

BM21259



BEN-MOR



DESSIN / DRAWING		B/C B
No. dessin :	257-7	Par : L M L / RL 07-02-23 B/C C
Date : 041110-1206/050329/060814-1220		Date

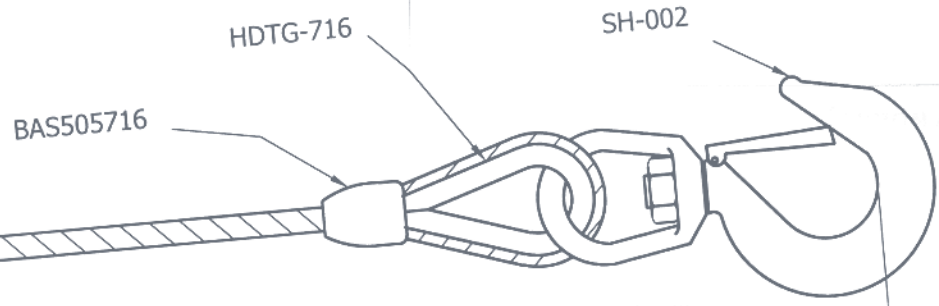
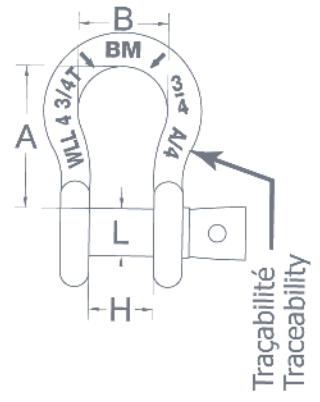
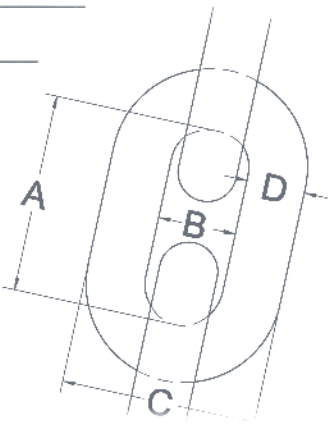

B/C Ben-Mor :
 B/C Client : A-2812
 Date de livr. : 28-10-14

Dénudeur :
 Press. :
 Contrôle qual. :
 No. :

2007-07-14

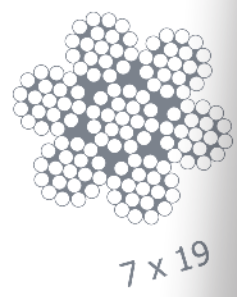
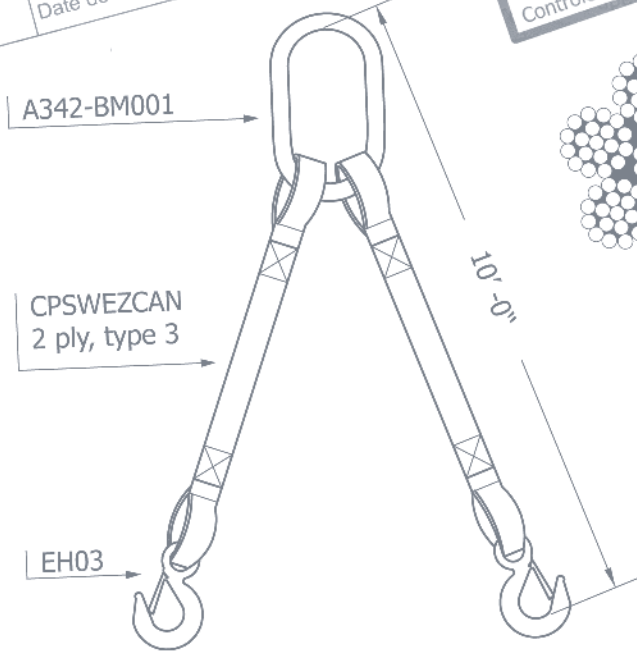

LINE
 30 1/32"
 INSTRUCTIONS

Hooked on SERVICE
 Merci! 25 years Thanks!

Dear valued customers,

After 25 years in business, our passion for excellence continues to be as strong today as it was in our early days. It is and will be at the forefront of our commitment to all our customers. For this, we are extremely proud.

We are always on the lookout for new products and services. As we constantly evolve to service you our customer, we are pleased to share our new industrial catalog which includes many new products and innovations. Our growth in our quality of products and services combined with our expertise allows us to offer personalized turnkey solutions for all your requirements.

Our numerous acquisitions in both Canada and the United States have contributed to developing expertise and a unique niche unmatched in the industry. Our most recent acquisition was Sling Tech, a major Canadian manufacturer of synthetic slings and round slings.

This new addition to the Ben-Mor family is a key component of our strategic plan to position Ben-Mor as the undisputed leader of all market segments we are involved in. We are now the largest manufacturer of synthetic slings in Canada.

We are proud to offer our team of professionals whose sole goal is to maintain our strong tradition of customer service. This is a key factor in our success as a company and our commitment to you as our valued customer. We will succeed together.

We sincerely thank you for your loyalty and trust!

Benoît Frappier

Lyne-Mireille Leduc

Richard Plante

Éric Rompré



Left to right :
Lyne-Mireille Leduc, V-P Finances and Human Resources,
Benoît Frappier, President and CEO of Ben-Mor,
Richard Plante, V-P Sales & Marketing,
Éric Rompré, V-P Production.

“ The Customer is King ”

The saying has survived and all have proclaimed it loudly. The voice may carry but if the results do not follow it, the Customer is not King any longer. At Ben-Mor, we prefer action to noise. That is why we whisper it in all confidence:

“ Ben-Mor knows the meaning of the word “Customer”, the consequences of the word “Trust”, and the notion of faithfulness to the King; ”

“ Ben-Mor’s team makes sure that its precious team spirit, mutual aid and mutual respect is constantly renewed;”

“ The same team is fully engaged, on a daily basis, to reinvent the highest quality standards;”

“ Finally, dear customer, we wish to assure you that at all times, we will work to offer you the best products possible at a price that will show our gratitude towards you. ”

Thank you from the whole team.

CABLE ASSEMBLIES



AS 9100
ISO 9001
MIL-SPEC

COATED CABLES



CABLES & WIRE ROPE



ACCESSORIES



**STAINLESS STEEL
ACCESSORIES**



LIFTING



CHAIN



ROPE



TOOLS



**FORESTRY
TRANSPORT
ASSEMBLIES**



SEISMIC SOLUTIONS



MERCHANDISING



**CONVERSION TABLE
SALES CONDITIONS**





The Cable Assemblies Specialists

Precision-Machined Components



CNC lathes, milling machines and a full complement of secondary machines gives us the ability to manufacture fittings for many of our assembly requirements.

Assembly



Superior Quality Control

From material receiving through final outgoing inspection, quality control is carefully monitored. At our facility, in-process quality inspection is an overall effort performed at each stage of production with documented control. Wire rope and cable products are tested to specified levels of performance, using both destructive and non-destructive test methods. We conform to applicable Military and ISO Standards.





Automated precision cuts



High quality swaging



With a variety of hydraulic swagers and rotary swaging machines, we are capable of swaging 3/64" through 3 1/2" diameter fittings. We are also equipped to swage specialty bar and tubing onto cable. Automatic cut-off machinery and bench swagers couple to turn out a finished product at a competitive price.



Zinc Die Cast Technology

Zinc die cast termination offers advantages that are difficult or nearly impossible to achieve with traditional swaging methods.

The benefits of zinc die cast termination to consider when designing your cable assembly are:

- **High Strength:** Zinc die cast termination will exceed the nominal published breaking strength of the cable in most cases.
- **Expanded Design Advantages:** Allows shapes to meet specific needs that would not be feasible with swaged fittings.

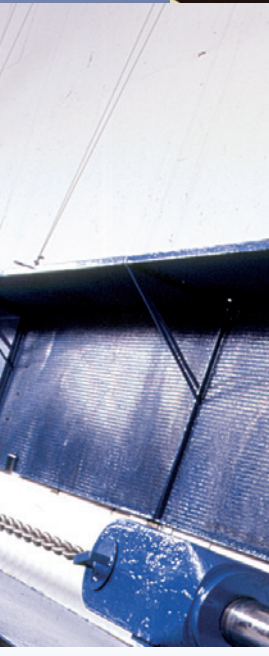
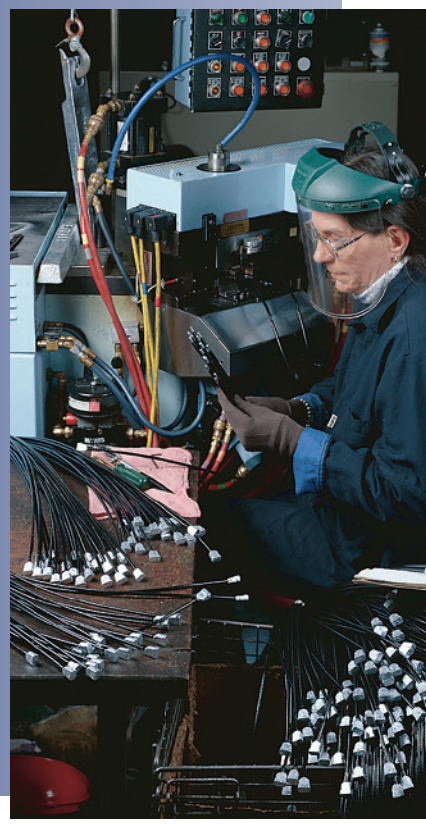



On earth, in the sky or on the sea...

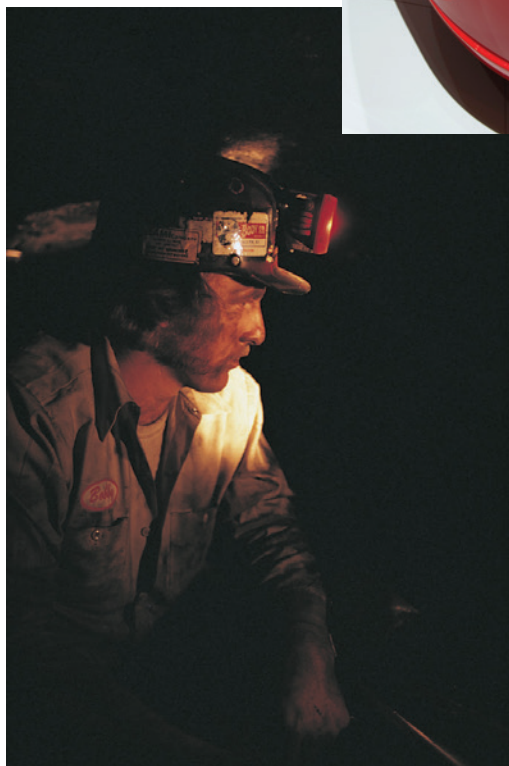

Endless possibilities !





AS 9100
ISO 9001
MIL-DTL-83420

North American
Made Quality



New Hampshire



AS 9100
ISO 9001
MIL-SPEC

On October 2, 2006, Ben-Mor Cables, Inc. acquired Continental Cable Company located in Hinsdale, New Hampshire, USA.

Continental Cable and its affiliates have been producing wire rope since 1948. The company has evolved into a leading manufacturer of custom wire rope and cable assemblies. Continental Cable expanded its product line to include an extensive stock of cable hardware with the acquisition of GBG Industries in 1989.

Continental Cable is an ISO9001:2000 and AS9100:2004 company which is essential when serving the aircraft industry. Also, Continental Cable is a qualified products list producer of MIL-DTL-83420 aircraft control cable as well as Federal Specification RR-W-410. With these qualifications, we are able to provide military and federal specification products for the aircraft and industrial markets.

The swaging, stranding, extrusion and machining capabilities of Continental Cable combined with the distinct service of Ben-Mor Cables make a perfect match. We look forward to providing the quality products and services you have come to expect.



MIL-DTL-83420

Continental Cable is an approved source for MIL-DTL-83420. Wire rope manufactured under this specification has been qualified by a test facility located in the continental United State or Canada. The specification MIL-DTL-83420 establishes all of the requirements for each size of wire rope for each type, composition, and construction.

The specific requirements refer to:

- ✓ Steel composition
- ✓ Tin and zinc coating composition
- ✓ Lubricant
- ✓ Construction
- ✓ Wire properties
- ✓ Preforming
- ✓ Splicing and joining
- ✓ Twist-off
- ✓ Temperature range*
- ✓ Wire flexibility
- ✓ Stretch limits
- ✓ Test load
- ✓ Resistance to fluid
- ✓ Color-coding identification
- ✓ Breaking strength
- ✓ Endurance
- ✓ Ductility of steel

** The wire rope shall be capable of operation in wind, dust, fuel, oil spills, wash-down, and other aircraft environmental stresses and experiences within a -65°F to +250°F (-54°C to 121°C) temperature range.*



MIL-DTL-83420

We are qualified to manufacture wire rope & cable under the detailed specification MIL-DTL-83420 for all of the products listed.

Type 1 - Comp A - Galvanized

Code	Construction	Diameter in.	Breaking Strength lbs.	Weight per 100 feet lbs.
GML047N-MFGC	7 x 7	3/64	270	0.42
GML063N-MFGC	7 x 7	1/16	480	0.75
GML094N-MFGC	7 x 7	3/32	920	1.6
GML094P-MFGC	7 x 19	3/32	1,000	1.6
GML125P-MFGC	7 x 19	1/8	2,000	2.9
GML156P-MFGC	7 x 19	5/32	2,800	4.5
GML188P-MFGC	7 x 19	3/16	4,200	6.5
GML250P-MFGC	7 x 19	1/4	7,000	11

Type 1 - Comp B - Stainless Steel 302/304

Code	Construction	Diameter in.	Breaking Strength lbs.	Weight per 100 feet lbs.
SML047N-MFGS	7 x 7	3/64	270	0.42
SML063N-MFGS	7 x 7	1/16	480	0.75
SML063P-MFGS	7 x 19	1/16	480	0.75
SML094N-MFGS	7 x 7	3/32	920	1.6
SML094P-MFGS	7 x 19	3/32	920	1.6
SML125P-MFGS	7 x 19	1/8	1,760	2.9
SML156P-MFGS	7 x 19	5/32	2,400	4.5
SML188P-MFGS	7 x 19	3/16	3,700	6.5
SML219P-MFGS	7 x 19	7/32	5,000	8.6
SML250P-MFGS	7 x 19	1/4	6,400	11
SML375P-MFGS	7 x 19	3/8	12,000	24.3

Other size available upon request.

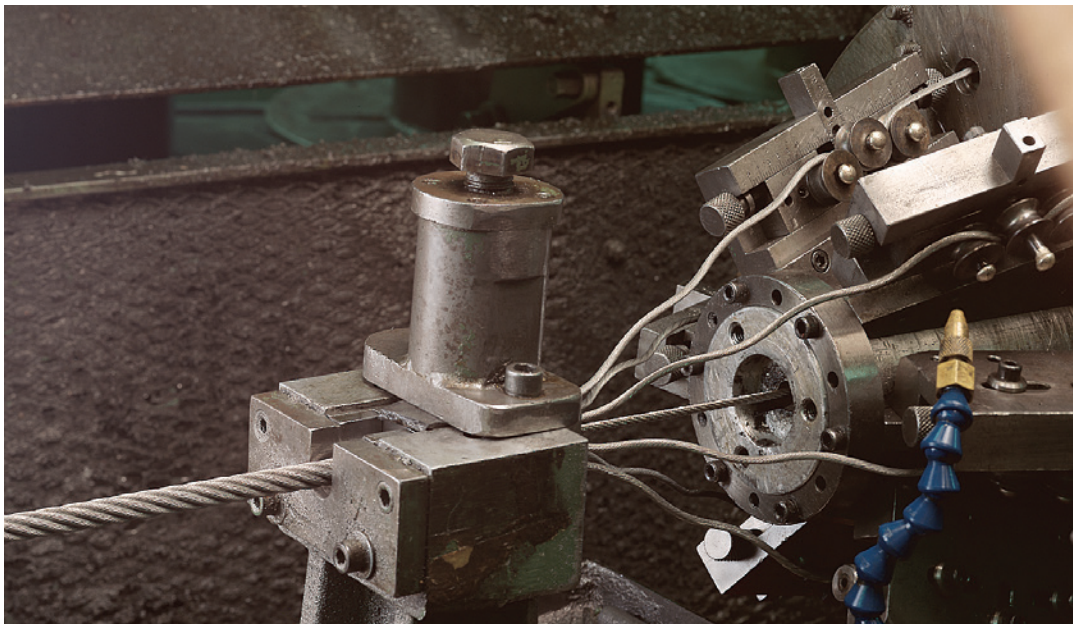



Threaded Aircraft Fittings MS21259
(Stainless Steel)

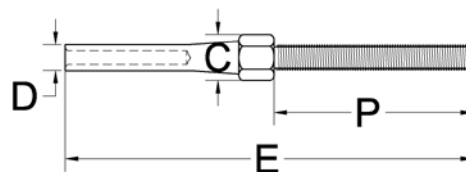

RH or LH Thread Code	For Cable Diameter in.	Weight ea. lbs.	Thd. D NF-3A or UNF-3A	Dimensions in.					
				C	D Before swage	D After swage	E +.015 -0.000 Before swage	E After swage	P
MS21259-2	1/16	0.0100	6-40	.188	.160	.138	2.473	2.65	1.045
MS21259-3	3/32	0.0225	10-32	.250	.218	.190	2.879	2.996	1.204
MS21259-4	1/8	0.0375	1/4-28	.313	.250	.219	3.333	3.589	1.376
MS21259-5	5/32	0.0475	1/4-28	.313	.297	.250	3.627	3.972	1.376
MS21259-6	3/16	0.0800	5/16-24	.375	.359	.313	4.002	4.170	1.458
MS21259-7	7/32	0.1200	3/8-24	.438	.427	.375	4.516	4.812	1.625
MS21259-8	1/4	0.1650	3/8-24	.500	.494	.438	4.937	5.236	1.750
MS21259-9	9/32	0.2650	7/16-20	.625	.563	.500	5.391	5.750	1.875
MS21259-10	5/16	0.3750	1/2-20	.688	.635	.563	5.844	6.266	2.000
MS21259-12	3/8	0.5000	9/16-18	.750	.703	.625	6.656	7.069	2.250
MS21259-14	7/16	0.6250	5/8-18	.812	.781	.688	7.437	7.910	2.500
MS21259-16	1/2	0.7500	5/8-18	.875	.844	.750	8.187	8.742	2.500

*Available on request: Left-hand thread.

Threaded Aircraft Fittings MS21260
(Stainless Steel)

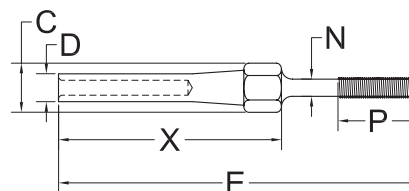

RH or LH Thread Code	For Cable Diameter in.	Weight ea. lbs.	Thd. B NF-3A or UNF-3A	Dimensions in.								
				C	D Before swage	D After swage	E ±.063 Before swage	E After swage	N +.006 -0.000	P ±.047	X After swage	
MS21260-L-2 S-2	1/16	0.010 0.011	6-40	.188	.160	.138	3.491 2.616	3.669 2.794	.092	.375	1.319	
MS21260-L-3 S-3	3/32	0.020 0.024	10-32	.250	.218	.190	3.738 2.863	3.855 2.980	.133	.500	1.581	
MS21260-L-4 S-4	1/8	0.024 0.040	1/4-28	.313	.250	.219	4.020 3.145	4.276 3.401	.195	.563	1.863	
MS21260-L-5 S-5	5/32	0.044 0.050	1/4-28	.313	.297	.250	4.314 3.439	4.659 3.784	.195	.625	2.157	
MS21260-L-6 S-6	3/16	0.070 0.086	5/16-24	.375	.359	.313	4.612 3.737	4.780 3.905	.245	.750	2.455	
MS21260-7	7/32	.130	3/8-24	.438	.427	.375	4.914	5.210	.306	.875	2.257	
MS21260-8	1/4	.170	3/8-24	.500	.494	.438	5.218	5.517	.306	.875	3.061	
MS21260-9	9/32	.22	7/16-20	.625	.563	.500	5.542	5.901	.361	1.000	3.385	
MS21260-10	5/16	.35	1/2-20	.688	.635	.563	5.875	6.297	.406	1.000	3.718	
MS21260-12	3/8	.50	9/16-18	.750	.703	.625	6.608	7.021	.476	1.125	4.281	
MS21260-14	7/16	.75	5/8-18	.812	.781	.688	7.468	7.941	.538	1.250	4.812	
MS21260-16	1/2	1.00	5/8-18	.875	.844	.750	8.718	9.273	.538	1.250	5.562	

*Available on request: Left-hand thread.

Aircraft Jaw Fitting MS20667 (Stainless Steel)

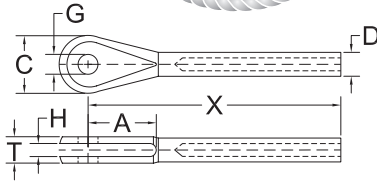

Code	For Cable Diameter in.	Weight ea. lbs.	Dimensions in.									
			A	C	D Before swage	D After swage	G		H ±.003	T +.010 - .005	X Before swage	X After swage
							Dia.	Tol.				
MS20667-2	1/16	0.01	.500	.344	.160	.138	.190	+ .002 - .000	.093	.218	1.572	1.750
MS20667-3	3/32	0.02	.670	.438	.218	.190	.190	+ .002 - .000	.108	.254	1.945	2.062
MS20667-4	1/8	0.03	.735	.547	.250	.219	.190	+ .002 - .000	.195	.383	2.352	2.608
MS20667-5	5/32	0.05	.800	.688	.297	.250	.250	+ .002 - .000	.202	.406	2.655	3.000
MS20667-6	3/16	0.09	.880	.781	.359	.313	.313	+ .002 - .000	.260	.543	3.071	3.239
MS20667-7	7/32	0.15	.970	.906	.427	.375	.313	+ .002 - .000	.296	.625	3.440	3.736
MS20667-8	1/4	0.20	1.070	.969	.494	.438	.375	+ .002 - .000	.313	.688	3.806	4.105
MS20667-9	9/32	0.30	1.170	1.156	.563	.500	.438	+ .002 - .000	.327	.719	4.120	4.479
MS20667-10	5/16	0.38	1.268	1.265	.635	.563	.438	+ .002 - .000	.348	.765	4.438	4.860
MS20667-12	3/8	0.57	1.525	1.500	.703	.625	.500	+ .005 - .000	.380	.830	5.333	5.746
MS20667-14	7/16	0.77	1.776	1.750	.781	.688	.562	+ .005 - .000	.380	.830	6.402	6.575
MS20667-16	1/2	1.62	1.903	1.875	.844	.750	.625	+ .005 - .000	.473	1.035	6.938	7.50

Aircraft Eye Fitting MS20668 (Stainless Steel)

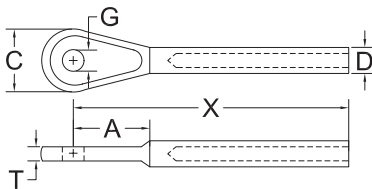

Code	For Cable Diameter in.	Weight ea. lbs.	Dimensions in.									
			A ±.020	C	D Before Swage	D After swage	G		T		X Before swage	X After swage
							Dia.	Tol.	Dia.	Tol.		
MS20668-2	1/16	0.01	.523	.359	.160	.138	.190	+ .002 - .000	.088	+ .000 - .005	1.631	1.809
MS20668-3	3/32	0.02	.707	.438	.218	.190	.190	+ .002 - .000	.103	+ .000 - .005	2.049	2.160
MS20668-4	1/8	0.03	.738	.500	.250	.219	.190	+ .002 - .000	.190	+ .000 - .005	2.337	2.593
MS20668-5	5/32	0.05	.831	.640	.297	.250	.250	+ .002 - .000	.197	+ .000 - .005	2.684	3.029
MS20668-6	3/16	0.09	.903	.781	.359	.313	.313	+ .002 - .000	.255	+ .000 - .005	3.019	3.187
MS20668-7	7/32	0.13	1.007	.813	.427	.375	.313	+ .002 - .000	.291	+ .000 - .005	3.382	3.678
MS20668-8	1/4	0.20	1.133	.968	.494	.438	.375	+ .002 - .000	.307	+ .000 - .005	3.763	4.062
MS20668-9	9/32	0.25	1.257	1.109	.563	.500	.438	+ .002 - .000	.322	+ .000 - .005	4.153	4.512
MS20668-10	5/16	0.40	1.373	1.218	.635	.563	.438	+ .002 - .000	.343	+ .000 - .005	4.546	4.969
MS20668-12	3/8	0.57	1.688	1.500	.703	.625	.500	+ .005 - .000	.375	+ .000 - .015	5.562	5.968
MS20668-14	7/16	0.79	1.968	1.750	.781	.688	.562	+ .005 - .000	.375	+ .000 - .015	6.398	6.867
MS20668-16	1/2	1.05	2.115	1.875	.844	.750	.625	+ .005 - .000	.468	+ .000 - .015	7.323	7.886



Ball Fitting (Stainless Steel)

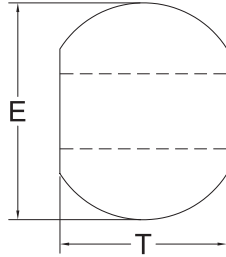

Code	For Cable Diameter in.	*Min. Breaking Strength lbs.	Weight / ea. lbs.	Dimensions in.				
				E Before swage		E After swage	T Before swage	
				Max	Min		Max	Min
BA3-1	1/32	88	0.002	.211	.208	.188	.141	.137
BA3-1.5	3/64	215	0.0019	.211	.208	.188	.141	.137
BA3-2	1/16	385	0.0017	.211	.208	.188	.141	.137
BA3-3	3/32	735	0.004	.288	.284	.250	.174	.170
BA3-4	1/8	1,200	0.006	.355	.351	.313	.190	.184
BA3-5	5/32	1,680	0.009	.429	.425	.375	.227	.222
BA3-6	3/16	2,520	0.010	.498	.493	.438	.264	.259

*Breaking Strength: Will break cable.

Shank Ball MS20664 (Stainless Steel)

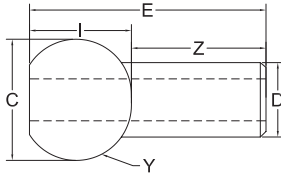

Code	Cor. Res. Steel	Nom. Cable Diameter in.	Weight / ea. lbs.	Dimensions in.						
				C Before swage	C After swage	D Before swage	D After swage	E	I	Y Max. Rad.
MS20664-C2	1/16	.0019	.212	.190	.132	.112	.2685	.114	.014	.156
MS20664-C3	3/32	.005	.282	.253	.168	.143	.384	.152	.019	.234
MS20664-C4	1/8	.0075	.350	.315	.223	.190	.500	.1895	.023	.313
MS20664-C5	5/32	.010	.424	.379	.259	.222	.616	.2275	.028	.391
MS20664-C6	3/16	.015	.492	.442	.298	.255	.730	.2645	.033	.469
MS20664-C7	7/32	.025	.560	.505	.352	.302	.846	.3025	.038	.547
MS20664-C8	1/4	.030	.629	.567	.406	.348	.962	.3395	.042	.625
MS20664-C9	9/32	.050	.699	.632	.444	.382	1.078	.3775	.046	.750
MS20664-C10	5/16	.066	.768	.694	.480	.413	1.193	.4145	.046	.813

Double Shank Ball MS20663 (Stainless Steel)

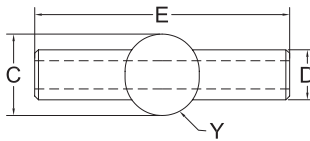

Code	Cor. Res. Steel	Nom. Cable Diameter in.	Weight / ea. lbs.	Dimensions in.					
				C Before swage	C After swage	D Before swage	D After swage	E Before swage	E After swage
MS20663-C2	1/16	.0016	.207	.190	.127	.112	.362	.390	.014
MS20663-C3	3/32	.0032	.277	.253	.163	.143	.525	.578	.019
MS20663-C4	1/8	.0094	.345	.315	.218	.190	.688	.765	.023
MS20663-C5	5/32	.0125	.419	.379	.254	.222	.850	.953	.028
MS20663-C6	3/16	.025	.487	.442	.293	.255	1.012	1.140	.033
MS20663-C7	7/32	.032	.555	.505	.347	.302	1.175	1.328	.038
MS20663-C8	1/4	.040	.624	.567	.401	.348	1.337	1.515	.042
MS20663-C9	9/32	.042	.694	.632	.439	.382	1.497	1.719	.046
MS20663-C10	5/16	.043	.763	.694	.475	.413	1.664	1.880	.046



Stamped Eyelets (Stainless Steel or Zinc Plated)

Code		For Cable Diameter in.	Material Type	Weight approx. per 100 Pcs. lbs.	Dimensions in.				
Ben-Mor	Continental				A	C	G	T	X
BMSEZ-364A	2083-01.5	3/64	Z.P.	.38	.315	.320	.160	.060	.715
BMSEZ-364A	2081-01.5	3/64	S.S.	.38	.315	.320	.160	.060	.715
BMSEZ-364B	2023-01.5	3/64	Z.P.	.35	.315	.320	.190	.060	.715
BMSEZ-364C	2023-01.5	3/64	Z.P.	.33	.315	.320	.190	.050	.715
BMSEZ-364B	2021-01.5	3/64	S.S.	.35	.315	.320	.190	.060	.715
n/a	2093-02*	1/16	Z.P.	.25	.340	.380	.129	.035	.650
n/a	2091-02*	1/16	S.S.	.25	.340	.380	.129	.035	.650
n/a	2103-02*	1/16	Z.P.	.24	.340	.380	.194	.035	.650
n/a	2101-02*	1/16	S.S.	.24	.340	.380	.194	.035	.650
BMSEZ-116C	2313-02	1/16	Z.P.	.74	.400	.460	.129	.060	.978
BMSEZ-116D	2003-02	1/16	Z.P.	.69	.320	.430	.190	.060	.940
BMSEZ-116D	2001-02	1/16	S.S.	.69	.320	.430	.190	.060	.940
BMSEZ-116E	2013-02	1/16	Z.P.	.63	.320	.430	.260	.060	.940
BMSEZ-116E	2011-02	1/16	S.S.	.63	.320	.430	.260	.060	.940
BMSEZ-116F	2173-02	1/16	Z.P.	.65	.400	.460	.204	.060	.978
BMSEZ-116F	2171-02	1/16	S.S.	.65	.400	.460	.204	.060	.978
BMSEZ-332A	2303-03	3/32	Z.P.	1.92	.470	.500	.205	.093	1.42
BMSEZ-332A	2301-03	3/32	S.S.	1.92	.470	.500	.205	.093	1.42
BMSEZ-332B	2343-03	3/32	Z.P.	1.88	.470	.500	.250	.093	1.42
BMSEZ-332B	2341-03	3/32	S.S.	1.88	.470	.500	.250	.093	1.42
BMSEZ-332C	2323-03	3/32	Z.P.	2.04	.450	.750	.375	.093	1.31
BMSEZ-332C	2321-03	3/32	S.S.	2.04	.450	.750	.375	.093	1.31
BMSEZ-332D	2333-03	3/32	Z.P.	1.81	.450	.750	.500	.093	1.31
BMSEZ-332D	2331-03	3/32	S.S.	1.81	.450	.750	.500	.093	1.31
BMSEZ-018A	2403-04**	1/8	Z.P.	4.66	.480	.580	.250	.125	1.95
BMSEZ-018A	2401-04**	1/8	S.S.	4.66	.480	.580	.250	.125	1.95
BMSEZ-018B	2413-04**	1/8	Z.P.	4.64	.480	.580	.316	.125	1.95
BMSEZ-018B	2411-04**	1/8	S.S.	4.64	.480	.580	.316	.125	1.95
BMSEZ-018C	2423-04	1/8	Z.P.	4.92	.540	.850	.375	.125	1.84
BMSEZ-018C	2421-04	1/8	S.S.	4.92	.540	.850	.375	.125	1.84
BMSEZ-018D	2433-04	1/8	Z.P.	4.56	.540	.850	.500	.125	1.84
BMSEZ-018D	2431-04	1/8	S.S.	4.56	.540	.850	.500	.125	1.84

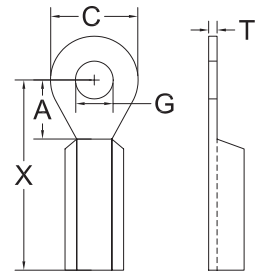

Before Swage
Eyelet part #2303-03 swaged with a GBG 50 Ton Hydraulic swager onto 3/32" 7 x 7 cable.

*2093-02, 2091-02, 2103-02, & 2101-02 holds 250 lbs. max. without distortion to eyelet.

**2403-04, 2401-04, 2413-04, & 2411-04 holds 1600 lbs. max.

General Notes:
Stamped eyelets must be assembled with a mechanical or hydraulic swager using properly designed dies.

A pull test should be performed to determine the holding strength of the applied eye, and suitability for your application.

Stainless Strap Eye with markings

Code	Diameter in.	Dimensions in.				
		C	D	J	L	T
NAS1435-E2	1/16	.454	.188	.088	1 1/16	.042
NAS1435-E3	3/32	.616	.188	.103	1 1/2	.049
NAS1435-E4	1/8	.638	.188	.190	1 5/8	.093
NAS1435-E5	5/32	.699	.250	.197	1 15/16	.096
NAS1435-E6	3/16	.750	.313	.255	2 3/16	.125

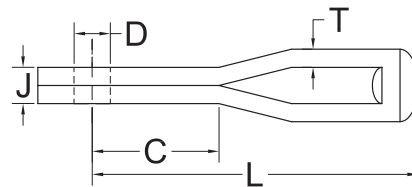

Stainless Strap Fork with markings

Code	Diameter in.	Dimensions in.				
		C	D	G	L	T
NAS1435-K2	1/16	.454	.188	.093	1 1/16	.042
NAS1435-K3	3/32	.616	.188	.108	1 1/2	.049
NAS1435-K4	1/8	.638	.188	.195	1 5/8	.093
NAS1435-K5	5/32	.699	.250	.202	1 15/16	.096
NAS1435-K6	3/16	.750	.313	.260	2 3/16	.125

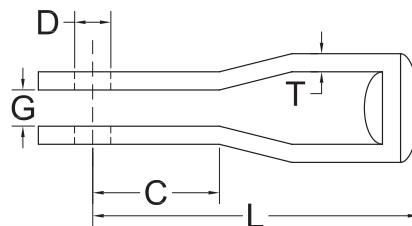



Coated Cables



Our Extruders are equipped with laser monitors that constantly measure every centimeter of the coated cable.

These machines insure the highest quality control over the outside diameter of the coatings during production.



Coated Cable

Cable / Nominal diameter in	Outside / Coating diameter in.	Weight approx. per 100 ft. lbs.
1/32	3/64	0.25
3/64	1/16	0.60
1/16	3/32	0.95
1/16	1/8	1.00
3/32	1/8	2.20
3/32	5/32	2.60
3/32	3/16	2.90
1/8	5/32	4.05
1/8	3/16	4.65
1/8	1/4	5.05
5/32	3/16	5.40
5/32	7/32	5.50
3/16	7/32	6.80
3/16	1/4	7.90
3/16	5/16	10.25
1/4	5/16	12.50
5/16	3/8	19.75
5/16	7/16	21.95
3/8	7/16	28.20
3/8	1/2	30.50
3/8	9/16	33.20
7/16	1/2	37.50
7/16	9/16	40.20
1/2	9/16	48.75
1/2	5/8	52.00
1/2	11/16	55.10
5/8	11/16	75.40
5/8	3/4	79.10
5/8	7/8	87.30
3/4	7/8	112.20
3/4	1	122.00
1	1 1/8	197.50
1	1 1/4	217.00
1 1/8	1 1/4	266.00
1 1/4	1 3/8	316.00
1 1/4	1 1/2	356.00

– Miniature cable available on request (smaller than 1/32")

– Galvanized, stainless steel 304 and 316 cable available

- ✓ Nylon 6 (standard)
- ✓ Nylon 11 (high performance)
- ✓ Vinyl, urethane
- ✓ Polypropylene
- ✓ Polyester (Hytrell)

TOLERANCES

Standard outside diameter tolerances for plastic coated cables.

O.D. of Jacket	Standard Tolerance
Up to .125 (1/8")	+/-0.007"
.126 to .250 (1/4")	+/-0.009"
.251 to .375 (3/8")	+/-0.010"
.376 to .500 (1/2")	+/-0.015"
.501 to .750 (3/4")	+/-0.020"
.751 to 1.000 (1")	+/-0.030"
1.001 to 1.250 (1 1/4")	+/-0.040"
1.251 to 1.500 (1 1/2")	+/-0.050"

WARNING

Applying fittings over a plastic jacket is not recommended.

Any fitting pressed or swaged over a plastic jacket will not hold to the nominal break strength of the cable.

CUSTOMER SUPPLIED MATERIAL

We offer a coating service for your cable - subject to certain conditions.

1. The cable must be dry-oil free.
2. No protruding or broken wires.
3. No obvious defects (such as high or uneven strands).
4. Cable must be evenly wound (thread lay) on the reels.

We have the right to refuse to coat your cable if in our opinion we cannot produce a satisfactory finished product, or we determine that the cable may cause damage to our extruders.



We have engineered our own mixes to offer you superior quality colors.

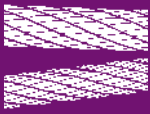

Cables & Wire Rope

Aircraft Cable and Preformed Strand

Hot Dip Galvanized				
Construction	Code	Diameter in.	Minimum Breaking Strength lbs.	Weight per 100 ft. lbs.
Soft guy wire	11617SOFT	1/16	100	0.85
	56417SOFT	5/64	150	1.4
	33217SOFT	3/32	250	2.0
	01817SOFT	1/8	520	3.3
	31617SOFT	3/16	1150	3.8
 1 x 7	16417G	1/64	40	0.055
	13217G	1/32	185	0.23
	36417G	3/64	375	0.55
	11617G	1/16	500	0.85
	56417G	5/64	800	1.4
	33217G	3/32	1,200	2.0
	01817G	1/8	2,100	3.5
	01417GEHS	1/4	6,650	13.7
	03817GEHS	3/8	15,400	24.3
	71617GEHS	7/16	20,800	39.0
	01217GEHS	1/2	26,900	52.0
	91617GEHS	9/16	35,000	67.0
	05817GEHS	5/8	42,400	80.0
	 1 x 19	364119G	3/64	375
116119G		1/16	500	0.85
564119G		5/64	800	1.4
332119G		3/32	1,200	2.0
018119G		1/8	2,100	3.3
532119G		5/32	3,300	5.5
316119G		3/16	4,700	7.7
014119G		1/4	8,200	13.5
516119G		5/16	12,500	21.0
038119G		3/8	17,500	30.1
 7 x 7	36477G	3/64	270	0.42
	11677G	1/16	480	0.75
	56477G	5/64	650	1.1
	33277G	3/32	920	1.6
	01877G	1/8	1,700	2.85
	53277G	5/32	2,600	4.3
	31677G	3/16	3,700	6.2
	01477G	1/4	6,100	10.6
	51677G	5/16	9,200	16.7
03877G	3/8	13,300	23.6	
 7 x 19	116719G	1/16	480	0.75
	332719G	3/32	1,000	1.6
	018719G	1/8	2,000	2.9
	532719G	5/32	2,800	4.5
	316719G	3/16	4,200	6.5
	732719G	7/32	5,600	8.6
	014719G	1/4	7,000	11.0
	516719G	5/16	9,800	17.3
038719G	3/8	14,400	24.3	





Black Oxide				
Construction	Code	Diameter in.	Minimum Breaking Strength lbs.	Weight per 100 ft. lbs.
 7 x 7	11677BLO	1/16	480	0.75
 7 x 19	018719BLO	1/8	2,000	2.9
	316719BLO	3/16	4,200	6.5



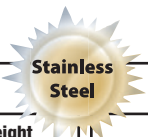
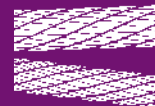

Black oxide : Gives galvanized cable a black matte finish



Miniature cable available on request (smaller than 1/32")



Stainless Steel 304				
Construction	Code	Diameter in.	Minimum Breaking Strength lbs.	Weight per 100 ft. lbs.
 1 x 7	16417S4	1/64	40	0.055
	13217S4	1/32	185	0.23
	36417S4	3/64	375	0.55
	11617S4	1/16	500	0.85
	56417S4	5/64	800	1.4
	33217S4	3/32	1,200	2.0
	01817S4	1/8	2,100	3.5
	31617S4	3/16	4,700	7.3
	01417S4	1/4	8,500	13.7
	03817S4	3/8	18,000	24.3
	01217S4	1/2	33,700	52.0
 1 x 19	364119S4	3/64	375	0.55
	116119S4	1/16	500	0.85
	564119S4	5/64	800	1.4
	332119S4	3/32	1,200	2.0
	018119S4	1/8	2,100	3.3
	532119S4	5/32	3,300	5.5
	316119S4	3/16	4,700	7.7
	014119S4	1/4	8,200	13.5
	516119S4	5/16	12,500	21.0
	038119S4	3/8	17,500	30.1
	012119S4	1/2	30,000	52.0
 7 x 7	13277S4	1/32	120	0.16
	36477S4	3/64	270	0.42
	11677S4	1/16	480	0.75
	56477S4	5/64	650	1.1
	33277S4	3/32	920	1.6
	01877S4	1/8	1,700	2.85
	53277S4	5/32	2,400	4.3
	31677S4	3/16	3,700	6.2
	01477S4	1/4	6,100	10.6
	51677S4	5/16	9,000	16.7
	03877S4	3/8	12,000	23.6
	01277S4	1/2	23,300	44.0
	 7 x 19	116719S4	1/16	480
332719S4		3/32	920	1.6
018719S4		1/8	1,760	2.9
532719S4		5/32	2,400	4.5
316719S4		3/16	3,700	6.5
732719S4		7/32	5,000	8.6
014719S4		1/4	6,400	11.0
516719S4		5/16	9,000	17.3
038719S4		3/8	12,000	24.3

Stainless Steel 316				
Construction	Code	Diameter in.	Minimum Breaking Strength lbs.	Weight per 100 ft. lbs.
 1 x 7	01417S6	1/4	7,650	13.7
	03817S6	3/8	16,200	24.3
	01217S6	1/2	30,200	52.0
 1 x 19	116119S6	1/16	467	0.85
	018119S6	1/8	1,780	3.3
	532119S6	5/32	2,800	5.5
	316119S6	3/16	4,000	7.7
	014119S6	1/4	6,900	13.5
	516119S6	5/16	10,600	21.0
	038119S6	3/8	14,800	30.1
 7 x 7	012119S6	1/2	27,000	52.0
	11677S6	1/16	360	0.75
	33277S6	3/32	700	1.6
	01877S6	1/8	1,360	2.85
	31677S6	3/16	2,875	6.2
	51677S6	5/16	7,600	16.7
	 7 x 19	332719S6	3/32	700
018719S6		1/8	1,300	2.9
532719S6		5/32	2,000	4.5
316719S6		3/16	2,900	6.5
014719S6		1/4	4,900	11.0
516719S6		5/16	7,600	17.3
038719S6		3/8	11,000	24.3

Type 316 stainless steel is the standard high corrosion resistant steel for rope and cable. It is resistant to many chemicals in the pulp and paper, photographic, food processing and textile industries. It has the best pitting resistance in marine and salt water and can be used in temperatures up to 480°C (900°F).

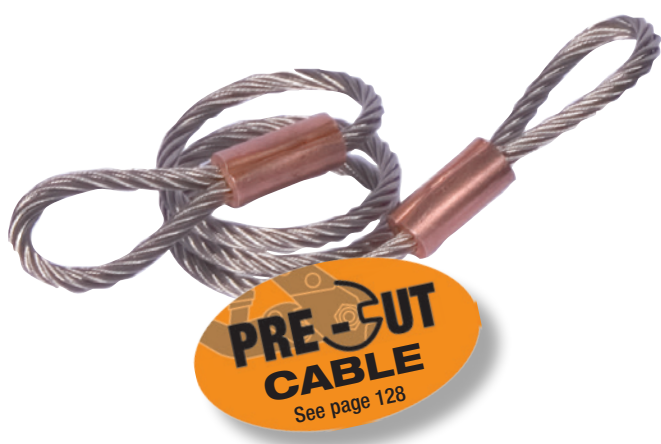

Type 304 stainless steel is the standard alloy for use in wire rope and cable. It has about the same strength as galvanized rope or cable but is much more corrosion resistant. It can be used in most industrial atmospheres and has acceptable corrosion resistance when used in marine and salt water.

6 X 19/26, 6 X 36/37 Steel Core — Fiber Core

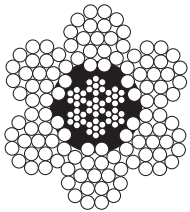

6 x 19

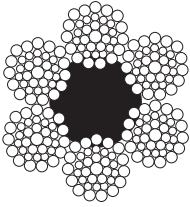

6 x 37

Diameter in.	Weight approx./ 100 ft. lbs.	Minimum Breaking Strength — lbs.							
		IPS				EIPS			
		Steel Core		Fiber Core		Steel Core		Fiber Core	
		Galv.	Bright	Galv.	Bright	Galv.	Bright	Galv.	Bright
1/4	12	5,300	5,880	4,940	5,480	6,120	6,800	5,680	6,300
5/16	18	8,240	9,160	7,660	8,520	9,480	10,540	8,810	9,800
3/8	26	11,800	13,120	10,980	12,200	13,600	15,100	12,600	14,000
7/16	35	16,000	17,780	14,880	16,540	18,360	20,400	17,100	19,000
1/2	46	20,700	23,000	19,260	21,400	24,000	26,600	22,000	24,600
9/16	59	26,100	29,000	24,300	27,000	30,200	33,600	28,000	31,100
5/8	72	32,200	35,800	30,000	33,400	37,000	41,200	34,500	38,400
3/4	104	46,000	51,200	42,800	47,600	53,000	58,800	49,200	54,700
7/8	142	62,200	69,200	58,000	64,400	71,600	79,600	66,700	74,100
1	185	80,800	89,800	75,200	83,600	93,000	103,400	86,500	96,100
1 1/8	234	101,800	113,000	94,600	105,200	117,000	130,000	108,800	121,000
1 1/4	289	125,000	138,800	116,200	129,200	143,800	159,800	133,600	148,600
1 3/8	350	150,400	167,000	139,800	155,400	172,800	192,000	160,800	178,700
1 1/2	416	178,000	197,800	165,600	184,000	206,000	228,000	190,400	211,600
1 3/4	567	240,000	266,000	224,000	248,000	276,000	306,000	N/A	N/A
2	739	310,000	344,000	288,000	320,000	356,000	396,000	N/A	N/A
2 1/4	936	387,000	430,000	360,000	400,000	444,000	494,000	N/A	N/A
2 1/2	1160	471,000	524,000	439,000	488,000	543,000	604,000	N/A	N/A

Cable larger than 2" available on request.

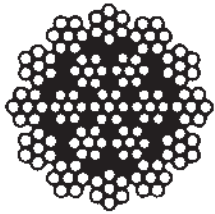

19 x 7

19 X 7 Non-rotating

Code	Diameter in.	Weight per 100 ft. lbs.	Minimum Breaking Strength lbs.	
			IPS	EIPS
316197B	3/16	6.5	---	3,140
014197B	1/4	11	5,020	5,460
516197B	5/16	18	7,800	8,530
038197B	3/8	25	11,180	12,300
716197B	7/16	35	15,160	16,660
012197B	1/2	45	19,700	21,600
916197B	9/16	58	24,800	27,200
058197B	5/8	71	30,600	33,600
034197B	3/4	102	43,600	48,000
078197B	7/8	139	59,000	65,000
001197B	1	182	76,600	84,400



With a variety of hydraulic swagers and rotary swaging machines, we are capable of swaging 3/64" through 3 1/2" diameter fittings. With two teams of splicers on two shifts, we manufacture and deliver exactly when needed.

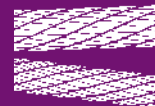

Cable Laid (Hot Dip Galvanized) 7 X 7 X 7

Code	Diameter in.	Minimum Breaking Strength lbs.	Weight per 100 ft. lbs.
014777G	1/4	4,900	9
516777G	5/16	6,000	13
038777G	3/8	10,400	22
012777G	1/2	19,500	35
058777G	5/8	29,200	60
034777G	3/4	42,000	88
078777G	7/8	56,000	119
001777G	1	78,000	156

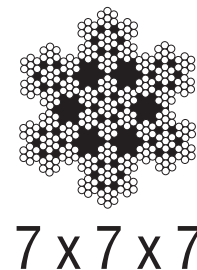

6 x 19/26 Stainless Steel

Diameter in.	Weight per 100 ft. lbs.	Minimum Breaking Strength lbs.	
		GR. 304	GR. 316
7/16	36	16,300	15,000
1/2	46	22,800	19,300
9/16	59	28,500	24,300
5/8	72	35,000	29,800
3/4	92	49,600	42,000
7/8	143	66,500	58,000
1	187	85,400	80,000

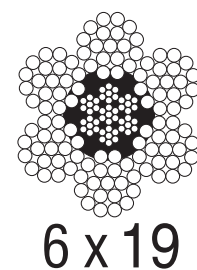

6 x 36/37 Stainless Steel

Diameter in.	Weight per 100 ft. lbs.	Minimum Breaking Strength lbs.	
		GR. 304	GR. 316
1/4	10	5,400	4,800
5/16	18	8,300	7,470
3/8	24	11,700	10,530
7/16	33	15,800	14,200
1/2	43	20,400	18,360
9/16	54	25,600	21,760
5/8	67	31,400	28,260
3/4	96	44,400	39,960
7/8	131	59,700	53,730
1	170	77,300	69,570



3 x 7 Swaged / Super Swaged

Code	Diameter in.	Minimum Breaking Strength lbs.	Weight per 100 ft. lbs.
31637BS	3/16	4,000	10
31637BSS	3/16	5,000	10
01437BSS	1/4	7,000	12



Armored Cable (tow target cable) 1 x 19

Code	Outside Diameter in.	Inside Diameter in.	Minimum Breaking Strength lbs.	Weight per 100 ft. lbs.
0181164119A	1 1/64	1/8 galvanized	4,000	8



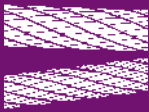

Construction & Identification of Steel Wire Rope

Wire ropes are identified primarily by construction. The number of strands and the number and geometric arrangement of wires within the strands make up the wire rope construction.

The more common constructions are shown below. Note that each construction can have more wires than shown, but the geometry remains the same. For example, there can be two-operation ropes having more than 19 wires; there can be Seale ropes having more than 19 wires; there can be Warrington ropes having more than 19 wires and there can be Filler Wire types having more (or less) than 25 wires. Here are the basic constructions.

Each of the above possesses unique characteristics which must be considered when selecting rope or strand for a job. The specific geometric construction selected depends on the destructive factors present on the job.

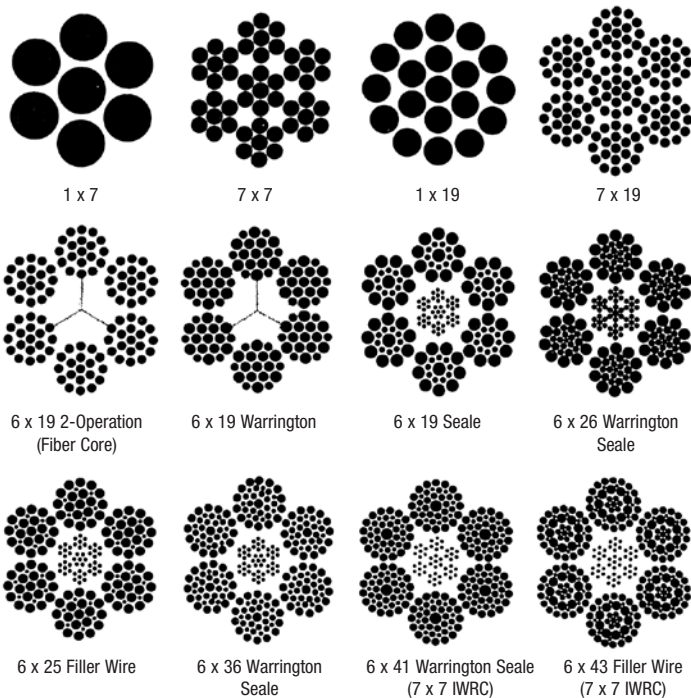

Wire Rope Construction

The most common factors, abrasion and fatigue, create conflicting requirements. Small (more numerous) outer wires resist fatigue but are easily worn through by abrasion. Larger outer wires have superior abrasion resistance but are more quickly broken by bending and flexing. The difference in outer wire size is seen between the 6 x 19 Seale and 6 x 25 Filler Wire constructions. The 9 outer wires in the Seale strands are clearly larger than the 12 outer wires in the Filler Wire strands. Other destructive factors must be considered: peening, corrosion, heat, crushing, and shock loads.

Classification

Each wire rope construction falls within a classification. Classifications are identified by the number of strands and nominal number of wires. The actual number of wires must fall within a range specified for the given class. For example, ropes within the 6 x 19 class contain 6 strands made up of 15 through 26 wires of which no more than 12 are outside wires. The 6 x 19 Seale and 6 x 25 Filler Wire constructions therefore are both within this class. The more common classifications are 6 x 7, 6 x 19, 6 x 37, 8 x 19, and 19 x 7.

Core

The sole purpose of the core of a rope is to support the strands under normal bending and loading conditions. The three most common types are Fiber Core (FC), Independent Wire Rope Core (IWRC) and Wire Strand Core (WSC). The bottom row of constructions are shown with 7 x 7 IWRCs where the 6 x 19 2-operation and 6 x 19 Warrington constructions contain fiber cores. The 7 x 7 construction contains a 1 x 7 WSC and the 7 x 19 2-operation construction contains a 1 x 19 WSC. Almost all constructions can have either of the three types of core.

Natural or synthetic fiber rope cores can be used at loads up to about 25% of the nominal strength and at temperatures up to 200°F. At higher loads and temperatures, the strands will lose support and either a WSC or an IWRC must be used. Greater support is also needed for rope operating over small diameter sheaves and drums under heavy loads.

Grade

The grade of rope depends on the strength requirements of the job. Grades commonly used include: Traction Steel (TS), Improved Plow Steel (IPS), Extra Improved Plow Steel (EIP), and Double Extra Improved Plow Steel (EEIP). These grades are most often bright or uncoated but the wires may be galvanized (zinc coated). Wire galvanized at finished size is usually 10% lower in strength than bright wire, where drawn galvanized wire has the same strength. Other wire types commonly used include Galvanized Aircraft (GAC), and various grades of stainless steel and bronze.

Lay

An important consideration in wire rope construction is the way the wires have been laid to form strands and the way the strands have been laid around the core.

Lay is classified by both direction and type. The lay direction of the wires within a strand and of the strands within a rope is either left or right. Rope lay is further classified as either regular or lang. In a regular lay rope, the wires in the strands are laid

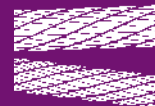

in the opposite direction as the strands in the rope. In a lang lay rope, the wires in the strands are laid in the same direction as the strands in the rope.

Regular and lang lay ropes are easily identified by the appearance of the outer wires with respect to the rope axis as shown by the examples to the right.

Right regular and right lang are the most common types of lay in use. Each possesses unique characteristics important to proper selection. Wire rope can be manufactured with five types of lay.

Regular lay ropes are generally more stable and more resistant to crushing. Lang lay ropes are significantly superior in fatigue and abrasion resistance. However, lang lay ropes are more susceptible to crushing and require good winding conditions. They are also extremely prone to rotate under load; they must never be used unless both ends are restrained.

Alternate lay rope combines the best features of regular and lang lay ropes. It offers the advantages of both constructions while minimizing the disadvantages. This construction is ideal where high bending stresses (fatigue) are combined with high rope-to-sheave pressure (crushing); for example, as applied to boom hoist rope.

Rotation Resistant Wire Ropes

Combinations of lays are sometimes employed to achieve rotation resistant properties. In this 19 x 7 rope, (as well as in 8 x 19 IWRC Rotation Resistant rope), the extreme rotational property of lang lay rope is used in the core to counteract the tendency of the outer regular lay strands to rotate in the opposite direction.

Selection

Wire rope selection is a highly specialized art and science. Only extensive experience can qualify the selector to choose the proper rope for a specific application.

Lubrication

Wire ropes are actually intricate machines comprised of many components which require lubrication. During manufacture, ropes receive lubrication; the kind and amount depend upon the rope size, type, and anticipated use. This lubrication protects against corrosion and enhances performance. It is not possible to permanently lubricate ropes. Most rope applications will require supplementary lubrication.

Corrosion

A large number of wire ropes fail because of corrosion which may be either external, internal, or both. Normally corrosion takes place because of acid or alkaline atmosphere which is due to sea, air, industrial fumes or other conditions. In most cases corrosion cannot be completely eliminated but it can be resisted by cleaning and lubricating rope or by using galvanized ropes. In short, a rope which would have adequate resistance to corrosive factors should be selected. Though, there would be a number of other factors which would influence the life of a rope, the above factors are generally important. In certain cases these properties are contradictory. For example, increasing the diameter of the outer wires of a rope increases resistance to abrasion, but decreases resistance to bending fatigue. It is, therefore, very important that the ultimate selection of rope must be a most acceptable compromise. Each of the desirable characteristics should be attained to the maximum degree possible without excessive sacrifice of the other required properties.



Right Regular Lay – Strands are laid to the right and wires appear in line with the rope.



Right Lang Lay – Strands are laid to the right but the wires appear to make an angle with the rope.



Left Regular Lay – Strands are laid to the left and wires appear in line with the rope.



Left Lang Lay – Strands are laid to the left but wires appear to make an angle with the rope.



Alternate Lay – Alternating right regular and right lang lay strands.

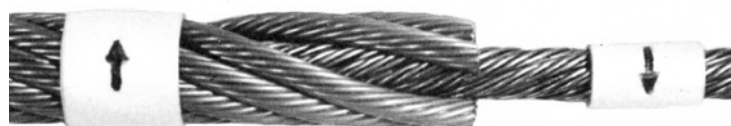



Accessories

Copper Duplex Sleeves or Copper Zinc Plated Duplex Sleeves



Code Copper	Code Copper Zinc Plated	For Cable Diameter in.	Weight / each approx. lbs.
COS-132	CZOS-132	1/32	.001
COS-364	CZOS-364	3/64	.002
COS-116	CZOS-116	1/16	.003
COS-332	CZOS-332	3/32	.005
COS-018	CZOS-018	1/8	.016
COS-532	CZOS-532	5/32	.022
COS-316	CZOS-316	3/16	.051
COS-732	CZOS-732	7/32	.044
COS-014	CZOS-014	1/4	.078
COS-516	CZOS-516	5/16	.115
COS-038	CZOS-038	3/8	.146
COS-012	CZOS-012	1/2	.372

Federal Specifications MS51844

Tin or Nickel plating available on request

Aluminum Duplex Sleeves (Hour glass shape)



Code	For Cable Diameter in.	Weight / each approx. lbs.
AOS-132	1/32	.0002
AOS-364	3/64	.001
AOS-116	1/16	.001
AOS-564	5/64	.002
AOS-332	3/32	.003
AOS-018	1/8	.006
AOS-532	5/32	.008
AOS-316	3/16	.016
AOS-732	7/32	.022
AOS-014	1/4	.025
AOS-516	5/16	.045
AOS-038	3/8	.061
AOS-716	7/16	.118
AOS-012	1/2	.176



Aluminum Stop Sleeves, *chamfered*



Code	For Cable Diameter in.	Weight / each approx. lbs.
ASS-116	1/16	.001
ASS-564	5/64	.002
ASS-332	3/32	.003
ASS-018	1/8	.002
ASS-532	5/32	.004
ASS-316	3/16	.004
ASS-014	1/4	.021
ASS-516	5/16	.022
ASS-038	3/8	.022

Aluminum Oval Sleeves



Code	For Cable Diameter in.	Weight / each approx. lbs.
AOS-058OVAL	9/16 - 5/8	.220
AOS-034OVAL	3/4	.400
AOS-078OVAL	7/8	.674
AOS-001OVAL	1	-
AOS-114OVAL	1 1/4	1.922

Other sizes available on request.

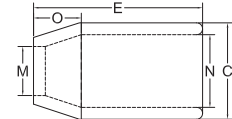

Copper Stop Sleeves



Code	For Cable Diameter in.	Weight / each approx. lbs.
CSS-132	1/32	.001
CSS-364	3/64	.002
CSS-116	1/16	.002
CSS-332	3/32	.008
CSS-018	1/8	.007
CSS-532	5/32	.012
CSS-316	3/16	.105
CSS-732	7/32	.186
CSS-014	1/4	.061
CSS-516	5/16	.052

Steel Sleeves

Code	Rope Size in.	Weight per 100 lbs.	Before Swage Dimensions in.					After Swage Dimensions in. (max)
			C	E	M	N	O	Standard Die
BAS505014	1/4	5	.66	1.00	.31	.47	.28	.57
BAS505516	5/16	14	.91	1.50	.38	.62	.44	.75
BAS505038	3/8	14	.91	1.50	.47	.66	.39	.75
BAS505716	7/16	33	1.22	2.00	.53	.85	.65	1.01
BAS505012	1/2	29	1.22	2.00	.63	.91	.56	1.01
BAS505916	9/16	64	1.47	2.75	.70	1.03	.63	1.24
BAS505058	5/8	56	1.47	2.75	.75	1.09	.63	1.24
BAS505034	3/4	88	1.72	3.19	.91	1.28	.84	1.46
BAS505078	7/8	131	2.03	3.56	1.03	1.53	1.00	1.68
BAS505001	1	195	2.28	4.00	1.16	1.72	1.13	1.93
BAS505118	1 1/8	260	2.50	4.81	1.28	1.94	1.25	2.13
BAS505114	1 1/4	355	2.78	5.19	1.44	2.16	1.41	2.32
BAS505138	1 3/8	423	3.00	5.81	1.56	2.38	1.56	2.52
BAS505112	1 1/2	499	3.25	6.25	1.69	2.63	1.69	2.71
BAS505134	1 3/4	805	3.84	7.25	1.94	3.13	1.97	3.10
BAS505002	2	1,132	4.38	8.50	2.25	3.63	2.25	3.56
BAS505214	2 1/4	1,936	5.03	9.56	2.50	4.03	2.53	4.12
BAS505212	2 1/2	2,352	5.50	10.50	2.75	4.50	2.81	4.50



Steel Swage Buttons

Code	Weight / ea. approx. lbs.	Dimensions in.			After Swage Dimensions in.	
		A	C	D	A	C
SBS409018	.02	0.438	0.526	0.141	0.40	0.61
SBS409316	.04	0.568	0.737	0.203	0.52	0.84
SBS409014	.07	0.632	1.000	0.281	0.58	1.20
SBS409516	.15	0.852	1.150	0.344	0.77	1.33
SBS409038	.20	0.875	1.500	0.406	0.77	1.69
SBS409716	.39	1.136	1.684	0.469	1.03	1.94
SBS409012	.54	1.278	1.840	0.531	1.16	2.17
SBS409916	.73	1.420	2.040	0.594	1.29	2.41
SBS409058	1.07	1.562	2.421	0.656	1.42	2.89
SBS409034	1.36	1.704	2.720	0.797	1.55	3.25
SBS409078	2.24	2.000	3.263	0.938	1.80	3.86
SBS409001	3.27	2.272	3.684	1.063	2.05	4.36
SBS409118	4.59	2.563	4.050	1.187	2.30	4.81
SBS409114	7.89	2.840	4.560	1.320	2.56	5.42
SBS409112	11.01	3.408	5.470	1.578	TBD	TBD

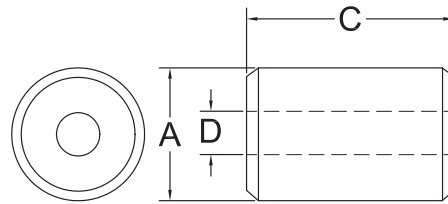

Properly swaged aluminum and copper oval sleeves and duplex will develop the published nominal break strength of the cable on 3x7, 7x7, and 7x19 constructions. Sleeves used on other constructions will not hold to the nominal published break strength. Stop sleeves will not hold to the nominal published break strength of any cable.

We recommend the use of a mechanical or hydraulic swager to obtain the full holding power of stainless steel oval sleeves.

Sleeves and other fittings swaged over a plastic jacket will not hold to the nominal published break strength of the cable.

To determine the actual holding strength of any fitting, a pull test must be made.

This will assist in determining if the applied fitting is suitable for your application.

EYE-SPLICE - OVAL SLEEVE OR DUPLEX



LAP SPLICE - OVAL SLEEVES OR DUPLEX

STOP SLEEVE

Standard Eye Length for Ben-Mor Cable Assemblies

Cable Diameter	Dimensions in.	
	S After Swage	Tolerances (+/-)
3/64	1/2	1/32
1/16	5/8	1/32
5/64	5/8	1/32
3/32	3/4	1/32
1/8	1 1/4	1/16
5/32	1 1/2	3/32
3/16	2	1/8
7/32	3	5/32
1/4	4	3/16
5/16	5	1/4
3/8	6	5/16
7/16	7	3/8
1/2	8	7/16
9/16	9	7/16
5/8	10	1/2
3/4	12	5/8
7/8	14	3/4
1	16	3/4

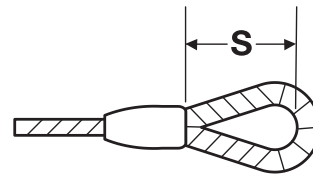

Other dimensions available upon request.



AN Thimbles (zinc plated)

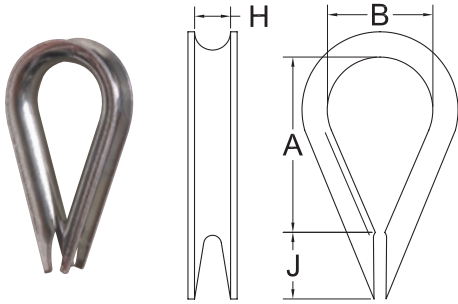

Code	For Cable Diameter in.	Weight / ea. approx. lbs.	Dimensions in.			
			A	B	H	J
ANTZ-116	3/64 – 1/16 – 5/64	.002	43/64	.350	3/32	3/16
ANTZ-018	3/32 – 7/64 – 1/8	.004	45/64	.350	9/64	7/32
ANTZ-532	5/32	.006	51/64	.400	11/64	7/32
ANTZ-316	3/16	.010	1	.500	13/64	5/16
ANTZ-014	7/32 – 1/4	.015	1 13/32	.700	17/64	13/32
ANTZ-516	9/32 – 5/16	.035	1 51/64	.900	21/64	7/16
ANTZ-038	3/8	.085	2	1.000	25/64	5/8

Standard Thimbles (hot dip galvanized)

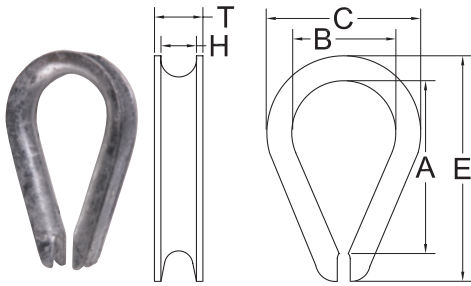

Code	For Cable Diameter in.	Weight / ea. approx. lbs.	Dimensions in.					
			A	B	C	E	H	T
STDTG-018	1/8 - 5/32	.035	1.31	.69	1.06	1.94	.16	.25
STDTG-316	3/16	.035	1.31	.69	1.06	1.94	.22	.31
STDTG-014	1/4	.035	1.31	.69	1.06	1.94	.28	.38
STDTG-516	5/16	.040	1.50	.81	1.25	2.13	.34	.44
STDTG-038	3/8	.075	1.63	.94	1.47	2.38	.41	.53
STDTG-012	1/2	.140	1.88	1.13	1.75	2.75	.53	.69
STDTG-058	5/8	.360	2.25	1.38	2.38	3.50	.66	.91
STDTG-034	3/4	.500	2.50	1.63	2.69	3.75	.78	1.08
STDTG-078	7/8	.900	3.50	1.88	3.19	5.00	.94	1.27
STDTG-001	1	1.04	4.25	2.50	3.75	5.69	1.06	1.39

Federal Specification : FF-T-276B Other dimensions available upon request.

HD Thimbles (hot dip galvanized)

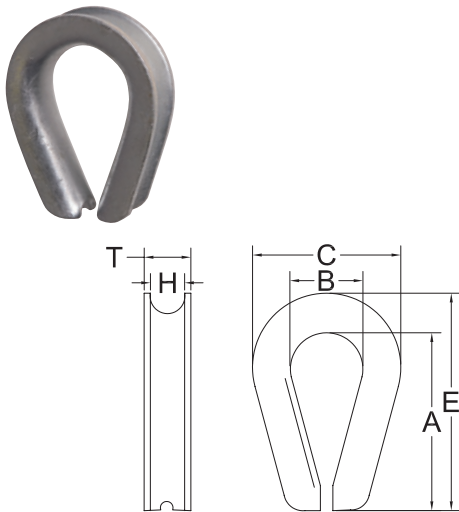

Code	For Cable Diameter in.	Weight / ea. approx. lbs.	Dimensions in.					
			A	B	C	E	H	T
HDTG-014	1/4	0.080	1.62	.88	1.50	2.19	.28	.41
HDTG-516	5/16	0.140	1.88	1.06	1.81	2.50	.34	.50
HDTG-038	3/8	0.260	2.12	1.12	2.12	2.88	.41	.63
HDTG-716	7/16	0.300	2.38	1.25	2.38	3.25	.47	.72
HDTG-012	1/2	0.440	2.75	1.50	2.75	3.62	.59	.89
HDTG-916	9/16	0.510	2.75	1.50	2.75	3.62	.59	.89
HDTG-058	5/8	0.740	3.25	1.75	3.12	4.25	.66	1.00
HDTG-034	3/4	1.150	3.75	2.00	3.81	5.00	.78	1.22
HDTG-078	7/8	1.500	4.25	2.25	4.25	5.50	.94	1.38
HDTG-001	1	2.250	4.50	2.50	4.75	6.12	1.06	1.56
HDTG-114	1 1/8 – 1 1/4	3.360	5.12	2.88	5.88	7.00	1.31	1.88
HDTG-138	1 1/4 – 1 3/8	8.17	6.50	3.50	6.81	9.08	1.44	2.25
HDTG-112	1 1/2	10.00	6.25	3.50	7.12	9.00	1.56	2.62
HDTG-002	2	27.75	12.00	6.00	10.38	15.12	2.09	3.38

Federal Specification : FF-T-276B Other dimensions available upon request.



Round Eye Thimbles (zinc plated)

Code	For Cable Diameter in.	Weight / ea.	Dimensions in.	
			E	G
RETZC-018281	3/32 – 1/8	0.02	0.625	0.281
RETZC-018359	3/32 – 1/8	0.02	0.625	0.359

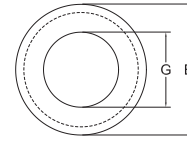

Solid Wire Rope Thimbles

Code	For Cable Diameter in.	Weight / ea. lbs.	Dimensions in.			
			C	E	G	T
S412-012	1/2	2.25	2 1/8	2 13/16	1	7/8
S412-058	5/8	6.00	3 3/8	4 11/16	1 3/16	1 1/8
S412-034	3/4	5.12	3 3/8	4 11/16	1 3/8	1 3/8
S412-078	7/8	10.00	4 1/2	6 1/16	1 5/8	1 5/8
S412-001	1	10.00	4 1/2	6 1/16	2	1 13/16
S412-118	1 1/8	10.00	5 3/8	7 1/4	2 1/4	2 1/16
S412-114	1 1/4 – 1 3/8	10.00	5 3/8	7 1/4	2 1/2	2 5/16

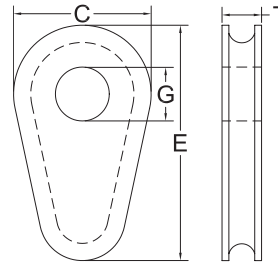

Eye & Eye Swivels (forged steel hot dip galvanized)

Code	Diameter in.	Working Load Limit lbs.	Weight / ea. lbs.	Dimensions in.	
				B	F
G402-014	1/4	850	0.21	3/4	2 15/16
G402-516	5/16	1,250	0.39	1	3 9/16
G402-038	3/8	2,250	0.75	1 1/4	4 5/16
G402-012	1/2	3,600	1.43	1 1/2	5 7/16
G402-058	5/8	5,200	2.50	1 3/4	6 9/16
G402-034	3/4	7,200	4.13	2	7 3/16
G402-078	7/8	10,000	6.25	2 1/4	8 3/8
G402-001	1	12,500	9.00	2 1/2	9 5/8
G402-114	1 1/4	18,000	15.75	3 1/8	11 1/8
G402-112	1 1/2	45,200	54.75	4	17 1/8

Safety Factor 5:1

Federal Specification : RR-C-271D

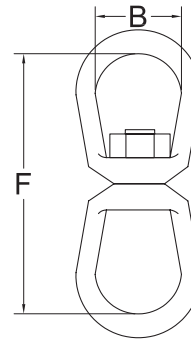

Jaw & Eye Swivels (forged steel hot dip galvanized)

Code	Diameter in.	Working Load Limit lbs.	Weight / ea. lbs.	Dimensions in.		
				B	F	H
G403-014	1/4	850	0.25	3/4	2 5/8	15/32
G403-516	5/16	1,250	0.37	1	2 15/16	1/2
G403-038	3/8	2,250	0.70	1 1/4	3 5/8	5/8
G403-012	1/2	3,600	1.43	1 1/2	4 1/2	3/4
G403-058	5/8	5,200	2.48	1 3/4	5 5/16	15/16
G403-034	3/4	7,200	3.88	2	6 1/16	1 1/8
G403-078	7/8	10,000	5.75	2 1/4	7	1 3/16
G403-001	1	12,500	10.25	2 1/2	8 9/16	1 3/4
G403-114	1 1/4	18,000	15.75	3 1/8	9 7/16	2 1/16

Safety Factor 5:1

Federal Specification : RR-C-271D

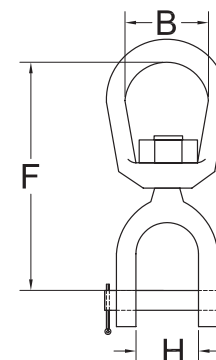



Wire Rope Clips (malleable, zinc plated)

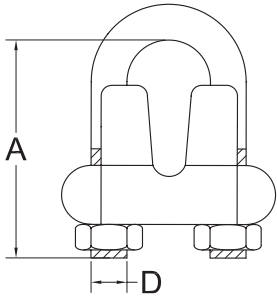

Code	For Cable Diameter in.	Weight / ea. lbs.	Dimensions in.		Nut Torque ft./lbs.	Wire Rope Clips Min. Qty	Turn Back Length in.
			A Minimum	D Minimum			
WRCMA-116	1/16	0.03	0.630	8 - 32	3.0	3	3
WRCMA-018	3/32 - 1/8	0.04	0.780	10 - 24	3.0	3	4 3/4
WRCMA-316	3/16	0.06	0.875	10 - 24	4.5	3	5 1/2
WRCMA-014	1/4	0.12	1.188	5/16 - 18	15	3	7
WRCMA-516	5/16	0.14	1.188	5/16 - 18	15	3	7 3/4
WRCMA-038	3/8	0.21	1.563	3/8 - 16	30	3	9 1/2
WRCMA-716	7/16	0.27	1.625	3/8 - 16	40	3	10 1/4
WRCMA-012	1/2	0.35	2.000	7/16 - 14	45	4	15 1/4
WRCMA-058	5/8	0.58	2.313	1/2 - 13	75	4	16
WRCMA-034	3/4	0.84	2.563	9/16 - 12	75	5	22 1/4
WRCMA-078	7/8	1.24	3.063	5/8 - 11	130	5	23 1/2
WRCMA-001	1	1.50	3.375	5/8 - 11	130	6	31
WRCMA-118	1 1/8	2.60	3.875	3/4 - 10	200	7	39 1/2
WRCMA-114	1 1/4	3.60	3.875	3/4 - 10	200	8	50

Federal Specification : FF-C-450 Other dimensions available upon request. Stamped with size on the saddle.

INSTRUCTIONS FOR USE OF WIRE ROPE CLIPS :

Wire rope clips are not to be used on coated cable without first stripping off the coating. Apply U-Bolt over dead end of wire rope. Live end rests in saddle. (Never saddle a dead horse !)

See following table for indications concerning quantity of clips to be installed and "turn back" lengths required on specific diameters of rope. These indications are valid for most cable "constructions". Please contact our specialists for more information.



Wire Rope Clips Brown Pin® (drop-forged, hot dip galvanized)



Brown Pin®

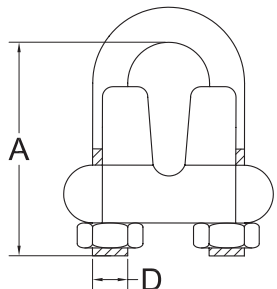

Code	For Cable Diameter in.	Weight / ea. lbs.	Dimensions in.		Nut Torque ft./lbs.	Wire Rope Clips Min. Qty	Turn Back Length in.
			A Minimum	D Minimum			
WRCDF-BP-018	1/8	0.06	0.719	12 - 24	4.5	2	3 1/4
WRCDF-BP-316	3/16	0.10	0.938	1/4 - 20	7.5	2	3 3/4
WRCDF-BP-014	1/4	0.19	1.031	5/16 - 18	15	2	4 3/4
WRCDF-BP-516	5/16	0.28	1.313	3/8 - 16	30	2	5 1/4
WRCDF-BP-038	3/8	0.48	1.500	7/16 - 14	45	2	6 1/2
WRCDF-BP-716	7/16	0.76	1.875	1/2 - 13	65	2	7
WRCDF-BP-012	1/2	0.80	1.875	1/2 - 13	65	3	11 1/2
WRCDF-BP-916	9/16	1.04	2.250	9/16 - 12	95	3	12
WRCDF-BP-058	5/8	1.10	2.375	9/16 - 12	95	3	12
WRCDF-BP-034	3/4	1.42	2.750	5/8 - 11	130	4	18
WRCDF-BP-078	7/8	2.12	3.125	3/4 - 10	225	4	19
WRCDF-BP-001	1	2.52	3.500	3/4 - 10	225	5	26
WRCDF-BP-118	1 1/8	2.90	3.875	3/4 - 10	225	6	34
WRCDF-BP-114	1 1/4	4.30	4.250	7/8 - 9	360	7	44
WRCDF-BP-112	1 1/2	5.40	4.940	7/8 - 9	360	8	54

Federal Specification : FF-C-450 Other dimensions available upon request. Stamped with size and BM for "Ben-Mor" identification code on the saddle.

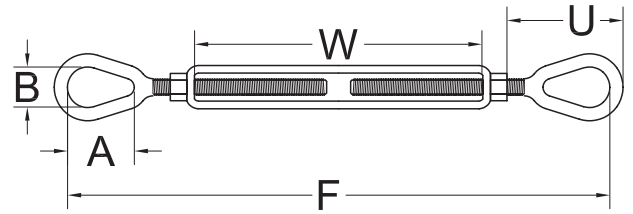

Hot Dip Galvanized Turnbuckles (EYE & EYE), drop-forged

Code	Thread Dia. x Take-Up in.	Working Load Limit lbs.	Weight Each lbs.	Dimensions in.					
				A	B	F Open	F Closed	U Closed	W
TEEG-01404	1/4 x 4	500	0.26	.78	.34	11.80	7.80	1.75	4.00
TEEG-516412	5/16 x 4 1/2	800	0.45	.94	.44	13.56	9.06	2.09	4.50
TEEG-03806	3/8 x 6	1,200	0.75	1.12	.53	17.47	11.47	2.52	6.00
TEEG-01206	1/2 x 6	2,200	1.50	1.44	.72	20.08	13.08	3.23	6.00
TEEG-01209	1/2 x 9	2,200	1.75	1.44	.72	26.08	16.08	3.23	9.00
TEEG-01212	1/2 x 12	2,200	2.18	1.44	.72	32.08	19.08	3.23	12.00
TEEG-05806	5/8 x 6	3,500	2.63	1.75	.88	21.93	14.68	3.90	6.00
TEEG-05809	5/8 x 9	3,500	3.00	1.75	.88	27.93	17.68	3.90	9.00
TEEG-05812	5/8 x 12	3,500	3.25	1.75	.88	33.93	20.68	3.90	12.00
TEEG-03406	3/4 x 6	5,200	3.75	2.09	1.00	23.88	16.38	4.69	6.00
TEEG-03409	3/4 x 9	5,200	4.50	2.09	1.00	29.88	19.38	4.69	9.00
TEEG-03412	3/4 x 12	5,200	5.75	2.09	1.00	35.88	22.38	4.69	12.00
TEEG-03418	3/4 x 18	5,200	7.00	2.09	1.00	47.88	28.38	4.69	18.00
TEEG-07812	7/8 x 12	7,200	8.35	2.38	1.25	37.07	23.32	5.10	12.00
TEEG-07818	7/8 x 18	7,200	10.25	2.38	1.25	49.07	29.32	5.10	18.00
TEEG-00106	1 x 6	10,000	9.04	3.00	1.44	27.97	19.97	6.36	6.00
TEEG-00112	1 x 12	10,000	11.25	3.00	1.44	39.97	25.97	6.36	12.00
TEEG-00118	1 x 18	10,000	14.0	3.00	1.44	51.97	31.97	6.36	18.00
TEEG-00124	1 x 24	10,000	17.0	3.00	1.44	63.97	37.97	6.36	24.00
TEEG-11412	1 1/4 x 12	15,200	19.0	3.56	1.81	42.81	28.31	7.72	12.00
TEEG-11418	1 1/4 x 18	15,200	24.1	3.56	1.81	54.81	34.31	7.72	18.00
TEEG-11424	1 1/4 x 24	15,200	27.0	3.56	1.81	66.81	40.31	7.72	24.00
TEEG-11212	1 1/2 x 12	21,400	27.0	4.06	2.12	45.50	30.50	8.62	12.00
TEEG-11218	1 1/2 x 18	21,400	31.2	4.06	2.12	57.50	36.50	8.62	18.00
TEEG-11224	1 1/2 x 24	21,400	38.2	4.06	2.12	69.50	42.50	8.62	24.00
TEEG-13418	1 3/4 x 18	28,000	45.0	4.62	2.38	57.38	39.38	10.00	18.00
TEEG-13424	1 3/4 x 24	28,000	58.0	4.62	2.38	69.38	45.38	10.00	24.00
TEEG-00224	2 x 24	37,000	85.0	5.75	2.69	75.69	51.69	13.09	24.00
TEEG-21224	2 1/2 x 24	60,000	148.0	6.50	3.12	78.62	54.62	13.78	24.00
TEEG-23424	2 3/4 x 24	75,000	180.0	7.00	3.25	81.00	57.00	15.22	24.00

Safety Factor 5:1

Federal Specification : FF-T-791B Other dimensions available upon request.

UNC Threading.

Jam Nut : included in sizes 1/4" to 1/2"

End fittings are quenched and tempered.

Body is heat treated by normalizing.

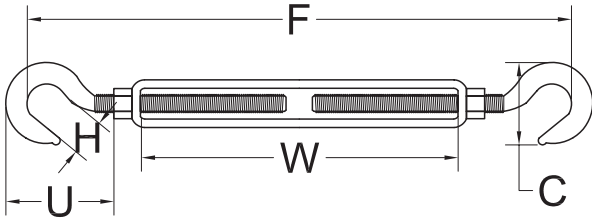

Hot Dip Galvanized Turnbuckles (HOOK & HOOK), drop-forged

Code	Thread Dia. x Take-Up in.	Working Load Limit lbs.	Weight Each lbs.	Dimensions in.					
				C	F Open	F Closed	H	U Closed	W
THHG-01404	1/4 x 4	400	0.26	1.27	11.12	7.12	.45	1.59	4.00
THHG-516412	5/16 x 4 1/2	700	0.45	1.50	12.81	8.31	.50	1.94	4.50
THHG-03806	3/8 x 6	1,000	0.75	1.77	16.50	10.50	.56	2.30	6.00
THHG-01206	1/2 x 6	1,500	1.50	2.28	18.82	11.82	.66	2.94	6.00
THHG-01209	1/2 x 9	1,500	1.75	2.28	24.82	14.82	.66	2.94	9.00
THHG-01212	1/2 x 12	1,500	2.18	2.28	30.82	17.82	.66	2.94	12.00
THHG-05806	5/8 x 6	2,250	2.63	2.81	20.50	13.25	.90	3.69	6.00
THHG-05809	5/8 x 9	2,250	3.00	2.81	26.50	16.25	.90	3.69	9.00
THHG-05812	5/8 x 12	2,250	3.25	2.81	32.50	19.25	.90	3.69	12.00
THHG-03406	3/4 x 6	3,000	3.75	3.33	22.38	14.88	.98	4.52	6.00
THHG-03409	3/4 x 9	3,000	4.50	3.33	28.38	17.88	.98	4.52	9.00
THHG-03412	3/4 x 12	3,000	5.75	3.33	34.38	20.88	.98	4.52	12.00
THHG-03418	3/4 x 18	3,000	7.00	3.33	46.38	26.88	.98	4.52	18.00
THHG-07812	7/8 x 12	4,000	8.35	3.78	36.00	22.25	1.13	5.19	12.00
THHG-07818	7/8 x 18	4,000	10.25	3.78	48.00	28.25	1.13	5.19	18.00
THHG-00106	1 x 6	5,000	9.04	4.25	25.63	17.63	1.25	5.84	6.00
THHG-00112	1 x 12	5,000	11.25	4.25	37.63	23.63	1.25	5.84	12.00
THHG-00118	1 x 18	5,000	14.0	4.25	49.63	29.63	1.25	5.84	18.00
THHG-00124	1 x 24	5,000	17.0	4.25	61.63	35.63	1.25	5.84	24.00
THHG-11412	1 1/4 x 12	6,500	19.0	5.13	40.50	26.50	1.50	7.22	12.00
THHG-11418	1 1/4 x 18	6,500	24.1	5.13	52.50	32.50	1.50	7.22	18.00
THHG-11424	1 1/4 x 24	6,500	27.0	5.13	64.50	38.50	1.50	7.22	24.00
THHG-11212	1 1/2 x 12	7,500	27.0	5.75	43.50	30.50	1.88	8.34	12.00
THHG-11218	1 1/2 x 18	7,500	31.2	5.75	55.50	36.50	1.88	8.34	18.00
THHG-11224	1 1/2 x 24	7,500	38.2	5.75	67.50	42.50	1.88	8.34	24.00
Safety Factor 5:1									

Federal Specification : FF-T-791B Other dimensions available upon request.

UNC Threading.

Jam Nut : included in sizes 1/4" to 1/2"

End fittings are quenched and tempered.

Body is heat treated by normalizing.

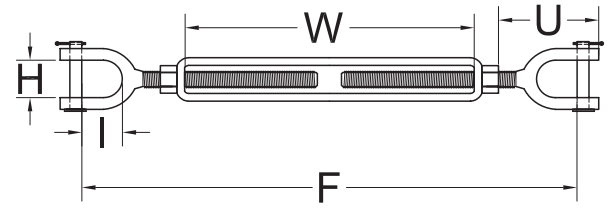

Hot Dip Galvanized Turnbuckles (JAW & JAW), drop-forged

Code	Thread Dia. x Take-Up in.	Working Load Limit lbs.	Weight Each lbs.	Dimensions in.					
				F Open	F Closed	H	I	U Closed	W
TJJG-01404	1/4 x 4	500	0.36	10.90	6.90	.45	.62	1.58	4.00
TJJG-516412	5/16 x 4 1/2	800	0.52	12.36	8.36	.50	.87	1.98	4.50
TJJG-03806	3/8 x 6	1,200	0.93	16.14	10.14	.54	.87	2.12	6.00
TJJG-01206	1/2 x 6	2,200	1.68	18.50	11.50	.65	1.06	2.75	6.00
TJJG-01209	1/2 x 9	2,200	1.85	24.50	14.50	.65	1.06	2.75	9.00
TJJG-01212	1/2 x 12	2,200	2.20	30.50	17.50	.65	1.06	2.75	12.00
TJJG-05806	5/8 x 6	3,500	2.82	20.05	12.80	.79	1.31	3.50	6.00
TJJG-05809	5/8 x 9	3,500	3.25	26.05	15.80	.79	1.31	3.50	9.00
TJJG-05812	5/8 x 12	3,500	3.75	32.05	18.80	.79	1.31	3.50	12.00
TJJG-03406	3/4 x 6	5,200	4.68	21.50	14.00	.94	1.50	4.18	6.00
TJJG-03409	3/4 x 9	5,200	5.36	27.50	17.00	.94	1.50	4.18	9.00
TJJG-03412	3/4 x 12	5,200	6.12	33.50	20.00	.94	1.50	4.18	12.00
TJJG-03418	3/4 x 18	5,200	7.75	45.50	26.00	.94	1.50	4.18	18.00
TJJG-07812	7/8 x 12	7,200	9.38	35.11	21.36	1.13	1.75	4.85	12.00
TJJG-07818	7/8 x 18	7,200	11.44	47.11	27.36	1.13	1.75	4.85	18.00
TJJG-00106	1 x 6	10,000	10.20	24.72	16.72	1.34	2.06	5.53	6.00
TJJG-00112	1 x 12	10,000	12.88	36.72	22.72	1.34	2.06	5.53	12.00
TJJG-00118	1 x 18	10,000	16.10	48.72	28.72	1.34	2.06	5.53	18.00
TJJG-00124	1 x 24	10,000	18.60	60.72	34.72	1.34	2.06	5.53	24.00
TJJG-11412	1 1/4 x 12	15,200	23.60	39.84	25.34	1.75	2.81	7.21	12.00
TJJG-11418	1 1/4 x 18	15,200	26.60	51.84	31.34	1.75	2.81	7.21	18.00
TJJG-11424	1 1/4 x 24	15,200	29.00	63.84	37.34	1.75	2.81	7.21	24.00
TJJG-11212	1 1/2 x 12	21,400	35.50	41.50	26.50	2.06	2.81	7.88	12.00
TJJG-11218	1 1/2 x 18	21,400	40.70	53.50	32.50	2.06	2.81	7.88	18.00
TJJG-11224	1 1/2 x 24	21,400	47.60	65.50	38.50	2.06	2.81	7.88	24.00
TJJG-13418	1 3/4 x 18	28,000	52.40	53.38	35.38	2.60	3.38	9.40	18.00
TJJG-13424	1 3/4 x 24	28,000	64.00	65.38	41.38	2.60	3.38	9.40	24.00
TJJG-00224	2 x 24	37,000	94.00	69.54	45.54	2.62	3.69	11.86	24.00
TJJG-21224	2 1/2 x 24	60,000	175.00	72.98	48.98	3.06	4.44	13.56	24.00
TJJG-23424	2 3/4 x 24	75,000	248.00	74.75	50.75	3.63	4.19	15.22	24.00

Safety Factor 5:1

Federal Specification : FF-T-791B Other dimensions available upon request.

Forged jaw ends are fitted with bolts and nuts for 1/4" through 5/8", and pin cotters on 3/4" through 2 3/4" sizes.

UNC Threading.

Jam Nut : included in sizes 1/4" to 1/2"

End fittings are quenched and tempered.

Body is heat treated by normalizing.

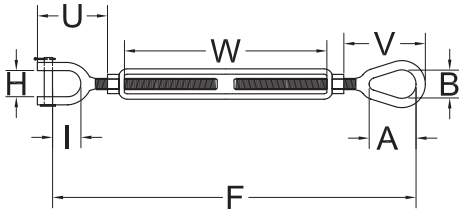

Hot Dip Galvanized Turnbuckles (JAW & EYE), drop-forged

Code	Thread Dia. x Take-Up in.	Working Load Limit lbs.	Weight Each lbs.	Dimensions in.								
				A	B	F Open	F Closed	H	I	U Closed	V Closed	W
TJEG-01404	1/4 x 4	500	.30	.78	.34	11.35	7.35	.45	.62	1.58	1.75	4.00
TJEG-516412	5/16 x 4 1/2	800	.50	.94	.44	13.71	8.71	.50	.87	1.98	2.09	4.50
TJEG-03806	3/8 x 6	1,200	.80	1.12	.53	16.81	10.81	.54	.87	2.12	2.52	6.00
TJEG-01206	1/2 x 6	2,200	1.51	1.44	.72	19.29	12.29	.65	1.06	2.75	3.23	6.00
TJEG-01209	1/2 x 9	2,200	1.71	1.44	.72	25.29	15.29	.65	1.06	2.75	3.23	9.00
TJEG-01212	1/2 x 12	2,200	2.08	1.44	.72	31.29	18.29	.65	1.06	2.75	3.23	12.00
TJEG-05806	5/8 x 6	3,500	2.35	1.75	.88	20.99	13.74	.79	1.31	3.50	3.90	6.00
TJEG-05809	5/8 x 9	3,500	3.17	1.75	.88	26.99	16.74	.79	1.31	3.50	3.90	9.00
TJEG-05812	5/8 x 12	3,500	3.61	1.75	.88	32.99	19.74	.79	1.31	3.50	3.90	12.00
TJEG-03406	3/4 x 6	5,200	4.00	2.09	1.00	22.69	15.19	.94	1.50	4.18	4.69	6.00
TJEG-03409	3/4 x 9	5,200	4.75	2.09	1.00	28.69	18.19	.94	1.50	4.18	4.69	9.00
TJEG-03412	3/4 x 12	5,200	5.93	2.09	1.00	34.69	21.19	.94	1.50	4.18	4.69	12.00
TJEG-03418	3/4 x 18	5,200	7.00	2.09	1.00	46.69	27.19	.94	1.50	4.18	4.69	18.00
TJEG-07812	7/8 x 12	7,200	8.36	2.38	1.25	36.09	22.34	1.13	1.75	4.85	5.10	12.00
TJEG-07818	7/8 x 18	7,200	9.75	2.38	1.25	48.09	28.34	1.13	1.75	4.85	5.10	18.00
TJEG-00106	1 x 6	10,000	8.92	3.00	1.44	26.34	18.34	1.34	2.06	5.53	6.36	6.00
TJEG-00112	1 x 12	10,000	11.20	3.00	1.44	38.34	24.34	1.34	2.06	5.53	6.36	12.00
TJEG-00118	1 x 18	10,000	13.30	3.00	1.44	50.34	30.34	1.34	2.06	5.53	6.36	18.00
TJEG-00124	1 x 24	10,000	17.00	3.00	1.44	62.34	36.34	1.34	2.06	5.53	6.36	24.00
TJEG-11412	1 1/4 x 12	15,200	19.42	3.56	1.81	41.32	26.82	1.75	2.81	7.21	7.72	12.00
TJEG-11418	1 1/4 x 18	15,200	24.18	3.56	1.81	53.32	32.82	1.75	2.81	7.21	7.72	18.00
TJEG-11424	1 1/4 x 24	15,200	28.50	3.56	1.81	65.32	38.82	1.75	2.81	7.21	7.72	24.00
TJEG-11212	1 1/2 x 12	21,400	28.99	4.06	2.12	43.50	28.50	2.06	2.81	7.88	8.62	12.00
TJEG-11218	1 1/2 x 18	21,400	35.00	4.06	2.12	55.50	34.50	2.06	2.81	7.88	8.62	18.00
TJEG-11224	1 1/2 x 24	21,400	39.18	4.06	2.12	67.50	40.50	2.06	2.91	7.88	8.62	24.00
TJEG-13418	1 3/4 x 18	28,000	53.75	4.62	2.38	53.38	37.38	2.60	3.38	9.40	10.00	18.00
TJEG-13424	1 3/4 x 24	28,000	60.68	4.62	2.38	67.38	43.38	2.60	3.38	9.40	10.00	24.00
TJEG-00224	2 x 24	37,000	89.00	5.75	2.69	72.62	48.62	2.62	3.69	11.86	11.86	24.00
TJEG-21224	2 1/2 x 24	60,000	165.00	6.50	3.12	75.80	51.80	3.06	4.44	13.56	13.78	24.00
TJEG-23424	2 3/4 x 24	75,000	183.00	7.00	3.25	77.88	53.88	3.68	4.19	15.22	15.22	24.00

Safety Factor 5:1

Federal Specification : FF-T-791B Other dimensions available upon request.

Forged jaw ends are fitted with bolts and nuts for 1/4" through 5/8", and pin cotters on 3/4" through 2 3/4" sizes.

UNC Threading.

Jam Nut : included in sizes 1/4" to 1/2"

End fittings are quenched and tempered.

Body is heat treated by normalizing.



Stub end Turnbuckles, self colored, drop forged

Code	Size Diameter x Take-Up in.	Working Load Limit lbs.	Weight / ea. lbs.	Dimensions in.			
				E	F	U	W
TSE-03806	3/8 x 6	1,200	0.75	7.13	16.0	4.44	6.0
TSE-01206	1/2 x 6	2,200	1.25	7.50	16.0	4.25	6.0
TSE-01209	1/2 x 9	2,200	1.70	10.50	19.0	4.25	9.0
TSE-05806	5/8 x 6	3,500	2.11	7.88	16.0	4.06	6.0
TSE-03406	3/4 x 6	5,200	3.27	8.25	17.0	4.38	6.0
TSE-03409	3/4 x 9	5,200	3.90	11.25	20.0	4.38	9.0
TSE-03412	3/4 x 12	5,200	4.60	14.25	23.0	4.38	12.0
TSE-07806	7/8 x 6	7,200	4.78	8.63	18.0	4.69	6.0
TSE-00106	1 x 6	10,000	6.36	9.00	19.0	5.00	6.0
TSE-00112	1 x 12	10,000	8.80	15.00	25.0	5.00	12.0
TSE-11806	1 1/8 x 6	12,400	8.88	9.13	19.0	4.94	6.0
TSE-11406	1 1/4 x 6	15,200	10.18	9.13	20.0	5.44	6.0
TSE-11412	1 1/4 x 12	15,200	13.60	15.12	26.0	5.44	12.0
TSE-11206	1 1/2 x 6	21,400	15.30	9.75	20.5	5.38	6.0
TSE-11212	1 1/2 x 12	21,400	20.44	15.75	26.5	5.38	12.0
TSE-13406	1 3/4 x 6	28,000	30.00	TBD	TBD	TBD	6.0

Safety Factor 5:1

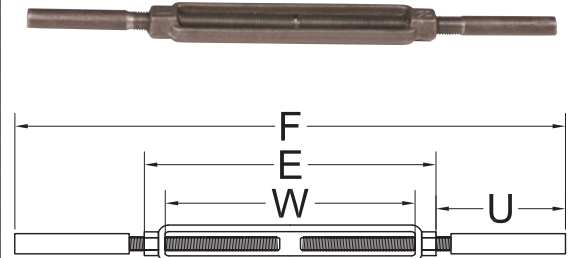

Body is heat treated by normalizing.

Federal Specification : FF-T-791B

Turnbuckles (body only) Hot Dip Galvanized, drop forged

Code	Size Diameter x Take-Up in.	Working Load Limit lbs.	Weight / ea. lbs.	Dimensions in.		
				C	E	W
TBG-01404	1/4 x 4	500	0.15	.72	4.75	4.00
TBG-03806	3/8 x 6	1,200	0.29	.88	7.12	6.00
TBG-01206	1/2 x 6	2,200	0.60	1.12	7.50	6.00
TBG-01212	1/2 x 12	2,200	1.00	1.12	13.50	12.00
TBG-05806	5/8 x 6	3,500	0.90	1.38	7.88	6.00
TBG-03406	3/4 x 6	5,200	1.30	1.69	8.25	6.00
TBG-03412	3/4 x 12	5,200	2.08	1.69	14.25	12.00
TBG-00106	1 x 6	10,000	2.48	2.25	9.00	6.00
TBG-00112	1 x 12	10,000	3.93	2.25	15.00	12.00
TBG-11412	1 1/4 x 12	15,200	5.25	2.62	15.12	12.00

Safety Factor 5:1

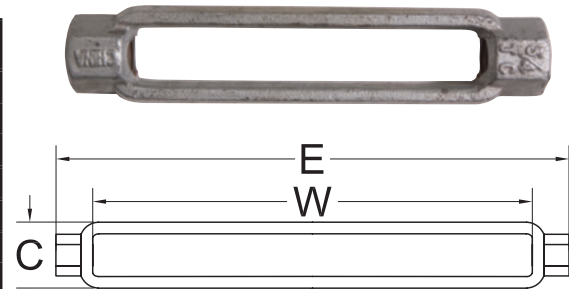

Body is heat treated by normalizing.

Federal Specification : FF-T-791B Other diameters and/or color available upon request.

Zinc Die Cast Ben-Mor Turnbuckles

Code H & E	Thread Diameter x Take-Up in.	Working Load Limit lbs.	Weight /ea. lbs.	B	F Closed	H	U1 Closed	U2 Closed	W
THEZ-014218	1/4 x 2 1/8	150	0.17	0.425	4.750	0.375	0.375	0.950	2.375
THEZ-516258	5/16 x 2 5/8	225	0.25	0.425	5.750	0.445	0.445	1.300	2.625
THEZ-038003	3/8 x 3	300	0.41	0.500	7.250	0.750	0.750	2.170	3.000

UNC Threading

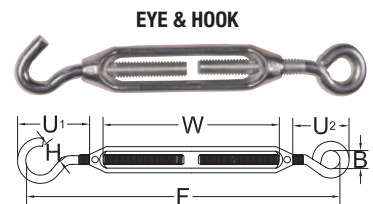

Code E & E	Thread Diameter x Take-Up in.	Working Load Limit lbs.	Weight / ea. lbs.	B	F Closed	U2 Closed	W
TEEZ-014218	1/4 x 2 1/8	150	0.17	0.425	4.750	0.970	2.375
TEEZ-516258	5/16 x 2 5/8	225	0.25	0.380	6.375	1.580	2.625
TEEZ-038003	3/8 x 3	300	0.41	0.500	7.125	1.800	3.000

UNC Threading

Body zinc die cast. End fittings steel zinc plated.

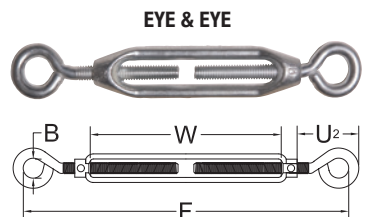



Bolt Type Anchor Shackles Brown Pin®, rated (drop forged, hot dip galvanized)

Code	Size in.	Working Load Limit TON	Weight / ea. lbs.	Dimensions in.								
				A		B Min	D Min	G Max	H		L Min	T Max
				Nominal	±				Nominal	±		
SPAS2130BP038	3/8	1	0.30	1 7/16	1/8	15/16	3/8	15/32	21/32	1/16	7/16	1 1/2
SPAS2130BP012	1/2	2	0.79	1 7/8	1/8	1 3/16	1/2	23/32	13/16	1/16	5/8	1 3/8
SPAS2130BP058	5/8	3 1/4	1.68	2 13/32	1/8	1 1/2	5/8	27/32	1 1/16	1/16	3/4	1 7/8
SPAS2130BP034	3/4	4 3/4	2.28	2 27/32	1/4	1 3/4	3/4	31/32	1 1/4	1/16	7/8	2 1/8
SPAS2130BP078	7/8	6 1/2	3.95	3 5/16	1/4	2	7/8	1 3/32	1 7/16	1/16	1	2 3/8
SPAS2130BP001	1	8 1/2	6.12	3 3/4	1/4	2 5/16	1	1 7/32	1 11/16	1/16	1 1/8	2 5/8
SPAS2130BP118	1 1/8	9 1/2	8.27	4 1/4	1/4	2 5/8	1 1/8	1 11/32	1 13/16	1/16	1 1/4	2 7/8
SPAS2130BP114	1 1/4	12	11.71	4 11/16	1/4	2 7/8	1 1/4	1 15/32	2 1/32	1/16	1 3/8	3 1/4
SPAS2130BP138	1 3/8	13 1/2	15.38	5 1/4	1/4	3 1/4	1 3/8	1 5/8	2 1/4	1/8	1 1/2	3 1/2
SPAS2130BP112	1 1/2	17	20.80	5 3/4	1/4	3 3/8	1 1/2	1 3/4	2 3/8	1/8	1 5/8	3 3/4
SPAS2130BP134	1 3/4	25	33.91	7	1/4	4 1/2	1 3/4	2 5/32	2 7/8	1/8	2	4 1/2
SPAS2130BP002	2	35	52.25	7 3/4	1/2	5 1/4	2	2 13/32	3 1/4	1/8	2 1/4	5 1/4
SPAS2130BP212	2 1/2	55	94.00	10 3/16	1/2	7	2 3/4	2 13/16	4 1/8	1/8	2 3/4	6

Safety Factor 6:1

Federal Specification : RR-C-271F and ASME B30.26-2010.

Forged steel, quenched and tempered.

Alloy brown pin stamped with the manufacturer identification code and HS for "High Strength".

Body stamped with BM identification code, WLL (working load limit), Size, 45° angle marks and traceability code.

Screw Pin Anchor Shackles Brown Pin®, rated (drop forged, hot dip galvanized)

Code	Size in.	Working Load Limit TON	Weight / ea. lbs.	Dimensions in.								
				A		B Min	D Min	G Max	H		L Min	T Max
				Nominal	±				Nominal	±		
SPASX-BP-316	3/16	1/3	0.06	7/8	1/16	9/16	3/16	5/16	3/8	1/16	1/4	5/8
SPASX-BP-014	1/4	1/2	0.10	1 1/8	1/16	3/4	1/4	13/32	15/32	1/16	5/16	7/8
SPASX-BP-516	5/16	3/4	0.19	1 1/4	1/16	13/16	5/16	15/32	17/32	1/16	3/8	1
SPASX-BP-038	3/8	1	0.31	1 7/16	1/8	15/16	3/8	17/32	21/32	1/16	7/16	1 1/8
SPASX-BP-716	7/16	1 1/2	0.38	1 11/16	1/8	1 1/16	7/16	19/32	23/32	1/16	1/2	1 1/4
SPASX-BP-012	1/2	2	0.72	1 7/8	1/8	1 3/16	1/2	23/32	13/16	1/16	5/8	1 3/8
SPASX-BP-058	5/8	3 1/4	1.37	2 13/32	1/8	1 1/2	5/8	27/32	1 1/16	1/16	3/4	1 7/8
SPASX-BP-034	3/4	4 3/4	2.35	2 27/32	1/4	1 3/4	3/4	31/32	1 1/4	1/16	7/8	2 1/8
SPASX-BP-078	7/8	6 1/2	3.62	3 5/16	1/4	2	7/8	1 3/32	1 7/16	1/16	1	2 3/8
SPASX-BP-001	1	8 1/2	5.00	3 3/4	1/4	2 5/16	1	1 7/32	1 11/16	1/16	1 1/8	2 5/8
SPASX-BP-118	1 1/8	9 1/2	7.41	4 1/4	1/4	2 5/8	1 1/8	1 11/32	1 13/16	1/16	1 1/4	2 7/8
SPASX-BP-114	1 1/4	12	9.50	4 11/16	1/4	2 7/8	1 1/4	1 15/32	2 1/32	1/16	1 3/8	3 1/4
SPASX-BP-138	1 3/8	13 1/2	13.53	5 1/4	1/4	3 1/4	1 3/8	1 5/8	2 1/4	1/8	1 1/2	3 1/2
SPASX-BP-112	1 1/2	17	17.20	5 3/4	1/4	3 3/8	1 1/2	1 3/4	2 3/8	1/8	1 5/8	3 3/4
SPASX-BP-134	1 3/4	25	27.78	7	1/4	4 1/2	1 3/4	2 5/32	2 7/8	1/8	2	4 1/2
SPASX-BP-002	2	35	45.0	7 3/4	1/2	5 1/4	2	2 13/32	3 1/4	1/8	2 1/4	5 1/4
SPASX-BP-212	2 1/2	55	85.0	10 1/2	1/2	6 3/4	2 1/2	2 29/32	4 1/8	1/8	2 3/4	6 1/4

Safety Factor 6:1

Federal Specification : RR-C-271F and ASME B30.26-2010.

Forged steel, quenched and tempered.

Alloy brown pin stamped with the manufacturer identification code and HS for "High Strength".

Body stamped with BM identification code, WLL (working load limit), Size, 45° angle marks and traceability code.



Screw Pin Anchor Shackles, non-rated, Commercial (hot dip galvanized)

Code	Size in.	Working Load Limit TON	Weight / ea. lbs.	Dimensions in.						
				A	B	D	G	H	L	T
SPAS-316	3/16	1/4	0.06	13/16	5/8	3/16	.260	.400	1/4	1/2
SPAS-014	1/4	1/3	0.10	1	3/4	1/4	.350	.500	5/16	9/16
SPAS-516	5/16	1/2	0.19	1 3/16	13/16	5/16	.425	.525	3/8	11/64
SPAS-038	3/8	3/4	0.31	1 3/8	1	3/8	.500	.675	7/16	13/16
SPAS-716	7/16	1	0.38	1 5/8	1 1/8	7/16	.550	.750	1/2	15/16
SPAS-012	1/2	1 1/2	0.72	1 7/8	1 1/4	1/2	.660	.775	5/8	1 1/16
SPAS-058	5/8	2 1/4	1.37	2 3/8	1 11/16	5/8	.610	1.000	3/4	1 3/8
SPAS-034	3/4	3 1/4	2.35	2 5/8	2	3/4	.975	1.250	7/8	1 1/2
SPAS-078	7/8	4 1/3	3.62	3	2 1/4	7/8	1.000	1.500	1	1 7/8
SPAS-001	1	5 1/2	5.00	4	2 5/8	1	1.200	1.675	1 1/8	2 1/4

Safety Factor 5:1

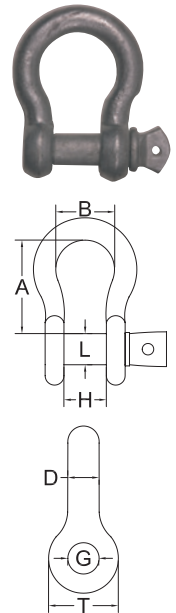

Shackles Ben-Mor "Brown Pin"®
US Federal Specs RR-C-271F
ASME B30.26-2010

Lifting references

Supplier

Dimension

Working Load Limit

Batch identification

Brown Pin®
Trade mark registered

Alloy brown pin stamped with the manufacturer identification code and HS for "High Strength".



Shoulder Nut Eye Bolt • Installation for Angular Loading

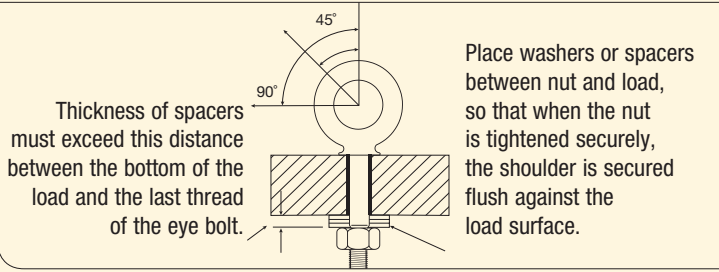

- ✓ The thread shank must protrude through the load sufficiently to allow full engagement of the nut.
- ✓ If the eye bolt protrudes so far through the load that the nut cannot be tightened securely against the load, use properly sized washers to take up the excess space BETWEEN THE NUT AND THE LOAD.

Shoulder Nut Eye Bolts (galvanized, drop-forged, carbon steel quenched and tempered)

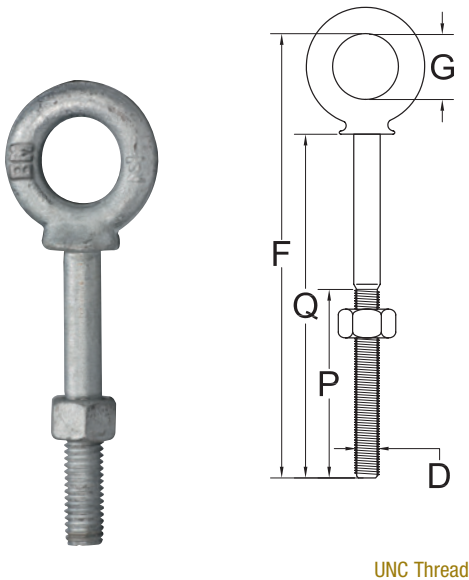

Code	Working Load Limit lbs.	Weight / ea. lbs.	Dimensions in.				
			D	F	G	P	Q
SNEB-014002	500	0.07	1/4	2 3/4	1/2	1 1/2	2
SNEB-014004	500	0.09	1/4	4 3/4	1/2	2 1/2	4
SNEB-516214	800	0.12	5/16	3 1/4	5/8	1 1/2	2 1/4
SNEB-516414	800	0.19	5/16	5 1/4	5/8	2 1/2	4 1/4
SNEB-038212	1,200	0.22	3/8	3 5/8	3/4	1 1/2	2 1/2
SNEB-038412	1,200	0.25	3/8	5 5/8	3/4	2 1/2	4 1/2
SNEB-012314	2,200	0.43	1/2	5	1	1 1/2	3 1/4
SNEB-012006	2,200	0.56	1/2	7 1/2	1	3	6
SNEB-058004	3,500	0.70	5/8	5 7/8	1 1/4	2	4
SNEB-058006	3,500	1.00	5/8	7 7/8	1 1/4	3	6
SNEB-034412	5,200	1.44	3/4	6 3/4	1 1/2	2	4 1/2
SNEB-034006	5,200	1.70	3/4	8 1/4	1 1/2	3	6
SNEB-078005	7,200	2.25	7/8	7 3/4	1 3/4	2 1/2	5
SNEB-001006	10,000	3.67	1	9	2	3	6
SNEB-001009	10,000	4.23	1	12	2	4	9
SNEB-114008	15,200	6.50	1 1/4	11 3/4	2 1/2	4	8
SNEB-114012	15,200	7.95	1 1/4	15 3/4	2 1/2	4	12
SNEB-112015	21,400	14.25	1 1/2	19 1/2	3	6	15

Safety Factor 5:1

Shoulder Type Machinery Eye Bolts (self-colored, drop-forged, carbon steel quenched and tempered)

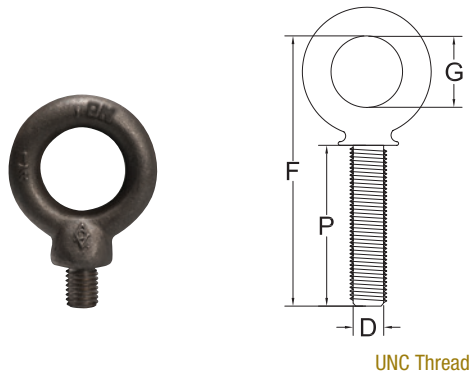

Code	Working Load Limit lbs.	Weight / ea. lbs.	Dimensions in.			
			D	F	G	P
STEB-014001SC	500	0.05	1/4	2 1/8	3/4	1
STEB-516118SC	900	0.10	5/16	2 1/2	7/8	1 1/8
STEB-038114SC	1,300	0.16	3/8	2 15/16	1	1 1/4
STEB-012112SC	2,400	0.35	1/2	3 1/4	1 1/8	1 1/2
STEB-058134SC	4,000	0.67	5/8	4 1/8	1 1/4	1 3/4
STEB-034002SC	5,000	1.00	3/4	4 3/8	1 1/2	2
STEB-078214SC	7,000	1.63	7/8	5 1/8	1 3/4	2 1/4
STEB-001212SC	9,000	2.22	1	5 7/8	2	2 1/2
STEB-114003SC	15,000	4.44	1 1/4	6 7/8	2 1/2	3
STEB-112312SC	21,000	7.36	1 1/2	9 1/8	3	3 1/2

Safety Factor 5:1

Shoulder Type Machinery Eye Bolts (zinc plated drop-forged, carbon steel quenched and tempered)

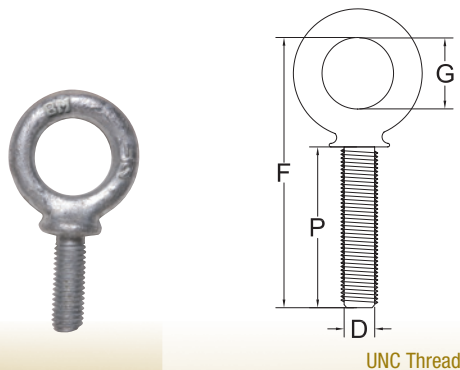

Code	Working Load Limit lbs.	Weight / ea. lbs.	Dimensions in.			
			D	F	G	P
STEB-014001	500	0.05	1/4	2 1/8	3/4	1
STEB-516118	900	0.10	5/16	2 1/2	7/8	1 1/8
STEB-038114	1,300	0.16	3/8	2 15/16	1	1 1/4
STEB-012112	2,400	0.35	1/2	3 1/4	1 1/8	1 1/2
STEB-058134	4,000	0.67	5/8	4 1/8	1 1/4	1 3/4
STEB-034002	5,000	1.00	3/4	4 3/8	1 1/2	2
STEB-078214	7,000	1.63	7/8	5 1/8	1 3/4	2 1/4
STEB-001212	9,000	2.22	1	5 7/8	2	2 1/2
STEB-114003	15,000	4.44	1 1/4	6 7/8	2 1/2	3
STEB-112312	21,000	7.36	1 1/2	9 1/8	3	3 1/2

Safety Factor 5:1



Regular Nut Eye Bolts (hot dip galvanized, drop-forged, carbon steel quenched and tempered)

Code	Working Load Limit lbs.	Weight / ea. lbs.	Dimensions in.				
			D	F	G	P	Q
RNEB-014002	500	0.08	1/4	2 3/4	1/2	1 1/2	2
RNEB-014004	500	0.12	1/4	4 3/4	1/2	2 1/2	4
RNEB-516214	800	0.13	5/16	3 1/4	5/8	1 1/2	2 1/4
RNEB-516414	800	0.25	5/16	5 1/4	5/8	2 1/2	4 1/4
RNEB-038212	1,200	0.24	3/8	3 3/4	3/4	1 1/2	2 1/2
RNEB-038412	1,200	0.29	3/8	5 3/4	3/4	2 1/2	4 1/2
RNEB-038006	1,200	0.35	3/8	7 1/4	3/4	2 1/2	6
RNEB-012314	2,200	0.50	1/2	4 7/8	1	1 1/2	3 1/4
RNEB-012006	2,200	0.66	1/2	7 5/8	1	3	6
RNEB-012008	2,200	0.82	1/2	9 5/8	1	3	8
RNEB-012010	2,200	0.88	1/2	11 5/8	1	3	10
RNEB-012012	2,200	1.15	1/2	13 5/8	1	3	12
RNEB-058004	3,500	1.03	5/8	6	1 1/4	2	4
RNEB-058006	3,500	1.20	5/8	8	1 1/4	3	6
RNEB-058008	3,500	1.35	5/8	10	1 1/4	3	8
RNEB-058010	3,500	1.53	5/8	12	1 1/4	3	10
RNEB-058012	3,500	1.67	5/8	14	1 1/4	4	12
RNEB-034412	5,200	1.68	3/4	7	1 1/2	2	4 1/2
RNEB-034006	5,200	1.85	3/4	8 1/2	1 1/2	3	6
RNEB-034008	5,200	2.08	3/4	10 1/2	1 1/2	3	8
RNEB-034010	5,200	2.37	3/4	12 1/2	1 1/2	3	10
RNEB-034012	5,200	2.58	3/4	14 1/2	1 1/2	4	12
RNEB-034015	5,200	3.00	3/4	17 1/2	1 1/2	5	15
RNEB-078005	7,200	2.70	7/8	7 7/8	1 3/4	2 1/2	5
RNEB-078008	7,200	3.10	7/8	10 7/8	1 3/4	4	8
RNEB-078012	7,200	4.00	7/8	14 7/8	1 3/4	4	12
RNEB-001006	10,000	4.25	1	9 1/4	2	3	6
RNEB-001009	10,000	4.70	1	12 1/4	2	4	9
RNEB-001012	10,000	5.40	1	15 1/4	2	4	12
RNEB-001018	10,000	6.50	1	21 1/4	2	7	18
RNEB-114008	15,200	7.50	1 1/4	12 1/8	2 1/2	4	8
RNEB-114012	15,200	9.00	1 1/4	16 1/8	2 1/2	4	12
RNEB-114020	15,200	12.1	1 1/4	24 1/8	2 1/2	6	20

Safety Factor 5:1

UNC Thread

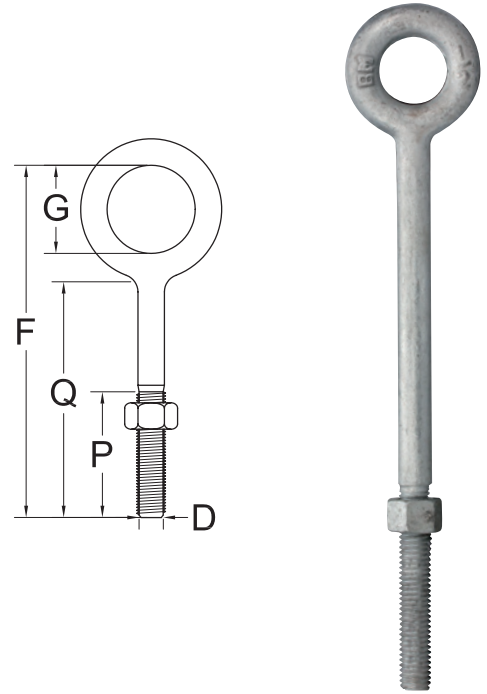

Eye Nuts (hot dip galvanized, drop-forged, forged carbon steel, quenched and tempered)

Code	Tap Size in.	Working Load Limit lbs.	Weight / ea. lbs.	Dimensions in.			
				A	B	D	E
EN-014	1/4 - 20	520	0.09	0.690	0.750	0.250	1.690
EN-516	5/16 - 18	700	0.11	0.690	0.750	0.250	1.690
EN-038	3/8 - 16	1,250	0.18	1.250	1.000	0.312	2.062
EN-012	1/2 - 13	2,250	0.28	1.500	1.250	0.375	2.500
EN-058	5/8 - 11	3,600	0.58	2.000	1.500	0.500	3.187
EN-034	3/4 - 10	5,200	1.00	2.375	1.750	0.625	3.875
EN-078	7/8 - 9	7,200	1.70	2.625	2.000	0.750	4.312
EN-001	1	10,000	2.75	3.065	2.155	0.910	5.050
EN-114	1 1/4	15,500	3.87	3.501	2.420	1.042	5.710
EN-112	1 1/2	22,500	6.78	4.31	3.12	1.25	7.06

Safety Factor 5:1

Also available in stainless steel. Other dimensions available upon request.

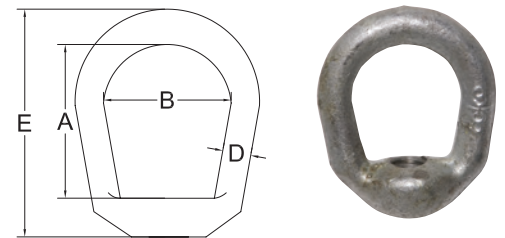

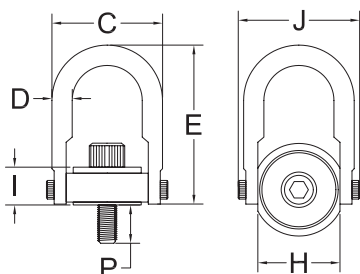

UNC Swivel Hoist Rings

Code	Working Load lbs.	Thread	Dimensions (in.)							Torque ft./lbs.	Weight lbs.
			C	D	E	H	I	J	P		
SHR-516932	800	5/16-18	1 5/8	3/8	2 5/8	1	45/64	1 27/32	9/32	7	0.3
SHR-5161732	800	5/16-18	1 5/8	3/8	2 5/8	1	45/64	1 27/32	17/32	7	0.3
SHR-0381732	1,000	3/8-16	1 5/8	3/8	2 5/8	1	45/64	1 27/32	17/32	12	0.3
SHR-0121116	2,500	1/2-13	2 7/16	1/2	3 3/4	1 13/32	56/64	2 9/16	1 1/16	26	1.0
SHR-012034	2,500	1/2-13	3 1/4	3/4	4 3/4	2	1 7/32	3 1/2	3/4	26	2.6
SHR-012001	2,500	1/2-13	3 1/4	3/4	4 3/4	2	1 7/32	3 1/2	1	28	2.6
SHR-012114	2,500	1/2-13	3 1/4	3/4	4 3/4	2	1 7/32	3 1/2	1 1/4	28	2.6
SHR-058034	4,000	5/8-11	3 1/4	3/4	4 3/4	2	1 7/32	3 1/2	3/4	60	2.6
SHR-058001	4,000	5/8-11	3 1/4	3/4	4 3/4	2	1 7/32	3 1/2	1	60	2.6
SHR-058114	4,000	5/8-11	3 1/4	3/4	4 3/4	2	1 7/32	3 1/2	1 1/4	60	2.6
SHR-034001A	5,000	3/4-10	3 1/4	3/4	4 3/4	2	1 7/32	3 1/2	1	100	3.0
SHR-034112A	5,000	3/4-10	3 1/4	3/4	4 3/4	2	1 7/32	3 1/2	1 1/2	100	3.0
SHR-034001B	7,000	3/4-10	4 13/16	1	6 1/2	3	1 11/16	5 9/16	1	100	7.0
SHR-034112B	7,000	3/4-10	4 13/16	1	6 1/2	3	1 11/16	5 9/16	1 1/2	100	7.0
SHR-078001	8,000	7/8-9	4 13/16	1	6 1/2	3	1 11/16	5 9/16	1	160	7.0
SHR-001114	10,000	1-8	4 13/16	1	6 1/2	3	1 11/16	5 9/16	1 1/4	230	7.5
SHR-001112	10,000	1-8	4 13/16	1	6 1/2	3	1 11/16	5 9/16	1 1/2	230	7.5
SHR-001214	10,000	1-8	4 13/16	1	6 1/2	3	1 11/16	5 9/16	2 1/4	230	7.5
SHR-114002	15,000	1 1/4-7	5	1 1/4	8 3/4	3 3/4	2 7/64	6 1/2	2	470	14.0
SHR-112234	24,000	1 1/2-6	8	1 3/4	12 15/32	4 7/8	2 13/16	8 35/64	2 3/4	800	34.0
SHR-002003	30,000	2-4	8	1 3/4	12 15/32	4 7/8	2 13/16	8 35/64	3	800	36.0
SHR-212004	50,000	2 1/2-4	10 1/2	2 1/4	18 7/8	6 1/2	4 3/32	11 43/64	4	2,100	88.0
SHR-003514	75,000	3-4	13	2 3/4	19 1/2	8 7/64	5 17/64	14 5/32	5 1/4	4,300	166.0
SHR-312007	100,000	3 1/2-4	14	3 1/4	22 3/32	8 7/64	6 1/16	15 29/32	7	5,100	265.0

Safety Factor 6:1

Metric Swivel Hoist Rings

Code	Working Load kg	Thread	Dimensions (mm)							Torque kg-m	Weight kg
			C	D	E	H	I	J	P		
SHR-M08013	400	M8x1.25	41	10	68	25	18	47	13	0.88	0,17
SHR-M10018	500	M10x1.50	41	10	68	25	18	47	18	1.5	0,17
SHR-M12019	1,050	M12x1.75	83	19	121	51	30	89	19	3.7	1,06
SHR-M16029	1,900	M16x2.00	83	19	121	51	30	89	29	8.4	1,12
SHR-M20034	2,150	M20x2.50	83	19	121	51	30	89	34	14	1,19
SHR-M20032	3,000	M20x2.50	122	25	166	76	43	131	32	14	3,03
SHR-M24037	4,200	M24x3.00	122	25	166	76	43	131	37	31	3,10
SHR-M30042	7,000	M30x3.50	152	32	222	95	54	165	42	60	5,30
SHR-M30062	7,000	M30x3.50	152	32	222	95	54	165	62	60	6,40
SHR-M36064	11,000	M36x4.00	203	44	317	124	71	217	64	100	16,60
SHR-M42082	12,500	M42x4.50	203	44	317	124	71	217	82	100	16,80
SHR-M48082	13,500	M48x5.00	203	44	317	124	71	217	82	100	16,80
SHR-M64101	22,300	M64x6.00	266	57	428	165	103	296	101	273	39,0
SHR-M72132	31,500	M72x6.00	330	70	495	206	133	359	132	559	74,0
SHR-M90177	44,500	M90x6.00	368	83	561	218	153	404	177	663	118,0

Safety Factor 6:1



Eye Hooks with latch* (alloy, zinc plated, forged alloy steel, quenched and tempered)

Code	Working Load Limit TON	Weight / ea. lbs.	Dimensions in.				
			C	D	F	G	H
EH-034	3/4	0.54	2.54	.33	2.80	.63	.81
EH-001	1	0.61	2.83	.36	3.34	.75	.89
EH-112	1 1/2	0.89	3.11	.42	3.81	.91	.91
EH-002	2	1.44	3.53	.55	4.14	1.13	1.00
EH-003	3	2.07	3.97	.58	4.69	1.25	1.09
EH-412	4 1/2	4.30	4.81	.72	5.77	1.56	1.36
EH-007	7	8.30	6.27	.90	7.37	2.00	1.61
EH-011	11	15.00	7.45	1.11	9.07	2.44	2.08
EH-015	15	21.60	8.30	1.27	10.08	2.84	2.27

Safety Factor 5:1

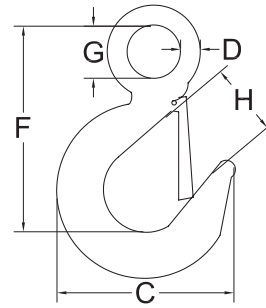

* Lock nut with Nylon insert nut

Eye Hooks with latch* (carbon, zinc plated, Forged carbon steel, quenched and tempered)

Code	Working Load Limit TON	Weight / ea. lbs.	Dimensions in.				
			C	D	F	G	H
EH-034C	3/4	.61	2.83	.36	3.34	.75	.89
EH-001C	1	.89	3.11	.42	3.81	.91	.91
EH-112C	1 1/2	1.44	3.53	.55	4.14	1.13	1.00
EH-002C	2	2.07	3.97	.58	4.69	1.25	1.09
EH-003C	3	4.30	4.81	.72	5.77	1.56	1.36
EH-005C	5	8.30	6.27	.90	7.37	2.00	1.61
EH-007C	7	15.00	7.45	1.11	9.07	2.44	2.08
EH-010C	10	20.77	8.30	1.27	10.08	2.84	2.27
EH-015C	15	39.50	10.30	1.56	12.53	3.50	3.02

Safety Factor 5:1

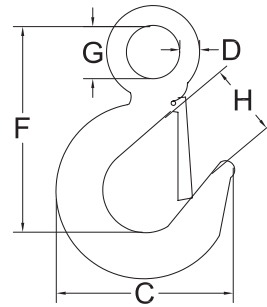

* Lock nut with Nylon insert nut

Swivel Hooks with latch* (alloy, zinc plated, Forged alloy steel, quenched and tempered)

Code	Working Load Limit TON	Weight / ea. lbs.	Dimensions in.				
			B	C	D	F	H
SH-001	1	0.75	1.25	2.86	.38	4.55	.89
SH-112	1 1/2	1.25	1.50	3.15	.50	5.37	.91
SH-002	2	2.25	1.75	3.59	.63	6.12	1.00
SH-003	3	2.30	1.75	4.00	.63	6.50	1.09
SH-412	4 1/2	4.96	2.00	4.84	.75	7.50	1.36
SH-007	7	10.29	2.50	6.28	1.00	9.63	1.61
SH-011	11	16.18	2.75	7.54	1.13	11.37	2.08
SH-015	15	23.25	3.12	8.34	1.25	12.25	2.27

Safety Factor 5:1

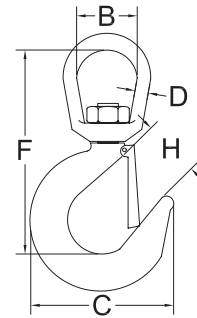

* Lock nut with Nylon insert nut

Swivel Hooks with latch* (carbon, zinc plated, Forged carbon steel, quenched and tempered)

Code	Working Load Limit TON	Weight / ea. lbs.	Dimensions in.				
			B	C	D	F	H
SH-034C	3/4	.75	1.25	2.86	.38	4.55	.89
SH-001C	1	1.25	1.50	3.15	.50	5.37	.91
SH-112C	1 1/2	2.25	1.75	3.59	.63	6.12	1.00
SH-002C	2	2.30	1.75	4.00	.63	6.50	1.09
SH-003C	3	4.96	2.00	4.84	.75	7.50	1.36
SH-005C	5	10.29	2.50	6.28	1.00	9.63	1.61

Safety Factor 5:1

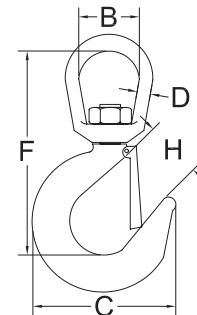

* Lock nut with Nylon insert nut

Safety Latch Kits (stainless steel)

Code	For Hooks With Capacity Carbon & Alloy TON	Weight / ea. lbs.
SS4055-012	1/2 & 3/4	0.01
SS4055-034	3/4 & 1	0.02
SS4055-001	1 & 1 1/2	0.02
SS4055-112	1 1/2 & 2	0.03
SS4055-002	2 & 3	0.03

Code	For Hooks With Capacity Carbon & Alloy TON	Weight / ea. lbs.
SS4055-003	3 & 4 1/2	0.06
SS4055-005	5 & 7	0.11
SS4055-712	7 1/2 & 11	0.17
SS4055-010	10 & 15	0.17



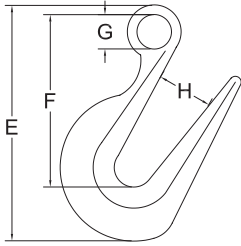

Sorting Hooks (alloy steel quenched and tempered)

Code	Working Load Limit at bottom TON	Working Load Limit at tip of hook TON	Style	Weight / ea. lbs.	Dimensions in.			
					E	F	G	H
A378-002	7 1/2	2	No handle	6.42	9.69	7.375	1.38	2.81

Safety Factor 4:1

Eye Slip Tow and Lanyard Hooks (zinc plated steel)

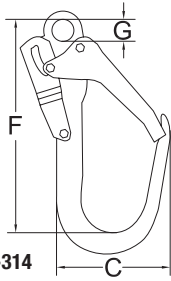

N-314



BM-5315

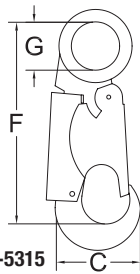

Code	Inside Eye Dia. in.	Throat opening in.	Working Load Limit lbs.	Weight / ea. lbs.	Dimensions in.		
					C	F	G
BM-BC53	3/4	1/2	800	0.33	1.771	2.553	0.75
BM-5555	3/4	5/8	1,500	0.45	2.172	2.827	0.75
BM-5315	1	5/8	1,000	0.61	2.321	4.435	1.00
N-314	3/4	2	1,000	1.1	4.45	7.60	0.78

Safety Factor 5:1



BM-5555

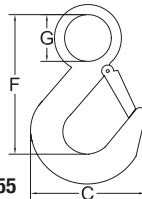

BM-BC53

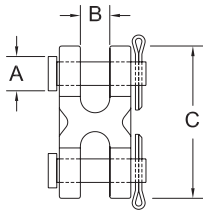
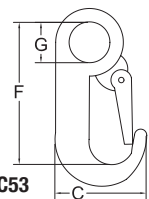

Double Clevis Chain Midlink (Gr. 70 gold chromate, body carbon steel heat treated, pin alloy)

Code	For Chain Dia. in.	Working Load Limit lbs.	Weight / ea. lbs.	Dimensions in.			QTY CTN
				A	B	C	
70991B	5/16	4,700	0.32	3/8	7/16	2.50	6
70992B	3/8	6,600	0.44	7/16	1/2	2.81	6
70993B	1/2	11,250	1.00	9/16	5/8	3.62	6

Safety Factor 4:1

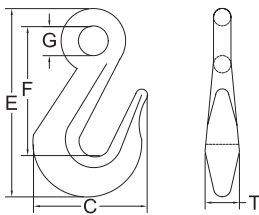

Eye Grab Hooks (Gr. 40 zinc plated, forged steel quenched and tempered)

Code	For Chain Dia. in.	Working Load Limit lbs.	Weight / ea. lbs.	Dimensions in.				
				C	E	F	G	T
EGH40-014	1/4	2,600	0.28	1.81	3.05	1.88	.53	.47
EGH40-516	5/16	3,900	0.45	2.12	3.59	2.28	.62	.59
EGH40-038	3/8	5,400	0.79	2.53	4.28	2.69	.75	.72

Safety Factor 4:1

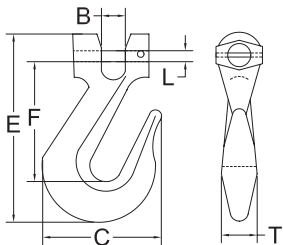

Clevis Grab Hooks (Gr. 40, zinc plated, forged steel quenched and tempered)

Code	For Chain Dia. in.	Working Load Limit lbs.	Weight / ea. lbs.	Dimensions in.					
				B	C	E	F	L	T
CGH40-014	1/4	2,600	0.38	.32	1.81	3.05	1.64	.31	.47
CGH40-516	5/16	3,900	0.70	.43	2.12	3.66	2.02	.38	.59
CGH40-038	3/8	5,400	1.04	.48	2.53	4.42	2.41	.44	.72
CGH40-716	7/16	7,200	1.31	.66	3.09	4.94	2.75	.56	.69
CGH40-012	1/2	9,200	2.06	.57	3.56	5.72	3.19	.63	.78

Safety Factor 4:1

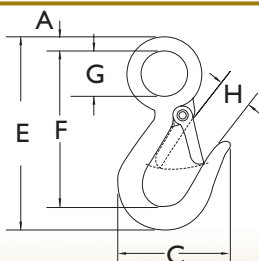

Snap Hooks (zinc plated)

Code	For Chain Dia. in.	Working Load Limit lbs.	Weight / ea. lbs.	Dimensions in.					
				A	C	E	F	G	H
G3315-716	7/16	750	0.23	.25	2.25	3.94	3.25	.75	.75
G3315-916	9/16	1,000	0.48	.34	2.69	4.75	3.84	1.12	.81

Safety Factor 4:1



Eye Slip Hooks (Gr. 40 zinc plated, forged steel quenched and tempered)

Code	For Chain Dia. in.	Working Load Limit lbs.	Weight / ea. lbs.	Dimensions in.				
				C	F	G	H	T
ESH40-014	1/4	1,950	0.40	2.75	2.56	.50	.94	.50
ESH40-516	5/16	2,875	0.70	3.06	2.95	.63	1.06	.56
ESH40-038	3/8	4,000	1.00	3.63	3.36	.72	1.31	.66
ESH40-012	1/2	6,900	2.00	4.81	4.28	.94	1.69	.91

Safety Factor 4:1

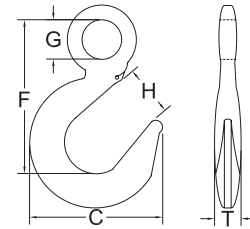

Clevis Slip Hooks (Gr. 40, zinc plated, forged steel quenched and tempered)

Code	For Chain Dia. in.	Working Load Limit lbs.	Weight / ea. lbs.	Dimensions in.						
				B	C	E	F	H	L	T
CSH40-014	1/4	1,950	0.50	.32	2.75	3.95	2.58	.94	.38	.50
CSH40-516	5/16	2,875	0.75	.43	3.06	4.52	2.87	1.06	.44	.56
CSH40-038	3/8	4,000	1.13	.45	3.63	5.15	3.25	1.31	.47	.66
CSH40-716	7/16	5,000	2.06	.59	4.34	5.97	3.70	1.56	.56	.81
CSH40-012	1/2	6,900	2.75	.57	4.81	6.53	4.00	1.69	.63	.91

Safety Factor 4:1

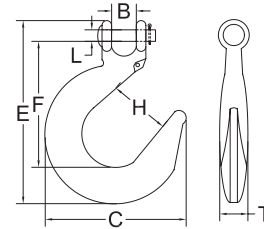

Clevis Slip Hooks (Gr. 70, gold chromate, forged alloy steel quenched and tempered)

Code without latch	Code with latch	For Chain Dia. in.	Working Load Limit lbs.	Weight / ea. lbs.	Dimensions in.						
					B	C	E	F	H	L	T
CSH70-014	CSH70L-014	1/4	2,750	0.50	.32	2.75	3.95	2.58	.94	.38	.50
CSH70-516	CSH70L-516	5/16	4,300	0.75	.43	3.06	4.52	2.87	1.06	.44	.56
CSH70-038	CSH70L-038	3/8	5,250	1.13	.45	3.63	5.15	3.25	1.31	.47	.66
CSH70-012	CSH70L-012	1/2	9,000	2.75	.57	4.81	6.53	4.00	1.69	.63	.91

Safety Factor 4:1

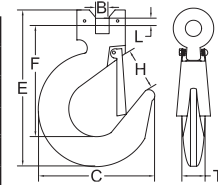

Safety Latch kit (Gr. 70, for clevis slip hook)

Code	For Chain Diameter in.	Weight / ea. lbs.
LATCHGR701/4BM	1/4	0.01
LATCHGR705/16BM	5/16	0.02
LATCHGR703/8BM	3/8	0.02
LATCHGR707/16BM	7/16	0.39
LATCHGR701/2BM	1/2	0.39

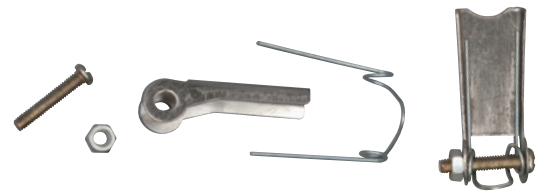

Clevis Grab Hooks (Gr. 70, gold chromate, forged alloy steel quenched and tempered)

Code	For Chain Diameter in.	Working Load Limit lbs.	Weight / ea. lbs.	Dimensions in.						
				B	C	E	F	H	L	T
CGH70-014	1/4	3,150	0.38	.32	1.81	3.05	1.64	.34	.31	.47
CGH70-516	5/16	4,700	0.70	.43	2.12	3.66	2.02	.44	.38	.59
CGH70-038	3/8	6,600	1.04	.48	2.53	4.42	2.41	.50	.44	.72
CGH70-012	1/2	11,300	2.06	.57	3.56	5.72	3.19	.66	.63	.78

Safety Factor 4:1

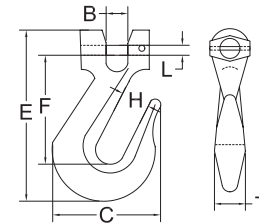

Clevis Grab Hooks with latch (Gr. 70, gold chromate, forged alloy steel quenched and tempered)

Code	For Chain Diameter in.	Working Load Limit lbs.	Weight / ea. lbs.	Dimensions in.				
				B	F	H	I	L
CGH70L-014	1/4	3,150	0.64	0.354	1.970	0.394	0.394	0.378
CGH70L-516	5/16	4,700	0.96	0.394	2.260	0.433	0.492	0.433
CGH70L-038	3/8	6,600	1.34	0.472	2.630	0.500	0.413	0.472
CGH70L-012	1/2	11,300	2.75	0.752	3.189	0.661	0.701	0.630

Safety Factor 4:1

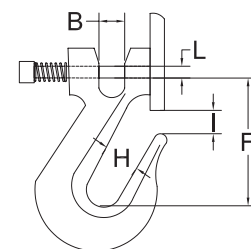



Snatch Block with Alloy Swivel Hook (forged steel)



Code	For Cable Diameter in.	Pulley Diameter in.	Working Load Limit TON	Weight ea. lbs.
K4180-002	3/8	3	2	2
K4180-004	1/2	4 1/2	4	12
K4180-008A	3/4	6	8	27
K4180-008B	3/4	8	8	35
K4180-008C	3/4	10	8	50
K4180-015	7/8	8	15	58
K4180-020	1 1/8	8	20	103

Safety Factor 4:1

Snatch Block with Shackle (forged steel)



Code	For Cable Diameter in.	Pulley Diameter in.	Working Load Limit TON	Weight ea. lbs.
K4190-002	3/8	3	2	2
K4190-004	1/2	4 1/2	4	10
K4190-008A	3/4	6	8	31
K4190-008B	3/4	8	8	36
K4190-008C	3/4	10	8	53
K4190-008D	3/4	14	8	81
K4190-015	7/8	8	15	64
K4190-020	1 1/8	8	20	117

Safety Factor 4:1

Toggle Block (Tail Board) (forged steel)



Code	For Cable Diameter in.	Pulley Diameter in.	Working Load Limit TON	Weight ea. lbs.
K4040-002	3/8	3	2	2
K4040-004	1/2	4 1/2	4	7.5
K4040-008A	3/4	6	8	15
K4040-008B	3/4	8	8	25
K4040-015	7/8	8	15	35
K4040-020	1 1/8	8	20	70

Safety Factor 4:1

Open Swage Sockets (forged steel)

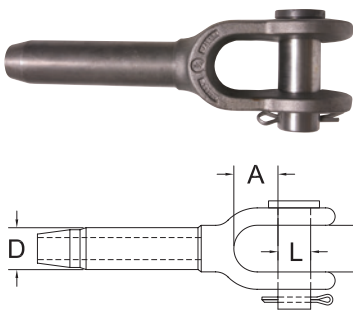

Code	For Cable Diameter in.	Weight ea. lbs.	Dimensions in.				
			A	B	D Before swage	D After swage	L
S501-014	1/4	0.57	1.156	1 1/16	.495	.438	.688
S501-516	5/16	1.24	1.344	13/16	.770	.688	.812
S501-038	3/8	.120	1.344	13/16	.770	.688	.812
S501-716	7/16	2.45	1.500	1	.982	.875	1.00
S501-012	1/2	2.40	1.500	1	.982	.875	1.00
S501-916	9/16	4.80	1.655	1 1/4	1.26	1.13	1.19
S501-058	5/8	4.50	1.655	1 1/4	1.26	1.13	1.19
S501-034	3/4	7.80	2.150	1 1/2	1.55	1.38	1.38
S501-078	7/8	11.80	2.435	1 3/4	1.70	1.50	1.63
S501-001	1	17.80	2.750	2	1.98	1.75	2.00
S501-118	1 1/8	28.90	3.125	2 1/4	2.25	2.00	2.25
S501-114	1 1/4	36.20	3.500	2 1/2	2.53	2.25	2.50
S501-138	1 3/8	47.70	4.00	2 1/2	2.80	2.50	2.50
S501-112	1 1/2	64.40	4.375	3	3.08	2.75	2.75



Closed Swage Sockets (forged steel)

Code	For Cable Diameter in.	Weight ea. lbs.	Dimensions in.				
			C	D Before swage	D After swage	G	T
S502-014	1/4	0.35	1 7/16	.495	.438	.750	1/2
S502-516	5/16	0.77	1 11/16	.770	.688	.875	11/16
S502-038	3/8	0.73	1 11/16	.770	.688	.875	11/16
S502-716	7/16	1.47	2	.982	.875	1.06	7/8
S502-012	1/2	1.38	2	.982	.982	1.06	7/8
S502-916	9/16	2.90	2 1/2	1.26	1.13	1.25	1 1/8
S502-058	5/8	2.80	2 1/2	1.26	1.13	1.25	1 1/8
S502-034	3/4	5.16	3	1.55	1.38	1.44	1 5/16
S502-078	7/8	7.40	3 1/2	1.70	1.50	1.69	1 1/2
S502-001	1	11.20	4	1.98	1.75	2.06	1 3/4
S502-118	1 1/8	16.00	4 1/2	2.25	2.00	2.31	2
S502-114	1 1/4	22.70	5	2.53	2.25	2.56	2 1/4
S502-138	1 3/8	29.00	5 1/4	2.80	2.50	2.56	2 1/4
S502-112	1 1/2	37.50	5 1/2	3.08	2.75	2.81	2 1/2

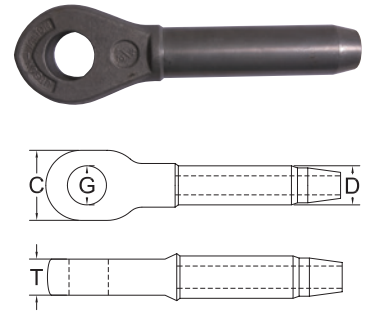

Open Spelter Sockets (forged steel, hot dip galvanized)

Code	For Cable Diameter in.	(G416 - G417) Wirelock Req. cm ³	Weight ea. lbs.	Dimensions in.		
				A	B	L
G416-014	1/4	9	0.90	1.219	11/16	11/16
G416-516	5/16	17	1.30	1.344	13/16	13/16
G416-038	3/8	17	1.30	1.344	13/16	13/16
G416-716	7/16	35	2.30	1.000	1	1
G416-012	1/2	35	2.30	1.000	1	1
G416-916	9/16	52	3.90	1.313	1 1/4	1 3/16
G416-058	5/8	52	3.90	1.313	1 1/4	1 3/16
G416-034	3/4	86	6.00	1.625	1 1/2	1 3/8
G416-078	7/8	125	10.00	1.875	1 3/4	1 5/8
G416-001	1	160	15.50	2.000	2	2
G416-118	1 1/8	210	24.00	2.250	2 1/4	2 1/4
G416-114	1 1/4	350	32.00	2.250	2 1/2	2 1/2
G416-138	1 3/8	350	32.00	2.250	2 1/2	2 1/2
G416-112	1 1/2	420	46.00	3.625	3	2 3/4

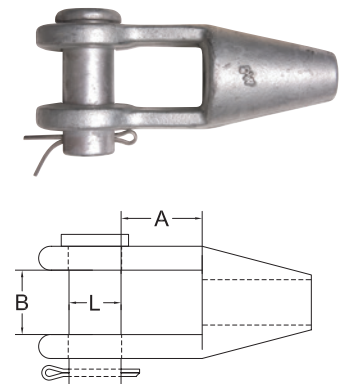

Closed Spelter Sockets (forged steel, hot dip galvanized)

Code	For Cable Diameter in.	(G416 - G417) Wirelock Req. cm ³	Weight ea. lbs.	Dimensions in.			
				A	B	C	T
G417-014	1/4	9	0.50	2	1 7/16	0.438	0.50
G417-516	5/16	17	1.00	2	1 11/16	0.563	0.69
G417-038	3/8	17	1.00	2	1 11/16	0.563	0.69
G417-716	7/16	35	1.80	2 1/2	2	0.689	0.88
G417-012	1/2	35	1.80	2 1/2	2	0.689	0.88
G417-916	9/16	52	3.40	3	2 5/8	0.813	1.00
G417-058	5/8	52	3.40	3	2 5/8	0.813	1.00
G417-034	3/4	86	5.10	3 1/2	3	1.063	1.25
G417-078	7/8	125	7.80	4	3 5/8	1.313	1.50
G417-001	1	160	12.00	4 1/2	4 1/8	1.438	1.75
G417-118	1 1/8	210	16.00	5	4 1/2	1.563	2.00
G417-114	1 1/4	350	23.00	5 1/2	5	1.689	2.25
G417-138	1 3/8	350	23.00	5 1/2	5	1.689	2.25
G417-112	1 1/2	420	28.00	6	5 3/8	2.00	2.50

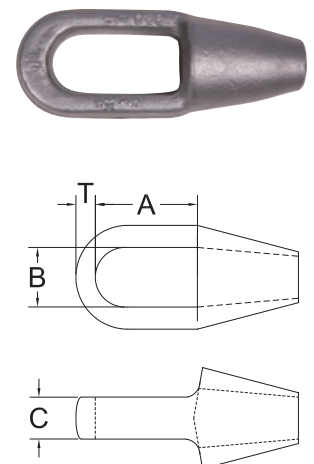



Ben-Mor Single Shank Balls

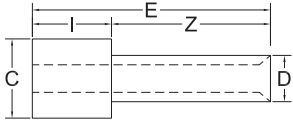

Code	For Cable Diameter in.	Minimum Breaking Strength lbs.	Material	C	D	E	I	Z
BM20664C3	3/32	500	Zinc	.285	.187	.650	.168	.477
BM20664C4	1/8	800	Zinc	.370	.312	1.004	.266	.735
BM20664C4I	1/8	1,200	Zinc	.400	.269	.700	.208	.483
BM20664C4BAT	1/8	2,000	Zinc plated steel	.375	.252	1.383	.256	1.114
BM20664C6	3/16	3,500	Zinc plated steel	.437	.313	1.444	.997	.435

Plain balls and double shank balls (military specs.) available upon request.

Eye Bolts shoulder-drilled (zinc plated, drop-forged)

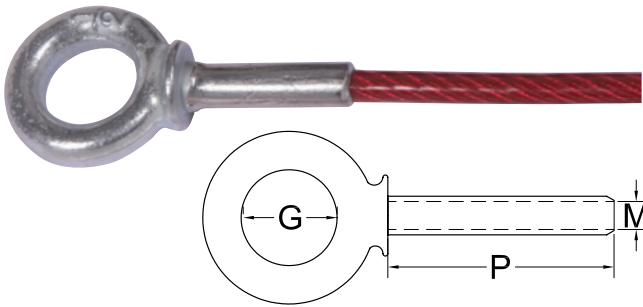

Code	For Cable Diameter in.	Working Load Limit lbs.	Weight / ea. lbs.			
				G	M	P
BM-55830	1/4	1200	0.35	1	.275	1.7

Safety Factor 5:1

Other dimensions available upon request
See Shoulder Type Machinery Eye Bolt for dimensions (page 36)

Ben-Mor Threaded Studs (steel)

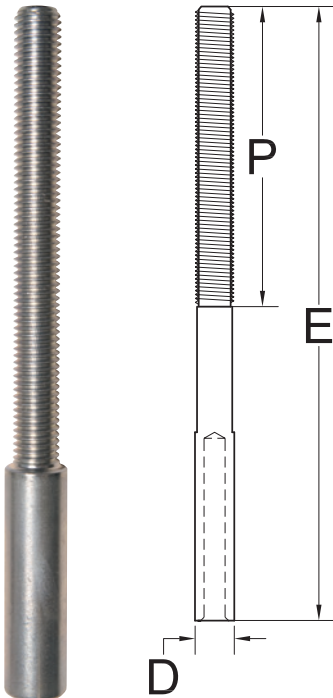

Code	For Cable Diameter in.	Threads size UNC	Dimensions in.			Finish
			D Before swage	E	P	
BM21259-014F	3/32	1/4 - 20	1/4	2 9/16	1 1/2	ZP
BM21259-014B	1/8	1/4 - 20	1/4	2 1/2	1/2	ZP
BM21259-014C	1/8	1/4 - 20	1/4	2 9/16	1 1/2	ZP
BM21259-014E	1/8	1/4 - 20	1/4	3 3/4	1 1/2	ZP
BM21259-516A	1/8	5/16 - 18	5/16	2 3/4	1 3/4	ZP
BM21259-516B	1/8	5/16 - 18	5/16	4 1/2	3	ZP
BM21259-038A	1/8	3/8 - 16	3/8	3	1 1/2	ZP
BM21259-038B	3/16	3/8 - 16	1/2	3	1 1/2	ZP
BM21259-012A	1/4	1/2 - 13	5/8	4 1/2	2 1/2	ZP
BM21259-058A	5/16	5/8 - 11	3/4	6 1/2	3 1/2	ZP
BM21259-058B	5/16	5/8 - 11	3/4	8	5	ZP
BM21259-058C	3/8	5/8 - 11	7/8	9	6	ZP
BM21259-034A	3/8	3/4 - 10	3/4	8	5	ZP
BM21259-014L	1/8	1/4 - 28	0.250	1.36	3/8	SS
BM21259-038C	1/4	3/8 - 16	0.500	8	5	SS
BM21259-012AB	1/4	1/2 - 13	0.625	6	4	SS
BM21259-012AK	3/8	1/2 - 13	0.700	5.775	1	ZP
BM21259-058AG	5/16	5/8 - 11	0.750	3 1/2	1	SS
BM21259-034X	3/8	3/4 - 10	0.750	13 5/8	5 1/4	Steel
BM21259-034Y	3/8	3/4 - 10	0.750	5 1/8	1 5/8	Steel

Available on request : Stainless steel, Left-Hand thread, metric thread, fine thread. Custom made for cables up to 1 1/2".
Other dimensions available upon request. Available in self colored or zinc plated.



Ben-Mor Strap Forks (steel)

Code	For Cable Diameter in.	Weight ea. lbs.	Dimensions in.		
			C	E	G
BM-6241	1/16	0.011	0.400	3/4	0.187

Available in self colored or zinc plated.

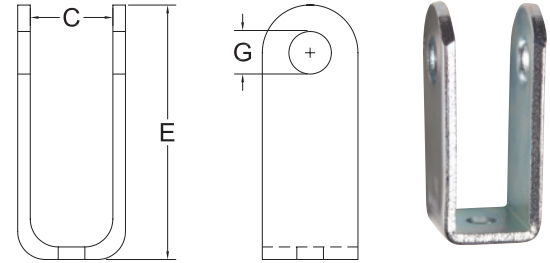

Ben-Mor Forks (steel)

Code	For Cable Diameter in.	Weight ea. lbs.	Dimensions in.				
			C	D Before swage	D After swage	E	G
BM100-058	3/16	0.2045	3/4	0.501	0.460	2 1/2	0.3125
BM100-031	3/8	0.549	1	0.842	0.775	4 1/2	0.4375
BM100-094	7/16	0.507	1	0.840	0.775	4 1/2	0.4375
BM100-026	3/8	1.069	1	0.840	0.775	7 1/2	0.500

Available in self colored or zinc plated. Custom made for cables up to 1 1/2". Other dimensions available upon request.

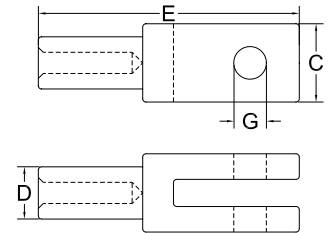

Ben-Mor Eye Ends (steel)

Code	For Cable Diameter in.	Weight ea. lbs.	Dimensions in.				
			C	D Before swage	D After swage	E	G
BM100-028	3/8	0.875	1	0.838	0.775	6 1/4	0.500

Available in self colored or zinc plated. Other dimensions available upon request.

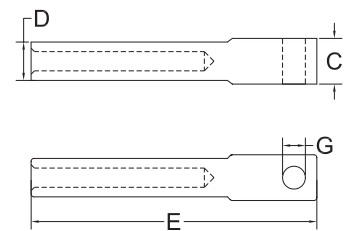

Heavy Duty Pulleys (steel)

Code	Size in.	Dimensions in.				Working Load Limit lbs.	Qty CTN
		E	F	H	L		
77091	5	4.920	6.615	0.750	2.640	700	6
77092	2 1/2	4.208	-	-	2.500	1,100	6

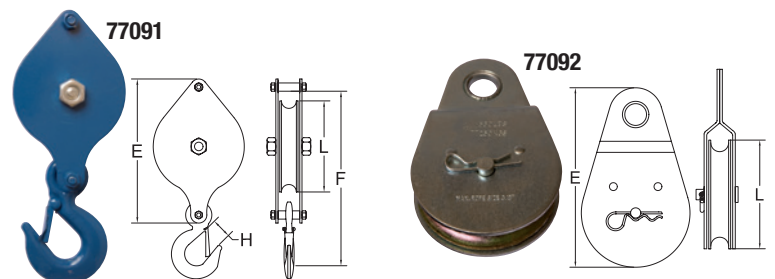

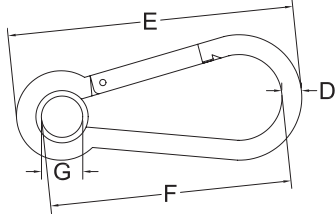

Carbine Snap Hooks with Eyelets (zinc plated, cold drawn mild steel)

Code	Working Load Limit lbs.	Weight / ea. lbs.	Dimensions in.				
			D		E	F	G
			in.	mm			
S8-1	100	0.04	3/16	5	1.97	1.586	0.197
S8-2	140	0.06	1/4	6	2.36	1.894	0.197
S8-3	240	0.15	5/16	8	3.15	2.449	0.315
S8-4	400	0.32	3/8	10	3.94	3.071	0.394
S8-5	560	0.60	1/2	12	5.51	4.470	0.512

Safety Factor 5:1

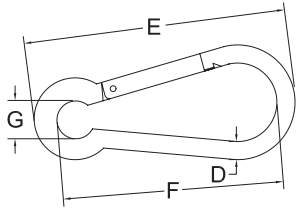

Carbine Snap Hooks (zinc plated, cold drawn mild steel)

Code	Working Load Limit lbs.	Weight / ea. lbs.	Dimensions in.				
			D		E	F	G
			in.	mm			
S10-1	100	0.04	3/16	5	1.97	1.614	0.197
S10-2	140	0.06	1/4	6	2.36	1.949	0.197
S10-3	240	0.15	5/16	8	3.15	2.545	0.315
S10-4	400	0.32	3/8	10	3.94	3.199	0.394
S10-4.5	485	0.42	7/16	11	4.72	3.960	0.433
S10-5	560	0.60	1/2	12	5.51	4.606	0.512

Safety Factor 5:1

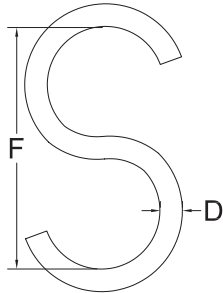

"S" Hooks (zinc plated, low carbon steel)

Code	Weight / ea. lbs.	Dimensions in.		
		F	D	
			in.	mm
SHZ-018	0.01	1.30	1/8	3
SHZ-532	0.02	1.50	5/32	4
SHZ-316	0.03	1.44	3/16	5
SHZ-014	0.07	1.75	1/4	6
SHZ-516	0.15	2.34	5/16	8
SHZ-038	0.27	3.20	3/8	10

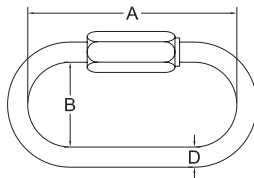
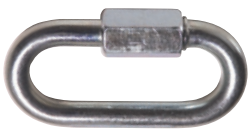

Quick Links Rated and Non-rated (zinc plated, cold drawn mild steel)

Code Rated	Code Non-rated	Working Load Limit lbs.	Weight / ea. lbs.	Dimensions in.			
				A	B	D	
						in.	mm
QLZ-018	70700	220	0.03	1.00	0.335	1/8	3
QLZ-532	70699	500	0.05	1.29	0.437	5/32	4
QLZ-316	70701	660	0.06	1.40	0.512	3/16	5
QLZ-014	70702	880	0.09	1.77	0.571	1/4	6
QLZ-516	70703	1,760	0.18	2.28	0.689	5/16	8
QLZ-038	70704	2,640	0.28	2.72	0.808	3/8	10
QLZ-716	70706	2,900	0.48	3.00	0.870	7/16	11
QLZ-012	70705	3,300	0.70	3.17	0.925	1/2	12
QLZ-058	70707	6,000	1.16	4.12	1.065	5/8	16

Safety Factor 2.5 : 1



Round Rings (nickel plated)

Code	Std Pack	Dimensions in.	
		A	D
71000	12	1	3/16
71001	12	1 1/4	3/16
71002	12	1 1/2	1/4
71003	12	2	1/4
71005	12	3/4	11/64
71011	12	3	1/2

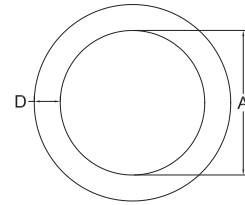

Malleable Swivel (zinc plated)

Code	For Cable Diameter in.	Working Load Limit lbs.	Weight / each lbs.	Dimensions in.			
				B1	B2	D	F
SW316112	3/16	N/D	0.044	.57	.31	.21	1 1/2
SW316134	3/16	N/D	0.044	.57	.31	.21	1 3/4
SW014214	1/4	400	0.11	.71	.43	.23	2 1/4
SW516234	5/16	N/D	0.086	1.00	.48	.32	2 3/4

Safety Factor 5:1

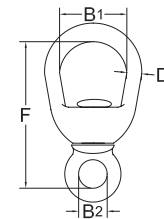

Zinc Swivel Eye Pulleys (single)

Code	Size in.	Std Pack	Dimensions in.		
			E	H	M
70720	1/2	6	1.775	.460	.225
70721	3/4	6	1.880	.460	.182
70722	1	6	2.340	.460	.295
70723	1 1/4	6	3.365	.810	.400
70724	1 1/2	6	3.480	.820	.384
77084	1 1/2	6	3.240	.377	.452
70725	2	6	4.220	.728	.383

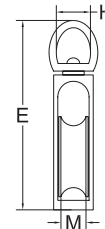

Zinc Swivel Eye Pulleys (double)

Code	Size in.	Std Pack	Dimensions in.		
			E	H	M
70731	3/4	6	1.89	.455	.194
70732	1	6	2.36	.445	.290
70734	1 1/2	6	3.50	.818	.405

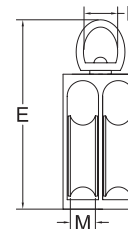

Zinc Fixed Eye Pulleys (double)

Code	Size in.	Std Pack	Dimensions in.		
			E	H	M
77083	1 1/2	6	3.00	.375	.400

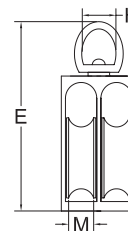

Black Nylon Fiber Sheave, Ball Bearing

Code	Cable Diameter in.	Capacity lbs.	Dimensions in.	
			E	H
BM998	3/16	400	3 1/2	3/8
BM999	3/16	250	4 1/2	3/8

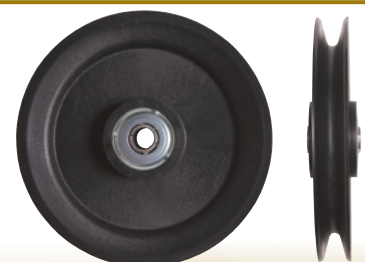
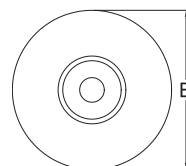



Stainless Steel Accessories

Single Sleeves (stainless steel 304)



Code	Rope Size in.	Weight ea. lbs.
BSS505-516	5/16	0.2
BSS505-038	3/8	0.2
BSS505-716	7/16	0.3
BSS505-012	1/2	0.3
BSS505-058	5/8	0.8
BSS505-034	3/4	1
BSS505-078	7/8	1.5
BSS505-001	1	2.2
BSS505-118	1 1/8	2.8
BSS505-114	1 1/4	2.5
BSS505-138	1 3/8	3.5
BSS505-112	1 1/2	3.8
BSS505-134	1 3/4	7
BSS505-002	2	8

Oval Sleeves (stainless steel 304)



Code	For Cable Diameter in.	Weight / each approx. lbs.
SSOS-132	1/32	.001
SSOS-364	3/64	.002
SSOS-116	1/16	.002
SSOS-332	3/32	.003
SSOS-018	1/8	.004
SSOS-532	5/32	.014
SSOS-316	3/16	.023
SSOS-732	7/32	.031
SSOS-014	1/4	.044
SSOS-516	5/16	.150
SSOS-038	3/8	.150

Federal Specification MS51844.

Other dimensions available upon request.

Oval Sleeves (stainless steel 304)



Code	For Cable Diameter in.	Weight / each approx. lbs.
SSOS-716	7/16	.350
SSOS-012	1/2	.320
SSOS-058	5/8	.600
SSOS-034	3/4	1.00
SSOS-078	7/8	1.50
SSOS-001	1	2.00

Other dimensions available upon request.

AN Thimbles (stainless steel 304)

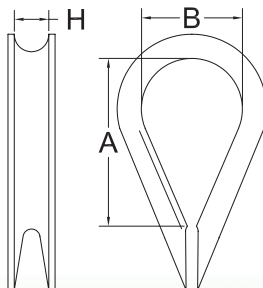

Code	For Cable Diameter in.	Weight / ea. approx. lbs.	Dimensions in.		
			A	B	H
ANTS4-116	3/64 - 1/16 - 5/64	.002	43/64	.350	3/32
ANTS4-018	3/32 - 7/64 - 1/8	.004	45/64	.350	9/64
ANTS4-532	5/32	.006	51/64	.400	11/64
ANTS4-316	3/16	.010	1	.500	13/64
ANTS4-014	7/32 - 1/4	.015	1 13/32	.700	17/64
ANTS4-516	9/32 - 5/16	.035	1 51/64	.900	21/64
ANTS4-038	3/8	.085	2	1.000	25/64

Wire Rope Clips (stainless steel 316)

Code	For Cable Diameter in.	Dimensions in.		Weight / ea. lbs.
		A	D	
WRCS6-116	1/16	0.620	0.110	0.020
WRCS6-018	1/8	0.810	0.150	0.030
WRCS6-532	5/32	0.810	0.150	0.040
WRCS6-316	3/16	0.960	0.190	0.060
WRCS6-014	1/4	1.490	0.230	0.090
WRCS6-516	5/16	1.315	0.300	0.190
WRCS6-038	3/8	1.855	0.385	0.370
WRCS6-012	1/2	1.965	0.460	0.596
WRCS6-916	9/16	2.630	0.540	0.850
WRCS6-058	5/8	2.630	0.540	1.000
WRCS6-034	3/4	2.730	0.540	1.500
WRCS6-078	7/8	3.000	0.770	2.000
WRCS6-001	1	3.560	0.770	2.500

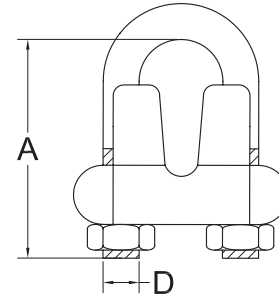

Wire Rope Clips (stainless steel 304)

Code	For Cable Diameter in.	Dimensions in.		Weight / ea. lbs.
		A	D	
WRCS4-116	1/16	0.705	0.150	0.020
WRCS4-018	1/8	0.830	0.195	0.030
WRCS4-532	5/32	0.905	0.205	0.040
WRCS4-316	3/16	0.945	0.235	0.060
WRCS4-014	1/4	1.285	0.300	0.090
WRCS4-516	5/16	1.375	0.312	0.190
WRCS4-038	3/8	1.725	0.385	0.370
WRCS4-012	1/2	2.130	0.465	0.596
WRCS4-058	5/8	2.405	0.540	1.000
WRCS4-034	3/4	2.630	0.560	1.500
WRCS4-078	7/8	3.150	0.630	2.000
WRCS4-001	1	3.500	0.630	2.500

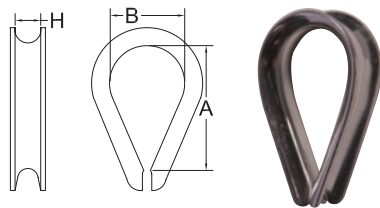
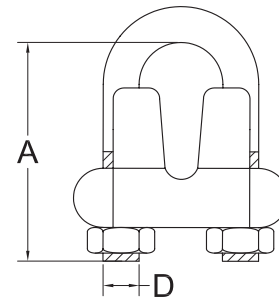

Standard Thimbles (stainless steel 304)

Standard Code 304	For Cable Diameter in.	Weight / ea. approx. lbs.	Dimensions in.		
			A	B	H
STDTS4-018	1/8	.006	.709	.394	.157
STDTS4-316	3/16	.014	.827	.512	.236
STDTS4-014	1/4	.024	1.063	.591	.276
STDTS4-516	5/16	.056	1.496	.866	.354
STDTS4-038	3/8	.073	1.614	.945	.394
STDTS4-012	1/2	.139	2.080	1.142	.551
STDTS4-058	5/8	.276	2.638	1.574	.709
STDTS4-034	3/4	.588	3.150	1.968	.866
STDTS4-078	7/8	.625	3.543	2.205	.945
STDTS4-001	1	.735	4.724	2.953	1.181

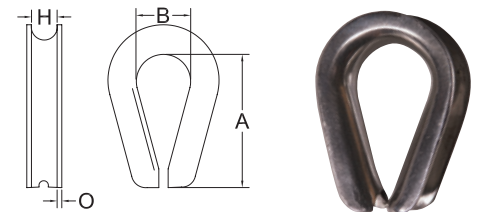

Heavy Duty Thimbles (stainless steel 316)

Heavy Duty Code 316	For Cable Diameter in.	Weight / ea. approx. lbs.	Dimensions in.			
			A	B	H	O
HSDTS6FS-316	3/16	0.04	1.35	0.71	0.23	0.05
HSDTS6FS-014	1/4	0.08	1.60	0.90	0.28	0.07
HSDTS6FS-516	5/16	0.14	1.85	1.08	0.35	0.07
HSDTS6FS-038	3/8	0.25	2.00	1.12	0.40	0.11
HSDTS6FS-012	1/2	0.53	2.62	1.52	0.55	0.15
HSDTS6FS-058	5/8	0.70	3.00	1.78	0.65	0.15
HSDTS6FS-034	3/4	1.25	3.83	2.02	0.85	0.22
HSDTS6FS-078	7/8	1.50	4.08	2.30	0.95	0.22
HSDTS6FS-001	1	2.50	4.80	2.56	1.12	0.22



Eye Nuts (stainless steel)

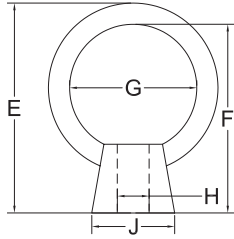

Code	Working Load Limit lbs.	Weight / ea. lbs.	Dimensions in.				
			E	F	G	H	J
ENS-014	400	0.04	1.20	1	0.62	1/4	0.50
ENS-516	700	0.08	1.55	1 5/16	0.75	5/16	0.62
ENS-038	1,000	0.13	1.92	1 5/8	0.97	3/8	0.76
ENS-012	2,000	0.26	2.38	2	1.17	1/2	0.95
ENS-058	3,200	0.53	2.81	2 1/2	1.34	5/8	1.19
ENS-034	4,700	0.75	3.36	2 3/4	1.57	3/4	1.32

Safety Factor 5:1

Lifting Eye Bolts (stainless steel 316)

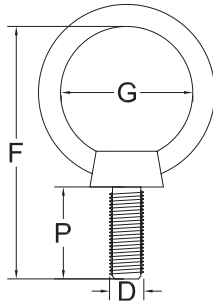

Code	Working Load Limit lbs.	Weight / ea. lbs.	Dimensions in.			
			D	F	G	P
LEBS-014916	400	0.05	1/4	1 7/16	5/8	9/16
LEBS-516916	700	0.07	5/16	1 5/8	3/4	9/16
LEBS-0381116	1,000	0.13	3/8	2 1/8	15/16	11/16
LEBS-012078	2,000	0.30	1/2	2 7/16	1 1/8	7/8
LEBS-0581116	3,200	0.45	5/8	2 15/16	1 5/16	1 1/16
LEBS-034118	4,700	0.79	3/4	3 5/16	1 9/16	1 1/8
LEBS-034002	4,700	0.79	3/4	4 7/16	1 9/16	2
LEBS-0011516	7,500	1.65	1	4 1/2	2	1 5/16

Safety Factor 5:1

Shoulder Nut Eye Bolts (stainless steel 316)

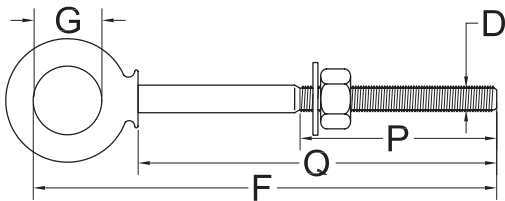

Code	Working Load Limit lbs.	Weight / ea. lbs.	Dimensions in.				
			D	F	G	P	Q
SNEBS-014004	370	0.06	1/4	4 13/16	.495	2 5/8	4
SNEBS-516412	625	0.13	5/16	5 7/8	.620	2 7/16	4 1/2
SNEBS-038412	930	0.20	3/8	5 1/4	.759	2 1/2	4 1/2
SNEBS-012006	1,700	0.33	1/2	7 3/4	1.021	3	6

Safety Factor 5:1

UNC Threading

Shoulder Nut Eye Bolts Heavy Duty (stainless steel 316)

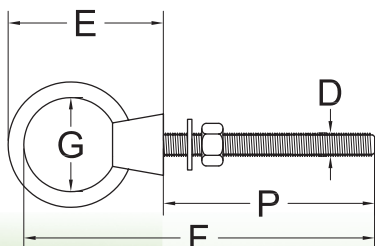

Code	Working Load Limit lbs.	Weight / ea. lbs.	Dimensions in.				
			D	E	F	G	P
HDSNEBS-014002	400	0.07	1/4	1.20	3	0.62	2.00
HDSNEBS-516004	700	0.16	5/16	1.55	5 1/4	0.75	4.00
HDSNEBS-038005	1,000	0.29	3/8	1.92	6 5/8	0.97	5.00
HDSNEBS-012006	2,000	0.61	1/2	2.38	7 7/8	1.17	6.00
HDSNEBS-058006	3,200	1.10	5/8	2.81	8 1/4	1.34	6.00
HDSNEBS-034006	4,700	1.60	3/4	3.36	8 5/8	1.57	6.00
HDSNEBS-001009	7,000	3.78	1	3.55	11 1/2	2.00	9.00

Safety Factor 5:1

UNC Threading

Ben-Mor Threaded Studs (stainless steel)

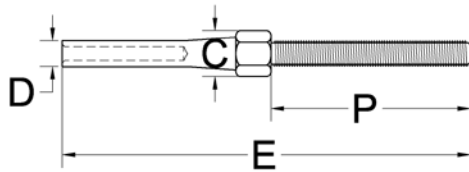

Code	For Cable Diameter	Thd. D NF-3A or UNF-3A	Dimensions in.					
			C	D Before swage	D After swage	E Before swage	E After swage	P
BM2I259-2	1/16	6-40	.188	.160	.138	2.473	2.650	1.045
BM2I259-3	3/32	10-32	.250	.218	.190	2.879	2.996	1.204
BM2I259-4	1/8	1/4-28	.313	.250	.219	3.333	3.589	1.376
BM2I259-5	5/32	1/4-28	.313	.297	.250	3.627	3.972	1.376
BM2I259-6	3/16	5/16-24	.375	.359	.313	4.002	4.170	1.458
BM2I259-7	7/32	3/8-24	.438	.427	.375	4.516	4.812	1.625
BM2I259-8	1/4	3/8-24	.500	.494	.438	4.937	5.236	1.750
BM2I259-9	9/32	7/16-20	.625	.563	.500	5.391	5.750	1.875
BM2I259-10	5/16	1/2-20	.688	.635	.563	5.844	6.266	2.000
BM2I259-12	3/8	9/16-18	.750	.703	.625	6.656	7.069	2.250
BM2I259-14	7/16	5/8-18	.812	.781	.688	7.437	7.910	2.500
BM2I259-16	1/2	5/8-18	.875	.844	.750	8.187	8.742	2.500

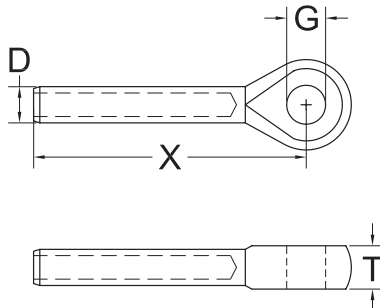

Marine Eyes EY1 (stainless steel)

Code	For Cable Diameter in.	Weight / ea. lbs.	Dimensions in.					
			D Before swaging	D After swaging	G Before swage	T Before swage	X Before swage	X After swage
EY1-2	1/16	.015	0.160	0.138	0.264	0.218	1.500	1.809
EY1-3	3/32	.028	0.218	0.190	0.264	0.218	1.758	2.070
EY1-4	1/8	.033	0.250	0.219	0.264	0.218	2.088	2.401
EY1-5	5/32	.055	0.297	0.250	0.327	0.281	2.355	2.709
EY1-6	3/16	.090	0.359	0.313	0.389	0.359	2.750	3.147
EY1-7	7/32	.150	0.427	0.375	0.452	0.406	3.220	3.787
EY1-8	1/4	.250	0.494	0.438	0.514	0.468	3.625	4.282
EY1-9	9/32	.330	0.563	0.500	0.514	0.468	3.795	4.514
EY1-10	5/16	.500	0.635	0.563	0.640	0.593	4.495	5.274
EY1-12	3/8	.670	0.703	0.625	0.640	0.593	4.930	5.659
EY1-14	7/16	1.00	0.781	0.688	0.765	0.719	6.375	6.750
EY1-16	1/2	1.25	0.844	0.750	0.890	0.844	7.375	7.587



EYE & EYE

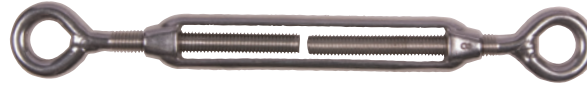

JAW & JAW



HOOK & HOOK



Precision Cast Turnbuckles (stainless steel 316)

Code E & E	Code J & J	Size Diameter x Take-Up in.	Working Load Limit lbs.	Code H & H	Size Diameter x Take-Up in.	Working Load Limit lbs.	Weight / ea. lbs.
			E & E / J & J			H & H	
TEES-316214	TJJS-316214	3/16 x 2 1/4	300	THHS-316212	3/16 x 2 1/2	100	0.10
TEES-014234	TJJS-014234	1/4 x 2 3/4	440	THHS-014003	1/4 x 3	200	0.20
TEES-516334	TJJS-516334	5/16 x 3 3/4	800	THHS-516004	5/16 x 4	400	0.37
TEES-038434	TJJS-038434	3/8 x 4 3/4	1,200	THHS-038006	3/8 x 6	700	0.60
TEES-012006	TJJS-012006	1/2 x 6	2,200	THHS-012006	1/2 x 6	1,000	1.25
TEES-058008	TJJS-058008	5/8 x 8	2,800	THHS-058008	5/8 x 8	1,500	2.38
TEES-034010	TJJS-034010	3/4 x 10	3,500	THHS-034010	3/4 x 10	2,000	4.00

Safety Factor 5:1

UNC threading

EYE & EYE



JAW & JAW



HOOK & HOOK



Forged Turnbuckles (stainless steel 316)

Code E & E	Code J & J	Size Diameter x Take-Up in.	Working Load Limit lbs.	Code H & H	Size Diameter x Take-Up in.	Working Load Limit lbs.	Weight / ea. lbs.
			E & E / J & J			H & H	
TEES-014004F	TJJS-014004F	1/4 x 4	460	THHS-014004F	1/4 x 4	300	0.20
TEES-516412F	TJJS-516412F	5/16 x 4 1/2	780	THHS-516412F	5/16 x 4 1/2	500	0.37
TEES-038006F	TJJS-038006F	3/8 x 6	1,160	THHS-038006F	3/8 x 6	750	0.60
TEES-012006F	TJJS-012006F	1/2 x 6	2,150	THHS-012006F	1/2 x 6	1,050	1.25
TEES-058006F	TJJS-058006F	5/8 x 6	3,440	THHS-058006F	5/8 x 6	1,600	2.38
TEES-034006F	TJJS-034006F	3/4 x 6	5,140	THHS-034006F	3/4 x 6	2,000	4.00

Safety Factor 5:1

UNC threading



Jaw and Swage Terminals (stainless steel 316)

Code	For Cable Diameter in.	Size Diameter x Take-Up in.	Weight / ea. lbs.
TJS-018A	1/8	1/4 x 3 1/2	0.2
TJS-532A	5/32	1/4 x 3 1/2	0.2
TJS-532B	5/32	5/16 x 4 5/16	0.3
TJS-316A	3/16	5/16 x 4 5/16	0.3
TJS-316B	3/16	3/8 x 4 3/4	0.5
TJS-732A	7/32	3/8 x 4 3/4	0.5
TJS-014A	1/4	3/8 x 4 3/4	0.6
TJS-014B	1/4	1/2 x 5 7/8	0.6
TJS-932A	9/32	7/10 x 5 1/8	0.7
TJS-932B	9/32	1/2 x 5 7/8	1.0
TJS-516A	5/16	1/2 x 5 7/8	1.8
TJS-516B	5/16	5/8 x 7 1/2	1.9
TJS-038A	3/8	5/8 x 7 1/2	2.0
TJS-038B	3/8	3/4 x 8 5/8	3.7
TJS-012A	1/2	3/4 x 8 5/8	3.8



Screw Pin Shackles, bow type (stainless steel 316)

Code	Size in.	Working Load Limit lbs.	Weight ea. lbs.	Dimensions (in.)						
				A	B	D	G	H	L	T
SPAS-316S6	3/16	400	0.03	0.740	0.622	0.206	0.220	0.375	0.200	0.448
SPAS-014S6	1/4	720	0.06	0.820	0.960	0.232	0.268	0.526	0.225	0.500
SPAS-516S6	5/16	1,060	0.16	1.350	1.120	0.305	0.335	0.660	0.308	0.625
SPAS-038S6	3/8	1,600	0.24	1.520	1.280	0.415	0.427	0.820	0.386	0.780
SPAS-716S6	7/16	2,200	0.50	2.100	1.640	0.464	0.497	0.960	0.464	0.933
SPAS-012S6	1/2	2,800	0.40	2.000	1.520	0.450	0.520	1.060	0.462	1.010
SPAS-058S6	5/8	4,400	1.00	2.900	2.130	0.620	0.635	1.220	0.600	1.250
SPAS-034S6	3/4	6,400	1.61	2.900	2.450	0.767	0.845	1.570	0.767	1.550
SPAS-078S6	7/8	8,800	2.53	3.350	2.190	0.875	1.040	1.400	0.965	2.000
SPAS-001S6	1	15,500	3.60	4.400	3.400	0.970	1.100	2.000	0.958	2.000

Safety Factor 5:1

Do not use for lifting. Lifting application available on request.

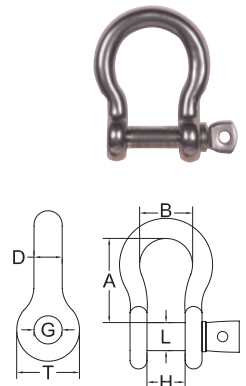

Screw Pin Shackles, chain type (stainless steel 316)

Code	Size in.	Working Load Limit lbs.	Weight ea. lbs.	Dimensions (in.)					
				A	D	G	H	L	T
SPCS-316S6	3/16	400	0.03	0.765	0.200	0.210	0.461	0.188	0.400
SPCS-014S6	1/4	720	0.06	0.820	0.230	0.260	0.480	0.226	0.425
SPCS-516S6	5/16	1,060	0.16	1.070	0.302	0.325	0.672	0.305	0.620
SPCS-038S6	3/8	1,600	0.24	1.400	0.388	0.400	0.812	0.380	0.770
SPCS-012S6	1/2	2,800	0.40	1.810	0.500	0.525	1.000	0.465	1.020
SPCS-058S6	5/8	4,400	1.00	1.900	0.586	0.637	1.250	0.626	1.150

Safety Factor 5:1

Do not use for lifting. Lifting application available on request.

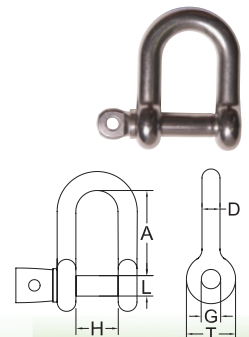

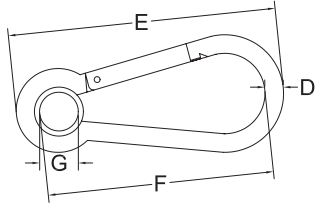

Carbine Snap Hooks with Eyelets (stainless steel 316)

Code	Working Load Limit lbs.	Weight / ea. lbs.	Dimensions in.				
			D		E	F	G
			in.	mm			
S9-1	120	0.04	3/16	5	1.97	1.553	0.197
S9-2	160	0.06	1/4	6	2.36	1.918	0.197
S9-3	300	0.15	5/16	8	3.15	2.471	0.315
S9-4	400	0.32	3/8	10	3.94	3.036	0.394
S9-5	700	0.60	1/2	12	5.51	4.516	0.512
Safety Factor 3:1							

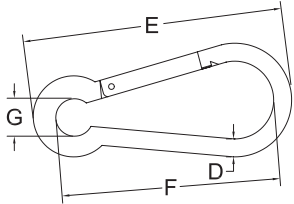

Carbine Snap Hooks (stainless steel 316)

Code	Working Load Limit lbs.	Weight / ea. lbs.	Dimensions in.				
			D		E	F	G Min
			in.	mm			
S11-1	120	0.04	3/16	5	1.97	1.609	0.197
S11-2	160	0.06	1/4	6	2.36	1.945	0.197
S11-3	300	0.15	5/16	8	3.15	2.578	0.315
S11-4	400	0.32	3/8	10	3.94	3.146	0.394
S11-5	700	0.60	1/2	12	5.51	4.678	0.512
Safety Factor 3:1							

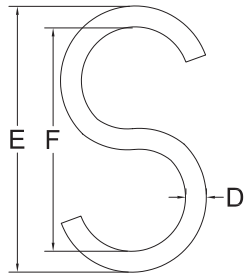

"S" Hooks (stainless steel 316)

Code	Weight / ea. lbs.	Dimensions in.			
		D		E	F
		in.	mm		
SHS-018	0.01	1/8	3	1.35	1.142
SHS-532	0.02	5/32	4	1.61	1.116
SHS-316	0.03	3/16	5	1.98	1.490
SHS-014	0.07	1/4	6	2.10	1.809
SHS-516	0.15	5/16	8	2.42	2.075

ISO 9001:2008

Quality at Ben-Mor...

- A **Quality management system** insuring to our customers the highest level of quality in our services and products;
- Management by **process**;
- Systematic receiving **inspection** and testing of all merchandise to insure that all products are up to the specs in place;
- Periodic **evaluation** of all our suppliers;
- All products managed by a unique and efficient **traceability** system;
- Rigorous **inspections** executed by a team of experts throughout the process;
- All the essential **equipment** for an efficient quality control, including a 225,000 lbs capacity test bench.
- Rigorous **calibration** of all production and control equipment;
- Continuous **training** of our employees;
- A multidisciplinary team offering complete and professional technical **support**;
- The **involvement** of all employees in our quality management system.

Quick links (stainless steel 316)

Code	Working Load Limit lbs.	Weight / ea. lbs.	Dimensions in.			
			A	B	D	
					in.	mm
QLS-018	220	0.03	1.00	0.335	1/8	3
QLS-532	500	0.05	1.29	0.437	5/32	4
QLS-316	660	0.06	1.40	0.512	3/16	5
QLS-014	880	0.09	1.77	0.571	1/4	6
QLS-516	1,760	0.18	2.28	0.689	5/16	8
QLS-038	2,640	0.28	2.72	0.808	3/8	10
QLS-012	3,300	0.70	3.17	0.925	1/2	12

Safety Factor 3:1

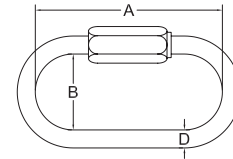

Swivel Eye Snaps (stainless steel 316)

Code	Working Load Limit lbs.	Weight / ea. lbs.	Dimensions in.	
			F	H
S2-1	120	0.128	3 5/16	3/4
S2-2	150	0.204	3 7/8	3/4

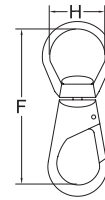

Fixed Eye Snaps (stainless steel 316)

Code	Working Load Limit lbs.	Weight / ea. lbs.	Dimensions in.	
			F	H
S1-0	100	0.050	2	7/16
S1-1	140	0.052	2 1/16	5/8
S1-2	240	0.106	2 7/8	3/4
S1-3	320	0.165	3 5/16	3/4

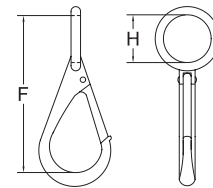

Safety Snap Hooks (stainless steel 316)

Code	Working Load Limit lbs.	Weight / ea. lbs.	Dimensions in.	
			F	H
S7-1	500	0.26	4 1/8	3/4
S7-2	600	0.42	4 3/4	1 1/8

Safety Factor 3:1

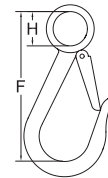

Swivel Hooks (stainless steel 316)

Code	Working Load Limit lbs.	Weight ea. lbs.	Dimensions in.				
			B	D	E	F	H
SH4-014	770	0.42	0.87	1/4	4.65	3.607	0.68
SH5-516	1,430	0.72	1.10	5/16	5.50	4.210	0.76
SH6-038	2,200	1.16	1.10	3/8	6.25	4.752	0.79
SH8-012	3,300	2.34	1.42	1/2	7.87	5.875	1.18

Safety Factor 4:1

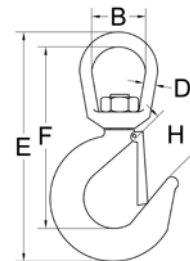

Eye Hooks (stainless steel 316)

Code	For Chain Size in.	Working Load Limit lbs.	Weight / ea. lbs.	Dimensions in.			
				D	F	G	H
EHS-014	1/4	600	0.35	1/4	2.54	0.53	0.68
EHS-516	5/16	1,100	0.55	5/16	2.85	0.64	0.70
EHS-038	3/8	1,540	0.92	3/8	3.28	0.71	0.80
EHS-012	1/2	2,860	1.90	1/2	4.17	0.94	1.02

Safety Factor 5:1

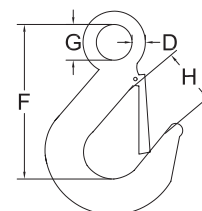



Lifting

Synthetic Web Sling type # 1* - 2* - 3 - 4

SINGLE PLY						
Width in.	Working Load Limit lbs.					
	Vertical	Choker	Basket 90°	Basket 60°	Basket 45°	Basket 30°
1	1,600	1,280	3,200	2,770	2,260	1,600
2	3,100	2,480	6,200	5,360	4,380	3,100
3	4,700	3,760	9,400	8,140	6,640	4,700
4	6,200	4,960	12,400	10,730	8,760	6,200
6	9,300	7,440	18,600	16,100	13,150	9,300
8	11,750	9,400	23,500	20,350	16,610	11,750
10	14,700	11,760	29,400	25,460	20,780	14,700
12	17,650	14,120	35,300	30,560	24,950	17,650

Safety Factor 5:1

DOUBLE PLY						
Width in.	Working Load Limit lbs.					
	Vertical	Choker	Basket 90°	Basket 60°	Basket 45°	Basket 30°
1	3,100	2,400	6,200	5,300	4,300	3,100
2	6,200	4,960	12,400	10,700	8,700	6,200
3	8,800	7,040	17,600	15,200	12,400	8,800
4	11,000	8,800	22,000	19,000	15,500	11,000
6	16,500	13,200	33,000	28,500	23,300	16,500
8	22,750	18,200	45,500	39,400	32,100	22,750
10	28,400	22,720	56,800	49,100	40,100	28,400
12	34,100	27,280	68,200	59,000	48,200	34,100

Safety Factor 5:1

* Type 1 & 2 : Steel Triangles, zinc plated (better corrosion resistance)
 Note : 1" width not available for types 1 and 2.

Synthetic Web Sling type # 3* - 4*

TRIPLE PLY						
Width in.	Working Load Limit lbs.					
	Vertical	Choker	Basket 90°	Basket 60°	Basket 45°	Basket 30°
1	4,100	3,300	8,200	7,050	5,780	4,100
2	8,300	6,600	16,600	10,470	11,700	8,300
3	12,500	10,000	25,000	21,500	17,600	12,500
4	16,000	12,800	32,000	27,500	22,500	16,000
6	23,000	18,400	46,000	39,500	32,400	23,000
8	30,700	24,500	61,400	52,800	43,300	30,700
10	36,800	29,400	73,600	63,300	51,900	36,800
12	44,000	35,200	88,000	75,700	62,000	44,000

Safety Factor 5:1

QUADRUPLE PLY						
Width in.	Working Load Limit lbs.					
	Vertical	Choker	Basket 90°	Basket 60°	Basket 45°	Basket 30°
1	5,500	4,400	11,000	9,500	7,700	5,500
2	11,000	8,800	22,000	19,000	15,500	11,000
3	16,450	13,100	32,900	28,400	23,200	16,450
4	20,400	16,300	40,800	35,300	28,800	20,400
6	30,600	24,400	61,200	52,900	43,200	30,600
8	39,700	31,700	79,400	68,600	56,000	39,700
10	49,600	39,600	99,200	85,800	69,900	49,600
12	59,500	47,600	119,000	102,900	83,900	59,500

Safety Factor 5:1

* We suggest using a roundsling. See page 69
 Material available : Polyester, Nylon Class 7 : 9,800 lbs/in. = Breaking Strength

Synthetic slings should be used with wear pads. Wear pads will reduce the wear on the sling, and in turn extend the life of the sling. See page 65.

Product code

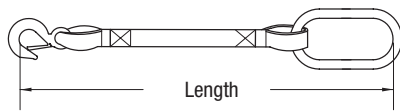

EE	1	9	01	Y	03	T3
Sling Type EE = Eye & Eye TI = Triangle & Triangle TC = Triangle & Choker EN = Endless	Number of ply	Capacity (9000 lbs./in.)	Width (inches)	Material Y = Polyester N = Nylon A = «Armour»	Length (feet)	Type
Eye & Eye, 1 ply, 9000 lbs./in., 1", Poly, 3', Type T3						

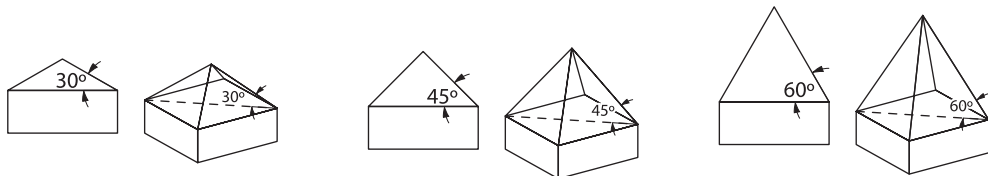

! WARNING: The maximum loads shown are applicable for products in new conditions.
! Do not exceed maximum rated capacities.



Synthetic Web Sling type # 5

SINGLE PLY						
Width in.	Working Load Limit lbs.					
	Vertical	Choker	Basket 90°	Basket 60°	Basket 45°	Basket 30°
1	3,200	2,560	6,400	5,540	4,520	3,200
2	6,200	4,960	12,400	10,730	8,760	6,200
3	9,400	7,520	18,800	16,200	13,200	9,400
4	12,400	9,920	24,800	21,470	17,530	12,400
6	18,600	14,880	37,200	32,210	26,300	18,600
8	21,200	16,900	42,400	36,700	29,900	21,200
10	26,500	21,200	53,000	45,800	37,400	26,500
12	31,800	25,400	63,600	55,000	44,900	31,800

Safety Factor 5:1

DOUBLE PLY						
Width in.	Working Load Limit lbs.					
	Vertical	Choker	Basket 90°	Basket 60°	Basket 45°	Basket 30°
1	6,200	4,960	12,400	10,700	8,700	6,200
2	12,400	9,920	24,800	21,400	17,500	12,400
3	17,600	14,080	35,200	30,400	24,800	17,600
4	22,000	17,600	44,000	38,100	31,100	22,000
6	33,000	26,400	66,000	57,100	46,600	33,000
8	42,300	33,800	84,600	73,200	59,800	42,300
10	52,900	42,300	105,800	91,600	74,800	52,900
12	63,500	50,800	127,000	109,900	89,700	63,500

Safety Factor 5:1



TYPE 5

TRIPLE PLY						
Width in.	Working Load Limit lbs.					
	Vertical	Choker	Basket 90°	Basket 60°	Basket 45°	Basket 30°
1	7,900	6,300	15,800	13,600	11,100	7,900
2	15,800	12,600	31,600	27,300	22,300	15,800
3	22,900	18,300	45,800	39,600	32,300	22,900
4	30,600	24,400	61,200	52,900	43,200	30,600
6	45,800	36,600	91,600	79,300	64,700	45,800
8	61,200	48,900	122,400	105,900	86,500	61,200
10	76,500	61,200	153,000	132,400	108,100	76,500
12	91,800	73,400	183,600	158,900	129,800	91,800

Safety Factor 5:1

QUADRUPLE PLY						
Width in.	Working Load Limit lbs.					
	Vertical	Choker	Basket 90°	Basket 60°	Basket 45°	Basket 30°
1	10,200	8,100	20,400	17,600	14,400	10,200
2	19,800	15,800	39,600	34,200	27,900	19,800
3	30,000	24,000	60,000	51,900	42,400	30,000
4	39,600	31,600	79,200	68,500	55,900	39,600
6	59,500	47,600	119,000	103,000	84,100	59,500
8	81,600	65,200	163,200	141,300	115,300	81,600
10	102,000	81,600	204,000	176,600	144,200	102,000
12	122,400	97,900	244,800	211,900	173,000	122,400

Safety Factor 5:1

Type 6 (RE) return eye slings have protective webbing sewn on the body to provide a long lasting flexible and wear-resistant sling. These slings can be used a vertical, choker or basket hitch.

Type 6 - Return eye



RE1 & RE2

Code	Width in.	Working Load Limit lbs.		
		Vertical	Choker	Basket 90°
		RE1902	2	3,100
RE1904	4	6,000	4,500	12,000
RE1906	6	8,600	6,450	17,200

Safety Factor 5:1

Code	Width in.	Working Load Limit lbs.		
		Vertical	Choker	Basket 90°
		RE2902	2	6,100
RE2904	4	12,000	9,000	24,000
RE2906	6	16,300	12,200	32,600

Safety Factor 5:1

These slings are designed for occasional or light duty lifting applications. They can be used in a vertical, choker & basket hitch. Available 1" & 1.75" only.

Type 7 - Light duty eye & eye



EE1 & EE2

Code	Width in.	Working Load Limit lbs.		
		Vertical	Choker	Basket 90°
		EE1601	1	1,100
EE1675	1 3/4	1,900	1,425	3,800

Safety Factor 5:1

Code	Width in.	Working Load Limit lbs.		
		Vertical	Choker	Basket 90°
		EE2601	1	2,200
EE2675	1 3/4	3,800	2,850	7,600

Safety Factor 5:1

Type 7 - Light duty endless



EN1 & EN2

Code	Width in.	Working Load Limit lbs.		
		Vertical	Choker	Basket 90°
		EN1601	1	2,200
EN1675	1 3/4	3,800	3,050	7,600

Safety Factor 5:1

Code	Width in.	Working Load Limit lbs.		
		Vertical	Choker	Basket 90°
		EN2601	1	4,400
EN2675	1 3/4	7,700	6,100	15,400

Safety Factor 5:1



Synthetic Web Sling, double leg

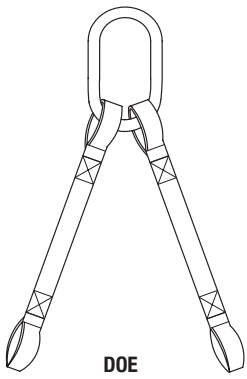

DOE

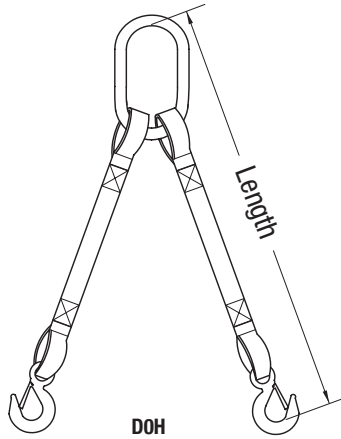

DOH

Number of Plies	Material Width in.	Working Load Limit lbs.		
		60 °	45 °	30 °
1	1	2,770	2,260	1,600
1	2	5,360	4,380	3,100
1	3	8,140	6,640	4,700
1	4	10,730	8,760	6,200
2	1	5,360	4,380	3,100
2	2	10,790	8,760	6,200
2	3	15,240	12,440	8,800
2	4	19,050	15,550	11,000
3	1	6,580	5,370	3,800
3	2	12,820	10,460	7,400
3	3	19,400	15,840	11,200
3	4	25,630	20,930	14,800
4	1	9,520	7,770	5,500
4	2	19,050	15,550	11,000
4	3	28,490	23,260	16,450
4	4	35,330	28,840	20,400

Safety Factor 5:1

Synthetic Web Sling, three legs

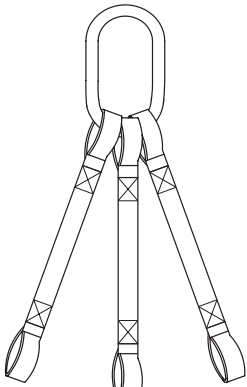

TOE

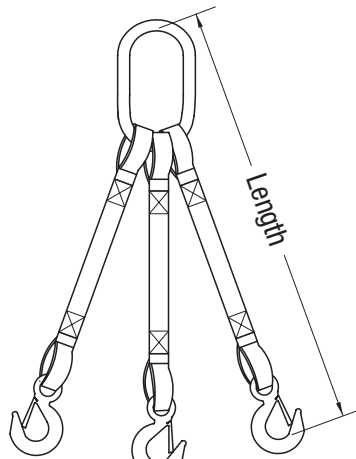

TOH

Number of Plies	Material Width in.	Working Load Limit lbs.		
		60 °	45 °	30 °
1	1	4,150	3,390	2,400
1	2	8,050	6,570	4,650
1	3	12,200	9,960	7,050
1	4	16,100	13,100	9,300
2	1	8,050	6,570	4,650
2	2	16,100	13,150	9,300
2	3	22,800	18,600	13,200
2	4	28,500	23,300	16,500
3	1	9,870	8,060	5,700
3	2	19,220	15,690	11,100
3	3	29,100	23,750	16,800
3	4	38,450	31,390	22,200
4	1	14,200	11,600	8,250
4	2	28,500	23,300	16,500
4	3	42,700	34,800	24,600
4	4	52,900	43,200	30,600

Safety Factor 5:1

Synthetic Web Sling, four legs

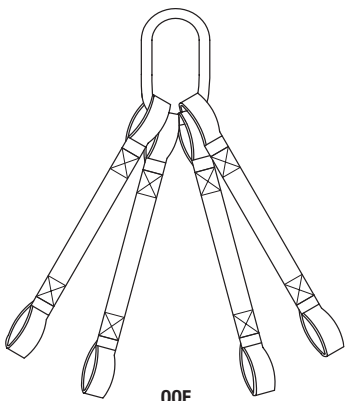

QOE

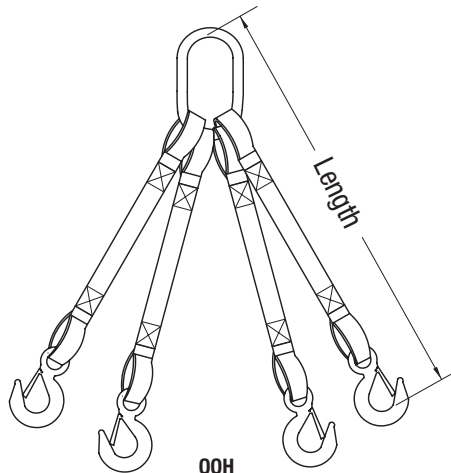

QOH

Number of Plies	Material Width in.	Working Load Limit lbs.		
		60 °	45 °	30 °
1	1	5,540	4,520	3,200
1	2	10,700	8,760	6,200
1	3	16,200	13,200	9,400
1	4	21,400	17,500	12,400
2	1	10,730	8,760	6,200
2	2	21,470	17,530	12,400
2	3	30,400	24,800	17,600
2	4	38,100	31,100	22,000
3	1	13,160	10,750	7,600
3	2	25,630	20,930	14,800
3	3	38,800	31,670	22,400
3	4	51,270	41,850	29,600
4	1	19,000	15,500	11,000
4	2	38,100	31,100	22,000
4	3	56,900	46,500	32,900
4	4	70,600	57,600	40,800

Safety Factor 5:1

Material available : Polyester, Nylon
Class 7 : 9,800 lbs/in. = Fabric Tensile



Wide lift slings provide maximum weight distribution of the load for those extra wide lifts. These slings have tapered eyes but can only be used in a basket hitch.

Wide Lift Cargo Heavy Loads



WL

SINGLE PLY				
Code	Width in.	Eye Length in.	Eye Width in.	Working Load Limit lbs.
				Basket
WL1906	6	9	1.5	15,400
WL1908	8	12	2	20,400
WL1912	12	18	3	30,800
WL1916	16	24	4	38,000
WL1920	20	30	5	45,000
WL1924	24	36	6	52,000

Safety Factor 5:1

DOUBLE PLY				
Code	Width in.	Eye Length in.	Eye Width in.	Working Load Limit lbs.
				Basket
WL2906	6	9	1.5	28,600
WL2908	8	12	2	38,000
WL2912	12	18	3	57,200
WL2916	16	24	4	75,000
WL2920	20	30	5	90,000
WL2924	24	36	6	110,000

Safety Factor 5:1

Wide lift light load slings are made with a single ply body and an eye is attached. Eyes are available in one ply (WLA1) and two plies (WLA2)

Wide Lift Cargo Light Loads



WLA

SINGLE PLY EYES				
Code	Width in.	Eye Length in.	Web Width Used for Eye in.	Working Load Limit lbs.
				Basket
WLA1906	6	10	2	5,000
WLA1908	8	10	2	5,000
WLA1910	10	12	2	5,000
WLA1912	12	12	2	5,000
WLA1916	16	12	4	10,000
WLA1920	20	18	4	10,000
WLA1924	24	18	4	10,000

Safety Factor 5:1

DOUBLE PLY EYES				
Code	Width in.	Eye Length in.	Web Width Used for DOUBLE PLY Eyes in.	Working Load Limit lbs.
				Basket
WLA2906	6	10	2	10,000
WLA2908	8	10	2	10,000
WLA2910	10	12	2	10,000
WLA2912	12	12	2	10,000
WLA2916	16	12	4	18,000
WLA2920	20	18	4	18,000
WLA2924	24	18	4	18,000

Safety Factor 5:1

SINGLE PLY EYES				
Code	Width in.	Eye Length in.	Web Width Used for Endless Sling Eye in.	Working Load Limit lbs.
				Basket
WLE1906	6	10	1	5,000
WLE1908	8	10	1	5,000
WLE1910	10	12	1	5,000
WLE1912	12	12	1	5,000
WLE1916	16	12	2	10,000
WLE1920	20	18	2	10,000
WLE1924	24	18	2	10,000

Safety Factor 5:1

DOUBLE PLY EYES				
Code	Width in.	Eye Length in.	Web Width Used for DOUBLE PLY Endless Sling Eye in.	Working Load Limit lbs.
				Basket
WLE2906	6	10	1	10,000
WLE2908	8	10	1	10,000
WLE2910	10	12	1	10,000
WLE2912	12	12	1	10,000
WLE2916	16	12	2	18,000
WLE2920	20	18	2	18,000
WLE2924	24	18	2	18,000

Safety Factor 5:1

Wide Lift Cargo Light - Endless Style

⚠️ WARNING: The maximum loads shown are applicable for products in new conditions.

⚠️ Do not exceed maximum rated capacities.



GSI

Glass Slings

Glass Lifting Slings can be custom made to fit any size glass pack or crate. The slings are available with fully lined with rubber on the inside to protect the sling from the sharp edges.

Code	SINGLE PLY		
	Length in.	Height in.	Working Load Limit lbs.
GSI-078	78	36 to 54	12,400
GSI-108	108	60 to 84	12,400
GSI-124	124	72 to 100	12,400

Safety Factor 5:1



TRAN

Transformer slings

Transformer slings are made to move transformers into place. They are made with an endless nylon sling as the link, and 1-3/4" elastic web to ensure the eyes stay into the lifting points.

Code	DOUBLE PLY			
	Width in.	Leg Length in.	Spread in.	Working Load Limit lbs.
				Basket 60°
TRAN15L	1 3/4	15	15	2,800
TRAN20L	1 3/4	20	20	2,800
TRAN22L	1 3/4	22	22	2,800
TRAN24L	1 3/4	24	24	2,800
TRAN30L	1 3/4	30	30	2,800

Safety Factor 5:1

Custom fabrication

Ben-Mor takes pride in the custom work we do for our customers. All custom slings are made to a diagram that is approved by the customer before starting the manufacturing process. We identify the product with the diagram number, and keep on file for future orders.



⚠ WARNING: The maximum loads shown are applicable for products in new conditions.

⚠ Do not exceed maximum rated capacities.



Marine Slings

Nylon Marine slings (MS) are lightweight and easy to use. They will not scratch or abuse the most delicate hull.



Extra eyes are available in tapered fabric or for use with hardware. Allows a single sling to adjust to different overall lengths.

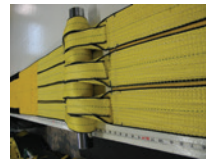

Quick disconnects allow for easy removal and installation of slings. Protective flap included.

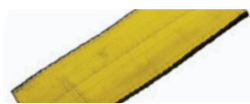

Keel pad is fastened to the sling at the centre to protect the sling from wear at the greatest load point.



Lead weights keeps slings under water. Allows easier positioning of slings under boat.

SINGLE PLY			DOUBLE PLY		
Code	Width in.	Basket Pounds	Code	Width in.	Basket Pounds
MSI-903	3	9,400	MS2-903	3	17,600
MSI-904	4	12,400	MS2-904	4	22,000
MSI-906	6	18,600	MS2-906	6	33,000
MSI-908	8	23,500	MS2-908	8	45,500
MSI-910	10	29,400	MS2-910	10	56,800
MSI-912	12	35,300	MS2-912	12	68,200

Drum Sling

Drum sling safety lifts plastic and steel drums up to 1,000 lbs.

Code	Working Load Limit lbs.
DRUMSLING	1000



⚠ WARNING: The maximum loads shown are applicable for products in new conditions.

⚠ Do not exceed maximum rated capacities.



Tow Slings



Tow Slings Eye Style

Code	Width in.	Assembly breaking strength lbs.	Towing Capacity lbs.	Eye size	Approx. weight/ft in pounds
TSE1-902	2	16,000	5,300	12	.20
TSE2-902	2	32,000	10,600	12	.26
TSE1-903	3	24,000	8,000	14	.30
TSE2-903	3	44,000	14,600	14	.40
TSE1-904	4	32,000	10,600	18	.40
TSE2-904	4	57,000	19,000	18	.50
TSE1-906	6	48,000	16,000	20	.65
TSE2-906	6	82,000	27,300	20	.78



Tow Slings with Hooks

Code	Width in.	Assembly breaking strength lbs.	Towing Capacity lbs.	Hook Size (tons) Alloy	Approx. weight/ft in pounds
TSH1-902	2	15,000	5,000	1.5	.30
TSH2-902	2	30,000	10,000	3.0	.45
TSH1-903	3	24,000	8,000	3.0	.46
TSH2-903	3	44,000	14,600	4.5	.80



Tow Slings Round Style

Code	Width in.	Assembly breaking strength lbs.	Towing Capacity lbs.	Eye size	Approx. weight/ft in pounds
TS-SL230E	4	115,000	38,300	16	1.25
TS-SL320E	4	160,000	53,300	16	1.75
TS-SL400E	5	200,000	66,600	18	2.25
TS-SL540E	6	270,000	9,000	20	2.75

Features

- ✓ Nylon tow straps give you the flexibility and elasticity that tow chains do not offer
- ✓ These nylon tow straps have approximately 15% - 20% stretch
- ✓ Connect the tow straps to solid mounting points under the vehicle
- ✓ Tow slings are NOT for lifting
- ✓ When recovering a vehicle, use straps with loops, not hooks that could retract and hit someone
- ✓ Always inspect the tow strap before each use. Look out for: cuts, knots, burns, or any other damage

Warning: Do not use for overhead lifting

Custom sizes available on request

Anchor Straps

Ben-Mor's Atlas Anchor straps become part of a fall arrest system. Anchor tie off points may differ according to the design of the project and or structure. It is important that all workers are trained so that all fall protection regulations are met. Ben-Mor's Atlas Anchor straps have a 5000 lbs minimum breaking strength per strap and meet CSA, ANSI, and OSHA anchorage requirements.



Atlas Low Rise Anchor Strap LR2-42

- ✓ 2" X 42" complete with 4" loop at one end, and 6" loop at the other end
- ✓ 1 Box (120 straps, 10/bag)
- ✓ 5,000 Lbs minimum breaking strength



Atlas High Rise Anchor Strap HR2-42

- ✓ 2" X 42" complete with dee ring at one end, and 6" loop at the other end
- ✓ 5,000 Lbs minimum breaking strength



ARMOUR WEB™



- ✓ Excellent abrasion resistance
- ✓ Best Value in Synthetic Web Slings
- ✓ Longer sling life reducing rigging costs
- ✓ Available in a wide range of sizes
- ✓ 100% Polyester
- ✓ 3% Elongation
- ✓ Maximum temperature exposure 180°F
- ✓ Better resistance to UV rays than Nylon
- ✓ Excellent chemical resistance

Results from a 5000 cycle Hex-Bar Abrasion test proved ARMOUR WEB to be better than treated Nylon and treated Polyester.

Environmental considerations

WARNING

Nylon and Polyester are seriously degraded at temperatures above 200° F.

Prolonged exposure to ultraviolet light adversely affects nylon and polyester. Slings become bleached and stiff when exposed to sunlight or arc welding.

Many chemicals have an adverse effect on nylon and polyester. See chemicals chart.

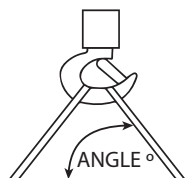

Reduction of sling capacity depends on the angle of the Sling leg. See chart for loss factor.

Angle reduction

CAUTION: SLING SHOULD FIT THE HOOK

On eye and eye type slings, the eyes must be of ample length to easily slip over the crane hook, thus reducing stress on stitching.

Rated capacities are affected by angle of lift (sling to load angle) measured from the horizontal when used with multi-legged slings or choker/basket hitches.

To determine the actual capacity at a given angle of lift, multiply the original sling rating by the appropriate loss factor determined from the table. Example:

Angle Degrees	Loss Factor
90°	1
85°	0.996
80°	0.985
75°	0.966
70°	0.94
65°	0.906
60°	0.866
55°	0.819
50°	0.766
45°	0.707
40°	0.643
35°	0.574
30°	0.500

Web Sling Rating								
EE2-902	X	60° angle	X	Number	=	2 Leg Bridle		
6,200 lbs		reduction		of Legs		EE2-902		
		.866		2		10,730 lbs		

Chemicals Chart

Chemicals	Nylon	Polyester
Acids	NOT OK	OK *
Alcohols	OK	OK
Aldehydes	OK	NOT OK
Strong alkaline	OK	OK **
Bleaching Agents	NOT OK	OK
Dry Cleaning Solvents	OK	OK
Ethers	OK	NOT OK
Halogenated Hydrocarbons	OK	OK
Hydrocarbons	OK	OK
Ketones	OK	OK
Oils Crude	OK	OK
Oils Lubricating	OK	OK
Soap Detergents	OK	OK
Water & Seawater	OK	OK
Weak alkaline	OK	OK

* Disintegrated by concentrated sulfuric acid.

** Degraded by strong alkaline concentration at elevated temperature.



Custom Labeling

The company name, logo, telephone number, or any information can be put on our sling tags. The sling tag can identify a department that the rigging belongs to, a site, a crane, or an individual's name. Our custom tagging is available for any sling type. Please contact our sales department.

Tag Varieties

DIA: 3/8 in #FAB: _____
 LENGTH/Long: _____ in _____ ft
 VERTICAL/Vertical: 2,400 LBS
 CHOKER/Etrangleur: 1,800 LBS
 BASKET/Panier: 4,800 LBS



SUNG DIA: 6X19/26/36B
 LONG. LENGTH: _____ LBS
 60° _____ LBS
 45° _____ LBS
 30° _____ LBS

BEN-MOR Tél.: 450-778-0022
 www.Ben-Mor.com
 Type _____ Grade: _____
 Reach _____ Ft _____ In
 Size _____ Serial# _____



SUNS DIA: 1/2" 6X19/26/36B
 LONG. LENGTH: _____ LBS
 VERTICAL/VERTICAL: 4400 LBS
 CHOKER / ETRANGLEUR: 3200 LBS
 BASKET 90° PANIER 90°: 8600 LBS

WLL 90° _____ lbs
 WLL 60° _____ lbs
 WLL 45° _____ lbs
 WLL 30° _____ lbs

BEN-MOR
 TEL: 800-481-0022
 www.ben-mor.com

CODE	TYPE	FABRICATION NO.	ATTENTION!
2902	5	VCO-084403	INSPECTER AVANT UTILISATION
POLY <input checked="" type="checkbox"/>	LARGEUR / WIDTH	LONGUEUR / LENGTH	CAUTION!
NYLON <input type="checkbox"/>	2"	20'	INSPECT BEFORE USING
VERTICAL	ETRANGLEUR / CHOKER	PANIER / BASKET (90°)	
12,400 LBS	9,900 LBS	24,800 LBS	



RFID

BEN-MOR
 TEL: 800-481-0022
 www.ben-mor.com

CODE	TYPE	FABRICATION NO.	ATTENTION!
2902	3	84350	INSPECTER AVANT UTILISATION
POLY <input checked="" type="checkbox"/>	LARGEUR / WIDTH	LONGUEUR / LENGTH	CAUTION!
NYLON <input type="checkbox"/>	2	10'	INSPECT BEFORE USING
VERTICAL	ETRANGLEUR / CHOKER	PANIER / BASKET (90°)	
6200 LBS	4900 LBS	12400 LBS	

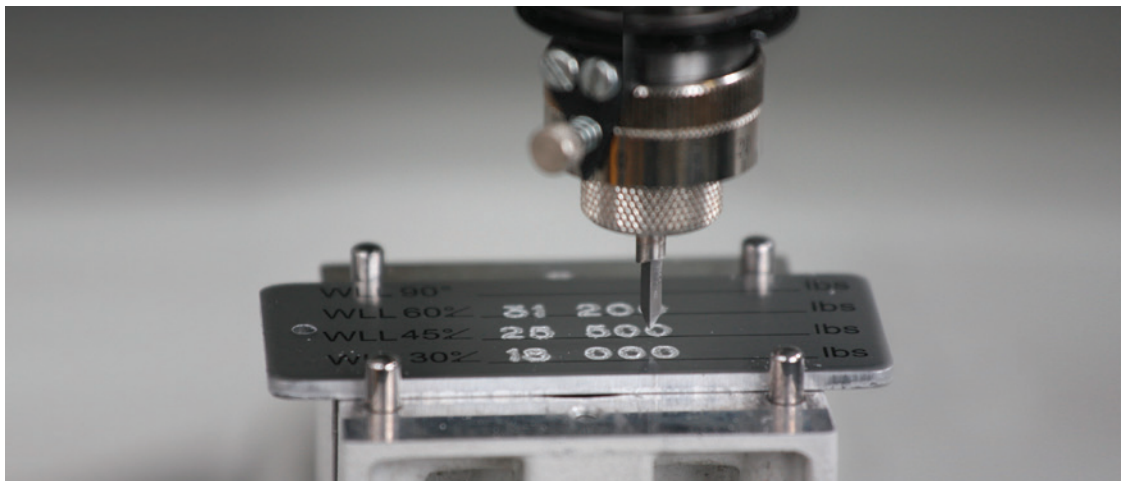



Wear Pads

Synthetic slings should be used with wear pads. Wear pads will reduce the wear on the sling, and in turn extend the life of the sling.

	Matériel ID	Material Code	Description	Quality	Sliding	Sewn	Wrapped eye
	80	BNS	Ballistic Nylon Sandwich	Excellent	X		
	81	NYL	Nylon	Good	X		
	82	BAL	Ballistic Nylon <i>Very high resistance to abrasion</i>	Excellent	X	X	X
	83	COR	Cordura Nylon	Good	X	X	X
	84	DYT	Dyneema Tubing	Best	X		
	85	POT	Poly Tubing	Good	X		
	86	COT	Cordura Nylon Tubing	Good	X		
	87	ART	Armour Ploy Tubing	Very Good	X		
	88	PWY	Poly Web (Yellow CPL)	Good	X		
	89	PWA	Poly Web (Blue Armour)	Very Good	X		
	91	PYR	Pyro Jacket <i>Protect against sparks and extreme heat</i>	Good	X		
	94	PBP	Poly Blue Protector	Basic			X
	N/A	LTH	Leather	Excellent	X	X	X



SLIDING TYPE 02



SLIDING WITH VELCRO TYPE 03



WRAPPED EYES

Product code

WITH SEWN WEAR PAD								
EE Sling Type EE = Eye & Eye TT = Triangle & Triangle TC = Triangle & Choker EN = Endless	1 Number of ply	9 Capacity (9000 lbs./in.)	01 Width (inches)	Y Material Y = Polyester N = Nylon A = Armour	03 Length (feet)	T3 Type	COR Material See "Material Code"	02 Protector Type See "Sewn Protector Type"

SLIDING WEAR PAD			
WP Wear Pad	03 Wear Pad Type 02 = Sliding 03 = Velcro Sliding	003 Width Of Sling to fit. (inches)	81 Material See "Material ID"

Sewn Protector Type

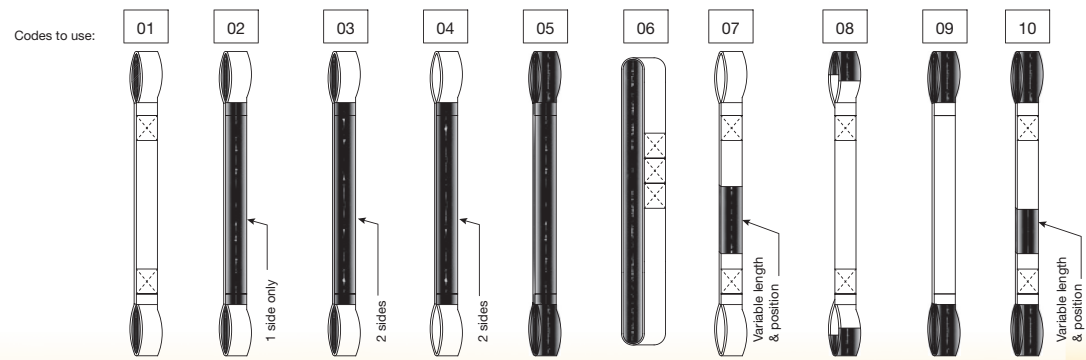



Heavy Lifting... Light Slings!

Super Slinger

High Performance Round Slings

Super Slings can be 15 times lighter than steel

- Reduce the amount of manpower needed for the job.
- Reduce the hours it takes to do the lift.
- Super Slings weigh less than 16% of what a wire rope sling would weigh.

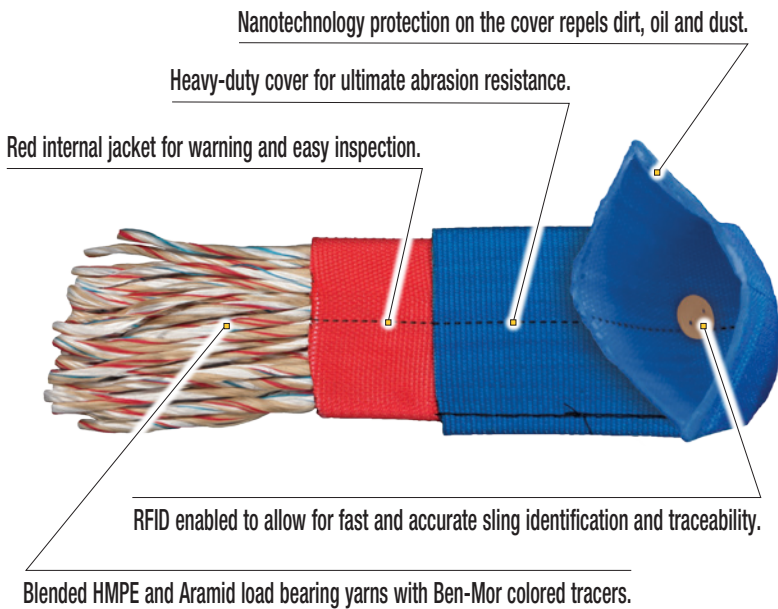

Building the world,
one lift at a time!

First ever round sling with Nanotechnology applied on the cover



Durable protective function

Due to the extremely high level of abrasion resistance, the Nano covers protective function is retained even with heavy-duty use, frequent washing or cleaning.

Naturally Self-cleaning

Oil, dirt and dust do not adhere to the Nano surface and can be rinsed off with water.



Heavy Lifting... Light Slings!

Super Slinger High Performance Round Slings



Rely on full inspection

Prevent delays! Save money!

Pre-failure warnings on slings often present a false alarm, when in fact the sling is ok to use. Prevent delays with your lift, and save money with inspection costs by using Super Slings.

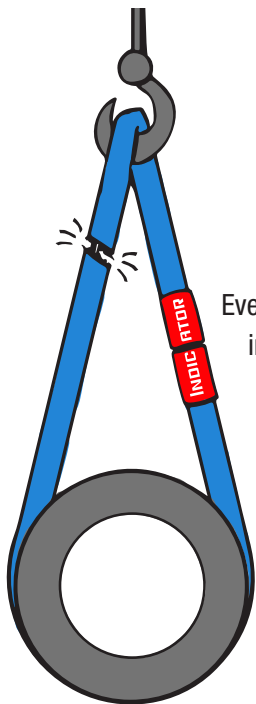

NEVER rely only on overload indicators

Even with overload indicators you must inspect the entire length of the sling.

No, the sling is damaged!

The indicator is okay, we can proceed.



Hey Boss, we just received this sling back from inspection, I put it up on crane, and pre-failure warnings have failed again. What should I do?

You can't use it, put the sling in the barrel with the others.



Meets ASME B30.9 standard!

ASME B30.9 states inspection MUST be done on the entire length of the sling!



Super Slinger High Performance Round Slings

Code	Color	Working Load Limit lbs.					Approx. Diameter In.	Approx. Weight / ft pounds
		Vertical	Choker	Basket 90°	Basket 60°	Basket 45°		
SSA200	Blue	20,000	16,000	40,000	34,600	28,000	1 1/4	0.55
SSA250	Blue	25,000	20,000	50,000	43,200	35,000	1 1/4	0.65
SSA300	Blue	30,000	24,000	60,000	51,900	42,000	1 3/8	0.80
SSA400	Blue	40,000	32,000	80,000	69,200	56,000	1 3/4	1.10
SSA500	Blue	50,000	40,000	100,000	86,500	70,000	1 7/8	1.50
SSA600	Blue	60,000	48,000	120,000	103,800	84,000	2	1.60
SSA700	Blue	70,000	56,000	140,000	121,100	98,000	2 1/8	1.65
SSA850	Blue	85,000	68,000	170,000	147,000	119,000	2 1/2	1.85
SSA1000	Blue	100,000	80,000	200,000	173,000	140,000	2 3/4	2.20
SSA1250	Blue	125,000	100,000	250,000	216,200	175,000	3	3.00
SSA1500	Blue	150,000	120,000	300,000	259,500	210,000	3 1/4	3.35
SSA1750	Blue	175,000	140,000	350,000	302,700	245,000	3 1/2	4.00
SSA2000	Blue	200,000	160,000	400,000	346,000	280,000	3 3/4	4.35
SSA2250	Blue	225,000	180,000	450,000	389,700	318,000	5	5.00
SSA2500	Blue	250,000	200,000	500,000	433,000	353,000	5 1/2	5.85
SSA2750	Blue	275,000	220,000	550,000	476,300	388,000	6	6.50
SSA3000	Blue	300,000	240,000	600,000	519,600	424,000	6 1/2	7.15
SSA4000	Blue	400,000	320,000	800,000	692,800	565,600	7	7.00
SSA5000	Blue	500,000	400,000	1,000,000	866,000	707,000	8	8.50
SSA6000	Blue	600,000	480,000	1,200,000	1,039,200	848,400	9	10.00

Safety Factor 5:1

Elongation at WLL	1%
Melting Range	144-152°C
Density	Floats
Moisture Retention	1%
Yarn Abrasion Resistance	Excellent (yarn on yarn)
Cover Abrasion Resistance	Excellent
UV Resistance	Very Good
Loss Strength when wet	0%



Super Slinger Roundsling

Slinger Features

- The most flexible sling available
- The sling conforms to the load extremely well, and provides the best choker hold
- Hook and load contact points can be continually rotated to extend the service life of the sling
- Longer sling life means cost reduction in sling purchases
- The load bearing fiber never comes into contact with the load
- Protection to the load from sling damage
- Seamless cover, no edges to wear out
- Wide variety of sling lengths and load capacities
- Adapts to all types, sizes, and load
- Lightweight, easy to rig, store, and clean
- Excellent resistance to ultraviolet light, rot, and mildew
- No loss of strength in water
- Only 3% elongation
- Maximum temperature exposure 194°F
- No metal parts on the sling, will not rust
- Configurations

Slinger Construction



Slinger roundslings are constructed from a multiple of high tenacity polyester yarns in an endless or continuous loop. These load bearing yarns are protected by two woven polyester jackets which act as a buffer between the load and the polyester yarn.

It is recommended to always use wear pads.

Product code: WPCPB

(See page 65)

Wear pads

All Super Slingers shall be used with wear pads. Using wear pads will protect your investment of a high performance sling as well as lower risk of accidents or injuries. There are many options available with qualities varying from good to ultimate.

Xtreme Tubing

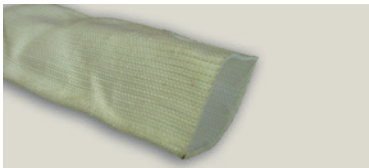

Xtreme wear pads provide the Ultimate protection against abrasion. These wear pads are specifically designed to be used on loads with sharp edges.

Armour Tubing

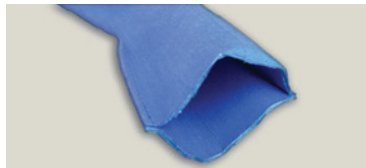

Armour wear pads are a great solution to abrasive surfaces. These wear pads will prolong the life of the sling.

Ballistic Nylon



Ballistic Nylon wear pads offer extensive protection to the sling.

Corner Wear Pad

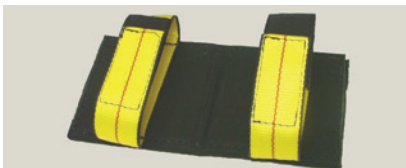

These wear pads are necessary when lifting around sharp corners. The bulky protection pad ensures that the sling will not be damaged.



Velcro Ties



Velcro ties hold the wear pad in place.



Slinger Polyester Roundsling

Code	Color Code	Working Load Limit (lbs.)						Minimum Length ft.	Diameter in.	Weight lbs./ft.
		Vertical	Choker	Basket 90°	Basket 60°	Basket 45°	Basket 30°			
SL 30	Purple	3,000	2,400	6,000	5,100	4,200	3,000	18"	.75	.25
SL 40	Black	4,000	3,200	8,000	6,900	5,600	4,000	18"	.80	.35
SL 60	Green	6,000	4,800	12,000	10,300	8,400	6,000	18"	.90	.40
SL 90	Yellow	9,000	7,200	18,000	15,500	12,700	9,000	2	1.00	.50
SL 120	Tan	12,000	9,600	24,000	20,700	16,900	12,000	3	1.25	.75
SL 140	Red	14,000	11,200	28,000	24,200	19,700	14,000	3	1.30	.85
SL 170	Orange	17,000	13,600	34,000	29,400	24,000	17,000	3	1.60	.95
SL 230	Blue	23,000	18,400	46,000	39,800	32,500	23,000	3	1.65	1.25
SL 260	Orange	26,000	20,800	52,000	45,000	36,700	26,000	3	1.75	1.45
SL 320	Grey	32,000	25,600	64,000	55,400	45,200	32,000	3	2.15	1.75
SL 400	Orange	40,000	32,000	80,000	69,200	56,500	40,000	4	2.45	2.25
SL 540	Brown	54,000	43,200	108,000	93,500	76,300	54,000	6	3.00	2.75
SL 680	Olive	68,000	54,400	136,000	117,700	96,100	68,000	8	3.25	3.60
SL 900	Black	90,000	72,000	180,000	155,800	127,200	90,000	8	3.75	4.10

Safety Factor 5:1



Code	Color Code	MIN. Connection Hardware Thickness Vertical or Choker po	MIN. Connection Hardware Thickness Basket po	MIN. Connection Hardware Effective Contact Width Vertical or Choker po	MIN. Connection Hardware Effective Contact Width Basket po
SL 30	Purple	0,500	0,625	1,000	1,375
SL 40	Black	0,625	0,875	1,000	1,375
SL 60	Green	0,625	1,000	1,375	1,875
SL 90	Yellow	0,750	1,125	1,750	2,375
SL 120	Tan	1,000	1,375	1,875	2,500
SL 140	Red	1,000	1,500	2,000	2,875
SL 170	Orange	1,125	1,750	2,125	3,000
SL 230	Blue	1,250	1,875	2,625	3,750
SL 260	Orange	1,375	1,875	2,875	4,000
SL 320	Grey	1,500	2,125	3,250	4,500
SL 400	Orange	1,625	2,375	3,625	5,000
SL 540	Brown	2,000	2,750	4,000	5,625
SL 680	Olive	2,125	3,000	4,625	6,500
SL 900	Black	2,500	3,500	5,250	7,375

Safety Factor 5:1



⚠ WARNING: The maximum loads shown are applicable for products in new conditions.

⚠ Do not exceed maximum rated capacities.



Eye & Eye Slinger Roundslings





Eye & eye roundslings are made with polyester tubing slid over both legs to create the eyes on each end.

For improved abrasion resistance, we can supply ballistic nylon to create the Eye & Eye roundsling.

(add "B" at the end of the part number)

We can also cover the eyes with ballistic nylon. (For ballistic nylon eyes, add "EB" at the end of the part number)



Code	Color	Working Load Limit lbs.				
		 Vertical	 Choker	 Basket 90°	 Basket 60°	 Basket 45°
SL-30E	Purple	3,000	2,400	6,000	5,200	4,200
SL-40E	Black	4,000	3,200	8,000	6,900	5,600
SL-60E	Green	6,000	4,800	12,000	10,300	8,400
SL-90E	Yellow	9,000	7,200	18,000	15,500	12,600
SL-120E	Tan	12,000	9,600	24,000	20,600	16,800
SL-140E	Red	14,000	11,200	28,000	24,100	19,600
SL-170E	Orange	17,000	13,600	34,000	29,300	23,800
SL-230E	Blue	23,000	18,400	46,000	39,500	32,200
SL-260E	Orange	26,000	20,800	52,000	44,700	36,400
SL-320E	Grey	32,000	25,600	64,000	55,000	44,800
SL-400E	Orange	40,000	32,000	80,000	68,800	56,000
SL-540E	Brown	54,000	43,200	108,000	92,900	75,600
SL-680E	Olive	68,000	54,400	136,000	117,000	95,200
SL-900E	Black	90,000	72,000	180,000	155,000	126,000

Safety Factor 5:1



⚠ WARNING: The maximum loads shown are applicable for products in new conditions.

⚠ Do not exceed maximum rated capacities.

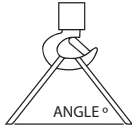

Slinger Bridle Slings ; 1 to 4 Legs

Code	Color	SINGLE 90° Vertical  ANGLE°	DOUBLE LEG BRIDLE  ANGLE°			Alloy Hook TON	Master Link Diameter in.	
			60°	45°	30°		SINGLE	DOUBLE
			SL-30	Purple	3,000		5,200	4,200
SL-40	Black	4,000	6,900	5,600	4,000	2	1/2	3/4
SL-60	Green	6,000	10,300	8,400	6,000	3	3/4	3/4
SL-90	Yellow	9,000	15,500	12,700	9,000	4.5	1	1
SL-120	Tan	12,000	20,700	16,900	12,000	7	1	1
SL-140	Red	14,000	24,200	19,700	14,000	7	1	1 1/4
SL-170	Orange	17,000	29,400	24,000	17,000	11	1 1/4	1 1/4
SL-230	Blue	23,000	39,800	32,500	23,000	15	1 1/2	1 1/2
SL-260	Orange	26,000	45,000	36,700	26,000	15	1 1/2	1 1/2
SL-320	Grey	32,000	55,400	45,200	32,000	22	1 3/4	1 3/4
SL-400	Orange	40,000	69,200	56,500	40,000	22	1 3/4	1 3/4
SL-540	Brown	54,000	93,500	76,300	54,000	30	2	2 1/4
SL-680	Olive	68,000	117,700	96,100	68,000	37	2 1/4	2 1/4
SL-900	Black	90,000	155,850	127,200	90,000	45	2 1/2	2-3/4

Safety Factor 5:1

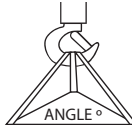
Code	Color	SINGLE 90° Vertical  ANGLE°	THREE LEG BRIDLE  ANGLE°			Alloy Hook TON	Master Link Diameter in.	
			60°	45°	30°		SINGLE	TRIPLE
			SL-30	Purple	3,000		7,700	6,300
SL-40	Black	4,000	10,300	8,400	6,000	2	1/2	1
SL-60	Green	6,000	15,500	12,700	9,000	3	3/4	1
SL-90	Yellow	9,000	23,300	19,000	13,500	4.5	1	1 1/4
SL-120	Tan	12,000	31,100	25,400	18,000	7	1	1 1/2
SL-140	Red	14,000	36,300	29,600	21,000	7	1	1 3/4
SL-170	Orange	17,000	44,100	36,000	25,500	11	1 1/4	1 3/4
SL-230	Blue	23,000	59,700	48,700	34,500	15	1 1/2	2
SL-260	Orange	26,000	67,500	55,100	39,000	15	1 1/2	2 1/4
SL-320	Grey	32,000	83,100	67,800	48,000	22	1 3/4	2 1/4
SL-400	Orange	40,000	103,900	84,800	60,000	22	1 3/4	2 1/2
SL-540	Brown	54,000	140,200	114,500	81,000	30	2	2 3/4
SL-680	Olive	68,000	176,600	144,200	102,000	37	2 1/4	3 1/2
SL-900	Black	90,000	233,800	190,800	135,000	45	2 1/2	4

Safety Factor 5:1

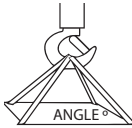
Code	Color	SINGLE 90° Vertical  ANGLE°	FOUR LEG BRIDLE  ANGLE°			Alloy Hook TON	Master Link Diameter in.	
			60°	45°	30°		SINGLE	QUAD.
			SL-30	Purple	3,000		10,300	8,400
SL-40	Black	4,000	13,800	11,300	8,000	2	1/2	1
SL-60	Green	6,000	20,700	16,900	12,000	3	3/4	1
SL-90	Yellow	9,000	31,100	25,400	18,000	4.5	1	1 1/4
SL-120	Tan	12,000	41,500	33,900	24,000	7	1	1 1/2
SL-140	Red	14,000	48,500	39,500	28,000	7	1	1 3/4
SL-170	Orange	17,000	58,800	48,000	34,000	11	1 1/4	1 3/4
SL-230	Blue	23,000	79,600	65,000	46,000	15	1 1/2	2
SL-260	Orange	26,000	90,000	73,500	52,000	15	1 1/2	2 1/4
SL-320	Grey	32,000	110,800	90,400	64,000	22	1 3/4	2 1/4
SL-400	Orange	40,000	138,500	113,100	80,000	22	1 3/4	2 1/2
SL-540	Brown	54,000	187,000	152,700	108,000	30	2	2 3/4
SL-680	Olive	68,000	235,500	192,304	136,000	37	2 1/4	3 1/2
SL-900	Black	90,000	311,700	254,500	180,000	45	2 1/2	4

Safety Factor 5:1

Bridle roundslings are custom made depending on the customer's needs. Hooks or eyes can be installed upon manufacturing. The customer can also supply their own accessories to install on its sling.



⚠ WARNING:
The maximum loads shown are applicable for products in new conditions.
⚠ Do not exceed maximum rated capacities.



Steel Slings

Steel Slings are manufactured from multiple galvanized cables for strength, extreme flexibility and heat resistance, and then covered in a jacket for high abrasion resistance.

Code	Color	Working Load Limit lbs.					Approx. Diameter In.	Approx. Weight / ft. Pounds
		Vertical	Choker	Basket 90°	Basket 60°	Basket 45°		
STL30	BLACK	3,000	2,400	6,000	5,200	4,200	0.75	0.30
STL40	BLACK	4,000	3,200	8,000	6,900	5,600	0.80	0.40
STL60	BLACK	6,000	4,800	12,000	10,300	8,400	0.90	0.45

Safety Factor 5:1

Available Options



Velcro inspection window



Clear inspection window

Inspection area under tag, where wires are easily checked for damage.

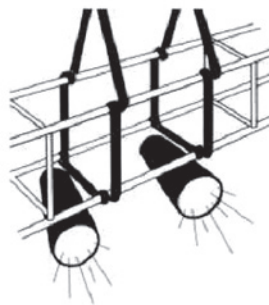

Features

- ✓ High heat resistance 400°F
- ✓ Excellent flexibility
- ✓ High abrasion resistance (longer sling life)
- ✓ Made for stage rigging overhead suspension
- ✓ Optional inspection window to inspect all inside wires

⚠ WARNING: The maximum loads shown are applicable for products in new conditions.

⚠ Do not exceed maximum rated capacities.



Xtreme Cover

Made with covers woven with Dyneema® yarns

Covers woven with Dyneema® yarns provide the ultimate protection for slings, and have the highest resistance to cuts and abrasion. Dyneema® is a synthetic material that protects your load, while protecting your sling at the same time. This sling is specifically designed to be used on loads with sharp edges.

Durability:

Dyneema® fibers are produced from polyethylene and do not contain any aromatic rings nor any amide, hydroxylic or other chemical groups that are susceptible to attack by aggressive agents. The result is a highly crystalline fiber with excellent resistance to water, moisture, most chemicals, UV light and microorganisms.

Made with covers woven with Dyneema® yarns



Red
warning
yarns



Wear pads made with Dyneema®
yarns flipping a mold

High Energy Absorption:

Dyneema® fibers can absorb extremely high amounts of energy. This property is utilized in products for ballistic protection, but this makes the fiber equally suited for products such as cut-resistant gloves, motor helmets and to improve the impact strength of laminated boat hulls. In these applications not only the high tenacity is used but also the high energy absorption.

Dyneema® is a registered trademark.

Contact us for more information.

Item Code: SSX



Roundsling Connection Points

Connection hardware for roundslings should be selected such that the bearing stress value at the connection does not exceed 7,000 lbs/in² during sling loading.

1. Contact Width Applicable

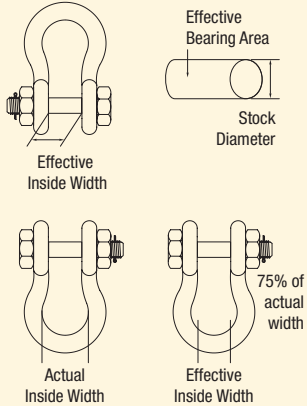

Two Options

- a. **Connection to Flat-bottom Surfaced Hardware** — includes pins, bolts and trunnions. The value of the effective contact width is equal to the opening width or spread of the sling connection area.
- b. **Connection to Round-bottom Surfaced Hardware** — includes links, hooks, or bow end of shackles. The value of the effective contact width is the inside opening width of the hardware multiplied by a factor of .75 equal to the opening width or spread of the sling connection area.

2. Load Bearing Area =

$$\frac{\text{Hardware Thickness or Stock Diameter}}{\text{Effective Contact Width}} \times$$

3. Bearing Stress =

$$\frac{\text{Sling Load Value (in lbs)}}{\text{Load Bearing Area}} \div$$

Example :

A SL400, rated at 40,000 lbs in a Vertical hitch, is connected in a Vertical hitch using the rounded end of a 25 ton shackle that has a stock diameter of 2.25 inches, and an inside width of 5 inches. Is this shackle acceptable ?

Since the bearing surface of the shackle is rounded;

1. **Effective Contact Width**
= 0.75 x Inside Width (5")
= 3.75"
2. **Load Bearing Area**
= Shackle stock Diameter (2.25") x Effective Width (3.75")
= 8.45 in²
3. **Bearing Stress Value**
= Vertical rating (40,000 lbs) ÷ Load Bearing Area (8.45 in²)
= **4,733 lbs/in²**

Because the Bearing Stress Value is less than 7,000 lbs/in², this shackle is acceptable.

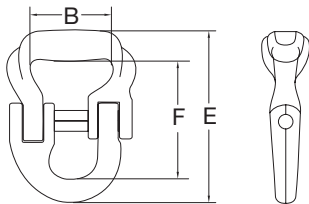

Sling Connectors – Alloy

Code	Material Width in.	Diameter to Connect Lok-A-Loy size in.	Working Load Limit lbs.	Weight / ea. lbs.	Dimensions in.		
					B	E	F
S237-002038	2	3/8	5,000	1.14	2.00	4.20	2.92
S237-003034	3	3/4	15,000	4.75	2.75	6.49	4.46

Safety Factor 5:1



Steel Triangles (zinc plated*)

Code	Working Load Limit lbs.	Weight approx. lbs.	Dimensions in.						
			A	B	C	E	G	I	T
TAC2-NW	6,600	1	2 5/16	2 1/8	3 3/4	3 7/8	1 3/4	1	1/2
TAC3-NW	8,900	1.6	3 5/16	3 1/16	5	5 3/16	2	1 1/4	1/2
TAC4-NW	11,600	2.7	3 7/8	4 5/16	6 5/8	6 7/16	2	1 5/8	1/2
TAC5-NW	14,000	3.5	4 15/16	5 3/16	7 15/16	7 7/8	2 1/2	2	1/2
TAC6-NW	16,800	5.3	5 9/16	6 1/8	9 1/4	9	2 3/4	2 5/16	1/2
TAC8-NW	22,400	12	7 3/16	8 1/4	12	11 7/16	3 5/8	2 7/8	3/4
TAC10	28,000	17	8 1/4	10 1/8	14 1/8	13 1/4	4 7/8	3 5/8	3/4
TAC12	32,000	19	8	12 3/8	16 7/16	13 13/16	5	4 1/16	3/4

Safety Factor 5:1

* Better corrosion resistance

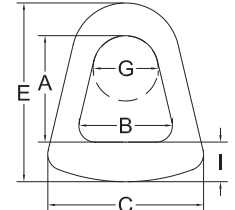

Steel Chokers (zinc plated*)

Code	Working Load Limit lbs.	Weight approx. lbs.	Dimensions in.						
			A	B	C	E	G	I	T
CAC2-NW	6,600	2	2 1/4	2 1/8	5 1/2	6	2	1 1/16	1/2
CAC3-NW	8,900	2.9	3 3/16	3 1/8	7	7 1/2	2	1 3/16	1/2
CAC4-NW	11,600	6	3 1/2	4 1/8	9 9/16	9 5/16	2 1/2	1 13/16	1/2
CAC5	14,000	7	4 7/16	5 1/8	11 5/8	10 9/16	2 3/4	2 1/16	1/2
CAC6-NW	16,800	9.8	4 9/16	6 1/8	12 3/4	12	2 7/8	2 11/16	1/2
CAC8	22,400	24	6 7/16	8 1/8	16 1/2	14 7/16	5	2 13/16	3/4
CAC10	28,000	28	7 5/8	10 1/4	18 3/4	16 1/2	5 1/8	3 1/2	3/4
CAC12	32,000	40	9 3/4	12 1/8	22 5/8	19 1/4	5 1/2	4 1/4	3/4

Safety Factor 5:1

* Better corrosion resistance

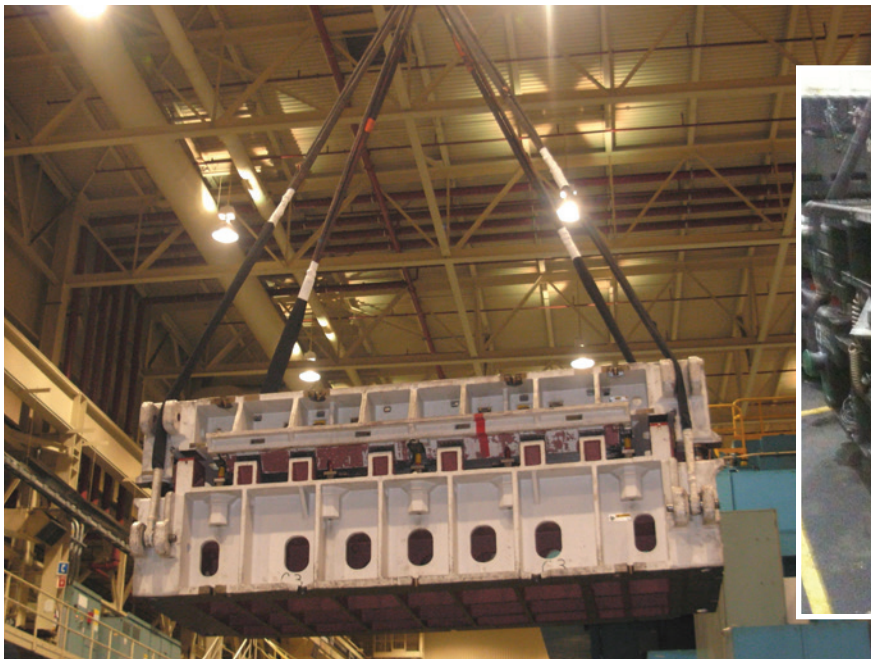
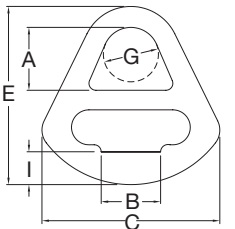
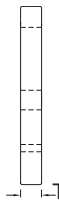



Chain Slings

SINGLE LEG

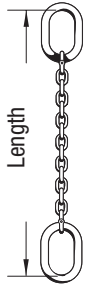

S00



S0F



S0G



S0S



SGS



SSS

DOUBLE LEGS

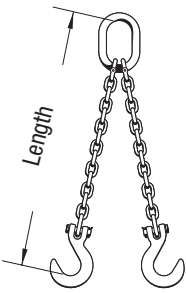

D0F

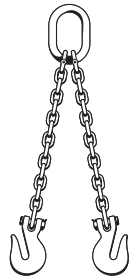

D0G

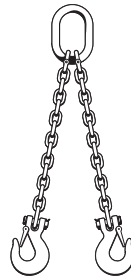

D0S

THREE LEGS

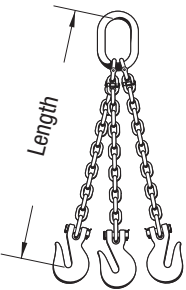

T0G

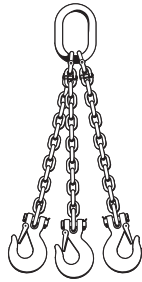

T0S

FOUR LEGS

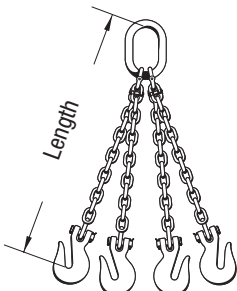

Q0G

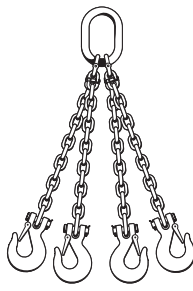

Q0S

Adjustable chain slings also available



TYPE A

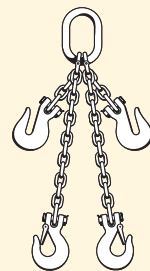

TYPE B

Ben-Mor

OFFERS DIFFERENT CHAIN
SLINGS SERVICES :

- INSPECTION
- CLEANING
- CERTIFICATION

**CERTIFIED
ISO 9001**



Chain Sling

Do a comparison with buying your chain slings from Ben-Mor and competition.

	BEN-MOR [®]	COMPETITION
1 Proof test all NEW chain slings to meet requirements of ASME B30.9?	<input checked="" type="checkbox"/>	<input type="checkbox"/>
2 Have ISO certification?	<input checked="" type="checkbox"/>	<input type="checkbox"/>
3 Have liability insurance for manufacturing lifting slings?	<input checked="" type="checkbox"/>	<input type="checkbox"/>
4 Provide registration of the product, so you can be notified when the sling is due for inspection and recertification?	<input checked="" type="checkbox"/>	<input type="checkbox"/>
5 Provide free access to sling history online?	<input checked="" type="checkbox"/>	<input type="checkbox"/>



Environmental considerations

WARNING

Acidic chemicals and atmospheres

Alloy chain, Grade 80 and Grade 100 components must not be used in acidic conditions.

Extreme temperature conditions

The environmental temperature affects the Working Load Limit of Grade 80 and Grade 100 chain slings as shown in the chart beside.

Grade 80 and Grade 100 alloy chain slings must not be used at temperatures outside the ranges in the chart beside.

Use

- Never make knots with a lifting sling ;
- Do not exceed specified Working Load Limit (WLL).

Temperature of Chain (°F)	Working Load Limit While at Temperature ¹	Permanent Reduction in Working Load Limit ²
< -40	not-recommended	none
-40 to 400	100%	none
400 to 600	90%	none
600 to 750	75%	10%
> 750	not-recommended	contact Ben-Mor

¹ While chain is at temperature shown in first column.

² When chain is used at room temperature after having been subjected to temperatures shown in first column.

Product code

D	O	S	80	012	003-03
Number of Legs S = 1, D = 2 T = 3, Q = 4	1ST End	2ND End	Adjustable Type A = Type A, B = Type B	Grade 100 = Grade 100, 80 = Grade 80	Diameter (inches)
				Length (feet)	Length (inches)



Grade 100

Chain Slings Certified – Grade 100

Chain Diameter in.	Working Load Limit (lbs.)					GRADE 100 Oblong* Master Link	
	Single Leg 90°	Double Legs 60°	Double Legs 45°	Double Legs 30°	Single	Double	
9/32	4,300	7,400	6,100	4,300	A342-012G100BM	A342-058G100BM	
5/16	5,700	9,900	8,100	5,700	A342-012G100BM	A342-058G100BM	
3/8	8,800	15,200	12,400	8,800	A342-034G100BM	A342-078G100BM	
1/2	15,000	26,000	21,200	15,000	A342-001G100BM	A342-001G100BM	
5/8	22,600	39,100	32,000	22,600	A342-001G100BM	A342-114G100BM	
3/4	35,300	61,100	49,900	35,300	A342-114G100BM	A342-112G100BM	
7/8	42,700	74,000	60,400	42,700	A342-112G100BM	A342-134G100BM	

Safety Factor 4:1

* See dimensions on page 79

Chain Diameter in.	Working Load Limit (lbs.)			GRADE 100 Oblong* Assemblies
	Three/Four Legs 60°	Three/Four Legs 45°	Three/Four Legs 30°	
9/32	11,200	9,100	6,400	SUB-034G100BM
5/16	14,800	12,100	8,500	SUB-001G100BM
3/8	22,900	18,700	13,200	SUB-001G100BM
1/2	39,000	31,800	22,500	SUB-114G100BM
5/8	58,700	47,900	33,900	SUB-112G100BM
3/4	91,700	74,900	53,000	SUB-002G100BM
7/8	110,900	90,600	64,000	SUB-214G100BM

Safety Factor 4:1

* See dimensions on page 79

Meet NACM and ASTM 973 standards.

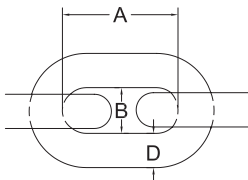

Alloy Lifting Chain Grade 100 (self colored)

Code	Diameter in.	Working Load Limit lbs.	Weight / ea. lbs.	Dimensions in.		
				A	B	D
CH100SC-932	9/32	4,300	77	0.87	0.41	0.28
CH100SC-516	5/16	5,700	112	1.01	0.48	0.34
CH100SC-038	3/8	8,800	152	1.23	0.56	0.40
CH100SC-012	1/2	15,000	279	1.57	0.75	0.53
CH100SC-058	5/8	22,600	374	1.93	0.87	0.63
CH100SC-034	3/4	35,300	600	2.42	1.13	0.82
CH100SC-078	7/8	42,700	793	2.66	1.26	0.91
CH100SC-001	1	59,700	1,010	3.09	1.42	1.03

Safety Factor 4:1

! WARNING: The maximum loads shown are applicable for products in new conditions.

! Do not exceed maximum rated capacities.



Master Oblong Links (Gr. 100 - alloy steel, quenched and tempered)

Code	Working Load Limit lbs.	Weight / ea. lbs.	Dimensions in.		
			A	B	D
A342-012G100BM	7,400	0.80	5	2 1/2	1/2
A342-058G100BM	8,800	1.54	6	3	5/8
A342-034G100BM	12,300	2.05	5 1/2	2 3/4	3/4
A342-078G100BM	15,300	3.30	6 1/4	3 1/2	7/8
A342-001G100BM	26,000	4.62	7	3 1/2	1
A342-114G100BM	39,000	9.33	8 3/4	4 3/8	1 1/4
A342-112G100BM	61,000	15.78	10 1/2	5 1/4	1 1/2
A342-134G100BM	84,800	25.41	12	6	1 3/4
A342-002G100BM	102,500	37.24	14	7	2
A342-214G100BM	143,000	53.90	16	8	2 1/4
A342-212G100BM	160,000	67.98	16	8	2 1/2
A342-234G100BM	216,900	86.90	16	9 1/2	2 3/4

Safety Factor 5:1

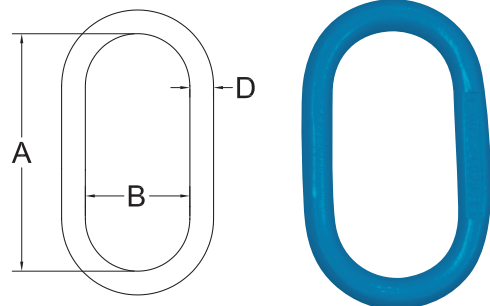

Stamped with BM identification code, size, grade and traceability code. Meet ASTM standard.

Welded Master Link Assemblies (Gr. 100 - alloy steel, quenched and tempered)

Code	Working Load Limit lbs.	Weight / ea. lbs.	A1	A2	B1	B2	D1	D2
SUB-012G100	7,400	1.0	5	1 1/8	2 1/2	5/8	1/2	11/32
SUB-034G100	12,300	3.41	5 1/2	3 7/8	2 3/4	1 1/2	3/4	9/16
SUB-001G100	26,000	7.24	7	4	3 1/2	2 3/8	1	11/16
SUB-114G100	39,000	15.80	8 3/4	4	4 3/8	2 3/8	1 1/4	7/8
SUB-112G100	61,000	28.40	10 1/2	7	5 1/4	4	1 1/2	1 3/16
SUB-134G100	84,800	46.75	12	7	6	4	1 3/4	1 1/4
SUB-002G100	102,500	66.75	14	7	7	4	2	1 1/2
SUB-214G100	160,000	141.68	16	13	8	7	2 1/2	2
SUB-234G100	216,900	195.80	16	16	9 1/2	8	2 3/4	2 1/4

Safety Factor 4:1

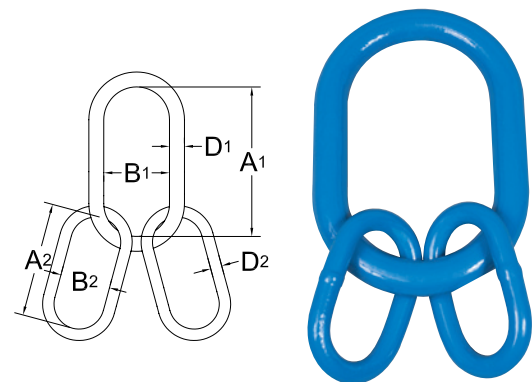

Stamped with BM identification code, size, grade and traceability code. Meet ASTM standard.

Safety Latch Kit (Gr.100, for sling hooks)

Code	For Chain Size in.	Weight / ea. lbs.
LATCHGRI007/32BM	7/32	0,07
LATCHGRI009/32BM	9/32	0,09
LATCHGRI003/8BM	3/8	0,14
LATCHGRI001/2BM	1/2	0,30
LATCHGRI005/8BM	5/8	0,33
LATCHGRI003/4BM	3/4	0,51
LATCHGRI007/8BM	7/8	0,72
LATCHGRI001BM	1	0,90
LATCHGRI0011/4BM	1 1/4	1,44

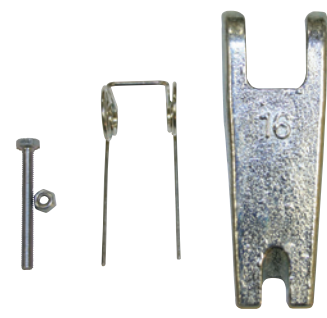

Latch Kit Trigger (Gr.100, for self locking hooks)

Code	For Chain Size in.	Weight / ea. lbs.
LATCHTRG732	7/32	0,04
LATCHTRG932	9/32	0,05
LATCHTRG038	3/8	0,052
LATCHTRG012	1/2	0,104
LATCHTRG058	5/8	0,2



⚠ WARNING: The maximum loads shown are applicable for products in new conditions.

⚠ Do not exceed maximum rated capacities.



Clevis Sling Hooks with latch* (Gr. 100 - Alloy steel, quenched and tempered)

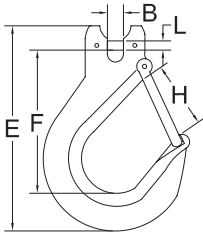

Stamped with BM identification code, size, grade and traceability code. Meet ASTM-952 standard.

Code	For Chain Size in.	Working Load Limit lbs.	Weight / ea. lbs.	Dimensions in.				
				B	E	F	H	L
CSH100L-732BM	7/32	3,100	0.60	0.25	3.80	2.71	2.80	1.06
CSH100L-932BM	9/32 - 5/16	5,700	1.35	0.35	5.20	3.72	1.26	0.38
CSH100L-038BM	3/8	8,800	2.47	0.45	6.08	4.29	1.53	0.49
CSH100L-012BM	1/2	15,000	4.52	0.57	7.52	5.31	1.89	0.63
CSH100L-058BM	5/8	22,600	7.50	0.69	8.74	6.10	2.16	0.79
CSH100L-034BM	3/4	35,300	13.80	0.91	10.12	7.20	2.40	0.94
CSH100L-078BM	7/8	42,700	19.32	0.96	11.80	8.35	0.99	0.29

Safety Factor 4:1

* Replacement safety latch kit available. See on page 79

Eye Foundry Hooks (Gr. 100 - Alloy steel, quenched and tempered)

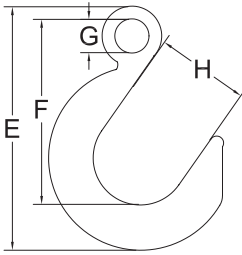

Stamped with BM identification code, size, grade and traceability code. Meet ASTM-952 standard.

Code	For Chain Size in.	Working Load Limit lbs.	Weight / ea. lbs.	Dimensions in.			
				E	F	G	H
EFH100-932	9/32 - 5/16	5,700	2.49	6.58	4.82	0.71	2.52
EFH100-038	3/8	9,800	4.39	7.92	5.87	0.86	3.07
EFH100-012	1/2	15,000	7.30	9.39	6.95	1.06	3.50
EFH100-058	5/8	22,600	11.69	10.99	8.07	1.26	3.94
EFH100-034	3/4	35,300	16.98	12.79	9.33	1.49	4.53

Safety Factor 4:1

Eye Self Locking Hooks* (Gr. 100 - Alloy steel, quenched and tempered)

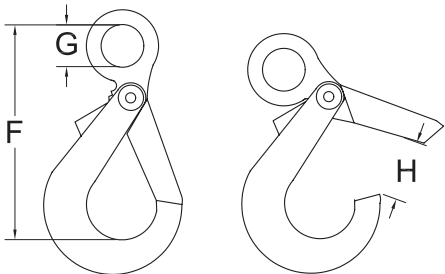

Stamped with BM identification code, size, grade and traceability code. Meet ASTM-952 standard.

Code	For Chain Size in.	Working Load Limit lbs.	Weight / ea. lbs.	Dimensions in.		
				F	G	H
S316-732G100BM	7/32	3,100	1.17	4.33	0.83	1.35
S316-014G100BM	1/4 - 5/16	5,700	1.96	5.35	0.98	1.59
S316-038G100BM	3/8	8,800	3.48	6.63	1.26	2.69
S316-012G100BM	1/2	15,000	6.97	8.07	1.56	3.38
S316-058G100BM	5/8	22,600	13.34	9.90	2.05	3.90

Safety Factor 4:1

* Replacement latch kit trigger available. See on page 79

Clevis Self Locking Hooks* (Gr. 100 - Alloy steel, quenched and tempered)

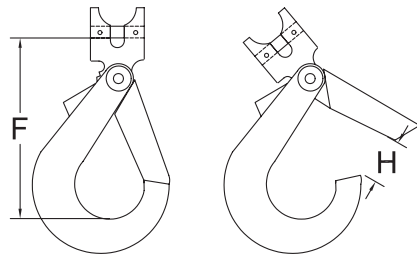

Stamped with BM identification code, size, grade and traceability code. Meet ASTM-952 standard.

Code	For Chain Size in.	Working Load Limit lbs.	Weight / ea. lbs.	Dimensions in.	
				F	H
S317-732G100BM	7/32	3,100	1.10	3.70	1.35
S317-014G100BM	1/4 - 5/16	5,700	2.12	4.84	1.59
S317-038G100BM	3/8	8,800	3.53	5.65	2.69
S317-012G100BM	1/2	15,000	6.90	7.07	3.38
S317-058G100BM	5/8	22,600	12.79	8.54	3.90

Safety Factor 4:1

* Replacement latch kit trigger available. See on page 79

Swivel Self Locking Hooks* (Gr. 100 - Alloy steel, quenched and tempered)

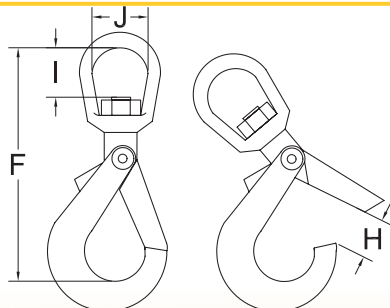

Stamped with BM identification code, size, grade and traceability code. Meet ASTM-952 standard.

Code	For Chain Size in.	Working Load Limit lbs.	Weight / ea. lbs.	Dimensions in.			
				F	H	I	J
S326-732G100BM	7/32	3,100	1.76	6.30	1.35	0.90	0.51
S326-014G100BM	1/4 - 5/16	5,700	7.13	7.12	1.59	1.10	0.51
S326-038G100BM	3/8	8,800	8.58	8.58	2.69	1.38	0.63
S326-012G100BM	1/2	15,000	10.59	10.59	3.38	1.57	0.78
S326-058G100BM	5/8	22,600	12.56	12.56	3.90	2.20	0.94

Safety Factor 4:1

* Replacement latch kit trigger available. See on page 79



Clevis Cradle Grab Hooks (Gr. 100, alloy steel, quenched and tempered)

Code	For Chain Size in.	Working Load Limit lbs.	Weight / ea. lbs.	Dimensions in.			
				E	F	H	L
CGH100-732BM	7/32	3,100	0.44	2.79	1.45	0.29	0.29
CGH100-932BM	9/32 - 5/16	5,700	0.75	3.60	2.00	0.37	0.38
CGH100-038BM	3/8	8,800	1.80	5.02	3.02	0.47	0.49
CGH100-012BM	1/2	15,000	3.85	6.42	3.65	0.59	0.63
CGH100-058BM	5/8	22,600	5.39	7.20	4.45	0.69	0.79
CGH100-034BM	3/4	35,300	10.38	8.94	5.50	0.94	0.94
CGH100-078BM	7/8	42,700	18.04	10.25	6.55	1.06	1.06

Safety Factor 4:1

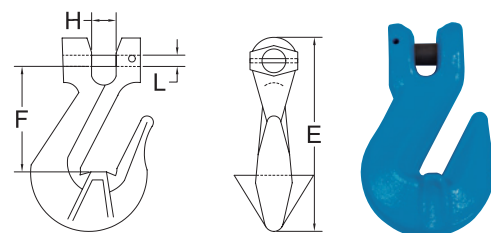

Stamped with BM identification code, size, grade and traceability code. Meet ASTM-952 standard.

Eye Sling Hooks with latch* (Gr. 100, alloy steel, quenched and tempered)

Code	For Chain Size in.	Working Load Limit lbs.	Weight / ea. lbs.	Dimensions in.				
				E	F	G	H	T
ESH100L-732BM	7/32	3,100	0.73	4.55	3.33	0.79	0.98	0.65
ESH100L-932BM	9/32 - 5/16	5,700	1.23	5.66	4.17	0.98	1.26	0.75
ESH100L-038BM	3/8	8,800	2.65	7.09	5.16	1.34	1.57	1.02
ESH100L-012BM	1/2	15,000	5.18	8.86	6.46	1.69	1.89	1.30
ESH100L-058BM	5/8	22,600	8.20	10.14	7.18	1.97	2.16	1.57
ESH100L-034BM	3/4	35,300	13.12	11.26	8.07	2.16	2.40	1.89
ESH100L-078BM	7/8	42,700	17.35	12.40	8.86	2.36	2.80	1.97

Safety Factor 4:1

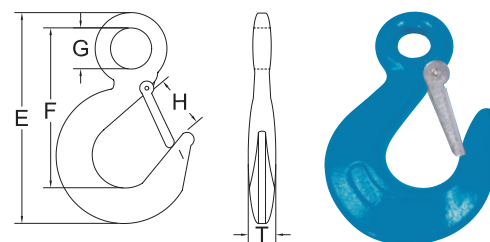

Stamped with BM identification code, size, grade and traceability code. Meet ASTM-952 standard.

* Replacement latch kit available. See on page 79 Latch kit available.

Hammerlock Type Connecting Links (Gr. 100, alloy steel, quenched and tempered)

Code	For chain diameter in.	Working Load Limit lbs.	Weight / ea. lbs.	Dimensions in.	
				A	B
A337-732G100BM	7/32	3,100	0.22	1.75	0.55
A337-932G100BM	9/32	4,300	0.35	2.35	0.79
A337-516G100BM	5/16	5,700	0.48	4.42	0.73
A337-038G100BM	3/8	8,800	0.99	2.83	0.90
A337-012G100BM	1/2	15,000	2.53	3.50	1.08
A337-058G100BM	5/8	22,600	3.85	4.05	1.32
A337-034G100BM	3/4	35,300	5.94	4.56	1.65
A337-078G100BM	7/8	42,700	8.84	5.31	1.89

Safety Factor 4:1

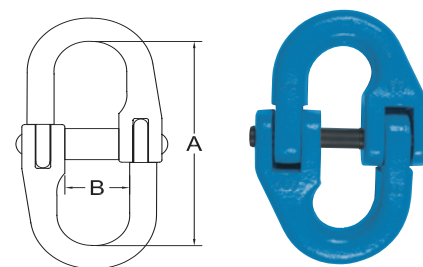

Stamped with BM identification code, size, grade and traceability code. Meet ASTM-952 standard.

Eye Cradle Grab Hooks (Gr. 100, alloy steel, quenched and tempered)

Code	For Chain Size in.	Working Load Limit lbs.	Weight / ea. lbs.	Dimensions in.		
				E	F	G
EGH100-732BM	7/32	3,100	0.44	2.79	2.42	0.57
EGH100-932BM	9/32 - 5/16	5,700	0.62	3.60	3.10	0.71
EGH100-038BM	3/8	8,800	1.58	5.02	4.40	0.53
EGH100-012BM	1/2	15,000	3.52	6.42	5.62	0.65
EGH100-058BM	5/8	22,600	5.39	7.20	6.20	0.75
EGH100-034BM	3/4	35,300	10.38	8.94	7.76	0.95
EGH100-078BM	7/8	42,700	18.04	10.25	8.95	1.06

Safety Factor 4:1

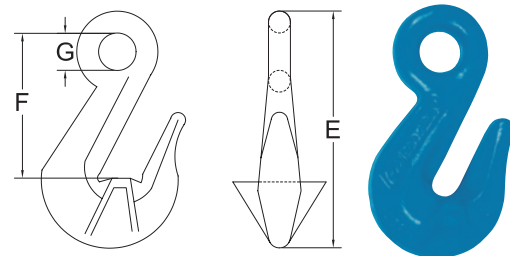

Stamped with BM identification code, size, grade and traceability code. Meet ASTM-952 standard.



Grade 80

Chain Slings, Certified – Grade 80

Chain Diameter in.	Working Load Limit (lbs.)					Oblong* Master Link	
	Single Leg 90°	Double Legs 60°	Double Legs 45°	Double Legs 30°	SINGLE	DOUBLE	
7/32	2,100	3,600	2,900	2,100	A342-012BM	A342-012BM	
9/32	3,500	6,100	4,900	3,500	A342-012BM	A342-058BM	
5/16	4,500	7,700	6,300	4,500	A342-012BM	A342-058BM	
3/8	7,100	12,300	10,000	7,100	A342-034BM	A342-034BM	
1/2	12,000	20,800	17,000	12,000	A342-001BM	A342-001BM	
5/8	18,100	31,300	25,600	18,100	A342-001BM	A342-114BM	
3/4	28,300	49,000	40,000	28,300	A342-114BM	A342-112BM	
7/8	34,200	59,200	48,400	34,200	A342-112BM	A342-134BM	
1	47,700	82,600	67,400	47,700	A342-134BM	A342-002BM	
1 1/4	72,300	125,200	102,000	72,300	A342-002BM	A342-214BM	

Safety Factor 4:1

*See dimensions on page 83

Chain Diameter in.	Working Load Limit (lbs.)			Oblong* Assemblies
	Three/Four Legs 60°	Three/Four Legs 45°	Three/Four Legs 30°	
7/32	5,400	4,400	3,100	SUB-012
9/32	9,100	7,400	5,200	SUB-034
5/16	11,600	9,500	6,700	SUB-001
3/8	18,400	15,100	10,600	SUB-001
1/2	31,200	25,500	18,000	SUB-114
5/8	47,000	38,400	27,100	SUB-112
3/4	73,500	60,000	42,400	SUB-134
7/8	88,900	72,500	51,300	SUB-002
1	123,900	101,200	71,500	SUB-214
1 1/4	187,800	153,400	108,400	SUB-234

Safety Factor 4:1

*See dimensions on page 83

Meet NACM and ASTM 391 standards.

Alloy Lifting Chain (Gr. 80 - Black Oxide)

Grade 80 alloy chain is used for overhead lifting.

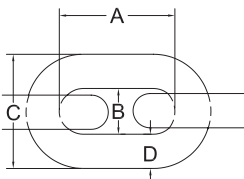

Code	Diameter in.	Working Load Limit lbs.	Weight / 100 ft. lbs.	Dimensions in.			
				A	B Min	C Max	D
CH80SC-732	7/32	2,100	47.0	.680	.319	.787	.217
CH80SC-932	9/32	3,500	73.8	.826	.375	.992	.276
CH80SC-516	5/16	4,500	93.9	.945	.430	1.134	.315
CH80SC-038	3/8	7,100	147.5	1.181	.531	1.417	.394
CH80SC-012	1/2	12,000	254.8	1.535	.689	1.843	.512
CH80SC-058	5/8	18,100	383.0	1.890	.846	2.268	.630
CH80SC-034	3/4	28,300	578.0	2.440	1.008	2.776	.787
CH80SC-078	7/8	34,200	732.4	2.598	1.161	3.118	.866
CH80SC-001	1	47,700	1,021.4	3.071	1.378	3.685	1.024
CH80SC-114	1 1/4	72,300	1,545.5	3.780	1.701	4.528	1.260

Safety Factor 4:1

⚠ WARNING: The maximum loads shown are applicable for products in new conditions.

⚠ Do not exceed maximum rated capacities.



Master Oblong Links (Gr. 80 - alloy steel, quenched and tempered)

Code	Working Load Limit lbs.	Weight / ea. lbs.	Dimensions in.		
			A	B	D
A342-012BM	7,000	0.89	5	2 1/2	1/2
A342-058BM	9,000	1.63	6	3	5/8
A342-034BM	12,300	2.25	5 1/2	2 3/4	3/4
A342-001BM	24,360	5.00	7	3 1/2	1
A342-114BM	39,130	9.75	8 3/4	4 3/8	1 1/4
A342-112BM	54,300	17.12	10 1/2	5 1/4	1 1/2
A342-134BM	84,900	26.12	12	6	1 3/4
A342-002BM	102,600	41.12	14	7	2
A342-214BM	143,100	54.80	16	8	2 1/4
A342-212BM	160,000	71.60	16	8	2 1/2
A342-234BM	216,900	87.70	16	9 1/2	2 3/4

Safety Factor 5:1

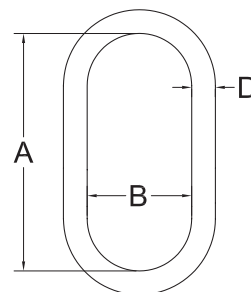

Stamped with BM identification code, size, grade and traceability code. Meet ASTM standard.

Welded Master Link Assemblies (Gr. 80 - alloy steel, quenched and tempered)

Code	Working Load Limit lbs. (at 60°)	Weight / ea. lbs.	A1	A2	B1	B2	D1	D2
SUB-012	5,460	1.0	5	1 1/8	2 1/2	5/8	1/2	11/32
SUB-034	9,100	2.6	5 1/2	3 7/8	2 3/4	1 1/2	3/4	9/16
SUB-001	18,400	6.1	7	4	3 1/2	2 3/8	1	11/16
SUB-114	31,200	13.3	8 3/4	4	4 3/8	2 3/8	1 1/4	7/8
SUB-112	47,000	24.3	10 1/2	7	5 1/4	4	1 1/2	1 3/16
SUB-134	73,500	36.1	12	7	6	4	1 3/4	1 1/4
SUB-002	88,900	57.4	14	7	7	4	2	1 1/2
SUB-214	123,900	83.9	16	13	8	7	2 1/2	2
SUB-234	187,800	129.7	16	16	9 1/2	8	2 3/4	2 1/4

Safety Factor 4:1

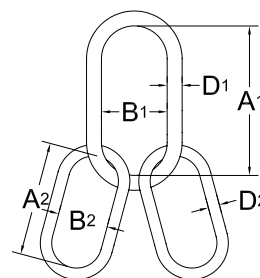

Stamped with BM identification code, size, grade and traceability code. Meet ASTM standard.

Safety Latch Kit (Gr.80, for sling hooks)

Code	For Chain Size in.	Weight / ea. lbs.
LATCHGR807/32	7/32	0,07
LATCHGR809/32	9/32	0,09
LATCHGR803/8	3/8	0,14
LATCHGR801/2	1/2	0,30
LATCHGR805/8	5/8	0,33

Code	For Chain Size in.	Weight / ea. lbs.
LATCHGR803/4	3/4	0,51
LATCHGR807/8	7/8	0,72
LATCHGR801	1	0,90
LATCHGR8011/4	1 1/4	1,44



Weldless Master Rings (carbon steel, quenched and tempered)

Code	Working Load Limit lbs.	Weight / ea. lbs.	Dimensions in.	
			A	D
S643-078004BM	7,200	2.7	4	7/8
S643-078512BM	5,600	3.4	5 1/2	7/8
S643-001004BM	10,800	3.5	4	1
S643-118006BM	10,400	6.5	6	1 1/8
S643-114005BM	17,000	7.0	5	1 1/4
S643-138006BM	19,000	10.6	6	1 3/8

Safety Factor 6:1

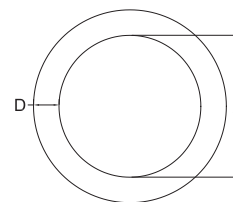

Stamped with BM identification code, size, grade and traceability code. Meet ASTM standard.

Federal Specification : RR-C-271D

Pear Shape Weldless Links (Hot dip galvanized, alloy steel, quenched and tempered)

Code	Working Load Limit lbs.	Weight / ea. lbs.	Dimensions in.	
			A	D
A341-038BM	3,600	0.22	2 1/4	3/8
A341-012BM	7,000	0.55	3	1/2
A341-058BM	9,000	1.10	3 3/4	5/8
A341-034BM	12,300	1.76	4 1/2	3/4
A341-078BM	14,000	3.08	5 1/4	7/8
A341-001BM	24,360	4.18	6	1
A341-114BM	36,000	8.26	7 3/4	1 1/4
A341-138BM	43,000	11.28	8 1/4	1 3/8

Safety Factor 5:1

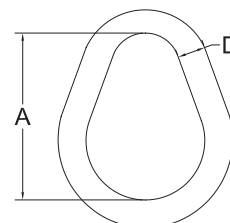

Stamped with BM identification code, size, grade and traceability code. Meet ASTM standard.

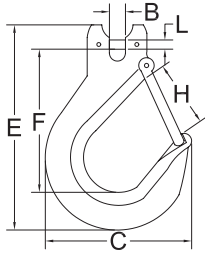

Stamped with BM identification code, size, grade and traceability code. Meet ASTM-952 standard.

Clevis Sling Hooks with latch* (Gr. 80 - Alloy steel, quenched and tempered)

Code	For Chain Size in.	Working Load Limit lbs.	Weight / ea. lbs.	Dimensions in.					
				B	C	E	F	H	L
CSH80L-932	9/32 - 5/16	4,500	0.6	.35	3.52	5.34	3.30	1.00	.39
CSH80L-038	3/8	7,100	1.9	.47	4.36	6.27	4.05	1.32	.49
CSH80L-012	1/2	12,000	4.3	.64	5.12	7.55	4.91	1.55	.63
CSH80L-058	5/8	18,100	5.2	.75	6.28	9.69	6.08	2.03	.75
CSH80L-034	3/4	28,300	11.4	.875	7.83	11.69	7.34	2.50	.91

Safety Factor 4:1

* Replacement safety latch kit available. See on page 83

Eye Foundry Hooks (Gr. 80 - Alloy steel, quenched and tempered)

Code	For Chain Size in.	Working Load Limit lbs.	Weight / ea. lbs.	Dimensions in.				
				C	E	F	G	H
EFH80-932	9/32 - 5/16	4,500	2.4	4.75	6.45	4.75	.63	2.50
EFH80-038	3/8	7,100	4.5	5.75	7.88	5.75	.75	3.00
EFH80-012	1/2	12,000	7.1	6.75	9.38	6.88	1.00	3.50
EFH80-058	5/8	18,100	11.6	7.81	10.97	8.06	1.25	4.00
EFH80-034	3/4	28,300	20.0	9.13	12.81	9.25	1.50	4.50
EFH80-078	7/8	34,200	26.0	10.14	14.23	10.38	1.75	5.00
EFH80-001	1	47,700	36.8	11.13	15.84	11.56	2.13	5.50
EFH80-114	1 1/4	72,300	58.4	12.84	18.03	12.88	2.38	6.00

Safety Factor 4:1

Stamped with BM identification code, size, grade and traceability code. Meet ASTM-952 standard.

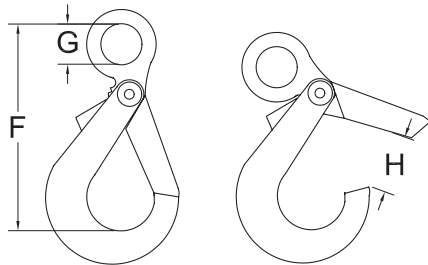

Stamped with BM identification code, size, grade and traceability code. Meet ASTM-952 standard.

Eye Self Locking Hooks* (Gr. 80 - Alloy steel, quenched and tempered)

Code	For Chain Size in.	Working Load Limit lbs.	Weight / ea. lbs.	Dimensions in.		
				F	G	H
S316-732	7/32	2,500	0.9	4.33	0.83	1.14
S316-014	1/4 - 5/16	4,500	1.8	5.35	0.98	1.38
S316-038	3/8	7,100	3.2	6.57	1.26	1.77
S316-012	1/2	12,000	6.0	8.15	1.56	2.13
S316-058	5/8	18,100	12.8	9.92	2.05	2.44

Safety Factor 4:1

* Replacement latch kit trigger available. See on page 79

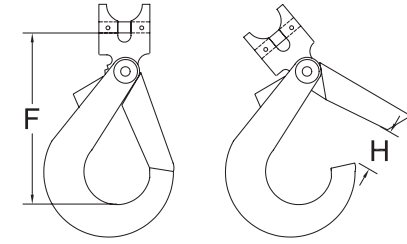

Stamped with BM identification code, size, grade and traceability code. Meet ASTM-952 standard.

Clevis Self Locking Hooks* (Gr. 80 - Alloy steel, quenched and tempered)

Code	For Chain Size in.	Working Load Limit lbs.	Weight / ea. lbs.	Dimensions in.	
				F	H
S317-732	7/32	2,500	.77	3.94	1.10
S317-014	1/4 - 5/16	4,500	1.79	4.69	1.34
S317-038	3/8	7,100	3.19	5.63	1.77
S317-012	1/2	12,000	6.75	7.05	2.13
S317-058	5/8	18,100	11.94	8.35	2.48

Safety Factor 4:1

* Replacement latch kit trigger available. See on page 79

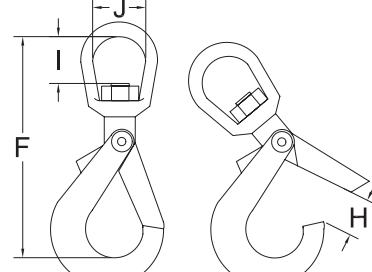

Stamped with BM identification code, size, grade and traceability code. Meet ASTM-952 standard.

Swivel Self Locking Hooks* (Gr. 80 - Alloy steel, quenched and tempered)

Code	For Chain Size in.	Working Load Limit lbs.	Weight / ea. lbs.	Dimensions in.			
				F	H	I	J
S326-732	7/32	2,500	1.26	4.48	1.14	0.67	1.26
S326-014	1/4 - 5/16	4,500	2.62	5.94	1.38	0.79	1.42
S326-038	3/8	7,100	4.70	6.75	1.77	1.06	1.63
S326-012	1/2	12,000	8.64	8.23	2.09	1.70	1.81
S326-058	5/8	18,100	17.00	10.43	2.44	1.56	2.36

Safety Factor 4:1

* Replacement latch kit trigger available. See on page 79



Clevis Cradle Grab Hooks (Gr. 80, alloy steel, quenched and tempered)

Code	For Chain Size in.	Working Load Limit lbs.	Weight / ea. lbs.	Dimensions in.				
				C	E	F	H	L
CGH80-932	9/32 - 5/16	4,500	.46	1.95	3.47	2.06	.38	.35
CGH80-038	3/8	7,100	1.23	2.80	4.85	2.83	.54	.50
CGH80-012	1/2	12,000	2.40	3.69	6.45	3.67	.59	.63
CGH80-058	5/8	18,100	4.17	4.16	6.75	4.00	.74	.78
CGH80-034	3/4	28,300	9.56	5.23	9.08	5.50	.87	.90

Safety Factor 4:1

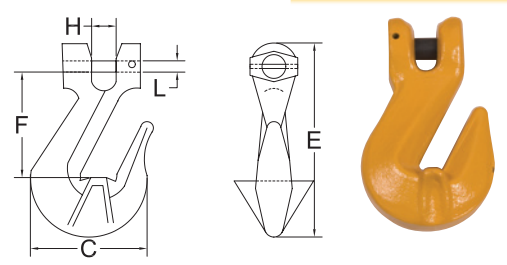

Stamped with BM identification code, size, grade and traceability code. Meet ASTM-952 standard.

Eye Sling Hooks with latch (Gr. 80, alloy steel, quenched and tempered)

Code	For Chain Size in.	Working Load Limit lbs.	Weight / ea. lbs.	Dimensions in.					
				C	E	F	G	H	T
ESH80L-732	7/32	2,100	.7	3.31	4.30	3.06	.75	1.25	.78
ESH80L-932	9/32 - 5/16	4,500	1.1	3.50	5.25	3.75	.75	1.19	.73
ESH80L-038	3/8	7,100	1.9	4.34	6.64	4.78	.94	1.44	.95
ESH80L-012	1/2	12,000	4.5	5.50	8.16	5.69	1.13	1.78	1.17
ESH80L-058	5/8	18,100	7.3	6.34	9.66	6.50	1.31	2.03	1.44
ESH80L-034	3/4	28,300	11.4	7.83	11.38	7.81	1.50	2.50	1.69
ESH80L-078	7/8	34,200	18.1	8.59	12.72	8.75	1.69	2.78	1.94
ESH80L-001	1	47,700	22.6	9.59	14.23	9.88	1.88	3.13	2.14
ESH80L-114	1 1/4	72,000	36.0	11.56	17.00	11.50	2.31	3.88	2.62

Safety Factor 4:1

* Replacement safety latch kit available. See on page 83. Latch kit available.

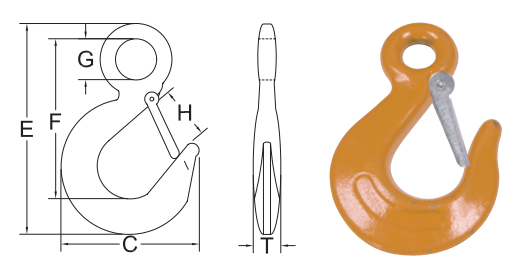

Stamped with BM identification code, size, grade and traceability code. Meet ASTM-952 standard.

Hammerlock Type Connecting Links (Gr. 80, alloy steel, quenched and tempered)

Code	For chain diameter in.	Working Load Limit lbs.	Weight / ea. lbs.	Dimensions in.	
				A	B
A337-732	7/32	2,100	0.20	1.75	0.58
A337-932516	9/32 - 5/16	4,500	0.23	2.22	0.77
A337-038	3/8	7,100	0.65	2.71	0.98
A337-012	1/2	12,000	1.50	3.35	1.17
A337-058	5/8	18,100	2.60	4.17	1.35
A337-034	3/4	28,300	3.80	4.61	1.64
A337-078	7/8	34,200	6.30	5.44	1.96
A337-001	1	47,700	9.30	6.10	2.31
A337-114	1 1/4	72,300	17.3	8.48	3.52

Safety Factor 4:1

Stamped with BM identification code, size, grade and traceability code. Meet ASTM-952 standard.

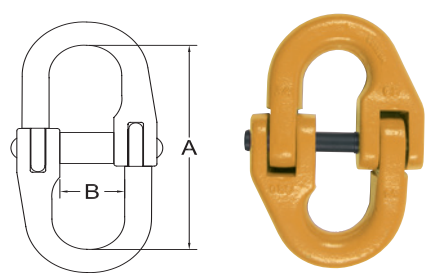

Eye Cradle Grab Hooks (Gr. 80, alloy steel, quenched and tempered)

Code	For Chain Size in.	Working Load Limit lbs.	Weight / ea. lbs.	Dimensions in.			
				C	E	F	G
EGH80-732	7/32	2,100	.35	1.75	2.69	1.63	.63
EGH80-932	9/32 - 5/16	4,500	.40	1.81	3.44	2.36	.63
EGH80-038	3/8	7,100	1.06	2.63	4.67	3.11	.78
EGH80-012	1/2	12,000	2.26	3.34	5.86	3.94	1.03
EGH80-058	5/8	18,100	4.36	4.08	7.13	4.78	1.25
EGH80-034	3/4	28,300	8.82	5.23	8.99	6.25	1.44
EGH80-078	7/8	34,200	10.40	5.69	9.63	6.50	1.75
EGH80-001	1	47,700	20.90	7.00	12.44	8.09	1.88
EGH80-114	1 1/4	72,300	40.00	8.50	15.56	10.50	2.25

Safety Factor 4:1

Stamped with BM identification code, size, grade and traceability code. Meet ASTM-952 standard.

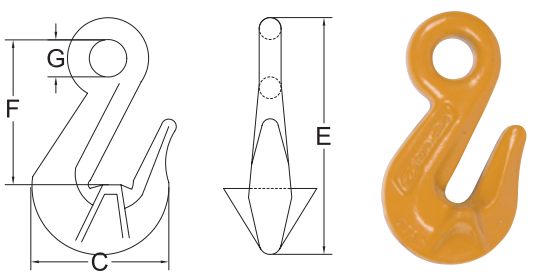

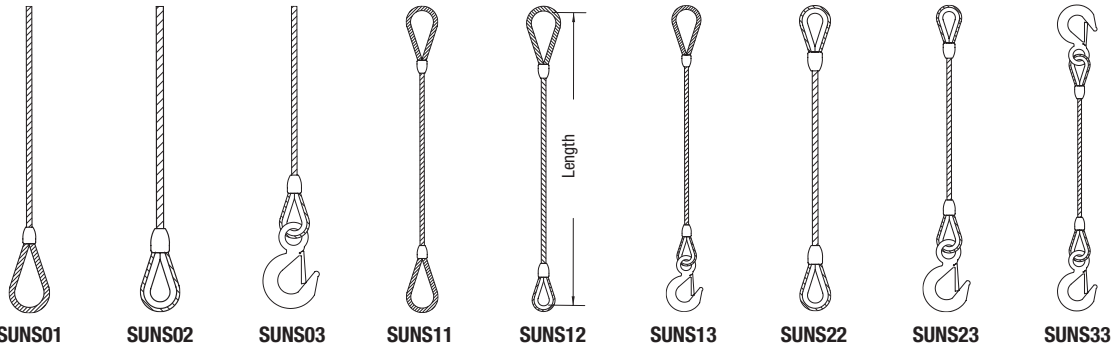

**Wire Rope Slings Single Leg,
6 x 19, 6 x 26, 6 x 36, 6 x 41 Steel Core IPS/EIPS**

Dia. in.	Standard Loops Inside Dim. in.	Hooks Capacity TON	IPS Working Load Limit lbs.						EIPS Working Load Limit lbs.					
			Vertical	Choker	Basket			Vertical	Choker	Basket				
					90°	60°	45°			30°	90°	60°	45°	30°
1/4	2 x 4	1.0	1,100	800	2,200	1,900	1,500	1,100	1,300	960	2,600	2,200	1,820	1,300
5/16	3 x 6	1.0	1,700	1,200	3,400	2,900	2,400	1,700	2,000	1,480	4,000	3,400	2,800	2,000
3/8	3 x 6	1.5	2,400	1,800	4,800	4,100	3,300	2,400	2,800	2,200	5,800	5,000	4,000	2,800
7/16	4 x 8	2.0	3,400	2,500	6,800	5,900	4,800	3,400	3,800	2,800	7,800	6,800	5,400	3,800
1/2	4 x 8	3.0	4,400	3,200	8,800	7,600	6,200	4,400	5,000	3,800	10,200	8,800	7,200	5,000
9/16	5 x 10	4.5	5,540	4,030	11,080	9,570	7,810	5,540	6,400	4,800	12,800	10,880	8,960	6,400
5/8	5 x 10	4.5	6,800	5,000	13,600	11,700	9,600	6,800	7,800	5,800	15,600	13,600	11,000	7,800
3/4	6 x 12	7.0	9,800	7,200	19,600	16,900	13,800	9,800	11,200	8,200	22,000	19,400	15,800	11,200
7/8	7 x 14	11.0	13,200	9,600	26,400	22,800	18,600	13,200	15,200	11,200	30,000	26,000	22,000	15,200
1	8 x 16	11.0	17,000	12,600	34,000	29,400	24,000	17,000	19,600	14,400	40,000	34,000	28,000	19,600
1 1/8	9 x 18	15.0	20,000	15,800	40,000	34,600	28,200	20,000	24,000	18,200	48,000	42,000	34,000	24,000
1 1/4	10 x 20	15.0	26,000	19,400	52,000	45,000	36,700	26,000	30,000	22,000	60,000	52,000	42,000	30,000
1 3/8	11 x 22	22.0	30,000	24,000	60,000	51,900	42,400	30,000	36,000	26,000	72,000	62,000	50,000	36,000
1 1/2	12 x 24	22.0	36,000	28,000	72,000	62,300	50,900	36,000	42,000	32,000	84,000	74,000	60,000	42,000
1 3/4	14 x 28	37.0	48,900	36,600	97,800	85,600	69,800	48,900	56,000	42,000	114,000	98,000	80,000	56,000
2	16 x 32	45.0	64,000	48,000	128,000	110,000	90,000	64,000	74,000	56,000	146,000	126,000	104,000	74,000
2 1/4	18 x 36	45.0	N/A	N/A	N/A	N/A	N/A	N/A	88,000	66,000	176,000	152,000	124,000	88,000
2 1/2	20 x 40	60.0	N/A	N/A	N/A	N/A	N/A	N/A	108,000	81,000	216,000	187,000	152,000	108,000

Safety Factor 5:1

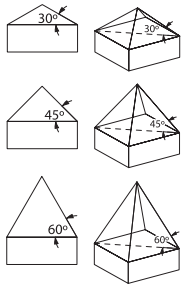

**Wire Rope Slings Double Legs,
6 x 19, 6 x 26, 6 x 36, 6 x 41 Steel Core IPS/EIPS**

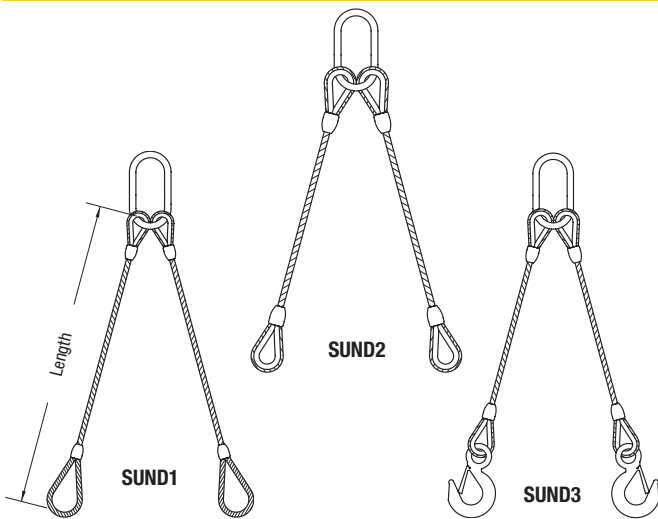

Dia. in.	Oblong* Master Link	Hooks Capacity TON	IPS Working Load Limit lbs.			EIPS Working Load Limit lbs.		
			60°	45°	30°	60°	45°	30°
1/4	A342-012	1.0	1,900	1,500	1,100	2,200	1,820	1,300
3/8	A342-058	1.5	4,100	3,300	2,400	5,000	4,000	2,800
1/2	A342-001	3.0	7,600	6,200	4,400	8,800	7,200	5,000
5/8	A342-114	4.5	11,700	9,600	6,800	13,600	11,000	7,800
3/4	A342-114	7.0	16,900	13,800	9,800	19,400	15,800	11,200
7/8	A342-114	11.0	22,800	18,600	13,200	26,000	22,000	15,200
1	A342-112	11.0	29,400	24,000	17,000	34,000	28,000	19,600
1 1/8	A342-112	15.0	34,600	28,200	20,000	42,000	34,000	24,000
1 1/4	A342-134	15.0	45,000	36,700	26,000	52,000	42,000	30,000
1 3/8	A342-002	22.0	51,900	42,400	30,000	62,000	50,000	36,000
1 1/2	A342-002	22.0	62,300	50,900	36,000	74,000	60,000	42,000
1 3/4	A342-002	37.0	81,600	66,600	47,100	98,000	80,000	56,000
2	A342-214	45.0	110,000	90,500	64,000	126,000	104,000	74,000

Safety Factor 5:1

*See dimensions on page 83

! WARNING: The maximum loads shown are applicable for products in new conditions.

! Do not exceed maximum rated capacities.



Wire Rope Slings Three Legs, 6 x 19, 6 x 26, 6 x 36, 6 x 41 Steel Core IPS/EIPS

Dia. in.	Oblong * Master Link	Hooks Capacity TON	IPS Working Load Limit lbs.			EIPS Working Load Limit lbs.		
			60 °	45 °	30 °	60 °	45 °	30 °
1/4	A342-058	1.0	2,900	2,300	1,600	3,400	2,800	1,940
3/8	A342-001	1.5	6,200	5,000	3,600	7,400	6,000	4,400
1/2	A342-114	3.0	11,400	9,300	6,600	13,200	10,800	7,600
5/8	A342-114	4.5	17,600	14,400	10,200	20,000	16,600	11,800
3/4	A342-112	7.0	25,400	20,700	14,700	30,000	24,000	16,800
7/8	A342-134	11.0	34,200	27,900	19,800	40,000	32,000	22,000
1	A342-002	11.0	44,100	36,000	25,500	52,000	42,000	30,000
1 1/8	A342-214	15.0	51,900	42,400	30,000	62,000	52,000	36,000
1 1/4	A342-212	15.0	67,500	55,100	39,000	76,000	62,000	44,000
1 3/8	A342-234	22.0	77,900	63,600	45,000	92,000	76,000	54,000
1 1/2	A342-234	22.0	93,500	76,300	54,000	110,000	90,000	64,000
1 3/4	A342-234	37.0	126,000	103,000	72,900	148,000	120,000	84,000
2	A342-234	45.0	166,000	135,000	96,000	190,000	156,000	110,000

Safety Factor 5:1

* See dimensions on page 83

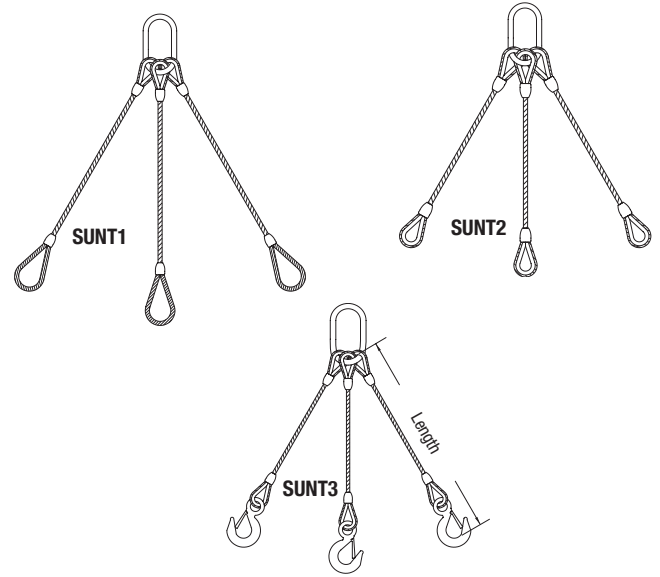

Wire Rope Slings Four Legs, 6 x 19, 6 x 26, 6 x 36, 6 x 41 Steel Core IPS/EIPS

Dia. in.	Oblong * Master Link	Hooks Capacity TON	IPS Working Load Limit lbs.			EIPS Working Load Limit lbs.		
			60 °	45 °	30 °	60 °	45 °	30 °
1/4	A342-058	1.0	3,800	3,100	2,200	4,400	3,600	2,600
3/8	A342-001	1.5	8,300	6,700	4,800	10,000	8,200	5,800
1/2	A342-114	3.0	15,200	12,400	8,800	17,600	14,200	10,200
5/8	A342-114	4.5	23,500	19,200	13,600	28,000	22,000	15,600
3/4	A342-112	7.0	33,900	27,700	19,600	38,000	32,000	22,000
7/8	A342-134	11.0	45,700	37,300	26,400	52,000	42,000	30,000
1	A342-002	11.0	58,800	48,000	34,000	68,000	56,000	40,000
1 1/8	A342-214	15.0	69,200	56,500	40,000	84,000	68,000	48,000
1 1/4	A342-212	15.0	90,000	73,500	52,000	102,000	84,000	60,000
1 3/8	A342-234	22.0	103,900	84,800	60,000	124,000	100,000	72,000
1 1/2	A342-234	22.0	124,700	101,800	72,000	146,000	120,000	84,000
1 3/4	A342-234	37.0	168,000	137,000	97,000	196,000	160,000	114,000

Safety Factor 5:1

* See dimensions on page 83

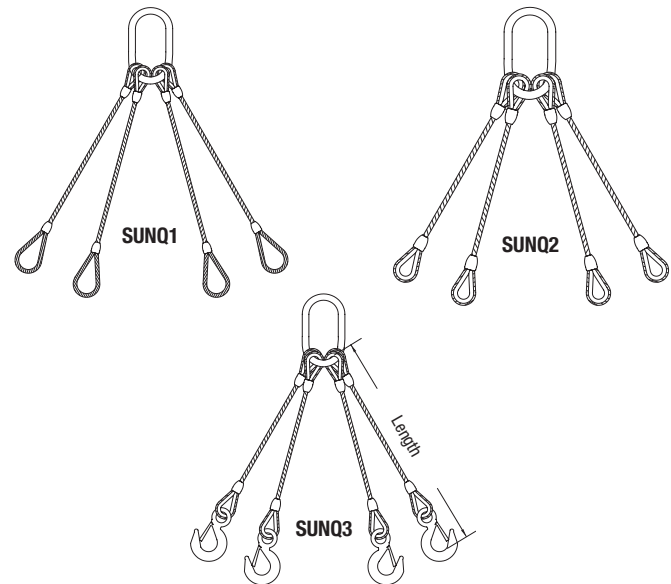

Wire Rope Slings, Ultra-flexible "Solflex"

Sling Diameter	Working Load Limit lbs.					
	Vertical	Choker	Basket 90 °	Basket 60 °	Basket 45 °	Basket 30 °
1/4	600	400	1,200	1,000	800	600
3/8	1,500	1,000	3,000	2,500	2,100	1,500
1/2	2,600	1,800	5,200	4,500	3,600	2,600
5/8	4,000	2,800	8,000	6,900	5,600	4,000
3/4	6,000	4,200	12,000	10,300	8,400	6,000
7/8	8,000	5,600	16,000	13,800	11,300	8,000
1	10,000	7,000	20,000	17,300	14,100	10,000
1 1/4	14,000	9,800	28,000	24,200	19,700	14,000
1 1/2	20,000	14,000	40,000	34,600	28,200	20,000
1 3/4	32,000	22,400	64,000	55,400	45,200	32,000
2	40,000	28,000	80,000	69,200	56,500	40,000

Safety Factor 5:1

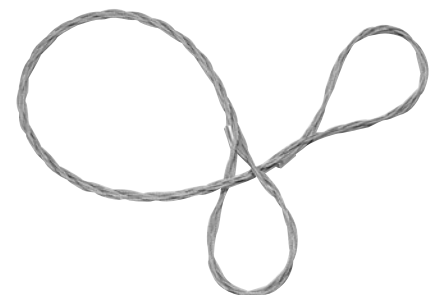



Lever Hoists



Code	Capacity WLL TON	Strands of Load Chain	Standard Lift		Load Chain Diameter		Net Weight	
			m	ft.	mm	in.	kg	lbs.
BMLH014-05	1/4	1	1,5	5	4	1/8	7,7	17
BMLH012-05	1/2	1	1,5	5	5	3/16	7,7	17
BMLH034-05-OP	3/4	1	1,5	5	6	1/4	7,7	17
BMLH112-05-OP	1 1/2	1	1,5	5	8	5/16	11,8	26
BMLH003-05-OP	3	1	1,5	5	10	7/16	20,9	46
BMLH006-05-OP	6	2	1,5	5	10	7/16	31,8	70
BMLH009-05-OP	9	3	1,5	5	10	7/16	47,2	104

Built in overload protection

Custom chain length available on request

Zinc plated hand chain

Ratings in metric ton = Tons of 1000kg or 2200lbs or 9.81 kN.

Proof load = WLL x 1.25

Chain Hoists



Code	Capacity WLL TON	Strands of Load Chain	Standard Lift		Load Chain Diameter		Net Weight	
			m	ft.	mm	in.	kg	lbs.
BMCH012-10-OP	1/2	1	3	10	6	1/4	10,0	22
BMCH012-20-OP	1/2	1	6	20	6	1/4	14,5	32
BMCH001-10-OP	1	1	3	10	6	1/4	11,8	26
BMCH001-20-OP	1	1	6	20	6	1/4	16,5	36
BMCH112-10-OP	1 1/2	1	3	10	8	5/16	19,0	42
BMCH112-20-OP	1 1/2	1	6	20	8	5/16	25,0	55
BMCH002-10-OP	2	1	3	10	8	5/16	20,0	44
BMCH002-20-OP	2	1	6	20	8	5/16	27,2	60
BMCH003-10-OP	3	2	3	10	8	5/16	27,2	60
BMCH003-20-OP	3	2	6	20	8	5/16	37,0	82

Built in overload protection

Custom chain length available on request

Zinc plated hand chain

Ratings in metric ton = Tons of 1000kg or 2200lbs or 9.81 kN.

Proof load = WLL x 1.25

Chains – Grade 80

Code	Diameter		Inside Width		Inside Length		Capacity WLL lbs.	Finish
	mm	in.	mm	in.	mm	in.		
CH80SC-04HOIST	4	1/8	4,8	0.188	12,0	0.472	550	Zinc
CH80SC-05HOIST	5	3/16	6,8	0.268	14,5	0.571	1200	Black
CH80SC-06HOIST	6	1/4	7,4	0.291	17,6	0.693	2300	Black
CH80SC-08HOIST	8	5/16	10,4	0.410	24,0	0.945	4400	Black
CH80SC-10HOIST	10	7/16	18,0	0.709	30,2	1.189	5600	Black



Beam Clamps

Code	Capacity WLL TON	Beam Width in.	Beam Width mm	Net Weight	
				kg	lbs.
BMBC001	1	3 – 8 1/2	75 – 220	4,5	9,9
BMBC002	2	3 – 8 1/2	75 – 220	5,0	11,0
BMBC003	3	3 1/8 – 12 1/2	80 – 320	10,5	23,1



Push Trolleys

Code	Capacity WLL TON	Beam Width in.	Beam Width mm	Net Weight	
				kg	lbs.
BMPT012	1/2	2 1/2 – 5 1/2	64 – 140	7,0	15,4
BMPT001	1	2 1/2 – 5 1/2	64 – 140	12,0	26,5
BMPT112	1 1/2	3 – 6 1/2	76 – 165	18,0	39,7
BMPT002	2	3 – 6 1/2	76 – 165	22,0	48,5
BMPT003	3	3 – 8	76 – 203	30,0	66,1
BMPT005	5	3 1/2 – 8	88 – 203	55,0	121,3



«i» Beam only.

Replacement Parts

Code	Capacity WLL TON	Lifting Chain	Hand Chain	*Bottom Hooks with Latch	*Safety Latch	Top Hooks
Lever Hoist						
BMLH034	3/4	CH80SC-06HOIST	-	SH-034HOIST	LATCH-034HOIST	TH-034HOIST
BMLH112	1 1/2	CH80SC-08HOIST	-	SH-112HOIST	LATCH-112HOIST	TH-112HOIST
BMLH003	3	CH80SC-10HOIST	-	SH-003HOIST-L	LATCH-003HOIST-L	TH-003HOIST
BMLH006	6	CH80SC-10HOIST	-	SH-006HOIST	LATCH-006HOIST	TH-006HOIST
BMLH009	9	CH80SC-10HOIST	-	SH-009HOIST	LATCH-009HOIST	TH-009HOIST
Chain Hoist						
BMCH012	1/2	CH80SC-06HOIST	CHMZPHOIST	SH-012HOIST-C	LATCH-012HOIST	TH-012HOIST-C
BMCH001	1	CH80SC-06HOIST	CHMZPHOIST	SH-001HOIST	LATCH-001HOIST	TH-001HOIST
BMCH112	1 1/2	CH80SC-08HOIST	CHMZPHOIST	SH-112HOIST	LATCH-112HOIST	TH-112HOIST
BMCH002	2	CH80SC-08HOIST	CHMZPHOIST	SH-002HOIST	LATCH-002HOIST	TH-002HOIST
BMCH003	3	CH80SC-08HOIST	CHMZPHOIST	SH-003HOIST-C	LATCH-003HOIST	TH-003HOIST
BMCH005	5	CH80SC-10HOIST	CHMZPHOIST	SH-005HOIST	LATCH-005HOIST	TH-005HOIST
BMCH010	10	CH80SC-10HOIST	CHMZPHOIST	SH-010HOIST	LATCH-010HOIST	TH-010HOIST

* Safety latch will work for top and bottom hooks.



Rigging Training



If your workers are using products that look like this, they need to update their training on safe rigging practices

Keep your workforce **SAFE!**

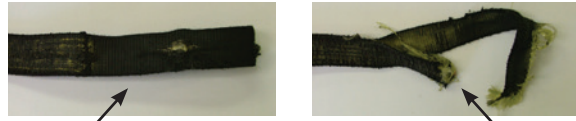

THIS ... QUICKLY TURNS... INTO THIS!

This sling, in new condition, should break at 31,000 lbs. This one failed at 7,040 lbs because of its poor condition.



Courses catered to your needs!

- Ben-Mor is a member of the Industrial Training International Advanced Rigging Network — a training partnership providing world class crane and rigging training to customers like you.

We will not come in and train your people on chain slings, when you do not own a chain sling. The course material is specifically set up to **CATER TO EXACTLY WHAT YOU NEED**, to maximize the time we spend with your people. The training will teach your people how to rig safe and prevent accidents as well as how to extend the life of their slings and lifting components.

Intro to Rigging

2 Hours
Your site or ours

What do you learn?

- Sling identification
- 2 Hours
- Inspection criteria
- Removal criteria for web slings, wire rope slings, chain slings, and roundslings
- Prevention of sling damage, using wear protection

What does each attendee receive?

- Pocket reference cards
- Workbook
- Certificate of attendance

Who should attend?

- Production workers

Rigging Fundamentals

4 Hours
Your site or ours

What do you learn?

- Sling identification
- Inspection criteria
- Removal criteria for web slings, wire rope slings, chain slings, and roundslings.
- Sling types and hitches
- Safe lifting practices

What does each attendee receive?

- Pocket reference cards
- Workbook
- Certificate of attendance

Who should attend?

- Safety coordinators
- Production workers
- Senior production or trades

Basic Rigger Course

8 Hours
Your site or ours

What do you learn?

- Employer/employee responsibilities
- ASME B30.9 standards
- Sling identification
- Inspection criteria
- Removal criteria for all slings
- Sling hitches
- OSHA regulations
- D/d ratios
- Load angle reductions
- Environmental considerations
- Repairs & certifications
- Hands on testing

What does each attendee receive?

- Pocket reference cards
- Workbook
- Certificate of completion upon test results of 80% or higher
- Lunch

Who should attend?

- Site supervisor
- Foremen
- Production managers
- Safety coordinators
- Senior production or trades

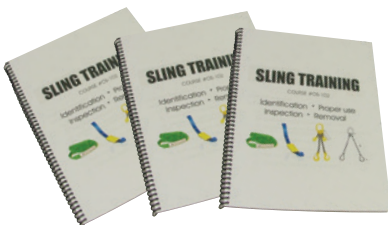



Eliminate Paperwork... Empower Field Staff

Easy-Track delivers innovative solutions that streamline any inspection and maintenance process. Mobile computing, Radio Frequency (RFID) tagging are internet applications which you, your contractors, and your customers enhanced accuracy and operational efficiency, not to mention eliminating most of the paperwork.



Easy-Track utilizes durable RFID chips for fast and accurate identification, handheld computers capture inspections and maintenance operations, eliminating manual data entry. Capture equipment entering in and out of service as well as location transfers. All data is synchronized back to the online database and automatically disseminated to other parties.



Flexible

Easy-Track tracks any asset: tailor category and item specific attributes, inspection forms, test forms, material certs and other documentation. Initiate items in the shop or the field. This is made simple with prefilled templates and drop down menus for any asset detail you need to track.

End coupling 1	ABC Coupling 1
End coupling 2	ABC Coupling 2
Max design temp	212 F
Min design temp	-22 F
Hose weight	200 lb
Manufacturer	Premier Industries
Hose Type	Choke & Kill Hose
Hose Standard	Mud Vibrator Hose
Hose Cover	Cement Hose, Acidizing Hoses
Outsideprotection	Production Hose
Dynamic MBR	Tensioner Hose
Storage MBR	SDP Control Hose
Static MBR	Boat Loading Transfer Hose
Notes	Hydraulic Hose

Selected Location: Root

Search Criteria: ChipID Asset #

Select From Date: To Date: Op. Type: Employee: Search

Dem Desc: Location: Category: Work Order Generated: Reset

ChipID	Customer Name	Make	Model	Location	Next Test Date
70490772	Demo Customer	GOODYEAR	TRUCK64	TRUCK64	2000-12-31
70490508	Demo Customer	GOODYEAR	PALADIN	UNSTOCK	2001-07-02
7049051A	Demo Customer	GOODYEAR	PALADIN	TRUCK 77	2002-10-22
7048F858	Demo Customer	GOODYEAR	PALADIN	STOCK	2003-09-01
7049088D	Demo Customer	GOODYEAR	PALADIN	STOCK	2004-01-01
7048FDB8	Demo Customer	MAK			
7048F81A	Demo Customer	MAK			
7048F728	Demo Customer	GOOD			
70490670	Demo Customer	GOOD			
70047228	Demo Customer	GOOD			
7048F9F0	Demo Customer	MAK			
7048F740	Demo Customer	MAK			
70490533	Demo Customer	MAK			
7048F6A2	Demo Customer	MAK			

Pressure Test Number 12345, 42006-11-01#

Always Available

Easy-Track includes a secure online database hosting your entire asset operation history. Management is notified with alerts for failed inspections, repairs and work order details. Various reports alert you to overdue service and inspections. Asset detail history includes: size, length, serial number, and part number. Complete backup download of your online database is also available.

Easy-Track Advantage

- ✓ Eliminates errors and time constraints associated with paperwork, faxing and re-keying data
- ✓ Avoid under utilization - eliminate calendar method of swapping out used assets
- ✓ RFID employee cards manage access and provide accountability
- ✓ Alert service teams automatically on overdue inspections / certifications and corresponding order details
- ✓ Immediate access to inspections and maintenance history through secure, hosted online database
- ✓ Accommodates barcode and traditional serial number tag data.
- ✓ Time stamps prove when and where inspection took place



Web Sling Inspection Criteria

It is important to inspect your web slings after purchase.

Types of inspection

- A. **Initial Inspection** - Before any new or repaired web sling is placed in service, it shall be inspected by a designated competent person to ensure that the correct web sling is being used, as well as to determine that the web sling meets the applicable requirements.
- B. **Frequent Inspection** - This inspection should be conducted by the person handling the sling each time the sling is used.
- C. **Periodic Inspection** - This inspection shall be conducted by the designated staff. Frequency of inspection should be based on frequency of web sling use, severity of service conditions and experience gained on the service life of web slings used in similar applications. Inspections should be conducted at least annually.

Often riggers confuse a cut sling for a broken sling. View the pictures below to see the difference. The cut sling has come into contact with something sharp that has sliced the sling in half. (You can tell by the clean edge). The broken sling has been pulled to destruction on our test bed. The ends are frayed and melted from heat friction.



Cut sling



Broken sling



Cut Eye



Snag

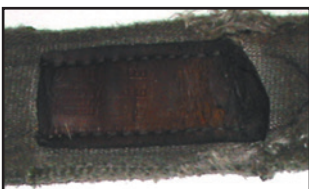

Illegible Tag

Remove the sling from service if any of the following is visible:

- ✓ If sling rated capacity or sling material identification is missing or not legible
- ✓ Acid or alkaline burns
- ✓ Melting, charring or weld spatters on any part of the web sling
- ✓ Holes, tears, cuts, snags or embedded particles
- ✓ Broken or worn stitching in load bearing splices
- ✓ Excessive abrasive wear
- ✓ Knots in any part of the web sling
- ✓ Excessive pitting, or corrosion, or cracked, or distorted, or broken fittings
- ✓ Any other visible damage that causes doubt as to the strength of the sling

Inspection Records

Written inspection records, utilizing the identification for each sling as established by the user, should be kept on file for all web slings. These records should show a description of the sling and its condition on each periodic inspection.

Repair of Web Slings

Web slings with structural damage shall never be repaired. Web slings utilizing hardware may be rewbedded. The fittings must be visually inspected and proof tested before they can be used.



WARNING!

These pages contain important safety information about the use of synthetic slings. However, it DOES NOT contain all the information you need to know about handling, lifting and manipulating materials and loads safely. Sling use is only one part of a lifting system and it is your responsibility to consider all risk factors prior to using any rigging device or product. Failure to do this may result in severe INJURY or DEATH due to sling failure and/or loss of load.

Read and follow all use and safety information provided with sling. Failure to do so may result in severe INJURY or DEATH due to sling failure and/or loss of load.

The following six points briefly summarize some important safety issues:

1. **All users must be trained** in sling selection, use and inspection, cautions to take, environmental effects and rigging practices.
2. **Inspect slings for damage** regularly, if the sling is damaged, remove it from service.
3. **Protect slings from damage.** ALWAYS protect slings in contact with edges, corners, protrusions, or abrasive surfaces with materials of sufficient strength, thickness and construction to prevent damage.
4. **Do not exceed a sling's rated capacity.** Always consider the effect of sling angle and tension on the sling's rated capacity.
5. **Do not stand on, under or near a load** with the sling under tension. All the staff should be alert to danger of falling and/or uncontrolled load, sling tension and the potential for snagging.
6. **Maintain and store slings properly.** Slings should be protected from mechanical, chemical and environmental damage.

1. ALL SLING USERS MUST BE TRAINED AND KNOWLEDGEABLE

All sling users must be trained on the proper use of slings.

It is important that all sling users be trained and knowledgeable about the safe and proper use and application of slings and be thoroughly familiar with the manufacturer's recommendations and safety materials provided with each product. In addition, all sling users need to be aware of their responsibilities as outlined in all applicable standards and regulations. (Please see The American Society of Mechanical Engineers; Safety standards for slings (ASME B30.9))

If you are unsure whether you are properly knowledgeable or trained, or if you are unsure of what the standards and regulations require of you, ask your employer for information and/or training-DO NOT use slings until you are absolutely sure of what you are doing. Remember, when it comes to using slings, lack of skill, knowledge and care can result in severe INJURY or DEATH to you and others.

2. SLINGS MUST BE REGULARLY AND PROPERLY INSPECTED

Even seemingly "minor" damage to a sling can significantly reduce its capacity to hold or lift objects and increases the risk that the sling will fail during use. Therefore, it is very important that slings are regularly and properly inspected. In reality, there simply is no such thing as "minor" damage. If you are not sure whether a sling is damaged, DO NOT USE IT!

Generally, damage to slings can be detected visually. In some instances, internal damage can occur and not be visible. To detect possible damage, you should perform a visual inspection of the entire sling and also feel along its entire length, as some damage may be felt more than seen. You should look and feel for any of the types of conditions listed in Table 1 (page 94).

A three-stage procedure is recommended to help ensure that slings are inspected with appropriate frequency.

Initial Inspection - Whenever a sling is initially received, it must be inspected by a designated person to help ensure that the correct sling has been received and is undamaged, and that the sling meets applicable requirements for its intended use.

Frequent Inspection - The entire sling must be inspected before each shift or day in normal service and before each use in severe service applications.

Periodic Inspection - Every sling must be inspected "periodically" by a qualified and designated person. In order to validate the frequent level of inspection, the periodic inspection should be performed by someone other than the individual(s) who most commonly performs the frequent inspection. The frequency of periodic inspections is based on the sling's actual or expected frequency of use, severity of service conditions, the nature of the work performed with the sling and experience gained during the inspection of other slings used in similar circumstances. General guidelines for the frequency of periodic inspections are: Normal service is yearly, Severe service is monthly to quarterly, and Special service is as recommended by qualified person. **Periodic inspections must not exceed one year.**



TABLE 1: Sling removal criteria

The entire sling must be inspected regularly and it shall be removed from service if ANY of the following are detected:

- If sling identification tag is missing or not readable.
- Holes, tears, cuts, embedded materials, excessive abrasive wear, or snags that expose the core yarn of the sling.
- Broken or damaged core yarn.
- Knots in any part of the sling.
- Acid or alkaline burns on the sling.
- Melting, charring or weld spatter of any part of the sling.
- Distortion, excessive pitting, corrosion or other damage to fitting(s),
- Broken or worn stitching
- Excessive, abrasive wear or crushed webbing.
- Signs of ultraviolet (UV) light degradation.
- If provided, exposed red core yarn. However, if damage is present and red yarns are not exposed DO NOT USE the sling.
- Any conditions which cause doubt as to the strength of the sling.

3. SLINGS MUST BE ADEQUATELY PROTECTED FROM DAMAGE

You should always avoid any action that causes the types of damage identified in the previous section, including (but not limited to):

- Dropping or dragging slings on the ground, floor or over abrasive surfaces.
- Pulling slings from under loads when the load is resting on the sling; place blocks under the load if feasible.
- Shortening or adjusting sling using methods not approved by the sling manufacturer or qualified person.
- Twisting, kinking, or knotting the sling.
- Exposing slings to damaging acids or alkalis.
- Exposing slings to sources of heat damage or weld spatter.
- Using slings or allowing exposure to temperatures above the recommended temperatures listed on slings warning tags.
- "Tip loading" a sling on a hook instead of centering it in the base or "bowl" of the hook.
- Using hooks, shackles or other hardware that have edges or surfaces that could damage the sling.
- Running/driving over slings with a vehicle or other equipment.
- Synthetic slings are affected by some chemicals ranging from little to total degradation. Time, temperature and concentration factors affect the degradation. For specific applications, consult the manufacturer.

Synthetic slings can be damaged, abraded or cut by tension and compression between the sling, the connection points and the cargo develops. Surfaces in contact with the sling do not have to be very abrasive or have "razor" sharp edges in order to create the conditions for sling failure. Therefore, slings must ALWAYS be protected from being cut or damaged by corners, protrusions, or from contact with edges that are not smooth or well-rounded with materials sufficient for the intended purpose.

There are many ways to protect slings from such damages. A qualified person might select and use appropriately engineered protectors/softeners-commercially available products (e.g., sleeves, wear pads, corner protectors, etc.) specifically designed to protect slings from damage. A qualified person might also design and construct their own methods of protection as long as the sling is adequately protected and/or kept off of the damaging edge surface.

4. ALWAYS USE SLINGS PROPERLY

When lifting loads, a trained, qualified and knowledgeable user must take into consideration the factors and issues addressed into these recommendations, as well as considering any other relevant factors not addressed herein. Among the factors related specifically to slings, users must perform several activities, including (but not limited to) those discussed in the following subsections.

Determine the weight of the load and make sure it does not exceed the sling's rated capacity or the capacity of any of the components of the rigging system. Users must also determine the load's center of gravity (CG) to make sure the rigging system used will be able to retain and control the load once lifted.



Select a sling having suitable characteristics for the type, size and weight of the load, the type of hitch and the environment. The sling must be securely attached to the load and rigged in a manner to provide load control to prevent slipping, sliding and/or loss of the load. A trained, qualified and knowledgeable user must determine the most appropriate method of rigging to help ensure a safe lift and control of the load.

Avoid accelerating or decelerating the load too quickly (i.e. "shock loading"). Do not use slings to pull on stuck or snagged objects and do not use slings for towing purposes. A sling should only be used for lifting loads.

Categories	Issues/ Factors to Consider		
Environment	Wind Weather Visibility	Environmental temperature Object temperature Chemical conditions & Exposure	Ground stability Underground installations
Load	Weight Dimensions Center of Gravity	Attachment point integrity Susceptibility to crushing/ compression Loose parts that could fall from load	Combination loads Damaging surfaces / edges Structural stability (Bend / flex)
Equipment/ Lift	Single/ Multiple Cranes / Hoists Maximum / planned operating radius Allowable load Ratio of lift to allowable load.	Clearance to surrounding facilities Power lines and other environmental hazards Clearance between boom & lift Emergency/ contingency set down area	Equipment inspection Ensure a clear load path
Rigging	Sling selection Load control Lift point (over CG) Positive sling-to-load engagement	Coefficient of friction: sling to load Appropriate hitch for (CG and load control) Load is free to move and is not snagged Coordination of multiple slings	Suitable wear protection Sling capacity is adequate for angle and tension
Staff	Area clear of unnecessary staff Staff are trained and qualified	Signals: Visual, audible, electronic, etc. Staff away from load and other dangers	Pre-lift plan and meeting Tag lines / spotter requirements

5. MAKE SURE THE STAFF IS CLEAR OF LOADS AND ALERT TO RISKS

Even if the factors/issues discussed into these pages are taken into consideration, things can still go wrong.

Therefore, all the staff must stand clear of the lifted loads and never be under, on or near suspended loads.

When using slings, no part of the body should be placed between the sling and load, or between the sling and lifting hook. In addition, the staff must be alert to the potential for the sling to become snagged during lifting, never use a sling to pull on objects in a snagged or constrained condition.

6. PROPERLY STORE AND MAINTAIN SLINGS

In order to prevent damage to slings when not in use, you should store slings in a cool, dry and dark location. Slings should be stored in an area free from environmental or mechanical sources of damage, such as: weld spatter, splinters from grinding or machining, heat sources, chemical exposure, etc. Also, keep slings clean and free of dirt, grime and foreign materials.

If slings are cleaned, use only mild soap and water. Rinse slings thoroughly and allow to dry completely before placing the slings back into storage or use. Do not machine wash slings. Machine washing results in significant loss of sling strength.

Where to Find Additional Information

This bulletin does not provide you with all the information you need to know in order to be considered trained and knowledgeable about rigging and lifting loads, but it does provide important information about the use of slings within a rigging system. If you need more information about slings and rigging practices or your responsibilities according to regulations and standards, talk to your employer. You and your employer can consult a number of sources of information to help ensure that you are properly trained and knowledgeable when using slings, including (but not limited to):

- WSTDA-WS-1 – Recommended Standard Specification for Synthetic Slings
- ASME B30.9 – Synthetic Webbing Slings: Selections, use and maintenance
- OSHA 29 CFR 1910.184 – Slings
- OSHA Guidance on safe sling use (<http://www.osha.gov.dsg/guidance/slings/synth-web.html>)
- Manufacturer's Catalogue, manual, website, bulletins, rigging handbooks etc.
- Formal training provided by manufacturers or other outside entities.





Roundsling Inspection criteria

It is important to inspect your roundslings after purchase.

Types of inspection

- A. **Initial Inspection** - Before any new or repaired roundsling is placed in service, it shall be inspected by a designated competent person to ensure that the correct web sling is being used, as well as to determine that the web sling meets the applicable requirements.
- B. **Frequent Inspection** - This inspection should be conducted by the person handling the sling each time the sling is used.
- C. **Periodic Inspection** - This inspection shall be conducted by the designated staff. Frequency of inspection should be based on frequency of web sling use, severity of service conditions and experience gained on the service life of web slings used in similar applications. Inspections should be conducted at least annually.

Remove the sling from service if any of the following is visible:

- ✓ If sling rated capacity or sling material identification is missing or not legible
- ✓ Acid or alkaline burns
- ✓ Melting, charring or weld spatters on any part of the roundsling
- ✓ Holes, tears, cuts, snags or embedded particles
- ✓ Broken or worn stitching in the cover, that exposes core yarns
- ✓ Core yarns are broken or damaged during use
- ✓ Knots in any part of the roundsling
- ✓ Excessive pitting, or corrosion, or cracked, or distorted, or broken fittings
- ✓ Any other visible damage that causes doubt as to the strength of the sling



Exposed load bearing yarns



Seam of cover opening

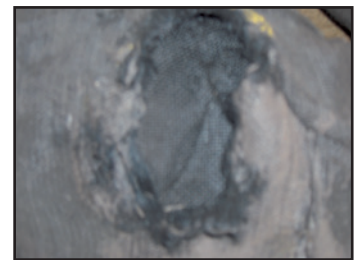

Melted or Charred areas

Inspection Records

Written inspection records, utilizing the identification for each sling as established by the user, should be kept on file for all roundslings. These records should show a description of the sling and its condition on each periodic inspection.

Repair of Roundslings

There shall be no repairs of load bearing fibers. Repairs to the protective covers will be done by the original manufacturer. All repaired polyester roundslings shall be proof tested to a minimum of 2 times rated vertical capacity.



Chain Sling Inspection criteria

It is important to inspect your chain slings after purchase.

Types of inspection

- A. **Initial Inspection** - Before any new or repaired chain sling is placed in service, it shall be inspected by a designated competent person to ensure that the correct web sling is being used, as well as to determine that the web sling meets the applicable requirements.
- B. **Frequent Inspection** - This inspection should be conducted by the person handling the sling each time the sling is used.
- C. **Periodic Inspection** - This inspection shall be conducted by the designated staff. Frequency of inspection should be based on frequency of web sling use, severity of service conditions and experience gained on the service life of web slings used in similar applications. Inspections should be conducted at least annually.

Remove the sling from service if any of the following is visible:

- ✓ If sling rated capacity or sling material identification is missing or not legible
- ✓ Cracks or breaks
- ✓ Excessive wear, nicks, or gouges
- ✓ Stretched chain links or components
- ✓ Bent, twisted, or deformed chain links or components
- ✓ Evidence of heat damage
- ✓ Excessive pitting, or corrosion
- ✓ Lack of ability of chain or components to hinge freely
- ✓ Weld splatter
- ✓ Any other visible damage that causes doubt as to the strength of the sling



Pitting & corrosion



Deformed components

Inspection Records

Written inspection records, utilizing the identification for each sling as established by the user, should be kept on file for all chain slings. These records should show a description of the sling and its condition on each periodic inspection.

Repair of Chain Slings

Cracked, broken, or bent chain links shall not be repaired, they shall be replaced. All repaired chain slings must be proof tested to twice the Vertical rated capacity.



Wire Rope Inspection

It is important to inspect your wire slings after purchase.

Types of inspection

- A. **Initial Inspection** - Before any new or repaired wire rope sling is placed in service, it shall be inspected by a designated competent person to ensure that the correct web sling is being used, as well as to determine that the web sling meets the applicable requirements.
- B. **Frequent Inspection** - This inspection should be conducted by the person handling the sling each time the sling is used.
- C. **Periodic Inspection** - This inspection shall be conducted by the designated staff. Frequency of inspection should be based on frequency of web sling use, severity of service conditions and experience gained on the service life of web slings used in similar applications. Inspections should be conducted at least annually.

Remove the sling from service if any of the following is visible:

- ✓ If sling rated capacity or sling material identification is missing or not legible
- ✓ Ten broken wires in one rope lay or five broken wires in one strand in one rope lay
- ✓ Severe localized abrasion or scraping
- ✓ Kinking, crushing, birdcaging, or any other damage resulting in damage to the rope structure
- ✓ Evidence of heat damage
- ✓ Severe corrosion of the rope
- ✓ Excessive pitting, or corrosion, or cracked, or distorted, or broken fittings
- ✓ Any other visible damage that causes doubt as to the strength of the sling



Bird caging

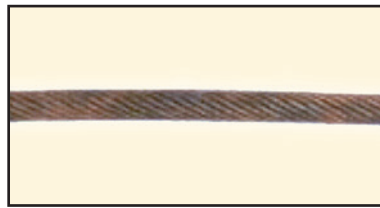

Corroded

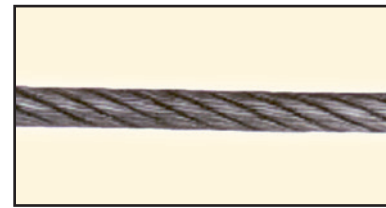

Worn wires



Broken wires

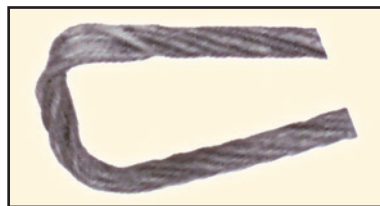

Kinked

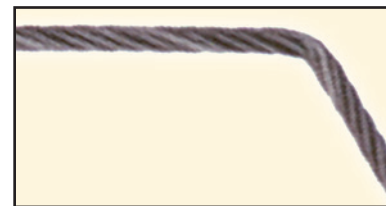

Crushed

Inspection Records

Written inspection records, utilizing the identification for each sling as established by the user, should be kept on file for all wire rope slings. These records should show a description of the sling and its condition on each periodic inspection.

Repair of Wire Rope Slings

There shall be no repairs done to the wire used in a wire rope sling. Repairs shall be restricted to end attachments and fittings, which will be deemed ok by the manufacturer.



In House Testing

Ben-Mor has a ROBERTS 350,000 lbs, 60 FT horizontal test bed. We can offer in-house testing & certification. All slings tested come complete with the proof test certificate, and are logged on-line with EasyTrack.



Batch testing

All of our slings are batch tested to ensure that we are meeting our rated capacities. Our slings are manufactured to meet the criteria of Web Sling & Tie Down Association, ASME B30.9, and OSHA.



CERTIFICATE



Ben-Mor Cables Inc. confirms that goods described below have succeeded to test of capacity as required by client, according to type of product, raw material and types of uses recommended.

Material	Quantity	Code No.	Diameter x Length	Description	BEN-MOR Serial No.	CLIENT Serial No.	TYPES OF USES					
							Vertical	Choker	Basket Suction Angle	LBS		
CHAIN	1	005	3/8" x 10'	G80 DSH SL 3/8 x 10' SLP	VCO-146940-1	n/a	N/A	N/A	12 300	7 100	28 400	N/A

REMARKS / Notes:

Min 20 Years
Date: 2015-03-03
Authorized Signature:

1105 Lemire, SAINT-HYACINTHE, QC, J2T 1L6, CANADA Tel: 450-778-0022 Fax: 450-778-0033 Tel: 800-481-0022 Fax: 800-498-0022 www.ben-mor.com

Re-Certification:

Send in for re-certification: Sling, hooks, ropes, chain hoists, hoist rings, hardware. With all proof tests, and destruction tests, you will receive a printed certificate.



Chain

Grade 40 High Tensile Chain - carbon steel

Grade 40 high tensile chain has a higher resistance to wear than Grade 30. It is a perfect product for farming and similar tasks.

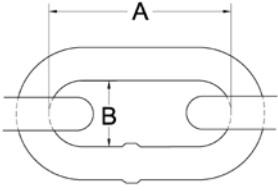

Specifications				
Diameter in.	Inside Dimensions in.		Working Load Limit lbs.	Weight / 100 ft. lbs
	A	B		
1/4	0.90	.44	2,600	71
5/16	1.12	.48	3,900	102
3/8	1.35	.57	5,400	140
1/2	1.70	.75	9,200	234

Safety Factor 3:1

Test certificate available – Do not use for overhead lifting



Self colored		
Drum		
Code	Diameter in.	Pack ft.
53030	1/4	400
53031	5/16	275
53032	3/8	200
53033	1/2	100



Zinc Plated		
Pail		
Code	Diameter in.	Pack ft.
52039	1/4	100
51159	5/16	75
52041	3/8	45



Hot Dip Galvanized		
Drum		
Code	Diameter in.	Pack ft.
53034	1/4	450
53035	5/16	275
53036	3/8	200
53037	3/8	400
53038	1/2	200

Stainless Steel Chain 316 L

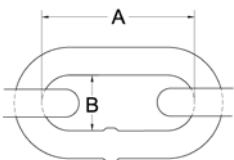

Code	Diameter		Working Load Limit lbs.	Inside Dimensions in.		Weight per 100 ft. lbs.
	mm	in.		A	B	
CHS-564	2	5/64	70	0.48	0.14	5
CHS-018	4	1/8	400	0.91	0.27	20
CHS-316	5.5	3/16	800	0.96	0.40	40
CHS-014	7	1/4	1,300	1.18	0.43	66
CHS-516	8	5/16	1,700	1.26	0.50	86
CHS-038	10	3/8	2,650	1.31	0.60	142
CHS-012	13	1/2	4,500	1.79	0.72	242

Safety Factor 4:1

Test certificate available – Do not use for lifting



Grade 30 Proof Coil Chain (low carbon steel)

A general utility chain for farm, industry and home applications.

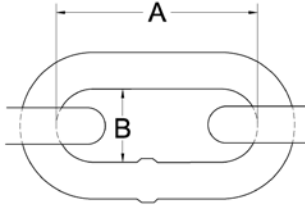

Specifications				
Diameter in.	Inside Dimensions in.		Working Load Limit lbs.	Weight / 100 ft. lbs.
	A	B		
1/8	0.69	.25	325	20
3/16	0.98	.34	630	29
1/4	1.34	.48	1,100	52
5/16	1.24	.50	1,900	85
3/8	1.35	.57	2,650	124
1/2	1.70	.75	4,500	234
5/8	2.20	.79	6,900	390
3/4	2.76	.98	10,600	537
1	3.60	1.25	17,900	941

Safety Factor 4:1

Test certificate available – Do not use for overhead lifting

Self Colored		
Drum		
Code	Diameter in.	Pack ft.
53000	1/8	1250
53001	3/16	800
53002	1/4	450
53003	5/16	275
53004	3/8	200
53005	1/2	100
Pail		
52000	1/8	250
52001	3/16	150
52002	1/4	100
52003	5/16	75
52006	5/16	90
52004	3/8	45
52005	1/2	25



SELF COLORED



ZINC PLATED



HOT DIP GALVANIZED

Zinc Plated		
Drum		
Code	Diameter in.	Pack ft.
53010	1/8	1250
53011	3/16	800
53012	1/4	450
53013	5/16	275
53014	3/8	200
53015	1/2	100
Pail		
52009	1/8	250
52010	3/16	150
52011	1/4	100
52012	5/16	75
52013	3/8	45
52014	1/2	25
Reel		
51000	3/16	100
51001	1/4	65
51002	5/16	60
51003	3/8	35
51009	1/8	150

For grade 70 see page 120
For grade 80 see page 82



Hot Dip Galvanized		
Drum 29 in.		
Code	Diameter in.	Pack ft.
53027	5/8	150
53028	3/4	100
Drum		
53020	1/8	1250
53021	3/16	800
53022	1/4	450
53023	5/16	275
53024	3/8	200
53025	1/2	100
Pail		
52020	1/8	250
52021	3/16	150
52022	1/4	100
52023	5/16	75
52024	3/8	45
52025	1/2	25



Machine Chain - low carbon steel

Machine chain is a short link chain used mainly where flexibility in a compact chain is required.



Straight Link								
Code	Trade Size #	Dimensions in.			Working Load Limit lbs.	Pack ft.	Weight / 100 ft. lbs	Packaging
		Dia.	Inside Length	Inside Width				
51011	# 2 (Zinc)	.150	.61	.26	325	125	19	Reel
56007	# 2 (Galv.)	.150	.61	.26	325	100	19	Reel
51012	# 3 (Brass)	.140	.59	.24	270	80	15	Reel
51010	# 4 (Zinc)	.120	.55	.21	215	100	11	Reel



Twist Link								
Code	Trade Size #	Dimensions in.			Working Load Limit lbs.	Pack ft.	Weight / 100 ft. lbs.	Packaging
		Dia.	Inside Length	Inside Width				
51020	# 2 (Zinc)	.150	.58	.22	310	125	20	Reel
51021	# 4 (Zinc)	.120	.52	.17	200	100	13	Reel
51022	2/0 (Zinc)	.190	.73	.28	520	75	34	Reel
51063	2/0 (Zinc)	.190	.73	.28	520	150	34	Pail
51023	# 250 (Nickel)	.095	.42	.2	45	100	9	Reel

Passing Link Chain - low steel carbon

A general utility chain that resist kinking due to the link design.



Zinc								
Code	Trade Size #	Dimensions in.			Working Load Limit lbs.	Pack ft.	Weight / 100 ft. lbs.	Packaging
		Dia.	Inside Length	Inside Width				
51035	2/0	.190	.88	.47	450	120	32	Reel
52037	2/0	.190	.88	.47	450	225	32	Pail



Harrow Chain



Self colored							
Code	Dimensions in.			Working Load Limit lbs.	Pack ft.	Weight / 100 ft. lbs.	Packaging
	Dia.	Inside Length	Inside Width				
56008	5/16	2.12	0.90	1,900	100	85	Special Pail

Coil Chain - low carbon steel

Coil chains have longer links than machine chain. This product is perfect for animal tie chains, platform barriers and other similar tasks.



Straight Link								
Code	Trade Size #	Dimensions in.			Working Load Limit lbs.	Pack ft.	Weight / 100 ft. lbs.	Packaging
		Dia.	Inside Length	Inside Width				
51017	2/0 (Zinc)	.190	1.29	.32	520	200	27	Pail
51015	# 4 (Zinc)	.120	1.11	.21	205	100	10	Reel
51016	2/0 (Zinc)	.190	1.29	.32	520	125	27	Reel
51018	# 2 (Zinc)	.148	1.18	.26	310	125	18	Reel



Twist Link								
Code	Trade Size #	Dimensions in.			Working Load Limit lbs.	Pack ft.	Weight / 100 ft. lbs.	Packaging
		Dia.	Inside Length	Inside Width				
51025	# 3 (Bronze)	.140	1.14	.21	240	50	13	Reel

Endweld Utility Chain - steel

A standard chain for all purpose usage except lifting.



Zinc Plated								
Code	Trade Size #	Dimensions in.			Working Load Limit lbs.	Pack ft.	Weight / 100 ft. lbs.	Packaging
		Dia.	Inside Length	Inside Width				
51030	# 14	.080	0.50	0.19	75	250	5	Reel



Double Loop Chain - steel



An economical utility chain used for swings, dog tie-outs, cow ties, etc... (also called Tenso and Lion)

Code	Trade Size #	Dimensions in.			Working Load Limit lbs.	Pack ft.	Weight / 100 ft. lbs.	Packaging
		Dia.	Inside Length	Inside Width				
51145	# 1 (Zinc)	.105	1.54	.281	155	125	8	Reel
51052	# 1 (Zinc)	.105	1.54	.281	155	250	8	Reel
51067	# 1 (Zinc)	.105	1.54	.281	155	425	8	Pail
51057	# 2 (Zinc)	.091	1.33	.16	115	200	12	Reel
51053	# 3 (Zinc)	.080	1.10	.187	90	200	6	Reel
51059	# 3 (Zinc)	.080	1.10	.187	90	700	6	Special Pail
51054	# 4 (Zinc)	.072	1.02	.171	70	250	5	Reel
51051	# 1/0 (Zinc)	.120	1.78	.312	200	200	13	Reel
51146	# 1/0 (Polycoat white)	.120	1.78	.312	200	100	13	Reel
51050	# 2/0 (Zinc)	.135	1.82	.340	255	75	17	Reel
52059	# 2/0 (Polycoat white)	.135	1.82	.340	255	200	17	Pail
52146	# 2/0 (Zinc)	.135	1.82	.340	255	275	17	Pail
51062	# 3/0 (Zinc)	.148	2.17	.415	305	150	20	Pail



Vinyl Covered								
Code	Trade Size #	Dimensions in.			Working Load Limit lbs.	Pack ft.	Weight / 100 ft. lbs.	Packaging
		Dia.	Inside Length	Inside Width				
51055	# 1/0 (Green)	.120	1.78	.312	200	100	17	Reel
51056	# 2 (Blue)	0.091	1.33	0.167	115	125	11	Reel

Lock Link Chain - steel



The strongest weldless chain. Provides a flat suspension surface.

Zinc							
Code	Trade Size #	Dimensions in.		Working Load Limit lbs.	Pack ft.	Weight / 100 ft. lbs.	Packaging
		Dia.	Inside Length				
51077	2/0	.140	1.48	340	50	23	Reel

Furnace Chain - steel



Light duty chain.

Zinc						
Code	Trade Size #	Thickness in.	Working Load Limit lbs.	Pack ft.	Weight / 100 ft. lbs.	Packaging
51070	# 91	.023	41	250	2.5	Reel



Single Jack Chain - steel

Ideal chain for hanging lighting fixtures, flower pots and other domestic type light objects.



Code	Trade Size #	Dimensions in.		Working Load Limit lbs.	Pack ft.	Weight / 100 ft. lbs.	Packaging
		Dia.	Inside Length				
51040	# 10 (Zinc)	.135	.93	43	150	12	Reel
51041	# 12 (Zinc)	.105	.77	29	100	9	Reel
51140	# 14 (Polycoat black)	.080	.66	16	190	5	Reel
51047	# 14 (Black)	.080	.66	16	200	5	Reel
51042	# 14 (Zinc)	.080	.66	16	200	5	Reel
51043	# 16 (Zinc)	.062	.52	11	250	2.75	Reel
51046	# 16 (Bronze)	.062	.52	11	250	2.75	Reel
51038	# 18 (Zinc)	.047	.39	5	200	1.7	Reel



Double Jack Chain - steel

Chain similar to the single jack chain with a sturdier construction.



Code	Trade Size #	Dimensions in.		Working Load Limit lbs.	Pack ft.	Weight / 100 ft. lbs.	Packaging
		Dia.	Inside Length				
51075	# 16 (Brass Pl.)	.058	.22	11	200	6	Reel
51076	# 16 (Zinc Pl.)	.058	.22	11	200	6	Reel

Plastic Chain

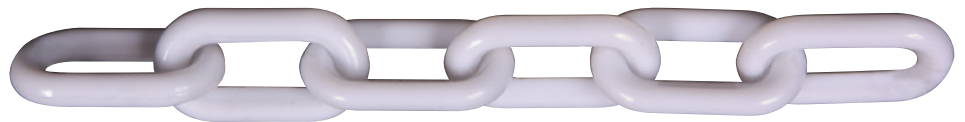

Code	Trade Size #	Dimensions in.			Working Load Limit lbs.	Pack ft.	Weight / 100 ft. lbs.	Packaging
		Dia.	Inside Length	Inside Width				
54000	# 6 (1-1/2") White	.230	1.00	.30	50	130	5	Pail
54001	# 6 (1-1/2") Black	.230	1.00	.30	50	130	5	Pail
54006	# 6 (1-1/2") Yellow	.230	1.00	.30	50	130	5	Pail
54002	# 8 (2") White	.290	1.50	.40	75	70	7	Pail
54003	# 8 (2") Black	.290	1.50	.40	75	70	7	Pail

Cathedral Chain - steel



Code	Trade Size #	Dimensions in.			Working Load Limit lbs.	Pack ft.	Weight / 100 ft. lbs.	Packaging
		Dia.	Inside Length	Inside Width				
51090	#31 Brass Plated	.087	.985	.552	35	98	6	Reel
51091	#31 White	.087	.985	.552	35	98	6	Reel



Decorative Oval Chain (Swag)

Code	Trade Size #	Dimensions in.			Working Load Limit lbs.	Pack ft.	Weight / 100 ft. lbs.	Packaging
		Dia.	Inside Length	Inside Width				
51105	# 4 Zinc Plated	.120	.58	.210	70	90	11	Reel
51080	# 10 Brass Plated	.109	1.25	.625	45	50	7	Reel
51081	# 10 Black	.109	1.25	.625	45	50	7	Reel
51082	# 10 Antique Silver	.109	1.25	.625	45	50	7	Reel
51083	# 10 White	.109	1.25	.625	45	50	7	Reel
51084	# 10 Aged Bronze	.109	1.25	.625	45	50	7	Reel
51085	# 10 Antique Copper	.109	1.25	.625	45	50	7	Reel
51088	# 10 Satin Chrome	.109	1.25	.625	45	50	7	Reel
51089	# 10 Oil Rubbed Bronze	.109	1.25	.625	45	50	7	Reel
51086	# 100 Bronze	.087	.63	.240	13	197	3	Reel
51127	# 100 Black	.087	.63	.240	13	197	3	Reel
51125	# 19 Brass Plated	.043	.205	.110	7	82	2	Reel



Sash Chain - steel

This chain is designed to operate smoothly over pulleys, it is ideal for many applications such as hanging and suspending double hung sashes.

Zinc						
Code	Trade Size #	Thickness in.	Working Load Limit lbs.	Pack ft.	Weight / 100 ft. lbs.	Packaging
51060	# 8	.029	75	200	4	Reel
51061	# 35	.035	106	100	6	Reel



Safety Chain - brass

This flat link chain is commonly used for plumbing fixtures.

Brass						
Code	Trade Size #	Thickness in.	Working Load Limit lbs.	Pack ft.	Weight / 100 ft. lbs.	Packaging
51065	1/0	.023	35	200	2	Reel

Electrical Fixture Chain



SINGLE JACK



DOUBLE LOOP

Code	Trade Size #	Dimensions in.			Working Load Limit lbs.	Pack ft.	Weight lbs.	Packaging
		Dia.	Inside Length	Inside Width				
52517	# 3 Double loop	.080	1.10	.187	90	800 (8 x 100')	48	Box
51054	# 4 Double loop	.072	1.02	.171	70	250	12.5	Reel
51039	# 10T Single Jack	.125	1.26	-	43	500 (10 x 50')	60	Box
52113	# 10T Single Jack	.125	1.26	-	43	250	30	Reel
51029	# 12 Single Jack	.105	0.77	-	29	500 (10 x 50')	45	Box



"S" Hook For Fixture Chain, #105

Code	Type	Size or Diameter in.	Inside Length in.	Weight / box lbs.	Packaging	Qty/Pack	Pack/CTN
70929	"S" Hooks	1/8	1.25	14	Box	1000 (10x100)	1



Bead Chain



Code	Trade Size #	Dia. & Ins. Dim. in.	Working Load Limit lbs.	Pack ft.	Weight per 100 ft. lbs.	Packaging
51130	#6 Steel Nickel Plated	.125 dia.	6	100	2	Reel
51132	#6 Brass Bright	.125 dia.	6	100	2	Reel
51134	#6 Brass Nickel Plated	.125 dia.	6	100	2	Reel
51136	#6 Stainless Steel	.125 dia.	6	100	2	Reel
51131	#10 Steel Nickel Plated	.178 dia.	12	100	3	Reel
51135	#10 Brass Nickel Plated	.178 dia.	12	100	3	Reel

Bead Chain Connectors - steel

Code	Trade Size # Finish	Packaging	Qty / Pack	Pack/CTN
55000	#6 Brass Bright	Bag	100	1
55002	#6 Nickel	Bag	100	1
55030	#6 Brass	Card	8	1
55004	# 6 Nickel	Card	6	10
55001	#10 Brass Bright	Bag	100	10
55003	#10 Nickel	Bag	100	1
55031	# 10 Nickel	Card	8	10
55032	#10 Brass Bright	Card	8	10



Hobby / Craft Chain - steel

Code	Trade Size #	Dimensions in.			Working Load Limit lbs.	Pack ft.	Weight per 100 ft. lbs.	Packaging
		Dia.	Inside Length	Inside Width				
51111	#5 Clock Brass Plated	.051	.315	.105	13	82	1.3	Reel
51112	#5 Clock Nickel Plated	.051	.315	.105	13	82	1.3	Reel
51113	#7 Clock Brass Plated	.063	.315	.130	18	82	1.6	Reel
51114	#7 Clock Nickel Plated	.063	.315	.130	18	82	1.6	Reel
51115	#2 Sash Chrome Plated	.043 ga	-	.532	29	164	.7	Reel
51117	#3 Sash Chrome Plated	.059 ga	-	.519	35	82	2.0	Reel
51118	#70 Twist Brass Plated	.047	.154	.030	15	82	2.6	Reel
51119	#90 Twist Brass Plated	.059	.260	.122	20	82	3.5	Reel
51120	#90 Twist Nickel Plated	.059	.260	.122	20	82	3.5	Reel
51121	#200 Twist Brass Plated	.079	.360	.122	29	49	4.7	Reel
51122	#200 Twist Nickel Plated	.079	.360	.122	29	49	4.7	Reel
51123	#250 Twist Brass Plated	.099	.284	.170	35	33	8.5	Reel
51124	#250 Twist Nickel	.099	.284	.170	35	33	8.5	Reel
51125	#19 Oval Link Brass Plated	.043	.205	.110	7	82	2.1	Reel
51126	#36 Ball Chain Chrome Plated	.142	-	-	11	164	1.6	Reel



CLOCK



SASH



TWIST



OVAL



BALL



Cold Shuts (zinc plated steel, mild steel)

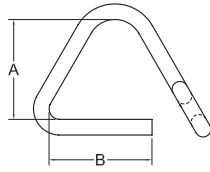

Code	Chain Size in.	Weight / ea. lbs.	Dimensions in.	
			A	B
MF-316	3/16	0.03	15/16	1 1/32
MF-014	1/4	0.06	1	3/8
MF-516	5/16	0.10	1 3/16	7/16
MF-038	3/8	0.18	1 5/16	5/8
MF-716	7/16	0.27	1 1/2	9/16
MF-012	1/2	0.38	1 9/16	3/4

Replacement Links (Hot dip galvanized, forged steel, quenched and tempered)

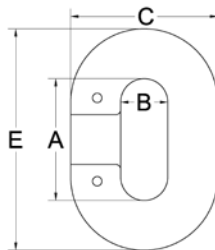

Code	Chain Size in.	Working Load Limit lbs.	Weight per 100 lbs.	Dimensions in.			
				A	B	C	E
G335-316	3/16	800	2.50	.69	.34	.78	1.19
G335-014	1/4	1325	6.25	.88	.44	1.00	1.50
G335-516	5/16	1950	12.50	.94	.47	1.16	1.69
G335-038	3/8	2750	20.00	1.13	.56	1.38	2.06
G335-716	7/16	3625	27.50	1.28	.59	1.53	2.34
G335-012	1/2	4750	37.50	1.47	.66	1.72	2.66
G335-058	5/8	7250	72.50	1.81	.78	2.09	3.31
G335-034	3/4	10250	122.50	2.13	.94	2.50	3.88
G335-078	7/8	12000	175.00	2.50	1.13	2.94	4.50
G335-001	1	15500	250.00	2.75	1.25	3.31	5.00

Safety Factor 4:1

Lap Links (zinc plated steel, cold drawn mild steel)



Code	Chain Size in.	Weight / ea. lbs.	Dimensions in.
			A
LAPZ-018	1/8	0.01	3/4
LAPZ-316	3/16	0.03	1
LAPZ-014	1/4	0.07	1 1/2
LAPZ-516	5/16	0.13	1 1/2
LAPZ-038	3/8	0.26	2
LAPZ-716	7/16	0.56	2 1/4
LAPZ-012	1/2	0.53	2 1/2

Federal Specification : RR-C-271D





Twisted Polypropylene Rope, 3 Strands

An economical, durable, lightweight, general-purpose cord that floats. It is also resistant to oil, gas and mould. It is used widely in industry, business and construction and for residential use.



Code	Size		Length		Color	Packaging	Pack/CTN
	mm	in.	m.	ft.			
60167	4,8	3/16	648	2125	Yellow	Reel	1
60191	6,4	1/4	396	1300	Yellow	Reel	1
60196	7,9	5/16	274	900	Yellow	Reel	1
60213	9,5	3/8	183	600	Yellow	Reel	1
60215	12,7	1/2	102	335	Yellow	Reel	1
60223-IND	16	5/8	61	200	Yellow	Reel	1
60229	19	3/4	48	150	Yellow	Reel	1

High Performance Synthetic Winch Cable (UHMWPE*)

An alternative to wire rope at 1/7th the weight of same size wire rope. This synthetic cable will not rust, is non-rotational and has same stretch attributes as wire rope.



Code	Size		Length		Color	Packaging
	mm	in.	m.	ft.		
WCD-316050	4,8	3/16	15	50	Blue	Bag
WCD-014050	6,4	1/4	15	50	Blue	Bag

UHMWPE* : Ultra-High Molecular Weight Polyethylene

High Performance Synthetic Cable (UHMWPE*)

Code	Size		Color	Breaking strength lbs.
	mm	in.		
60806	4	3/16	Blue	4945
60803	4	1/4	Blue	7508
60804	8	5/16	Blue	10116
60805	9	3/8	Blue	11577
60809	12,7	1/2	Blue	25291



UHMWPE* : Ultra-High Molecular Weight Polyethylene

This heavy-duty nylon rope will not shrink nor harden with use, and will maintain its flexibility for excellent handling.

Code	Size		Color	Breaking strength lbs.
	mm	in.		
60817	9,5	3/8	White	4840
60819	12,7	1/2	White	8580
60821	16	5/8	White	14400
60823	19	3/4	White	19100
60824	25,4	1	White	34000
60825	32	1 1/4	White	51100
60826	38	1 1/2	White	72600
60828	51	2	White	128000

Heavy Duty Nylon 2/1 Rope





Tools

Hand Swagers, 1 cavity



Length : 20" — Weight : 4.2 lbs.



Length : 28" — Weight : 5 lbs.



Length : 8" — Weight : 8oz

Code	For Oval Sleeves	For Stop Sleeves	For Oval Sleeves Stainless Steel	Made in
HS-0A	3/64	3/64	5/64 – 1/16	USA
HS-0B	1/16	1/16	3/32	USA
HS-0C	3/32	3/32 – 1/8	1/8	USA
HS-0D	1/8	5/32 – 3/16 – 7/32	5/32	USA
HS-0E	5/32	—	3/16	USA
HS-0F	3/16	—	7/32	USA

Code	For Oval Sleeves	For Stop Sleeves	Made in
HS-1A	7/32	7/32	USA
HS-1B	1/4	1/4 – 9/32 – 5/16	USA
HS-1C	9/32	—	USA
HS-1D	5/16	—	USA
HS-1E	3/8	—	USA
HS-1F	1/4 - 5/16	—	Japan

Code	For Oval Sleeves	For Stop Sleeves	Made in
S132	1/32	1/32	USA
S1532	3/64	3/64	USA
S232	1/16	1/16	USA

Functional Swagers



Length : 14" — Weight : 2 lbs.

Code	For Oval Sleeves	For Stop Sleeves	Made in
HS-2	3/64 – 1/16 – 3/32	3/64 – 1/16 – 3/32 – 1/8	USA
HS-2A	1/16 – 3/32	1/16 – 3/32 – 1/8	Japan
70292	1/16 – 3/16	1/16 – 3/16	China

Pocket Hand Swagers



Length : 9" — Weight : 12 oz.

Code	For Oval Sleeves	For Stop Sleeves	Made in
HS-3	1/32 – 3/64 – 1/16	1/32 – 3/64 – 1/16	USA

Multicompression Hand Swagers with Cable Cutter

Length : 28" — Weight : 6.5 lbs.



S2632H



HS5

Code	For Oval Sleeves	For Stop Sleeves	Made in
S2632H	1/16 – 3/32 – 1/8 – 5/32 – 3/16	1/16 – 3/32 – 1/8 – 5/32 – 3/16 – 7/32	USA
HS-5	1/16 – 3/32 – 1/8 – 5/32 – 3/16	1/16 – 3/32 – 1/8 – 5/32 – 3/16 – 7/32	Japan

Bench Swagers

Length 22.5" , Height 6.25" (height with handle up 24"), Weight 6.6 lbs.



BS-1

Code	For Oval Sleeves	For Stop Sleeves	Made in
BS-1	1/16 – 3/32 – 1/8 – 5/32 – 3/16	1/16 – 3/32 – 1/8 – 5/32 – 3/16 – 7/32	Japan



Chain Cutters

Code	Product	For diameter in. Maximum	Weight lbs.	Pack/CTN
55020	#25	1/4 G30	5	1
55021G	#44	3/8 G40	35	1
55023G	#88	1/2 G40 - 3/8 G70	46	1
55024G	#88 kit	1/2 G40 - 3/8 G70	2	1
55025	#88 Carbide teeth	1/2 G40 - 3/8 G70	-	2



"Felco" Wire Rope Cutters, Switzerland

Code	For Cable Diameter in.	Length in.	Weight ea. lbs.
FC-7	0 - 3/16	8	0.625
FC-9	0 - 1/4	13	1.500
FC-12	0 - 3/8	19	3.000
FC-16	0 - 5/8	23	5.000



Wire Rope Cutters

Code	For Cable Diameter in.	Length in.	Weight ea. lbs.	Made in
RC-8	Up to 3/16	8	0.66	Japan
70293	Up to 3/16	8	0.66	China
RC-450	Up to 1/2	19	3.00	Japan
RC-800	Up to 5/8	23	5.00	Japan



Wire Rope Cutter, USA

Code	For Cable Diameter in.	Length in.	Weight ea. lbs.
C632	Up to 3/16	8	5.5



Hammer Cable Cutters

Code	Description	For Cable Diameter in.
SFCC-1	Model #1	up to 3/4
SFCC-1A	Model #1A	up to 1 1/16
SFCC-2	Model #2	up to 1 1/2



Spare Parts

Code	Description	For Cable Diameter in.
SFPIS-1	Piston for Model #1	0 - 3/4
SFPIS-1A	Piston for Model #1A	0 - 1 1/16
SFPIS-2	Piston for Model #2	0 - 1 1/2
SFTB-1-1A	Top blade + pin for Model #1 and 1A	(0 - 3/4) et (0 - 1 1/16)
SFTB-2	Top Blade + pin for Model #2	0 - 1 1/2
SFBB-1	Bottom blade(pair) for Model #1	0 - 3/4
SFBB-1A	Bottom blade (pair) for Model #1A	0 - 1 1/16
SFBB-2	Bottom blade (pair) for Model #2	0 - 1 1/2





Forestry

Forestry chokers

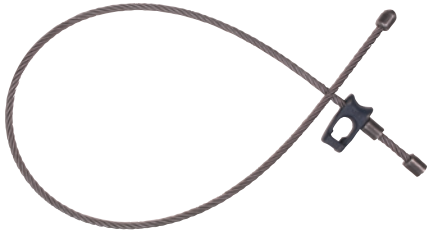

TYPE 3 BUTTONS

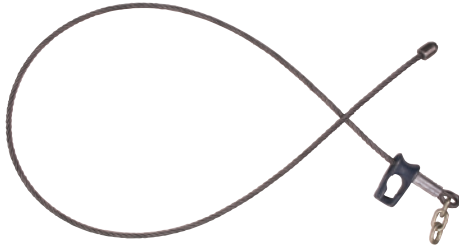

CHAIN TYPE

Code Type 3 (buttons)	Code Chain Type	Diameter x length in. x ft.	Minimum Breaking Strength lbs.
SFE3-716005	SFEC-716005	7/16 x 5	17,200
SFE3-716512	SFEC-716512	7/16 x 5 1/2	17,200
SFE3-716006	SFEC-716006	7/16 x 6	17,200
SFE3-716612	SFEC-716612	7/16 x 6 1/2	17,200
SFE3-716007	SFEC-716007	7/16 x 7	17,200
SFE3-716008	SFEC-716008	7/16 x 8	17,200
SFE3-012006	SFEC-012006	1/2 x 6	23,600
SFE3-012612	SFEC-012612	1/2 x 6 1/2	23,600
SFE3-012007	SFEC-012007	1/2 x 7	23,600
SFE3-012008	SFEC-012008	1/2 x 8	23,600
SFE3-012009	SFEC-012009	1/2 x 9	23,600
SFE3-012010	SFEC-012010	1/2 x 10	23,600
SFE3-916010	SFEC-916010	9/16 x 10	28,600
SFE3-916011	SFEC-916011	9/16 x 11	28,600
SFE3-916012	SFEC-916012	9/16 x 12	28,600
SFE3-916013	SFEC-916013	9/16 x 13	28,600
SFE3-916014	SFEC-916014	9/16 x 14	28,600
SFE3-916015	SFEC-916015	9/16 x 15	28,600

Extensions (type 2 buttons)

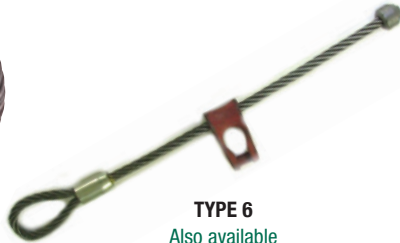

TYPE 6
Also available

Code	Diameter x length in.	Minimum Breaking Strength lbs.
SFE2-716112	7/16 x 18	17,200
SFE2-716002	7/16 x 24	17,200
SFE2-012112	1/2 x 18	23,600
SFE2-012002	1/2 x 24	23,600
SFE2-916112	9/16 x 18	28,600
SFE2-916002	9/16 x 24	28,600

Main Lines with Swaged button



Swaged Cable			
Code	Diameter x length in. x ft.	Minimum Breaking Strength lbs.	Weight / ft. approx. lbs.
SFCPB-012	1/2 x 100	31,400	0.67
SFCPB-916	9/16 x 100	38,900	0.80
SFCPB-058	5/8 x 100	46,400	0.96
SFCPB-1116	11/16 x 100	54,400	1.20
SFCPB-034	3/4 x 100	68,800	1.55

Super-Swaged Cable			
Code	Diameter x length in. x ft.	Minimum Breaking Strength lbs.	Weight / ft. approx. lbs.
SFCPB-012S	1/2 x 100	33,600	0.67
SFCPB-916S	9/16 x 100	41,000	0.80
SFCPB-058S	5/8 x 100	54,400	0.96
SFCPB-1116S	11/16 x 100	67,400	1.20
SFCPB-034S	3/4 x 100	72,200	1.55

Any length available upon request.

Logging Chain



Code	Diameter in.	Grade	Finish	Length ft.	Working Load Limit lbs.	Weight / ea. lbs.
56001	1/4	30	Self-colored	14	1,100	8
56002	5/16	30	Self-colored	14	1,900	12
56003	3/8	30	Self-colored	14	2,650	17
56006	1/2	30	Self-colored	14	4,500	33

Safety factor : 4:1



Sliding Hooks for chokers

Code	Description	For Chokers Diameter in.
SFMIC	MICRO	7/16 – 1/2
SFMID	MIDGET	3/8 – 9/16
SFBAN	BANTAM	9/16 – 5/8



SFMID

Rings for Main-lines

Code	Description
SFMLR-TH	TWITCH-HOOK
SFMLR-E	With reversed eye
SFGS-516	Spiral pin – 5/16 x 2



SFMLR-E



SFGS-516



SFMLR-TH

Buttons

Code	Description	For Chokers Diameter in.
SFBC-XXX	3/8, 7/16, 1/2, 9/16, 5/8 Taper sleeves	3/8, 7/16, 1/2, 9/16, 5/8
SFBP-XXX	3/8, 7/16, 1/2, 9/16, 5/8 Straight wall	3/8, 7/16, 1/2, 9/16, 5/8



SFBC

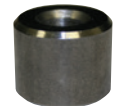

SFBP

Choker Sliding Hooks (forged carbon steel, quenched and tempered)

Code WITHOUT latch	Code WITH latch	For cable diameter in.	Eye diameter in.	Throat opening in.	Weight / ea. approx. lbs.
A350-038	A350L-038	3/8	1 1/16	5/8	0.75
A350-012	A350L-012	1/2	3/4	25/32	1.25
A350-058	A350L-058	5/8	7/8	15/16	3.10
A350-034	A350L-034	3/4	1	1 5/32	5.17



6 X 26 Super-swaged

Super-Swaged			
Code	Diameter In.	Minimum Breaking Strength lbs.	Weight per 100 ft. lbs.
038626BSS	3/8	20,400	35
716626BSS	7/16	26,000	46
012626BSS	1/2	34,800	72
916626BSS	9/16	43,800	87
058626BSS	5/8	54,000	104
1116626BSS	1 1/16	65,000	122
034626BSS	3/4	77,000	185
078626BSS	7/8	104,000	209
001626BSS	1	133,000	244

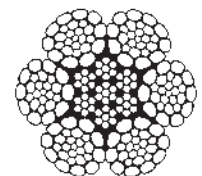

6 X WS(26) IWRC

6 X 26 Swaged

Regular Swaged			
Code	Diameter In.	Minimum Breaking Strength lbs.	Weight per 100 ft. lbs.
038626BS	3/8	18,500	35
716626BS	7/16	24,300	46
012626BS	1/2	31,800	59
916626BS	9/16	40,000	72
058626BS	5/8	49,000	87
1116626BS	1 1/16	59,000	104
034626BS	3/4	70,000	122
078626BS	7/8	95,000	185
001626BS	1	123,000	209

8 X 36 Steel Core (Natural) EIPS

Code	Diameter In.	Minimum Breaking Strength lbs.	Weight per 100 ft. lbs.
058836B	5/8	36,200	67



Transport

Tie-Down Accessories



DR2



DR3

Delta Rings

Code	Material width in.	Weight / lbs.
DR2	2	0.2
DR3	3	0.8



MCC2



MCC4



PCC

Corner Caps

Code	Material width in.	Weight / lbs.
MCC2	1 3/4 - 2	-
MCC4	2 - 4	-
PCC	2 - 4	0.2



Load Anchor

Code	Chain Size in.	Working load limit lbs.	Working load limit Ton	Dimension Width x Length mm
LA	5/16	13,200	6	103 x 130



"E" Fitting

Code	Material width in.	Weight / lbs.
3040900	2 (BS 4,500 lbs.)	0.2



Ratchet Buckles

Code	Material width in.	Weight / lbs.
RAT1	1	1.0
RAT2L	1 3/4	2.5
RAT3L	3	7.0



Rubber Straps w/ "S" Hooks

Code	Length in.	Weight / lbs.
TC9	9	0.2
TC21	21	0.3
TC31	31	0.4
TC41	41	0.5

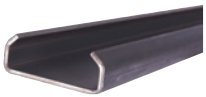

Sliding Bars

Code	Length in.	Weight / lbs.
RAIL6	72	35.0





Snap Hook

Code	Hook Type	Material width in.	Weight / lbs.
3010250	Snap	1	0.2
3020253	Snap	2 (BS 6,000 lbs.)	0.4
3020254	Snap	2 (BS 10,000 lbs.)	0.6
3020255	Long Snap	2 (BS 10,000 lbs.)	0.7
3020251	Twisted Snap	2 (BS 10,000 lbs.)	0.6



TWISTED



LONG

Flat Hooks

Code	Material width in.	Weight / lbs.
CP2	2	0.7
CP3	3	1.1
CP4	4	2.0

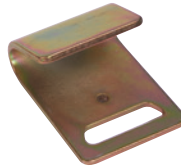

Narrow Wire Hooks

Code	Material width in.	Weight / lbs.
CF1	1	0.1
CF2	2	0.6
CF3	3	1.6



Vinyl "S" Hook

Code	Material width in.	Weight / lbs.
3010330	1 (BS 1,200 lbs.)	0.3



Side Winches

Code	Material width in.	Weight / lbs.
TRS2	2	3.5
TRS5	5	9.0



TRS5



TRS2

Chain Assembly

Code	Material width in.	Weight / lbs.
TCC2	2	2.3
TCC3	3	3.6
TCC4	4	4.2



Winch Bars

Code	Length in.	Weight / lbs.
BAR	30	5.0





Winch Cables



Steel Core														
Code	Diameter po	Breaking Strength lbs.	Hook Capacity Ton	Length ft.										
				50	60	65	70	75	80	85	90	95	100	125
WCWR-516_---	5/16	10 500	1	050	060	065	070	075	080	085	090	095	100	125
WCWR-038_---	3/8	15 100	2	050	060	065	070	075	080	085	090	095	100	125
WCWR-716_---	7/16	20 400	3	050	060	065	070	075	080	085	090	095	100	125
WCWR-012_---	1/2	26 600	3	050	060	065	070	075	080	085	090	095	100	125
WCWR-916_---	9/16	33 600	4,5	050	060	065	070	075	080	085	090	095	100	125
WCWR-058_---	5/8	41 200	4,5	050	060	065	070	075	080	085	090	095	100	125
WCWR-034_---	3/4	58 800	7	050	060	065	070	075	080	085	090	095	100	125

Example for item code: WCWR-516**050** (Winch Cable Wire Rope 5/16 X 50 ft.)

Fiber Core														
Code	Diameter po	Breaking Strength lbs.	Hook Capacity Ton	Length ft.										
				50	60	65	70	75	80	85	90	95	100	125
WCWR-516__FC	5/16	8 500	1	050	060	065	070	075	080	085	090	095	100	125
WCWR-038__FC	3/8	12 200	2	050	060	065	070	075	080	085	090	095	100	125
WCWR-716__FC	7/16	16 500	3	050	060	065	070	075	080	085	090	095	100	125
WCWR-012__FC	1/2	21 400	3	050	060	065	070	075	080	085	090	095	100	125
WCWR-916__FC	9/16	27 000	4,5	050	060	065	070	075	080	085	090	095	100	125
WCWR-058__FC	5/8	33 400	4,5	050	060	065	070	075	080	085	090	095	100	125
WCWR-034__FC	3/4	47 600	7	050	060	065	070	075	080	085	090	095	100	125

Example for item code: WCWR-516**050FC** (Winch Cable Wire Rope Fiber Core 5/16 X 50 ft.)

**Other constructions available upon request. **Other lengths available upon request.



Roll Off Cables, 6x26



ROCSH



ROCTH



ROCB

Diameter in.	Breaking Strength lbs.	TYPE	Length ft.		
			50	75	100
5/8	41,200	Thimble	ROCTH-058050	ROCTH-058075	ROCTH-058100
5/8	41,200	Button	ROCB-058050	ROCB-058075	ROCB-058100
5/8	41,200	Swivel hook	ROCSH-058050	ROCSH-058075	ROCSH-058100
3/4	58,800	Thimble	ROCTH-034050	ROCTH-034075	ROCTH-034100
3/4	58,800	Button	ROCB-034050	ROCB-034075	ROCB-034100
3/4	58,800	Swivel hook	ROCSH-034050	ROCSH-034075	ROCSH-034100
7/8	79,600	Thimble	ROCTH-078050	ROCTH-078075	ROCTH-078100
7/8	79,600	Button	ROCB-078050	ROCB-078075	ROCB-078100
7/8	79,600	Swivel hook	ROCSH-078050	ROCSH-078075	ROCSH-078100
1	103,400	Thimble	ROCTH-001050	ROCTH-001075	ROCTH-001100
1	103,400	Button	ROCB-001050	ROCB-001075	ROCB-001100
1	103,400	Swivel hook	ROCSH-001050	ROCSH-001075	ROCSH-001100

Roll Off Cables, 6x36

Diameter in.	Breaking Strength lbs.	TYPE	Length ft.		
			50	75	100
5/8	41,200	Thimble	ROCTH-058050636	ROCTH-058075636	ROCTH-058100636
5/8	41,200	Button	ROCB-058050636	ROCB-058075636	ROCB-058100636
5/8	41,200	Swivel hook	ROCSH-058050636	ROCSH-058075636	ROCSH-058100636
3/4	58,800	Thimble	ROCTH-034050636	ROCTH-034075636	ROCTH-034100636
3/4	58,800	Button	ROCB-034050636	ROCB-034075636	ROCB-034100636
3/4	58,800	Swivel hook	ROCSH-034050636	ROCSH-034075636	ROCSH-034100636
7/8	79,600	Thimble	ROCTH-078050636	ROCTH-078075636	ROCTH-078100636
7/8	79,600	Button	ROCB-078050636	ROCB-078075636	ROCB-078100636
7/8	79,600	Swivel hook	ROCSH-078050636	ROCSH-078075636	ROCSH-078100636
1	103,400	Thimble	ROCTH-001050636	ROCTH-001075636	ROCTH-001100636
1	103,400	Button	ROCB-001050636	ROCB-001075636	ROCB-001100636
1	103,400	Swivel hook	ROCSH-001050636	ROCSH-001075636	ROCSH-001100636

Winch straps - all sizes

Code	Length ft.	Working Load Limit lbs.	Type	End Hardware
WSWH2-30	30	3,335	2" Winch strap	Wire Hook
WSFH2-30	30	3,335	2" Winch strap	Flat Hook
WSCA2-30	30	3,335	2" Winch strap	Chain Assembly
WSWH3-30	30	5,000	3" Winch strap	Wire Hook
WSFH3-30	30	5,400	3" Winch strap	Flat Hook
WSCA3-30	30	5,400	3" Winch strap	Chain Assembly
WSDR3-30	30	5,400	3" Winch strap	Dee Ring
WSFH4-30	30	5,400	4" Winch strap	Flat Hook
WSCA4-30	30	6,000	4" Winch strap	Chain Assembly

Custom sizes available.



WSWH



WSFH



WSCA



WSDR

! WARNING: The maximum loads shown are applicable for products in new conditions.

! Do not exceed maximum rated capacities.



1" Straps

1" Utility straps are used for securing motorcycles, snowmobiles, or small equipment. 1" straps are available in wide range of colors.

Code	Diameter x length in. x ft.	Working Load Limit lbs.	Type	End Hardware
CSSH1-6	1 x 6	500	Cam Strap	Vinyl "S" Hook
RSSH1-10	1 x 10	800	Ratchet Strap	Vinyl "S" Hook
RSSH1-16	1 x 16	800	Ratchet Strap	Vinyl "S" Hook
RSWH1-12	1 x 12	1,100	Ratchet Strap	Wire Hook
RSWH1-16	1 x 16	1,100	Ratchet Strap	Wire Hook
RSWHD1-16	1 x 16	1,100	Ratchet Strap	Wire Hook & Dee Ring
RSWH1-20	1 x 20	1,100	Ratchet Strap	Wire Hook

Custom sizes available.



2" Straps

Standard Ratchet straps are made with Long Wide Handle Ratchet Buckle.

Code	Diameter x length in. x ft.	Working Load Limit lbs.	Type	End Hardware
RSWH2-20	2 x 20	3,335	Ratchet Strap	Wire Hook
RSWH2-25	2 x 25	3,335	Ratchet Strap	Wire Hook
RSWH2-27	2 x 27	3,335	Ratchet Strap	Wire Hook
RSWH2-30	2 x 30	3,335	Ratchet Strap	Wire Hook
RSFH2-25	2 x 25	3,335	Ratchet Strap	Flat Hook
RSFH2-30	2 x 30	3,335	Ratchet Strap	Flat Hook
RSCA2-25	2 x 25	3,335	Ratchet Strap	Chain Assembly
RSCA2-30	2 x 30	3,335	Ratchet Strap	Chain Assembly
RSEN2-20	2 x 20	3,335	Ratchet Strap	Endless
RSEN2-25	2 x 25	3,335	Ratchet Strap	Endless

Custom sizes available.

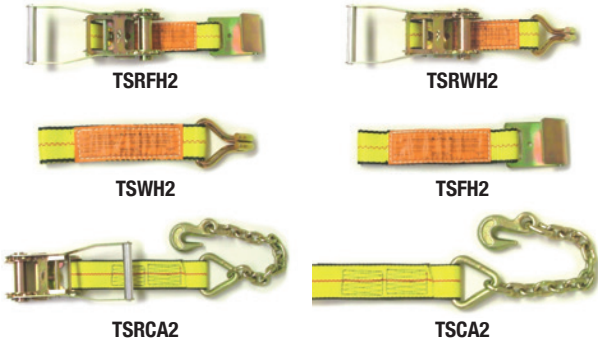

2" Tail Straps

Code	Diameter x length in. x in.	Working Load Limit lbs.	Type	End Hardware
TSRWH2-18	2 x 18	3,335	Ratchet Tail	Wire Hook
TSRFH2-18	2 x 18	3,335	Ratchet Tail	Flat Hook
TSRCA2-33	2 x 33	3,335	Ratchet Tail	Chain Assembly
TSWH2-12	2 x 12	3,335	1" Loop	Wire Hook
TSFH2-12	2 x 12	3,335	1" Loop	Flat Hook
TSCA2-30	2 x 30	3,335	1" Loop	Chain Assembly



3" & 4" Straps

Code	Diameter x length in. x ft.	Working Load Limit lbs.	Type	End Hardware
RSWH3-30	3 x 30	5,000	Ratchet strap	Wire Hook
RSFH3-30	3 x 30	5,400	Ratchet strap	Flat Hook
RSCA3-30	3 x 30	5,400	Ratchet strap	Chain Assembly
RSDR3-30	3 x 30	5,400	Ratchet strap	Dee Ring
RSFH4-30	4 x 30	5,400	Ratchet strap	Flat Hook
RSCA4-30	4 x 30	6,000	Ratchet strap	Chain Assembly

Custom sizes available.

WARNING: The maximum loads shown are applicable for products in new conditions.

! Do not exceed maximum rated capacities.



White Tie Downs

1" White tie-downs are great to tighten tents, tarps or awnings.



Van Straps



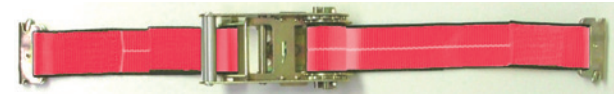



Standard van straps are made with short handle ratchet buckle.



Code	Diameter x length in. x ft.	Working Load Limit lbs.	Type	End Hardware
RSEF2-12	2 x 12	1,500	Ratchet Strap	E-Fitting
RSEF2-16	2 x 16	1,500	Ratchet Strap	E-Fitting

Custom sizes available.

Load Binders

Code	Product	Chain Size in.	Capacity lbs.	Weight lbs.	
55005	BX 270 Style	3/16 (G30)	375	1.0	
55006	BX 271 Style	1/4 (G30 - G40) 5/16 (G30)	2,600	3.5	 *
55007	BX 320 Style	5/16 (G40 - G70) 3/8 (G40)	5,400	7.0	
55008	BX 400 Style	3/8 (G40 - G70) 1/2 (G40)	9,200	10.5	
55009	BX 600 Style	5/16 (G40 - G70) 3/8 (G40)	5,400	10.25	 *
55010	BX 800 Style	3/8 (G40 - G70) 1/2 (G40)	9,200	14.0	
55014	Ratchet Type	1/4 (G40 - G70) 5/16 (G30)	2,600	3.85	
55015	Ratchet Type	5/16 (G40 - G70) 3/8 (G40)	5,400	10.8	
55016	Ratchet Type	3/8 (G40 - G70) 1/2 (G40)	9,200	12.75	
55017	Ratchet Type	1/2 (G40 - G70) 5/8 (G40)	13,000	14.55	
LB150-012	Lever Type	1/2 (G40 - G70) 5/8 (G40)	11,000	20	

*Forged steel, quenched and tempered. Stamped with Working Load Limit, size and matching chain grade.

Load Binder Locks

Code	Dimensions		Weight lbs.
	Length in.	Width in.	
BL12017	4.25	1.85	0.40

Designed for: 55005, 55006, 55007, 55008, 55009, 55010, LB150-012

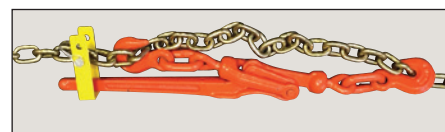



Tie Down Chain (Grade 40 – self-colored)



Code Bulk	Code Packaged	Diameter in.	Grade	Length ft.	Working Load Limit lbs.	Weight ea. lbs.
SGG40516010-00	56055	5/16	40	10	3,900	10
SGG40516012-00	56058	5/16	40	12	3,900	12
SGG40516014-00	56061	5/16	40	14	3,900	14
SGG40516016-00	56064	5/16	40	16	3,900	16
SGG40516020-00	56067	5/16	40	20	3,900	20
SGG40516025-00	56070	5/16	40	25	3,900	25
SGG40038010-00	56056	3/8	40	10	5,400	14
SGG40038012-00	56059	3/8	40	12	5,400	17
SGG40038014-00	56062	3/8	40	14	5,400	20
SGG40038016-00	56065	3/8	40	16	5,400	22
SGG40038020-00	56068	3/8	40	20	5,400	28
SGG40038025-00	—	3/8	40	25	5,400	35
SGG40012010-00	—	1/2	40	10	9,200	23
SGG40012012-00	—	1/2	40	12	9,200	28
SGG40012014-00	—	1/2	40	14	9,200	32
SGG40012016-00	—	1/2	40	16	9,200	37
SGG40012020-00	—	1/2	40	20	9,200	46

Safety factor : 3:1

Agricultural Safety Chain for Towed Machines (Grade 70)



Code Bulk	Code Packaged	Chain Size in.	Length ft.	Tow Capacity lbs.	Weight / ea. lbs.
ASC-01405	56011	1/4	5	10,000	5.5
ASC-01406	56013	1/4	6	10,000	5.5
ASC-51605	56012	5/16	5	16,100	8.5
ASC-51606	56014	5/16	6	16,100	8.5
ASC-03805	56009	3/8	5	20,000	11.5
ASC-03806	56015	3/8	6	20,000	11.5
ASC-01205	56010	1/2	5	40,000	18.5
ASC-01206	56016	1/2	6	40,000	19.5

Custom sizes available on request.

Tow Chain (Grade 70)



Code Bulk	Code Packaged	Chain Size in.	Length ft.	WLL lbs.	Weight / ea. lbs.
SGS70516006-00	—	5/16	6	4,300	7.5
SGS70516010-00	—	5/16	10	4,300	11.5
SGS70516014-00	56115	5/16	14	4,300	16.5
SGS70038004-00	—	3/8	4	5,250	7
SGS70038006-00	—	3/8	6	5,250	11
SGS70038008-00	—	3/8	8	5,250	13.5
SGS70038010-00	—	3/8	10	5,250	16.5
SGS70038012-00	—	3/8	12	5,250	19
SGS70038016-00	56116	3/8	16	5,250	25
SGS70012012-00	—	1/2	12	9,000	31
SGS70012016-00	—	1/2	16	9,000	44

Safety factor : 4:1

Cable and Chain Tie Down (Tagged)



Code	Cable	Chain	Hook	WLL lbs.	Weight / ea. lbs.
CCTD-01429	7 x 19 Galv., 1/4" x 29'	GR. 70 1/4" x 1'	CGH70-516	2,333	4.698

Safety factor : 3:1

Other combinations of cables, chain and hook available upon request.



Tie Down Chain (Grade 70 – Chromate Gold)

Code Bulk	Code Packaged	Diameter in.	Grade	Length ft.	Working Load Limit lbs.	Weight ea. lbs.
SGG70516010-00	56017	5/16	70	10	4,700	10
SGG70516012-00	56018	5/16	70	12	4,700	12
SGG70516014-00	56004	5/16	70	14	4,700	14
SGG70516016-00	56029	5/16	70	16	4,700	16
SGG70516020-00	56032	5/16	70	20	4,700	20
SGG70516025-00	56022	5/16	70	25	4,700	25
SGG70038010-00	56021	3/8	70	10	6,600	15
SGG70038012-00	56024	3/8	70	12	6,600	18
SGG70038014-00	56025	3/8	70	14	6,600	21
SGG70038016-00	56030	3/8	70	16	6,600	24
SGG70038020-00	56005	3/8	70	20	6,600	30
SGG70038025-00	—	3/8	70	25	6,600	37
SGG70012010-00	—	1/2	70	10	11,300	23
SGG70012012-00	—	1/2	70	12	11,300	28
SGG70012014-00	—	1/2	70	14	11,300	32
SGG70012016-00	—	1/2	70	16	11,300	37
SGG70012020-00	—	1/2	70	20	11,300	46
SGG70012025-00	—	1/2	70	25	11,300	58

Safety factor : 4:1



Grade 70 “Transport” Chain - yellow chromate carbon steel

Grade 70 chain is extremely strong and resistant to wear. It is mainly used for transport tiedowns, towing, lumbering and other similar tasks. Meet NACM standard.

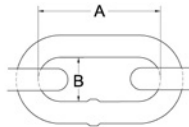

Chromate Gold		
Drum		
Code	Diameter in.	Pack ft.
53040	1/4	400
53041	5/16	275
53042	3/8	200
53043	1/2	100
53047	1/2	200
Pail		
52030	1/4	65
52031	5/16	50
52032	3/8	45
52033	1/2	25

Specifications				
Diameter in.	Inside Dimensions in.		Working Load Limit lbs.	Weight / 100 ft. lbs.
	A	B		
1/4	1.22	.51	3,150	71
5/16	1.28	.53	4,700	102
3/8	1.36	.57	6,600	143
1/2	1.77	.75	11,300	234

Safety Factor 4:1

Test certificate available – Do not use for overhead lifting





Trailer Safety Chain (Class 1)

Code	Chain Diameter in.	Grade	Class	Length in.	Endings	Weight / ea. lbs.
56090	3/16	30	1	36	2 x "S" Hooks 3/8	0.9
56091	3/16	30	1	48	2 x "S" Hooks 3/8	1.2
56092	3/16	30	1	60	2 x "S" Hooks 3/8	1.5
56093	3/16	30	1	72	2 x "S" Hooks 3/8	1.7
56111	3/16	30	1	24	1 x "S" Hook 3/8	0.6
56095	3/16	30	1	30	1 x "S" Hook 3/8	0.7
56096	3/16	30	1	36	1 x "S" Hook 3/8	0.9



Trailer Safety Chain (Class 2)

Code	Chain Diameter in.	Grade	Class	Length in.	Endings	Weight / ea. lbs.
56097	1/4	30	2	36	2 x "S" Hooks 7/16	1.6
56098	1/4	30	2	48	2 x "S" Hooks 7/16	2.1
56099	1/4	30	2	60	2 x "S" Hooks 7/16	2.0
56100	1/4	30	2	72	2 x "S" Hooks 7/16	3.1
56101	1/4	30	2	24	1 x "S" Hook 7/16	1.0
56102	1/4	30	2	30	1 x "S" Hook 7/16	1.3
56103	1/4	30	2	36	1 x "S" Hook 7/16	1.6



Other

Code	Chain Diameter in.	Grade	Class	Length in.	Endings	Weight / ea. lbs.
56113	5/16	30	N/A	40	1 x "S" Hook with latch	3.48
56114	3/8	30	N/A	41	1 x Hook with G43 latch	4.74

Tow Cables and Winch Cables



TOW CABLE



WINCH CABLE

Code	Description
90300	Tow Cable 7/32, 7 x 19 GAC x 25'
90304	Tow Cable 7/32, 7 x 19 GAC x 50'
90301	Tow Cable 5/16, 7 x 19 GAC x 25'
ASY-WC-20R	Winch Cable 1/8, 7 x 7 GAC x 20'
ASY-WC-25	Winch Cable 3/16, 7 x 7 GAC x 25'
90305	Winch Cable 3/16, 7 x 19 GAC x 50'



Whip Restraints, hose-hose type

Code	For Hose Diameter in.	Length in.	Diameter of Cable Used in.	Weight / ea. approx. lbs.
WR1822-15	1/2 – 1 1/4	15	1/8	0.16
WR1822-18	1/2 – 1 1/4	18	1/8	0.19
WR1822-20	1/2 – 1 1/4	20	1/8	0.21
WR1822-22	1/2 – 1 1/4	22	1/8	0.23
WR1422-24	1 1/2 – 3	24	1/4	0.91
WR1422-30	1 1/2 – 3	30	1/4	0.92
WR1422-36	1 1/2 – 3	36	1/4	1.22
WR1422-37.5	1 1/2 – 3	37 1/2	1/4	1.26
WR1422-48	1 1/2 – 3	48	1/4	1.50
WR3822-48	3 1/2 – 6	48	3/8	3.00

Any length available upon request.



Whip Restraints, hose-tool type

Code	For Hose Diameter in.	Length in.	Diameter of Cable Used in.	Weight / ea. approx. lbs.
WR18215	1/2 – 1 1/4	22	1/8	0.21
WR14215	1 1/2 – 3	37 1/2	1/4	1.22
WR1421	1 1/2 – 3	23	1/4	0.73
WR1821	1/2 – 1 1/4	13 1/2	1/8	0.15

Any length available upon request.



Whip Restraints, hose-tool type with snap hook

Code	For Hose Diameter Po. / in.	Length in.	Diameter of Cable Used in.	Weight / ea. approx. lbs.
WR1821-S	1/2 – 1 1/4	14	1/8	0.21

Any length available upon request.

Loop Wire Rope Concrete Anchors

Code	Cable	Working Load Limit TON	Weight / ea. lbs.	Dimensions in.	
				A	B
LWRCA-058	6 x 19 Galv., 5/8"	6	3.72	22	11
LWRCA-038	7 x 19 Galv., 3/8"	2	1.04	18 1/4	9

Wire rope concrete anchor custom made available.

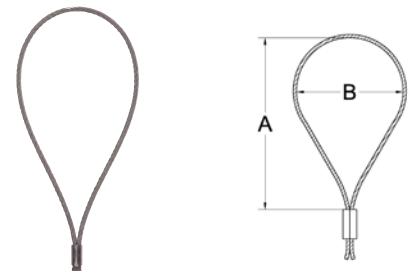

Oval Wire Rope Concrete Anchors (tagged)

Code	Cable	Rod in. x ft.	Working Load Limit TON	Weight / ea. lbs.	Dimensions in.	
					A	B
OWRA-058	6 x 19 Galv., 5/8"	1/8 x 9 1/4	6	3.72	16 3/4	9 1/4
OWRA-034	6 x 19 Galv., 3/4"	1/8 x 9 1/4	8	4.83	18 7/8	9 1/4
OWRA-078	6 x 19 Galv., 7/8"	3/16 x 11	12	8.35	23 1/4	11
OWRA-114	6 x 37 Galv., 1 1/4"	3/16 x 15 3/4	25	21.32	33 15/32	15 3/4

Wire rope concrete anchor custom made available.

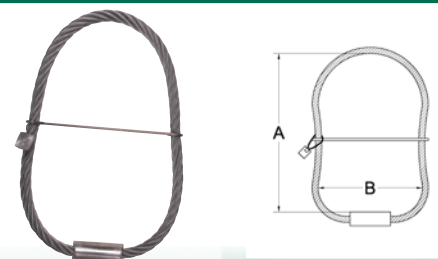



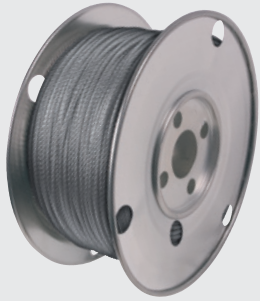

Seismic Solutions

Bracing Cable (galvanized)



	Code	Diameter in.	Construction	Length ft.	Safe Working Load lbs.
 7 x 7	SSBC-3641000	3/64	7X7	1000	35
	SSBC-1160500	1/16	7X7	500	75
	SSBC-3320500	3/32	7X7	500	150
	SSBC-1080500	1/8	7X7	500	250
 7 x 19	SSBC-3160250	3/16	7X19	250	640
	SSBC-1040250	1/4	7X19	250	1.1

*Also available in stainless steel.

Looped Cable

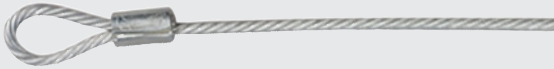

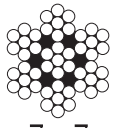
 7 x 7	Diameter in.	Construction	Code / Length in.				Safe Working Load lbs.
			60	120	180	300	
	3/64	7X7	SSLC-364060	SSLC-364120	SSLC-364180	SSLC-364300	35
	1/16	7X7	SSLC-116060	SSLC-116120	SSLC-116180	SSLC-116300	75
	3/32	7X7	SSLC-332060	SSLC-332120	SSLC-332180	SSLC-332300	150
	1/8	7X7	SSLC-018060	SSLC-018120	SSLC-018180	SSLC-018300	250

Sway Bracing Cable With Straight Eyelet

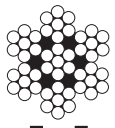

 7 x 7	Diameter in.	Construction	Code / Length in.				Safe Working Load lbs.
			60	120	180	300	
	3/64	7X7	SSSBCSE-364060	SSSBCSE-364120	SSSBCSE-364180	SSSBCSE-364300	35
	1/16	7X7	SSSBCSE-116060	SSSBCSE-116120	SSSBCSE-116180	SSSBCSE-116300	75
	3/32	7X7	SSSBCSE-332060	SSSBCSE-332120	SSSBCSE-332180	SSSBCSE-332300	150
	1/8	7X7	SSSBCSE-018060	SSSBCSE-018120	SSSBCSE-018180	SSSBCSE-018300	250

Sway Bracing Cable With 45° Eyelet

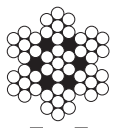

 7 x 7	Diameter in.	Construction	Code / Length in.				Safe Working Load lbs.
			60	120	180	300	
	3/64	7X7	SSSBC45E-364060	SSSBC45E-364120	SSSBC45E-364180	SSSBC45E-364300	35
	1/16	7X7	SSSBC45E-116060	SSSBC45E-116120	SSSBC45E-116180	SSSBC45E-116300	75
	3/32	7X7	SSSBC45E-332060	SSSBC45E-332120	SSSBC45E-332180	SSSBC45E-332300	150
	1/8	7X7	SSSBC45E-018060	SSSBC45E-018120	SSSBC45E-018180	SSSBC45E-018300	250



Wire Rope Cutters



Code	For Cable Diameter in.	Length in.	Weight ea. Lbs.	Made in
RC-8	Up to 3/16	8	0.66	Japan
RC-450	Up to 1/2	19	3.00	Japan

Swagers



Length : 14" — Weight : 2 lbs.

HS-3

Length : 9" — Weight : 12 oz.

HS-2A

HS5

Code	For Cable Diameter in.	For Stop Sleeves in.	Weight ea. Lbs.	Made in
HS-3	1/32 – 3/64 – 3/16	1/32 – 3/64 – 3/16	0.75	USA
HS-2A	1/16 – 3/32	1/16 – 3/32 – 1/8	3	USA
HS-5	1/16 – 3/32 – 1/8 – 5/32 – 3/16	1/16 – 3/32 – 1/8 – 5/32 – 3/16 – 7/32	6.5	Japan

Kwik-Locs

Code	Typical Applications	Cable Diameter in.	Safe Working Load lbs.
SSKL050	Signs, Lighting, Gallery Displays	3/64	5 – 35
SSKL075	Signs, Lighting, Gallery Displays	1/16	10 – 75
SSKL100	Fluorescent Lights, Speakers, Busbar, Cable Trays	3/32	25 – 150
SSKL150	Heavy Cable Basket HID Lights	1/8	25 – 250
SSKL200	Sound Systems, Heavy Cable Trays	3/16	50 – 640
SSKL600	Services, Strut	1/4	50 – 1,100

Safety factor : 5:1



KL50 / KL75 / KL100 / KL150 / KL200 (Assembly Instructions)

- 1) Pull adjustment pin back and pass wire through KWIK-LOC™ failure to pull adjustment pin first may cause damage to serrated teeth and reduce holding capacity.
- 2) Loop wire through anchor.
- 3) Pull adjustment pin back and pass wire back through KWIK-LOC™ push through at least 6" of wire rope.
- 4) Always confirm engagement of KWIK-LOC™ on wire before applying load by pushing the adjustment pin in the opposite direction of the arrows on the cable lock and then pulling the cable also in the opposite direction of the arrows on the cable lock.
Minimum 6 in. /15.21 cm
- 5) To adjust, take the load off and pull the tail slightly to disengage teeth, then release using adjustment pin.

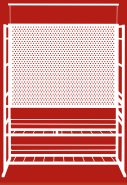

Merchandising

Merchandising At Its Best !

Call your representative for assistance in configuring your own inhouse display.





Packaged Chains

Code	Description	Finish	Dia. in.	Trade size #	Package ft.	Inside Dimension			Working Load Limit lbs.	Weight lbs.	Packaging	Pack/CTN
						Dia.	Inside length	Inside width				
55260	G30	Zinc	1/8	-	16	-	0.69	.25	325	3.2	Pail	6
55261	G30	Zinc	3/16	-	16	-	0.97	.33	630	4.6	Pail	6
55262	G30	Zinc	1/4	-	10	-	1.14	.43	1,100	5.2	Pail	4
55263	G30	Zinc	5/16	-	8	-	1.24	.50	1,900	6.8	Pail	4
55264	G30	Zinc	3/8	-	5	-	1.35	.57	2,650	6.2	Pail	4
55270	G30	Galvanized	1/8	-	16	-	0.69	.25	325	3.2	Pail	6
55271	G30	Galvanized	3/16	-	16	-	0.97	.33	630	4.6	Pail	6
55272	G30	Galvanized	1/4	-	10	-	1.14	.43	1,100	5.2	Pail	4
55273	G30	Galvanized	5/16	-	8	-	1.24	.50	1,900	6.8	Pail	4
55274	G30	Galvanized	3/8	-	5	-	1.35	.57	2,650	6.2	Pail	4
55280	Passing Link	Zinc	-	2/0	10	.190	.88	.47	450	3.2	Pail	6
55204	Machine Chain Twist Link	Zinc	-	2/0	10	.190	.73	.28	520	3.4	Pail	6
55206	Coil Chain Straight Link	Zinc	-	2/0	10	.190	1.29	.32	520	2.7	Pail	6
55243	Double Loop	Zinc	-	2/0	16	.135	1.82	.34	255	2.7	Pail	6
55245	Double Loop	Zinc	-	3/0	16	.148	2.17	.415	305	3.2	Pail	4
55209	Single Jack	Zinc	-	10T	12	.135	.93	-	43	1.3	Clamshell	6
55285	Plastic Chain	Black	-	6	12	.230	1.00	.30	50	0.6	Clamshell	6
55286	Plastic Chain	Black	-	8	12	.290	1.50	.40	75	0.6	Clamshell	6
55288	Plastic Chain	White	-	8	12	.290	1.50	.40	75	0.6	Clamshell	6

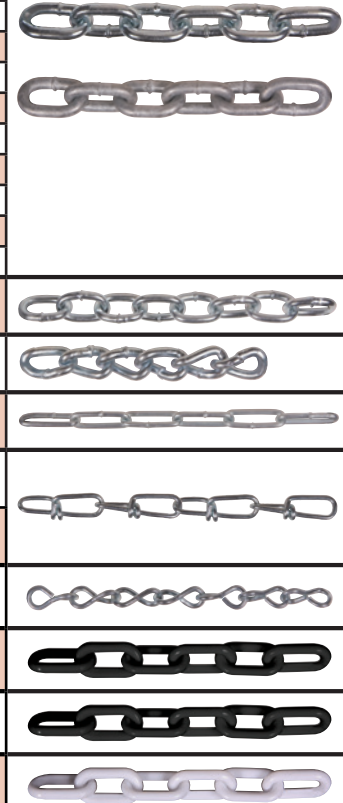

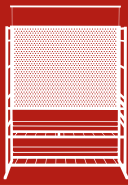



Stainless Steel Cable

Galvanized Cable



 7 x 7	50'			100'			150'			200'			
	Dia. in.	GAC	SS304	SS316	GAC	SS304	SS316	GAC	SS304	SS316	GAC	SS304	SS316
	3/64	83030	83130	83230	81030	81130	81230	89030	89130	89230	88030	88130	88230
	1/16	83031	83131	83231	81031	81131	81231	89031	89131	89231	88031	88131	88231
	5/64	83032	83132	83232	81032	81132	81232	89032	89132	89232	88032	88132	88232
	3/32	83033	83133	83233	81033	81133	81233	89033	89133	89233	88033	88133	88233
	1/8	83034	83134	83234	81034	81134	81234	89034	89134	89234	88034	88134	88234

 7 x 7	250'			500'			1000'			
	Dia. in.	GAC	SS304	SS316	GAC	SS304	SS316	GAC	SS304	SS316
	3/64	82030	82130	82230	80030	80130	80230	86030	86130	86230
	1/16	82031	82131	82231	80031	80131	80231	86031	86131	86231
	5/64	82032	82132	82232	80032	80132	80232	86032	86132	86232
	3/32	82033	82133	82233	80033	80133	80233	86033	86133	86233
	1/8	82034	82134	82234	80034	80134	80234	86034	86134	86234

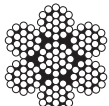
 7 x 19	50'			100'			150'			200'			
	Dia. in.	GAC	SS304	SS316	GAC	SS304	SS316	GAC	SS304	SS316	GAC	SS304	SS316
	1/8	83042	83142	83242	81042	81142	81242	89042	89142	89242	88042	88142	88242
	5/32	83043	83143	83243	81043	81143	81243	89043	89143	89243	88043	88143	88243
	3/16	83044	83144	83244	81044	81144	81244	89044	89144	89244	88044	88144	88244
	1/4	83045	83145	83245	81045	81145	81245	89045	89145	89245	88045	88145	88245
	5/16	83046	83146	83246	81046	81146	81246	89046	89146	89246	88046	88146	88246
	3/8	83047	83147	83247	81047	81147	81247	89047	89147	89247	88047	88147	88247

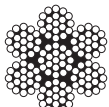
 7 x 19	250'			500'			1000'			
	Dia. in.	GAC	SS304	SS316	GAC	SS304	SS316	GAC	SS304	SS316
	1/8	82042	82142	82242	80042	80142	80242	86042	86142	86242
	5/32	82043	82143	82243	80043	80143	80243	86043	86143	86243
	3/16	82044	82144	82244	80044	80144	80244	86044	86144	86244
	1/4	82045	82145	82245	80045	80145	80245	86045	86145	86245
	5/16	82046	82146	82246	80046	80146	80246	86046	86146	86246
	3/8	82047	82147	82247	80047	80147	80247	86047	86147	86247

Conversion Table



Conversion Table

Fractions	Decimals	mm
1/64"	0.015625	0.3969
1/32"	0.03125	0.7938
3/64"	0.046875	1.1906
1/16"	0.0625	1.5875
5/64"	0.078125	1.9844
3/32"	0.09375	2.3812
7/64"	0.109375	2.7781
1/8"	0.125	3.175
9/64"	0.140625	3.5719
5/32"	0.15625	3.9688
1 1/64"	0.171875	4.3656
3/16"	0.1875	4.7625
13/64"	0.203125	5.1594
7/32"	0.21875	5.5562
15/64"	0.234375	5.9531
1/4"	0.25	6.35
17/64"	0.265625	6.7469
9/32"	0.28125	7.1483
19/64"	0.296875	7.5406
5/16"	0.3125	7.9375
21/64"	0.328125	8.3344
1 1/32"	0.34375	8.7312
23/64"	0.359375	9.1281
3/8"	0.375	9.525
25/64"	0.390625	9.9219
13/32"	0.40625	10.3188
27/64"	0.421875	10.7156
7/16"	0.4375	11.1125
29/64"	0.453125	11.5094
15/32"	0.46875	11.9062
31/64"	0.484375	12.3031
1/2"	0.5	12.7

Fractions	Decimals	mm
33/64"	0.515625	13.0969
17/32"	0.53125	13.4938
35/64"	0.546875	13.8906
9/16"	0.5625	14.2875
37/64"	0.578125	14.6844
19/32"	0.59375	15.0812
39/64"	0.609375	15.4781
5/8"	0.625	15.875
41/64"	0.640625	16.2719
21/32"	0.65625	16.6688
43/64"	0.671875	17.0656
1 1/16"	0.6875	17.4625
45/64"	0.703125	17.8594
23/32"	0.71875	18.2562
47/64"	0.734375	18.6531
3/4"	0.75	19.05
49/64"	0.765625	19.4469
25/32"	0.78125	19.8438
51/64"	0.796875	20.2406
13/16"	0.8125	20.6375
53/64"	0.828125	21.0344
27/32"	0.84375	21.4312
55/64"	0.859375	21.8281
7/8"	0.875	22.225
57/64"	0.890625	22.6219
29/32"	0.90625	23.0188
59/64"	0.921875	23.4156
15/16"	0.9375	23.8125
61/64"	0.953125	24.2094
31/32"	0.96875	24.6062
63/64"	0.984375	25.0031
1"	1.0	25.4

Pulley or Sheave Diameter According To Cable Construction

Construction	Sheave Diameter	
	Recommended	Minimum
6 x 19	45 x d	34 x d
6 x 36	35 x d	23 x d
19 x 7	51 x d	34 x d
7 x 7 GAC	72 x d	42 x d
7 x 19 GAC	35 x d	26 x d
7 x 7 SS	82 x d	65 x d
7 x 19 SS	40 x d	31 x d

d = wire rope diameter





Ben-Mor is a leader in solar heating for a plant.

Enerconcept's heliothermic heat pump helps to save close to 50% of the plant's heating costs.

This solar energy system could very well become a model of efficiency and profitability for all Quebec industries. The sun's light is transformed into usable heat to warm the plant's interior.

The exterior ambient temperature is raised by 10°C to 20°C in the solar collectors. The hot air is drawn into the collectors and then routed to the cold side of the heat pump, which easily absorbs this energy. The solar energy that is so captured is directed towards the interior of the building and is distributed at a higher temperature (27°C) by fabric air ducts.



General Sales Conditions

Guarantee

All "Ben-Mor inc." products are unconditionally guaranteed against manufacturing defects. Any item found to be defective will be replaced or adjusted, provided "Ben-Mor inc." is notified promptly upon receipt of merchandise. "Ben-Mor inc." reserves the right to request that the defective item be returned for examination purposes. The purchaser will be responsible for labor charges incurred by the examination of the returned item(s). "Ben-Mor inc." liability regarding defects in any item shall be limited to its replacement or to the adjustment for an amount equal to the price paid for the item. Debit memos will not be accepted without prior written authorization by "Ben-Mor inc."

Claims for loss or damage in transit

All products are carefully inspected and packaged to assure delivery in good condition. Product damage or loss occurring in transit is the responsibility of the carrier, and in the event of such loss, the purchaser must advise the carrier within 10 days after delivery. "Ben-Mor inc." will give all reasonable assistance in tracing shortages and filing claims.

Returned Merchandise

Credit will not be issued for material returned without written authorization from "Ben-Mor inc." Return request must be mailed to the "Ben-Mor inc." office and must include an itemized list of materials with the dates and numbers of invoices. All returns must be done within thirty days of delivery of goods. Items are subject to 20% handling charge.

Prices

All prices are subject to change without notice. Invoices will be based on the prices prevailing at date of shipment. Because of the unpredictable fluctuations of raw materials, "Ben-Mor inc." may be forced to add surcharges without notice, and due to rapid changes, these surcharges may result in immediate additional costs to our customers. When possible, "Ben-Mor inc." will advise of surcharges in advance.

Payment Terms

Net 30 days. Service charge of 2% per month will apply against all outstanding balances over 30 days, or 24% annually.

Credit

Open account terms will be extended to firms with satisfactory commercial credit rating. Firms without satisfactory commercial credit rating may qualify for open account terms, by listing on their order form the name of their bank and three active credit references. When we lack proper credit information, in order to avoid delay in servicing an order, we will ship "cash on delivery" payment basis (C.O.D.).

Specifications

The dimensions, weights, strengths, lengths, and other specifications shown in the catalog are subject to variation within reasonable tolerances.



***Our Guarantee:
An experienced team available,
always ready to deliver your order on time!***



Index

Armored Cable	21	Eyelets	15	Shank Balls	14
Ball Fitting	14	Eye Bolts	36-37, 44, 50	Sheaves	47
Beam Clamps	89	Eye End	45	Sleeves	24, 48
Bracing Cable	124	Eye Fitting	13	Slings	
Buttons	25	Eye Nuts	37, 50	Chain Slings	76-78
Cables Roll Off	117	Forestry Chokers	112	Roundslings	66-72
Cable & Wire Rope	18-23	Fork	15, 45	Wire Rope Slings	86-87
Chain		Hammerlock Type		Web Slings	58-60, 96
Grade 30	101	Connecting Links	81, 85	Snaps	40, 46, 54, 55
Grade 40	100, 120	Hoist Rings	38	Snatch Block	42
Grade 70	120, 121	Hooks		Sockets	42-43
Grade 80	82, 88	Grade 40	40, 41	Spelter Sockets	43
Grade 100	78	Grade 70	41	Strap Eyes	15
Stainless Steel	100	Grade 80	84-85	Strap Fork	15, 45
Agricultural Safety Chain	120	Grade 100	80-81	Stub End Turnbuckles	33
Bead & Connectors	107	Stainless	55	Studs	44, 51
Cathedral	105	Others	39, 40, 41, 113	Swage Cable	21, 113
Coil	101, 103	Jaw and Swage Terminal	53	Swage Sockets	42-43
Craft	107	Jaw Fitting	13	Swagers	110, 125
Cutter	110, 111	Kwik-Locs	125	Sway Bracing Cable With Straight Eyelet	124
Decorative Oval Chain	106	Lap Links	108	Sway Bracing Cable With 45° Eyelet	124
Double Loop	104	Latch	39, 41, 83	Swivels	27, 47
Electrical	106	Lever Hoist	88	Synthetic Slings	56-60
Furnace	104	Lifting Eye Bolt	50	Tag Identification	64
Harrow	103	Load Binders	119	Thimbles	26-27, 48-49
Hobby	107	Load Binder Locks	119	Threaded Fittings	12, 44, 51
Jack	105	Looped Cable	124	Tie-Down Accessories	114, 115
Logging	112	Main Lines	112	Tie Down, Cable and Chain	120-121
Lock Link	104	Marine Eyes	51	Toggle Block	42
Machine	102	Marine Slings	61	Tow Cables	122
Passing Link	102	Master Oblong Links	79, 83	Tow Chain	120
Plastic	105	Master Rings	83	Tow Slings	62
Safety	106, 120	Mil Spec Cable	10-11	Trailer Safety Chain	122
Sash	106	Military Fittings	12-15	Triangles	75
Sling	78-80	Pear Shape Weldless Links	83	Turnbuckles	29-33, 52
Tie Down	119-121	Pulleys	42, 45, 47	Wear Pads	65, 68
Tow	120	Push Trolleys	89	Web Slings	56-60, 96
Utility	103	Quick Links	46, 55	Web Sling Connectors	74
Vinyl covered	104	RFID	91	Welded Master Link Assembly	79, 83
Chain Hoist	88-89	Rigging / Training	90	Wire Rope & Cable	18-23
Chokers	75, 112	Replacement Links	108	Wire Rope Clips	28, 49
Coated Cable	16-17	Rings for Main-lines	113	Wire Rope Cutters	111, 125
Cold Shuts	108	Rope	109	Wire Rope Slings	86-87
Concrete Anchors	123	Round Rings	47	Whip Restraints	123
Cutters	111	Roundslings	66-72	Winch Cables	116, 122
Double Clevis Chain Midlink	40	“S” Hooks	46, 54, 106		
Drum Slings	61	Shackles	34-35, 53		



www.ben-mor.com
info@ben-mor.com

Head Office

1105, Lemire, St-Hyacinthe, Quebec, Canada, J2T 1L8
☎ 1-800-481-0022 • 450-778-0022 — ☎ 1-800-498-0022 • 450-778-0033

Ontario Plant

690, Bay View Dr, Barrie, Ontario, Canada, L4N 9A6
☎ 1-800-423-4423

Western Distribution Center

7018, 30th Street S.E., Calgary, Alberta, Canada, T2C 1N9
☎ 403-279-9631 — ☎ 403-279-6907

Retail Products Distribution Center

1400, Nobel, Boucherville, Quebec, Canada, J4B 5H3



253 Monument Road, Hinsdale, New Hampshire, 03451, USA
☎ 1 800 229-5131

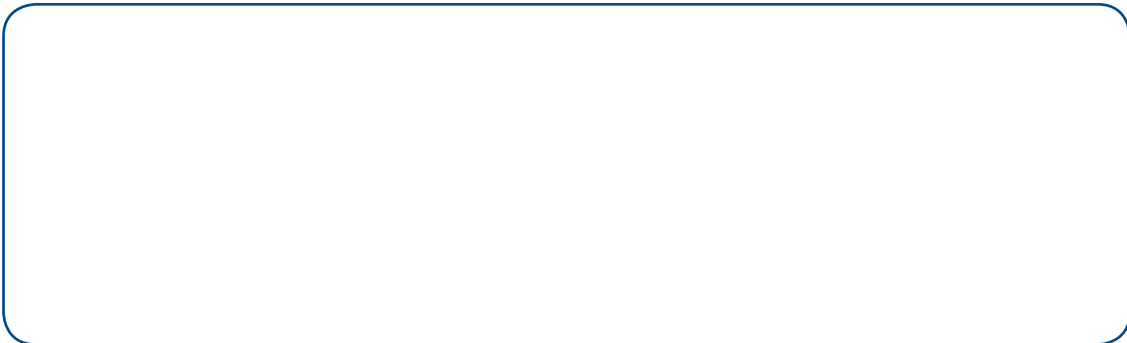

Printed in Canada



99021
Rev. December 2016