

Watts 2015 Price List

Water Safety, Flow Control and
Backflow Prevention Products

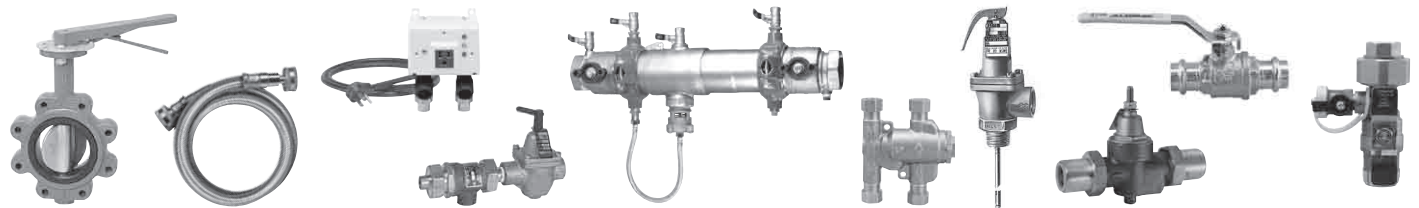

Effective March 30, 2015

All prices supersede previous issues, are temporary and subject to change without notice.

* The wetted surface of this product contacted by consumable water contains less than 0.25% of lead by weight.

Includes
Our
LEAD FREE
Product Offering.
Traditional products are still available
while supplies last. Call your local rep.

Index

Numerical

LF1L, LF1XL	33	411	89	Butterfly Valve Options 110-111	HK SXI-PRESS	84	RL600	136
2M2-DWB	131	415-M1	34	C	HK-2000-M2	111	RPV	115
2-M2, 2T-M2	131	500	134	C-36 Com	HP-BHM	116	S	
3L/LF3L	31	530C/LF530C	31	C-FBV-1	HPX	116	S8, S8C	39
LF05	130	LF560/LFH560	12	CDC-S	HP30Pro	116	SAE-TC	73
LF6	88	600 Z3	89	CFC-P/LFCFC-P	HWA	123	SC8	133
LFH7/LF7R	43	600/LF600	89	CFC-S/LFCFC-S	I		S-FBV-1	86
LF07S	43	LF601	89	CIC-P	ICV-125-2-2-T	88	LFS777, LFS777S	92-93
007/LF007	44-45	LF6115	23	COC-S	ILHK	85	SAN50, SAN50S	118
007DCDA	60	LF709	48	CSM-61	INS KIT	140	SAN89	118
8/LF8	39	709DCDA	60	CSM-81F	IPF/LFIPF	114	SC	133
LF008PCQT	42	719/LF719	46-47	CSM-91	LFIT6300, LFIS6301	82	SCV	117
9BD/LFN9, 9D	39-40	740	30	CTC-P	ITHK	85	LFSL100XL	33
009/LF009	51-53	LF745	94	CTC-S	IWTG	153	SD2, SD3	40
LF10L	33	750	134	LFCWH-S	J		SS 07F	89
LF15M2/LF15	130	757	50	CWM-S	Jumper Kits	10	SS263AP	11
LF17	94	LF757DCDA	63-65	D			SV, SVA, SVS	123
LF25AUB	3-4	774	49	DBF			SX1-HK	85
LF26A	11	774DCDA	61-62	DETA	K		T	
LF27-40	94	LF777, LF777S	92-93	LFDPG	KA2	131	T156B	112
30L/LFN30	31	LF777SI	91	LFDPTG			TA	155
40L, 40XL/LF40XL	32-33	800M4FR/LF800M4FR	42	DuoVents			LFTB, TBC, TBP, LFTBR	154
53/LF53, 53L/LF53L	31	800M4QT/LF800M4QT	41	E			LFTC	73
65	122	909/LF909	55-56	E-50, 100			TDV	98
LF70A, LFL70A	127	909RPDA	66	E-75, 120			Terms & Conditions	2
77F-BI	93	911/B911	112	Elbows			TK-7	72
77F-CSI	95	912HP	40	LFEMVII-6400SS			TK-9A	72
77F-CSSI	96	919/LF919	54	ENS-20			TK-99D	72
77F-DI, 77F-DI-FDA	91	957	58-59	ETA, ETRA			TK-99E	72
77F-SS	96	LF957RPDA	68-71	ETX, ETSX			TK-DL	72
77G-SS	96	994	57	F			LFTL	155
77S/77SI	91	994RPDA	67	F115/F1115			LFTP	155
87SI	95	1000	134	F-127SS			LFTP-300	133
88CSI	95	1070	124-125	LFFBV			TP-GA1	155
88S	96	1116FH	25	LFFBV-PEX			TPK-QC Kits	3
97FB	97	1156	112	FBV-3C/LFFBV-3C			TPT	153
100DT, 100DT-A	35	LF1170/LFL1170	126-127	FBVS-3C/LFFBVS-3C			TSE-75	36
LF100XL	33	1250	134	LFFBV-3C-QC/LFFBV-3C-QC			TR	73
LF110/LF1110 (ACV)	15-16	1450F	112	LFFBV-3-Press			TUBING	156-165
LF113/LF1113	17	1500	134	LFEBV-4, FBVS-4			LFTWH	37
LF115/LFF115	18-22	2000	134	FH/LFFH, FHB/LFFHB			TWS	39
LF115F (ACV)	26	2000 M5	112	FHB-1-PEX			U	
LFF116 (ACV)	24-28	2300	8	FHB-2			UL-1, UL-2	123
116-BTR/1116BTR	25	LF3001 - LF3008	139	Fig. 41			USG-B	124
LF123LP	12	LF3100 - LF3200	140	Float Valve Components			LFU5B	3
127SS	14	3110/3110LF	140	FP53L/LF53L			U800M4QT	41
LF127W	9	4001E	140	FS-26, 36			W	
140/LF140	32-33	5300A/LF5300A	31	FS-CDC-S			LFWAMV	123
142	118	LF6115 (ACV)	23	FS-CFC-S/LFFS-CFC-S			WAS	124
144	118	A		FS-CFC-S/LFFS-CFC-S			WB	75-76
LF150A	130	A2C	131	FS-CIC-S/LFFS-CIC-S			LFWCV	89
152A, 152SS	13	ACV Options	29	FS-CTC-S			WDS/LFWDS	37
174A	30	AirGaps	72	FS-CWM-S			WFT	119
188A	40	APU	132	FV-4M1			WFTC, WFTK	119
LF210	34	AS-M1, AS-M1-T	113	G			LFWGV	90
LF215	12	AS-MB	113	G			WB	120
LF223, LF223S	9	AS-20, 22, 26, 30	36	G-1070			WM-26, 30	36
252A	13	B		G-4000			WPE-24	36
LF263A	11	B-24, 26, 30, 36	36	G, GH			WPHR	77
276H300	153	LFB6080G2/LFB6081G2	80-81	GBV, GBV-1, GBV-FL			WPLR, WPLRN	77
LF288A	40-41	LFB6400	80	GF			W-SPL	74
LF289	41	LFB6780, LFB6781	81	LFGVL			W-FLG	74
315-M2	34	LFB6800, LFB6801	79	Gov80M2			WTD 600	120
340/LF340	33	BD/LFBD	132	H			WVS	74
342/LF342	33	BD-QT/LFBD-QT	132	LFH7			X	
374A	30	BF	107-109	LFH560, LFH560G			LFX65B	5-6
375	134	BIC-1000	77	Handle Options			LFX65B Cartridge Assy/LF	6
405RW	90	BP30A/LF	31	HAV			LFX65B-RIK/LFX65B-RIK	6-7
408-OSY-RW	90	LFBRVP	39	HBV				
		LFBRVT, LFBRSV	38					

Table of Contents

Terms & Conditions		2
Section 1	Pressure Regulators & Automatic Control Valves	3 – 29
Section 2	Relief Valves	30 – 34
Section 3	Water Heater Installation Products <i>(Relief Valves, Drain Lines, Expansion Tanks, Water Heater Stands, Straps and Enclosures, Water Heater Installation Products)</i>	35 – 38
Section 4	Backflow Preventers & Accessories	39 – 77
Section 5	Ball Valves	78 – 87
Section 6	Gate/Globe/Check Valves	88 – 90
Section 7	Strainers	91 – 97
Section 8	Balancing & Flow Measurement	98 – 99
Section 9	Butterfly Valves	100 – 111
Section 10	Hydronics/Steam Heating Products	112 – 123
Section 11	Tempering Valves	124 – 127
Section 12	Plumbing Specialties <i>(Wall Hydrants, Water Hammer Arrestors, Float Valves, Evaporative Cooler Kits)</i>	128 – 138
Section 13	Dielectric Unions	139 – 140
Section 14	Flexible Connectors	141 – 149
Section 15	Gauges <i>(Dial Pressure, Combination Pressure/Temperature, Hose Connection, Temperature Gauges)</i>	150 – 155
Section 16	Anti-Scale Systems	156 – 157
Section 17	Tubing	158 – 167

Throughout this book you will see products highlighted with **LEAD FREE***. These are Watts products that comply with Lead Free laws in California, VT, MD, and LA. as well as the 2014 Federal “Reduction of Lead in Drinking Water Act” requirements. For more information on our Lead Free products, please visit our Lead Free informational web site at WeAreLeadFree.net.

*The wetted surface of this product contacted by consumable water contains less than 0.25% of lead by weight.

Electronic is Green!

For the latest Watts pricing information in electronic format, visit our Data Exchange at:

<http://www.wattswater.com/DataExchange>

- Download product and list price data in .csv, .pdf, .tsv, .xls and .xml formats
- Easy access to list price data for business systems
- Sign up for e-mail alerts when data is updated
- Access other Watts Water Technologies brands pricing data

Terms and Conditions

FREIGHT TERMS: All shipments are F.O.B. shipping point. Shipments from factory less than 1000 lbs. are F.O.B. factory. Factory shipments OF \$5000 and over within the continental U.S.A. will be prepaid and allowed when made at the lowest motor carrier transportation rate.

TERMS OF SALE: All sales are F.O.B. shipping point.

PAYMENT TERMS: The invoices are due and payable 30 days from the date of invoice.

PURCHASE ORDER FORMS: Orders submitted on customer's own purchase order forms will be accepted only with the express understanding that no statements, clauses, or conditions contained in said order form will be binding on the Seller if they in any way modify the Seller's own terms and conditions of sales.

STOCKING WHOLESALER MINIMUM CHARGE: A minimum billing charge of \$100.00 applies to shipments F.O.B. factory. Stocking Wholesaler Customers are encouraged to order sufficient material to avoid this charge which is necessitated by increased costs of processing small orders.

SPECIAL PRODUCTS: Orders for special or modified products are non-cancelable.

LIMITED WARRANTY: Watts Regulator Co. (the "Company") warrants each product to be free from defects in material and workmanship under normal usage for a period of one year from the date of original shipment. In the event of such defects within the warranty period, the Company will, at its option, replace or recondition the product without charge.

THE WARRANTY SET FORTH HEREIN IS GIVEN EXPRESSLY AND IS THE ONLY WARRANTY GIVEN BY THE COMPANY WITH RESPECT TO THE PRODUCT. THE COMPANY MAKES NO OTHER WARRANTIES, EXPRESS OR IMPLIED. THE COMPANY HEREBY SPECIFICALLY DISCLAIMS ALL OTHER WARRANTIES, EXPRESS OR IMPLIED, INCLUDING BUT NOT LIMITED TO THE IMPLIED WARRANTIES OF MERCHANTABILITY AND FITNESS FOR A PARTICULAR PURPOSE.

The remedy described in the first paragraph of this warranty shall constitute the sole and exclusive remedy for breach of warranty, and the Company shall not be responsible for any incidental, special or consequential damages, including without limitation, lost profits or the cost of repairing or replacing other property which is damaged if this product does not work properly, other costs resulting from labor charges, delays, vandalism, negligence, fouling caused by foreign material, damage from adverse water conditions, chemical, or any other circumstances over which the Company has no control. This warranty shall be invalidated by any abuse, misuse, misapplication, improper installation or improper maintenance or alteration of the product.

Some States do not allow limitations on how long an implied warranty lasts, and some States do not allow the exclusion or limitation of incidental or consequential damages. Therefore the above limitations may not apply to you. This Limited Warranty gives you specific legal rights, and you may have other rights that vary from State to State. You should consult applicable state laws to determine your rights. **SO FAR AS IS CONSISTENT WITH APPLICABLE STATE LAW, ANY IMPLIED WARRANTIES THAT MAY NOT BE DISCLAIMED, INCLUDING THE IMPLIED WARRANTIES OF MERCHANTABILITY AND FITNESS FOR A PARTICULAR PURPOSE, ARE LIMITED IN DURATION TO ONE YEAR FROM THE DATE OF ORIGINAL SHIPMENT.**

SERVICE POLICY: For inoperative products beyond the warranty period, we assume no liability for replacement of valves due to service conditions beyond our control.

RETURNED GOODS: No material shall be returned without authorization. When credit is issued it will be at the price charged, or prevailing price if lower, less handling charges based on costs of reconditioning, boxing, etc. However, a minimum 25% handling charge will apply. A minimum handling charge of \$20.00 is applied whenever the 25% handling deduction does not total \$20.00. Products which are obsolete or made to special order are not returnable.

NOTE: Prices and terms are subject to change without notice and supersede all previous quotations. The right is reserved to change or modify product design or construction without prior notice and without incurring any obligation to make such changes and modifications on products previously or subsequently sold.

Water Pressure Reducing Valves

Unless noted, all pressure reducing valves on this page are factory set at 50psi. Adjustable range is 25 – 75psi.



LFU5B-Z3

SERIES LFU5B-Z3, LF25AUB-Z3:
Standard Features

- Z3** – Sealed spring cage and stainless steel corrosion resistant adjusting & cage screws for accessible outdoor or pit installations
- Options**
- G** – Gauge tapping; list price 5% extra
- GG** – Gauge tapping and 160psi gauge; add 15% to list price (1/2"–1"); add 5% to list price (1 1/4"–2")
- HP** – High pressure range; price 25% extra U5B-Z3 75 – 100psi; 25AUB-Z3 75 – 125psi . Not available with G or GG option
- LP** – Low pressure range 10 – 35psi; price 10% extra. Not available with G or GG option
- Z7** – 400psi initial pressure 1/2", 3/4" and 1" price 7.5% extra (25AUB-Z3 only)



LF25AUB-QC-Z3

Model	Ordering Code	Size (in.)	UPC	Qty. Per Carton	Weight Per Carton (lbs.)	List Price (each)
-------	---------------	------------	-----	-----------------	--------------------------	-------------------

Series LFU5B – Max Pressure 300psi w/Bypass

NPT Threaded Female Union Inlet x NPT Female Threaded Union Outlet

LEAD FREE*	Model	Ordering Code	Size (in.)	UPC	Qty. Per Carton	Weight Per Carton (lbs.)	List Price (each)
	LFU5B-Z3	0009100	1/2	098268327335	6	19	\$ 515.00
	LFU5B-Z3	0009118	3/4	098268327533	6	24	599.50
	LFU5B-Z3	0009154	1	098268327991	6	32	915.00
	LFU5B-Z3	0009180	1 1/4	098268328462	6	47	1,761.00
	LFU5B-Z3	0009192	1 1/2	098268328677	1	12	1,982.00
	LFU5B-Z3	0009204	2	098268329001	1	19	2,890.00

Quick-Connect Union Inlet x NPT Threaded Female Outlet

LEAD FREE*	Model	Ordering Code	Size (in.)	UPC	Qty. Per Carton	Weight Per Carton (lbs.)	List Price (each)
	LFU5B-QC-Z3	0125285	3/4	098268859898	6	24	697.50
	LFU5B-QC-Z3	0125286	1	098268859904	6	32	1,028.00

SPECIAL MODELS: Model 5M3-Z6 – with water meter threaded connections and 7 1/2" lay length for new or existing meter box installations.

Series LF25AUB – Max Pressure 300psi w/Bypass

NPT Threaded Female Union Inlet x NPT Threaded Female Outlet

LEAD FREE*	Model	Ordering Code	Size (in.)	UPC	Qty. Per Carton	Weight Per Carton (lbs.)	List Price (each)
	LF25AUB-Z3	0009217	1/2	098268329162	6	16	222.50
	LF25AUB-Z3	0009257	3/4	098268329704	6	17	229.00
	LF25AUB-Z3	0009309	1	098268330427	6	27	295.00
	LF25AUB-Z3	0009392	1 1/4	098268331431	4	33	561.00
	LF25AUB-Z3	0009431	1 1/2	098268331868	4	35	748.00
	LF25AUB-Z3	0009465	2	098268332247	1	13	1,092.00

Quick-Connect Union Inlet x NPT Threaded Female Outlet

LEAD FREE*	Model	Ordering Code	Size (in.)	UPC	Qty. Per Carton	Weight Per Carton (lbs.)	List Price (each)
	LF25AUB-QC-Z3	0125292	1/2	098268860047	6	18	326.50
	LF25AUB-QC-Z3	0125293	3/4	098268860054	6	17	257.00
	LF25AUB-QC-Z3	0125294	1	098268860061	6	27	190.50

Solder Union Inlet x NPT Threaded Female Outlet

LEAD FREE*	Model	Ordering Code	Size (in.)	UPC	Qty. Per Carton	Weight Per Carton (lbs.)	List Price (each)
	LF25AUB-S-Z3	0009237	1/2	098268329421	6	16	222.50
	LF25AUB-S-Z3	0009282	3/4	098268330083	6	18	229.00
	LF25AUB-S-Z3	0009331	1	098268330724	6	27	295.00
	LF25AUB-S-Z3	0009391	1 1/4	098268331424	4	34	561.00
	LF25AUB-S-Z3	0009430	1 1/2	098268331851	4	37	748.00
	LF25AUB-S-Z3	0009464	2	098268332230	1	13	1,092.00

NPT Threaded Female Union Inlet x NPT Threaded Female Union Outlet

LEAD FREE*	Model	Ordering Code	Size (in.)	UPC	Qty. Per Carton	Weight Per Carton (lbs.)	List Price (each)
	LF25AUB-DU-Z3	0009228	1/2	098268329315	6	18	255.00
	LF25AUB-DU-Z3	0009258	3/4	098268329711	6	21	263.50
	LF25AUB-DU-Z3	0009322	1	098268330588	6	93	353.50
	LF25AUB-DU-Z3	0009353	1 1/4	098268330984	1	8.9	616.50
	LF25AUB-DU-Z3	0009393	1 1/2	098268331448	1	8.9	860.00
	LF25AUB-DU-Z3	0009442	2	098268331981	1	18	1,149.00

*The wetted surface of this product contacted by consumable water contains less than 0.25% of lead by weight.

Consult factory for ordering code numbers of special models/options.

Water Pressure Reducing Valves

Unless noted, all pressure reducing valves on this page are factory set at 50psi. Adjustable range is 25 – 75psi.

Model	Ordering Code	Size (in.)	UPC	Qty. Per Carton	Weight Per Carton (lbs.)	List Price (each)
-------	---------------	------------	-----	-----------------	--------------------------	-------------------

Series LF25AUB – Max Pressure 300psi w/Bypass (cont.)

Quick-Connect Union Inlet x Quick-Connect Union Outlet

LEAD FREE*	Model	Ordering Code	Size (in.)	UPC	Qty. Per Carton	Weight Per Carton (lbs.)	List Price (each)
	LF25AUB-DU-QC-Z3	0125289	1/2	098268860016	6	18	\$ 360.50
	LF25AUB-DU-QC-Z3	0125290	3/4	098268860023	6	21	454.00
	LF25AUB-DU-QC-Z3	0125291	1	098268860030	6	93	587.00

Solder Union Inlet x Solder Union Outlet

LEAD FREE*	Model	Ordering Code	Size (in.)	UPC	Qty. Per Carton	Weight Per Carton (lbs.)	List Price (each)
	LF25AUB-S-DU-Z3	0009246	1/2	098268329513	6	22	255.00
	LF25AUB-S-DU-Z3	0009283	3/4	098268330090	6	19	263.50
	LF25AUB-S-DU-Z3	0009337	1	098268330786	6	29	353.50
	LF25AUB-S-DU-Z3	0009382	1 1/4	098268331332	1	29	616.50
	LF25AUB-S-DU-Z3	0009421	1 1/2	098268331752	1	11	860.00
	LF25AUB-S-DU-Z3	0009455	2	098268332131	1	16	1,149.00

Double Union/NPT Threaded Female Union Inlet – Less Fittings

LEAD FREE*	Model	Ordering Code	Size (in.)	UPC	Qty. Per Carton	Weight Per Carton (lbs.)	List Price (each)
	LF25AUB-DU-LF-Z3	0009298	3/4	098268330298	6	24	229.00
	LF25AUB-DU-LF-Z3	0009320	1	098268330564	6	41	314.00
	LF25AUB-DU-LF-Z3	0009364	1 1/4	098268331134	4	36	553.00

Tail Piece Kits

Quick-Connect Tail Piece Kits for Series LFU5B and LF25AUB

LEAD FREE*	Model	Ordering Code	Size (in.)	UPC	Qty. Per Carton	Weight Per Carton (lbs.)	List Price (each)
	LFTPK-QC 25AUB/U5B	0121276	1/2	098268582260	24	6	17.50
	LFTPK-QC 25AUB/U5B	0121277	3/4	098268582277	24	11	26.50
	LFTPK-QC 25AUB/U5B	0121278	1	098268582284	24	14	37.00



LFTPK-QC

*The wetted surface of this product contacted by consumable water contains less than 0.25% of lead by weight.

Consult factory for ordering code numbers of special models/options.

Water Pressure Reducing Valves

Unless noted, all pressure reducing valves on this page are factory set at 50psi. Adjustable range is 25 – 75psi.



LFX65B

SERIES LFX65B:

Options

- G** – Gauge tapping; list price 5% extra
- GG** – Gauge tapping and 160psi gauge; add 15% to list price (1/2"–1"); add 5% to list price (1 1/4"–2")
- HP** – High pressure range; price 25% extra. Not available with G or GG option

Model	Ordering Code	Size (in.)	UPC	Qty. Per Carton	Weight Per Carton (lbs.)	List Price (each)
-------	---------------	------------	-----	-----------------	--------------------------	-------------------

Series LFX65B – Max Pressure 400psi – Cartridge Style w/Bypass
NPT Threaded Female Inlet X NPT Threaded Female Outlet

LEAD FREE*	LFX65B	0009925	1/2	098268448221	12	19	\$ 233.00
LFX65B	0009945	3/4	098268448276	12	20	237.00	
LFX65B	0009966	1	098268448337	6	14	278.50	
LFX65B	0009986	1 1/4	098268448382	6	23	620.00	
LFX65B	0010023	1 1/2	098268448436	1	8.8	975.00	
LFX65B	0010043	2	098268448481	1	10	1,271.00	

NPT Threaded Female Union Inlet X NPT Threaded Female Outlet

LEAD FREE*	LFX65BU	0009929	1/2	098268448238	12	8.2	239.50
LFX65BU	0009949	3/4	098268448283	12	23	262.00	
LFX65BU	0009970	1	098268448344	6	17	306.00	
LFX65BU	0009990	1 1/4	098268448399	6	29	646.50	
LFX65BU	0010027	1 1/2	098268448443	1	10	1,003.00	
LFX65BU	0010047	2	098268448498	1	12	1,296.00	

Solder Union Inlet X NPT Threaded Female Outlet

LEAD FREE*	LFX65BU-S	0009933	1/2	098268448245	12	21	239.50
LFX65BU-S	0009953	3/4	098268448290	12	26	262.00	
LFX65BU-S	0009974	1	098268448351	6	17	306.00	
LFX65BU-S	0009994	1 1/4	098268448405	6	27	646.50	
LFX65BU-S	0010031	1 1/2	098268448450	1	10	1,003.00	
LFX65BU-S	0010051	2	098268448504	1	12	1,296.00	

NPT Threaded Female Union Inlet X NPT Threaded Female Union Outlet

LEAD FREE*	LFX65BDU	0009937	1/2	098268448252	12	22	268.00
LFX65BDU	0009957	3/4	098268448306	12	26	291.00	
LFX65BDU	0009978	1	098268448368	6	19	350.00	
LFX65BDU	0010015	1 1/4	098268448412	6	34	724.50	
LFX65BDU	0010035	1 1/2	098268448467	1	11	1,138.00	
LFX65BDU	0010055	2	098268448511	1	14	1,426.00	

Solder Union Inlet X Solder Union Outlet

LEAD FREE*	LFX65BDU-S	0009941	1/2	098268448269	12	22	268.00
LFX65BDU-S	0009961	3/4	098268448313	12	29	291.00	
LFX65BDU-S	0009982	1	098268448375	6	21	350.00	
LFX65BDU-S	0010019	1 1/4	098268448429	6	31	724.50	
LFX65BDU-S	0010039	1 1/2	098268448474	1	11	1,138.00	
LFX65BDU-S	0010059	2	098268448528	1	13	1,426.00	

*The wetted surface of this product contacted by consumable water contains less than 0.25% of lead by weight.

Consult factory for ordering code numbers of special models/options.

Water Pressure Reducing Valves

Model	Ordering Code	Size (in.)	UPC	Qty. Per Carton	Weight Per Carton (lbs.)	List Price (each)
-------	---------------	------------	-----	-----------------	--------------------------	-------------------

Cartridge Assembly Series LFX65B

Standard Pressure Setting

LEAD FREE*	Model	Ordering Code	Size (in.)	UPC	Qty. Per Carton	Weight Per Carton (lbs.)	List Price (each)
	LFX65B CartAssy-STD	0045826	1/2-3/4	098268491487	12	10	\$ 135.00
	LFX65B CartAssy-STD	0045827	1	098268491494	12	15	160.00
	LFX65B CartAssy-STD	0045828	1 1/4	098268491500	6	12	354.50
	LFX65B CartAssy-STD	0045829	1 1/2-2	098268491517	6	35	556.00

Rough-In Kits Series LFX65B

NPT Threaded Inlet X NPT Threaded Female Outlet

LEAD FREE*	Model	Ordering Code	Size	UPC	Qty. Per Carton	Weight Per Carton (lbs.)	List Price
	LFX65B RIK	0010063	1/2	098268448535	12	8.3	88.25
	LFX65B RIK	0010064	3/4	098268448542	12	9.4	90.00
	LFX65B RIK	0010065	1	098268448559	12	13	106.50
	LFX65B RIK	0010066	1 1/4	098268448566	6	11	237.00
	LFX65B RIK	0010067	1 1/2	098268448573	6	20	371.50
	LFX65B RIK	0010068	2	098268448580	6	24	483.50

Threaded Female Union Inlet X Threaded Female Union Outlet

LEAD FREE*	Model	Ordering Code	Size	UPC	Qty. Per Carton	Weight Per Carton (lbs.)	List Price
	LFX65BU RIK	0010079	1/2	098268448696	12	11	91.00
	LFX65BU RIK	0010080	3/4	098268448702	12	14	99.50
	LFX65BU RIK	0010081	1	098268448719	12	15	116.50
	LFX65BU RIK	0010082	1 1/4	098268448726	6	18	246.00
	LFX65BU RIK	0010083	1 1/2	098268448733	6	31	381.50
	LFX65BU RIK	0010084	2	098268448740	6	36	493.00

Solder Union Inlet X NPT Threaded Female Outlet

LEAD FREE*	Model	Ordering Code	Size	UPC	Qty. Per Carton	Weight Per Carton (lbs.)	List Price
	LFX65B-U-S RIK	0010091	1/2	098268448818	12	11	91.00
	LFX65B-U-S RIK	0010092	3/4	098268448825	12	13	99.50
	LFX65B-U-S RIK	0010093	1	098268448832	12	15	116.50
	LFX65B-U-S RIK	0010094	1 1/4	098268448849	6	16	246.00
	LFX65B-U-S RIK	0010095	1 1/2	098268448856	6	29	381.50
	LFX65B-U-S RIK	0010096	2	098268448863	6	34	493.00

NPT Threaded Female Union Inlet X NPT Threaded Female Union Outlet

LEAD FREE*	Model	Ordering Code	Size	UPC	Qty. Per Carton	Weight Per Carton (lbs.)	List Price
	LFX65B-DU RIK	0010085	1/2	098268448757	12	13	102.00
	LFX65B-DU RIK	0010086	3/4	098268448764	12	17	111.00
	LFX65B-DU RIK	0010087	1	098268448771	12	20	134.00
	LFX65B-DU RIK	0010088	1 1/4	098268448788	6	24	277.00
	LFX65B-DU RIK	0010089	1 1/2	098268448795	6	40	432.50
	LFX65B-DU RIK	0010090	2	098268448801	6	47	541.50

Solder Union Inlet X Solder Union Outlet

LEAD FREE*	Model	Ordering Code	Size	UPC	Qty. Per Carton	Weight Per Carton (lbs.)	List Price
	LFX65B-DU-S RIK	0010097	1/2	098268448870	12	12	91.00
	LFX65B-DU-S RIK	0010098	3/4	098268448887	12	16	99.50
	LFX65B-DU-S RIK	0010099	1	098268448894	12	18	116.50
	LFX65B-DU-S RIK	0010100	1 1/4	098268448900	6	20	246.00
	LFX65B-DU-S RIK	0010101	1 1/2	098268448917	6	36	381.50
	LFX65B-DU-S RIK	0010102	2	098268448924	6	43	493.00



LFX65B-Rough In Kit

*The wetted surface of this product contacted by consumable water contains less than 0.25% of lead by weight.

Consult factory for ordering code numbers of special models/options.

Water Pressure Reducing Valves

Model	Ordering Code	Size (in.)	UPC	Qty. Per Carton	Weight Per Carton (lbs.)	List Price (each)
-------	---------------	------------	-----	-----------------	--------------------------	-------------------

Series LFN45B - Max Pressure 400psi w/Bypass

NPT Threaded Female Inlet x NPT Threaded Female Outlet

LEAD FREE*	Model	Ordering Code	Size (in.)	UPC	Qty. Per Carton	Weight Per Carton (lbs.)	List Price (each)
	LFN45BM1	0009470	1/2	098268332308	12	24	\$ 115.50
	LFN45BM1	0009477	3/4	098268332391	12	20	116.50
	LFN45BM1	0009489	1	098268332575	12	30	139.00
	LFN45B	0009503	1 1/4	098268332728	1	6.0	331.00
	LFN45B	0009514	1 1/2	098268332827	1	6.3	526.00
	LFN45B	0009523	2	098268332926	1	7.0	690.00

NPT Threaded Female Union Inlet x NPT Threaded Female Outlet

LEAD FREE*	Model	Ordering Code	Size (in.)	UPC	Qty. Per Carton	Weight Per Carton (lbs.)	List Price (each)
	LFN45BM1-U	0009471	1/2	098268332315	12	24	120.00
	LFN45BM1-U	0009478	3/4	098268332407	12	24	121.50
	LFN45BM1-U	0009490	1	098268332582	12	33	156.00
	LFN45BU	0009516	1 1/2	098268332858	1	7.6	570.50

Quick-Connect Union Inlet x NPT Threaded Female Outlet

LEAD FREE*	Model	Ordering Code	Size (in.)	UPC	Qty. Per Carton	Weight Per Carton (lbs.)	List Price (each)
	LFN45BM1-U-QC	0121279	3/4	098268582291	12	34	56.25
	LFN45BM1-U-QC	0121280	1	098268582307	12	42	206.50

Solder Union Inlet x NPT Threaded Female Outlet

LEAD FREE*	Model	Ordering Code	Size (in.)	UPC	Qty. Per Carton	Weight Per Carton (lbs.)	List Price (each)
	LFN45BM1-U-S	0009480	3/4	098268332438	12	23	121.50
	LFN45BM1-U-S	0009492	1	098268332605	12	26	156.00

NPT Threaded Female Union Inlet x NPT Threaded Female Union Outlet

LEAD FREE*	Model	Ordering Code	Size (in.)	UPC	Qty. Per Carton	Weight Per Carton (lbs.)	List Price (each)
	LFN45BM1-DU	0009479	3/4	098268332414	12	26	132.50
	LFN45BM1-DU	0009491	1	098268332599	6	18	174.00

Quick-Connect Union Inlet x Quick-Connect Union Outlet

LEAD FREE*	Model	Ordering Code	Size (in.)	UPC	Qty. Per Carton	Weight Per Carton (lbs.)	List Price (each)
	LFN45BDU-QC M1	0125321	3/4	098268860504	12	23	154.50
	LFN45BDU-QC M1	0125322	1	098268860511	12	32	202.00

Solder Union Inlet x Solder Union Outlet

LEAD FREE*	Model	Ordering Code	Size (in.)	UPC	Qty. Per Carton	Weight Per Carton (lbs.)	List Price (each)
	LFN45BM1-DU-S	0009481	3/4	098268332469	12	25	132.50
	LFN45BM1-DU-S	0009493	1	098268332612	6	15	174.00
	LFN45BDU-S	0009801	1 1/4	098268428612	1	7.3	387.00
	LFN45BDU-S	0009800	1 1/2	098268428605	1	8.9	622.50
	LFN45BDU-S	0009533	2	098268333046	1	10	794.00

NPT Threaded Union Connections inlet and outlet and Calibrated Outlet Adjustment

LEAD FREE*	Model	Ordering Code	Size (in.)	UPC	Qty. Per Carton	Weight Per Carton (lbs.)	List Price (each)
	LFN45BM1-DU-EZ	0009482	3/4	098268332476	12	29	147.50
	LFN45BM1-DU-EZ	0009498	1	098268332667	6	18	160.00

PEX Union Inlet x PEX Union Outlet

LEAD FREE*	Model	Ordering Code	Size (in.)	UPC	Qty. Per Carton	Weight Per Carton (lbs.)	List Price (each)
	LFN45BM1-DU-PEXxPEX	0009485	3/4	098268332520	12	26	103.00

CPVC Union Inlet x CPVC Union Outlet

LEAD FREE*	Model	Ordering Code	Size (in.)	UPC	Qty. Per Carton	Weight Per Carton (lbs.)	List Price (each)
	LFN45BM1-DU-CPVC	0009486	3/4	098268332537	12	25	127.00
	LFN45BM1-DU-CPVC	0009496	1	098268332643	6	18	171.50

SERIES LFN45B:
Standard Features

Corrosion-resistant adjusting screw and sealed cage for waterworks pit installations



LFN45BU

Unless noted, all pressure reducing valves on this page are factory set at 50psi. Adjustable range is 25 – 75psi.



LFN45BDU-QC-M1



LFN45BDU



LFN45BDU-EZ

*The wetted surface of this product contacted by consumable water contains less than 0.25% of lead by weight.

Consult factory for ordering code numbers of special models/options.

Water Pressure Reducing Valves

Pressure Regulators & Automatic Control Valves

How To Order Jumper Kits

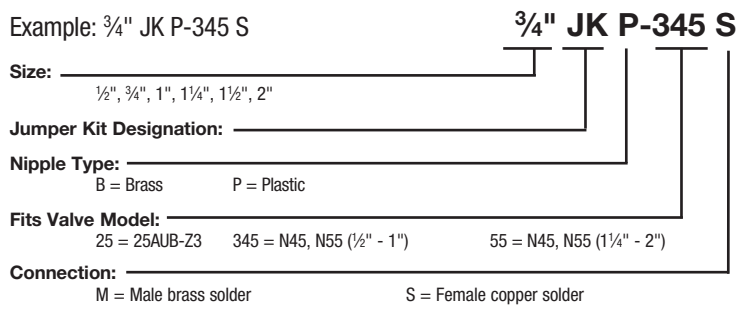

Model	Ordering Code	Size (in.)	UPC	Qty. Per Carton	Weight Per Carton (lbs.)	List Price (each)
-------	---------------	------------	-----	-----------------	--------------------------	-------------------

Jumper Kits

Complete Kits With Plastic Nipple

Female x Female Copper Sweat Tailpiece

JK-P-25 S	0006944	1 1/4	098268554175	6	19	\$ 70.00
JK-P-55 S	0007721	1 1/4	098268200133	6	20	74.50

Female Copper Sweat x Male Brass Sweat Tailpiece

JK-P-345-FM S	0006943	1	098268554168	12	14	38.00
---------------	---------	---	--------------	----	----	-------

Complete Kits With Brass Nipple

Female x Female Copper Sweat Tailpiece

JK-B-25 S	0006304	1	098268216127	12	23	79.00
JK-B-25 S	0006939	1 1/4	098268064780	6	36	81.75
JK-B-55 S	0007737	2	098268253894	6	29	101.00



Jumper Kit

Jumper Kits Include: Jumper nipple, strainer screen, 2 fiber washers, 2 union nuts and tailpieces.

Jumper Kits are the correct lay length for the water pressure reducing valves.

When removing jumper nipple and inserting the water pressure reducing valve, two O-rings (ordered separately) are required.

*The wetted surface of this product contacted by consumable water contains less than 0.25% of lead by weight.

Consult factory for ordering code numbers of special models/options.

Water Pressure Reducing Valves

Model	Ordering Code	Size (in.)	UPC	Qty. Per Carton	Weight Per Carton (lbs.)	List Price (each)
-------	---------------	------------	-----	-----------------	--------------------------	-------------------

High Capacity

Series LFN250/LFN250B - Max. Pressure 250psi

Iron Body Water Pressure Regulators - NPT Threaded Female Connections

LEAD FREE*	Model	Ordering Code	Size (in.)	UPC	Qty. Per Carton	Weight Per Carton (lbs.)	List Price (each)	
	LFN250B	0121241	1/2	25-75	098268580501	12	44	\$ 204.50
	LFN250B	0121243	3/4	25-75	098268581348	6	22	240.50
	LFN250	0121242	3/4	25-75	098268581331	6	22	224.00

Suffix B - bypass feature

Series LF127W - Max Pressure 175psi

Pressure Range 25-100psi

LEAD FREE*	Model	Ordering Code	Size (in.)	UPC	Qty. Per Carton	Weight Per Carton (lbs.)	List Price (each)	
	LF127W-206	0009904	3	Bronze	098268430592	1	39	\$ 6,459.00

Series LFF127W - Max Pressure 175psi

Flange Connections

LEAD FREE*	Model	Ordering Code	Size (in.)	UPC	Qty. Per Carton	Weight Per Carton (lbs.)	List Price (each)	
	LFF127W-206	0009905	3	Iron	098268430608	1	47	6,952.00
	LFF127W-206	0009906	4	Iron	098268430615	1	81	8,608.00

*Model N223B - 3" size can be used as an alternative to 127W. †Max. pressure 175psi.

Unless noted, all pressure reducing valves on this page are factory set at 50psi. Adjustable range is 25 - 75psi.

Series LF223 - Max Pressure 300psi

Without Strainer - NPT Threaded Female Connections

LEAD FREE*	Model	Ordering Code	Size (in.)	UPC	Qty. Per Carton	Weight Per Carton (lbs.)	List Price (each)	
	LF223	0298500	1/2	Brass	098268349375	6	27	542.50
	LF223	0298514	3/4	Brass	098268349511	6	27	542.50
	LF223	0298533	1	Brass	098268349702	6	41	840.00
	LF223	0298553	1 1/4	Brass	098268349917	6	49	1,502.00
	LF223	0298568	1 1/2	Brass	098268350401	1	16	2,268.00
	LF223	0298585	2	Brass	098268350623	1	26	3,273.00
	LF223	0298601	2 1/2	Iron	098268350784	1	27	3,601.00

With Strainer - NPT Threaded Female Connections

LEAD FREE*	Model	Ordering Code	Size (in.)	UPC	Qty. Per Carton	Weight Per Carton (lbs.)	List Price (each)	
	LF223-S	0298510	1/2	Brass	098268349474	6	27	739.00
	LF223-S	0298524	3/4	Brass	098268349610	6	34	739.00
	LF223-S	0298546	1	Brass	098268349832	1	9.0	1,061.00
	LF223-S	0298561	1 1/4	Brass	098268350272	1	11	1,835.00
	LF223-S	0298574	1 1/2	Brass	098268350463	1	20	2,685.00
	LF223-S	0298594	2	Brass	098268350715	1	34	3,915.00

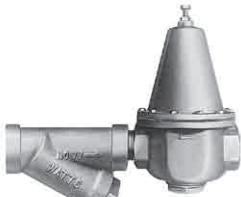

LF223S



LFN223F-M2

Series LFN223 - Max Pressure 300psi

Without Strainer - NPT Threaded Female Connections

LEAD FREE*	Model	Ordering Code	Size (in.)	UPC	Qty. Per Carton	Weight Per Carton (lbs.)	List Price (each)	
	LFN223-B-M2	0298602	2 1/2	Brass	098268350791	1	27	4,307.00
	LFN223-B-M1	0298615	3	Brass	098268350944	1	70	5,006.00
	LFN223FM2	0298620	3	Iron	098268350999	1	88	5,202.00

With Bronze Strainer - NPT Threaded Female Connections

LEAD FREE*	Model	Ordering Code	Size (in.)	UPC	Qty. Per Carton	Weight Per Carton (lbs.)	List Price (each)	
	LFN223M2-S-B	0298609	2 1/2	Bronze	098268350869	1	39	5,601.00
	LFN223M1-S-B	0298617	3	Bronze	098268350968	1	96	6,714.00
	LFN223FM2-S	0298621	3	Iron	098268351002	1	125	6,615.00

SERIES LF223, LF223S, LFN223B:

Options

- B** - Built-in bypass feature; list price 5% extra
- HP** - High pressure range 50 - 145psi; price 25% extra (223 Series only)
- LP** - Low pressure range 10 - 35psi; price 25% extra (223 Series only)
- Z3** - Sealed spring cage and stainless steel corrosion resistant adjusting & cage screws for accessible outdoor or pit installations list price 10% extra (1/2" - 1")

*The wetted surface of this product contacted by consumable water contains less than 0.25% of lead by weight.

Consult factory for ordering code numbers of special models/options.

Water Pressure Reducing Valves

Model	Ordering Code	Size (in.)	Body	UPC	Carton Qty	Weight Per Carton (lbs.)	List Price (each)
-------	---------------	---------------	------	-----	---------------	-----------------------------	----------------------



2300

Direct Operated Water Pressure Reducing Valves

Series 2300 - Max Pressure 200psi

Pressure Range 30-80psi; Max Pressure 200psi

LEAD FREE*	Model	Ordering Code	Size (in.)	UPC	Carton Qty	Weight Per Carton (lbs.)	List Price (each)
	2300	0681040	3	098268086850	1	121	\$ 13,805.00
	2300	0681060	4	098268086867	1	225	19,706.00

*The wetted surface of this product contacted by consumable water contains less than 0.25% of lead by weight.

Consult factory for ordering code numbers of special models/options.

Water Pressure Reducing Valves



LF26A

Model	Ordering Code	Size (in.)	Pressure Range (psi)	UPC	Qty. Per Carton	Weight Per Carton (lbs.)	List Price (each)
-------	---------------	------------	----------------------	-----	-----------------	--------------------------	-------------------

Small Capacity Series LF26A - Max Pressure 300psi

Compact Water Pressure Regulators

Model	Ordering Code	Size (in.)	Pressure Range (psi)	UPC	Qty. Per Carton	Weight Per Carton (lbs.)	List Price (each)
LF26A 1-25	0009810	1/4	1-25	098268428674	25	30	169.00
LF26A 1-25	0009814	3/8	1-25	098268428711	25	25	169.00
LF26A 1-25	0009818	1/2	1-25	098268428759	12	15	220.00
LF26A 3-50	0125326	1/8	3-50	098268860559	25	25	169.00
LF26A 3-50	0009811	1/4	3-50	098268428681	25	27	169.00
LF26A 3-50	0009815	3/8	3-50	098268428728	25	26	169.00
LF26A 3-50	0009819	1/2	3-50	098268428766	12	15	220.00
LF26A 10-125	0009812	1/4	10-125	098268428698	25	28	169.00
LF26A 10-125	0009816	3/8	10-125	098268428735	25	27	169.00
LF26A 10-125	0009820	1/2	10-125	098268428773	12	15	220.00
LF26A 50-175	0009817	3/8	50-175	098268428742	25	30	169.00



LF263A 3-way

Series LF263A - Max Pressure 300psi

Compact Water Pressure Regulators, 3-way Flow

Model	Ordering Code	Size (in.)	Pressure Range (psi)	UPC	Qty. Per Carton	Weight Per Carton (lbs.)	List Price (each)
LF263A 3-50	0009821	1/4	3-50	098268428780	25	26	184.00
LF263A 3-50	0009827	3/8	3-50	098268428841	25	28	184.00
LF263A 3-50	0009835	1/2	3-50	098268428926	12	14	236.50
LF263A 10-125	0009823	1/4	10-125	098268428803	25	48	184.00
LF263A 10-125	0009828	3/8	10-125	098268428858	25	24	184.00
LF263A 10-125	0009836	1/2	10-125	098268428933	12	20	236.50
LF263A 1-25	0009826	3/8	1-25	098268428834	25	25	184.00
LF263A 1-25	0009834	1/2	1-25	098268428919	12	17	236.50
LF263A 50-175	0009837	1/2	50-175	098268428940	12	20	236.50
LF263AP 20-175	0009898	1/2	20-175	098268430530	12	15	510.50

Compact Water Pressure Regulator - Stainless Steel Body, 3-Way Flow

Model	Ordering Code	Size (in.)	Pressure Range (psi)	UPC	Qty. Per Carton	Weight Per Carton (lbs.)	List Price (each)
SS263AP-M1 1-25	0335115	1/2	1-25	098268081046	12	21	849.00
SS263AP-M1 3-50	0335077	1/2	3-50	098268197617	12	23	849.00
SS263AP-M1 10-125	0335078	1/2	10-125	098268197624	12	22	849.00
SS263AP-M1 20-175	0335079	1/2	20-175	098268197631	12	22	849.00
SS263AP-M1 100-300	0335080	1/2	100-300	098268197648	12	23	849.00

*The wetted surface of this product contacted by consumable water contains less than 0.25% of lead by weight.
Consult factory for ordering code numbers of special models/options.

Water Pressure Reducing Valves

Pressure Regulators & Automatic Control Valves



LF123LP

Model	Ordering Code	Size (in.)	Pressure Range (psi)	UPC	Qty. Per Carton	Weight Per Carton (lbs.)	List Price (each)
-------	---------------	------------	----------------------	-----	-----------------	--------------------------	-------------------

Series LF123LP - Max Pressure 200psi

Factory Set at 30psi

LEAD FREE	Model	Ordering Code	Size (in.)	Pressure Range (psi)	UPC	Qty. Per Carton	Weight Per Carton (lbs.)	List Price (each)
	LF123-LP	0121224	1/2	10-30	098268580235	12	23	\$ 476.00
	LF123-LP	0121225	3/4	10-30	098268580242	6	19	552.50

Compact Water Pressure Regulators

Series LF560 - Max Pressure 300psi

Compact Water Pressure Regulator

LEAD FREE	Model	Ordering Code	Size (in.)	Pressure Range (psi)	UPC	Qty. Per Carton	Weight Per Carton (lbs.)	List Price (each)
	LF560 0-60	0121250	1/8	0-60	098268581508	50	45	148.50
	LF560-G 0-60	0121253	1/8	0-60	098268581553	24	24	214.00
	LF560 0-60	0121257	1/4	0-60	098268581591	50	28	148.50
	LF560-G 0-60	0121256	1/4	0-60	098268581584	24	19	214.00

0-25 and 0-125psi pressure ranges also available. Consult factory for ordering codes.



LFH560G

Series LFH560 - Max Pressure 150psi

Factory Preset to 40psi

Compact Water Pressure Regulator - with Hose End Connections

LEAD FREE	Model	Ordering Code	Size (in.)	Pressure Range (psi)	UPC	Qty. Per Carton	Weight Per Carton (lbs.)	List Price (each)
	LFH560	0121264	3/4 HT	10-60	098268582079	24	22	178.50
	LFH560-G	0121265	3/4 HT	10-60	098268582086	24	23	248.50
	LFH560-G	0121265	3/4 HT	10-60	098268582086	24	23	248.50



P60

Miniature Water Pressure Regulators

Series P60M1 - Max Pressure 300psi, Plastic Regulator

LEAD FREE	Model	Ordering Code	Size (in.)	Pressure Range (psi)	UPC	Qty. Per Carton	Weight Per Carton (lbs.)	List Price (each)
	P60M1 0-25	0354554	1/4	0-25	098268224375	50	7	117.50
	P60M1 0-60	0354555	1/4	0-60	098268224382	50	8	117.50
	P60M1 0-125	0354556	1/4	0-125	098268224399	50	8	117.00

Series LF215 - Max Pressure 300psi

Water, No. 2 Fuel Oil

LEAD FREE	Model	Ordering Code	Size (in.)	Pressure Range (psi)	UPC	Qty. Per Carton	Weight Per Carton (lbs.)	List Price (each)
	LF215M1 0-50	0009840	1/4	0-50	098268428971	6	14	438.00
	LF215M1 0-50	0009842	3/8	0-50	098268428995	6	14	438.00

0-8 and 0-20psi pressure ranges also available. Consult factory for ordering codes.



LF215

*The wetted surface of this product contacted by consumable water contains less than 0.25% of lead by weight.

Consult factory for ordering code numbers of special models/options.

Model	Ordering Code	Size (in.)	Pressure Range (psi)	UPC	Qty. Per Carton	Weight Per Carton (lbs.)	List Price (each)
-------	---------------	------------	----------------------	-----	-----------------	--------------------------	-------------------

Series 152A

Max. Pressure 200psi – Stainless Steel Disc, Seat and Strainer – For Steam or Liquid Service – Iron Body



152A

152A 3-15	†0830886	1/2	3-15	098268095692	4	49	\$ 684.00
152A 10-50	†0830910	1/2	10-50	098268095784	4	47	684.00
152A 30-140	†0830905	1/2	30-140	098268095760	4	48	684.00
152A 3-15	†0830918	3/4	3-15	098268095821	4	47	823.00
152A 10-50	†0830920	3/4	10-50	098268095845	4	48	823.00
152A 30-140	†0830928	3/4	30-140	098268095869	4	44	823.00
152A 3-15	†0830946	1	3-15	098268095968	1	20	1,075.00
152A 10-30	†0830945	1	10-30	098268095951	1	20	1,075.00
152A 30-140	†0830950	1	30-140	098268095999	1	21	1,075.00
152A 3-15	†0830957	1 1/4	3-15	098268096026	1	20	1,484.00
152A 10-30	†0830960	1 1/4	10-30	098268096040	1	20	1,484.00
152A 30-140	†0830965	1 1/4	30-140	098268096057	1	20	1,484.00
152A 5-40	†0830985	1 1/2	5-40	098268096064	1	40	1,667.00
152A 30-100	†0830988	1 1/2	30-100	098268096071	1	41	1,667.00
152A 5-40	†0831010	2	5-40	098268096088	1	41	2,420.00
152A 30-100	†0831015	2	30-100	098268096118	1	40	2,420.00

Use Model 152AT for extra tight seating in liquid service. Available in these sizes. List Price 10% extra

Series 152SS

Stainless Steel Body – 152SS (Up to 300psi @ 420°F), 152SST (300psi @ 300°F – 200psi @ 400°F)

152SS 3-15	†0842076	1/2	3-15	098268234817	1	13	\$ 7,479.00
152SS 10-50	†0842072	1/2	10-50	098268103090	4	11	7,479.00
152SS 30-140	†0842073	1/2	30-140	098268213263	4	55	7,479.00
152SS 3-15	†0842087	3/4	3-15	098268234824	1	13	8,265.00
152SS 10-50	†0842086	3/4	10-50	098268103137	1	13	8,265.00
152SS 30-140	†0842088	3/4	30-140	098268234831	4	54	8,265.00
152SS 3-15	†0842107	1	3-15	098268234848	1	13	8,658.00
152SS 10-50	†0842106	1	10-50	098268103205	1	13	8,658.00
152SS 30-140	†0842108	1	30-140	098268307559	1	14	8,658.00

Use Model 152SST for extra tight seating in liquid service. Available in these sizes. List Price 10% extra

Series 252A

Max. Pressure 300psi – Bronze Body

252A 3-15	†0839720	1/2	3-15	098268102758	4	48	1,173.00
252A 10-50	†0839721	1/2	10-50	098268102765	4	49	1,173.00
252A 30-140	†0839740	1/2	30-140	098268102802	4	50	1,173.00
252A 3-15	†0839828	3/4	3-15	098268102895	4	48	1,397.00
252A 10-50	†0839831	3/4	10-50	098268102925	4	49	1,397.00
252A 30-140	†0839827	3/4	30-140	098268102888	4	51	1,397.00
252A 3-15	†0839982	1	3-15	098268199178	1	21	1,696.00
252A 10-50	†0839981	1	10-50	098268103052	1	21	1,696.00
252A 30-140	†0840000	1	30-140	098268103069	1	22	1,696.00

Use Model 252AT for extra tight seating in liquid service. List Price 10% extra.

Steam Pressure Regulators

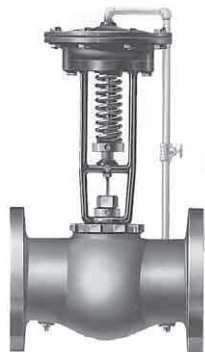

F127SS

Model	Ordering Code	Size (in.)	Body	UPC	Carton Qty	Weight Per Carton (lbs.)	List Price (each)
-------	---------------	------------	------	-----	------------	--------------------------	-------------------

High Capacity Diaphragm Operated Steam Pressure Regulators Series 127

Threaded Connections

127SS-206	0826229	1/2	Bronze	098268094589	1	22	\$ 2,932.00
127SS-206	0826543	3/4	Bronze	098268094633	1	22	2,932.00
127SS-206	0826861	1	Bronze	098268094688	1	23	3,275.00
127SS-208	0827187	1 1/4	Bronze	098268094763	1	28	3,619.00
127SS-208	0827314	1 1/2	Bronze	098268094817	1	30	4,139.00
127SS-208	0827334	2	Bronze	098268094879	1	32	5,070.00
127SS-208	0828250	2 1/2	Bronze	098268094923	1	36	6,353.00
127SS-208	0828290	3	Bronze	098268095012	1	40	7,242.00

Series F127

Flange Connections

F127SS-208	0828292	3	Iron	098268095029	1	51	7,933.00
F127SS-208	0828330	4	Iron	098268095098	1	83	9,997.00

Standardly furnished with stainless steel valve disc.

For reduced pressure below 10psi, prices subject to \$85.85 list extra, whenever special extra large diaphragm is required.

When ordering Series 127 and F127, be sure to specify initial pressure and reduced pressure setting or range required.

Automatic Control Valves

Lead Free* Series Materials of Construction	
Body & Cover	Ductile Iron - NSF 61 Approved Fusion Bonded Epoxy Coating (inside & outside)
Cover Bearing	Stainless Steel
Valve Trim	Stainless Steel
Elastomers	Buna-N (optional EPDM & Viton)
Tubing & Fittings	Lead Free Brass with Copper Tubing (Stainless Optional)
Pressure Reducing Control	LF263 - Lead Free Brass / Buna-N (options available)
Range	20-175psi
Pressure Relief Control	LFPV20 - Lead Free Copper Silicon Alloy / Buna-N (options available)
Range	20-200psi
Pressure Sustaining Control	LFPV20 - Lead Free Copper Silicon Alloy / Buna-N (options available)
Range	20-200psi
Surge Control	LFPV20 - Lead Free Copper Silicon Alloy / Buna-N (options available)
Range	20-200psi
Check Valves	Lead Free Copper Silicon Alloy (options available)
Solenoid Control	Brass or Stainless Steel

Standard Production Valves:
Globe pattern 1¼" – 24",
Angle pattern 1¼" – 12",
 Ductile Iron body and cover with NSF Approved heat fusion bonded epoxy coated (inside & out), Long life non-edged stainless steel seat, FDA Approved Buna-N diaphragm, Top and bottom guided stem. Consult factory for specifications and ordering codes.

Model	Size (in.)	Qty Per Carton	Estimated Weight Per Carton (lbs.)	Threaded List Price	Iron Body 150#FLG. List Price	Iron Body 300#FLG. List Price
-------	------------	----------------	------------------------------------	---------------------	-------------------------------	-------------------------------

Automatic Control Valve Features – Classic Series ACV110-10 Globe / 1110-10 Angle



Float Control - Modulating (Constant Level)

Model	Size (in.)	Qty Per Carton	Estimated Weight Per Carton (lbs.)	Threaded List Price	Iron Body 150#FLG. List Price	Iron Body 300#FLG. List Price
LF110-10/LF1110-10	1 1/4"	1	25	\$2,449.00	-	-
LF110-10/LF1110-10	1 1/2"	1	25	2,449.00	\$2,597.00	-
LF110-10/LF1110-10	2"	1	25	2,491.00	2,666.00	\$2,728.00
LF110-10/LF1110-10	2 1/2"	1	60	2,923.00	2,946.00	3,195.00
LF110-10/LF1110-10	3"	1	60	3,179.00	3,179.00	3,365.00
LF110-10/LF1110-10	4"	1	100	-	4,142.00	4,362.00
LF110-10/LF1110-10	6"	1	195	-	5,816.00	6,440.00
LF110-10/LF1110-10	8"	1	415	-	9,433.00	10,429.00

*The wetted surface of this product contacted by consumable water contains less than 0.25% of lead by weight.
 Consult factory for ordering code numbers of special models/options.

Automatic Control Valves

Model	Ordering Code	Size (in.)	Body	Qty Per Carton	Estimated Weight Per Carton (lbs.)	Threaded List Price
-------	---------------	------------	------	----------------	------------------------------------	---------------------

ACV110-14 Globe / 1110-14 Angle On/Off (open/closed)

Classic Series

NPT Threaded Valves

Float Control Valve (Adjustable Hi/Lo level) On/Off Float Valve

Model	Ordering Code	Size (in.)	Body	Qty Per Carton	Estimated Weight Per Carton (lbs.)	Threaded List Price
LFF110-14 Globe Threaded	T713315	1 1/4"	Ductile Iron w LF Brass Pilot	1	35	\$1,735.00
LFF110-14 Globe Threaded	T259910	1 1/2"	Ductile Iron w LF Brass Pilot	1	35	\$1,753.00
LFF110-14 Globe Threaded	T689012	2"	Ductile Iron w LF Brass Pilot	1	35	\$1,793.00
LFF110-14 Globe Threaded	CF*	2 1/2"	Ductile Iron w LF Brass Pilot	1	70	\$2,022.00
LFF110-14 Globe Threaded	CF*	3"	Ductile Iron w LF Brass Pilot	1	70	\$2,319.00

CF* - Consult Factory

For Threaded Angle Valves List Price is the Same as Globe Valves - Consult Factory for Ordering Code

Mustang Series List Pricing identical to Classic Series Consult Factory for Ordering Code

Valve standard with stainless rods/plastic float. Size 2" - 6" std. with (2) 12" rods. Sizes 8" - 16" std. with (4) 12" rods.

Additional Rods: LF Series Stainless Steel 12" ...add \$60.00 each.

Model	Ordering Code	Size (in.)	Body	Qty. Per Carton	Estimated Weight Per Carton (lbs.)	Iron Body 150# FLG List Price	Ordering Code Class 300	Iron Body 300 #FLG List Price
-------	---------------	------------	------	-----------------	------------------------------------	-------------------------------	-------------------------	-------------------------------

Classic Series

Flanged Valves

Float Control Valve (Adjustable Hi/Lo level) On/Off Float Valve

Model	Ordering Code	Size (in.)	Body	Qty. Per Carton	Estimated Weight Per Carton (lbs.)	Iron Body 150# FLG List Price	Ordering Code Class 300	Iron Body 300 #FLG List Price
LFF110-14 Globe Class 150 Flanged	CF*	1 1/2"	Ductile Iron w LF Brass Pilot	1	35	\$1,905.00	-	-
LFF110-14 Globe Class 150 Flanged	T704312	2"	Ductile Iron w LF Brass Pilot	1	35	\$2,045.00	CF*	\$2,080.00
LFF110-14 Globe Class 150 Flanged	T065403	2 1/2"	Ductile Iron w LF Brass Pilot	1	70	\$2,374.00	CF*	\$2,562.00
LFF110-14 Globe Class 150 Flanged	CF*	3"	Ductile Iron w LF Brass Pilot	1	70	\$2,435.00	CF*	\$2,641.00
LFF110-14 Globe Class 150 Flanged	7420-09	4"	Ductile Iron w LF Brass Pilot	1	120	\$3,345.00	CF*	\$4,041.00
LFF110-14 Globe Class 150 Flanged	8119-06	6"	Ductile Iron w LF Brass Pilot	1	220	\$5,042.00	CF*	\$5,454.00
LFF110-14 Globe Class 150 Flanged	6680-09	8"	Ductile Iron w LF Brass Pilot	1	425	\$9,825.00	CF*	\$10,430.00

CF* - Consult Factory

For Flanged Angle Valves List Price is the Same as Globe Valves - Consult Factory for Ordering Code

Mustang Series List Pricing identical to Classic Series Consult Factory for Ordering Code

Valve standard with stainless rods/plastic float. Size 2" - 6" std. with (2) 12" rods. Sizes 8" - 16" std. with (4) 12" rods.

Additional Rods: LF Series Stainless Steel 12" ...add \$60.00 each.



Automatic Control Valves

Model	Size (in.)	Qty Per Carton	Estimated Weight Per Carton (lbs.)	Threaded List Price	Iron Body 150#FLG. List Price	Iron Body 300#FLG. List Price
-------	------------	----------------	------------------------------------	---------------------	-------------------------------	-------------------------------



ACV113-12 Globe / 1113-12 Angle
LFF113-12 or LFM113-12 Globe / LFF1113-12 or LFM1113-12 Angle
Solenoid On/Off (open/closed) sizes: 1 1/4" - 4"

LEAD FREE*	Model	Size (in.)	Qty Per Carton	Estimated Weight Per Carton (lbs.)	Threaded List Price	Iron Body 150#FLG. List Price	Iron Body 300#FLG. List Price
	LFF113-12 / LFM113-12 / LFF1113-12 / LFM1113-12	1 1/4"	1	30	\$1,269.00	-	-
	LFF113-12 / LFM113-12 / LFF1113-12 / LFM1113-12	1 1/2"	1	30	1,292.00	-	-
	LFF113-12 / LFM113-12 / LFF1113-12 / LFM1113-12	2"	1	30	1,341.00	\$1,684.00	Consult
	LFF113-12 / LFM113-12 / LFF1113-12 / LFM1113-12	2 1/2"	1	65	1,698.00	1,719.00	Consult
	LFF113-12 / LFM113-12 / LFF1113-12 / LFM1113-12	3"	1	65	1,764.00	1,908.00	Consult
LFF113-12 / LFM113-12 / LFF1113-12 / LFM1113-12	4"	1	110	-	2626.00	Consult	

Note: Manual Operator Standard, specify voltage, specify energize to open or close main valve.

ACV113-6 Globe / 1113-6 Angle
LFF113-6 or LFM113-6 Globe / LFF1113-6 or LFM1113-6 Angle
Solenoid On/Off (open/closed) with high capacity controls for fast operation. Sizes 6" - 24"

LEAD FREE*	Model	Size (in.)	Qty Per Carton	Estimated Weight Per Carton (lbs.)	Threaded List Price	Iron Body 150#FLG. List Price	Iron Body 300#FLG. List Price
	LFF113-6 / LFM113-6 / LFF1113-6 / LFM1113-6	6"	1	220	-	\$6,444.00	\$6,899.00
LFF113-6 / LFM113-6 / LFF1113-6 / LFM1113-6	8"	1	440	-	9,579.00	9,828.00	

Note: Manual Operator Standard, specify voltage, specify energize to open or close main valve.

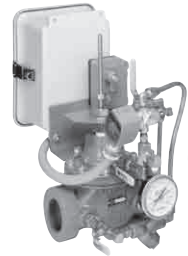

Model	Ordering Code	Size (in.)	Body	Qty Per Carton	Estimated Weight Per Carton (lbs.)	Iron Body 150#FLG. List Price	Ordering Code Threaded	Iron Body Threaded List Price
-------	---------------	------------	------	----------------	------------------------------------	-------------------------------	------------------------	-------------------------------

ACV113-RFP Globe / 1113-RFP Angle
Flood Prevention Solenoid On/Off valve

LEAD FREE*	Model	Ordering Code	Size (in.)	Body	Qty Per Carton	Estimated Weight Per Carton (lbs.)	Iron Body 150#FLG. List Price	Ordering Code Threaded	Iron Body Threaded List Price
	LFF113RFP Globe Class 150 Flanged		1 1/4	Ductile Iron w LF Brass Pilot	1	35		VT093302	\$8,155.00
	LFF113RFP Globe Class 150 Flanged		1 1/2	Ductile Iron w LF Brass Pilot	1	35		VT210502	\$8,276.00
	LFF113RFP Globe Class 150 Flanged	VT851110	2	Ductile Iron w LF Brass Pilot	1	35	\$8,450.00	VT851109	\$8,432.00
	LFF113RFP Globe Class 150 Flanged	VT094402	2 1/2	Ductile Iron w LF Brass Pilot	1	70	\$8,460.00		
	LFF113RFP Globe Class 150 Flanged	V5728-04	3	Ductile Iron w LF Brass Pilot	1	70	\$8,643.00		
	LFF113RFP Globe Class 150 Flanged	V8290-04	4	Ductile Iron w LF Brass Pilot	1	120	\$10,209.00		
	LFF113RFP Globe Class 150 Flanged	V8077-04	6	Ductile Iron w LF Brass Pilot	1	220	\$11,139.00		
LFF113RFP Globe Class 150 Flanged	V7135-27	8	Ductile Iron w LF Brass Pilot	1	425	\$11,960.00			

CF*
 For Flanged Angle Valves List Price is the Same as Globe Valves - Consult Factory for Ordering Code
 Mustang Series List Pricing identical to Classic Series Consult Factory for Ordering Code

*The wetted surface of this product contacted by consumable water contains less than 0.25% of lead by weight.

Automatic Control Valves

Model	Ordering Code	Size (in.)	Body	Qty Per Carton	Estimated Weight Per Carton (lbs.)	Iron Body Threaded List Price
-------	---------------	------------	------	----------------	------------------------------------	-------------------------------

ACV115 Globe / 1115 Angle Classic Series NPT Threaded Valves



Pressure Reducing Control Valve (20 - 175 psi adjustment range)

Model	Ordering Code	Size (in.)	Body	Qty Per Carton	Estimated Weight Per Carton (lbs.)	Iron Body Threaded List Price
LFF115 Globe Threaded	VT200003	1 1/4"	Ductile Iron w LF Brass Pilot	1	35	\$1,949.00
LFF115 Globe Threaded	VT200203	1 1/2"	Ductile Iron w LF Brass Pilot	1	35	\$1,949.00
LFF115 Globe Threaded	VT200403	2"	Ductile Iron w LF Brass Pilot	1	35	\$1,995.00
LFF115 Globe Threaded	VT200803	2 1/2"	Ductile Iron w LF Brass Pilot	1	70	\$2,442.00
LFF115 Globe Threaded	V2012-03	3"	Ductile Iron w LF Brass Pilot	1	70	\$2,504.00

LEAD FREE*

For Threaded Angle Valves List Price is the Same as Globe Valves - Consult Factory for Ordering Code
Optional 100-300 psi range ...add \$217.00.
Mustang Series List Pricing identical to Classic Series Consult Factory for Ordering Code



Model	Ordering Code	Size (in.)	Body	Qty Per Carton	Estimated Weight Per Carton (lbs.)	Iron Body 150#FLG List Price	Ordering Code Class 300	Iron Body 300#FLG. List Price
-------	---------------	------------	------	----------------	------------------------------------	------------------------------	-------------------------	-------------------------------

Classic Series Flanged Valves

Pressure Reducing Control Valve (20 - 175 psi adjustment range)

Model	Ordering Code	Size (in.)	Body	Qty Per Carton	Estimated Weight Per Carton (lbs.)	Iron Body 150#FLG List Price	Ordering Code Class 300	Iron Body 300#FLG. List Price
LFF115 Globe Class 150 Flanged	T761110	1 1/2"	Ductile Iron w LF Brass Pilot	1	35	\$2,053.00	-	-
LFF115 Globe Class 150 Flanged	VT200503	2"	Ductile Iron w LF Brass Pilot	1	35	\$2,516.00	CF*	\$2,915.00
LFF115 Globe Class 150 Flanged	VT200903	2 1/2"	Ductile Iron w LF Brass Pilot	1	70	\$2,593.00	CF*	\$2,970.00
LFF115 Globe Class 150 Flanged	V2013-03	3"	Ductile Iron w LF Brass Pilot	1	70	\$2,697.00	CF*	\$2,990.00
LFF115 Globe Class 150 Flanged	2016-04	4"	Ductile Iron w LF Brass Pilot	1	120	\$3,465.00	7120-04	\$3,503.00
LFF115 Globe Class 150 Flanged	2018-04	6"	Ductile Iron w LF Brass Pilot	1	220	\$5,249.00	5536-06	\$5,830.00
LFF115 Globe Class 150 Flanged	4949-05	8"	Ductile Iron w LF Brass Pilot	1	425	\$8,990.00	CF*	\$10,540.00

LEAD FREE*

CF* - Consult Factory
For Flanged Angle Valves List Price is the Same as Globe Valves - Consult Factory for Ordering Code
Optional 100-300 psi range ...add \$217.00.
Mustang Series List Pricing identical to Classic Series Consult Factory for Ordering Code

*The wetted surface of this product contacted by consumable water contains less than 0.25% of lead by weight.

Automatic Control Valves

Model	Ordering Code	Size (in.)	Body	Qty Per Carton	Estimated Weight Per Carton (lbs.)	Iron Body Threaded List Price
-------	---------------	------------	------	----------------	------------------------------------	-------------------------------

ACV115-2 Globe / 1115-2 Angle Classic Series NPT Threaded Valves



Pressure Reducing and (Back Pressure) Sustaining Control Valve (20 - 175 psi adjustment range)

Model	Ordering Code	Size (in.)	Body	Qty Per Carton	Estimated Weight Per Carton (lbs.)	Iron Body Threaded List Price
LFF115-2 Globe Threaded	T203603	1 1/4"	Ductile Iron w LF Brass Pilot	1	35	\$2,732.00
LFF115-2 Globe Threaded	T203803	1 1/2"	Ductile Iron w LF Brass Pilot	1	35	\$2,747.00
LFF115-2 Globe Threaded	T204003	2"	Ductile Iron w LF Brass Pilot	1	35	\$2,779.00
LFF115-2 Globe Threaded	T099303	2 1/2"	Ductile Iron w LF Brass Pilot	1	70	\$3,209.00
LFF115-2 Globe Threaded	2048-03	3"	Ductile Iron w LF Brass Pilot	1	70	\$3,309.00

LEAD FREE*

For Threaded Angle Valves List Price is the Same as Globe Valves - Consult Factory for Ordering Code
Mustang Series List Pricing identical to Classic Series Consult Factory for Ordering Code
Optional 100-300 psi range ...add \$217.00.



Model	Ordering Code	Size (in.)	Body	Qty Per Carton	Estimated Weight Per Carton (lbs.)	Iron Body 150#FLG List Price	Ordering Code Class 300	Iron Body 300#FLG. List Price
-------	---------------	------------	------	----------------	------------------------------------	------------------------------	-------------------------	-------------------------------

Classic Series Flanged Valves

Pressure Reducing and (Back Pressure) Sustaining Control Valve (20 - 175 psi adjustment range)

Model	Ordering Code	Size (in.)	Body	Qty Per Carton	Estimated Weight Per Carton (lbs.)	Iron Body 150#FLG List Price	Ordering Code Class 300	Iron Body 300#FLG. List Price
LFF115-2 Globe Class 150 Flanged	T873008	1 1/2"	Ductile Iron w LF Brass Pilot	1	35	\$2,821.00		-
LFF115-2 Globe Class 150 Flanged	T206103	2"	Ductile Iron w LF Brass Pilot	1	35	\$2,903.00	CF*	\$3,302.00
LFF115-2 Globe Class 150 Flanged	T204503	2 1/2"	Ductile Iron w LF Brass Pilot	1	70	\$3,234.00	CF*	\$3,863.00
LFF115-2 Globe Class 150 Flanged	2049-03	3"	Ductile Iron w LF Brass Pilot	1	70	\$3,474.00	CF*	\$3,768.00
LFF115-2 Globe Class 150 Flanged	2052-04	4"	Ductile Iron w LF Brass Pilot	1	120	\$4,205.00	CF*	\$4,226.00
LFF115-2 Globe Class 150 Flanged	2054-04	6"	Ductile Iron w LF Brass Pilot	1	220	\$5,866.00	CF*	\$6,191.00
LFF115-2 Globe Class 150 Flanged	CF*	8"	Ductile Iron w LF Brass Pilot	1	425	\$9,977.00	CF*	\$11,527.00

LEAD FREE*

CF* - Consult Factory
For Flanged Angle Valves List Price is the Same as Globe Valves - Consult Factory for Ordering Code
Mustang Series List Pricing identical to Classic Series Consult Factory for Ordering Code
Optional 100-300 psi range ...add \$217.00.

*The wetted surface of this product contacted by consumable water contains less than 0.25% of lead by weight.

Automatic Control Valves

Pressure Regulators & Automatic Control Valves

Model	Ordering Code	Size (in.)	Body	Qty Per Carton	Estimated Weight Per Carton (lbs.)	Iron Body Threaded List Price
-------	---------------	------------	------	----------------	------------------------------------	-------------------------------

ACV115-3 Globe / 1115-3 Angle Classic Series NPT Threaded Valves

Pressure Reducing and Check Valve (20 - 175 psi adjustment range)

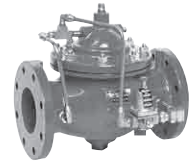

LEAD FREE*	Model	Ordering Code	Size (in.)	Body	Qty Per Carton	Estimated Weight Per Carton (lbs.)	Iron Body Threaded List Price
	LFF115-3 Globe Threaded	T853609	1 1/4"	Ductile Iron w LF Brass Pilot	1	35	\$2,344.00
	LFF115-3 Globe Threaded	T761812	1 1/2"	Ductile Iron w LF Brass Pilot	1	35	\$2,344.00
	LFF115-3 Globe Threaded	T207603	2"	Ductile Iron w LF Brass Pilot	1	35	\$2,387.00
	LFF115-3 Globe Threaded	T721128	2 1/2"	Ductile Iron w LF Brass Pilot	1	70	\$2,842.00
	LFF115-3 Globe Threaded	2084-03	3"	Ductile Iron w LF Brass Pilot	1	70	\$2,901.00

For Threaded Angle Valves List Price is the Same as Globe Valves - Consult Factory for Ordering Code
Mustang Series List Pricing identical to Classic Series Consult Factory for Ordering Code
Optional 100-300 psi range ...add \$217.00.



Model	Ordering Code	Size (in.)	Body	Qty Per Carton	Estimated Weight Per Carton (lbs.)	Iron Body 150#FLG List Price	Ordering Code Class 300	Iron Body 300#FLG. List Price
-------	---------------	------------	------	----------------	------------------------------------	------------------------------	-------------------------	-------------------------------

Classic Series Flanged Valves

Pressure Reducing and Check Valve (20 - 175 psi adjustment range)

LEAD FREE*	Model	Ordering Code	Size (in.)	Body	Qty Per Carton	Estimated Weight Per Carton (lbs.)	Iron Body 150#FLG List Price	Ordering Code Class 300	Iron Body 300#FLG. List Price
	LFF115-3 Globe Class 150 Flanged	T761808	1 1/2"	Ductile Iron w LF Brass Pilot	1	35	\$2,520.00	-	-
	LFF115-3 Globe Class 150 Flanged	T207703	2"	Ductile Iron w LF Brass Pilot	1	35	\$2,907.00	CF*	\$3,305.00
	LFF115-3 Globe Class 150 Flanged	T721120	2 1/2"	Ductile Iron w LF Brass Pilot	1	70	\$2,987.00	CF*	\$3,365.00
	LFF115-3 Globe Class 150 Flanged	2085-03	3"	Ductile Iron w LF Brass Pilot	1	70	\$3,098.00	CF*	\$3,392.00
	LFF115-3 Globe Class 150 Flanged	2088-06	4"	Ductile Iron w LF Brass Pilot	1	120	\$3,863.00	CF*	\$3,903.00
	LFF115-3 Globe Class 150 Flanged	2090-04	6"	Ductile Iron w LF Brass Pilot	1	220	\$5,642.00	CF*	\$5,967.00
	LFF115-3 Globe Class 150 Flanged	7981-04	8"	Ductile Iron w LF Brass Pilot	1	425	\$9,129.00	CF*	\$10,681.00

CF* - Consult Factory
For Flanged Angle Valves List Price is the Same as Globe Valves - Consult Factory for Ordering Code
Mustang Series List Pricing identical to Classic Series Consult Factory for Ordering Code
Optional 100-300 psi range ...add \$217.00.

*The wetted surface of this product contacted by consumable water contains less than 0.25% of lead by weight.

Automatic Control Valves

Model	Ordering Code	Size (in.)	Body	Qty Per Carton	Estimated Weight Per Carton (lbs.)	Iron Body Threaded List Price
-------	---------------	------------	------	----------------	------------------------------------	-------------------------------

ACV115-7 Globe / 1115-7 Angle Classic Series NPT Threaded Valves



Pressure Reducing and Downstream Surge Control Valve (20 - 175 psi adjustment range)

Model	Ordering Code	Size (in.)	Body	Qty Per Carton	Estimated Weight Per Carton (lbs.)	Iron Body Threaded List Price
LFF115-7 Globe Threaded	T210803	1 1/4"	Ductile Iron w LF Brass Pilot	1	35	\$2,732.00
LFF115-7 Globe Threaded	T211003	1 1/2"	Ductile Iron w LF Brass Pilot	1	35	\$2,747.00
LFF115-7 Globe Threaded	T211203	2"	Ductile Iron w LF Brass Pilot	1	35	\$2,779.00
LFF115-7 Globe Threaded	T849215	2 1/2"	Ductile Iron w LF Brass Pilot	1	70	\$3,210.00
LFF115-7 Globe Threaded	CF*	3"	Ductile Iron w LF Brass Pilot	1	70	\$3,310.00

For Threaded Angle Valves List Price is the Same as Globe Valves - Consult Factory for Ordering Code
Mustang Series List Pricing identical to Classic Series Consult Factory for Ordering Code
Optional 100-300 psi range ...add \$217.00.

Model	Ordering Code	Size (in.)	Body	Qty Per Carton	Estimated Weight Per Carton (lbs.)	Iron Body 150#FLG List Price	Ordering Code Class 300	Iron Body 300#FLG. List Price
-------	---------------	------------	------	----------------	------------------------------------	------------------------------	-------------------------	-------------------------------

Classic Series Flanged Valves

Pressure Reducing and Downstream Surge Control Valve (20 - 175 psi adjustment range)

Model	Ordering Code	Size (in.)	Body	Qty Per Carton	Estimated Weight Per Carton (lbs.)	Iron Body 150#FLG List Price	Ordering Code Class 300	Iron Body 300#FLG. List Price
LFF115-7 Globe Class 150 Flanged	T210803	1 1/2"	Ductile Iron w LF Brass Pilot	1	35	\$2,732.00	-	-
LFF115-7 Globe Class 150 Flanged	T211303	2"	Ductile Iron w LF Brass Pilot	1	35	\$2,907.00	CF*	\$3,302.00
LFF115-7 Globe Class 150 Flanged	T211703	2 1/2"	Ductile Iron w LF Brass Pilot	1	70	\$3,234.00	CF*	\$3,863.00
LFF115-7 Globe Class 150 Flanged	2121-03	3"	Ductile Iron w LF Brass Pilot	1	70	\$3,474.00	CF*	\$3,767.00
LFF115-7 Globe Class 150 Flanged	2124-05	4"	Ductile Iron w LF Brass Pilot	1	120	\$3,916.00	CF*	\$4,227.00
LFF115-7 Globe Class 150 Flanged	2126-04	6"	Ductile Iron w LF Brass Pilot	1	220	\$5,865.00	CF*	\$6,189.00
LFF115-7 Globe Class 150 Flanged	8776-07	8"	Ductile Iron w LF Brass Pilot	1	425	\$9,721.00	CF*	\$11,529.00

CF* - Consult Factory
For Flanged Angle Valves List Price is the Same as Globe Valves - Consult Factory for Ordering Code
Mustang Series List Pricing identical to Classic Series Consult Factory for Ordering Code
Optional 100-300 psi range ...add \$217.00.

*The wetted surface of this product contacted by consumable water contains less than 0.25% of lead by weight.

Automatic Control Valves

Model	Ordering Code	Size (in.)	Body	Qty Per Carton	Estimated Weight Per Carton (lbs.)	Iron Body Threaded List Price
-------	---------------	------------	------	----------------	------------------------------------	-------------------------------

ACV115-74 Globe / 1115-74 Angle Classic Series NPT Threaded Valves

Pressure Reducing Control Valve with Low Flow By-Pass (20 - 175 psi adjustment range)

LEAD FREE*	Model	Ordering Code	Size (in.)	Body	Qty Per Carton	Estimated Weight Per Carton (lbs.)	Iron Body Threaded List Price
	LFF115-74 Globe Threaded	T899809	1 1/4"	Ductile Iron w LF Brass Pilot	1	40	\$2,382.00
	LFF115-74 Globe Threaded	T083802	1 1/2"	Ductile Iron w LF Brass Pilot	1	40	\$2,385.00
	LFF115-74 Globe Threaded	T231805	2"	Ductile Iron w LF Brass Pilot	1	40	\$2,425.00
	LFF115-74 Globe Threaded	T871111	2 1/2"	Ductile Iron w LF Brass Pilot	1	75	\$2,701.00
	LFF115-74 Globe Threaded	8994-17	3"	Ductile Iron w LF Brass Pilot	1	75	\$2,780.00

For Threaded Angle Valves List Price is the Same as Globe Valves - Consult Factory for Ordering Code
Mustang Series List Pricing identical to Classic Series Consult Factory for Ordering Code
Optional 100-300 psi range ...add \$217.00.

Model	Ordering Code	Size (in.)	Body	Qty Per Carton	Estimated Weight Per Carton (lbs.)	Iron Body 150#FLG List Price	Ordering Code Class 300	Iron Body 300#FLG List Price
-------	---------------	------------	------	----------------	------------------------------------	------------------------------	-------------------------	------------------------------

Classic Series Flanged Valves

Pressure Reducing Control Valve with Low Flow By-Pass (20 - 175 psi adjustment range)

LEAD FREE*	Model	Ordering Code	Size (in.)	Body	Qty Per Carton	Estimated Weight Per Carton (lbs.)	Iron Body 150#FLG List Price	Ordering Code Class 300	Iron Body 300#FLG List Price
	LFF115-74 Globe Class 150 Flanged	T083803	1 1/2"	Ductile Iron w LF Brass Pilot	1	40	\$2,385.00	-	-
	LFF115-74 Globe Class 150 Flanged	T231806	2"	Ductile Iron w LF Brass Pilot	1	40	\$2,776.00	CF*	\$3,175.00
	LFF115-74 Globe Class 150 Flanged	T871110	2 1/2"	Ductile Iron w LF Brass Pilot	1	75	\$2,819.00	CF*	\$3,197.00
	LFF115-74 Globe Class 150 Flanged	8994-16	3"	Ductile Iron w LF Brass Pilot	1	75	\$2,909.00	CF*	\$3,203.00
	LFF115-74 Globe Class 150 Flanged	8583-12	4"	Ductile Iron w LF Brass Pilot	1	125	\$3,565.00	CF*	\$3,586.00
	LFF115-74 Globe Class 150 Flanged	8853-11	6"	Ductile Iron w LF Brass Pilot	1	230	\$5,190.00	CF*	\$5,514.00
	LFF115-74 Globe Class 150 Flanged	CF*	8"	Ductile Iron w LF Brass Pilot	1	440	\$9,302.00	CF*	\$10,852.00

CF* - Consult Factory
For Flanged Angle Valves List Price is the Same as Globe Valves - Consult Factory for Ordering Code
Mustang Series List Pricing identical to Classic Series Consult Factory for Ordering Code
Optional 100-300 psi range ...add \$217.00.

*The wetted surface of this product contacted by consumable water contains less than 0.25% of lead by weight.

Automatic Control Valves

Model	Ordering Code	Size (in.)	Qty Per Carton	Estimated Weight Per Carton (lbs.)	List Price (each)
-------	---------------	------------	----------------	------------------------------------	-------------------

"JM" Series Pressure Reducing Control Valves

Special 12 1/4" lay length to match 4" Watts Regulator Model 127W direct acting pressure reducing valve for retrofit applications. End Connection: 150# ANSI Flanged

Globe pattern, reduced port, ductile iron body and cover with NSF Approved heat fusion bonded epoxy coating (inside and out). Exclusive "Quad Seal" seat disc for positive drip-tight closure. Long life non-edged stainless steel seat, FDA Approved Buna-N diaphragm, Top and bottom guided stem with position indicator, Pilot system isolation ball valves and Upstream and Downstream gauge connections. Downstream pressure adjustment range: 30-300psi."

LF6115-JM

Pressure Reducing Control Valve (flow range: 30 - 580 gpm)

LEAD FREE*	Model	Ordering Code	Size (in.)	Qty Per Carton	Estimated Weight Per Carton (lbs.)	List Price (each)
	LF6115-JM	234801	4"	1	93	\$3,534.00
	LF6115-7JM					

Pressure Reducing and Downstream Surge Control Valve (flow range: 30 - 580 gpm)

LEAD FREE*	Model	Ordering Code	Size (in.)	Qty Per Carton	Estimated Weight Per Carton (lbs.)	List Price (each)
	LF6115-7JM	234802	4"	1	125	\$4,126.00
	LF6115-74JM					

Pressure Reducing Control Valve w/ 3/4" 223HP Low Flow (flow range: 1 - 580 gpm)

LEAD FREE*	Model	Ordering Code	Size (in.)	Qty Per Carton	Estimated Weight Per Carton (lbs.)	List Price (each)
	LF6115-74JM	234803	4"	1	130	\$4176.00

*The wetted surface of this product contacted by consumable water contains less than 0.25% of lead by weight.

Automatic Control Valves

Model	Ordering Code	Size (in.)	Body	Qty Per Carton	Estimated Weight Per Carton (lbs.)	Iron Body Threaded List Price
-------	---------------	------------	------	----------------	------------------------------------	-------------------------------

ACV116 Globe/1116 Angle Classic Series NPT Threaded Valves

Pressure Reducing Control Valve (20 - 175 psi adjustment range)

LEAD FREE*	Model	Ordering Code	Size (in.)	Body	Qty Per Carton	Estimated Weight Per Carton (lbs.)	Iron Body Threaded List Price
	LFF116 Globe Threaded	T716130	1 1/4"	Ductile Iron w LF Brass Pilot	1	35	\$2,073.00
	LFF116 Globe Threaded	T218203	1 1/2"	Ductile Iron w LF Brass Pilot	1	35	\$2,073.00
	LFF116 Globe Threaded	T218403	2"	Ductile Iron w LF Brass Pilot	1	35	\$2,127.00
	LFF116 Globe Threaded	T218803	2 1/2"	Ductile Iron w LF Brass Pilot	1	70	\$2,580.00
	LFF116 Globe Threaded	2192-03	3"	Ductile Iron w LF Brass Pilot	1	70	\$2,728.00

For Threaded Angle Valves List Price is the Same as Globe Valves - Consult Factory for Ordering Code
Mustang Series List Pricing identical to Classic Series Consult Factory for Ordering Code
Optional 300-450 psi range...add \$1,144.00.

Model	Ordering Code	Size (in.)	Body	Qty Per Carton	Estimated Weight Per Carton (lbs.)	Iron Body 150#FLG List Price	Ordering Code Class 300	Iron Body 300#FLG. List Price
-------	---------------	------------	------	----------------	------------------------------------	------------------------------	-------------------------	-------------------------------

Classic Series Flanged Valves

Pressure Reducing Control Valve (20 - 175 psi adjustment range)

LEAD FREE*	Model	Ordering Code	Size (in.)	Body	Qty Per Carton	Estimated Weight Per Carton (lbs.)	Iron Body 150#FLG List Price	Ordering Code Class 300	Iron Body 300#FLG. List Price
	LFF116 Globe Class 150 Flanged	T852028	1 1/2"	Ductile Iron w LF Brass Pilot	1	35	\$2,443.00	-	-
	LFF116 Globe Class 150 Flanged	T218503	2"	Ductile Iron w LF Brass Pilot	1	35	\$2,478.00	CF*	\$2,889.00
	LFF116 Globe Class 150 Flanged	T218903	2 1/2"	Ductile Iron w LF Brass Pilot	1	70	\$2,616.00	CF*	\$2,994.00
	LFF116 Globe Class 150 Flanged	2193-03	3"	Ductile Iron w LF Brass Pilot	1	70	\$2,862.00	CF*	\$3,156.00
	LFF116 Globe Class 150 Flanged	2196-03	4"	Ductile Iron w LF Brass Pilot	1	120	\$4,119.00	CF*	\$4,163.00
	LFF116 Globe Class 150 Flanged	2198-03	6"	Ductile Iron w LF Brass Pilot	1	220	\$5,797.00	CF*	\$6,121.00
	LFF116 Globe Class 150 Flanged	7039-04	8"	Ductile Iron w LF Brass Pilot	1	425	\$9,474.00	CF*	\$11,065.00

CF* - Consult Factory
For Flanged Angle Valves List Price is the Same as Globe Valves - Consult Factory for Ordering Code
Optional 300-450 psi range...add \$1,144.00.
Mustang Series List Pricing identical to Classic Series Consult Factory for Ordering Code

*The wetted surface of this product contacted by consumable water contains less than 0.25% of lead by weight.
Consult factory for ordering code numbers of special models/options.

Automatic Control Valves

Model	Ordering Code	Size (in.)	Qty Per Carton	Estimated Weight Per Carton (lbs.)	Threaded List Price	Iron Body 150#FLG. List Price	Iron Body 300#FLG. List Price
-------	---------------	------------	----------------	------------------------------------	---------------------	-------------------------------	-------------------------------

ACV116-BTR Globe / 1116-BTR Angle

High Pressure Safety Shutoff Valve (20 - 200 psi adjustment range)

Available in sizes 1 1/4" - 6". Price includes Classic Series Basic Valve with anti-scale trim (Xylan coated seat and stem), Position Indicator, Heavy cover spring, and Manual reset.

Model	Ordering Code	Size (in.)	Qty Per Carton	Estimated Weight Per Carton (lbs.)	Threaded List Price	Iron Body 150#FLG. List Price	Iron Body 300#FLG. List Price
116-BTR/1116-BTR		1 1/4"	1	35	\$2,545.00	-	-
116-BTR/1116-BTR		1 1/2"	1	35	2,621.00	\$2,907.00	-
116-BTR/1116-BTR		2"	1	35	2,824.00	2,941.00	\$3,340.00
116-BTR/1116-BTR		2 1/2"	1	70	3,081.00	3,112.00	\$3,490.00
116-BTR/1116-BTR		3"	1	70	3,237.00	3,363.00	\$3,657.00
116-BTR/1116-BTR		4"	1	120	-	4,640.00	\$4,661.00
116-BTR/1116-BTR		6"	1	220	-	6,203.00	\$6,527.00

Brass Isolation Cocks for valves 1 1/4" - 3" ...add \$217.00. Isolation cocks standard 4" and 6".

Model	Ordering Code	Size (in.)	Qty Per Carton	Estimated Weight Per Carton (lbs.)	Threaded List Price
-------	---------------	------------	----------------	------------------------------------	---------------------

ACV1116FH Angle

Fire Hydrant Relief Valve (20 - 175psi adjustment range)

Available in 2" Threaded, Angle Pattern. Price includes Classic Series Basic Valve attached with 2 1/2" FNST Swivel.

Model	Ordering Code	Size (in.)	Qty Per Carton	Estimated Weight Per Carton (lbs.)	Threaded List Price
1116FH	T030503	2	1	45	2,278.00

*The wetted surface of this product contacted by consumable water contains less than 0.25% of lead by weight.

Consult factory for ordering code numbers of special models/options.

Automatic Control Valves

Model	Ordering Code	Size (in.)	Body	Qty Per Carton	Estimated Weight Per Carton (lbs.)	Threaded List Price
-------	---------------	------------	------	----------------	------------------------------------	---------------------

**ACV115F Globe
Classic Series
NPT Threaded Valves**

Pressure Reducing Valve - UL Listed (VLMT.EX4359)

F115F Globe Threaded	9773-01	3"	Ductile Iron w LF Brass Pilot	1	70	\$2,719.00
----------------------	---------	----	-------------------------------	---	----	------------

For Flanged Angle Valves List Price is the Same as Globe Valves - Consult Factory for Ordering Code

Model	Ordering Code	Size (in.)	Body	Qty Per Carton	Estimated Weight Per Carton (lbs.)	Iron Body 150#FLG. List Price	Ordering Code Class 300	Iron Body 300#FLG. List Price
-------	---------------	------------	------	----------------	------------------------------------	-------------------------------	-------------------------	-------------------------------

**Classic Series
Flanged Valves**

Pressure Reducing Valve - UL Listed (VLMT.EX4359)

F115F Globe Class 150 Flanged	9773-02	3"	Ductile Iron w LF Brass Pilot	1	70	\$2,692.00	9942-02	\$2,986.00
F115F Globe Class 150 Flanged	9775-01	4"	Ductile Iron w LF Brass Pilot	1	120	\$3,886.00	9944-02	\$3,907.00
F115F Globe Class 150 Flanged	9777-01	6"	Ductile Iron w LF Brass Pilot	1	220	\$5,950.00	9946-02	\$6,274.00
F115F Globe Class 150 Flanged	9779-01	8"	Ductile Iron w LF Brass Pilot	1	425	\$9,375.00	-	-

**ACV1115F Angle
Classic Series
Flanged Valves**

Pressure Reducing Valve - UL Listed (VLMT.EX4359)

F1115F Angle Class 150 Flanged	9774-02	3"	Ductile Iron w LF Brass Pilot	1	70	\$2,692.00	9774-06	\$2,986.00
F1115F Angle Class 150 Flanged	9776-01	4"	Ductile Iron w LF Brass Pilot	1	120	\$3,886.00	CF*	\$3,907.00
F1115F Angle Class 150 Flanged	9778-01	6"	Ductile Iron w LF Brass Pilot	1	220	\$5,950.00	CF*	\$6,274.00
F1115F Angle Class 150 Flanged	CF*	8"	Ductile Iron w LF Brass Pilot	1	425	\$9,375.00	-	-

For Fire Protection

*The wetted surface of this product contacted by consumable water contains less than 0.25% of lead by weight.

Consult factory for ordering code numbers of special models/options.

Automatic Control Valves

Model	Ordering Code	Size (in.)	Body	Qty Per Carton	Estimated Weight Per Carton (lbs.)	Iron Body 150#FLG. List Price	Ordering Code Class 300	Iron Body 300#FLG. List Price
-------	---------------	------------	------	----------------	------------------------------------	-------------------------------	-------------------------	-------------------------------

ACV116FM Globe Classic Series Flanged Valves

Fire Pump Relief Valve - UL Listed/FM Approved

F116FM Class 150 Flanged	3652-10	3"	Ductile Iron w LF Brass Pilot	1	70	\$4,284.00	3897-17	\$3,082.00
F116FM Class 150 Flanged	3653-09	4"	Ductile Iron w LF Brass Pilot	1	120	\$5,487.00	4117-09	\$3,876.00
F116FM Class 150 Flanged	5255-08	6"	Ductile Iron w LF Brass Pilot	1	220	\$7,752.00	5805-09	\$8,571.00
F116FM Class 150 Flanged	5369-08	8"	Ductile Iron w LF Brass Pilot	1	425	\$12,331.00	4343-03	\$12,645.00
F116FM Class 300X150 Flanged	CF*	3"	Ductile Iron w LF Brass Pilot	1	70	\$4,741.00	-	-
F116FM Class 300X150 Flanged	CF*	4"	Ductile Iron w LF Brass Pilot	1	120	\$6,233.00	-	-
F116FM Class 300X150 Flanged	8155-10	6"	Ductile Iron w LF Brass Pilot	1	220	\$8,022.00	-	-
F116FM Class 300X150 Flanged	CF*	8"	Ductile Iron w LF Brass Pilot	1	425	\$12,710.00	-	-

CF* - Consult Factory

UL Listed (40-H-1), ULC (CEX757), Factory Mutual Approved (Serial No. 1A2A3.AH) - UL Listed 3", 4", 6", 8" Globe and Angle - FM Approved - 4", 6", 8", Globe and Angle.

ACV116FM Angle Classic Series Flanged Valves

Fire Pump Relief Valve - UL Listed/FM Approved

F116FM Class 150 Flanged	5749-08	3"	Ductile Iron w LF Brass Pilot	1	70	\$4,284.00	6541-04	\$4,721.00
F116FM Class 150 Flanged	5371-07	4"	Ductile Iron w LF Brass Pilot	1	120	\$5,487.00	5435-09	\$6,174.00
F116FM Class 150 Flanged	5372-08	6"	Ductile Iron w LF Brass Pilot	1	220	\$7,752.00	5027-08	\$8,571.00
F116FM Class 150 Flanged	5365-08	8"	Ductile Iron w LF Brass Pilot	1	425	\$12,331.00	6345-08	\$12,645.00
F116FM Class 300X150 Flanged	8261-07	3"	Ductile Iron w LF Brass Pilot	1	70	\$4,741.00	-	-
F116FM Class 300X150 Flanged	6896-08	4"	Ductile Iron w LF Brass Pilot	1	120	\$6,233.00	-	-
F116FM Class 300X150 Flanged	6505-08	6"	Ductile Iron w LF Brass Pilot	1	220	\$8,022.00	-	-
F116FM Class 300X150 Flanged	7961-08	8"	Ductile Iron w LF Brass Pilot	1	425	\$12,710.00	-	-

CF* - Consult Factory

UL Listed (40-H-1), ULC (CEX757), Factory Mutual Approved (Serial No. 1A2A3.AH) - UL Listed 3", 4", 6", 8" Globe and Angle - FM Approved - 4", 6", 8", Globe and Angle.

*The wetted surface of this product contacted by consumable water contains less than 0.25% of lead by weight.

Consult factory for ordering code numbers of special models/options.

Automatic Control Valves

Model	Ordering Code	Size (in.)	Body	Qty Per Carton	Estimated Weight Per Carton (lbs.)	Iron Body 150#FLG. List Price	Ordering Code Class 300	Iron Body 300#FLG. List Price
-------	---------------	------------	------	----------------	------------------------------------	-------------------------------	-------------------------	-------------------------------

ACV116-1FM Globe

Classic Series

Flanged Valves

Fire Pump Suction Control - FM Approved

F116-1FM Class 150 Flanged	3890-08	4"	Ductile Iron w LF Brass Pilot	1	125	\$5,534.00	CF*	\$5,982.00
F116-1FM Class 150 Flanged	5768-08	6"	Ductile Iron w LF Brass Pilot	1	225	8,485.00	9164-03	9,068.00
F116-1FM Class 150 Flanged	5769-08	8"	Ductile Iron w LF Brass Pilot	1	445	12,212.00	CF*	12,504.00

CF* - Consult Factory

Factory Mutual Approved (Approval No. 1C9A6-AH) FM Approved - 4", 6", 8" Globe pattern only.

ACV100D-A Globe

Pneumatic - Hydraulic Deluge Valve - UL Listed

100D-A Class 150 Flanged	CF*	4"	Ductile Iron w LF Brass Pilot	1	120	\$4875.00	CF*	CF*
100D-A Class 150 Flanged	2801-01	6"	Ductile Iron w LF Brass Pilot	1	220	\$6398.00	CF*	CF*
100D-A Class 150 Flanged	CF*	8"	Ductile Iron w LF Brass Pilot	1	440	\$10944.00	CF*	CF*
100D-A Class 150 Flanged	CF*	10"	Ductile Iron w LF Brass Pilot	1	740	\$16426.00	CF*	CF*

CF* - Consult Factory

UL Listed - VLFT.EX4609

ACV100D-B Globe

Electronically Actuated Deluge Valve - UL Listed

100D-B Class 150 Flanged	2742-20	4"	Ductile Iron w LF Brass Pilot	1	120	\$5675.00	CF*	CF*
100D-B Class 150 Flanged	2802-18	6"	Ductile Iron w LF Brass Pilot	1	220	\$6656.00	CF*	CF*
100D-B Class 150 Flanged	2804-18	8"	Ductile Iron w LF Brass Pilot	1	440	\$9359.00	CF*	CF*
100D-B Class 150 Flanged	CF*	10"	Ductile Iron w LF Brass Pilot	1	740	\$17175.00	CF*	CF*

CF* - Consult Factory

UL Listed - VLFT.EX4609

*The wetted surface of this product contacted by consumable water contains less than 0.25% of lead by weight.

Consult factory for ordering code numbers of special models/options.

Automatic Control Valves

ACV Options

Add to List Price of selected valve

Size (In.)	Stainless Steel Trim**	Position Indicator	Single Limit Switch	Dual Limit Switch
1 1/4"	STD	349.00	\$692.00	\$1,148.00
1 1/2"	STD	349.00	692.00	1,148.00
2"	STD	349.00	692.00	1,148.00
2 1/2"	STD	349.00	692.00	1,148.00
3"	STD	349.00	692.00	1,148.00
4"	STD	349.00	692.00	1,148.00
6"	STD	349.00	692.00	1,148.00
8"	STD	412.00	862.00	1,314.00

** Stainless Steel Trim: Main Valve Seat, and Retainer Plate (or Disc Guide). Standard in valve sizes 1 1/4" - 8".

† Sizes 10" – 24" Priced on application.

Consult factory for ordering code numbers of special models or options.



740

High Capacity Water Pressure Relief Valves

Series 740

For Hot Water Space Heating Boiler - ASME RATED - Female inlet NPTF

For Low Pressure Hot Water Heating Boilers - Iron Body - 30psi setting

Model	Ordering Code	Size (in.)	UPC	Qty. Per Carton	Weight Per Carton (lbs.)	List Price (each)
740	0382008	3/4	098268018844	12	20	\$ 171.50
740	0382570	1	098268019087	6	19	298.00
740	0383020	1 1/4	098268019209	6	32	451.50
740	0383542	1 1/2	098268019407	6	40	630.50
740	0384042	2	098268019629	1	16	906.50

Also available in 5psi increments 30 - 75psi, add 10% to list price. Contact factory for ordering codes.

ASME Rated - Water Pressure Relief Valves - For Hot Water Supply Boilers

Series 374 and Series 174A†

For Hot Water Supply Boilers - Bronze body -

Female inlet NPTF - 30psi setting



174A

374A	0358553	3/4	098268018042	25	28	63.25
174A	0274428	3/4	098268013054	25	28	155.00
174A	0274934	1	098268013290	12	23	348.00
174A	0275600	1 1/4	098268013580	6	28	550.50
174A	0276500	1 1/2	098268013894	6	41	761.00
174A	0278030	2	098268014174	1	14	1,100.00

Also available in 5psi increments 30-150psi, add 10% to list price. Contact factory for ordering codes.

† Selected pressure set 174A are available in LeadFree*. Please contact customer service for list price.

740, 374A, 174A Steam Discharge Ratings

Model	Size	30 BTU/Hr.	125 BTU/Hr.	150 BTU/Hr.	Model	Size	30 BTU/Hr.	50 BTU/Hr.	75 BTU/Hr.
374A	3/4"	550,000	-	-	740	3/4" x 1"	925,000	1,352,000	1,886,000
174A	3/4"	650,000	2,070,000	2,445,000	740	1" x 1 1/4"	1,300,000	1,899,000	2,649,000
174A	1"	1,005,000	3,215,000	3,795,000	740	1 1/4" x 1 1/2"	2,105,000	3,075,000	4,285,000
174A	1 1/4"	1,682,000	5,370,000	6,340,000	740	1 1/2" x 2"	2,900,000	4,237,000	5,909,000
174A	1 1/2"	2,020,000	6,460,000	7,630,000	740	2" x 2 1/2"	5,250,000	7,672,000	10,700,000
174A	2"	3,815,000	12,170,000	14,370,000					

*The wetted surface of this product contacted by consumable water contains less than 0.25% of lead by weight.

Consult factory for ordering code numbers of special models/options.

Pressure Relief Valves

Model	Ordering Code	Size (in.)	UPC	Qty. Per Carton	Weight Per Carton (lbs.)	List Price (each)
-------	---------------	------------	-----	-----------------	--------------------------	-------------------

Specialty Relief Valves Series 530 and LF530

Poppet Type - Pressure Relief Valves



530C

LEAD FREE*

530C	0371271	1/2	098268018233	50	21	\$ 66.75
530C	0372271	3/4	098268018240	50	24	71.25
LF530-C	0556035	1/2	098268435191	50	21	92.25
LF530-C	0556036	3/4	098268435207	50	21	98.50
530FP	0371270	1/2	098268221657	50	20	66.75

Model 530C and LF530C 1/2" and 3/4" adjustments are between 50 and 175psi. For 100 – 300psi adjustments, 3/4" only, specify ordering code 0372273.

Model 530FP fire line thermal expansion valve is set at 150psi, adjustable pressure relief range between 50 – 175psi.

Series 53 and LF53

LEAD FREE*

53	0185131	1/2	098268010138	50	19	69.25
53	0185643	3/4	098268010190	50	21	72.25
LF53-75	0121434	1/2	098268584738	50	19	88.75
LF53-75	0121437	3/4	098268584776	50	21	92.00

Model 53 is available in factory preset standard pressure relief settings of 75, 125, and 150psi.

Model LF53 is available in factory preset standard pressure relief settings of 75, 100, and 125psi.

Series 53L, LF53L, 3L and LF3L

Poppet Type - Pressure Relief Valves

LEAD FREE*

53L-075	0189747	1/2	098268010244	50	26	65.75
FP53L-175	0190893	1/2	098268329278	50	26	64.00
3L-075	0011086	3/4	098268001402	50	26	68.25
LF53L-75	0121439	1/2	098268584929	50	26	83.50
LF3L-075	0556032	3/4	098268435160	50	26	87.25
LF3L-125	0556033	3/4	098268435177	50	26	87.25
LF3L-150	0556034	3/4	098268435184	50	25	87.25

**For outside solar applications, specify Model 3L-Z9 with stainless steel lever and pin.

Models 53L, LF53L, 3L, LF3L are available in factory preset standard pressure relief settings of 75, 100, and 125, and 150psi.

Model FP53L fire line thermal expansion valve is UL Listed and available in factory preset standard pressure relief settings of 175, 185, 260, and 310psi.



N30

Series N30 and LFN30

Diaphragm Type - Water Pressure Relief Valves

LEAD FREE*

N30	0109265	1/2	098268009187	25	34	256.50
LFN30	0121397	1/2	098268583892	25	34	341.50

Models N30 and LFN30 adjustable pressure relief range is between 5-30psi.

Bypass Control Valves

Series 5300A, LF5300A, BP30 and LFBP30

For Pumping Equipment - Bronze Body



5300A

LEAD FREE*

5300A	0391600	1/2	098268025699	25	15	120.00
BP30A 10-50	0114039	1/2	098268009347	12	14	269.00
LF5300A	0121627	1/2	098268587814	25	15	165.50
LFBP30 10-50	0121399	1/2	098268584011	12	14	356.50

Models 5300A and LF5300A adjustable pressure relief range is between 0-250psi.

Models BP30 and LFBP30 are available in 10-50psi, 45-100psi and 75-175psi adjustable ranges.

*The wetted surface of this product contacted by consumable water contains less than 0.25% of lead by weight.

Consult factory for ordering code numbers of special models/options.

Temperature & Pressure Relief Valves



40XL,
40XL-8



LF340

PLEASE NOTE: Temperature and pressure safety relief valves constructed of standard materials (non-lead free) are permitted to be used as a component part of a water heater that meets the definition of lead free under Section 1417 of the Safe Drinking Water Act.

Temperature & Pressure Relief Valves

T&P Relief Valves on this page are certified by CSA and meet current F.H.A. requirements and American National Standard Z21.22.

Standard Relief Valve Settings:

Due to excessive costs of producing non-standard "special" settings in small quantities, we find it necessary to limit available pressure relief settings to 75,100,125,150psi. Temperature 210°F.

If "special" settings are necessary for large quantity requirements, we will approve pricing at little or no extra cost, depending on type of valve, setting and quantity. Please consult factory.

Model	Ordering Code	Size (in.)	Thermostat Length (in.)	CSA Temp. Steam BTU/Hr	ASME Pressure Steam Rating BTU/Hr @75psi set pres.	ASME Pressure Steam Rating BTU/Hr @150psi set pres.	UPC	Qty. Per Carton	Per Carton Wgt. (lbs.)	List Price (Each)
		Inlet Outlet								

ASME Self-Closing T&P Relief Valves

Series 40, LL40, LLL40, 140, 240, 340, LF40, LFLL40, LFLLL40, LF140, LF240, LF340

	40L 150/210	0153614	3/4 M	3/4 F	3	180,000	777,600	1,437,600	098268009620	12	20	\$ 243.00
	40XL 150/210	0156731	3/4 M	3/4 F	5	205,000	777,600	1,437,600	098268009767	12	18	236.50
	40XL8 150/210	0158774	3/4 M	3/4 F	8	205,000	777,600	1,437,600	098268009835	12	21	257.50
	LL40XL 150/210	0163801	3/4 M	3/4 F	3 1/2	205,000	777,600	1,437,600	098268921328	12	35	321.00
	LLL40XL 150/210	0163803	3/4 M	3/4 F	5	205,000	777,600	1,437,600	098268921342	12	35	336.00
LEAD FREE*	LF40L 150/210	0121406	3/4 M	3/4 F	3	180,000	777,600	1,437,600	098268584080	12	20	319.50
	LF40L 125/210	0556013	3/4 M	3/4 F	3	180,000	777,600	1,437,600	098268432480	12	35	319.50
	LF40XL 125/210	0556015	3/4 M	3/4 F	5	205,000	777,600	1,437,600	098268432503	12	20	345.00
	LF40XL 150/210	0556016	3/4 M	3/4 F	5	205,000	777,600	1,437,600	098268432510	12	20	310.50
	LF40XL8 150/210	0121421	3/4 M	3/4 F	8	205,000	777,600	1,437,600	098268584516	12	21	339.00
	LFLL40XL 150/210	0121429	3/4 M	3/4 F	3 1/2	205,000	777,600	1,437,600	098268584622	12	35	422.00
	LFLLL40XL 150/210	0121430	3/4 M	3/4 F	5	205,000	777,600	1,437,600	098268584660	12	35	442.00
	140S3 150/210	0254702	3/4 F	3/4 F	3	180,000	777,600	1,437,600	098268012347	12	21	262.50
	140X5 150/210	0257564	3/4 F	3/4 F	5	205,000	777,600	1,437,600	098268012422	12	21	286.00
	140X8 150/210	0259850	3/4 F	3/4 F	8	205,000	777,600	1,437,600	098268012538	12	25	308.00
LEAD FREE*	LF140S3 150/210	0121449	3/4 F	3/4 F	3	180,000	777,600	1,437,600	098268585254	12	21	345.00
	LF140X5 150/210	0121453	3/4 F	3/4 F	5	205,000	777,600	1,437,600	098268585346	12	21	376.50
	LF140X8 150/210	0121459	3/4 F	3/4 F	8	205,000	777,600	1,437,600	098268585445	12	25	405.00
	40L 150/210	0154830	1 M	1 F	2	450,000	1,155,000	2,134,000	098268009675	12	21	391.50
	40XL 150/210	0163725	1 M	1 F	4	500,000	1,155,000	2,134,000	098268009897	12	23	373.50
	40XL7 150/210	0163765	1 M	1 F	7	500,000	1,155,000	2,134,000	098268009989	12	26	412.50
	LL40XL 150/210	0163805	1 M	1 F	3	500,000	1,155,000	2,134,000	098268921366	12	36	584.50
LEAD FREE*	LF40L 150/210	0121409	1 M	1 F	2	450,000	1,155,000	2,134,000	098268584110	12	38	514.00
	LF40XL 100/210	0556006	1 M	1 F	4	450,000	1,155,000	2,134,000	098268432411	12	23	519.50
	LF40XL 125/210	0556007	1 M	1 F	4	500,000	1,155,000	2,134,000	098268432428	12	24	545.00
	LF40XL 150/210	0556008	1 M	1 F	4	500,000	1,155,000	2,134,000	098268432435	12	23	491.00
	LF40XL7 150/210	0121428	1 M	1 F	7	500,000	1,155,000	2,134,000	098268584615	12	26	542.50
	LFLL40XL 150/210	0121431	1 M	1 F	3	500,000	1,155,000	2,134,000	098268584677	12	36	769.00
	140S3 150/210 **	0256661	1 F	1 F	3	570,000	1,670,000	3,085,000	098268012385	6	14	426.00
	140X6 150/210 **	0259705	1 F	1 F	6	670,000	1,670,000	3,085,000	098268012477	12	28	470.00
	140X9 150/210 **	0259930	1 F	1 F	9	670,000	1,670,000	3,085,000	098268012576	12	30	513.50
	N240X-6 150/210**	0315130	1 F	1 F	6	730,000	2,195,000	4,059,000	098268016345	12	35	774.00
	N240X-9 150/210**	0315180	1 F	1 F	9	730,000	2,195,000	4,059,000	098268016383	12	34	870.50
LEAD FREE*	LF140S3 150/210 **	0121451	1 F	1 F	3	570,000	1,670,000	3,085,000	098268585322	6	14	560.50
	LF140X6 150/210 **	0121457	1 F	1 F	6	670,000	1,670,000	3,085,000	098268585384	12	28	617.50
	LF140X9 150/210 **	0121460	1 F	1 F	9	670,000	1,670,000	3,085,000	098268585476	12	30	674.50
	LFN240X 150/210 **	0556019	1 F	1 F	6	730,000	2,195,000	4,059,000	098268432541	12	35	1,099.00
	LFN240X9 150/210 **	0121589	1 F	1 F	9	730,000	2,195,000	4,059,000	098268587227	12	49	1,237.00
	N241X5 150/210 **	0318825	1 1/4 M	1 F	5	730,000	2,195,000	4,059,000	098268016437	12	39	846.00
	N241X8 150/210**	0318861	1 1/4 M	1 F	8	730,000	2,195,000	4,059,000	098268016475	12	44	966.00

*The wetted surface of this product contacted by consumable water contains less than 0.25% of lead by weight.

Consult factory for ordering code numbers of special models/options.

Temperature & Pressure Relief Valves

PLEASE NOTE: Temperature and pressure safety relief valves constructed of standard materials (non-lead free) are permitted to be used as a component part of a water heater that meets the definition of lead free under Section 1417 of the Safe Drinking Water Act.

Model	Ordering Code	Size (in.)		Thermostat Length (in.)	CSA Temp. Steam BTU/Hr	ASME Pressure Steam Rating BTU/Hr @75psi set pres.	ASME Pressure Steam Rating BTU/Hr @150psi set pres.	UPC	Qty. Per Carton	Per Carton Wgt. (lbs.)	List Price (Each)
		Inlet	Outlet								

ASME Self-Closing T&P Relief Valves (cont.)

Series 40, LL40, LLL40, 140, 240, 340, LF40, LFLL40, LFLLL40, LF140, LF240, LF340

Model	Ordering Code	Inlet Size (in.)	Outlet Size (in.)	Thermostat Length (in.)	CSA Temp. Steam BTU/Hr	ASME Pressure Steam Rating BTU/Hr @75psi set pres.	ASME Pressure Steam Rating BTU/Hr @150psi set pres.	UPC	Qty. Per Carton	Per Carton Wgt. (lbs.)	List Price (Each)
LFN241X5 150/210 **	0121592	1 1/4 M	1 F	5	730,000	2,195,000	4,059,000	098268587258	12	39	1,202.00
LFN241X8 150/210 **	0121595	1 1/4 M	1 F	8	730,000	2,195,000	4,059,000	098268587302	12	44	1,372.00
340 150/210 **	0344276	1 1/2 F	1 1/2 F	3	1,150,000	3,450,000	6,379,000	098268017571	6	44	1,619.00
340X8 150/210 **	0348470	1 1/2 F	1 1/2 F	8	1,150,000	5,403,000	6,379,000	098268017625	6	39	1,721.00
LF340 150/210 **	0121602	1 1/2 F	1 1/2 F	3	1,150,000	3,450,000	6,379,000	098268587487	6	44	2,297.00
LF340X8 150/210 **	0121605	1 1/2 F	1 1/2 F	8	1,150,000	5,403,000	6,379,000	098268587517	6	39	2,440.00
342-3 150/210 **	0352478	2 M	1 1/2 F	3	1,150,000	3,450,000	6,379,000	098268017663	6	40	1,767.00
342X-8 150/210 **	0352620	2M	1 1/2 F	8	1,150,000	3,450,000	6,379,000	098268017700	6	37	1,875.00
LF342 150/210 **	0121608	2 M	1 1/2 F	3	1,150,000	3,450,000	6,379,000	098268587548	6	40	2,508.00
LF342X8 150/210 **	0121610	2M	1 1/2 F	8	1,150,000	3,450,000	6,379,000	098268587586	6	37	2,660.00

340X-8 M4Z, Temperature Relief 210°F, 175psi, Certified CSA only, Ordering code 0348475 List Price \$2065.00.

**Standardly furnished with stainless steel thermostat tube.

Model	Ordering Code	Size (in.)	Thermostat Length (in.)	CSA Temp. Steam BTU/Hr	UPC	Qty. Per Carton	Weight Per Carton (lbs.)	List Price (each)
-------	---------------	------------	-------------------------	------------------------	-----	-----------------	--------------------------	-------------------

Standard Self-Closing T&P Relief Valves - Series LF1L, LF1XL

Thermo-bonded (non-metallic) protective coating on thermostat

1L-2 150/210	0002268	1/2	2	15,000	098268000313	50	32	\$ 31.75
1XL-4 150/210	0004494	1/2	4	15,000	098268000429	25	17	30.25
1XL-8 150/210	0004497	1/2	8	15,000	098268000443	25	20	32.00
LF1L-2 150/210	0121321	1/2	2	15,000	098268582918	50	32	41.75
LF1XL-4 150/210	0121325	1/2	4	15,000	098268582956	25	17	39.75
LF1XL-8 150/210	0121326	1/2	8	15,000	098268582963	25	20	42.00

Available in factory preset standard pressure relief settings of 75, 100, and 125, and 150psi. Consult factory for ordering codes.



LF100XL

ASME Self-Closing T&P Relief Valves

Series LF10L, LF100XL

Thermo-bonded (non-metallic) protective coating on thermostat

10L-2 150/210	0064014	3/4	2	80,000	098268006988	50	35	31.75
100XL-4 150/210	0066100	3/4	4	105,000	098268000016	50	37	19.00
100XL-8 150/210	0066110	3/4	8	105,000	098268007237	50	40	21.00
SL100XL 150/210	0066445	3/4		105,000	098268739770	50	41	35.75
L100XL-3 150/210	0066133	3/4		105,000	098268214673	50	41	34.75
LL100XL-2 1/2 150/210	0066132	3/4	2 1/2	105,000	098268214666	50	41	37.00
LLL100XLZ5 150/210	0066446	3/4		105,000	098268739787	50	46	39.75
LF10L-2 150/210	0121339	3/4	2	80,000	098268006988	50	35	41.75
LF100XL-4 150/210	0556000	3/4	4	105,000	098268000016	50	37	25.00
LF100XL-8 150/210	0556001	3/4	8	105,000	098268007237	50	40	28.00
LFSL100XL 150/210	0068720	3/4		105,000	098268739770	50	41	47.00
LFL100XL-3 150/210	0556003	3/4		105,000	098268214673	50	41	46.00
LFLL100XL-2 1/2 150/210	0556002	3/4	2 1/2	105,000	098268214666	50	41	48.75
LFLLL100XLZ5 150/210	0556004	3/4		105,000	098268739787	50	46	52.50

OPTION: SOLAR - Model 100XL/1XL, specify Suffix Z9 stainless steel lever and pin for outside solar applications. Net price \$1.70 extra. Suffix Z11 for 180°F thermostat. Net price \$2.00 extra. Consult factory for additional pressure settings and ordering codes.

*The wetted surface of this product contacted by consumable water contains less than 0.25% of lead by weight.

Consult factory for ordering code numbers of special models/options.

Model	Ordering Code	Size (in.)	Thermostat Length (in.)	CSA Temp. Steam BTU/Hr	UPC	Qty. Per Carton	Weight Per Carton (lbs.)	List Price (each)
-------	---------------	------------	-------------------------	------------------------	-----	-----------------	--------------------------	-------------------

Temperature Gas Shutoff Valves

Series LF210

Design Certified to ANSI Z21.87 - Automatic Gas Shutoff devices for hot water supply systems

210M2-5	0295395	3/4 X 1/2	5	150,000 (Natural Gas) 243,000 (LP Gas)	098268014891	25	28	231.50
L210M2-5	0295396	3/4 X 1/2	5	150,000 (Natural Gas) 243,000 (LP Gas)	098268288094	25	28	259.00
LL210M2-5	0295397	3/4 X 1/2	5	150,000 (Natural Gas) 243,000 (LP Gas)	098268288100	25	29	268.00
LLL210M2-5	0295398	3/4 X 1/2	5	150,000 (Natural Gas) 243,000 (LP Gas)	098268288117	25	29	289.50
LF210M2-5	0556025	3/4 X 1/2	5	150,000 (Natural Gas) 243,000 (LP Gas)	098268432602	25	28	330.00
LFL210M2-5	0556026	3/4 X 1/2	5	150,000 (Natural Gas) 243,000 (LP Gas)	098268432619	25	28	368.00
LFLL210M2-5	0556027	3/4 X 1/2	5	150,000 (Natural Gas) 243,000 (LP Gas)	098268432626	25	29	381.50
LFLLL210M2-5	0295399	3/4 X 1/2	5	150,000 (Natural Gas) 243,000 (LP Gas)	098268457308	25	29	412.00

LEAD FREE*

Model	Ordering Code	Size (in.)	UPC	Qty. Per Carton	Weight Per Carton (lbs.)	List Price (each)
-------	---------------	------------	-----	-----------------	--------------------------	-------------------



315-M2

Steam Safety Valves - ASME Section IV

Series 315 and Series 415

For Low Pressure Steam Heating Boilers Furnished with special Teflon® disc. (Set at 15psi)

315-M2	0342629	3/4 x 3/4	098268792034	50	25	\$ 94.25
415-M1	0346045	3/4 x 3/4	098268609332	25	19	161.00
415-M1	0346044	1 x 1	098268699203	24	28	195.00
415	0364195	1 1/4 x 1 1/2	098268903034	6	16	272.50
415	0364200	1 1/2 x 2	098268903041	6	24	312.00

Steam Safety Valves - ASME VIII - Handling Saturated Steam to 250psi

Series Figure 41

Bronze Body

Ordering Code	Inlet	Valve Size (In.) Orifice	Outlet	Pipe Connection NPT X Outlet	UPC	Qty. Per Carton	Weight Per Carton (lbs.)	List Price (each)
0390700	1/2	0.1188	3/4	NPT x NPT	098268869026	1	3.0	\$ 797.50
0390701	3/4	0.1188	3/4	NPT x NPT	098268869033	1	3.0	830.00
0390702	3/4	0.2116	1	NPT x NPT	098268869040	1	13	893.50
0390703	1	0.2116	1	NPT x NPT	098268869057	1	3.5	947.50
0390704	1	0.3318	1 1/4	NPT x NPT	098268869064	1	6.0	1,020.00
0390705	1 1/4	0.3318	1 1/4	NPT x NPT	098268869071	1	6.0	1,147.00
0390706	1 1/4	0.5424	1 1/2	NPT x NPT	098268869088	1	7.0	1,326.00
0390707	1 1/2	0.5424	1 1/2	NPT x NPT	098268869095	1	7.3	1,392.00
0390708	1 1/2	0.8479	2	NPT x NPT	098268869101	1	11	1,591.00
0390709	2	0.8479	2	NPT x NPT	098268869118	1	14	2,058.00
0390710	2	1.391	2 1/2	NPT x NPT	098268869125	1	18	2,206.00
0390711	2 1/2	1.391	2 1/2	NPT x NPT	098268869132	1	18	2,873.00

Cast Iron Body

0390714	2	1.391	3	250 FLG x NPT	098268869163	1	42	5,651.00
0390715	2	1.892	3	250 FLG x NPT	098268869170	1	42	6,476.00
0390717	2 1/2	1.892	3	250 FLG x NPT	098268869194	1	45	7,895.00



Figure 41
Bronze



Figure 41
Cast Iron

*The wetted surface of this product contacted by consumable water contains less than 0.25% of lead by weight.

Consult factory for ordering code numbers of special models/options.

Water Heater Installation Products



LFN36

Model	Ordering Code	Size (in.)	UPC	Qty. Per Carton	Weight Per Carton (lbs.)	List Price (each)
-------	---------------	------------	-----	-----------------	--------------------------	-------------------

Vacuum Relief Valves - CSA/ANSI Z21.22 - Series LFN36M1

Water and Steam Service

LEAD FREE	LFN36M1	0556030	1/2	098268450408	24	5.5	\$ 57.50
	LFN36M1	0556031	3/4	098268450415	24	6.0	72.00

Drain Line For T&P Relief Valves - Series 100DT, 100DT-A60

For use on water heaters up to 100,000 BTU/Hr



100DT

		Conn. Size	Drop Length				
100DT	0066125	3/4	48	098268007329	75	21	\$ 8.25
100DT-A60	0066129	3/4	60	098268026665	12	23	53.50
100DT-A60-12	0066060	3/4	60	098268902006	12	24	60.25

Model	Ordering Code	Size (in.)	UPC	Qty. Per Carton	Weight Per Carton (lbs.)	List Price (each)
-------	---------------	------------	-----	-----------------	--------------------------	-------------------

Potable Water Expansion Tanks Series PLT

Max. temp. 160° - Max. pressure 150psi - Precharge 20psi



PLT-12

LEAD FREE	PLT-5	†0067370	-	098268095739	1	5.4	\$ 66.75
	PLT-12	†0067371	-	098268095753	1	9.1	94.75
	PLT-20	0067372	-	098268483161	1	15	188.00
	PLT-35	0067373	-	098268483178	1	27	232.50

Available in pallet quantities (PLT-5, 180), (PLT-12, 70)

ASME Pressurized Expansion Tanks For Potable Hot Water Series DETA



DETA

LEAD FREE	DETA-5	0212026	-	098268913484	1	23	1,333.00
	DETA-12	0212027	-	098268913491	1	27	1,534.00
	DETA-20	0212028	-	098268913507	1	40	1,706.00
	DETA-30	0212029	-	098268913514	1	68	1,924.00
	DETA-42	0212030	-	098268913521	1	81	2,056.00
	DETA-60	0212031	-	098268913538	1	93	2,503.00
	DETA-80	0212032	-	098268913545	1	108	2,656.00
	DETA-100	0212033	-	098268913552	1	148	3,004.00
	DETA-125	0212034	-	098268913569	1	174	3,352.00
	DETA-160	0212035	-	098268913576	1	258	3,701.00
	DETA-180	0212036	-	098268913583	1	269	4,047.00
DETA-210	0212037	-	098268913590	1	282	4,249.00	

*The wetted surface of this product contacted by consumable water contains less than 0.25% of lead by weight.

Consult factory for ordering code numbers of special models/options.

Water Heater Installation Products

3

Water Heater Installation Products

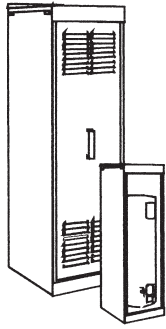

Outside Water Heater Enclosure

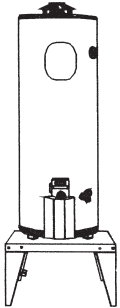

Water Heater Stand

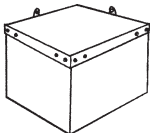

ENS-20



Free Standing Water Heater Restraint System



Wall Mounted Water Heater Stand/Restraint

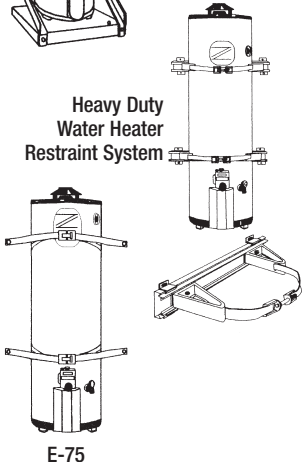

Heavy Duty Water Heater Restraint System

E-75

Model	Ordering Code	Size (in.)	UPC	Qty. Per Carton	Weight Per Carton (lbs.)	List Price (each)
-------	---------------	------------	-----	-----------------	--------------------------	-------------------

Outside Water Heater Enclosures

R-24BL	0070001	24" square x 72 1/2" tall	098268928327	1	37	\$ 276.00
R-26BL	0070002	26" wide x 24" deep x 72 1/2" tall	098268928334	1	47	349.00
R-30BL	0070004	30" square x 72 1/2" tall 80 gal. capacity	098268928358	1	48	381.50
C-36 Com	0070005	36" square x 72 1/2" tall 100 gal. capacity	098268928365	1	94	854.00
WPE-24	0070006	24" cabinet w/o venting or louvers	098268928372	1	30	308.00
B-24	0070007	24" back section for R-24 BL enclosures	098268928389	1	15	132.00
B-26	0070008	26" back section for R-26 enclosures	098268928396	1	13	154.00
B-30	0070009	30" back section for R-30 BL enclosures	098268928402	1	19	164.50
B-36	0070010	36" back section for C-36 Com enclosures	098268928419	1	29	208.50
B-24 WPE	0070011	back sections for WPE-24	098268928426	1	10	146.50

Water Heater Stands

AS-20 ♦	0070012	20" X 20" X 16" 50 gal. capacity	098268928433	1	12	94.50
AS-22 ♦	0070014	22" x 22" x 16" 65 gal. capacity	098268928457	1	14	126.00
AS-26 ♦	0070016	26" x 26" x 16" 75 gal. capacity	098268928471	1	21	193.00
AS-30	0070018	30" x 30" x 16" 100 gal. capacity	098268928495	1	24	224.00

♦Pallet quantity AS-20 @ 40 pcs., AS-22 @ 20 pcs., AS-26 @ 20 pcs.

ENS-20 Water Heater Stands - enclosed for use in food processing areas

ENS-20	0070021	16" tall	098268928525	4	80	143.50
--------	---------	----------	--------------	---	----	--------

Free Standing Water Heater Restraint Systems - Heavy duty angle iron frame

FS-26	0070022	26" square up to 65 gallon water heaters	098268928532	1	75	611.00
FS-36	0070023	36" square up to 120 gallon water heaters	098268928549	1	80	648.50

Wall Mounted Water Heater Stands / Restraint - includes a E-100 restraint

WM-26	0070024	26" square up to 65 gallon water heaters	098268928556	1	42	430.00
WM-30	0070025	30" square up to 120 gallon water heaters	098268928563	1	45	492.50

Heavy Duty Water Heater Restraint Systems - endorsed by GLAA-PHCC - double strapping system

E-50	0070026	up to 65 gallon water heaters	098268928570	8	60	84.50
E-100	0070028	up to 100 gallon water heaters	098268928594	3	44	199.50

TSE-75 Water Heater Straps - across the front installation for zero clearance water heaters

TSE-75	0070029	-	098268928600	12	32	19.00
TSE-75P plastic	0070030	-	098268928617	12	31	20.50

E-75 Water Heater Straps - across the front or wrap around installation

E-75	0070031	-	098268928624	12	43	24.50
E-120	0070032	-	098268928631	12	60	37.75

*The wetted surface of this product contacted by consumable water contains less than 0.25% of lead by weight.

Consult factory for ordering code numbers of special models/options.

Water Heater Installation Products

Model	Ordering Code	Size (in.)	UPC	Qty. Per Carton	Weight Per Carton (lbs.)	List Price (each)
-------	---------------	------------	-----	-----------------	--------------------------	-------------------

Water Detector Shutoffs Series WDS and LFWDS



LFWDS

Complete Valves

LEAD FREE*	LFWDS-SP-L	0121577	3/4	098268587029	1	5.3	\$ 446.00
	LFWDS-SP-R	0121578	3/4	098268587050	1	5.3	446.00
	LFWDS-SI	0121579	3/4	098268587067	1	5.2	427.50
	LFWDS-E220	0121580	3/4	098268587074	1	7.0	515.00
	LFWDS-SP-L	0301015	1	098268460056	1	5.5	472.00
	LFWDS-SP-R	0121581	1	098268587081	1	5.5	472.00
	LFWDS-SI	0301017	1	098268460070	1	5.4	452.00
	LFWDS-E220	0121582	1	098268587098	1	7.2	539.50

Components

WDS- L Therm.	0301009		098268356236	12	3.2	71.00
WDS- R Therm.	0301010		098268356243	12	3.2	71.00

Tankless Water Heater Valves Series LFTWH



LFTWH-UT-HC



LFTWH-FS-HCN-RV

LEAD FREE*	LFTWH-UT-HC-RV	0120001	3/4	098268442854	5	25	246.50
	LFTWH-UT-HCN-RV	0125110	3/4	098268849035	5	28	245.50
	LFTWH-FT-HCN	0100155	3/4	098268483475	5	19	126.00
	LFTWH-UTS-HCN	0120002	3/4	098268454758	5	26	169.00
	LFTWH-FT-HCN-RV	0100156	3/4	098268483482	5	22	167.00
	LFTWH-UTS-HCN-RV	0120003	3/4	098268454765	5	28	169.00
	LFTWH-QC-HCN-RV	0120005	3/4	098268454789	5	28	229.00
	LFTWH-UTS-HCN Valve Set	0100165	1	098268548952	5	29	215.50
	LFTWH-FS-HCN	0120007	3/4	098268542523	5	19	207.00
	LFTWH-FS-HCN-RV	0120006	3/4	098268542516	5	22	267.50
	LFTWH-UTS-HCN-RV	0100164	1	098268548945	4	30	486.00

*The wetted surface of this product contacted by consumable water contains less than 0.25% of lead by weight.
Consult factory for ordering code numbers of special models/options.

Model	Ordering Code	Size (in.)	UPC	Qty. Per Carton	Weight Per Carton (lbs.)	List Price (each)
-------	---------------	------------	-----	-----------------	--------------------------	-------------------

Hose Connection Atmospheric Vacuum Breaker Series 8/LF8



8A



8FR

LEAD FREE*

		Inlet	Outlet			
	8	3/4 f	3/4 m	098268308006	72	23 \$ 30.50
	8P	3/4 f	3/4 m	098268004137	72	6.6 10.50
	8B	3/4 f	3/4 m	098268308020	72	23 16.50
	8BC	3/4 f	3/4 m	098268307993	72	23 41.75
	8C	3/4 f	3/4 m	098268307986	72	23 42.75
	8A	3/4 f	3/4 m	098268004212	72	22 39.50
	8AC	3/4 f	3/4 m	098268006681	72	22 57.00
	8FR	3/4 f	3/4 m	098268920413	50	26 47.50
LEAD FREE*	LF8	3/4 f	3/4 m	098268434729	72	19 38.25
	LF8B	3/4 f	3/4 m	098268434736	72	19 21.00
	LF8BC	3/4 f	3/4 m	098268434774	72	19 52.50
	LF8C	3/4 f	3/4 m	098268434743	72	19 53.75
	LF8A	3/4 f	3/4 m	098268434781	72	22 49.25
	LF8AC	3/4 f	3/4 m	098268434798	72	22 72.00
	LF8FR	3/4 f	3/4 m	098268434811	50	23 59.50

Series 8:

Suffix - Options

- A - Patented "Non-Removable" feature
- B - Furnished with break-away set screw
- P - Patented "Non-Removable" feature. Constructed of durable, corrosion-resistant, reinforced thermoplastic
- C - Chrome Plated
- FR -With freeze relief feature

Series NF8/LFNFB

With Manual Draining For Freezing Conditions

LEAD FREE*

NF8	0061854	3/4 f	3/4 m	098268004007	50	17 40.00
NF8C	0061855	3/4 f	3/4 m	098268004014	50	30 54.50
LFNFB	0792093	3/4 f	3/4 m	098268434804	50	17 50.25

For Tub and Shower Hand Spray Sets

S8	0061853	1/2 f	1/2 m	098268003994	50	12 66.50
S8C	0061852	1/2 f	1/2 m	098268003987	50	12 75.25
S8C	0061867	3/8 f	1/2 m	098268004120	50	13 69.25

Series TWS

Through The Wall Shutoff For Use With PVB, DC and RP - Key Operated



TWS

		Size	Length			
TWS-8	0722050	3/4	8	098268611977	4	32 499.50
TWS-10	0722051	3/4	10	098268611984	4	31 560.50
TWS-12	0722052	3/4	12	098268611991	4	34 605.00
TWS-8	0722045	1	8	098268569278	4	31 499.50
TWS-10	0722046	1	10	098268569285	4	33 560.50
TWS-12	0722047	1	12	098268569292	4	35 605.00

Series LFNLF9

Lab Faucet Vacuum Breaker - Chrome Finish

LEAD FREE*

LFNLF9	0792095	3/8 m	3/8 f	098268434828	50	21 107.50
--------	---------	-------	-------	--------------	----	-----------

Series LFN9CD

Field Testable, Hose Connection Backflow Preventer

LEAD FREE*

LFN9CD	0792099	3/4 f	3/4 m	098268434866	50	28 157.50
--------	---------	-------	-------	--------------	----	-----------

Series LFN9

In-Line, Continuous Pressure Backflow Preventer

LEAD FREE*

LFN9	0792096	1/4 f	1/4 f	098268434835	50	25 157.50
LFN9	0792097	3/8 f	3/8 f	098268434842	50	23 157.50
LFN9C	0122584	1/4 f	1/4 f	098268638578	50	35 173.50
LFN9C	0792098	3/8 f	3/8 f	098268434859	50	23 173.50

C = Chrome plated

Series 9BD

Vented Triple Check - For Carbonated Beverage Vending Machines

LEAD FREE*

9BD	0061894	3/8 Flare	3/8 Flare	098268004328	50	20 375.50
9BD	0061911	1/4 NPT	1/4 NPT	098268004496	50	35 375.50
9BD	0061913	3/8 NPT	3/8 NPT	098268004519	50	22 375.50

*The wetted surface of this product contacted by consumable water contains less than 0.25% of lead by weight.

Consult factory for ordering code numbers of special models/options.

Vacuum Breakers



9D

Series 9D

Dual Check With Atmospheric Port

		Inlet	Outlet				
9D M3	0061935	1/2 f	1/2 f	098268221794	12	15	\$ 98.50
9DS M3 ♦	0061952	1/2 f	1/2 f	098268290417	12	14	98.50
9D M2	0061888	3/4 f	3/4 f	098268004281	12	19	100.50
9DS M2 ♦	0061926	3/4 f	3/4 f	098268195347	12	18	100.50

♦ Solder Ends Satin chrome models available, specify Suffix SC



912HP

Series 912HP

High Pressure Hose Drop Backflow Preventer

912HP	0386447	3/4	Bronze	098268873306	6	19	490.00
912HP	0386448	1	Bronze	098268873313	6	22	608.50



SD2

Series SD2

Stainless Steel Dual Check For Carbonated Beverage Machines

LEAD FREE*							
SD2-MF	0061651	1/4 Flare	1/4 Flare	098268848892	50	18	128.00
SD2-MF	0061655	3/8 Flare	3/8 Flare	098268848939	50	18	136.00



SD3

Series SD3

Stainless Steel Vented Dual Check For Carbonated Beverage Machines

LEAD FREE*							
SD3-MF	0061653	1/4 Flare	1/4 Flare	098268848915	25	8.8	295.50
SD3-MF	0061657	3/8 Flare	3/8 Flare	098268848953	25	8.8	295.50

Model	Ordering Code	Size (in.)	UPC	Qty. Per Carton	Weight Per Carton (lbs.)	List Price (each)
-------	---------------	------------	-----	-----------------	--------------------------	-------------------

Toilet Fill Valve and Thermal Expansion Relief Valve

Series Gov80M2

Gov80M2-ADJ	0146040	8 3/4 - 12 3/4	042805489024	6	4.8	\$ 36.75
-------------	---------	----------------	--------------	---	-----	----------



Gov80M2

Irrigation Vacuum Breakers

Series 188A

Brass Body

188A	0340971	3/4	098268209808	24	18	90.50
188A	0340972	1	098268209815	24	20	117.00
188A	0340973	1 1/4	098268209822	12	25	161.00
188A	0340974	1 1/2	098268209839	6	20	291.00
188A	0340975	2	098268209846	6	29	453.00

Anti-Siphon Vacuum Breakers

Series LF288A

LEAD FREE*						
LF288A	0792036	1/4	098268434224	50	20	86.25
LF288A	0792037	3/8	098268434231	50	16	86.25
LF288A	0792038	1/2	098268434248	50	26	97.25
LF288A	0792039	3/4	098268434255	24	18	116.00
LF288AM4	0792040	1	098268434262	24	24	180.00
LF288AM2	0792041	1 1/4	098268434279	12	12	315.00
LF288AM2	0792042	1 1/2	098268434286	6	11	369.50
LF288AM2	0792043	2	098268434293	6	29	575.00
LF288AM2	0792044	2 1/2	098268434309	1	12	1,652.00
LF288AM2	0122748	3	098268646245	1	15	2,193.00



LF288A

*The wetted surface of this product contacted by consumable water contains less than 0.25% of lead by weight.

Consult factory for ordering code numbers of special models/options.

Pressure Vacuum Breakers

Model	Ordering Code	Size (in.)	UPC	Qty. Per Carton	Weight Per Carton (lbs.)	List Price (each)
-------	---------------	------------	-----	-----------------	--------------------------	-------------------

Anti-Siphon Vacuum Breakers (cont.)

Series LF288A

Polished Chrome Plated Body

LEAD FREE*	Model	Ordering Code	Size (in.)	UPC	Qty. Per Carton	Weight Per Carton (lbs.)	List Price (each)
	LF288AC	0792051	1/4	098268434378	50	19	\$ 130.00
	LF288AC	0792053	3/8	098268434408	50	17	130.00
	LF288AC	0792052	1/2	098268434385	50	24	145.00
	LF288AC	0792054	3/4	098268434415	24	17	168.50
	LF288ACM4	0792055	1	098268434422	24	22	287.00

Spill-Resistant Atmospheric Vacuum Breakers

Series LF289

LEAD FREE*	Model	Ordering Code	Size (in.)	UPC	Qty. Per Carton	Weight Per Carton (lbs.)	List Price (each)
	LF289	0792047	1/2	098268434330	24	28	200.00
	LF289	0792048	3/4	098268434347	1	3.4	388.00



LF289



LFN388

Series LFN388

With Bottom Inlet and Outlet Connections

LEAD FREE*	Model	Ordering Code	Size (in.)	UPC	Qty. Per Carton	Weight Per Carton (lbs.)	List Price (each)
	LFN388	0792062	1/4	098268434491	50	23	74.75
	LFN388	0792064	3/8	098268434514	50	40	86.75

Polished Chrome Plated Body

LEAD FREE*	Model	Ordering Code	Size (in.)	UPC	Qty. Per Carton	Weight Per Carton (lbs.)	List Price (each)
	LFN388-C	0792061	1/4	098268434484	50	10	114.50
	LFN388-C	0792065	3/8	098268434521	50	24	154.50

Satin chrome models available, specify Suffix SC.

Pressure Vacuum Breakers

Series 800M4QT and LF800M4QT

With Quarter-Turn Shutoffs

Model	Ordering Code	Size (in.)	UPC	Qty. Per Carton	Weight Per Carton (lbs.)	List Price (each)	
800M4QT	0387096	1/2	098268279351	1	4.3	201.50	
800M4QT	0388001	3/4	098268279375	1	4.0	201.50	
800M4QT	0388002	1	098268279399	1	7.0	207.50	
800M4QT	0387126	1 1/4	098268235951	1	11	408.00	
800M4QT	0387114	1 1/2	098268208894	1	13	503.50	
800M4QT	0387122	2	098268208931	1	17	519.00	
LEAD FREE*	LF800M4-QT	0792010	1/2	098268433807	1	3.8	251.50
	LF800M4-QT	0792011	3/4	098268433814	1	4.1	251.50
	LF800M4-QT	0792012	1	098268433821	1	6.1	259.50
	LF800M4-QT	0792013	1 1/4	098268433838	1	11	510.50
	LF800M4-QT	0792014	1 1/2	098268433869	1	13	629.50
	LF800M4-QT	0792015	2	098268433876	1	17	648.50



800M4QT

With Union Connections and Quarter-Turn Shutoffs

Model	Ordering Code	Size (in.)	UPC	Qty. Per Carton	Weight Per Carton (lbs.)	List Price (each)
U800M4-QT	0388005	3/4	098268300833	1	5.1	231.00
U800M4-QT	0388006	1	098268300840	1	7.3	239.00

With Stainless Steel Handles

Model	Ordering Code	Size (in.)	UPC	Qty. Per Carton	Weight Per Carton (lbs.)	List Price (each)
800M4-QT-SH	0388100	1/2	098268875409	1	4.0	230.00
800M4-QT-SH	0388101	3/4	098268875416	1	4.1	230.00
800M4-QT-SH	0388102	1	098268875423	1	6.0	238.00
800M4-QT-SH	0388103	1 1/4	098268875430	1	11	473.50
800M4-QT-SH	0388104	1 1/2	098268875447	1	14	570.50
800M4-QT-SH	0388105	2	098268875454	1	18	587.50



800M4QT SH

*The wetted surface of this product contacted by consumable water contains less than 0.25% of lead by weight.

Consult factory for ordering code numbers of special models/options.

Backflow Preventers

4

Backflow Preventers & Accessories



800M4FR

Model	Ordering Code	Size (in.)	UPC	Qty. Per Carton	Weight Per Carton (lbs.)	List Price (each)
-------	---------------	------------	-----	-----------------	--------------------------	-------------------

Freeze Protection Pressure Vacuum Breakers - Series 800M4FR and LF800M4FR

Designed to be left out in the cold.

	800M4FR	0388013	1/2	098268823578	1	4.5	\$ 220.50
	800M4FR	0388014	3/4	098268823585	1	4.8	220.50
	800M4FR	0388015	1	098268597059	1	6.0	224.00
	800M4FR	0388016	1 1/4	098268798647	1	11	452.50
	800M4FR	0388017	1 1/2	098268798654	1	13	557.50
	800M4FR	0388018	2	098268798661	1	17	575.00
LEAD FREE*	LF800M4-FR	0792016	1/2	098268433883	1	4.5	276.00
	LF800M4-FR	0792017	3/4	098268433890	1	4.1	276.00
	LF800M4-FR	0792018	1	098268433906	1	6.0	279.50
	LF800M4-FR	0792019	1 1/4	098268433920	1	11	565.00
	LF800M4-FR	0792020	1 1/2	098268433937	1	13	696.50
	LF800M4-FR	0792021	2	098268433944	1	17	719.00

With Stainless Steel Handles

	800M4FR SH	0388120	1/2	098268876437	1	4.0	250.00
	800M4FR SH	0388121	3/4	098268876444	1	4.0	250.00
	800M4FR SH	0388122	1	098268876451	1	6.2	253.50
	800M4FR SH	0388123	1 1/4	098268876468	1	11	517.50
	800M4FR SH	0388124	1 1/2	098268876475	1	13	626.00
	800M4FR SH	0388125	2	098268876482	1	18	644.50

With Union Connections and Quarter-Turn Shutoffs

	U800M4FR	0388007	3/4	098268349313	1	4.1	224.00
	U800M4FR	0388008	1	098268349320	1	10	233.50



LF008PCQT

Spill-Resistant, Anti-Siphon Vacuum Breakers Series LF008PCQT

With Polymer Coating

LEAD FREE*	LF008PCQT	0792023	3/8	098268434064	4	3.6	515.00
	LF008PCQT	0792024	1/2	098268434071	4	1.9	515.00
	LF008PCQT	0792025	3/4	098268434088	1	4.7	651.00
	LF008PCQT	0792026	1	098268434095	1	6.0	719.00

With Satin Chrome Finish

LEAD FREE*	LF008PCQT-SC	0792027	3/8	098268434101	4	3.6	1,127.00
	LF008PCQT-SC	0792028	1/2	098268434118	4	7.4	1,127.00
	LF008PCQT-SC	0792029	3/4	098268434125	1	0.75	1,673.00
	LF008PCQT-SC	0792030	1	098268434132	1	6.0	1,905.00

*The wetted surface of this product contacted by consumable water contains less than 0.25% of lead by weight.

Consult factory for ordering code numbers of special models/options.

Backflow Preventers

Model	Ordering Code	Size (in.)	UPC	Qty. Per Carton	Weight Per Carton (lbs.)	List Price (each)
-------	---------------	------------	-----	-----------------	--------------------------	-------------------

Dual Check Valves

Series LFH7

LEAD FREE*	Model	Ordering Code	Size Inlet	Size Outlet	UPC	Qty. Per Carton	Weight Per Carton (lbs.)	List Price (each)
			Hose Connection					
	LFH7	0122586			098268638615	25	23	\$ 205.50
	LFH7C	0792078			098268434651	25	23	218.50

Suffix C – Chrome plated

Series LF7R



LF7R

LEAD FREE*	Model	Ordering Code	Size Inlet	Size Outlet	UPC	Qty. Per Carton	Weight Per Carton (lbs.)	List Price (each)
			Hose Connection					
	LF7RU2-2	0072203	1/2	1/2	098268533576	25	19	56.25
	LF7RU2-2	0072204	3/4	3/4	098268533583	25	19	60.75
	LF7RU2-2	0072205	1	1	098268533590	25	20	66.75
	LF7RU2-U2	0072206	1/2	1/2	098268533606	25	24	69.25
	LF7R10-U2	0072207	1	3/4	098268533613	25	23	68.50
	LF7R10-U3	0072208	1	4	098268533620	25	23	81.75

Residential Fire Line Dual Check Valves

LEAD FREE*	Model	Ordering Code	Size Inlet	Size Outlet	UPC	Qty. Per Carton	Weight Per Carton (lbs.)	List Price (each)
	LF07S	0122588	1	1	098268638646	6	19	245.50
	LF07S	0061943	1 1/2	1 1/2	098268572247	1	3.9	489.50
	LF07S	0061945	2	2	098268572254	1	4.3	539.00

*The wetted surface of this product contacted by consumable water contains less than 0.25% of lead by weight.

Consult factory for ordering code numbers of special models/options.

Double Check Valve Assemblies

4

Backflow Preventers & Accessories



007-QT



007M1-QT-HC

Model	Ordering Code	Size (in.)	Body	UPC	Qty. Per Carton	Weight Per Carton (lbs.)	List Price (each)
-------	---------------	------------	------	-----	-----------------	--------------------------	-------------------

Series 007 and LF007

With Quarter-Turn Shutoff Valves

007-QT	0062131	1/2	Bronze	098268302004	1	4	\$ 219.50
007M3-QT	0062020	3/4	Bronze	098268802153	1	5	248.50
007M1-QT	0062306	1	Bronze	098268005080	1	9	281.00
007M2-QT	0062681	1 1/4	Bronze	098268739091	1	14	413.00
007M2-QT	0062616	1 1/2	Bronze	098268279337	1	16	520.00
007M1-QT	0062427	2	Bronze	098268295573	1	24	582.50
LF007-QT	0063230	1/2	Silicon Bronze	098268209723	1	4	275.00
LF007M3-QT	0063231	3/4	Silicon Bronze	098268209730	1	6	310.50
LF007M1-QT	0063232	1	Silicon Bronze	098268209747	1	10	351.00
LF007M2-QT	0063233	1 1/4	Silicon Bronze	098268209754	1	15	516.00
LF007M2-QT	0063234	1 1/2	Silicon Bronze	098268209761	1	16	650.00
LF007M1-QT	0063235	2	Silicon Bronze	098268209778	1	24	729.00

LEAD FREE*

With Polymer Coating and Quarter-Turn Shutoff Valves

007-PC-QT	0062559	1/2	Bronze	098268556889	1	3.0	285.50
007M2-PC-QT	0062560	3/4	Bronze	098268556896	1	5.1	322.50
007M1-PC-QT	0062561	1	Bronze	098268556902	1	10	365.00
007M2-PC-QT	0062682	1 1/4	Bronze	098268739107	1	4.5	537.50
007M2-PC-QT	0062562	1 1/2	Bronze	098268556919	1	27	675.50
007M1-PC-QT	0062563	2	Bronze	098268556926	1	24	758.00

With Quarter-Turn Shutoff Valves and Strainer

007-QT-S	0062132	1/2	Bronze	098268383485	1	4.5	283.00
007M3-QT-S	0062021	3/4	Bronze	098268846713	1	6.6	341.00
007M1-QT-S	0062308	1	Bronze	098268198850	1	11	394.50
007M2-QT-S	0062450	1 1/4	Bronze	098268738254	1	16	574.50
007M2-QT-S	0062436	1 1/2	Bronze	098268471205	1	19	709.50
007M1-QT-S	0062428	2	Bronze	098268350128	1	29	845.00
LF007-QT-S	0122601	1/2	Silicon Bronze	098268639070	1	4.5	354.00
LF007M3-QT-S	0122593	3/4	Silicon Bronze	098268638707	1	6.6	425.50
LF007M1-QT-S	0122609	1	Silicon Bronze	098268639629	1	11	493.00
LF007M2-QT-S	0122624	1 1/4	Silicon Bronze	098268639780	1	16	718.00
LF007M2-QT-S	0122619	1 1/2	Silicon Bronze	098268639735	1	19	887.00
LF007M1-QT-S	0122617	2	Silicon Bronze	098268639704	1	29	1,057.00

LEAD FREE*

With Quarter-Turn Shutoff Valves-Inlet/Outlet Fire Hydrant Fittings (2.5" Inlet Female Hose Thread Swivel x 2.5" Outlet Male NST)

007M1-QT-HC	0063210	2	Bronze	098268914771	1	27	986.00
-------------	---------	---	--------	--------------	---	----	--------

With Stainless Steel Handles

007-QT-SH	0063200	1/2	Bronze	098268875263	1	3	242.00
007M3-QT-SH	0063206	3/4	Bronze	098268875324	1	9	271.50
007M1-QT-SH	0063202	1	Bronze	098268875287	1	10	306.00
007M2-QT-SH	0063203	1 1/4	Bronze	098268875294	1	23	460.50
007M2-QT-SH	0063204	1 1/2	Bronze	098268875300	1	25	570.50
007M1-QT-SH	0063205	2	Bronze	098268875317	1	26	636.00

*The wetted surface of this product contacted by consumable water contains less than 0.25% of lead by weight.

Consult factory for ordering code numbers of special models/options.

Double Check Valve Assemblies

Model	Ordering Code	Size (in.)	Body	UPC	Qty. Per Carton	Weight Per Carton (lbs.)	List Price (each)
-------	---------------	------------	------	-----	-----------------	--------------------------	-------------------

Series 007 and LF007 (cont.)

With Union Connections and Quarter-Turn Shutoffs

U007M2-QT	0062120	3/4	Bronze	098268325997	1	7.2	\$ 315.50
U007M1-QT	0062311	1	Bronze	098268307764	1	11	367.00
U007M2-QT	0062683	1 1/4	Bronze	098268739114	1	19	614.00
U007M2-QT	0062141	1 1/2	Bronze	098268350531	1	21	672.50
U007M1-QT	0062430	2	Bronze	098268350142	1	31	792.50
LFU007M2-QT	0122597	3/4	Silicon Bronze	098268638783	1	7.2	395.00
LFU007M1-QT	0122611	1	Silicon Bronze	098268639643	1	11	458.50
LFU007M2-QT	0124326	1 1/4	Silicon Bronze	098268829990	1	19	766.50
LFU007M2-QT	0122603	1 1/2	Silicon Bronze	098268639094	1	21	841.00
LFU007M1-QT	0122618	2	Silicon Bronze	098268639728	1	31	991.00

LEAD FREE*

With Union Connections, Quarter-Turn Shutoffs and Strainer

U007M2-QT-S	0062121	3/4	Bronze	098268567304	1	8.0	387.50
U007M1-QT-S	0062565	1	Bronze	098268554694	1	12	401.00
U007M2-QT-S	0062685	1 1/4	Bronze	098268739121	1	21	860.50
U007M2-QT-S	0062437	1 1/2	Bronze	098268471199	1	25	935.50
U007M1-QT-S	0062431	2	Bronze	098268350159	1	37	1,006.00

Stainless Steel Body with Quarter-Turn Shutoff

SS007M3-QT	0062695	1/2	S.S.	098268817119	1	4.8	1,029.00
SS007M3-QT	0062696	3/4	S.S.	098268817126	1	5.4	1,076.00
SS007M1-QT	0062692	1	S.S.	098268572056	1	10	1,439.00

LEAD FREE*

Less Shutoff Valves

007-LF	0062130	1/2	Bronze	098268383478	1	3.3	219.50
007M3-LF-UL	0062022	3/4	Bronze	098268924862	1	3.3	298.50
007M1-LF-UL	0062299	1	Bronze	098268211481	1	5.9	308.00
007M2-LF	0062680	1 1/4	Bronze	098268739084	1	10	375.00
007M2-LF	0062435	1 1/2	Bronze	098268471212	1	10	491.00
007M1-LF	0062426	2	Bronze	098268350111	1	14	500.00
LF007-LF	0122600	1/2	Silicon Bronze	098268639063	1	3.3	275.00
LF007M1-LF-UL	0122608	1	Silicon Bronze	098268639612	1	5.9	370.00
LF007M2-LF	0122661	1 1/4	Silicon Bronze	098268642742	1	10	469.50
LF007M2-LF	0124001	1 1/2	Silicon Bronze	098268739220	1	10	614.50
LF007M1-LF	0122616	2	Silicon Bronze	098268639698	1	14	626.00

LEAD FREE*

With Epoxy-Coated Quarter-Turn Ball Valve Shutoffs

LF007-QT-FDA	0122635	2 1/2	**Iron	098268642445	1	184	4,949.00
LF007-QT-FDA	0122639	3	**Iron	098268642483	1	158	5,651.00

LEAD FREE*

With NRS Resilient Seated Shutoff Valves

LF007-NRS	0122614	2 1/2	**Iron	098268639674	1	159	3,592.00
LF007-NRS	0122615	3	**Iron	098268639681	1	203	3,945.00

LEAD FREE*

With OSY Resilient Seated Shutoff Valves

LF007-OSY	0122633	2 1/2	**Iron	098268642421	1	164	3,957.00
LF007-OSY	0122637	3	**Iron	098268642469	1	270	4,553.00

LEAD FREE*

Less Shutoff Valves

LF007-LF	0063236	2 1/2	**Iron	098268507522	1	78	2,072.00
LF007-LF	0063237	3	**Iron	098268507539	1	78	2,274.00

LEAD FREE*



SS007QT



LF007-NRS

**FDA fused epoxy coated cast iron body.

*The wetted surface of this product contacted by consumable water contains less than 0.25% of lead by weight.

Consult factory for ordering code numbers of special models/options.

Double Check Valve Assemblies

4

Backflow Preventers & Accessories



LF719-QT



Model	Ordering Code	Size (in.)	Body	UPC	Qty. Per Carton	Weight Per Carton (lbs.)	List Price (each)
-------	---------------	------------	------	-----	-----------------	--------------------------	-------------------

Series 719 and LF719

With Quarter-Turn Shutoff Valves

719-QT	0062760	1/2	Bronze	098268068740	1	4.2	\$ 234.00
719-QT	0062761	3/4	Bronze	098268068801	1	5.3	264.00
719-QT	0062762	1	Bronze	098268068832	1	8.2	300.00
719-QT	0062763	1 1/4	Bronze	098268068856	1	15	439.50
719-QT	0062764	1 1/2	Bronze	098268068863	1	16	553.50
719-QT	0062765	2	Bronze	098268068986	1	24	620.50
LF719-QT	0065301	1/2	Silicon Bronze	098268236613	1	3.7	292.50
LF719-QT	0065302	3/4	Silicon Bronze	098268236620	1	5.3	330.50
LF719-QT	0065303	1	Silicon Bronze	098268236637	1	8.2	374.00
LF719-QT	0065304	1 1/4	Silicon Bronze	098268236644	1	14	549.50
LF719-QT	0065305	1 1/2	Silicon Bronze	098268236651	1	16	692.50
LF719-QT	0065306	2	Silicon Bronze	098268236668	1	24	776.00

LEAD FREE*

With Quarter-Turn Shutoff Valves and Bronze Strainer

719-QT-S	0062766	1/2	Bronze	098268069006	1	4.4	292.50
719-QT-S	0062767	3/4	Bronze	098268069013	1	7.2	351.00
719-QT-S	0062768	1	Bronze	098268069044	1	11	407.00
719-QT-S	0062769	1 1/4	Bronze	098268069136	1	18	592.50
719-QT-S	0062770	1 1/2	Bronze	098268069143	1	23	733.00
719-QT-S	0062771	2	Bronze	098268069150	1	35	872.50
LF719-QT-S	0065307	1/2	Bronze	098268236675	1	4.4	365.50
LF719-QT-S	0065308	3/4	Silicon Bronze	098268236781	1	6.2	439.00
LF719-QT-S	0065309	1	Silicon Bronze	098268236798	1	9.4	509.50
LF719-QT-S	0065310	1 1/4	Silicon Bronze	098268236804	1	22	740.50
LF719-QT-S	0065311	1 1/2	Silicon Bronze	098268236811	1	23	916.50
LF719-QT-S	0065312	2	Silicon Bronze	098268236828	1	35	1,091.00

LEAD FREE*

With Stainless Steel Handles

719-QT-SH	0064282	1/2	Bronze	098268207576	1	3.7	257.50
719-QT-SH	0064283	3/4	Bronze	098268207583	1	6.2	288.50
719-QT-SH	0064284	1	Bronze	098268207590	1	9.4	324.50
719-QT-SH	0064285	1 1/4	Bronze	098268207606	1	16	490.00
719-QT-SH	0064286	1 1/2	Bronze	098268207613	1	19	608.00
719-QT-SH	0064287	2	Bronze	098268207620	1	28	677.00

With Quarter-Turn Shutoff Valves-Inlet/Outlet Fire Hydrant Fittings (2.5" inlet female hose thread swivel x 2.5" outlet male NST)

719-QT HC	0064288	2	Bronze	098268207637	1	28	1,049.00
-----------	---------	---	--------	--------------	---	----	----------

*The wetted surface of this product contacted by consumable water contains less than 0.25% of lead by weight.

Consult factory for ordering code numbers of special models/options.

Double Check Valve Assemblies

Model	Ordering Code	Size (in.)	Body	UPC	Qty. Per Carton	Weight Per Carton (lbs.)	List Price (each)
-------	---------------	------------	------	-----	-----------------	--------------------------	-------------------

Series 719 and LF719

With Union Connections and Quarter-Turn Shutoffs

U719-QT-R10	0062874	1/2	Bronze	098268079760	1	9.0	\$ 379.00
U719-QT-R10	0062875	3/4	Bronze	098268079777	1	9.1	379.00
U719-QT	0062802	1	Bronze	098268069990	1	10	379.00
U719-QT-R15	0062803	1 1/4	Bronze	098268070002	1	22	633.50
U719-QT	0062804	1 1/2	Bronze	098268070019	1	24	694.50
U719-QT	0062805	2	Bronze	098268070026	1	35	818.00

With Union Connections, Quarter-Turn Shutoffs and Bronze Strainer

U719-QT-S R10	0064246	1/2	Bronze	098268139242	1	10	414.00
U719-QT-S R10	0064247	3/4	Bronze	098268139259	1	11	414.00
U719-QT-S	0064242	1	Bronze	098268139204	1	11	414.00
U719-QT-S	0064243	1 1/4	Bronze	098268139211	1	23	888.50
U719-QT-S	0064244	1 1/2	Bronze	098268139228	1	24	967.00
U719-QT-S	0064245	2	Bronze	098268139235	1	36	1,039.00

With Elbow Fitting for 360° Rotation

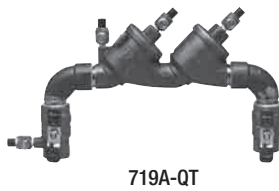

719A-QT

719A-QT	0062806	1/2	Bronze	098268070033	1	4.0	389.50
719A-QT-R10	0062877	3/4	Bronze	098268079791	1	9.2	497.00
719A-QT	0062808	1	Bronze	098268070057	1	11	497.00
719A-QT	0062809	1 1/4	Bronze	098268070064	1	23	664.50
719A-QT	0062810	1 1/2	Bronze	098268070071	1	24	725.00
719A-QT	0062811	2	Bronze	098268070088	1	36	917.00

With Quarter-Turn Shutoff Valves and Cap and Tether

719-QT-CT	0064276	1/2	Bronze	098268202649	1	3.7	261.00
719-QT-CT	0064277	3/4	Bronze	098268202717	1	6.2	294.00
719-QT-CT	0064278	1	Bronze	098268202762	1	9.4	333.50
719-QT-CT	0064279	1 1/4	Bronze	098268202779	1	16	475.00
719-QT-CT	0064280	1 1/2	Bronze	098268202786	1	19	599.50
719-QT-CT	0064281	2	Bronze	098268202793	1	28	671.50

*The wetted surface of this product contacted by consumable water contains less than 0.25% of lead by weight.

Consult factory for ordering code numbers of special models/options.

Double Check Valve Assemblies

4

Backflow Preventers & Accessories

Model	Ordering Code	Size (in.)	Body	UPC	Qty. Per Carton	Weight Per Carton (lbs.)	List Price (each)
-------	---------------	------------	------	-----	-----------------	--------------------------	-------------------

Series LF709

With NRS Resilient Seated Shutoff Valves

LEAD FREE*	Model	Ordering Code	Size (in.)	Body	UPC	Qty. Per Carton	Weight Per Carton (lbs.)	List Price (each)
	LF709-NRS	0122787	2 1/2	**Iron	098268646795	1	248	\$ 3,618.00
	LF709-NRS	0122788	3	**Iron	098268646801	1	260	3,972.00
	LF709-NRS	0122752	4	**Iron	098268646436	1	421	4,215.00
	LF709-NRS	0122792	6	**Iron	098268646849	1	898	6,956.00
	LF709-NRS	0122800	8	**Iron	098268646979	1	1821	14,818.00
	LF709-NRS	0122793	10	**Iron	098268646863	1	2359	19,137.00

With Strainer

LEAD FREE*	Model	Ordering Code	Size (in.)	Body	UPC	Qty. Per Carton	Weight Per Carton (lbs.)	List Price (each)
	LF709-NRS-S-FDA	0122824	4	**Iron	098268647211	1	600	4,987.00
	LF709-NRS-S-FDA	0122825	6	**Iron	098268647228	1	950	8,168.00
	LF709-NRS-S-FDA	0122828	10	**Iron	098268647259	1	2410	22,444.00

With OSY Resilient Seated Shutoff Valves

LEAD FREE*	Model	Ordering Code	Size (in.)	Body	UPC	Qty. Per Carton	Weight Per Carton (lbs.)	List Price (each)
	LF709-OSY	0122785	2 1/2	**Iron	098268646771	1	297	3,858.00
	LF709-OSY	0122786	3	**Iron	098268646788	1	288	4,236.00
	LF709-OSY	0122789	4	**Iron	098268646818	1	502	4,496.00
	LF709-OSY	0122790	6	**Iron	098268646825	1	893	7,420.00
	LF709-OSY	0122791	8	**Iron	098268646832	1	1512	15,806.00
	LF709-OSY	0122794	10	**Iron	098268646900	1	2003	20,412.00



LF709OSY

Less Shutoff Valves

LEAD FREE*	Model	Ordering Code	Size (in.)	Body	UPC	Qty. Per Carton	Weight Per Carton (lbs.)	List Price (each)
	LF709-LF	0792160	2 1/2	**Iron	098268437423	1	130	2,412.00
	LF709-LF	0792161	3	**Iron	098268437430	1	132	2,649.00
	LF709-LF	0792162	4	**Iron	098268437447	1	298	2,810.00
	LF709-LF	0792163	6	**Iron	098268437454	1	597	4,637.00
	LF709-LF	0792164	8	**Iron	098268437461	1	928	9,879.00
	LF709-LF	0792165	10	**Iron	098268437478	1	1573	12,758.00

**FDA fused epoxy coated cast iron body.

*The wetted surface of this product contacted by consumable water contains less than 0.25% of lead by weight.

Consult factory for ordering code numbers of special models/options.

Double Check Valve Assemblies

Model	Ordering Code	Size (in.)	Body	UPC	Qty. Per Carton	Weight Per Carton (lbs.)	List Price (each)
-------	---------------	------------	------	-----	-----------------	--------------------------	-------------------

Series 774

With NRS Resilient Seated Shutoff Valves

LEAD FREE*	774-NRS	0437700	2 1/2	S.S.	098268877991	1	140	\$ 2,611.00
	774-NRS	0437708	3	S.S.	098268878073	1	215	2,868.00
	774-NRS	0438000	4	S.S.	098268795417	1	225	3,002.00
	774-NRS	0438008	6	S.S.	098268795516	1	375	4,823.00
	774-NRS	0438024	8	S.S.	098268795493	1	680	9,669.00
	774-NRS	0438040	10	S.S.	098268795615	1	763	12,867.00
	774-NRS	0438080	12	S.S.	098268877335	1	1505	18,393.00

With OSY Resilient Seated Shutoff Valves

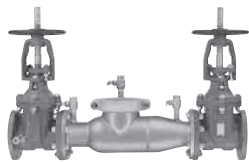

774-OSY

LEAD FREE*	774-OSY	0437701	2 1/2	S.S.	098268878004	1	140	2,605.00
	774-OSY	0437709	3	S.S.	098268878172	1	215	2,982.00
	774-OSY	0438001	4	S.S.	098268795424	1	265	3,078.00
	774-OSY	0438009	6	S.S.	098268795523	1	485	4,813.00
	774-OSY	0438025	8	S.S.	098268795486	1	752	9,512.00
	774-OSY	0438041	10	S.S.	098268795608	1	1144	13,102.00
	774-OSY	0438081	12	S.S.	098268877342	1	1505	18,158.00

With OSY Resilient Seated Shutoff Valves (Grooved Inlet x Flanged Outlet)

LEAD FREE*	774-OSY-GxF	0439501	2 1/2	S.S.	098268264111	1	140	2,605.00
	774-OSY-GxF	0439504	3	S.S.	098268264159	1	215	2,982.00
	774-OSY-GxF	0439507	4	S.S.	098268264180	1	265	3,078.00
	774-OSY-GxF	0439510	6	S.S.	098268264210	1	485	4,813.00
	774-OSY-GxF	0439513	8	S.S.	098268264241	1	752	9,512.00
	774-OSY-GxF	0439516	10	S.S.	098268264272	1	1144	13,102.00

With OSY Resilient Seated Shutoff Valves (Flanged Inlet x Grooved Outlet)

LEAD FREE*	774-OSY-FxG	0439502	2 1/2	S.S.	098268264128	1	140	2,605.00
	774-OSY-FxG	0439505	3	S.S.	098268264166	1	215	2,982.00
	774-OSY-FxG	0439508	4	S.S.	098268264197	1	265	3,078.00
	774-OSY-FxG	0439511	6	S.S.	098268264227	1	485	4,813.00
	774-OSY-FxG	0439514	8	S.S.	098268264258	1	752	9,512.00
	774-OSY-FxG	0439517	10	S.S.	098268264289	1	1144	13,102.00

Less Shutoff Valves

LEAD FREE*	774-LF	0437702	2 1/2	S.S.	098268878011	1	60	1,707.00
	774-LF	0437710	3	S.S.	098268878080	1	55	1,874.00
	774-LF	0438002	4	S.S.	098268795370	1	37	1,988.00
	774-LF	0438010	6	S.S.	098268795585	1	92	3,282.00
	774-LF	0438026	8	S.S.	098268795509	1	260	6,989.00
	774-LF	0438042	10	S.S.	098268795660	1	179	9,027.00
	774-LF	0438082	12	S.S.	098268877359	1	209	12,944.00

*The wetted surface of this product contacted by consumable water contains less than 0.25% of lead by weight.

Consult factory for ordering code numbers of special models/options.

Double Check Valve Assemblies

4

Backflow Preventers & Accessories

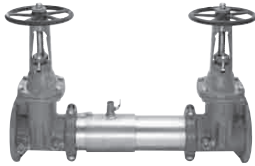

757-OSY

Model	Ordering Code	Size (in.)	Body	UPC	Qty. Per Carton	Weight Per Carton (lbs.)	List Price (each)
-------	---------------	------------	------	-----	-----------------	--------------------------	-------------------

Series 757

With OSY Resilient Seated Shutoff Valves

757-OSY	0111510	2 1/2	S.S.	098268117639	1	201	\$ 2,166.00
757-OSY	0111511	3	S.S.	098268117646	1	323	2,382.00
757-OSY	0111512	4	S.S.	098268117653	1	260	2,599.00
757-OSY	0111513	6	S.S.	098268117684	1	402	4,064.00
757-OSY	0111514	8	S.S.	098268117691	1	610	8,031.00
757-OSY	0111515	10	S.S.	098268118117	1	922	10,161.00

N-Pattern with OSY Resilient Seated Shutoff Valves

757N-OSY	0111516	2 1/2	S.S.	098268118858	1	183	3,083.00
757N-OSY	0111517	3	S.S.	098268118865	1	206	3,311.00
757N-OSY	0111518	4	S.S.	098268118902	1	249	4,080.00
757N-OSY	0111519	6	S.S.	098268118940	1	556	6,526.00
757N-OSY	0111520	8	S.S.	098268118995	1	706	11,784.00
757N-OSY	0111521	10	S.S.	098268119008	1	1092	14,022.00

With NRS Resilient Seated Shutoff Valves

757-NRS	0111522	2 1/2	S.S.	098268119022	1	200	2,015.00
757-NRS	0111523	3	S.S.	098268119039	1	222	2,238.00
757-NRS	0111524	4	S.S.	098268119091	1	260	2,462.00
757-NRS	0111525	6	S.S.	098268119428	1	405	3,957.00
757-NRS	0111526	8	S.S.	098268119602	1	610	7,933.00
757-NRS	0111527	10	S.S.	098268119664	1	921	10,064.00

N-Pattern with NRS Resilient Seated Shutoff Valves

757N-NRS	0111528	2 1/2	S.S.	098268119732	1	173	2,854.00
757N-NRS	0111529	3	S.S.	098268120295	1	222	3,083.00
757N-NRS	0111530	4	S.S.	098268120301	1	249	3,852.00
757N-NRS	0111531	6	S.S.	098268120318	1	424	6,283.00
757N-NRS	0111532	8	S.S.	098268120325	1	664	11,417.00
757N-NRS	0111533	10	S.S.	098268120332	1	1091	13,654.00

With UL/FM Butterfly Valve Shutoffs (Gear operated)

757-BFG	0111534	2 1/2	S.S.	098268120349	1	65	2,377.00
757-BFG	0111535	3	S.S.	098268120356	1	64	2,592.00
757-BFG	0111536	4	S.S.	098268120363	1	69	2,810.00
757-BFG	0111537	6	S.S.	098268120370	1	232	4,280.00
757-BFG	0111538	8	S.S.	098268120547	1	271	8,252.00

N-Pattern with UL/FM Butterfly Valve Shutoffs (Gear operated)

757N-BFG	0111540	2 1/2	S.S.	098268120578	1	115	3,301.00
757N-BFG	0111541	3	S.S.	098268120608	1	80	3,529.00
757N-BFG	0111542	4	S.S.	098268120622	1	90	4,299.00
757N-BFG	0111543	6	S.S.	098268120776	1	250	6,751.00
757N-BFG	0111746	8	S.S.	098268125764	1	487	8,664.00

With Quarter-turn Ball Valve Shutoffs

757-QT	0111757	2 1/2	S.S.	098268300628	1	54	2,117.00
757-QT	0111758	3	S.S.	098268231861	1	60	2,351.00

N-Pattern with Quarter-Turn Ball Valve Shutoffs

757N-QT	0111765	2 1/2	S.S.	098268126129	1	115	2,854.00
757N-QT	0111766	3	S.S.	098268126136	1	117	3,083.00



757N-BFG



757-QT

*The wetted surface of this product contacted by consumable water contains less than 0.25% of lead by weight.

Consult factory for ordering code numbers of special models/options.

Reduced Pressure Zone Assemblies

Model	Ordering Code	Size (in.)	Body	UPC	Qty. Per Carton	Weight Per Carton (lbs.)	List Price (each)
-------	---------------	------------	------	-----	-----------------	--------------------------	-------------------

Series 009 and LF009 With Quarter-Turn Shutoff Valves



LF009-QT

009-QT	0062098	1/4	Bronze	098268080988	1	4.8	\$ 240.50
009-QT	0062096	3/8	Bronze	098268080971	1	5.6	252.50
009-QT	0062094	1/2	Bronze	098268080964	1	4.7	297.50
009M3-QT	0063030	3/4	Bronze	098268802214	1	5.5	396.50
009M2-QT	0063020	1	Bronze	098268647525	1	12	468.00
009M2-QT	0062920	1 1/4	Bronze	098268240511	1	15	734.50
009M2-QT	0062921	1 1/2	Bronze	098268240528	1	17	769.00
009M2-QT	0063010	2	Bronze	098268591781	1	29	912.50
LF009-QT	0391002	1/2	Silicon Bronze	098268051100	1	4.7	372.00
LF009M3-QT	0391003	3/4	Silicon Bronze	098268051117	1	6.4	495.50
LF009M2-QT	0391004	1	Silicon Bronze	098268051131	1	12	584.50
LF009M2-QT	0391005	1 1/4	Silicon Bronze	098268051148	1	17	918.00
LF009M2-QT	0391006	1 1/2	Silicon Bronze	098268051155	1	18	960.50
LF009M2-QT	0391007	2	Silicon Bronze	098268051162	1	28	1,140.00

LEAD FREE

With Inlet/Outlet Fire Hydrant Fittings (2.5" Inlet Female Hose Thread Swivel x 2.5" Outlet Male NST)



009M2-QT-HC

009M2-QT HC	0436020	2	Bronze	098268914788	1	34	1,292.00
-------------	---------	---	--------	--------------	---	----	----------

Stainless Steel Body - with Quarter-Turn Shutoff Valve

SS009M3-QT	0062967	1/2	S.S.	098268817096	1	4.8	2,085.00
SS009M3-QT	0062968	3/4	S.S.	098268817102	1	5.8	2,233.00
SS009-QT	0062962	1	S.S.	098268572087	1	13	2,361.00

LEAD FREE

With Quarter-Turn Shutoff Valves and Strainer



SS009-QT

009-QT-S	0062181	1/4	Bronze	098268587296	1	5.4	269.50
009-QT-S	0062180	3/8	Bronze	098268587289	1	5.3	282.00
009-QT-S	0062095	1/2	Bronze	098268237320	1	4.9	340.50
009M3-QT-S	0063031	3/4	Bronze	098268846706	1	6.7	462.50
009M2-QT-S	0063021	1	Bronze	098268647532	1	13	551.00
009M2-QT-S	0062950	1 1/4	Bronze	098268489224	1	18	846.50
009M2-QT-S	0062952	1 1/2	Bronze	098268489248	1	21	927.00
009M2-QT-S	0063011	2	Bronze	098268591798	1	34	1,107.00
LF009-QT-S	0122606	1/4	Silicon Bronze	098268639599	1	5.4	336.00
LF009-QT-S	0122605	3/8	Silicon Bronze	098268639179	1	5.3	353.00
LF009-QT-S	0122596	1/2	Silicon Bronze	098268638752	1	4.9	425.00
LF009M3-QT-S	0122695	3/4	Silicon Bronze	098268643299	1	6.7	578.50
LF009M2-QT-S	0122693	1	Silicon Bronze	098268643213	1	13	688.50
LF009M2-QT-S	0122688	1 1/4	Silicon Bronze	098268643046	1	18	1,059.00
LF009M2-QT-S	0122689	1 1/2	Silicon Bronze	098268643053	1	21	1,160.00
LF009M2-QT-S	0122692	2	Silicon Bronze	098268643091	1	34	1,384.00

LEAD FREE

With Union Connections and Quarter-Turn Shutoffs

U009-QT	0062085	1/2	Bronze	098268256918	1	6.0	343.50
U009M2-QT	0062288	3/4	Bronze	098268325331	1	7.8	449.50
U009M2-QT	0437012	1	Bronze	098268875683	1	13	536.00
U009M2-QT	0062922	1 1/4	Bronze	098268271003	1	20	824.50
U009M2-QT	0062923	1 1/2	Bronze	098268271010	1	23	913.00
U009M2-QT	0436073	2	Bronze	098268824339	1	36	1,092.00
LFU009-QT	0122594	1/2	Silicon Bronze	098268638714	1	6.0	428.50
LFU009M2-QT	0122607	3/4	Silicon Bronze	098268639605	1	7.8	562.00
LFU009M2-QT	0122847	1	Silicon Bronze	098268647440	1	13	669.50
LFU009M2-QT	0122686	1 1/4	Silicon Bronze	098268643022	1	20	1,030.00
LFU009M2-QT	0122687	1 1/2	Silicon Bronze	098268643039	1	23	1,141.00
LFU009M2-QT	0122841	2	Silicon Bronze	098268647389	1	36	1,366.00

LEAD FREE

*The wetted surface of this product contacted by consumable water contains less than 0.25% of lead by weight.

Consult factory for ordering code numbers of special models/options.

Reduced Pressure Zone Assemblies

4

Backflow Preventers & Accessories

Model	Ordering Code	Size (in.)	Body	UPC	Qty. Per Carton	Weight Per Carton (lbs.)	List Price (each)
-------	---------------	------------	------	-----	-----------------	--------------------------	-------------------

Series 009 and LF009 (cont.)

With Union Connections, Quarter-Turn Shutoffs and Strainer

U009-QT-S	0062086	1/2	Bronze	098268260649	1	5.9	\$ 396.50
U009M2-QT-S	0062287	3/4	Bronze	098268325348	1	8.6	530.00
U009M2-QT-S	0437013	1	Bronze	098268875690	1	15	665.50
U009M2-QT-S	0062951	1 1/4	Bronze	098268489231	1	22	964.00
U009M2-QT-S	0062953	1 1/2	Bronze	098268489262	1	27	1,079.00
U009M2-QT-S	0436074	2	Bronze	098268827408	1	41	1,326.00
LFU009-QT-S	0124319	1/2	Silicon Bronze	098268829716	1	5.9	495.50
LFU009M2-QT-S	0124320	3/4	Silicon Bronze	098268829839	1	8.6	663.00
LFU009M2-QT-S	0122848	1	Silicon Bronze	098268647457	1	15	831.00
LFU009M2-QT-S	0124321	1 1/4	Silicon Bronze	098268829846	1	22	1,206.00
LFU009M2-QT-S	0124322	1 1/2	Silicon Bronze	098268829853	1	27	1,349.00
LFU009M2-QT-S	0122842	2	Silicon Bronze	098268647396	1	41	1,657.00

LEAD FREE

With Polymer Coating and Quarter-Turn Shutoffs

009PC-QT	0062170	1/2	Bronze	098268493610	1	5	420.50
009M2PC-QT	0436040	3/4	Bronze	098268420197	1	6	458.50
009M2PC-QT	0436076	1	Bronze	098268874419	1	11	541.50
009M2PC-QT	0436042	1 1/4	Bronze	098268420210	1	17	849.50
009M2PC-QT	0436043	1 1/2	Bronze	098268420227	1	18	917.00
009M2PC-QT	0436039	2	Bronze	098268741803	1	30	1,056.00
LF009M2-PC-QT	0122837	3/4	Silicon Bronze	098268647341	1	6	574.00

LEAD FREE

With Union Connections, Polymer Coating and Quarter-Turn Shutoffs

U009M2PC-QT	0436077	1	Bronze	098268874426	1	13	603.00
U009M2PC-QT	0436070	2	Bronze	098268824315	1	36	1,222.00

With Union Angle Inlet x Union Angle Outlet

U009A-QT	0062451	3/4	Bronze	098268322088	1	13	541.50
U009M2A-QT	0437014	1	Bronze	098268875706	1	14	545.00
U009M2A-QT	0062465	1 1/2	Bronze	098268350555	1	25	925.50
U009M2A-QT	0436072	2	Bronze	098268824322	1	37	1,149.00

With Stainless Steel Handles

009-QT-SH	0436010	1/2	Bronze	098268875331	1	5	321.50
009M3-QT-SH	0436016	3/4	Bronze	098268875393	1	10	423.00
009M2-QT-SH	0436012	1	Bronze	098268875355	1	12	497.00
009M2-QT-SH	0436013	1 1/4	Bronze	098268875362	1	28	789.50
009M2-QT-SH	0436014	1 1/2	Bronze	098268875379	1	19	849.50
009M2-QT-SH	0436015	2	Bronze	098268875386	1	32	972.50



U009PC-QT



U009A-QT

*The wetted surface of this product contacted by consumable water contains less than 0.25% of lead by weight.

Consult factory for ordering code numbers of special models/options.

Reduced Pressure Zone Assemblies

Model	Ordering Code	Size (in.)	Body	UPC	Qty. Per Carton	Weight Per Carton (lbs.)	List Price (each)
-------	---------------	------------	------	-----	-----------------	--------------------------	-------------------

Series 009 and LF009 (cont.)

Less Shutoff Valves

009-LF	0062087	1/2	Bronze	098268648591	1	3.7	\$ 279.50
009M3-LF	0062973	3/4	Bronze	098268924879	1	4.0	392.50
009M2-LF	0437010	1	Bronze	098268875669	1	10	457.50
009M2-LF	0062956	1 1/4	Bronze	098268744699	1	12	727.00
009M2-LF	0062954	1 1/2	Bronze	098268639391	1	12	816.50
009M2-LF	0063022	2	Bronze	098268783209	1	18	842.00
LF009-LF	0122595	1/2	Silicon Bronze	098268638745	1	3.7	349.50
LF009M3-LF	0124323	3/4	Silicon Bronze	098268829860	1	4.0	490.50
LF009M2-LF	0124325	1	Silicon Bronze	098268829884	1	10	571.00
LF009M2-LF	0122691	1 1/4	Silicon Bronze	098268643077	1	12	909.00
LF009M2-LF	0122690	1 1/2	Silicon Bronze	098268643060	1	12	1,022.00
LF009M2-LF	0122694	2	Silicon Bronze	098268643282	1	18	1,053.00

LEAD FREE*

With NRS Resilient Seated Shutoff Valves

LF009-NRS	0122612	2 1/2	**Iron	098268639650	1	185	3,286.00
LF009-NRS	0122613	3	**Iron	098268639667	1	225	3,706.00

LEAD FREE*

With OSY Resilient Seated Shutoff Valves

LF009-OSY	0122643	2 1/2	**Iron	098268642520	1	224	3,543.00
LF009-OSY	0122651	3	**Iron	098268642643	1	198	4,134.00

LEAD FREE*

With NRS Resilient Seated Shutoff Valves and FDA Epoxy-Coated Strainer

LF009-NRS-S-FDA	0122646	2 1/2	**Iron	098268642551	1	203	3,960.00
LF009-NRS-S-FDA	0122654	3	**Iron	098268642674	1	245	4,490.00

LEAD FREE*

With OSY Resilient Seated Shutoff Valves and FDA Epoxy-Coated Strainer

LF009-OSY-S-FDA	0122647	2 1/2	**Iron	098268642568	1	206	4,238.00
LF009-OSY-S-FDA	0124317	3	**Iron	098268828740	1	206	4,858.00

LEAD FREE*

With Quarter-Turn Resilient Seated Ball Shutoff Valves

LF009-QT-FDA	0122645	2 1/2	**Iron	098268642544	1	150	4,421.00
LF009-QT-FDA	0122653	3	**Iron	098268642667	1	158	5,127.00

LEAD FREE*

Less Shutoff Valves

LF009-LF	0122642	2 1/2	**Iron	098268642513	1	81	2,756.00
LF009-LF	0122650	3	**Iron	098268642636	1	82	3,135.00

LEAD FREE*



LF009-NRS

**FDA fused epoxy coated cast iron body.

*The wetted surface of this product contacted by consumable water contains less than 0.25% of lead by weight.
Consult factory for ordering code numbers of special models/options.

Reduced Pressure Zone Assemblies

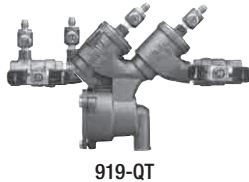

919-QT

Model	Ordering Code	Size (in.)	Body	UPC	Qty. Per Carton	Weight Per Carton (lbs.)	List Price (each)
-------	---------------	------------	------	-----	-----------------	--------------------------	-------------------

Series 919 and LF919

With Quarter-Turn Shutoff Valves

919-QT	0062773	3/4	Bronze	098268069525	1	7.8	\$ 416.00
919-QT	0062774	1	Bronze	098268069686	1	11	491.50
919-QT	0062775	1 1/4	Bronze	098268069754	1	23	770.50
919-QT	0062776	1 1/2	Bronze	098268069761	1	25	807.50
919-QT	0062777	2	Bronze	098268069778	1	33	957.00
LF919-QT	0065372	3/4	Bronze	098268238518	1	7.8	521.00
LF919-QT	0065373	1	Bronze	098268238556	1	11	614.50
LF919-QT	0065374	1 1/4	Bronze	098268238631	1	23	963.00
LF919-QT	0065375	1 1/2	Bronze	098268238648	1	24	1,009.00
LF919-QT	0065376	2	Bronze	098268238709	1	32	1,198.00

LEAD FREE

With Quarter-Turn Shutoff Valves and Strainer

919-QT-S	0062779	3/4	Bronze	098268069792	1	10	486.00
919-QT-S	0062780	1	Bronze	098268069808	1	14	578.50
919-QT-S	0062781	1 1/4	Bronze	098268069860	1	28	889.00
919-QT-S	0062782	1 1/2	Bronze	098268069877	1	33	974.00
919-QT-S	0062783	2	Bronze	098268069884	1	44	1,163.00
LF919-QT-S	0065378	3/4	Bronze	098268238723	1	10	607.00
LF919-QT-S	0065379	1	Bronze	098268238730	1	14	723.00
LF919-QT-S	0065380	1 1/4	Bronze	098268238747	1	28	1,112.00
LF919-QT-S	0065381	1 1/2	Bronze	098268238754	1	33	1,219.00
LF919-QT-S	0065382	2	Bronze	098268238778	1	44	1,453.00

LEAD FREE

With Quarter-Turn Shutoff Valves and Cap and Tether

919-QT-CT	0063487	3/4	Bronze	098268202281	1	8.3	463.50
919-QT-CT	0063488	1	Bronze	098268202298	1	12	535.50
919-QT-CT	0063489	1 1/4	Bronze	098268202304	1	22	856.50
919-QT-CT	0063490	1 1/2	Bronze	098268202311	1	28	898.00
919-QT-CT	0063491	2	Bronze	098268202410	1	37	1,065.00

With Elbow Fitting for 360° Rotation and Quarter-Turn Shutoff Valves

919A-QT	0062819	3/4	Bronze	098268070224	1	10	568.50
919A-QT	0062820	1	Bronze	098268070231	1	13	573.00
919A-QT	0062821	1 1/4	Bronze	098268070248	1	29	868.50
919A-QT	0062822	1 1/2	Bronze	098268070255	1	34	971.50
919A-QT	0062823	2	Bronze	098268070262	1	46	1,206.00

Z-Pattern With Quarter-Turn Shutoff Valves

919Z-QT	0062837	3/4	Bronze	098268095623	1	8.3	654.00
919Z-QT	0062838	1	Bronze	098268095647	1	13	658.00
919Z-QT	0062839	1 1/4	Bronze	098268095661	1	29	999.00
919Z-QT	0062840	1 1/2	Bronze	098268095678	1	34	1,118.00
919Z-QT	0062841	2	Bronze	098268095685	1	46	1,386.00

With Union Connections and Quarter-Turn Shutoff Valves

U919-QT	0062814	1	Bronze	098268070118	1	13	546.00
U919-QT	0062815	1 1/4	Bronze	098268070163	1	28	841.00
U919-QT	0062816	1 1/2	Bronze	098268070170	1	34	931.00
U919-QT	0062817	2	Bronze	098268070200	1	45	1,114.00

With Union Angle Inlet x Union Angle Outlet

U919A-QT	0063508	3/4	Bronze	098268194395	1	11	473.00
U919A-QT	0063511	1	Bronze	098268194425	1	16	567.50
U919A-QT	0063512	1 1/4	Bronze	098268194432	1	32	871.00
U919A-QT	0063513	1 1/2	Bronze	098268194678	1	34	933.00
U919A-QT	0063514	2	Bronze	098268194692	1	46	1,147.00

*The wetted surface of this product contacted by consumable water contains less than 0.25% of lead by weight.

Consult factory for ordering code numbers of special models/options.

Reduced Pressure Zone Assemblies



LF909-QT

Model	Ordering Code	Size (in.)	Body	UPC	Qty. Per Carton	Weight Per Carton (lbs.)	List Price (each)
-------	---------------	------------	------	-----	-----------------	--------------------------	-------------------

Series LF909

With Quarter-Turn Shutoff Valves

LEAD FREE*	LF909-QT	0391008	3/4	Silicon Bronze	098268051179	1	15	\$ 1,095.00
	LF909-QT	0391009	1	Silicon Bronze	098268051186	1	17	1,292.00
	LF909M1-QT	0391010	1 1/4	Silicon Bronze	098268051193	1	37	2,026.00
	LF909M1-QT	0391011	1 1/2	Silicon Bronze	098268051209	1	39	2,184.00
	LF909M1-QT	0391012	2	Silicon Bronze	098268051230	1	43	2,516.00

With Quarter-Turn Shutoff Valves and Strainer

LEAD FREE*	LF909-QT-S	0122774	3/4	Silicon Bronze	098268646665	1	18	1,250.00
	LF909-QT-S	0122775	1	Silicon Bronze	098268646672	1	18	1,485.00
	LF909M1-QT-S	0122765	1 1/4	Silicon Bronze	098268646566	1	40	2,294.00
	LF909M1-QT-S	0122766	1 1/2	Silicon Bronze	098268646573	1	42	2,501.00
	LF909M1-QT-S	0122767	2	Silicon Bronze	098268646580	1	49	2,960.00

With Quarter-Turn Shutoff Valves and Stainless Steel Check Modules

LEAD FREE*	LF909HW-QT	0792031	3/4	Silicon Bronze	098268434149	1	16	1,585.00
	LF909HW-QT	0792032	1	Silicon Bronze	098268434156	1	17	1,866.00
	LF909HWM1-QT	0792033	1 1/4	Silicon Bronze	098268434163	1	38	2,933.00
	LF909HWM1-QT	0792034	1 1/2	Silicon Bronze	098268434170	1	41	3,161.00
	LF909HWM1-QT	0792035	2	Silicon Bronze	098268434187	1	44	3,641.00

With Quarter-Turn Shutoff Valves, Stainless Steel Check Modules and Strainer

LEAD FREE*	LF909-QT-S-HW	0122771	3/4	Silicon Bronze	098268646627	1	17	1,774.00
	LF909-QT-S-HW	0122772	1	Silicon Bronze	098268646634	1	18	2,109.00
	LF909M1-QT-S-HW	0122768	1 1/4	Silicon Bronze	098268646597	1	41	3,255.00
	LF909M1-QT-S-HW	0122769	1 1/2	Silicon Bronze	098268646603	1	44	3,551.00
	LF909M1-QT-S-HW	0122770	2	Silicon Bronze	098268646610	1	50	4,200.00

With NRS Resilient Seated Shutoff Valves

LEAD FREE*	LF909-NRS	0122773	2 1/2	**Iron	098268646641	1	259	5,803.00
	LF909-NRS	0391015	3	**Iron	098268208153	1	278	6,600.00
	LF909-NRS	0122797	4	**Iron	098268646948	1	500	8,250.00
	LF909-NRS	0122799	6	**Iron	098268646962	1	864	11,989.00
	LF909M1-NRS	0122758	8	**Iron	098268646498	1	1456	20,050.00
	LF909M1-NRS	0122761	10	**Iron	098268646528	1	2160	26,556.00

With NRS Resilient Seated Shutoff Valves and Epoxy-Coated Strainer

LEAD FREE*	LF909-NRS-S-FDA	0122804	2 1/2	**Iron	098268647013	1	301	6,271.00
	LF909-NRS-S-FDA	0122805	3	**Iron	098268647020	1	277	7,092.00
	LF909-NRS-S-FDA	0122801	4	**Iron	098268646986	1	640	9,005.00
	LF909-NRS-S-FDA	0122798	6	**Iron	098268646955	1	1032	13,409.00
	LF909M1-NRS-S-FDA	0122757	8	**Iron	098268646481	1	1731	21,804.00
	LF909M1-NRS-S-FDA	0124336	10	**Iron	098268830750	1	2573	29,777.00

With OSY Resilient Seated Shutoff Valves

LEAD FREE*	LF909-OSY	0122795	2 1/2	**Iron	098268646924	1	302	6,189.00
	LF909-OSY	0122776	3	**Iron	098268646689	1	340	7,040.00
	LF909-OSY	0122763	4	**Iron	098268646542	1	563	8,799.00
	LF909-OSY	0122764	6	**Iron	098268646559	1	864	12,789.00
	LF909M1-OSY	0122759	8	**Iron	098268646504	1	1456	21,387.00
	LF909M1-OSY	0122762	10	**Iron	098268646535	1	2401	28,326.00

*FDA fused epoxy coated cast iron body.

*The wetted surface of this product contacted by consumable water contains less than 0.25% of lead by weight.

Consult factory for ordering code numbers of special models/options.

Reduced Pressure Zone Assemblies

4

Backflow Preventers & Accessories



LF909-OSY



LF909-QT-S-FDA

Model	Ordering Code	Size (in.)	Body	UPC	Qty. Per Carton	Weight Per Carton (lbs.)	List Price (each)
-------	---------------	------------	------	-----	-----------------	--------------------------	-------------------

Series LF909 (cont.)

With Epoxy-Coated Quarter-Turn Ball Valve Shutoffs

LEAD FREE*	LF909-OSY-S-FDA	0122806	2 1/2	**Iron	098268647037	1	240	\$ 6,657.00
	LF909-OSY-S-FDA	0122807	3	**Iron	098268647044	1	282	7,532.00
	LF909-OSY-S-FDA	0122802	4	**Iron	098268646993	1	651	9,555.00
	LF909-OSY-S-FDA	0122803	6	**Iron	098268647006	1	1032	14,208.00
	LF909M1-OSY-S-FDA	0122760	8	**Iron	098268646511	1	1456	23,140.00
	LF909M1-OSY-S-FDA	0124337	10	**Iron	098268830903	1	2645	31,548.00

Iron Body With FDA Epoxy-Coated Quarter-Turn Ball Valve Shutoffs

LEAD FREE*	LF909-QT-FDA	0122777	2 1/2	**Iron	098268646696	1	227	7,427.00
	LF909-QT-FDA	0122779	3	**Iron	098268646719	1	250	8,447.00
	LF909-QT-FDA	0122781	4	**Iron	098268646733	1	477	10,559.00
	LF909-QT-FDA	0122783	6	**Iron	098268646757	1	864	15,346.00

With Epoxy-Coated Quarter-Turn Ball Valve Shutoffs and Strainer

LEAD FREE*	LF909-QT-S-FDA	0122778	2 1/2	**Iron	098268646702	1	326	7,895.00
	LF909-QT-S-FDA	0122780	3	**Iron	098268646726	1	343	8,940.00
	LF909-QT-S-FDA	0122782	4	**Iron	098268646740	1	595	11,315.00
	LF909-QT-S-FDA	0122784	6	**Iron	098268646764	1	935	16,766.00

Less Shutoff Valves

LEAD FREE*	LF909-LF	0792188	2 1/2	**Iron	098268437706	1	114	3,869.00
	LF909-LF	0792189	3	**Iron	098268437713	1	114	4,400.00
	LF909-LF	0792190	4	**Iron	098268437720	1	375	5,500.00
	LF909-LF	0792191	6	**Iron	098268437737	1	466	7,993.00
	LF909M1-LF	0792192	8	**Iron	098268437744	1	836	13,367.00
	LF909M1-LF	0792193	10	**Iron	098268437751	1	1246	17,705.00

*FDA fused epoxy coated cast iron body.

*The wetted surface of this product contacted by consumable water contains less than 0.25% of lead by weight.

Consult factory for ordering code numbers of special models/options.

Reduced Pressure Zone Assemblies

Model	Ordering Code	Size (in.)	Body	UPC	Qty. Per Carton	Weight Per Carton (lbs.)	List Price (each)
-------	---------------	------------	------	-----	-----------------	--------------------------	-------------------

Series 994

With NRS Resilient Seated Shutoff Valves

LEAD FREE*	994-NRS	0437800	2 1/2	S.S.	098268882926	1	148	\$ 3,421.00
	994-NRS	0437804	3	S.S.	098268882964	1	226	3,863.00
	994-NRS	0438048	4	S.S.	098268795936	1	410	4,423.00
	994-NRS	0438056	6	S.S.	098268795707	1	380	7,043.00
	994-NRS	0438064	8	S.S.	098268795790	1	571	12,332.00
	994-NRS	0438072	10	S.S.	098268795844	1	773	16,389.00

With OSY Resilient Seated Shutoff Valves

LEAD FREE*	994-OSY	0437801	2 1/2	S.S.	098268882933	1	148	3,656.00
	994-OSY	0437805	3	S.S.	098268882971	1	226	4,251.00
	994-OSY	0438049	4	S.S.	098268795981	1	350	4,702.00
	994-OSY	0438057	6	S.S.	098268795677	1	425	7,483.00
	994-OSY	0438065	8	S.S.	098268795783	1	752	13,101.00
	994-OSY	0438073	10	S.S.	098268795868	1	805	17,855.00

With OSY Resilient Seated Shutoff Valves (Grooved Inlet x Flanged Outlet)

LEAD FREE*	994-OSY-GxF	0438601	2 1/2	S.S.	098268263558	1	148	3,656.00
	994-OSY-GxF	0438604	3	S.S.	098268263589	1	226	4,251.00
	994-OSY-GxF	0438607	4	S.S.	098268263619	1	250	4,702.00
	994-OSY-GxF	0438610	6	S.S.	098268263640	1	380	7,483.00
	994-OSY-GxF	0438613	8	S.S.	098268263671	1	571	13,101.00
	994-OSY-GxF	0438616	10	S.S.	098268263701	1	773	17,855.00

With OSY Resilient Seated Shutoff Valves (Flanged Inlet x Grooved Outlet)

LEAD FREE*	994-OSY-FxG	0438602	2 1/2	S.S.	098268263565	1	148	3,656.00
	994-OSY-FxG	0438605	3	S.S.	098268263596	1	226	4,251.00
	994-OSY-FxG	0438608	4	S.S.	098268263626	1	250	4,702.00
	994-OSY-FxG	0438611	6	S.S.	098268263657	1	380	7,483.00
	994-OSY-FxG	0438614	8	S.S.	098268263688	1	571	13,101.00
	994-OSY-FxG	0438617	10	S.S.	098268263718	1	773	17,855.00

Less Shutoff Valves

LEAD FREE*	994-LF	0437802	2 1/2	S.S.	098268882940	1	60	2,694.00
	994-LF	0437806	3	S.S.	098268882988	1	53	3,064.00
	994-LF	0438050	4	S.S.	098268795929	1	65	3,610.00
	994-LF	0438058	6	S.S.	098268795684	1	110	5,831.00
	994-LF	0438066	8	S.S.	098268795820	1	179	10,324.00
	994-LF	0438074	10	S.S.	098268795899	1	189	13,413.00

Portable Hydrant Backflow

994BLT	0437815	2 1/2 - 3	S.S.	098268262230	1	122	3,408.00
--------	---------	-----------	------	--------------	---	-----	----------

Hydrant Meter Backflow

994HMB-GPM	0437808	3	S.S.	098268923391	1	140	7,900.00
994HMB-CFM	0437809	3	S.S.	098268262223	1	140	7,900.00



994-OSY

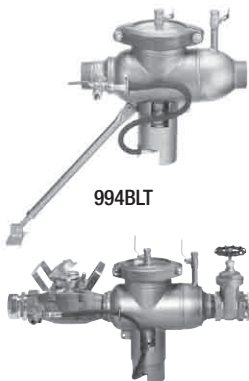

994BLT

994HMB

*FDA fused epoxy coated cast iron body.

*The wetted surface of this product contacted by consumable water contains less than 0.25% of lead by weight.

Consult factory for ordering code numbers of special models/options.

Reduced Pressure Zone Assemblies

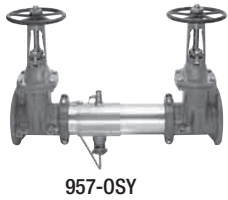

Model	Ordering Code	Size (in.)	Body	UPC	Qty. Per Carton	Weight Per Carton (lbs.)	List Price (each)
-------	---------------	------------	------	-----	-----------------	--------------------------	-------------------

Series 957

With OSY Resilient Seated Shutoff Valves

LEAD FREE*	Model	Ordering Code	Size (in.)	Body	UPC	Qty. Per Carton	Weight Per Carton (lbs.)	List Price (each)
	957-OSY	0111584	2 1/2	S.S.	098268121971	1	225	\$ 3,160.00
	957-OSY	0111585	3	S.S.	098268121988	1	233	3,532.00
	957-OSY	0111586	4	S.S.	098268122008	1	265	3,908.00
	957-OSY	0111587	6	S.S.	098268122152	1	420	6,220.00
	957-OSY	0111588	8	S.S.	098268122169	1	633	10,801.00
	957-OSY	0111589	10	S.S.	098268122176	1	924	13,260.00

N-Pattern with OSY Resilient Seated Shutoff Valves

LEAD FREE*	Model	Ordering Code	Size (in.)	Body	UPC	Qty. Per Carton	Weight Per Carton (lbs.)	List Price (each)
	957N-OSY	0111590	2 1/2	S.S.	098268122183	1	186	4,243.00
	957N-OSY	0111591	3	S.S.	098268122190	1	211	4,634.00
	957N-OSY	0111592	4	S.S.	098268122220	1	300	5,636.00
	957N-OSY	0111593	6	S.S.	098268122237	1	520	9,097.00
	957N-OSY	0111594	8	S.S.	098268122244	1	709	13,901.00
	957N-OSY	0111595	10	S.S.	098268122251	1	1091	16,479.00

Z-Pattern with OSY Resilient Seated Shutoff Valves

LEAD FREE*	Model	Ordering Code	Size (in.)	Body	UPC	Qty. Per Carton	Weight Per Carton (lbs.)	List Price (each)
	957Z-OSY	0111596	2 1/2	S.S.	098268122268	1	186	4,243.00
	957Z-OSY	0111597	3	S.S.	098268122275	1	211	4,634.00
	957Z-OSY	0111598	4	S.S.	098268122282	1	252	5,636.00
	957Z-OSY	0111599	6	S.S.	098268122299	1	449	9,097.00
	957Z-OSY	0111600	8	S.S.	098268122367	1	709	13,901.00
	957Z-OSY	0111601	10	S.S.	098268122435	1	1091	16,479.00

With NRS Resilient Seated Shutoff Valves

LEAD FREE*	Model	Ordering Code	Size (in.)	Body	UPC	Qty. Per Carton	Weight Per Carton (lbs.)	List Price (each)
	957-NRS	0111602	2 1/2	S.S.	098268122459	1	211	2,620.00
	957-NRS	0111603	3	S.S.	098268122534	1	225	3,207.00
	957-NRS	0111604	4	S.S.	098268122541	1	264	3,671.00
	957-NRS	0111605	6	S.S.	098268122626	1	402	5,844.00
	957-NRS	0111606	8	S.S.	098268122657	1	645	10,419.00
	957-NRS	0111607	10	S.S.	098268122701	1	1131	12,654.00

N-Pattern with NRS Resilient Seated Shutoff Valves

LEAD FREE*	Model	Ordering Code	Size (in.)	Body	UPC	Qty. Per Carton	Weight Per Carton (lbs.)	List Price (each)
	957N-NRS	0111608	2 1/2	S.S.	098268122732	1	176	2,884.00
	957N-NRS	0111609	3	S.S.	098268122749	1	235	3,368.00
	957N-NRS	0111610	4	S.S.	098268122985	1	275	4,233.00
	957N-NRS	0111611	6	S.S.	098268123319	1	427	6,838.00
	957N-NRS	0111612	8	S.S.	098268123449	1	667	9,026.00
	957N-NRS	0111613	10	S.S.	098268123494	1	1093	10,962.00

Z-Pattern with NRS Resilient Seated Shutoff Valves

LEAD FREE*	Model	Ordering Code	Size (in.)	Body	UPC	Qty. Per Carton	Weight Per Carton (lbs.)	List Price (each)
	957Z-NRS	0111614	2 1/2	S.S.	098268123531	1	176	2,884.00
	957Z-NRS	0111615	3	S.S.	098268123548	1	240	3,368.00
	957Z-NRS	0111616	4	S.S.	098268123555	1	270	4,233.00
	957Z-NRS	0111617	6	S.S.	098268123562	1	427	6,838.00
	957Z-NRS	0111618	8	S.S.	098268123579	1	667	9,026.00
	957Z-NRS	0111619	10	S.S.	098268123586	1	1093	10,962.00

With NRS Resilient Seated Shutoff Valves and Cast Iron Strainer

LEAD FREE*	Model	Ordering Code	Size (in.)	Body	UPC	Qty. Per Carton	Weight Per Carton (lbs.)	List Price (each)
	957-NRS-S	0111825	2 1/2	S.S.	098268260137	1	176	2,382.00
	957-NRS-S	0111826	3	S.S.	098268260144	1	297	2,906.00
	957-NRS-S	0111827	4	S.S.	098268260175	1	399	3,530.00
	957-NRS-S	0111828	6	S.S.	098268260182	1	427	5,775.00
	957-NRS-S	0111829	8	S.S.	098268260199	1	667	10,199.00
	957-NRS-S	0111830	10	S.S.	098268260212	1	1093	13,195.00

*The wetted surface of this product contacted by consumable water contains less than 0.25% of lead by weight.

Consult factory for ordering code numbers of special models/options.

Reduced Pressure Zone Assemblies

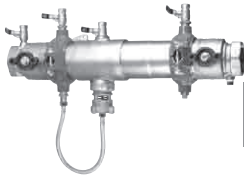

957-QT

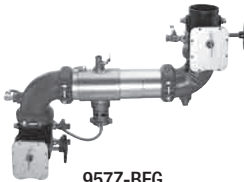

957Z-BFG

Model	Ordering Code	Size (in.)	Body	UPC	Qty. Per Carton	Weight Per Carton (lbs.)	List Price (each)
-------	---------------	------------	------	-----	-----------------	--------------------------	-------------------

Series 957 (cont.)

With Quarter-Turn Ball Valve Shutoffs

LEAD FREE	957-QT	0111760	2 1/2	S.S.	098268300635	1	64	\$ 2,752.00
LEAD FREE	957-QT	0111761	3	S.S.	098268336689	1	60	3,367.00

N-Pattern with Quarter-Turn Ball Valve Shutoffs

LEAD FREE	957N-QT	0111668	2 1/2	S.S.	098268124750	1	118	3,671.00
LEAD FREE	957N-QT	0111669	3	S.S.	098268124767	1	120	4,287.00

Z-Pattern with Quarter-Turn Ball Valve Shutoffs

LEAD FREE	957Z-QT	0111777	2 1/2	S.S.	098268126211	1	118	3,671.00
LEAD FREE	957Z-QT	0111778	3	S.S.	098268126228	1	120	4,287.00

N-Pattern with UL/FM Butterfly Valve Shutoffs (Gear Operated)

LEAD FREE	957N-BFG	0111780	2 1/2	S.S.	098268126242	1	118	4,667.00
LEAD FREE	957N-BFG	0111781	3	S.S.	098268126259	1	92	5,098.00
LEAD FREE	957N-BFG	0111782	4	S.S.	098268126266	1	135	6,200.00
LEAD FREE	957N-BFG	0111783	6	S.S.	098268126273	1	271	10,007.00

Z-Pattern with UL/FM Butterfly Valve Shutoffs (Gear Operated)

LEAD FREE	957Z-BFG	0111784	2 1/2	S.S.	098268126280	1	90	4,667.00
LEAD FREE	957Z-BFG	0111785	3	S.S.	098268126297	1	87	5,098.00
LEAD FREE	957Z-BFG	0111786	4	S.S.	098268126303	1	98	6,200.00
LEAD FREE	957Z-BFG	0111787	6	S.S.	098268126310	1	300	10,007.00

*The wetted surface of this product contacted by consumable water contains less than 0.25% of lead by weight.

Consult factory for ordering code numbers of special models/options.

Double Check Detector Assemblies

4

Backflow Preventers & Accessories

DCDA – Standard shut-offs are resilient seated outside stem and yoke (OSY), UL/FM listed

Model	Ordering Code	Size (in.)	Body	UPC	Qty. Per Carton	Weight Per Carton (lbs.)	List Price (each)
-------	---------------	------------	------	-----	-----------------	--------------------------	-------------------

Series 007DCDA

Less Shutoffs – CFM/GPM Meter

007M1DCDA-LF-CFM	0062727	2	Bronze	098268573121	1	88	\$ 3,590.00
007DCDA-LF-CFM	0062516	2 1/2	**Iron	098268489279	1	170	6,911.00
007DCDA-LF-CFM	0062518	3	**Iron	098268489293	1	200	7,209.00
007M1DCDA-LF-GPM	0062728	2	Bronze	098268573138	1	88	3,590.00
007DCDA-LF-GPM	0062515	2 1/2	**Iron	098268488104	1	170	6,911.00
007DCDA-LF-GPM	0062517	3	**Iron	098268489286	1	200	7,209.00

With OSY Shutoffs – CFM/GPM Meter

007M1DCDA-OSY-CFM	0062725	2	†Bronze	098268573107	1	141	4,500.00
007DCDA0SY-CFM	0062511	2 1/2	**Iron	098268316827	1	179	5,359.00
007DCDA0SY-CFM	0062513	3	**Iron	098268316803	1	211	5,663.00
007M1DCDA-OSY-GPM	0062726	2	†Bronze	098268574883	1	155	4,500.00
007DCDA0SY-GPM	0062510	2 1/2	**Iron	098268316834	1	179	5,359.00
007DCDA0SY-GPM	0062512	3	**Iron	098268573114	1	211	5,663.00

Series 709DCDA

Less Shutoffs – CFM/GPM Meter

709DCDA-LF-CFM	0384741	3	**Iron	098268278187	1	150	3,575.00
709DCDA-LF-CFM	0384815	4	**Iron	098268021394	1	320	3,793.00
709DCDA-LF-CFM	0384816	6	**Iron	098268021400	1	450	6,261.00
709DCDA-LF-CFM	0384817	8	**Iron	098268021417	1	946	13,337.00
709DCDA-LF-CFM	0384818	10	**Iron	098268021424	1	1332	17,223.00
709DCDA-LF-GPM	0384740	3	**Iron	098268278170	1	150	3,575.00
709DCDA-LF-GPM	0384662	4	**Iron	098268021035	1	320	3,793.00
709DCDA-LF-GPM	0384666	6	**Iron	098268021042	1	450	6,261.00
709DCDA-LF-GPM	0387064	8	**Iron	098268023824	1	794	13,337.00
709DCDA-LF-GPM	0387068	10	**Iron	098268023862	1	1332	17,223.00

With OSY Shutoffs – CFM/GPM Meter

709DCDA-OSY-CFM	0387052	3	**Iron	098268023725	1	327	5,719.00
709DCDA-OSY-CFM	0387058	4	**Iron	098268023770	1	522	6,068.00
709DCDA-OSY-CFM	0387069	6	**Iron	098268023879	1	893	8,903.00
709DCDA-OSY-CFM	0387088	8	**Iron	098268024005	1	1512	17,387.00
709DCDA-OSY-CFM	0387090	10	**Iron	098268024029	1	2332	22,454.00
709DCDA-OSY-GPM	0387745	3	**Iron	098268025408	1	327	5,719.00
709DCDA-OSY-GPM	0385680	4	**Iron	098268022216	1	500	6,068.00
709DCDA-OSY-GPM	0387082	6	**Iron	098268023961	1	893	8,903.00
709DCDA-OSY-GPM	0387070	8	**Iron	098268023886	1	1329	17,387.00
709DCDA-OSY-GPM	0387092	10	**Iron	098268080940	1	2299	22,454.00

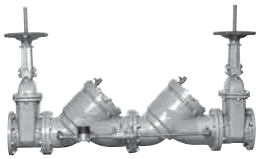

709DCDA OSY

**FDA fused epoxy coated cast iron body.

† Bronze body with epoxy coated cast iron OSY gate valves.

*The wetted surface of this product contacted by consumable water contains less than 0.25% of lead by weight.

Consult factory for ordering code numbers of special models/options.

Double Check Detector Assemblies

Model	Ordering Code	Size (in.)	Body	UPC	Qty. Per Carton	Weight Per Carton (lbs.)	List Price (each)
-------	---------------	------------	------	-----	-----------------	--------------------------	-------------------

Series 774DCDA

Less Shutoffs – CFM/GPM Meter

Standard shutoffs are resilient seated outside stem and yoke (OSY), UL/FM listed

774DCDA-LF-CFM	0437706	2 1/2	S.S.	098268878059	1	68	\$ 2,791.00
774DCDA-LF-CFM	0437714	3	S.S.	098268878127	1	70	3,433.00
774DCDA-LF-CFM	0438006	4	S.S.	098268795387	1	73	3,663.00
774DCDA-LF-CFM	0438014	6	S.S.	098268795547	1	102	4,324.00
774DCDA-LF-CFM	0438030	8	S.S.	098268795479	1	190	8,047.00
774DCDA-LF-CFM	0438046	10	S.S.	098268795622	1	275	10,356.00
774DCDA-LF-CFM	0438086	12	S.S.	098268877397	1	220	13,774.00
774DCDA-LF-GPM	0437707	2 1/2	S.S.	098268878066	1	68	2,791.00
774DCDA-LF-GPM	0437715	3	S.S.	098268878134	1	70	3,433.00
774DCDA-LF-GPM	0438007	4	S.S.	098268795356	1	73	3,663.00
774DCDA-LF-GPM	0438015	6	S.S.	098268795554	1	92	4,324.00
774DCDA-LF-GPM	0438031	8	S.S.	098268795455	1	275	8,047.00
774DCDA-LF-GPM	0438047	10	S.S.	098268795639	1	190	10,356.00
774DCDA-LF-GPM	0438087	12	S.S.	098268877403	1	220	13,774.00

With OSY Shutoffs – CFM/GPM Meter

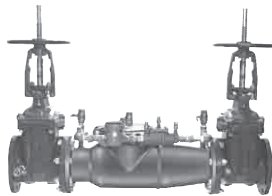

774DCDA-OSY

774DCDA-OSY-CFM	0437704	2 1/2	S.S.	098268878035	1	155	3,708.00
774DCDA-OSY-CFM	0437712	3	S.S.	098268878103	1	230	4,512.00
774DCDA-OSY-CFM	0438004	4	S.S.	098268795394	1	344	4,896.00
774DCDA-OSY-CFM	0438012	6	S.S.	098268795530	1	535	5,858.00
774DCDA-OSY-CFM	0438028	8	S.S.	098268795448	1	754	10,589.00
774DCDA-OSY-CFM	0438044	10	S.S.	098268795592	1	1156	14,471.00
774DCDA-OSY-CFM	0438084	12	S.S.	098268877373	1	1520	19,511.00
774DCDA-OSY-GPM	0437705	2 1/2	S.S.	098268878042	1	155	3,708.00
774DCDA-OSY-GPM	0437713	3	S.S.	098268878110	1	230	4,512.00
774DCDA-OSY-GPM	0438005	4	S.S.	098268795363	1	344	4,896.00
774DCDA-OSY-GPM	0438013	6	S.S.	098268795578	1	535	5,858.00
774DCDA-OSY-GPM	0438029	8	S.S.	098268795462	1	754	10,589.00
774DCDA-OSY-GPM	0438045	10	S.S.	098268795646	1	1156	14,471.00
774DCDA-OSY-GPM	0438085	12	S.S.	098268877380	1	1520	19,511.00

Less Shutoffs and Less Meter

774DCDA-LF-LM	0438130	2 1/2	S.S.	098268262247	1	68	2,730.00
774DCDA-LF-LM	0438131	3	S.S.	098268262254	1	70	3,371.00
774DCDA-LF-LM	0438132	4	S.S.	098268262261	1	65	3,601.00
774DCDA-LF-LM	0438133	6	S.S.	098268262278	1	105	4,262.00
774DCDA-LF-LM	0438134	8	S.S.	098268262285	1	190	7,986.00
774DCDA-LF-LM	0438135	10	S.S.	098268262292	1	275	10,293.00
774DCDA-LF-LM	0438136	12	S.S.	098268262308	1	225	13,712.00

With OSY Shutoffs and Less Meter

774DCDA-OSY-LM	0438137	2 1/2	S.S.	098268262315	1	155	3,646.00
774DCDA-OSY-LM	0438138	3	S.S.	098268262322	1	230	4,450.00
774DCDA-OSY-LM	0438139	4	S.S.	098268262339	1	350	4,834.00
774DCDA-OSY-LM	0438140	6	S.S.	098268262346	1	535	5,798.00
774DCDA-OSY-LM	0438141	8	S.S.	098268262353	1	765	10,528.00
774DCDA-OSY-LM	0438142	10	S.S.	098268262360	1	1156	14,410.00
774DCDA-OSY-LM	0438143	12	S.S.	098268262377	1	1520	19,449.00

*The wetted surface of this product contacted by consumable water contains less than 0.25% of lead by weight.

Consult factory for ordering code numbers of special models/options.

Double Check Detector Assemblies

4

Backflow Preventers & Accessories

Model	Ordering Code	Size (in.)	Body	UPC	Qty. Per Carton	Weight Per Carton (lbs.)	List Price (each)
-------	---------------	------------	------	-----	-----------------	--------------------------	-------------------

Series 774DCDA

With OSY Resilient Seated Shutoff Valves (Grooved Inlet x Flanged Outlet) — CFM/GPM Meter

774DCDA-OSY-GxF-CFM	0439521	2 1/2	S.S.	098268264302	1	155	\$ 3,708.00
774DCDA-OSY-GxF-CFM	0439527	3	S.S.	098268264371	1	230	4,512.00
774DCDA-OSY-GxF-CFM	0439533	4	S.S.	098268264432	1	280	4,896.00
774DCDA-OSY-GxF-CFM	0439539	6	S.S.	098268264494	1	435	5,858.00
774DCDA-OSY-GxF-CFM	0439545	8	S.S.	098268264555	1	760	10,589.00
774DCDA-OSY-GxF-CFM	0439551	10	S.S.	098268264616	1	774	14,471.00
774DCDA-OSY-GxF-GPM	0439524	2 1/2	S.S.	098268264340	1	155	3,708.00
774DCDA-OSY-GxF-GPM	0439530	3	S.S.	098268264401	1	230	4,512.00
774DCDA-OSY-GxF-GPM	0439536	4	S.S.	098268264463	1	280	4,896.00
774DCDA-OSY-GxF-GPM	0439542	6	S.S.	098268264524	1	435	5,858.00
774DCDA-OSY-GxF-GPM	0439548	8	S.S.	098268264586	1	760	10,589.00
774DCDA-OSY-GxF-GPM	0439554	10	S.S.	098268264647	1	774	14,471.00

With OSY Resilient Seated Shutoff Valves (Flanged Inlet x Grooved Outlet) — CFM/GPM Meter

774DCDA-OSY-FxG-CFM	0439522	2 1/2	S.S.	098268264319	1	155	3,708.00
774DCDA-OSY-FxG-CFM	0439528	3	S.S.	098268264388	1	230	4,512.00
774DCDA-OSY-FxG-CFM	0439534	4	S.S.	098268264449	1	280	4,896.00
774DCDA-OSY-FxG-CFM	0439540	6	S.S.	098268264500	1	435	5,858.00
774DCDA-OSY-FxG-CFM	0439546	8	S.S.	098268264562	1	760	10,589.00
774DCDA-OSY-FxG-CFM	0439552	10	S.S.	098268264623	1	774	14,471.00
774DCDA-OSY-FxG-GPM	0439525	2 1/2	S.S.	098268264357	1	155	3,708.00
774DCDA-OSY-FxG-GPM	0439531	3	S.S.	098268264418	1	230	4,512.00
774DCDA-OSY-FxG-GPM	0439537	4	S.S.	098268264470	1	280	4,896.00
774DCDA-OSY-FxG-GPM	0439543	6	S.S.	098268264531	1	435	5,858.00
774DCDA-OSY-FxG-GPM	0439549	8	S.S.	098268264593	1	760	10,589.00
774DCDA-OSY-FxG-GPM	0439555	10	S.S.	098268264654	1	774	14,471.00

*The wetted surface of this product contacted by consumable water contains less than 0.25% of lead by weight.

Consult factory for ordering code numbers of special models/options.

Double Check Detector Assemblies

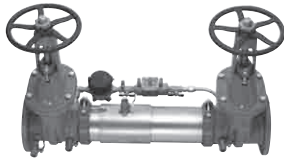

757DCDA OSY

Model	Ordering Code	Size (in.)	Body	UPC	Qty. Per Carton	Weight Per Carton (lbs.)	List Price (each)
-------	---------------	------------	------	-----	-----------------	--------------------------	-------------------

Series 757DCDA

With OSY Resilient Seated Shutoff Valves — CFM/GPM Meter

	757DCDA-OSY-CFM	0111544	2 1/2	S.S.	098268120783	1	189	\$ 3,566.00
	757DCDA-OSY-CFM	0111545	3	S.S.	098268120790	1	210	3,799.00
	757DCDA-OSY-CFM	0111546	4	S.S.	098268120806	1	271	4,038.00
	757DCDA-OSY-CFM	0111547	6	S.S.	098268120813	1	438	5,242.00
	757DCDA-OSY-CFM	0111548	8	S.S.	098268120936	1	610	9,473.00
	757DCDA-OSY-CFM	0111549	10	S.S.	098268121193	1	936	11,159.00
LEAD FREE*	LF757DCDA-OSY-CFM	0122709	2 1/2		098268643619	1	189	3,834.00
	LF757DCDA-OSY-CFM	0122710	3		098268643626	1	210	4,085.00
	LF757DCDA-OSY-CFM	0122711	4		098268643985	1	271	4,340.00
	LF757DCDA-OSY-CFM	0122712	6		098268643992	1	438	5,635.00
	LF757DCDA-OSY-CFM	0122713	8		098268644005	1	610	10,184.00
	LF757DCDA-OSY-CFM	0124693	10		098268840605	1	936	11,995.00
	757DCDA-OSY-GPM	0111550	2 1/2	S.S.	098268121247	1	189	3,566.00
	757DCDA-OSY-GPM	0111551	3	S.S.	098268121254	1	210	3,799.00
	757DCDA-OSY-GPM	0111552	4	S.S.	098268121261	1	284	4,038.00
	757DCDA-OSY-GPM	0111553	6	S.S.	098268121278	1	415	5,242.00
	757DCDA-OSY-GPM	0111554	8	S.S.	098268121360	1	630	9,473.00
	757DCDA-OSY-GPM	0111555	10	S.S.	098268121377	1	936	11,159.00
LEAD FREE*	LF757DCDA-OSY-GPM	0122714	2 1/2		098268644012	1	189	3,834.00
	LF757DCDA-OSY-GPM	0122715	3		098268644029	1	210	4,085.00
	LF757DCDA-OSY-GPM	0122716	4		098268644050	1	284	4,340.00
	LF757DCDA-OSY-GPM	0122717	6		098268644067	1	415	5,635.00
	LF757DCDA-OSY-GPM	0122718	8		098268644081	1	630	10,184.00
	LF757DCDA-OSY-GPM	0124694	10		098268840612	1	936	11,995.00
N-Pattern with OSY Resilient Seated Shutoff Valves — CFM/GPM Meter								
	757N-DCDA-OSY-CFM	0111556	2 1/2	S.S.	098268121407	1	197	4,651.00
	757N-DCDA-OSY-CFM	0111557	3	S.S.	098268121414	1	222	4,896.00
	757N-DCDA-OSY-CFM	0111558	4	S.S.	098268121421	1	263	5,728.00
	757N-DCDA-OSY-CFM	0111559	6	S.S.	098268121438	1	460	7,956.00
	757N-DCDA-OSY-CFM	0111560	8	S.S.	098268121445	1	720	13,567.00
	757N-DCDA-OSY-CFM	0111561	10	S.S.	098268121452	1	1106	15,337.00
LEAD FREE*	LF757NDCDA-OSY-CFM	0792284	2 1/2		098268439151	1	197	5,650.00
	LF757NDCDA-OSY-CFM	0792285	3		098268439168	1	222	5,946.00
	LF757NDCDA-OSY-CFM	0792286	4		098268439175	1	263	6,957.00
	LF757NDCDA-OSY-CFM	0792287	6		098268439182	1	460	9,666.00
	LF757NDCDA-OSY-CFM	0792288	8		098268439199	1	490	14,586.00
	LF757NDCDA-OSY-CFM	0792289	10		098268439205	1	1165	16,488.00
	757N-DCDA-OSY-GPM	0111562	2 1/2	S.S.	098268121469	1	197	4,651.00
	757N-DCDA-OSY-GPM	0111563	3	S.S.	098268121490	1	222	4,896.00
	757N-DCDA-OSY-GPM	0111564	4	S.S.	098268121506	1	263	5,728.00
	757N-DCDA-OSY-GPM	0111565	6	S.S.	098268121513	1	460	7,956.00
	757N-DCDA-OSY-GPM	0111566	8	S.S.	098268121520	1	720	13,567.00
	757N-DCDA-OSY-GPM	0111567	10	S.S.	098268121568	1	1106	15,337.00
LEAD FREE*	LF757NDCDA-DOSY-GPM	0792290	2 1/2		098268439212	1	197	5,650.00
	LF757NDCDA-DOSY-GPM	0792291	3		098268439229	1	222	5,946.00
	LF757NDCDA-DOSY-GPM	0792292	4		098268439236	1	263	6,957.00
	LF757NDCDA-DOSY-GPM	0792293	6		098268439243	1	460	9,666.00
	LF757NDCDA-DOSY-GPM	0792294	8		098268439250	1	694	14,586.00
	LF757NDCDA-DOSY-GPM	0792295	10		098268439267	1	720	16,488.00

*The wetted surface of this product contacted by consumable water contains less than 0.25% of lead by weight.

Consult factory for ordering code numbers of special models/options.

Double Check Detector Assemblies

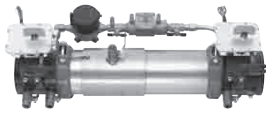

757DCDA BFG

Model	Ordering Code	Size (in.)	Body	UPC	Qty. Per Carton	Weight Per Carton (lbs.)	List Price (each)
-------	---------------	------------	------	-----	-----------------	--------------------------	-------------------

Series 757DCDA (cont.)

With UL/FM Butterfly Valves Shutoffs — CFM/GPM Meter

	757DCDA-BFG-CFM	0111568	2 1/2	S.S.	098268121575	1	89	\$ 3,791.00
	757DCDA-BFG-CFM	0111569	3	S.S.	098268121582	1	55	4,023.00
	757DCDA-BFG-CFM	0111570	4	S.S.	098268121773	1	85	4,261.00
	757DCDA-BFG-CFM	0111571	6	S.S.	098268121780	1	248	5,472.00
	757DCDA-BFG-CFM	0111747	8	S.S.	098268125771	1	426	9,704.00
LEAD FREE*	LF757DCDA-BFG-CFM	0122729	2 1/2		098268644364	1	225	3,062.00
	LF757DCDA-BFG-CFM	0122730	3		098268644371	1	240	3,408.00
	LF757DCDA-BFG-CFM	0122731	4		098268644388	1	265	4,474.00
	LF757DCDA-BFG-CFM	0122732	6		098268644425	1	420	6,476.00
	LF757DCDA-BFG-CFM	0124719	8		098268841244	1	426	10,433.00
	757DCDA-BFG-GPM	0111572	2 1/2	S.S.	098268121810	1	69	3,791.00
	757DCDA-BFG-GPM	0111573	3	S.S.	098268121827	1	68	4,023.00
	757DCDA-BFG-GPM	0111574	4	S.S.	098268121834	1	84	4,261.00
	757DCDA-BFG-GPM	0111575	6	S.S.	098268121841	1	141	5,472.00
	757DCDA-BFG-GPM	0111748	8	S.S.	098268125788	1	426	9,704.00
LEAD FREE*	LF757DCDA-BFG-GPM	0122734	2 1/2		098268644814	1	924	12,539.00
	LF757DCDA-BFG-GPM	0122735	3		098268644838	1	225	3,540.00
	LF757DCDA-BFG-GPM	0122736	4		098268644845	1	225	3,930.00
	LF757DCDA-BFG-GPM	0122737	6		098268644852	1	265	5,134.00
	LF757DCDA-BFG-GPM	0124720	8		098268841251	1	426	10,433.00

N-Pattern with UL/FM Butterfly Valves Shutoffs — CFM/GPM Meter

	757N-DCDA-BFG-CFM	0111576	2 1/2	S.S.	098268121858	1	129	4,885.00
	757N-DCDA-BFG-CFM	0111577	3	S.S.	098268121889	1	131	5,130.00
	757N-DCDA-BFG-CFM	0111578	4	S.S.	098268121919	1	163	5,963.00
	757N-DCDA-BFG-CFM	0111579	6	S.S.	098268121926	1	282	8,198.00
	757N-DCDA-BFG-CFM	0111749	8	S.S.	098268125917	1	501	13,810.00
	757N-DCDA-BFG-GPM	0111580	2 1/2	S.S.	098268121933	1	129	4,885.00
	757N-DCDA-BFG-GPM	0111581	3	S.S.	098268121940	1	131	5,130.00
	757N-DCDA-BFG-GPM	0111582	4	S.S.	098268121957	1	163	5,963.00
	757N-DCDA-BFG-GPM	0111583	6	S.S.	098268121964	1	282	8,198.00
	757N-DCDA-BFG-GPM	0111750	8	S.S.	098268125924	1	501	13,810.00

*The wetted surface of this product contacted by consumable water contains less than 0.25% of lead by weight.

Consult factory for ordering code numbers of special models/options.

Double Check Detector Assemblies

Model	Ordering Code	Size (in.)	Body	UPC	Qty. Per Carton	Weight Per Carton (lbs.)	List Price (each)
-------	---------------	------------	------	-----	-----------------	--------------------------	-------------------

Series 757DCDA (cont.)

With OSY Resilient Seated Shutoff Valves - Less Meter

757DCDA-OSY-LM	0111837	2 1/2	S.S.	098268260304	1	129	\$ 3,495.00
757DCDA-OSY-LM	0111838	3	S.S.	098268260311	1	131	3,728.00
757DCDA-OSY-LM	0111839	4	S.S.	098268260328	1	265	3,967.00
757DCDA-OSY-LM	0111840	6	S.S.	098268260335	1	420	5,170.00
757DCDA-OSY-LM	0111841	8	S.S.	098268260342	1	633	9,403.00
757DCDA-OSY-LM	0111842	10	S.S.	098268260359	1	924	11,087.00

N-Pattern with OSY Resilient Seated Shutoff Valves - Less Meter

757N-DCDA-OSY-LM	0111843	2 1/2	S.S.	098268260366	1	183	4,576.00
757N-DCDA-OSY-LM	0111844	3	S.S.	098268260472	1	206	4,820.00
757N-DCDA-OSY-LM	0111845	4	S.S.	098268260489	1	249	5,653.00
757N-DCDA-OSY-LM	0111846	6	S.S.	098268260496	1	556	7,883.00
757N-DCDA-OSY-LM	0111847	8	S.S.	098268260502	1	706	13,493.00
757N-DCDA-OSY-LM	0111848	10	S.S.	098268260519	1	924	15,262.00

With UL/FM Butterfly Valves Shutoffs - Less Meter

757DCDA-BFG-LM	0111849	2 1/2	S.S.	098268260526	1	89	3,721.00
757DCDA-BFG-LM	0111850	3	S.S.	098268260533	1	95	3,952.00
757DCDA-BFG-LM	0111851	4	S.S.	098268260540	1	103	4,191.00
757DCDA-BFG-LM	0111852	6	S.S.	098268260557	1	248	5,401.00
757DCDA-BFG-LM	0111853	8	S.S.	098268260564	1	426	9,632.00

N-Pattern with UL/FM Butterfly Valves Shutoffs - Less Meter

757N-DCDA-BFG-LM	0111854	2 1/2	S.S.	098268260571	1	129	4,812.00
757N-DCDA-BFG-LM	0111855	3	S.S.	098268260588	1	131	5,056.00
757N-DCDA-BFG-LM	0111856	4	S.S.	098268260595	1	103	5,888.00
757N-DCDA-BFG-LM	0111857	6	S.S.	098268260601	1	248	8,125.00
757N-DCDA-BFG-LM	0111858	8	S.S.	098268260618	1	426	13,735.00



Standard shutoffs are resilient seated outside stem and yoke (OSY), UL/FM listed

*The wetted surface of this product contacted by consumable water contains less than 0.25% of lead by weight.
Consult factory for ordering code numbers of special models/options.

Double Check Detector Assemblies

4

Backflow Preventers & Accessories

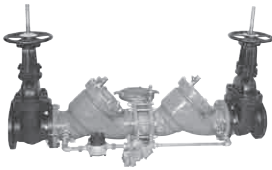

909RPDA

Model	Ordering Code	Size (in.)	Body	UPC	Qty. Per Carton	Weight Per Carton (lbs.)	List Price (each)
-------	---------------	------------	------	-----	-----------------	--------------------------	-------------------

Series 909RPDA

Standard shutoffs are resilient seated outside stem and yoke (OSY), UL/FM listed

909RPDA-OSY-CFM	0387453	2 1/2	**Iron	098268590227	1	250	\$ 6,808.00
909RPDA-OSY-CFM	0387456	3	**Iron	098268025064	1	250	7,743.00
909RPDA-OSY-CFM	0387461	4	**Iron	098268025088	1	490	9,679.00
909RPDA-OSY-CFM	0387466	6	**Iron	098268025101	1	951	14,068.00
909RPDA-OSY-CFM	0385610	8	**Iron	098268199703	1	1656	23,526.00
909RPDA-OSY-CFM	0385629	10	**Iron	098268199895	1	2250	31,158.00
909RPDA-OSY-GPM	0387454	2 1/2	**Iron	098268590579	1	250	6,808.00
909RPDA-OSY-GPM	0387480	3	**Iron	098268025156	1	250	7,743.00
909RPDA-OSY-GPM	0387486	4	**Iron	098268025170	1	597	9,679.00
909RPDA-OSY-GPM	0387491	6	**Iron	098268025194	1	820	14,068.00
909RPDA-OSY-GPM	0385612	8	**Iron	098268199727	1	1656	23,526.00
909RPDA-OSY-GPM	0385630	10	**Iron	098268199901	1	2250	31,158.00

Less Shutoffs

909RPDA-LF-CFM	0384743	3	**Iron	098268271461	1	162	5,499.00
909RPDA-LF-CFM	0387211	4	**Iron	098268024609	1	385	6,875.00
909RPDA-LF-CFM	0387212	6	**Iron	098268024616	1	819	9,991.00
909RPDA-LF-CFM	0385607	8	**Iron	098268199673	1	919	16,709.00
909RPDA-LF-CFM	0385624	10	**Iron	098268199840	1	1784	22,130.00
909RPDA-LF-GPM	0384742	3	**Iron	098268271478	1	162	5,499.00
909RPDA-LF-GPM	0387209	4	**Iron	098268024593	1	385	6,875.00
909RPDA-LF-GPM	0387216	6	**Iron	098268024647	1	534	9,991.00
909RPDA-LF-GPM	0385598	8	**Iron	098268199581	1	974	16,709.00
909RPDA-LF-GPM	0385626	10	**Iron	098268199864	1	1784	22,130.00

*The wetted surface of this product contacted by consumable water contains less than 0.25% of lead by weight.

Consult factory for ordering code numbers of special models/options.

Reduced Pressure Detector Assemblies

Model	Ordering Code	Size (in.)	Body	UPC	Qty. Per Carton	Weight Per Carton (lbs.)	List Price (each)
-------	---------------	------------	------	-----	-----------------	--------------------------	-------------------

Series 994RPDA

Less Shutoffs

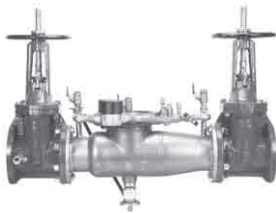

994RPDA

994RPDA-LF-CFM	0438246	2 1/2	S.S.	098268262421	1	76	\$ 3,506.00
994RPDA-LF-CFM	0438248	3	S.S.	098268262445	1	80	3,897.00
994RPDA-LF-CFM	0438054	4	S.S.	098268795974	1	75	4,458.00
994RPDA-LF-CFM	0438062	6	S.S.	098268795714	1	145	6,459.00
994RPDA-OSY-CFM	0438250	2 1/2	S.S.	098268262469	1	185	4,445.00
994RPDA-OSY-CFM	0438252	3	S.S.	098268262483	1	185	4,938.00
994RPDA-OSY-CFM	0438052	4	S.S.	098268795967	1	300	5,651.00
994RPDA-OSY-CFM	0438060	6	S.S.	098268795738	1	460	8,142.00
994RPDA-LF-GPM	0438247	2 1/2	S.S.	098268262438	1	76	3,506.00
994RPDA-LF-GPM	0438249	3	S.S.	098268262452	1	60	3,897.00
994RPDA-LF-GPM	0438055	4	S.S.	098268795943	1	95	4,458.00
994RPDA-LF-GPM	0438063	6	S.S.	098268795721	1	115	6,459.00
994RPDA-OSY-GPM	0438251	2 1/2	S.S.	098268262476	1	225	4,445.00
994RPDA-OSY-GPM	0438253	3	S.S.	098268262490	1	220	4,938.00
994RPDA-OSY-GPM	0438053	4	S.S.	098268795912	1	300	5,651.00
994RPDA-OSY-GPM	0438061	6	S.S.	098268795745	1	460	8,142.00

With OSY Resilient Seated Shutoff Valves (Grooved Inlet x Flanged Outlet)

994RPDA-OSY-GxF-CFM	0438619	2 1/2	S.S.	098268263732	1	170	4,445.00
994RPDA-OSY-GxF-CFM	0438625	3	S.S.	098268263794	1	205	4,938.00
994RPDA-OSY-GxF-CFM	0438631	4	S.S.	098268263954	1	270	5,651.00
994RPDA-OSY-GxF-CFM	0438637	6	S.S.	098268264050	1	405	8,142.00
994RPDA-OSY-GxF-GPM	0438622	2 1/2	S.S.	098268263763	1	170	4,445.00
994RPDA-OSY-GxF-GPM	0438628	3	S.S.	098268263824	1	205	4,938.00
994RPDA-OSY-GxF-GPM	0438634	4	S.S.	098268264029	1	270	5,651.00
994RPDA-OSY-GxF-GPM	0438640	6	S.S.	098268264081	1	405	8,142.00

With OSY Resilient Seated Shutoff Valves (Flanged Inlet x Grooved Outlet)

994RPDA-OSY-FxG-CFM	0438620	2 1/2	S.S.	098268263749	1	170	4,445.00
994RPDA-OSY-FxG-CFM	0438626	3	S.S.	098268263800	1	205	4,938.00
994RPDA-OSY-FxG-CFM	0438632	4	S.S.	098268263961	1	270	5,651.00
994RPDA-OSY-FxG-CFM	0438638	6	S.S.	098268264067	1	405	8,142.00
994RPDA-OSY-FxG-GPM	0438623	2 1/2	S.S.	098268263770	1	170	4,445.00
994RPDA-OSY-FxG-GPM	0438629	3	S.S.	098268263831	1	205	4,938.00
994RPDA-OSY-FxG-GPM	0438635	4	S.S.	098268264036	1	270	5,651.00
994RPDA-OSY-FxG-GPM	0438641	6	S.S.	098268264098	1	405	8,142.00

**FDA fused epoxy coated cast iron body.

*The wetted surface of this product contacted by consumable water contains less than 0.25% of lead by weight.

Consult factory for ordering code numbers of special models/options.

Reduced Pressure Detector Assemblies

4

Backflow Preventers & Accessories

Standard shutoffs are resilient seated outside stem and yoke (OSY), UL/FM listed

Model	Ordering Code	Size (in.)	Body	UPC	Qty. Per Carton	Weight Per Carton (lbs.)	List Price (each)
-------	---------------	------------	------	-----	-----------------	--------------------------	-------------------

Series 957RPDA

With OSY Resilient Seated Shutoff Valves

	957RPDA-OSY-CFM	0111620	2 1/2	S.S.	098268123593	1	192	\$ 2,955.00
	957RPDA-OSY-CFM	0111621	3	S.S.	098268123609	1	213	3,281.00
	957RPDA-OSY-CFM	0111622	4	S.S.	098268123616	1	278	4,287.00
	957RPDA-OSY-CFM	0111623	6	S.S.	098268123623	1	448	6,175.00
	957RPDA-OSY-CFM	0111624	8	S.S.	098268123777	1	647	10,174.00
	957RPDA-OSY-CFM	0111625	10	S.S.	098268123814	1	997	11,895.00
LEAD FREE*	LF957RPDA-OSY-CFM	0122719	2 1/2	S.S.	098268644098	1	192	3,133.00
	LF957RPDA-OSY-CFM	0122720	3	S.S.	098268644104	1	213	3,478.00
	LF957RPDA-OSY-CFM	0122721	4	S.S.	098268644111	1	278	4,544.00
	LF957RPDA-OSY-CFM	0122722	6	S.S.	098268644210	1	448	6,547.00
	LF957RPDA-OSY-CFM	0122723	8	S.S.	098268644227	1	647	10,785.00
	LF957RPDA-OSY-CFM	0124736	10	S.S.	098268841718	1	997	12,609.00
	957RPDA-OSY-GPM	0111626	2 1/2	S.S.	098268123913	1	192	2,955.00
	957RPDA-OSY-GPM	0111627	3	S.S.	098268124170	1	213	3,281.00
	957RPDA-OSY-GPM	0111628	4	S.S.	098268124187	1	243	4,287.00
	957RPDA-OSY-GPM	0111629	6	S.S.	098268124194	1	423	6,175.00
	957RPDA-OSY-GPM	0111630	8	S.S.	098268124217	1	644	10,174.00
	957RPDA-OSY-GPM	0111631	10	S.S.	098268124293	1	997	11,895.00
LEAD FREE*	LF957RPDA-OSY-GPM	0122724	2 1/2	S.S.	098268644234	1	192	3,133.00
	LF957RPDA-OSY-GPM	0122725	3	S.S.	098268644241	1	213	3,478.00
	LF957RPDA-OSY-GPM	0122726	4	S.S.	098268644258	1	243	4,544.00
	LF957RPDA-OSY-GPM	0122727	6	S.S.	098268644265	1	423	6,547.00
	LF957RPDA-OSY-GPM	0122728	8	S.S.	098268644326	1	644	10,785.00
	LF957RPDA-OSY-GPM	0124737	10	S.S.	098268841725	1	997	12,609.00
N-Pattern with OSY Resilient Seated Shutoff Valves								
	957N-RPDA-OSY-CFM	0111632	2 1/2	S.S.	098268124309	1	200	3,921.00
	957N-RPDA-OSY-CFM	0111633	3	S.S.	098268124316	1	225	4,264.00
	957N-RPDA-OSY-CFM	0111634	4	S.S.	098268124323	1	266	5,873.00
	957N-RPDA-OSY-CFM	0111635	6	S.S.	098268124385	1	463	8,760.00
	957N-RPDA-OSY-CFM	0111636	8	S.S.	098268124392	1	523	12,761.00
	957N-RPDA-OSY-CFM	0111637	10	S.S.	098268124408	1	1164	15,127.00
LEAD FREE*	LF957N-RPDA-OSY-CFM	0792391	2 1/2	S.S.	098268440256	1	200	4,696.00
	LF957N-RPDA-OSY-CFM	0124738	3	S.S.	098268841992	1	225	4,520.00
	LF957N-RPDA-OSY-CFM	0124739	4	S.S.	098268842005	1	266	6,227.00
	LF957N-RPDA-OSY-CFM	0124740	6	S.S.	098268842012	1	463	9,287.00
	957N-RPDA-OSY-GPM	0111638	2 1/2	S.S.	098268124415	1	200	3,921.00
	957N-RPDA-OSY-GPM	0111639	3	S.S.	098268124422	1	225	4,264.00
	957N-RPDA-OSY-GPM	0111640	4	S.S.	098268124439	1	266	5,873.00
	957N-RPDA-OSY-GPM	0111641	6	S.S.	098268124446	1	463	8,760.00
	957N-RPDA-OSY-GPM	0111642	8	S.S.	098268124453	1	523	12,761.00
	957N-RPDA-OSY-GPM	0111643	10	S.S.	098268124484	1	1164	15,127.00
LEAD FREE*	LF957N-RPDA-OSY-GPM	0124743	2 1/2	S.S.	NA	1	200	4,156.00
	LF957N-RPDA-OSY-GPM	0124744	3	S.S.	098268842067	1	225	4,520.00
	LF957N-RPDA-OSY-GPM	0124745	4	S.S.	098268842074	1	266	6,227.00
	LF957N-RPDA-OSY-GPM	0124746	6	S.S.	098268842081	1	463	9,287.00

*The wetted surface of this product contacted by consumable water contains less than 0.25% of lead by weight.

Consult factory for ordering code numbers of special models/options.

Reduced Pressure Detector Assemblies

Model	Ordering Code	Size (in.)	Body	UPC	Qty. Per Carton	Weight Per Carton (lbs.)	List Price (each)
-------	---------------	------------	------	-----	-----------------	--------------------------	-------------------

Series 957RPDA (cont.)

Z-Pattern with OSY Resilient Seated Shutoff Valves

957Z-RPDA-OSY-CFM	0111644	2 1/2	S.S.	098268124491	1	150	\$ 3,921.00
957Z-RPDA-OSY-CFM	0111645	3	S.S.	098268124507	1	175	4,264.00
957Z-RPDA-OSY-CFM	0111646	4	S.S.	098268124514	1	201	5,873.00
957Z-RPDA-OSY-CFM	0111647	6	S.S.	098268124521	1	353	8,760.00
957Z-RPDA-OSY-CFM	0111648	8	S.S.	098268124552	1	572	12,761.00
957Z-RPDA-OSY-CFM	0111649	10	S.S.	098268124569	1	964	15,127.00
LEAD FREE LF957Z-RPDA-OSY-CFM	0792415	2 1/2	S.S.	098268440492	1	200	4,696.00
LF957Z-RPDA-OSY-CFM	0792416	3	S.S.	098268440508	1	225	5,106.00
LF957Z-RPDA-OSY-CFM	0792417	4	S.S.	098268440515	1	266	7,036.00
LF957Z-RPDA-OSY-CFM	0792418	6	S.S.	098268440522	1	463	10,493.00
957Z-RPDA-OSY-GPM	0111650	2 1/2	S.S.	098268124576	1	150	3,921.00
957Z-RPDA-OSY-GPM	0111651	3	S.S.	098268124583	1	175	4,264.00
957Z-RPDA-OSY-GPM	0111652	4	S.S.	098268124590	1	201	5,873.00
957Z-RPDA-OSY-GPM	0111653	6	S.S.	098268124606	1	353	8,760.00
957Z-RPDA-OSY-GPM	0111654	8	S.S.	098268124613	1	572	12,761.00
957Z-RPDA-OSY-GPM	0111655	10	S.S.	098268124620	1	964	15,127.00
LEAD FREE LF957Z-RPDA-OSY-GPM	0124751	2 1/2	S.S.	098268842142	1	200	4,156.00
LF957Z-RPDA-OSY-GPM	0124752	3	S.S.	098268842159	1	225	4,520.00
LF957Z-RPDA-OSY-GPM	0124753	4	S.S.	098268842166	1	266	6,227.00
LF957Z-RPDA-OSY-GPM	0124754	6	S.S.	098268842500	1	463	4,156.00

N-Pattern with UL/FM Butterfly Valve Shutoffs

957N-RPDA-BFG-CFM	0111656	2 1/2	S.S.	098268124637	1	132	4,141.00
957N-RPDA-BFG-CFM	0111657	3	S.S.	098268124644	1	134	4,484.00
957N-RPDA-BFG-CFM	0111658	4	S.S.	098268124651	1	166	6,094.00
957N-RPDA-BFG-CFM	0111659	6	S.S.	098268124668	1	285	8,986.00
LEAD FREE LF957N-RPDA-BFG-CFM	0124755	4	S.S.	098268842678	1	166	6,460.00
LF957N-RPDA-BFG-CFM	0124756	6	S.S.	098268842685	1	285	9,526.00
957N-RPDA-BFG-GPM	0111662	2 1/2	S.S.	098268124699	1	132	4,141.00
957N-RPDA-BFG-GPM	0111663	3	S.S.	098268124705	1	134	4,484.00
957N-RPDA-BFG-GPM	0111664	4	S.S.	098268124712	1	166	6,094.00
957N-RPDA-BFG-GPM	0111665	6	S.S.	098268124729	1	285	8,986.00
LEAD FREE LF957N-RPDA-BFG-GPM	0124759	4	S.S.	098268842715	1	166	6,460.00
LF957N-RPDA-BFG-GPM	0124760	6	S.S.	098268843347	1	285	1,320.00

Standard shutoffs are resilient seated outside stem and yoke (OSY), UL/FM listed



957N RPDA OSY

*The wetted surface of this product contacted by consumable water contains less than 0.25% of lead by weight.
Consult factory for ordering code numbers of special models/options.

Reduced Pressure Detector Assemblies

4

Backflow Preventers & Accessories

Standard shutoffs are resilient seated outside stem and yoke (OSY), UL/FM listed

Model	Ordering Code	Size (in.)	Body	UPC	Qty. Per Carton	Weight Per Carton (lbs.)	List Price (each)
-------	---------------	------------	------	-----	-----------------	--------------------------	-------------------

Series 957RPDA (cont.)

Z-Pattern with UL/FM Butterfly Valve Shutoffs

	957Z-RPDA-BFG-CFM	0111800	2 1/2	S.S.	098268126402	1	129	\$ 4,141.00
	957Z-RPDA-BFG-CFM	0111801	3	S.S.	098268126419	1	131	4,484.00
	957Z-RPDA-BFG-CFM	0111802	4	S.S.	098268126426	1	157	6,094.00
	957Z-RPDA-BFG-CFM	0111803	6	S.S.	098268126433	1	248	8,986.00
LEAD FREE	LF957Z-RPDA-BFG-CFM	0124761	2 1/2	S.S.	098268843354	1	129	4,390.00
	LF957Z-RPDA-BFG-CFM	0124762	3	S.S.	098268843361	1	131	4,754.00
	LF957Z-RPDA-BFG-CFM	0124763	4	S.S.	098268843392	1	157	6,460.00
	957Z-RPDA-BFG-GPM	0111806	2 1/2	S.S.	098268126464	1	129	4,141.00
	957Z-RPDA-BFG-GPM	0111807	3	S.S.	098268126471	1	131	4,484.00
	957Z-RPDA-BFG-GPM	0111808	4	S.S.	098268126488	1	103	6,094.00
	957Z-RPDA-BFG-GPM	0111809	6	S.S.	098268126495	1	248	8,986.00
LEAD FREE	LF957Z-RPDA-BFG-GPM	0124764	2 1/2	S.S.	098268843488	1	129	4,390.00
	LF957Z-RPDA-BFG-GPM	0124765	3	S.S.	098268843415	1	131	4,754.00
	LF957Z-RPDA-BFG-GPM	0124766	4	S.S.	098268843422	1	103	6,460.00
	LF957Z-RPDA-BFG-GPM	0124767	6	S.S.	098268843439	1	248	9,526.00

With OSY Resilient Seated Shutoff Valves - Less Meter

	957RPDA-OSY-LM	0111875	2 1/2	S.S.	098268260830	1	225	2,888.00
	957RPDA-OSY-LM	0111876	3	S.S.	098268260847	1	240	3,214.00
	957RPDA-OSY-LM	0111877	4	S.S.	098268260854	1	265	4,220.00
	957RPDA-OSY-LM	0111878	6	S.S.	098268260861	1	420	6,109.00
	957RPDA-OSY-LM	0111879	8	S.S.	098268260878	1	633	10,108.00
	957RPDA-OSY-LM	0111880	10	S.S.	098268260885	1	924	11,828.00
LEAD FREE	LF957-RPDA-OSY-LM	0124836	2 1/2	S.S.	098268002010	1	225	3,192.00
	LF957-RPDA-OSY-LM	0124837	3	S.S.	098268002034	1	240	3,408.00
	LF957-RPDA-OSY-LM	0124838	4	S.S.	098268002041	1	265	4,474.00
	LF957-RPDA-OSY-LM	0124839	6	S.S.	098268002058	1	420	6,476.00
	LF957-RPDA-OSY-LM	0124840	8	S.S.	098268002065	1	633	10,716.00
	LF957-RPDA-OSY-LM	0124841	10	S.S.	098268002072	1	924	12,539.00

*The wetted surface of this product contacted by consumable water contains less than 0.25% of lead by weight.

Consult factory for ordering code numbers of special models/options.

Reduced Pressure Detector Assemblies

Model	Ordering Code	Size (in.)	Body	UPC	Qty. Per Carton	Weight Per Carton (lbs.)	List Price (each)
-------	---------------	------------	------	-----	-----------------	--------------------------	-------------------

Series 957RPDA (cont.)

N-Pattern with OSY Resilient Seated Shutoff Valves - Less Meter

957N-RPDA-OSY-LM	0111881	2 1/2	S.S.	098268260892	1	183	\$ 3,851.00
957N-RPDA-OSY-LM	0111882	3	S.S.	098268260908	1	206	4,194.00
957N-RPDA-OSY-LM	0111883	4	S.S.	098268260915	1	249	5,804.00
957N-RPDA-OSY-LM	0111884	6	S.S.	098268260922	1	556	8,692.00
957N-RPDA-OSY-LM	0111885	8	S.S.	098268260939	1	706	12,692.00
957N-RPDA-OSY-LM	0111886	10	S.S.	098268260946	1	924	15,058.00

Z-Pattern with OSY Resilient Seated Shutoff Valves - Less Meter

957Z-RPDA-OSY-LM	0111887	2 1/2	S.S.	098268260953	1	183	3,851.00
957Z-RPDA-OSY-LM	0111888	3	S.S.	098268260960	1	206	4,194.00
957Z-RPDA-OSY-LM	0111889	4	S.S.	098268260977	1	249	5,804.00
957Z-RPDA-OSY-LM	0111890	6	S.S.	098268361599	1	556	8,692.00
957Z-RPDA-OSY-LM	0111891	8	S.S.	098268260984	1	706	12,692.00
957Z-RPDA-OSY-LM	0111892	10	S.S.	098268260991	1	924	15,058.00

N-Pattern with UL/FM Butterfly Valves Shutoffs - Less Meter

957N-RPDA-BFG-LM	0111893	2 1/2	S.S.	098268261011	1	129	4,071.00
957N-RPDA-BFG-LM	0111894	3	S.S.	098268261028	1	131	4,414.00
957N-RPDA-BFG-LM	0111895	4	S.S.	098268261035	1	103	6,024.00
957N-RPDA-BFG-LM	0111896	6	S.S.	098268261059	1	248	8,917.00

Z-Pattern with UL/FM Butterfly Valves Shutoffs - Less Meter

957Z-RPDA-BFG-LM	0111899	2 1/2	S.S.	098268261103	1	129	4,071.00
957Z-RPDA-BFG-LM	0111900	3	S.S.	098268261127	1	131	4,414.00
957Z-RPDA-BFG-LM	0111901	4	S.S.	098268261134	1	103	6,024.00
957Z-RPDA-BFG-LM	0111902	6	S.S.	098268261141	1	248	8,917.00



957N RPDA OSY

Standard shutoffs are resilient seated outside stem and yoke (OSY), UL/FM listed

*The wetted surface of this product contacted by consumable water contains less than 0.25% of lead by weight.

Consult factory for ordering code numbers of special models/options.

Reduced Pressure Detector Assemblies



TK-99D with Optional Carrying Case



TK-99D



AG Series

Model	Ordering Code	Type	UPC	Qty. Per Carton	Weight Per Carton (lbs.)	List Price (each)
-------	---------------	------	-----	-----------------	--------------------------	-------------------

Test Kits and Accessories

TK-9A	0385496	Analog	098268022049	1	8.7	\$ 1,473.00
TK-99E	0385511	Analog	098268399806	1	7.9	3,163.00
TK-99D	0385516	Delta-Lite™ Hand Held Digital	098268618211	1	5.0	5,431.00
TK-DL	0385515	Print out & Computer Download	098268509519	1	19	13,379.00
TK-7	0061792	Sight Glass	098268003437	1	2.6	573.50
TK-99D Case	0385508	Optional Carrying Case Only	098268920444	1	3.7	525.00

Air Gaps

909-AGA	0881399	1/4 – 1/2" 009, 1/2 – 1" 995, 3/4" 009M2/M3	098268235319	24	22	67.25
909-AGC	0881376	3/4", 1" 009/909, 1 – 1 1/2" 009M2, 1/2"-2" 995	098268104950	6	10	77.25
909-AGF	0881378	1 1/4 – 2" 009M1, 2" 009M2, 1 1/4 – 3" 009/909, 4 – 6" 993	098268104967	6	24	151.50
909-AGK •	0881385	4 – 6" 909, 8 – 10" 909M1	098268104998	1	8.7	298.50
909-AGM •	0881387	8 – 10" 909	098268105018	1	12	298.50
919AGC	0881576	3/4 – 1" 919	098268213560	24	18	83.00
919AGF	0881577	1 1/4 – 2" 919	098268213577	6	26	151.50
957-AG	0111764	2 1/2 – 10" 957	098268126112	1	2.0	196.50
957-AG Splash Guard	0111815	2 1/2 – 10" 957	098268126525	1	5.0	65.00
994-AGKP	0881397	2 1/2 – 10" 994	098268265132	1	2.1	216.00
995-AG	0439190	3 – 6" 995	098268920529	1	1.3	180.50

•Vertical

*The wetted surface of this product contacted by consumable water contains less than 0.25% of lead by weight.

Consult factory for ordering code numbers of special models/options.



909EL

Model	Ordering Code	Type	UPC	Qty. Per Carton	Weight Per Carton (lbs.)	List Price (each)
Elbows						
909-ELA	0881370	1/4 – 1/2" 009, 3/4 009M2/M3	098268310764	25	16	\$ 47.50
909-ELC	0881380	3/4 – 1" 009/909, 1 – 1 1/2" 009M2	098268104974	25	21	51.50
909-ELF •	0881382	1 1/4 – 2" 009M1, 1 1/4 – 2" 009/909, 2" 009M2, 4 – 6" 993	098268104981	6	16	99.25
909-ELH •	0881384	2 1/2 – 3" 009/909	098268276336	6	18	301.00
919-ELC	0881578	3/4 – 1" 919	098268336047	25	16	49.00
919-ELF	0881579	1 1/4 – 2" 919	098268335378	6	13	99.25
994-ELF	0881396	2 1/2 – 10" 994	098268796278	1	12	588.00

•Vertical

Test Cocks - All Bronze



LFSAE-TC
with RK-TC-TC

		Size				
	RK-SAE-TC Brass Cap & Tether	1/8 SAE	098268914764	100	5.0	20.00
	SAE-TC Brass Cap Only	1/8 SAE	098268133219	1000	42	3.25
	SAE-TC Plastic Cap Only	1/8 SAE	098268288346	100	0.1	3.00
	RK-TC-P Plastic Cap & Tether	1/8, 1/4 NPT	098268047165	3000	15	1.25
LEAD FREE*	LFNPT-TC	1/8 NPT	098268433715	50	7.5	34.75
	LFTC	1/4 NPT	098268433708	50	9.5	45.25
	LFTC4	1/2 NPT	098268433739	50	14	50.25
	LFSAE-TC	1/8 SAE	098268433722	50	10	44.00

• Epoxy coated, For 3/4" test cocks, use 3/4" B-6002.

Adapter



Adapter

SAE-TC Adapter	0006903	1/4	098268059977	1	1	43.25
SAE-TC Brass Cap	0006902	-	098268133219	1000	42	3.25

Test Cocks

For Use With 757/957 Silvereagle®

LEAD FREE*	LFTC 757/957 2 1/2-4	0792520	2 1/2 – 4" 757/957	098268500646	1	1	85.25
	LFTC 757/957 6-10	0792521	6 – 10" 757/957	098268500653	1	1	88.25
	LFRK-TC3 757/957 2 1/2-4	0792522	2 1/2 – 4" 757/957	098268500660	1	1	100.50
	LFRK-TC3 757/957 6-10	0792523	6 – 10" 757/957	098268500677	1	1	100.50

Transition Risers

For Connection of the Main Fire Supply to the Building Overhead Fire System

LEAD FREE*	TR GRVxCIPS	0777500	4	098268264838	7	71	1,365.00
	TR GRVxCIPS	0777501	6	098268264845	5	600	1,803.00
	TR GRVxCIPS	0777502	8	098268264852	2	920	2,804.00
	TR GRVxCIPS	0777503	10	098268264876	1	202	4,926.00



TR

*The wetted surface of this product contacted by consumable water contains less than 0.25% of lead by weight.

Consult factory for ordering code numbers of special models/options.

Accessories

4

Backflow Preventers & Accessories

Model	Ordering Code	Size (in.)	UPC	Qty. Per Carton	Weight Per Carton (lbs.)	List Price (each)
-------	---------------	------------	-----	-----------------	--------------------------	-------------------

Valve Setters

Flange x Flange

WWS-C FxF	0107200	2 1/2	098268300642	1		\$ 428.50
WWS-C FxF	0107210	3	098268381238	1	134	549.50
WWS-C FxF	0107211	4	098268381245	1	161	681.50
WWS-C FxF	0107212	6	098268381252	1	274	935.00
WWS-C FxF	0107213	8	098268381269	1	379	1,326.00
WWS-C FxF	0107214	10	098268381276	1	491	1,829.00

Flange x Mechanical Joint

WWS-C FxMJ	0107215	3	098268381283	1	130	549.50
WWS-C FxMJ	0107216	4	098268381290	1	157	681.50
WWS-C FxMJ	0107217	6	098268381306	1	282	934.00
WWS-C FxMJ	0107218	8	098268381313	1	367	1,326.00
WWS-C FxMJ	0107219	10	098268381320	1	469	1,831.00
WWS-C MJxMJ	0107220	3	098268381337	1	130	597.00
WWS-C MJxMJ	0107221	4	098268381344	1	157	794.00
WWS-C MJxMJ	0107222	6	098268381351	1	282	901.00
WWS-C MJxMJ	0107223	8	098268381368	1	367	1,479.00
WWS-C MJxMJ	0107224	10	098268381375	1	469	2,057.00

Flange x Flange (RP-BFG)

WWS-C FxF RP BFG	0107231	3	098268381443	1	134	549.50
WWS-C FxF RP BFG	0107225	4	098268381382	1	161	681.50
WWS-C FxF RP BFG	0107226	6	098268381399	1	274	1,029.00

Flange x Mechanical Joint (RP-BFG)

WWS-C FxMJ RP BFG	0107232	3	098268381450	1	130	549.50
WWS-C FxMJ RP BFG	0107227	4	098268381405	1	157	681.00
WWS-C FxMJ RP BFG	0107228	6	098268381412	1	282	1,028.00

Mechanical Joint x Mechanical Joint (RP-BFG)

WWS-C MJxMJ RP BFG	0107233	3	098268381467	1	130	596.00
WWS-C MJxMJ RP BFG	0107229	4	098268381429	1	157	792.50
WWS-C MJxMJ RP BFG	0107230	6	098268381436	1	282	1,091.00



W-SPL

Spools and Flanges - For Retrofitting Backflow Preventers

Spools available in sizes:

LEAD FREE	W-SPL	2 1/2 x 1 7/8 - 10 x 1/2	-	N/A
-----------	-------	--------------------------	---	-----

Flanges available in sizes:

LEAD FREE	W-FLG	2 x 1/4 - 10 x 1/2	-	N/A
-----------	-------	--------------------	---	-----

Contact your local Watts Representative for ordering information and pricing.



Valve Stand

Valve Stand

RK-EZ-STD	0777237		098268357868	1	43	214.00
-----------	---------	--	--------------	---	----	--------

*The wetted surface of this product contacted by consumable water contains less than 0.25% of lead by weight.

Consult factory for ordering code numbers of special models/options.

Wattsbox Enclosures



Model	Ordering Code	Size (in.)	UPC	Qty. Per Carton	Weight Per Carton (lbs.)	List Price (each)
-------	---------------	------------	-----	-----------------	--------------------------	-------------------

Wattsbox Enclosures

Fiberglass

WB-75	0888600	19 x 11 x 22	098268733310	1	30	\$ 819.00
WB-1	0888601	27 x 13 x 23	098268733327	1	35	1,043.00
WB-1.5	0888603	33 x 21 x 25	098268733341	1	50	1,343.00
WB-2	0888604	39 x 13 x 28	098268733358	1	50	1,375.00
WB-N3	0888789	70 x 26 x 45	098268823646	1	210	5,563.00
WB-E3	0888790	70 x 26 x 55	098268823653	1	285	7,505.00
WB 3000	0889334	45 x 35 x 35	098268940237	1	244	4,744.00
WB 4000	0889335	53 x 44 x 44	098268940244	1	300	6,497.00

Fiberglass - Less Heat

WB-75-LH	0889330	19 x 11 x 22	098268832112	1	30	706.50
WB-1-LH	0889331	27 x 13 x 23	098268832105	1	35	905.00
WB-1.5-LH	0889332	33 x 21 x 25	098268832099	1	50	1,218.00
WB-2-LH	0889333	39 x 13 x 28	098268832129	1	50	1,274.00
WB-N3-LH	0889300	70 x 26 x 45	098268823974	1	210	4,719.00
WB-E3-LH	0889301	70 x 26 x 55	098268823981	1	285	6,144.00

Fiberglass, Strainer Models

WB-2S	0888800	47 x 13 x 28	098268823752	1	85	1,705.00
WB-N3S	0888801	83 x 26 x 45	098268823769	1	275	7,868.00

Fiberglass, Strainer Models - Less Heat

WB-2S-LH	0889311	47 x 13 x 28	098268824094	1	85	1,550.00
WB-N3S-LH	0889312	83 x 26 x 45	098268824100	1	275	6,974.00
WB-E3S-LH	0889313	83 x 26 x 55	098268824117	1	295	7,972.00

Aluminum

WB-N4	0888793	90 x 32 x 50 1/2	098268823684	1	407	7,014.00
WB-E4	0888857	90 x 32 x 57 1/2	098268830101	1	375	7,794.00
WB-N6	0888794	106 x 36 x 53	098268823691	1	491	8,768.00
WB-E6	0888795	105 x 36 x 64	098268823707	1	500	10,560.00
WB-N8	0888796	118 x 40 x 58	098268823714	1	540	11,144.00
WB-E8	0888797	118 x 40 x 74	098268823721	1	575	12,703.00
WB-N10	0888798	142 x 42 x 65	098268823738	1	650	13,483.00
WB-E10	0888799	142 x 42 x 85	098268823745	1	700	15,588.00
WB 4000AN	0889336	53 x 33 x 44	098268940251	1	275	5,592.00
WB 4000AE	0889337	53 x 44 x 44	098268940268	1	300	6,079.00
WB 6000AN	0889338	62 x 39 x 46	098268940275	1	325	6,547.00
WB 6000AE	0889339	62 x 53 x 46	098268940282	1	401	7,521.00

Aluminum - Less Heat

WB-N4-LH	0889304	90 x 32 x 50 1/2	098268824025	1	325	6,043.00
WB-N6-LH	0889305	106 x 36 x 53	098268824032	1	500	7,796.00
WB-E6-LH	0889306	105 x 36 x 64	098268824049	1	540	8,770.00
WB-N8-LH	0889307	118 x 40 x 58	098268824056	1	550	9,354.00
WB-E8-LH	0889308	118 x 40 x 74	098268824063	1	625	10,914.00
WB-N10-LH	0889309	142 x 42 x 65	098268824070	1	650	11,694.00
WB-E10-LH	0889310	142 x 42 x 85	098268824087	1	800	13,643.00

Aluminum Stucco

WB 2000A	0889350	39 x 24 x 32	098268214833	1	160	2,352.00
WB 2.5	0889352	60 x 22 x 30	098268214864	1	200	3,022.00
WB 2.75	0889354	60 x 22 x 42	098268214888	1	260	3,632.00
WB 6 ET	0889356	105 x 36 x 80	098268214901	1	790	11,923.00
WB 8000ANT	0889358	73 x 45 x 60	098268214925	1	530	9,470.00
WB 8000AET	0889360	73 x 67 x 60	098268214970	1	530	10,522.00

See literature ES-WB for sizing information

*The wetted surface of this product contacted by consumable water contains less than 0.25% of lead by weight.

Consult factory for ordering code numbers of special models/options.

Wattsbox Enclosures

4

Backflow Preventers & Accessories



Model	Ordering Code	Size (in.)	UPC	Qty. Per Carton	Weight Per Carton (lbs.)	List Price (each)
-------	---------------	------------	-----	-----------------	--------------------------	-------------------

Wattsbox Enclosures (cont.)

Aluminum Stucco - Less Heat

WB 2000A LH	0889351		098268214857	1	151	\$ 2,183.00
WB 2.5 LH	0889353		098268214871	1	191	2,681.00
WB 2.75 LH	0889355		098268214895	1	251	3,294.00
WB 6 ET LH	0889357		098268214918	1	781	10,135.00
WB 8000ANT LH	0889359		098268214963	1	521	8,497.00
WB 8000AET LH	0889361		098268214994	1	521	9,550.00

Aluminum, Strainer Models

WB-N4S	0888803	4 NRS	098268823783	1	375	7,794.00
WB-E4S	0888804	4 OSY	098268823790	1	400	8,550.00
WB-N6S	0888805	6 NRS	098268823806	1	540	10,365.00
WB-E6S	0888806	6 OSY	098268823813	1	575	11,533.00
WB-N8S	0888807	8 NRS	098268823820	1	550	13,093.00
WB-E8S	0888808	8 OSY	098268823943	1	650	14,614.00
WB-N10S	0888809	10 NRS	098268823950	1	800	15,588.00
WB-E10S	0888810	10 OSY	098268823967	1	745	18,238.00

Aluminum, Strainer Models - Less Heat

WB-N4S-LH	0889314	4 NRS	098268824124	1	375	6,822.00
WB-E4S-LH	0889315	4 OSY	098268824131	1	400	7,578.00
WB-N6S-LH	0889316	6 NRS	098268824148	1	540	8,575.00
WB-E6S-LH	0889317	6 OSY	098268824155	1	575	9,744.00
WB-N8S-LH	0889318	8 NRS	098268824162	1	625	11,304.00
WB-E8S-LH	0889319	8 OSY	098268824179	1	650	12,668.00
WB-N10S-LH	0889320	10 NRS	098268824186	1	800	13,643.00
WB-E10S-LH	0889321	10 OSY	098268824193	1	850	16,293.00

For Pressure Vacuum Breakers

WB-PVB1	0888664	3/4 - 1	098268733952	1	18	618.50
WB-PVB-T1	0888665	3/4 - 1	098268733969	1	21	725.50
WB-PVB2	0888666	1 1/4 - 2	098268733976	1	39	723.00
WB-PVB-T2	0888667	1 1/4 - 2	098268733983	1	120	888.00

For Pressure Vacuum Breakers - Less Heat

WB-PVB2-LH	0888716	1 1/4 - 2	098268744149	1	30	622.00
WB-PVBT1-LH	0888675	3/4 - 1	098268244335	1	21	613.00
WB-PVBT2-LH	0888676	1 1/4 - 2	098268244342	1	120	796.00

See literature ES-WB for sizing information

*The wetted surface of this product contacted by consumable water contains less than 0.25% of lead by weight.

Consult factory for ordering code numbers of special models/options.

Watts Rock & Pre-Engineered Valve Stations

Model	Ordering Code	Dimensions L x W x H	UPC	Qty. Per Carton	Weight Per Carton (lbs.)	List Price (each)
-------	---------------	-------------------------	-----	--------------------	-----------------------------	----------------------



Watts Rock

Shell Only

WPLRN-1 Brown	0888985	28 x 12 x 23	098268133189	1	25	\$ 898.00
WPLRN-1 Grey	0888988	28 x 12 x 23	098268151862	1	25	898.00
WPLRN-2 Brown	0888991	45 x 14 x 28	098268185911	1	50	1,136.00
WPLRN-2 Grey	0888992	45 x 14 x 28	098268185928	1	35	1,136.00

With Insulation - Less Heat

WPLR-1 Brown	0888986	26 x 10 x 22	098268133196	1	25	1,032.00
WPLR-1 Grey	0888989	26 x 10 x 22	098268151879	1	25	1,032.00
WPLR-2 Brown	0888993	43 x 12 x 27	098268185935	1	40	1,286.00
WPLR-2 Grey	0888994	43 x 12 x 27	098268185942	1	50	1,286.00

With Heat and Insulation

WPHR-1 Brown	0888987	26 x 10 x 22	098268133202	1	25	1,169.00
WPHR-1 Grey	0888990	26 x 10 x 22	098268151886	1	25	1,169.00
WPHR-2 Brown	0888995	43 x 12 x 27	098268185973	1	50	1,455.00
WPHR-2 Grey	0888996	43 x 12 x 27	098268185980	1	50	1,455.00

*See ES-WattsRock literature for sizing information

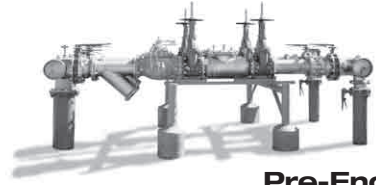

Pre-Engineered Valve Stations

Custom Configured Water Flow Control Systems

PVS-1000	Contact your local Watts representative for pricing and ordering information.
BIC-1000	Contact your local Watts representative for pricing and ordering information.

*The wetted surface of this product contacted by consumable water contains less than 0.25% of lead by weight.

Consult factory for ordering code numbers of special models/options.

Electric Motor Valves



LFEMVII-6400SS

5

Ball Valves

Model	Ordering Code	Size (in.)	UPC	Qty. Per Carton	Weight Per Carton (lbs.)	List Price (each)
-------	---------------	------------	-----	-----------------	--------------------------	-------------------

Electric Motor Valves

2-Piece, Standard Port, Bronze Electric Motor Valves – Fully Assembled – 316 Stainless Steel Ball & Stem Threaded Ends – 100 WSP/600 WOG

Model	Ordering Code	Size (in.)	UPC	Qty. Per Carton	Weight Per Carton (lbs.)	List Price (each)
LFEMVII6400SS 115-8	0123439	1/4	098268694482	1	10	\$ 1,397.00
LFEMVII6400SS 115-8	0123301	3/8	098268691214	1	10	1,678.00
LFEMVII6400SS 115-8	0123410	1/2	098268694024	1	10	1,397.00
LFEMVII6400SS 115-35	0123411	1/2	098268694031	1	8.8	1,397.00
LFEMVII6400SS 24-18	0123414	1/2	098268694093	1	9.0	1,227.00
LFEMVII6400SS 24-40	0123415	1/2	098268694123	1	9.0	1,227.00
LFEMVII6400SS 115-8	0123416	3/4	098268694130	1	11	1,458.00
LFEMVII6400SS 115-35	0123417	3/4	098268694147	1	10	1,458.00
LFEMVII6400SS 24-18	0123418	3/4	098268694154	1	10	1,248.00
LFEMVII6400SS 24-40	0123419	3/4	098268694161	1	9.4	1,248.00
LFEMVII6400SS 115-8	0123420	1	098268694178	1	11	1,528.00
LFEMVII6400SS 115-35	0123421	1	098268694192	1	10	1,528.00
LFEMVII6400SS 24-18	0123423	1	098268694215	1	12	1,340.00
LFEMVII6400SS 24-40	0123424	1	098268694239	1	10	1,340.00
LFEMVII6400SS 115-8	0123425	1 1/4	098268694246	1	12	1,594.00
LFEMVII6400SS 115-35	0123426	1 1/4	098268694253	1	11	1,594.00
LFEMVII6400SS 24-18	0123427	1 1/4	098268694277	1	11	1,398.00
LFEMVII6400SS 24-40	0123428	1 1/4	098268694284	1	11	1,398.00
LFEMVII6400SS 115-8	0123429	1 1/2	098268694291	1	13	1,664.00
LFEMVII6400SS 115-35	0123432	1 1/2	098268694321	1	12	1,664.00
LFEMVII6400SS 24-18	0123430	1 1/2	098268694307	1	13	1,460.00
LFEMVII6400SS 24-40	0123431	1 1/2	098268694314	1	12	1,460.00
LFEMVII6400SS350 115-8	0123413	2	098268694055	1	15	2,220.00
LFEMVII6400SS350 115-40	0123437	2	098268694376	1	15	2,220.00
LFEMVII6400SS350 24-18	0123436	2	098268694369	1	15	2,220.00
LFEMVII6400SS350 24-40	0123412	2	098268694048	1	6.4	2,220.00

LEAD FREE*

Available in 115 VAC or 24VAC motor with various operator cycles.

Handle Options

Suffix	Description	Models	Sizes	Repair Kit Description	Valve Option Price Adder
--------	-------------	--------	-------	------------------------	--------------------------



Tee Handle



Extended Handle

Handle Options

LC / LFB6400	Latch Lock Lever Handle-Closed Positions (without lock)	B6800/B6800SE B6400SE	1/4 – 2	LL-HK	See PL-RP-GP
LH / LFB6400	Locking Lever Handle (without lock)	B6000/B6001	1/2 – 2	LH-HK	See PL-RP-GP
		B6400/B6400SE	1/4 – 2		
		B6800/B6801	1/2 – 2		
LL / LFB6400	Latch Lock Lever Handle (with-out lock)	B6400/B6400SE B6800/B6801	1/4 – 2 1/2 – 2	LL-HK	See PL-RP-GP
SH	Stainless Steel Lever Handle & Nut	LFFBV-3C	1/4 – 2	SH-HK	See PL-RP-GP
TH	Tee Handle	LFFBV-3C	All	TH-HK	See PL-RP-GP
XH	Extended Lever Handle	LFFBV-3C	1/4 – 2	XHK-LH	See PL-RP-GP

Ball Valve options only, refer to ball valve literature, PL-RP-GP for required kit information.

*The wetted surface of this product contacted by consumable water contains less than 0.25% of lead by weight.

Consult factory for ordering code numbers of special models/options.

Ball Valves

Model	Ordering Code	Size (in.)	UPC	Qty. Per Carton	Weight Per Carton (lbs.)	List Price (each)
-------	---------------	------------	-----	-----------------	--------------------------	-------------------

Bronze Ball Valves — Full Port — 3 Piece

Series LFB6800

Threaded Ends - 316 Stainless Steel Ball and Stem - 150 WSP/600 WOG

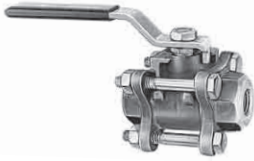

LFB6800

Model	Ordering Code	Size (in.)	UPC	Qty. Per Carton	Weight Per Carton (lbs.)	List Price (each)
LFB6800	0123219	1/4	098268689099	32	32	\$ 85.00
LFB6800	0123221	3/8	098268689136	32	32	85.00
LFB6800	0123222	1/2	098268689143	32	35	97.00
LFB6800	0123227	3/4	098268689365	16	36	119.50
LFB6800	0123231	1	098268689440	8	33	195.00
LFB6800	0123234	1 1/4	098268689471	6	36	282.50
LFB6800	0123239	1 1/2	098268689723	4	36	369.50
LFB6800	0123242	2	098268689938	2	30	544.00

Threaded Ends - Latch-Lok - Open and Closed Position - 150 WSP/600 WOG

Model	Ordering Code	Size (in.)	UPC	Qty. Per Carton	Weight Per Carton (lbs.)	List Price (each)
LFB6800-LL	0123243	1/4	098268689945	32	32	112.00
LFB6800-LL	0123244	3/8	098268689952	32	32	112.00
LFB6800-LL	0123245	1/2	098268689969	32	35	123.50
LFB6800-LL	0123246	3/4	098268689976	16	48	145.00
LFB6800-LL	0123247	1	098268689983	8	31	214.50
LFB6800-LL	0123248	1 1/4	098268689990	6	36	321.00
LFB6800-LL	0123249	1 1/2	098268690118	4	36	399.50
LFB6800-LL	0123250	2	098268690194	2	28	556.00

Series LFB6801

Solder Ends - 316 Stainless Steel Ball and Stem - 150 WSP/600 WOG



LFB6801

Model	Ordering Code	Size (in.)	UPC	Qty. Per Carton	Weight Per Carton (lbs.)	List Price (each)
LFB6801	0123275	1/2	098268690958	32	35	113.00
LFB6801	0123276	3/4	098268690965	16	34	138.50
LFB6801	0123277	1	098268690972	8	31	226.00
LFB6801	0123278	1 1/4	098268690989	6	37	326.50
LFB6801	0123279	1 1/2	098268690996	4	33	426.00
LFB6801	0123280	2	098268691009	4	65	629.00

Bronze Ball Valves — Full Port — 2 Piece

Series LFB6000

Threaded Ends - 316 Stainless Steel Ball and Stem - 125 WSP/400 WOG

Model	Ordering Code	Size (in.)	UPC	Qty. Per Carton	Weight Per Carton (lbs.)	List Price (each)
LFB6000	0555192	2 1/2	098268433029	1	15	622.50
LFB6000	0555193	3	098268433036	1	19	775.00
LFB6000	0555194	4	098268433043	1	30	1,350.00

Series LFB6001

Solder Ends - 316 Stainless Steel Ball and Stem - 125 WSP/400 WOG



LFB6001

Model	Ordering Code	Size (in.)	UPC	Qty. Per Carton	Weight Per Carton (lbs.)	List Price (each)
LFB6001	0555202	2 1/2	098268433159	1	14	715.00
LFB6001	0555203	3	098268433166	1	17	805.00

*The wetted surface of this product contacted by consumable water contains less than 0.25% of lead by weight.

Consult factory for ordering code numbers of special models/options.

Model	Ordering Code	Size (in.)	UPC	Qty. Per Carton	Weight Per Carton (lbs.)	List Price (each)
-------	---------------	------------	-----	-----------------	--------------------------	-------------------

Bronze Ball Valves - Standard Port - 2 Piece

Series LFB6400

Standard Port - With Mounting Pads

150 WSP/600 WOG (2 1/2" - 4" 125 WSP/400 WOG)

LFB6400	0123190	1/4	098268669336	48	48	\$ 49.00
LFB6400	0123192	3/8	098268669374	40	48	49.00
LFB6400	0123194	1/2	098268669510	40	40	49.00
LFB6400	0123196	3/4	098268669596	32	40	63.75
LFB6400	0123198	1	098268669695	16	34	86.50
LFB6400	0123200	1 1/4	098268672039	12	34	103.00
LFB6400	0123202	1 1/2	098268672107	12	50	162.00
LFB6400	0123204	2	098268672138	4	27	255.50
LFB6400	0123206	2 1/2	098268673555	1	14	1,096.00
LFB6400	0123208	3	098268673586	1	17	1,176.00
LFB6400	0123210	4	098268673609	1	25	1,408.00

Standard Port - With Mounting Pads - Latch Lock Lever

150 WSP/600 WOG (2 1/2" - 3" 125 WSP/400 WOG)

LFB6400-LL	0125207	1/4	098268852035	40	20	109.00
LFB6400-LL	0125208	3/8	098268852042	48	48	109.00
LFB6400-LL	0125209	1/2	098268852226	40	32	111.50
LFB6400-LL	0125210	3/4	098268852233	40	62	198.00
LFB6400-LL	0125212	1	098268852257	16	34	166.00
LFB6400-LL	0125214	1 1/4	098268852271	12	39	264.50
LFB6400-LL	0125215	1 1/2	098268852288	4	26	380.50
LFB6400-LL	0125216	2	098268852295	12	51	441.50
LFB6400-LL	0125217	2 1/2	098268852301	1	13	1,451.00
LFB6400-LL	0125223	3	098268852752	1	17	1,675.00

Bronze Ball Valves - Full Port - 2 Piece

Series LFB6080G2

Full Port - Threaded Ends - (150 WSP/600 WOG)

LFB6080G2	0450100	1/4	098268763294	48	21	32.25
LFB6080G2	0450101	3/8	098268763355	48	22	32.25
LFB6080G2	0450102	1/2	098268763362	40	20	32.25
LFB6080G2	0450103	3/4	098268763379	40	36	51.75
LFB6080G2	0450104	1	098268763386	24	34	81.50
LFB6080G2	0450105	1 1/4	098268763461	12	25	123.00
LFB6080G2	0450106	1 1/2	098268763478	6	19	157.50
LFB6080G2	0450107	2	098268763485	6	30	275.50

Series LFB6081G2

Full Port - Solder Ends - (150 WSP/600 WOG)

LFB6081G2	0450108	3/8	098268763492	48	20	32.25
LFB6081G2	0450109	1/2	098268763508	40	16	32.25
LFB6081G2	0450110	3/4	098268763539	40	32	51.75
LFB6081G2	0450111	1	098268763546	24	30	81.50
LFB6081G2	0450112	1 1/4	098268763560	12	22	123.00
LFB6081G2	0450113	1 1/2	098268763652	6	16	157.50
LFB6081G2	0450114	2	098268763669	6	27	275.50



LFB6080G2



LFB6081G2

*The wetted surface of this product contacted by consumable water contains less than 0.25% of lead by weight.

Consult factory for ordering code numbers of special models/options.

Model	Ordering Code	Size (in.)	UPC	Qty. Per Carton	Weight Per Carton (lbs.)	List Price (each)
-------	---------------	------------	-----	-----------------	--------------------------	-------------------

Bronze Ball Valves - Full Port - 2 Piece (cont.)

Series LFB6080G2-SS

Full Port - 3/16 Stainless Ball & Stem - Threaded Ends - (150 WSP/600 WOG)

LFB6080G2-SS	0450115	1/4	098268763676	48	21	\$ 50.00
LFB6080G2-SS	0450116	3/8	098268763683	48	21	55.50
LFB6080G2-SS	0450117	1/2	098268763690	40	20	59.25
LFB6080G2-SS	0450118	3/4	098268763706	40	36	99.75
LFB6080G2-SS	0450119	1	098268763942	24	34	183.00
LFB6080G2-SS	0450120	1 1/4	098268763973	12	25	223.50
LFB6080G2-SS	0450121	1 1/2	098268763980	6	18	257.50
LFB6080G2-SS	0450122	2	098268763997	6	29	428.50

Series LFB6081G2-SS

Full Port - 3/16 Stainless Ball & Stem Solder Ends - (150 WSP/600 WOG)

LFB6081G2-SS	0450123	3/8	098268764000	48	19	55.50
LFB6081G2-SS	0450124	1/2	042805764046	40	16	59.25
LFB6081G2-SS	0450125	3/4	098268764178	40	31	99.75
LFB6081G2-SS	0450126	1	098268764185	24	30	183.00
LFB6081G2-SS	0450127	1 1/4	098268764192	8	14	223.50
LFB6081G2-SS	0450128	1 1/2	098268764314	6	16	257.50
LFB6081G2-SS	0450129	2	098268764321	6	26	428.50

Bronze Ball Valves - Standard Port - 2 Piece

Series LFB6780

Threaded Ends - Three-Way Diverter - 125 WSP/400 WOG

LFB6780M1	0123394	1/4	098268693287	24	16	67.00
LFB6780M1	0123395	3/8	098268693294	24	16	67.00
LFB6780M1	0555219	1/2	098268433326	24	16	73.25
LFB6780M1	0555220	3/4	098268433333	24	26	78.00
LFB6780M1	0555221	1	098268433340	16	30	130.00
LFB6780M1	0555222	1 1/4	098268433357	12	48	245.50
LFB6780M1	0555223	1 1/2	098268433364	8	52	279.50
LFB6780M1	0555224	2	098268433371	2	20	467.50

Series LFB6781

Solder Ends - Three-Way Diverter - 125 WSP/ 400 WOG

LFB6781	0123358	1/2	098268692556	24	16	50.75
LFB6781	0555225	3/4	098268433388	32	19	111.00
LFB6781	0123360	1	098268692570	16	30	113.50

Series LFFBV

Threaded Ends - 600 WOG

LFFBV	0125026	1/2	098268846423	108	60	34.25
LFFBV	0125027	3/4	098268846430	72	50	47.50
LFFBV	0125028	1	098268846447	36	58	100.50
LFFBV	0792509	1 1/4	098268500431	6	11	175.00
LFFBV	0792510	1 1/2	098268500448	6	19	224.00
LFFBV	0792511	2	098268500455	6	31	391.50



LFB6780M1

LEAD FREE*



LFFBV

LEAD FREE*

*The wetted surface of this product contacted by consumable water contains less than 0.25% of lead by weight.

Consult factory for ordering code numbers of special models/options.

Model	Ordering Code	Size (in.)	UPC	Qty. Per Carton	Weight Per Carton (lbs.)	List Price (each)
-------	---------------	------------	-----	-----------------	--------------------------	-------------------

Brass Ball Valves - Full Port - 2 Piece

Series LFIT6300

Threaded Ends - Brass Ball and Waste Feature - 600 WOG



LFIT6300

LEAD FREE*	Model	Ordering Code	Size (in.)	UPC	Qty. Per Carton	Weight Per Carton (lbs.)	List Price (each)
	LFIT6300	0123625	1/2	098268701432	120	48	\$ 20.00
	LFIT6300	0123626	3/4	098268701449	60	54	28.00
	LFIT6300	0123627	1	098268701456	36	50	36.75

Series LFIS6301

Solder Ends - 600 WOG

LEAD FREE*	Model	Ordering Code	Size (in.)	UPC	Qty. Per Carton	Weight Per Carton (lbs.)	List Price (each)
	LFIS6301	0123628	1/2	098268701470	120	24	20.00
	LFIS6301	0123629	3/4	098268701494	60	44	28.00
	LFIS6301	0123630	1	098268701500	36	36	36.75

Series FBV-3C and LFFBV-3C - 2 Piece

Threaded Ends - 150 WSP/600 WOG



FBV-3C

	FBV-3C	0547100	1/4	098268335811	120	45	9.75
	FBV-3C	0547101	3/8	098268335941	120	44	9.75
	FBV-3C	0547102	1/2	098268335958	120	46	9.75
	FBV-3C	0547103	3/4	098268335996	60	46	14.75
	FBV-3C	0547104	1	098268335972	30	36	21.75
	FBV-3C	0547105	1 1/4	098268335873	20	37	33.75
	FBV-3C	0547106	1 1/2	098268335880	16	41	52.50
	FBV-3C	0547107	2	098268335897	6	22	80.50

LEAD FREE*	Model	Ordering Code	Size (in.)	UPC	Qty. Per Carton	Weight Per Carton (lbs.)	List Price (each)
	LFFBV-3C	0555100	1/4	098268447699	120	45	12.50
	LFFBV-3C	0555101	3/8	098268447705	120	44	12.50
	LFFBV-3C †❖	0555102	1/2	098268447712	120	46	12.50
	LFFBV-3C †❖	0555103	3/4	098268447729	60	46	18.75
	LFFBV-3C †❖	0555104	1	098268447736	30	36	28.00
	LFFBV-3C †❖	0555105	1 1/4	098268447743	20	37	42.75
	LFFBV-3C †❖	0555106	1 1/2	098268447750	16	41	67.00
	LFFBV-3C †❖	0555107	2	098268447767	6	22	103.00

Threaded Ends - 125 WSP/400 WOG



LFFBV-3C

	FBV-3C	0547108	2 1/2	098268335903	5	36	221.00
	FBV-3C	0547109	3	098268335910	5	57	303.00
	FBV-3C	0546845	4	098268335295	1	18	502.00
	LFFBV-3C ▼	0555108	2 1/2	098268447774	5	36	282.00
	LFFBV-3C ▼	0555109	3	098268447781	5	57	386.50
	LFFBV-3C	0555096	4	098268810066	1	18	640.50

*The wetted surface of this product contacted by consumable water contains less than 0.25% of lead by weight.

Consult factory for ordering code numbers of special models/options.

Model	Ordering Code	Size (in.)	UPC	Qty. Per Carton	Weight Per Carton (lbs.)	List Price (each)
-------	---------------	------------	-----	-----------------	--------------------------	-------------------

Brass Ball Valves - Full Port - 2 Piece

Series FBVS-3C and LFFBVS-3C

Solder Ends - 150 WSP/600 WOG

FBVS-3C	0547110	1/2	098268335828	120	46	\$ 9.75
FBVS-3C	0547111	3/4	098268335965	60	46	14.75
FBVS-3C	0547112	1	098268335835	30	36	21.75
FBVS-3C	0547113	1 1/4	098268335842	20	37	33.75
FBVS-3C	0547114	1 1/2	098268335859	16	41	52.50
FBVS-3C	0547115	2	098268335866	6	22	80.50

Solder Ends - 150 WSP/600 WOG

LEAD FREE*	LFFBVS-3C	0555110	1/2	098268447798	120	42	12.50
	LFFBVS-3C	0555111	3/4	098268447804	60	41	18.75
	LFFBVS-3C	0555112	1	098268447811	30	33	28.00
	LFFBVS-3C	0555113	1 1/4	098268447828	20	34	42.75
	LFFBVS-3C	0555114	1 1/2	098268447835	16	38	67.00
	LFFBVS-3C	0555115	2	098268447842	6	23	103.00

Solder Ends - 125 WSP/400 WOG

LEAD FREE*	FBVS-3C	0547116	2 1/2	098268335827	5	33	221.00
	FBVS-3C	0547117	3	098268335934	5	47	303.00
	LFFBVS-3C	0555116	2 1/2	098268447859	5	33	282.00
	LFFBVS-3C	0555117	3	098268447866	5	47	386.50

Series FBV-3C, LFFBV-3C, LFFBVS-3C

Threaded Ends - 150 WSP/600 WOG

LEAD FREE*	LFFBV-3C-TH	0123461	1/2	098268695830	120	46	36.25
	LFFBV-3C-TH	0123489	3/4	098268696950	60	46	21.25
	LFFBV-3C-TH	0123490	1	098268696967	30	36	30.75

Solder Ends - 150 WSP/600 WOG

LEAD FREE*	LFFBVS-3C-TH	0123491	1/2	098268696998	100	35	15.00
	LFFBVS-3C-TH	0123492	3/4	098268697001	60	41	21.25
	LFFBVS-3C-TH	0123493	1	098268697018	30	33	30.75

Threaded Ends - 300psi UL/FM Trim & Drain

FBV-3C - UL/FM	0547125	1/4	098268340952	120	45	19.00
FBV-3C - UL/FM	0547127	1/2	098268340891	120	46	21.50
FBV-3C - UL/FM	0547128	3/4	098268340907	60	51	25.50
FBV-3C - UL/FM	0547129	1	098268340914	30	41	57.25
FBV-3C - UL/FM	0547130	1 1/4	098268340921	20	37	68.50
FBV-3C - UL/FM	0547131	1 1/2	098268340938	16	41	83.25
FBV-3C - UL/FM	0547132	2	098268340945	6	27	127.50

Threaded Ends - Stainless Steel Ball & Stem - 150 WSP/600 WOG

LEAD FREE*	LFFBV-3C-SS	0123462	1/2	098268695847	120	60	102.50
	LFFBV-3C-SS	0123463	3/4	098268695854	60	54	145.00
	LFFBV-3C-SS	0123464	1	098268695861	30	40	172.50
	LFFBV-3C-SS	0123465	1 1/4	098268695878	20	45	269.50
	LFFBV-3C-SS	0123466	1 1/2	098268695908	16	48	324.00
	LFFBV-3C-SS	0123467	2	098268695915	6	33	485.50

Solder Ends - Stainless Steel Ball & Stem - 150 WSP/600 WOG

LEAD FREE*	LFFBVS-3C-SS	0123468	1/2	098268695939	120	60	102.50
	LFFBVS-3C-SS	0123469	3/4	098268695953	60	54	145.00
	LFFBVS-3C-SS	0123470	1	098268695960	30	40	172.50
	LFFBVS-3C-SS	0123471	1 1/4	098268695977	20	45	269.50
	LFFBVS-3C-SS	0123472	1 1/2	098268696080	16	48	324.00
	LFFBVS-3C-SS	0123473	2	098268696097	6	33	485.50

*The wetted surface of this product contacted by consumable water contains less than 0.25% of lead by weight.

Consult factory for ordering code numbers of special models/options.

Ball Valves

5 Ball Valves



LFFBV-3C-QC

Model	Ordering Code	Size (in.)	UPC	Qty. Per Carton	Weight Per Carton (lbs.)	List Price (each)
-------	---------------	------------	-----	-----------------	--------------------------	-------------------

Brass Ball Valves - Full Port - 2 Piece (cont.) Series LFFBV-3

Quick-Connect End Connection - 200 CWP

LEAD FREE*	Model	Ordering Code	Size (in.)	UPC	Qty. Per Carton	Weight Per Carton (lbs.)	List Price (each)
	LFFBV-3C-QC	0555269	1/2	098268450316	96	54	\$ 27.50
	LFFBV-3C-QC	0555270	3/4	098268450323	48	50	43.00
	LFFBV-3C-QC	0555271	1	098268450330	24	37	64.75

Threaded End - Cap and Chain

LEAD FREE*	Model	Ordering Code	Size (in.)	UPC	Qty. Per Carton	Weight Per Carton (lbs.)	List Price (each)
	LFFBV-3C-CC Cap and Chain	0123474	1/2	098268696103	48	32	21.50
	LFFBV-3C-CC Cap and Chain	0123475	3/4	098268696110	48	55	28.00

Soldered End - Cap and Chain

LEAD FREE*	Model	Ordering Code	Size (in.)	UPC	Qty. Per Carton	Weight Per Carton (lbs.)	List Price (each)
	LFFBVS-3C-CC Cap and Chain	0123476	1/2	098268696127	48	23	21.50
	LFFBVS-3C-CC Cap and Chain	0123477	3/4	098268696134	48	41	28.00

Integral Press Fitting End Connection - 200CWP NSF/ANSI 61 1/2" - 2"

LEAD FREE*	Model	Ordering Code	Size (in.)	UPC	Qty. Per Carton	Weight Per Carton (lbs.)	List Price (each)
	LFFBV-3 Press-M1	0555298	1/2	098268064667	80	29	43.75
	LFFBV-3 Press-M1	0555299	3/4	098268064674	50	36	56.50
	LFFBV-3 Press-M1	0555300	1	098268064681	40	37	74.00
	LFFBV-3 Press-M1	0555301	1 1/4	098268064698	20	31	107.50
	LFFBV-3 Press-M1	0555302	1 1/2	098268064704	12	30	177.50
	LFFBV-3 Press-M1	0555303	2	098268064711	8	36	250.50
	LFFBV-3-PRESS-XLC	0125084	2 1/2	098268848076	2	22	825.50
	LFFBV-3-PRESS-XLC	0125085	3	098268848335	2	35	1,162.00
	LFFBV-3-PRESS-XLC	0125086	4	098268848342	1	24	1,534.00

FBV-3-Press Extended Handle Kits

Model	Ordering Code	Size (in.)	UPC	Qty. Per Carton	Weight Per Carton (lbs.)	List Price (each)
HK SXI-PRESS	0789509	1/2	098268501889	20	17	24.25
HK SXI-PRESS	0789510	3/4-1	098268501896	20	17	28.75
HK SXI-PRESS	0789511	1 1/4-1 1/2	098268501902	20	20	38.50
HK SXI-PRESS	0789512	2	098268501919	20	35	57.25

Series LFFBV-4

Threaded Ends - 150 WSP/600 WOG for Sizes 1/4-2 & 125WSP/400 WOG for sizes 2 1/2-3

LEAD FREE*	Model	Ordering Code	Size (in.)	UPC	Qty. Per Carton	Weight Per Carton (lbs.)	List Price (each)
	LFFBV-4	0555118	1/4	098268805444	120	35	10.75
	LFFBV-4	0555119	3/8	098268805451	120	31	10.75
	LFFBV-4	0555120	1/2	098268805468	120	48	10.75
	LFFBV-4	0555121	3/4	098268805475	60	48	15.50
	LFFBV-4	0555122	1	098268805482	30	38	21.75
	LFFBV-4	0555123	1 1/4	098268805499	20	29	34.75
	LFFBV-4	0555124	1 1/2	098268805505	16	37	53.50
	LFFBV-4	0555125	2	098268805512	6	22	80.50
	LFFBV-4	0555126	2 1/2	098268805529	5	40	227.00
	LFFBV-4	0555127	3	098268805536	5	60	323.00

Series LFFBVS-4

Solder Ends - 150 WSP/600 WOG for Sizes 1/4-2 & 125WSP/400 WOG for sizes 2 1/2-3

LEAD FREE*	Model	Ordering Code	Size (in.)	UPC	Qty. Per Carton	Weight Per Carton (lbs.)	List Price (each)
	LFFBVS-4	0555128	1/2	098268805543	120	43	10.75
	LFFBVS-4	0555129	3/4	098268805727	60	44	15.50
	LFFBVS-4	0555130	1	098268805734	30	35	21.75
	LFFBVS-4	0555131	1 1/4	098268805789	20	28	34.75
	LFFBVS-4	0555132	1 1/2	098268806120	16	39	53.50
	LFFBVS-4	0555133	2	098268455113	6	23	80.50
	LFFBVS-4	0555134	2 1/2	098268806175	5	36	227.00
	LFFBVS-4	0555135	3	098268806182	5	55	323.00



LFFBV-3-Press



LFFBV-4

*The wetted surface of this product contacted by consumable water contains less than 0.25% of lead by weight.

Consult factory for ordering code numbers of special models/options.

Model	Ordering Code	Size (in.)	UPC	Qty. Per Carton	Weight Per Carton (lbs.)	List Price (each)
-------	---------------	------------	-----	-----------------	--------------------------	-------------------

Brass Ball Valves - Full Port - 2 Piece (cont.)

Series LFFBV-PEX

PEX Ends - 400 WOG

Model	Ordering Code	Size (in.)	UPC	Qty. Per Carton	Weight Per Carton (lbs.)	List Price (each)
LFFBV-PEX	0555272	1/2	098268450347	40	12	10.50
LFFBV-PEX	0555273	3/4	098268450354	40	18	16.25
LFFBV-PEX	0555274	1	098268450361	40	28	31.50

LEAD FREE*

Handle Options

The handle kits on this page will only fit Series FBV-3C ball valves manufactured in our WNV facility. If the ball valve has the NSF logo shown to right on the lever handle, use these kits.



Kit No.	Ordering Code	Size (in.)	UPC	Qty. Per Carton	Weight Per Carton (lbs.)	List Price (each)
---------	---------------	------------	-----	-----------------	--------------------------	-------------------

FBV-3C Tee Handle Kits

ITHK-10	0548514	1/4 - 1/2	098268454956	20	3.4	9.25
ITHK-11	0548515	3/4	098268454963	20	4.8	13.50
ITHK-12	0548516	1	098268454970	20	6.0	16.75

FBVS-3C Tee Handle Kits

ITHK-13	0548527	1/2	098268455083	20	34	9.25
ITHK-14	0548528	3/4	098268455090	20	2.5	13.50
ITHK-15	0548529	1	098268455106	20	60	16.75

FBV-3C/FBVS-3C Stem Extension Kits

#5 SXI-HK	0548517	1/4 - 1/2	098268454987	20	4.3	22.25
#6 SXI-HK	0548518	3/4	098268454994	20	4.7	31.75
#7 SXI-HK	0548519	1 - 1 1/4	098268455007	20	7.2	40.00
#8 SXI-HK	0548520	1 1/2	098268455014	20	8.2	51.25
#9 SXI-HK	0548521	2	098268455021	20	8.8	55.25

FBV-3C/FBVS-3C Memory Stop Kits

#5 MSI-HK	0548522	1/4 - 1/2	098268455038	10	5.0	3.25
#6 MSI-HK	0548523	3/4	098268455045	10	5.0	3.50
#7 MSI-HK	0548524	1 - 1 1/4	098268455052	10	5.0	4.50
#8 MSI-HK	0548525	1 1/2	098268455069	10	5.0	4.75
#9 MSI-HK	0548526	2	098268455076	10	7.0	5.50

Stainless Steel Lever Handle Kits

ILHK-SS	0548493	1/4 - 1/2	098268539882	10	0.9	12.00
ILHK-SS	0548494	3/4	098268539879	10	1.3	14.00
ILHK-SS	0548495	1 - 1 1/4	098268539868	10	1.8	16.25
ILHK-SS	0548496	1 1/2	098268539855	10	3.1	22.25
ILHK-SS	0548497	2	098268539848	10	4.0	24.00
ILHK-SS	0548498	2 1/2	098268539831	10	5.0	51.25
ILHK-SS	0548499	3	098268539820	10	6.0	63.75



Tee Handle



Stem Extension

*The wetted surface of this product contacted by consumable water contains less than 0.25% of lead by weight.

Consult factory for ordering code numbers of special models/options.

Model	Ordering Code	Size (in.)	UPC	Qty. Per Carton	Weight Per Carton (lbs.)	List Price (each)
-------	---------------	------------	-----	-----------------	--------------------------	-------------------

Carbon/Stainless Steel Ball Valves

Series C-FBV-1



C-FBV-1

Carbon - Full Port - Threaded Ends - 125 WSP/1000 WOG

C-FBV-1	0548000	1/4	098268386660	80	48	\$ 92.00
C-FBV-1	0548001	3/8	098268386677	80	44	92.00
C-FBV-1	0548002	1/2	098268386684	80	64	107.00
C-FBV-1	0548003	3/4	098268386691	60	71	128.50
C-FBV-1	0548004	1	098268386707	36	73	172.50
C-FBV-1	0548005	1 1/4	098268386714	24	73	285.00
C-FBV-1	0548006	1 1/2	098268386721	12	53	352.50
C-FBV-1	0548007	2	098268386738	8	48	427.50
C-FBV-1	0548008	2 1/2	098268386745	1	16	1,099.00
C-FBV-1	0548009	3	098268386752	1	21	1,285.00

Series S-FBV-1



S-FBV-1

316 Stainless Steel - Full Port - Threaded Ends - 125 WSP/1000 WOG

S-FBV-1	0548010	1/4	098268386769	80	62	112.50
S-FBV-1	0548011	3/8	098268386776	80	62	119.50
S-FBV-1	0548012	1/2	098268386783	80	62	133.00
S-FBV-1	0548013	3/4	098268386790	60	64	174.50
S-FBV-1	0548014	1	098268386806	36	66	244.50
S-FBV-1	0548015	1 1/4	098268386813	24	79	335.50
S-FBV-1	0548016	1 1/2	098268386820	12	59	462.50
S-FBV-1	0548017	2	098268386837	8	53	645.50
S-FBV-1	0548018	2 1/2	098268386844	1	59	1,178.00
S-FBV-1	0548019	3	098268386851	1	42	1,352.00

Gas Ball Valves

Series GBV



GBV

Two-Piece - Brass - CSA/UL

GBV	0545001	3/8	098268074352	144	44	9.50
GBV	0545003	1/2	098268074376	144	50	9.50
GBV	0545005	3/4	098268074390	72	37	12.75
GBV	0545007	1	098268074413	60	72	28.00
†GBV-FL	0545002	1/2 x 3/8	098268074369	144	54	8.75
†GBV-FL	0545004	1/2 x 1/2	098268074383	144	27	8.75
†GBV-FL	0545006	3/4 x 15/16	098268074406	72	42	22.00

†FL = NPT x Flare.

One-Piece - Brass - CSA/UL



GBV-1

GBV-1	0544999	1/2	098268792362	144	65	20.00
GBV-1	0545000	3/4	098268792379	96	67	25.00

*The wetted surface of this product contacted by consumable water contains less than 0.25% of lead by weight.

Consult factory for ordering code numbers of special models/options.

Ball Valves

Model	Ordering Code	Size (in.)	UPC	Qty. Per Carton	Weight Per Carton (lbs.)	List Price (each)
-------	---------------	------------	-----	-----------------	--------------------------	-------------------

Cast Iron Ball Valves Series G4000



G-4000-M1

Flanged, Full Port Ball Valves - 125 WSP, 200 CWP

G4000M1	0822650	2	098268908831	1	32	\$ 723.50
G4000M1	0822651	2 1/2	098268908848	1	50	860.00
G4000M1	0822652	3	098268908855	1	59	981.00
G4000M1	0822653	4	098268908862	1	89	1,048.00
G4000M1	0822654	6	098268908879	1	155	2,047.00

*The wetted surface of this product contacted by consumable water contains less than 0.25% of lead by weight.
Consult factory for ordering code numbers of special models/options.

Silent Check Valves

Model	Ordering Code	Size (in.)	UPC	Qty. Per Carton	Weight Per Carton (lbs.)	List Price (each)
-------	---------------	------------	-----	-----------------	--------------------------	-------------------

Silent Check Valves

Series ICV

Cast Iron, Wafer Style, Double Disc - Fits ANSI Class 125 or 150 Flanges - API 594, 200 CWP



ICV-125-2-2-T

Model	Ordering Code	Size (in.)	UPC	Qty. Per Carton	Weight Per Carton (lbs.)	List Price (each)
ICV-125-2-2-T	0625500	2	098268878738	1	5	\$ 322.50
ICV-125-2-2-T	0625501	2 1/2	098268878837	1	6	511.50
ICV-125-2-2-T	0625502	3	098268878745	1	8	537.50
ICV-125-2-2-T	0625503	4	098268878752	1	12	681.50
ICV-125-2-2-T	0625504	5	098268878769	1	16	1,106.00
ICV-125-2-2-T	0625505	6	098268878776	1	25	1,211.00
ICV-125-2-2-T	0625506	8	098268878783	1	48	1,865.00
ICV-125-2-2-T	0625507	10	098268878790	1	78	2,952.00
ICV-125-2-2-T	0625508	12	098268878806	1	121	3,956.00

LEAD FREE*

Bronze Silent Check Valves -

Warning: Not to be used for reciprocating air compressor service.

Series 600 and LF600

Threaded Ends - Maxi-flo Check Valves - PTFE Seat - 15 WSP/400 WOG



LF600

Model	Ordering Code	Size (in.)	UPC	Qty. Per Carton	Weight Per Carton (lbs.)	List Price (each)
LF600	0555173	1/4	098268432831	40	28	\$ 80.50
LF600	0555174	3/8	098268432848	40	20	80.50
LF600	0555175	1/2	098268432855	40	17	80.50
LF600	0555176	3/4	098268432862	40	28	95.75
LF600	0555177	1	098268432879	32	41	131.00
LF600	0555178	1 1/4	098268432886	12	25	187.50
LF600	0555179	1 1/2	098268432893	6	19	232.00
LF600	0555180	2	098268432909	6	27	348.00

LEAD FREE*

Series LF601 and 600-Z3

Threaded Ends - Bronze Seat, Viton® Disc - 400 WOG

Model	Ordering Code	Size (in.)	UPC	Qty. Per Carton	Weight Per Carton (lbs.)	List Price (each)
LF601	0123071	1/4	098268653328	40	24	94.50
LF601	0123072	3/8	098268653335	40	24	94.50
LF601	0123073	1/2	098268653342	40	19	94.50

LEAD FREE*

Solder Ends - Bronze Seat, Viton® Disc - 400 WOG



LF601S

Model	Ordering Code	Size (in.)	UPC	Qty. Per Carton	Weight Per Carton (lbs.)	List Price (each)
LF601S	0555181	1/2	098268432916	40	13	81.00
LF601S	0555182	3/4	098268432923	40	28	107.00
LF601S	0555183	1	098268432930	32	35	146.00

LEAD FREE*

Series LF6

Midi Check Valves - Threaded Ends

Model	Ordering Code	Size (in.)	UPC	Qty. Per Carton	Weight Per Carton (lbs.)	List Price (each)
LF6	0123066	1/4	098268653151	50	17	67.50
LF6	0123067	3/8	098268653168	50	15	67.50
LF6	0123068	1/2	098268653175	50	14	67.50
LF6	0123069	3/4	098268653182	50	25	78.50
LF6	0123070	1	098268653311	50	41	93.00

LEAD FREE*

Viton® is a registered trademark of DuPont Dow Elastomers

*The wetted surface of this product contacted by consumable water contains less than 0.25% of lead by weight.

Consult factory for ordering code numbers of special models/options.

Brass Check Valves

Model	Ordering Code	Size (in.)	UPC	Qty. Per Carton	Weight Per Carton (lbs.)	List Price (each)
-------	---------------	------------	-----	-----------------	--------------------------	-------------------

Brass Check Valve

Series LFWCV

Threaded Ends - 125 WSP/200 WOG

Model	Ordering Code	Size (in.)	UPC	Qty. Per Carton	Weight Per Carton (lbs.)	List Price (each)
LFWCV	0123494	1/2	098268697032	120	48	\$ 17.50
LFWCV	0123495	3/4	098268697049	100	55	35.00
LFWCV	0123496	1	098268697070	80	60	50.50

Solder Ends - 125 WSP/200 WOG

Model	Ordering Code	Size (in.)	UPC	Qty. Per Carton	Weight Per Carton (lbs.)	List Price (each)
LFWCVS	0123503	1/2	098268697186	160	112	17.50
LFWCVS	0123504	3/4	098268697193	100	60	22.00
LFWCVS	0123505	1	098268697209	80	64	35.00



LFWCV

LEAD FREE*

LEAD FREE*

Model	Ordering Code	Size (in.)	UPC	Qty. Per Carton	Weight Per Carton (lbs.)	List Price (each)
-------	---------------	------------	-----	-----------------	--------------------------	-------------------

Cast Iron Check Valves

Series 411

ANSI 125 Flanged Swing Checks - UL/FM Listed Except 2" - (200 WOG)

Model	Ordering Code	Size (in.)	UPC	Qty. Per Carton	Weight Per Carton (lbs.)	List Price (each)
411	0390010	**2	098268025606	1	20	\$ 316.00
411	0390015	2 1/2	098268025613	1	43	345.00
411	0390020	3	098268025620	1	61	507.00
411	0390025	4	098268025637	1	89	756.00
411	0390030	6	098268025644	1	166	1,163.00
411	0390035	8	098268025651	1	310	2,098.00
411	0390040	10	098268025668	1	525	3,748.00



411

LEAD FREE*

**Non UL/FM listed.

Detector Check

Model	Ordering Code	Size (in.)	UPC	Qty. Per Carton	Weight Per Carton (lbs.)	List Price (each)
-------	---------------	------------	-----	-----------------	--------------------------	-------------------

Stainless Steel Single Detector Checks Valves

Series SS07F

Drilled, tapped and plugged for right or left bypass line.

125# Flanged Connection, Less Bypass Assembly. UL/FM

Model	Ordering Code	Size (in.)	UPC	Qty. Per Carton	Weight Per Carton (lbs.)	List Price (each)
SS07F	0065130	4	098268920697	1	43	\$ 1,040.00
SS07F	0065131	6	098268920703	1	61	1,692.00
SS07F	0065132	8	098268920710	1	206	3,256.00
SS07F	0065133	10	098268920727	1	128	3,531.00



SS07F

Series SS07F

Optional By-Pass Valves - 3/4" Bypass with GPM/CFM Meter

Model	Ordering Code	Size (in.)	UPC	Qty. Per Carton	Weight Per Carton (lbs.)	List Price (each)
SS07F-CFM	0065135	4	098268920734	1	60	2,033.00
SS07F-GPM	0065136	4	098268920741	1	60	2,033.00
SS07F-CFM	0065137	6	098268920758	1	78	2,759.00
SS07F-GPM	0065138	6	098268920765	1	79	2,759.00
SS07F-CFM	0065139	8	098268920772	1	90	4,323.00
SS07F-GPM	0065140	8	098268920789	1	90	4,323.00
SS07F-CFM	0065141	10	098268920796	1	135	4,701.00
SS07F-GPM	0065142	10	098268920802	1	135	4,701.00

*The wetted surface of this product contacted by consumable water contains less than 0.25% of lead by weight.

Consult factory for ordering code numbers of special models/options.

Cast Iron Gate Valves

9

Gate/Globe/Check Valves



408-OSY-RW



LFWGV

Model	Ordering Code	Size (in.)	UPC	Qty. Per Carton	Weight Per Carton (lbs.)	List Price (each)
-------	---------------	------------	-----	-----------------	--------------------------	-------------------

Cast Iron Gate Valves

Series 405

Flanged Gate Valves - ANSI 125 - 200 WOG - Resilient Wedge, Epoxy Coated, NRS

Model	Ordering Code	Size (in.)	UPC	Qty. Per Carton	Weight Per Carton (lbs.)	List Price (each)
405RW	0700102	2	098268087109	1	28	\$ 260.00
405RW	0700103	2 1/2	098268087116	1	35	332.50
405RW	0700104	3	098268087123	1	57	390.50
405RW	0700105	4	098268087130	1	74	542.50
405RW	0700106	6	098268087147	1	124	913.50
405RW	0700107	8	098268087154	1	219	1,362.00
405RW	0700108	10	098268087161	1	328	2,607.00

Series 408

Resilient Wedge, Epoxy Coated, OSY - UL/FM Listed

Model	Ordering Code	Size (in.)	UPC	Qty. Per Carton	Weight Per Carton (lbs.)	List Price (each)
408-OSY-RW	0702310	2 1/2	098268089134	1	57	541.50
408-OSY-RW	0702315	3	098268089141	1	64	592.50
408-OSY-RW	0702320	4	098268089158	1	94	739.00
408-OSY-RW	0702325	6	098268089165	1	145	1,176.00
408-OSY-RW	0702330	8	098268089172	1	326	1,948.00
408-OSY-RW	0702335	10	098268089189	1	397	3,090.00
408-OSY-RW	0702340	12	098268089196	1	853	3,936.00

Model	Ordering Code	Size (in.)	UPC	Qty. Per Carton	Weight Per Carton (lbs.)	List Price (each)
-------	---------------	------------	-----	-----------------	--------------------------	-------------------

Brass Gate Valves

Series LFWGV

Threaded Ends - 125 WSP/200 WOG

Model	Ordering Code	Size (in.)	UPC	Qty. Per Carton	Weight Per Carton (lbs.)	List Price (each)
LFWGV	0555158	1/2	098268449860	120	73	\$16.25
LFWGV	0555159	3/4	098268449877	80	66	20.00
LFWGV	0555160	1	098268449884	60	71	29.25

Solder Ends - 125 WSP/200 WOG

Model	Ordering Code	Size (in.)	UPC	Qty. Per Carton	Weight Per Carton (lbs.)	List Price (each)
LFWGVS	0555167	1/2	098268449952	120	67	18.50
LFWGVS	0555168	3/4	098268449969	80	68	24.50
LFWGVS	0555169	1	098268449976	60	67	35.75

*The wetted surface of this product contacted by consumable water contains less than 0.25% of lead by weight.

Consult factory for ordering code numbers of special models/options.

Strainers

Model	Ordering Code	Size (in.)	UPC	Qty. Per Carton	Weight Per Carton (lbs.)	List Price (each)
-------	---------------	------------	-----	-----------------	--------------------------	-------------------

Cast Iron Strainers

Series 77

Wye Type - Threaded Connections, - 250 WSP/400 WOG

20 Mesh Screen (3" has 3/64" Perforated Screen) - Tapped Blowdown



77SM1

77SM1-20	0220201	1/4	098268643138	12	32	\$ 31.00
77SM1-20	0220200	3/8	098268643121	12	32	31.00
77SM1-20	0220202	1/2	098268643145	12	32	31.00
77SM1-20	0220203	3/4	098268643152	12	60	38.50
77SM1-20	0220204	1	098268643169	6	29	42.00
77SM1-20	0220205	1 1/4	098268643176	6	41	54.50
77SM1-20	0220206	1 1/2	098268643183	4	33	65.50
77SM1-20	0220208	2	098268643190	2	47	101.00
77SM1-20	0220209	2 1/2	098268643206	1	27	224.50
77SM1-3/64	0220210	3	098268643275	1	27	315.00

Wye Type - Threaded Connections - 250 WSP/400 WOG

20 Mesh Screen (2 1/2" and 3" has 3/64" Perforated Screen) - Tapped Blowdown



77SI

77SI	0220082	1/4	098268011777	10	12	15.75
77SI	0220071	1/2	098268011685	10	15	19.00
77SI	0220073	3/4	098268011708	10	20	20.50
77SI	0220075	1	098268011722	8	25	25.25
77SI	0220077	1 1/4	098268011739	6	31	41.00
77SI	0220079	1 1/2	098268011753	4	26	46.75
77SI	0220081	2	098268011760	3	36	66.25
77SI	0220084	2 1/2	098268011791	1	26	157.50
77SI	0220085	3	098268011807	1	35	224.50

Flanged Connections - ANSI 125 Flanged Ends - with Tapped Closure Plug - 125 WSP/200 WOG



77F-DI-125

77F-DI-125	0825200	2	098268051704	1	20	166.50
77F-DI-125	0825201	2 1/2	098268051711	1	36	183.50
77F-DI-125	0825202	3	098268051728	1	37	266.50
77F-DI-125	0825203	4	098268051735	1	70	333.00
77F-DI-125	0825204	5	098268051742	1	110	704.00
77F-DI-125	0825205	6	098268051759	1	146	710.50
77F-DI-125	0825206	8	098268051803	1	254	1,148.00
77F-DI-125	0825207	10	098268051810	1	460	2,095.00
77F-DI-125	0825208	12	098268051827	1	573	3,116.00

Flanged Connections - Epoxy Coated FDA Approved - ANSI 125 Flanged Ends - with Tapped Closure Plug - 200 WOG



77F-DI-FDA-125

77F-DI-FDA-125	0825209	2	098268051834	1	21	423.50
77F-DI-FDA-125	0825210	2 1/2	098268051841	1	38	449.00
77F-DI-FDA-125	0825211	3	098268051858	1	38	474.00
77F-DI-FDA-125	0825212	4	098268051872	1	66	726.50
77F-DI-FDA-125	0825213	5	098268051889	1	100	1,148.00
77F-DI-FDA-125	0825214	6	098268051896	1	147	1,366.00
77F-DI-FDA-125	0825215	8	098268051902	1	311	1,687.00
77F-DI-FDA-125	0825216	10	098268051919	1	494	3,101.00
77F-DI-FDA-125	0825217	12	098268051940	1	663	6,757.00

*The wetted surface of this product contacted by consumable water contains less than 0.25% of lead by weight.

Consult factory for ordering code numbers of special models/options.

Strainers

Model	Ordering Code	Size (in.)	UPC	Qty. Per Carton	Weight Per Carton (lbs.)	List Price (each)
-------	---------------	------------	-----	-----------------	--------------------------	-------------------

Ductile Iron Strainers

Series 77 (cont.)

Flanged Connections - ANSI 250 Flanged Ends - Tapped with Closure Plug - 250 WSP/500 WOG

Model	Ordering Code	Size (in.)	UPC	Qty. Per Carton	Weight Per Carton (lbs.)	List Price (each)
77F-DI-250	0823039	2	098268880786	1	25	\$ 402.50
77F-DI-250	0823040	2 1/2	098268880793	1	42	431.50
77F-DI-250	0823041	3	098268880809	1	50	484.00
77F-DI-250	0823042	4	098268880816	1	90	878.00
77F-DI-250	0823043	5	098268880823	1	160	1,459.00
77F-DI-250	0823044	6	098268880830	1	178	1,716.00
77F-DI-250	0823045	8	098268880847	1	282	2,822.00
77F-DI-250	0823046	10	098268880854	1	590	5,860.00
77F-DI-250	0823047	12	098268880861	1	890	9,131.00

Bronze Strainers

Series LF777

Wye Type - Threaded Connections - Not Tapped - 400 WOG/125 WSP (4" - 125 WSP/300 WOG)



LF777

Model	Ordering Code	Size (in.)	UPC	Qty. Per Carton	Weight Per Carton (lbs.)	List Price (each)
LF777M1-20	0123075	1/4	098268653366	12	6.5	98.75
LF777M1-20	0123076	3/8	098268653373	12	6.1	98.75
LF777M1-20	0123080	1/2	098268653410	12	9.0	98.75
LF777M1-20	0123086	3/4	098268653489	12	14	121.00
LF777M120	0123095	1	098268653878	6	12	139.50
LF777M1-20	0123106	1 1/4	098268654257	6	15	183.00
LF777M1-20	0123113	1 1/2	098268657951	4	16	204.50
LF777M3-20	0123162	2	098268664966	3	21	332.50
LF777-20	0123126	2 1/2	098268664560	2	22	926.00
LF777-04	0123129	3	098268664607	1	23	1,009.00
LF777-12	0123146	4	098268664799	1	36	2,172.00

Wye Type - Solder End Connections - Not Tapped for Closure Plug - 125 WSP/400 WOG



LFS777

Model	Ordering Code	Size (in.)	UPC	Qty. Per Carton	Weight Per Carton (lbs.)	List Price (each)
LFS777M1-20	0123147	1/2	098268664805	12	12	102.00
LFS777M1-20	0123148	3/4	098268664812	12	15	124.50
LFS777M1-20	0123149	1	098268664829	6	17	142.50
LFS777M1-20	0123150	1 1/4	098268664836	12	34	186.00
LFS777M1-20	0123151	1 1/2	098268664843	6	26	208.00
LFS777M3-20	0123122	2	098268664522	6	46	332.50

Wye Type - Threaded Connections - with Tapped Retainer Cap (closure plug not provided) - 125 WSP/400 WOG (4" - 125 WSP/300 WOG)



LF777S

Model	Ordering Code	Size (in.)	UPC	Qty. Per Carton	Weight Per Carton (lbs.)	List Price (each)
LF777SM1-20	0123081	1/2	098268653427	12	8.4	102.00
LF777SM1-20	0124002	3/4	098268769951	12	13	124.50
LF777SM1-20	0124003	1	098268769968	6	11	142.50
LF777SM1-20	0124004	1 1/4	098268770193	6	14	186.00
LF777SM1-20	0124005	1 1/2	098268770223	4	14	208.00
LF777SM3-20	0124006	2	098268770285	3	18	335.50
LF777S-20	0124007	2 1/2	098268770698	2	22	926.00
LF777S-04	0124008	3	098268771374	1	23	1,009.00
LF777S-12	0124009	4	098268771435	1	43	2,172.00

*The wetted surface of this product contacted by consumable water contains less than 0.25% of lead by weight.

Consult factory for ordering code numbers of special models/options.

Strainers

Model	Ordering Code	Size (in.)	UPC	Qty. Per Carton	Weight Per Carton (lbs.)	List Price (each)
-------	---------------	------------	-----	-----------------	--------------------------	-------------------

Bronze Strainers - (cont.)

Series LF777

Wye Type - Solder End Connections - with Tapped Retainer Cap (closure plug not provided) - 125 WSP/400 WOG

Model	Ordering Code	Size (in.)	UPC	Qty. Per Carton	Weight Per Carton (lbs.)	List Price (each)
LFS777SM1-20	0123132	1/2	098268664638	12	9	\$ 102.00
LFS777SM1-20	0123133	3/4	098268664645	12	12	124.50
LFS777SM1-20	0123134	1	098268664652	6	12	142.50
LFS777SM1-20	0123135	1 1/4	098268664669	12	32	186.00
LFS777SM1-20	0123136	1 1/2	098268664676	6	24	208.00
LFS777SM3-20	0123121	2	098268664515	6	40	332.50

Wye Type - Threaded Connections - with Tapped Retainer Cap and Closure Plug - 125 WSP/400 WOG

Model	Ordering Code	Size (in.)	UPC	Qty. Per Carton	Weight Per Carton (lbs.)	List Price (each)
LF777SI	0379110	3/8	098268285581	80	38	20.50
LF777SI	0379111	1/2	098268285598	48	29	46.25
LF777SI	0379112	3/4	098268285604	36	33	62.00
LF777SI	0379113	1	098268285611	24	36	71.25
LF777SI	0379114	1 1/4	098268285628	18	40	102.00
LF777SI	0379115	1 1/2	098268285635	12	35	145.00
LF777SI	0379116	2	098268285642	6	30	214.00



LF777SI

Wye Type - Threaded Connections - with Tapped Retainer Cap and Closure Plug - 125 WSP/300 WOG

Model	Ordering Code	Size (in.)	UPC	Qty. Per Carton	Weight Per Carton (lbs.)	List Price (each)
LF777SI	†0379117	2 1/2	098268285659	3	36	669.50
LF777SI	†0379118	3	098268285666	2	34	730.00

Wye Type - Solder Connections - with Tapped Retainer Cap and Closure Plug - 125 WSP/400 WOG

Model	Ordering Code	Size (in.)	UPC	Qty. Per Carton	Weight Per Carton (lbs.)	List Price (each)
LFS777SI	0379119	1/2	098268285673	48	22	46.25
LFS777SI	0379120	3/4	098268285680	36	24	62.00
LFS777SI	0379121	1	098268285697	24	24	71.25
LFS777SI	0379122	1 1/4	098268285703	18	29	102.00
LFS777SI	0379123	1 1/2	098268285734	12	27	145.00
LFS777SI	0379124	2	098268285758	6	24	214.00

Bronze flanged - Class 150 - with Tapped Closure Plug - 150 WSP/225 WOG

Model	Ordering Code	Size (in.)	UPC	Qty. Per Carton	Weight Per Carton (lbs.)	List Price (each)
77F-BI	0823048	2	098268880878	1	20	2,304.00
77F-BI	0823049	2 1/2	098268880885	1	32	3,318.00
77F-BI	0823050	3	098268880892	1	44	4,379.00
77F-BI	0823051	4	098268880908	1	68	6,646.00
77F-BI	0823052	6	098268880915	1	134	11,502.00
77F-BI	0823053	8	098268880922	1	210	17,755.00

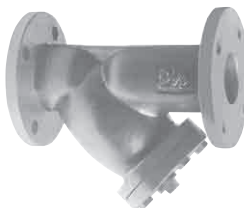

77F-BI

*The wetted surface of this product contacted by consumable water contains less than 0.25% of lead by weight.
Consult factory for ordering code numbers of special models/options.

Strainers

Model	Ordering Code	Size (in.)	UPC	Qty. Per Carton	Weight Per Carton (lbs.)	List Price (each)
-------	---------------	------------	-----	-----------------	--------------------------	-------------------

Bronze Strainers (cont.)

Series LF27

Threaded Connections - "V" Type, Water Strainers - 250 CWP



LF27

LEAD FREE*	Model	Ordering Code	Size (in.)	UPC	Qty. Per Carton	Weight Per Carton (lbs.)	List Price (each)
	LF27-40	0555157	1/8	098268432824	50	13	\$ 53.75
	LF27-40	0123053	1/4	098268652949	50	23	82.25
	LF27-40	0123064	3/8	098268653137	50	45	101.00
	LF27-40	0555156	1/2	098268432817	25	25	131.00

Series LF745

45° Wye Type with Hand Removable Clean-Out Plug - 250 WOG

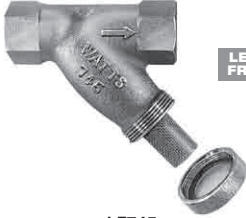

LF745

LEAD FREE*	Model	Ordering Code	Size (in.)	UPC	Qty. Per Carton	Weight Per Carton (lbs.)	List Price (each)
	LF745	0555155	3/4	098268432800	12	2.8	197.00

Series LF17

Union End In-line Strainer - 250 WOG

LEAD FREE*	Model	Ordering Code	Size (in.)	UPC	Qty. Per Carton	Weight Per Carton (lbs.)	List Price (each)
	LF17	0125079	3/4	098268847987	12	20	209.00
	LF17	0125080	1	098268847994	12	20	231.50

Plastic Strainers

Series P777

Wye Type



P777-100

	P777-100	0384765	1/4	098268235272	50	5.0	12.25
	P777-100	0384766	3/8	098268235289	50	4.0	12.25

*The wetted surface of this product contacted by consumable water contains less than 0.25% of lead by weight.

Consult factory for ordering code numbers of special models/options.

Model	Ordering Code	Size (in.)	UPC	Qty. Per Carton	Weight Per Carton (lbs.)	List Price (each)
-------	---------------	------------	-----	-----------------	--------------------------	-------------------

Carbon Steel Strainers

Series 88CSI

Threaded Connections - Class 600 - with Tapped Closure Plug - 600 WSP/1480 WOG



88CSI-T

88CSI-T	0823000	1/2	098268874457	1	1.6	\$ 295.00
88CSI-T	0823001	3/4	098268879377	1	2.6	381.50
88CSI-T	0823002	1	098268879384	1	4.6	539.00
88CSI-T	0823003	1 1/4	098268879391	1	5.6	646.50
88CSI-T	0823004	1 1/2	098268879407	1	2.9	880.00
88CSI-T	0823005	2	098268879414	1	14	1,226.00

Socket Weld Connections - Class 600 - with Tapped Closure Plug - 600 WSP/1480 WOG

88CSI-SW	0823008	1/2	098268879421	1	1.6	295.00
88CSI-SW	0823009	3/4	098268879438	1	0.8	381.50
88CSI-SW	0823010	1	098268879445	1	1.5	539.00
88CSI-SW	0823011	1 1/4	098268879452	1	2.0	646.50
88CSI-SW	0823012	1 1/2	098268879469	1	9.4	880.00
88CSI-SW	0823013	2	098268879476	1	4.2	1,226.00

Series 77F

Flanged Connections - Class 150 - with Tapped Closure Plug - 150 WSP/285 WOG



77F-CSI

77F-CSI	0823016	1/2	098268879483	1	6.0	694.50
77F-CSI	0823017	3/4	098268879490	1	7.0	912.00
77F-CSI	0823018	1	098268879506	1	9.0	1,228.00
77F-CSI	0823019	1 1/2	098268879513	1	12	1,572.00
77F-CSI	0823020	2	098268879520	1	20	1,602.00
77F-CSI	0823021	2 1/2	098268879537	1	36	2,115.00
77F-CSI	0823022	3	098268879544	1	36	2,325.00
77F-CSI	0823023	4	098268879551	1	75	3,806.00
77F-CSI	0823024	5	098268879568	1	160	6,820.00
77F-CSI	0823025	6	098268879575	1	210	11,548.00

Stainless Steel Strainers

Series 87SI

Threaded Connections - Class 300 - with Tapped Closure Plug - 300 WSP/720 WOG



87SI

87SI-T	0823073	1/2	098268881110	1	0.8	388.00
87SI-T	0823074	3/4	098268881127	1	1.1	480.00
87SI-T	0823075	1	098268881134	1	2.0	675.00
87SI-T	0823076	1 1/4	098268881141	1	2.3	815.50
87SI-T	0823077	1 1/2	098268881158	1	3.0	1,124.00
87SI-T	0823078	2	098268881165	1	4.7	1,440.00
87SI-T	0823079	2 1/2	098268881172	1	13	2,333.00
87SI-T	0823080	3	098268881189	1	15	3,679.00

Socket Weld Connections - Class 300 - with Tapped Closure Plug - 300 WSP/720 WOG

87SI-SW	0823081	1/2	098268881196	1	0.5	388.00
87SI-SW	0823082	3/4	098268881202	1	0.8	480.00
87SI-SW	0823083	1	098268881219	1	1.5	675.00
87SI-SW	0823084	1 1/4	098268881226	1	2.0	815.50
87SI-SW	0823085	1 1/2	098268881233	1	2.8	1,124.00
87SI-SW	0823086	2	098268881240	1	4.2	1,440.00
87SI-SW	0823087	2 1/2	098268881257	1	13	2,333.00
87SI-SW	0823088	3	098268881264	1	15	3,679.00

*The wetted surface of this product contacted by consumable water contains less than 0.25% of lead by weight.

Consult factory for ordering code numbers of special models/options.

Strainers

Model	Ordering Code	Size (in.)	UPC	Qty. Per Carton	Weight Per Carton (lbs.)	List Price (each)
-------	---------------	------------	-----	-----------------	--------------------------	-------------------

Stainless Steel Strainers - (cont.)

Series 88S

Wye Type - Threaded Connections - ANSI 600 - with Tapped Closure Plug - 600 WSP/1440 WOG



88S

88S	0701000	1/4	098268088373	12	13	\$ 717.50
88S	0701002	3/8	098268088380	12	22	717.50
88S	0701004	1/2	098268088403	12	41	750.00
88S	0701006	3/4	098268088427	12	31	942.50
88S	0701008	1	098268088441	6	25	1,130.00
88S	0701010	1 1/4	098268088465	4	27	1,594.00
88S	0701012	1 1/2	098268088489	3	33	1,952.00
88S	0701014	2	098268088502	3	42	2,339.00

Series 77

Flanged Connections, Class 150 - with Tapped Closure Plug - 150 WSP/275 WOG



77F-CSSI

77F-CSSI	0823089	1/2	098268881271	1	6.0	1,389.00
77F-CSSI	0823090	3/4	098268881288	1	9.4	1,579.00
77F-CSSI	0823091	1	098268881295	1	9.0	1,632.00
77F-CSSI	0823092	1 1/2	098268881301	1	12	1,838.00
77F-CSSI	0823093	2	098268881318	1	21	2,584.00
77F-CSSI	0823094	2 1/2	098268881325	1	32	3,263.00
77F-CSSI	0823095	3	098268881332	1	36	3,392.00
77F-CSSI	0823096	4	098268881349	1	67	6,153.00
77F-CSSI	0823097	6	098268881356	1	160	10,979.00

Grooved Connections - ANSI 125 Grooved Ends - 200 WOG



77F-SS

77F-SS	0821110	2 1/2	098268802160	1	21	435.00
77F-SS	0821111	3	098268802177	1	24	495.50
77F-SS	0821112	4	098268802184	1	37	581.50
77F-SS	0821114	6	098268802207	1	58	1,174.00
77F-SS	0821115	8	098268802221	1	90	2,506.00
77F-SS	0821116	10	098268802238	1	140	2,963.00
77F-SS	0821117	12	098268802245	1	230	10,422.00

Flanged Connections - ANSI 125 Flanged Ends - 200 WOG



77G-SS

77G-SS	0821160	2 1/2	098268264920	1	10	466.50
77G-SS	0821161	3	098268264937	1	12	570.00
77G-SS	0821162	4	098268264944	1	21	617.00
77G-SS	0821164	6	098268264968	1	37	775.50
77G-SS	0821165	8	098268264975	1	60	1,273.00
77G-SS	0821166	10	098268264982	1	71	6,822.00
77G-SS	0821167	12	098268264999	1	119	9,888.00

LEAD FREE*

LEAD FREE*

LEAD FREE*

*The wetted surface of this product contacted by consumable water contains less than 0.25% of lead by weight.

Consult factory for ordering code numbers of special models/options.

Basket Strainers

Model	Ordering Code	Size (in.)	UPC	Qty. Per Carton	Weight Per Carton (lbs.)	List Price (each)
-------	---------------	------------	-----	-----------------	--------------------------	-------------------

Cast Iron Simplex Basket Strainers Series 97FB

Flanged Connections - Class 125 - Bolted Cover - 125 WSP/200 WOG



97FB-CIB

LEAD FREE*

97FB-CIB	0823054	2	098268880939	1	27	\$ 637.00
97FB-CIB	0823055	2 1/2	098268880946	1	37	849.00
97FB-CIB	0823056	3	098268880953	1	52	931.50
97FB-CIB	0823057	4	098268880960	1	70	1,227.00
97FB-CIB	0823058	5	098268880977	1	90	1,829.00
97FB-CIB	0823059	6	098268880984	1	124	2,492.00
97FB-CIB	0823060	8	098268880991	1	270	4,217.00
97FB-CIB	0823061	10	098268881004	1	385	5,037.00
97FB-CIB	0823062	12	098268881011	1	670	7,198.00

Cast 316SS Simplex Basket Strainers

Flanged Connections - Class 150 - Bolted Screen Retainer Cover - 275 WOG



97FB-FSFE

LEAD FREE*

97FB-CSSIB	0823235	2	098268894325	1	22	1,990.00
97FB-CSSIB	0823236	2 1/2	098268894332	1	31	3,247.00
97FB-CSSIB	0823237	3	098268894356	1	42	3,628.00
97FB-CSSIB	0823238	4	098268894363	1	70	6,347.00
97FB-CSSIB	0823239	6	098268894370	1	124	12,442.00

UL/FM Basket Strainer

Flanged Connections - Class 150 - 175 WOG

LEAD FREE*

97FB-FSFE	0823255	3	098268920550	1	130	1,776.00
97FB-FSFE	0823256	4	098268920567	1	120	2,126.00
97FB-FSFE	0823257	6	098268920574	1	300	5,365.00
97FB-FSFE	0823258	8	098268920581	1	560	7,103.00
97FB-FSFE	0823259	10	098268920598	1	570	9,311.00

7
Strainers

*The wetted surface of this product contacted by consumable water contains less than 0.25% of lead by weight.
Consult factory for ordering code numbers of special models/options.

Flow Measurement Valves

Model	Ordering Code	Size (in.)	UPC	Qty. Per Carton	Weight Per Carton (lbs.)	List Price (each)
-------	---------------	------------	-----	-----------------	--------------------------	-------------------

Flow Balancing Valves - Series CSM



CSM-61-M1

Threaded Ends

CSM-61-M1-T	0856736	1/2	098268631470	24	19	\$ 117.00
CSM-61-M1-T	0856738	3/4	098268631500	24	23	126.50
CSM-61-M1-T	0856740	1	098268631531	12	17	154.00
CSM-61-M1-T	0856742	1 1/4	098268631395	12	28	233.50
CSM-61-M1-T	0856744	1 1/2	098268631425	6	17	283.50
CSM-61-M1-T	0856746	2	098268631449	6	31	399.00
CSM-61-M1-T	0856734	2 1/2	098268782134	1	15	855.00
CSM-61-M1-T	0856729	3	098268782141	1	18	1,412.00

LEAD FREE*

LFCSM-61-MI-S	0856809	1/2	098268017748	24	18	144.00
LFCSM-61-MI-S	0856810	3/4	098268463446	24	23	158.50
LFCSM-61-MI-S	0856811	1	098268463453	12	19	192.50
LFCSM-61-MI-S	0856812	1 1/4	098268463460	12	17	292.00
LFCSM-61-MI-S	0856813	1 1/2	098268463477	6	27	354.50
LFCSM-61-M1-S	0856814	2	098268463484	10	55	498.50

Flanged Ends



CSM-81-F

CSM-81-F	0036540	2 1/2	098268832372	1	32	1,022.00
CSM-81-F	0036541	3	098268832389	1	42	1,391.00
CSM-81-F	0036535	4	098268410051	1	80	1,848.00
CSM-81-F	0036542	5	098268832396	1	120	3,674.00
CSM-81-F	0036543	6	098268832402	1	101	4,460.00
CSM-81-F	0036544	8	098268832419	1	173	10,487.00

Grooved Connections



CSM-91

CSM-91	0036600	2 1/2	098268633689	1	25	655.50
CSM-91	0036601	3	098268633696	1	28	1,004.00
CSM-91	0036602	4	098268633702	1	39	1,388.00
CSM-91	0036603	5	098268633719	1	85	2,543.00
CSM-91	0036604	6	098268633726	1	125	2,667.00
CSM-91	0036605	8	098268633733	1	315	8,362.00
CSM-91	0036606	10	098268633740	1	465	11,186.00

Triple Duty Valves - Series TDV



TDV

Grooved Connections

TDV	0036610	2 1/2	098268633764	1	26	782.00
TDV	0036611	3	098268633771	1	28	973.50
TDV	0036612	4	098268633788	1	45	1,518.00
TDV	0036613	5	098268633795	1	84	1,748.00
TDV	0036614	6	098268633801	1	125	2,536.00
TDV	0036615	8	098268633818	1	315	4,388.00
TDV	0036616	10	098268633825	1	465	7,003.00

*The wetted surface of this product contacted by consumable water contains less than 0.25% of lead by weight.

Consult factory for ordering code numbers of special models/options.

Flow Measurement Valves

Model	Ordering Code	Size (in.)	UPC	Qty. Per Carton	Weight Per Carton (lbs.)	List Price (each)
-------	---------------	------------	-----	-----------------	--------------------------	-------------------

Flange Adapter Kit

Series CSM

ANSI 125 - For CSM-91 and TDV Valves

CSM-91 FLG ADPT	0036620	2 1/2	098268633849	1	12	\$ 69.50
CSM-91 FLG ADPT	0036621	3	098268633856	1	6.9	96.25
CSM-91 FLG ADPT	0036622	4	098268633863	1	10	128.00
CSM-91 FLG ADPT	0036623	5	098268633870	1	12	158.50
CSM-91 FLG ADPT	0036624	6	098268633887	1	12	219.50
CSM-91 FLG ADPT	0036625	8	098268633894	1	21	466.50
CSM-91 FLG ADPT	0036626	10	098268633900	1	17	545.50

Kit consists of two (2) flange halves and one gasket. One kit required for each valve end to be flanged.

Insulation Wrap

for CSM-91-M1 Series

CSM-91-IK	0036630	2 1/2	098268633924	1	4.2	96.00
CSM-91-IK	0036631	3	098268633931	1	4.7	119.00
CSM-91-IK	0036632	4	098268633948	1	4.0	183.00

Differential Pressure Gauge Kits

Series PG

for use with CSM's and FMO's

PG3-0-35-FT	0036516		098268394818	1	10	5,153.00
PG4-0-100IN	0036517		098268394825	1	12	5,153.00
PG5-0-200IN	0036518		098268394832	1	13	5,153.00
PG6-0-50IN	0036519		098268394849	1	12	5,153.00
PG8-0-135IN	0036520		098268394856	1	5.4	5,153.00



PG-8

*The wetted surface of this product contacted by consumable water contains less than 0.25% of lead by weight.
Consult factory for ordering code numbers of special models/options.

Butterfly Valves

How to Order Watts Butterfly Valves

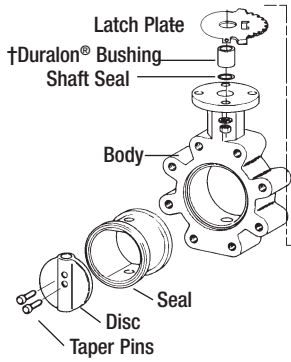

†Duralon® is a registered trademark of Rexnord Corp.

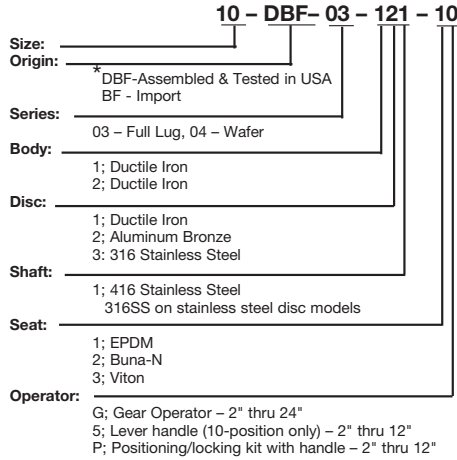

*DBF: Manufactured using domestic and foreign components that have been assembled and tested in the U.S.A
 BF: Import valve

9

Butterfly Valves

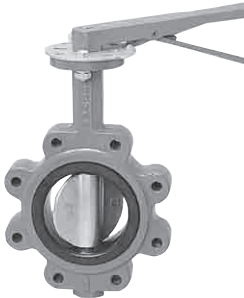

Model DBF-03
Lug, Lever Handle

Model	Ordering Code	Size (in.)	UPC	Qty. Per Carton	Weight Per Carton (lbs.)	List Price (each)
Lug, Lever Handle						
DBF-03-111-15 M2	0525100	2	098268593716	1	12	\$ 333.00
DBF-03-111-15 M2	0525118	2 1/2	098268593891	1	16	343.00
DBF-03-111-15 M2	0525136	3	098268594072	1	15	379.50
DBF-03-111-15 M2	0525154	4	098268594256	1	16	454.00
DBF-03-111-15 M2	0525173	5	098268594430	1	25	606.50
DBF-03-111-15 M2	0525191	6	098268594614	1	31	724.00
DBF-03-111-15 M2	0525210	8	098268594799	1	42	1,005.00
DBF-03-111-15 M2	0525228	10	098268594966	1	63	1,455.00
DBF-03-111-15 M2	0525258	12	098268595260	1	108	2,602.00
LEAD FREE*						
DBF-03-121-15 M2	0525102	2	098268593730	1	11	346.50
DBF-03-121-15 M2	0525120	2 1/2	098268593914	1	12	352.50
DBF-03-121-15 M2	0525138	3	098268594096	1	13	405.50
DBF-03-121-15 M2	0525157	4	098268594270	1	20	539.00
DBF-03-121-15 M2	0525175	5	098268594454	1	25	694.00
DBF-03-121-15 M2	0525193	6	098268594638	1	31	810.00
DBF-03-121-15 M2	0525212	8	098268594812	1	48	1,224.00
DBF-03-121-15 M2	0525260	12	098268595284	1	108	2,619.00
LEAD FREE*						
DBF-03-131-15 M2	0525104	2	098268593754	1	12	434.50
DBF-03-131-15 M2	0525122	2 1/2	098268593938	1	14	499.50
DBF-03-131-15 M2	0525140	3	098268594119	1	11	551.50
DBF-03-131-15 M2	0525159	4	098268594294	1	20	691.50
DBF-03-131-15 M2	0525177	5	098268594478	1	25	985.00
DBF-03-131-15 M2	0525195	6	098268594652	1	31	1,197.00
DBF-03-131-15 M2	0525214	8	098268594836	1	42	1,510.00
DBF-03-131-15 M2	0525232	10	098268595000	1	72	2,325.00
DBF-03-131-15 M2	0525262	12	098268595307	1	108	3,437.00

*The wetted surface of this product contacted by consumable water contains less than 0.25% of lead by weight.

Consult factory for ordering code numbers of special models/options.

Butterfly Valves

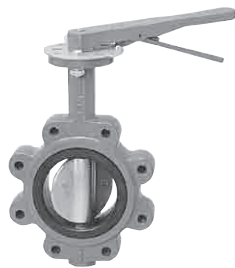

Model DBF-03
Lug, Lever Handle

Model	Ordering Code	Size (in.)	UPC	Qty. Per Carton	Weight Per Carton (lbs.)	List Price (each)
Lug, Lever Handle (cont.)						
DBF-03-111-25 M2	0525101	2	098268593723	1	12	\$ 333.00
DBF-03-111-25 M2	0525119	2 1/2	098268593907	1	16	343.00
DBF-03-111-25 M2	0525137	3	098268594089	1	15	379.50
DBF-03-111-25 M2	0525156	4	098268594263	1	24	454.00
DBF-03-111-25 M2	0525174	5	098268594447	1	25	606.50
DBF-03-111-25 M2	0525192	6	098268594621	1	31	724.00
DBF-03-111-25 M2	0525211	8	098268594805	1	42	1,005.00
DBF-03-111-25 M2	0525229	10	098268594973	1	72	1,455.00
DBF-03-111-25 M2	0525259	12	098268595277	1	108	2,602.00
DBF-03-121-25 M2	0525103	2	098268593747	1	12	346.50
DBF-03-121-25 M2	0525121	2 1/2	098268593921	1	16	352.50
DBF-03-121-25 M2	0525139	3	098268594102	1	11	405.50
DBF-03-121-25 M2	0525158	4	098268594287	1	20	539.00
DBF-03-121-25 M2	0525176	5	098268594461	1	25	694.00
DBF-03-121-25 M2	0525194	6	098268594645	1	31	810.00
DBF-03-121-25 M2	0525213	8	098268594829	1	42	1,224.00
DBF-03-121-25 M2	0525231	10	098268594997	1	72	1,772.00
DBF-03-121-25 M2	0525261	12	098268595291	1	108	2,619.00
DBF-03-131-25 M2	0525105	2	098268593761	1	12	434.50
DBF-03-131-25 M2	0525123	2 1/2	098268593945	1	16	499.50
DBF-03-131-25 M2	0525141	3	098268594126	1	7.0	551.50
DBF-03-131-25 M2	0525160	4	098268594300	1	19	691.50
DBF-03-131-25 M2	0525178	5	098268594485	1	25	985.00
DBF-03-131-25 M2	0525196	6	098268594669	1	31	1,197.00
DBF-03-131-25 M2	0525215	8	098268594843	1	42	1,510.00
DBF-03-131-25 M2	0525233	10	098268595017	1	72	2,325.00
DBF-03-131-25 M2	0525263	12	098268595314	1	108	3,437.00

LEAD FREE*

LEAD FREE*

LEAD FREE*

*The wetted surface of this product contacted by consumable water contains less than 0.25% of lead by weight.
Consult factory for ordering code numbers of special models/options.

Butterfly Valves



Model DBF-03
Lug, Gear Operator

Model	Ordering Code	Size (in.)	UPC	Qty. Per Carton	Weight Per Carton (lbs.)	List Price (each)		
Lug, Gear Operator								
LEAD FREE*	DBF-03-111-1G M2	0525112	2	098268593839	1	27	\$ 528.00	
	DBF-03-111-1G M2	0525130	2 1/2	098268594010	1	31	552.50	
	DBF-03-111-1G M2	0525148	3	098268594195	1	30	552.50	
	DBF-03-111-1G M2	0525167	4	098268594379	1	30	623.50	
	DBF-03-111-1G M2	0525185	5	098268594553	1	47	725.50	
	DBF-03-111-1G M2	0525204	6	098268594737	1	53	843.50	
	DBF-03-111-1G M2	0525222	8	098268638363	1	75	1,099.00	
	DBF-03-111-1G M2	0525240	10	098268595086	1	105	1,435.00	
	DBF-03-111-1G M2	0525252	12	098268595208	1	141	2,314.00	
	LEAD FREE*	DBF-03-121-1G M2	0525114	2	098268593853	1	27	532.50
DBF-03-121-1G M2		0525132	2 1/2	098268594034	1	22	540.50	
DBF-03-121-1G M2		0525150	3	098268594218	1	22	561.00	
DBF-03-121-1G M2		0525169	4	098268594393	1	30	655.50	
DBF-03-121-1G M2		0525187	5	098268594577	1	47	766.00	
DBF-03-121-1G M2		0525206	6	098268594751	1	41	1,014.00	
DBF-03-121-1G M2		0525224	8	098268594928	1	63	1,224.00	
DBF-03-121-1G M2		0525242	10	098268595109	1	105	1,742.00	
DBF-03-121-1G M2		0525254	12	098268595222	1	141	2,496.00	
LEAD FREE*		DBF-03-111-2G M2	0525113	2	098268593846	1	27	528.00
	DBF-03-111-2G M2	0525131	2 1/2	098268594027	1	31	552.50	
	DBF-03-111-2G M2	0525149	3	098268594201	1	30	552.50	
	DBF-03-111-2G M2	0525168	4	098268594386	1	42	623.50	
	DBF-03-111-2G M2	0525186	5	098268594560	1	47	725.50	
	DBF-03-111-2G M2	0525205	6	098268594744	1	53	843.50	
	DBF-03-111-2G M2	0525223	8	098268594911	1	75	1,099.00	
	DBF-03-111-2G M2	0525241	10	098268595093	1	105	1,435.00	
	DBF-03-111-2G M2	0525253	12	098268595215	1	141	2,314.00	
	LEAD FREE*	DBF-03-121-2G M2	0525115	2	098268593860	1	27	532.50
DBF-03-121-2G M2		0525133	2 1/2	098268594041	1	31	540.50	
DBF-03-121-2G M2		0525151	3	098268594225	1	30	561.00	
DBF-03-121-2G M2		0525170	4	098268594409	1	42	655.50	
DBF-03-121-2G M2		0525188	5	098268594584	1	47	766.00	
DBF-03-121-2G M2		0525225	8	098268594935	1	75	1,224.00	
DBF-03-121-2G M2		0525243	10	098268595116	1	105	1,742.00	
DBF-03-121-2G M2		0525255	12	098268595239	1	141	2,496.00	
LEAD FREE*		DBF-03-131-1G M2	0525116	2	098268593877	1	27	578.00
		DBF-03-131-1G M2	0525134	2 1/2	098268594058	1	15	628.50
	DBF-03-131-1G M2	0525152	3	098268594232	1	30	668.50	
	DBF-03-131-1G M2	0525171	4	098268594416	1	42	776.50	
	DBF-03-131-1G M2	0525189	5	098268594591	1	47	1,002.00	
	DBF-03-131-1G M2	0525208	6	098268594775	1	53	1,166.00	
	DBF-03-131-1G M2	0525226	8	098268594942	1	75	1,407.00	
	DBF-03-131-1G M2	0525244	10	098268595123	1	105	2,092.00	
	DBF-03-131-1G M2	0525256	12	098268595246	1	141	3,080.00	
	LEAD FREE*	DBF-03-131-2G M2	0525117	2	098268593884	1	27	578.00
DBF-03-131-2G M2		0525135	2 1/2	098268594065	1	31	628.50	
DBF-03-131-2G M2		0525153	3	098268594249	1	30	668.50	
DBF-03-131-2G M2		0525172	4	098268594423	1	42	776.50	
DBF-03-131-2G M2		0525190	5	098268594607	1	47	1,002.00	
DBF-03-131-2G M2		0525209	6	098268594782	1	53	1,166.00	
DBF-03-131-2G M2		0525227	8	098268594959	1	75	1,407.00	
DBF-03-131-2G M2		0525245	10	098268595130	1	105	2,092.00	
DBF-03-131-2G M2		0525257	12	098268595253	1	141	3,080.00	

*The wetted surface of this product contacted by consumable water contains less than 0.25% of lead by weight.

Consult factory for ordering code numbers of special models/options.

Butterfly Valves

Model	Ordering Code	Size (in.)	UPC	Qty. Per Carton	Weight Per Carton (lbs.)	List Price (each)
-------	---------------	------------	-----	-----------------	--------------------------	-------------------

Lug, Lever Handle

LEAD FREE	DBF-03-131-35 M2	0526000	2	098268639858	1	12	\$ 1,596.00
	DBF-03-131-35 M2	0526009	2 1/2	098268639957	1	16	1,886.00
	DBF-03-131-35 M2	0526018	3	098268640045	1	15	2,219.00
	DBF-03-131-35 M2	0526027	4	098268640137	1	21	2,905.00
	DBF-03-131-35 M2	0526036	5	098268640229	1	25	3,475.00
	DBF-03-131-35 M2	0526045	6	098268640311	1	31	3,843.00
	DBF-03-131-35 M2	0526054	8	098268640403	1	41	5,281.00
	DBF-03-131-35 M2	0526063	10	098268640496	1	72	6,802.00
	DBF-03-131-35 M2	0526072	12	098268640588	1	108	8,834.00

Lug, Gear Operator

LEAD FREE	DBF-03-131-3G M2	0526006	2	098268639919	1	27	1,459.00
	DBF-03-131-3G M2	0526015	2 1/2	098268640014	1	31	1,681.00
	DBF-03-131-3G M2	0526024	3	098268640106	1	30	1,938.00
	DBF-03-131-3G M2	0526033	4	098268640199	1	30	2,443.00
	DBF-03-131-3G M2	0526042	5	098268640281	1	47	2,889.00
	DBF-03-131-3G M2	0526051	6	098268640373	1	40	3,178.00
	DBF-03-131-3G M2	0526060	8	098268640465	1	75	4,356.00
	DBF-03-131-3G M2	0526069	10	098268640557	1	105	5,543.00
	DBF-03-131-3G M2	0526078	12	098268640649	1	108	7,191.00

*The wetted surface of this product contacted by consumable water contains less than 0.25% of lead by weight.
 Consult factory for ordering code numbers of special models/options.

Butterfly Valves



Model DBF-04
Wafer, Lever Handle

Model	Ordering Code	Size (in.)	UPC	Qty. Per Carton	Weight Per Carton (lbs.)	List Price (each)	
Wafer, Lever Handle							
LEAD FREE*	DBF-04-111-15 M2	0525325	2	098268595321	1	10	\$ 288.00
	DBF-04-111-15 M2	0525343	2 1/2	098268595550	1	13	307.00
	DBF-04-111-15 M2	0525361	3	098268595734	1	11	330.00
	DBF-04-111-15 M2	0525379	4	098268595918	1	15	388.50
	DBF-04-111-15 M2	0525397	5	098268596090	1	25	467.00
	DBF-04-111-15 M2	0525415	6	098268596281	1	23	610.50
	DBF-04-111-15 M2	0525433	8	098268596465	1	35	839.00
	DBF-04-111-15 M2	0525451	10	098268596649	1	48	1,221.00
	DBF-04-111-15 M2	0525481	12	098268596823	1	88	2,082.00
LEAD FREE*	DBF-04-121-15 M2	0525327	2	098268595345	1	10	297.50
	DBF-04-121-15 M2	0525345	2 1/2	098268595574	1	11	317.50
	DBF-04-121-15 M2	0525363	3	098268595758	1	11	346.50
	DBF-04-121-15 M2	0525381	4	098268595932	1	15	428.00
	DBF-04-121-15 M2	0525399	5	098268596113	1	25	548.50
	DBF-04-121-15 M2	0525417	6	098268596304	1	23	669.00
	DBF-04-121-15 M2	0525435	8	098268596489	1	35	1,067.00
	DBF-04-121-15 M2	0525453	10	098268596663	1	48	1,673.00
	DBF-04-121-15 M2	0525483	12	098268596847	1	88	2,371.00
LEAD FREE*	DBF-04-131-15 M2	0525329	2	098268595369	1	10	392.00
	DBF-04-131-15 M2	0525347	2 1/2	098268595598	1	13	457.00
	DBF-04-131-15 M2	0525365	3	098268595772	1	12	506.00
	DBF-04-131-15 M2	0525383	4	098268595956	1	15	633.50
	DBF-04-131-15 M2	0525401	5	098268596144	1	25	839.00
	DBF-04-131-15 M2	0525419	6	098268596328	1	23	1,110.00
	DBF-04-131-15 M2	0525437	8	098268596502	1	31	1,394.00
	DBF-04-131-15 M2	0525455	10	098268694543	1	48	2,270.00
	DBF-04-131-15 M2	0525485	12	098268596861	1	88	3,366.00
LEAD FREE*	DBF-04-111-25 M2	0525326	2	098268595338	1	10	288.00
	DBF-04-111-25 M2	0525344	2 1/2	098268595567	1	13	307.00
	DBF-04-111-25 M2	0525362	3	098268595741	1	11	330.00
	DBF-04-111-25 M2	0525380	4	098268595925	1	15	388.50
	DBF-04-111-25 M2	0525398	5	098268596106	1	19	467.00
	DBF-04-111-25 M2	0525416	6	098268596298	1	23	610.50
	DBF-04-111-25 M2	0525434	8	098268596472	1	36	839.00
	DBF-04-111-25 M2	0525452	10	098268596656	1	48	1,221.00
	DBF-04-111-25 M2	0525482	12	098268596830	1	88	2,082.00
LEAD FREE*	DBF-04-121-25 M2	0525328	2	098268595352	1	10	297.50
	DBF-04-121-25 M2	0525346	2 1/2	098268595581	1	13	317.50
	DBF-04-121-25 M2	0525364	3	098268595765	1	7.9	346.50
	DBF-04-121-25 M2	0525382	4	098268595949	1	20	428.00
	DBF-04-121-25 M2	0525400	5	098268650457	1	25	548.50
	DBF-04-121-25 M2	0525418	6	098268596311	1	23	669.00
	DBF-04-121-25 M2	0525436	8	098268596496	1	19	1,067.00
	DBF-04-121-25 M2	0525454	10	098268596670	1	48	1,673.00
	DBF-04-121-25 M2	0525484	12	098268596854	1	88	2,371.00
LEAD FREE*	DBF-04-131-25 M2	0525330	2	098268595376	1	10	392.00
	DBF-04-131-25 M2	0525348	2 1/2	098268595604	1	13	457.00
	DBF-04-131-25 M2	0525384	4	098268595963	1	20	633.50
	DBF-04-131-25 M2	0525402	5	098268596151	1	25	839.00
	DBF-04-131-25 M2	0525420	6	098268596335	1	23	1,110.00
	DBF-04-131-25 M2	0525456	10	098268596694	1	48	2,270.00
DBF-04-131-25 M2	0525486	12	098268596878	1	88	3,366.00	

*The wetted surface of this product contacted by consumable water contains less than 0.25% of lead by weight.

Consult factory for ordering code numbers of special models/options.

Butterfly Valves

Model	Ordering Code	Size (in.)	UPC	Qty. Per Carton	Weight Per Carton (lbs.)	List Price (each)
-------	---------------	------------	-----	-----------------	--------------------------	-------------------

Wafer, Gear Operator

LEAD FREE*	DBF-04-111-1G M2	0525337	2	098268595499	1	25	\$ 465.00
	DBF-04-111-1G M2	0525355	2 1/2	098268595673	1	19	477.50
	DBF-04-111-1G M2	0525373	3	098268595857	1	29	497.50
	DBF-04-111-1G M2	0525391	4	098268596038	1	41	542.50
	DBF-04-111-1G M2	0525409	5	098268596229	1	46	638.50
	DBF-04-111-1G M2	0525427	6	098268596403	1	28	713.50
	DBF-04-111-1G M2	0525445	8	098268596588	1	64	901.50
	DBF-04-111-1G M2	0525463	10	098268596762	1	81	1,241.00
	DBF-04-111-1G M2	0525475	12	098268596946	1	121	2,037.00
LEAD FREE*	DBF-04-121-1G M2	0525339	2	098268595512	1	25	473.00
	DBF-04-121-1G M2	0525357	2 1/2	098268595697	1	28	487.50
	DBF-04-121-1G M2	0525375	3	098268595871	1	29	508.00
	DBF-04-121-1G M2	0525393	4	098268596052	1	41	573.00
	DBF-04-121-1G M2	0525411	5	098268596243	1	46	665.50
	DBF-04-121-1G M2	0525429	6	098268596427	1	45	844.00
	DBF-04-121-1G M2	0525447	8	098268596601	1	64	1,259.00
	DBF-04-121-1G M2	0525465	10	098268596786	1	81	1,588.00
	DBF-04-121-1G M2	0525477	12	098268596960	1	121	2,260.00
LEAD FREE*	DBF-04-131-1G M2	0525341	2	098268595536	1	25	545.00
	DBF-04-131-1G M2	0525359	2 1/2	098268595710	1	28	595.50
	DBF-04-131-1G M2	0525377	3	098268595895	1	29	632.50
	DBF-04-131-1G M2	0525395	4	098268596076	1	41	728.00
	DBF-04-131-1G M2	0525413	5	098268596267	1	46	889.00
	DBF-04-131-1G M2	0525431	6	098268596441	1	45	1,099.00
	DBF-04-131-1G M2	0525449	8	098268596625	1	52	1,326.00
	DBF-04-131-1G M2	0525467	10	098268596809	1	81	2,048.00
	DBF-04-131-1G M2	0525479	12	098268596984	1	121	3,025.00
LEAD FREE*	DBF-04-111-2G M2	0525338	2	098268595505	1	25	465.00
	DBF-04-111-2G M2	0525356	2 1/2	098268595680	1	28	477.50
	DBF-04-111-2G M2	0525374	3	098268595864	1	29	497.50
	DBF-04-111-2G M2	0525392	4	098268596045	1	41	542.50
	DBF-04-111-2G M2	0525410	5	098268596236	1	46	638.50
	DBF-04-111-2G M2	0525428	6	098268596410	1	45	713.50
	DBF-04-111-2G M2	0525446	8	098268596595	1	64	901.50
	DBF-04-111-2G M2	0525464	10	098268596779	1	81	1,241.00
	DBF-04-111-2G M2	0525476	12	098268596953	1	121	2,037.00
LEAD FREE*	DBF-04-121-2G M2	0525340	2	098268595529	1	25	473.00
	DBF-04-121-2G M2	0525358	2 1/2	098268595703	1	28	487.50
	DBF-04-121-2G M2	0525376	3	098268595888	1	29	508.00
	DBF-04-121-2G M2	0525394	4	098268596069	1	41	573.00
	DBF-04-121-2G M2	0525412	5	098268596250	1	46	665.50
	DBF-04-121-2G M2	0525430	6	098268596434	1	45	844.00
	DBF-04-121-2G M2	0525448	8	098268596618	1	64	1,259.00
	DBF-04-121-2G M2	0525466	10	098268596793	1	81	1,588.00
	DBF-04-121-2G M2	0525478	12	098268596977	1	121	2,260.00
LEAD FREE*	DBF-04-131-2G M2	0525342	2	098268595543	1	25	545.00
	DBF-04-131-2G M2	0525360	2 1/2	098268595727	1	28	595.50
	DBF-04-131-2G M2	0525378	3	098268595901	1	29	632.50
	DBF-04-131-2G M2	0525396	4	098268596083	1	42	728.00
	DBF-04-131-2G M2	0525414	5	098268596274	1	46	889.00
	DBF-04-131-2G M2	0525432	6	098268596458	1	45	1,099.00
	DBF-04-131-2G M2	0525450	8	098268596632	1	64	1,326.00
	DBF-04-131-2G M2	0525468	10	098268596816	1	81	2,048.00
	DBF-04-131-2G M2	0525480	12	098268596991	1	121	3,025.00

*The wetted surface of this product contacted by consumable water contains less than 0.25% of lead by weight.

Consult factory for ordering code numbers of special models/options.

Butterfly Valves

Model	Ordering Code	Size (in.)	UPC	Qty. Per Carton	Weight Per Carton (lbs.)	List Price (each)
-------	---------------	------------	-----	-----------------	--------------------------	-------------------

Wafer, Lever Handle

LEAD FREE*	DBF-04-131-35 M2	0526128	2	098268640670	1	10	\$ 1,587.00
	DBF-04-131-35 M2	0526137	2 1/2	098268640762	1	13	1,882.00
	DBF-04-131-35 M2	0526146	3	098268640854	1	14	2,212.00
	DBF-04-131-35 M2	0526155	4	098268640946	1	15	2,821.00
	DBF-04-131-35 M2	0526164	5	098268641035	1	25	3,410.00
	DBF-04-131-35 M2	0526173	6	098268641127	1	23	3,774.00
	DBF-04-131-35 M2	0526182	8	098268641219	1	31	5,194.00
	DBF-04-131-35 M2	0526191	10	098268641301	1	48	6,759.00
	DBF-04-131-35 M2	0526200	12	098268641394	1	88	8,788.00

Wafer, Gear Operator

LEAD FREE*	DBF-04-131-3G M2	0526134	2	098268640731	1	25	1,461.00
	DBF-04-131-3G M2	0526143	2 1/2	098268640823	1	28	1,684.00
	DBF-04-131-3G M2	0526159	3	098268640984	1	41	1,943.00
	DBF-04-131-3G M2	0526161	4	098268641004	1	41	2,421.00
	DBF-04-131-3G M2	0526170	5	098268641097	1	46	2,843.00
	DBF-04-131-3G M2	0526179	6	098268641189	1	45	3,131.00
	DBF-04-131-3G M2	0526188	8	098268641271	1	64	4,272.00
	DBF-04-131-3G M2	0526197	10	098268641363	1	81	5,516.00
	DBF-04-131-3G M2	0526206	12	098268641455	1	121	7,162.00

*The wetted surface of this product contacted by consumable water contains less than 0.25% of lead by weight.

Consult factory for ordering code numbers of special models/options.

Butterfly Valves

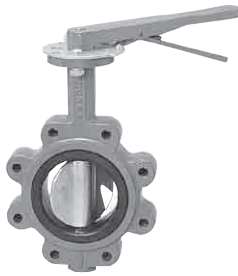

Model BF-03
Lug, Lever Handle

Model	Ordering Code	Size (in.)	UPC	Qty. Per Carton	Weight Per Carton (lbs.)	List Price (each)	
Lug, Lever Handle							
LEAD FREE*	BF-03-111-15 M2	0525547	2	098268603507	1	10	\$ 152.50
	BF-03-111-15 M2	0525565	2 1/2	098268603682	1	12	160.00
	BF-03-111-15 M2	0525583	3	098268603859	1	12	173.50
	BF-03-111-15 M2	0525601	4	098268604030	1	26	198.50
	BF-03-111-15 M2	0525619	5	098268604207	1	27	264.00
	BF-03-111-15 M2	0525637	6	098268604382	1	30	312.00
	BF-03-111-15 M2	0525655	8	098268604566	1	68	421.00
	BF-03-111-15 M2	0525673	10	098268604740	1	68	591.50
	BF-03-111-15 M2	0525691	12	098268604924	1	106	947.00
LEAD FREE*	BF-03-121-15 M2	0525549	2	098268603521	1	10	231.00
	BF-03-121-15 M2	0525567	2 1/2	098268603705	1	12	244.00
	BF-03-121-15 M2	0525585	3	098268605297	1	12	256.00
	BF-03-121-15 M2	0525603	4	098268604054	1	17	337.50
	BF-03-121-15 M2	0525621	5	098268604221	1	26	279.50
	BF-03-121-15 M2	0525639	6	098268604405	1	28	343.00
	BF-03-121-15 M2	0525657	8	098268604580	1	44	474.50
	BF-03-121-15 M2	0525675	10	098268604764	1	69	740.00
	BF-03-121-15 M2	0525693	12	098268604948	1	145	1,046.00
LEAD FREE*	BF-03-131-15 M2	0525551	2	098268603545	1	11	196.00
	BF-03-131-15 M2	0525569	2 1/2	098268603729	1	16	222.00
	BF-03-131-15 M2	0525587	3	098268603897	1	18	243.00
	BF-03-131-15 M2	0525605	4	098268604078	1	26	298.00
	BF-03-131-15 M2	0525623	5	098268604245	1	26	413.50
	BF-03-131-15 M2	0525641	6	098268604429	1	39	496.50
	BF-03-131-15 M2	0525659	8	098268604603	1	48	619.50
	BF-03-131-15 M2	0525677	10	098268604788	1	94	931.50
	BF-03-131-15 M2	0525695	12	098268604962	1	115	1,365.00
LEAD FREE*	BF-03-111-25 M2	0525548	2	098268603514	1	12	152.50
	BF-03-111-25 M2	0525566	2 1/2	098268603699	1	14	160.00
	BF-03-111-25 M2	0525584	3	098268603866	1	18	173.50
	BF-03-111-25 M2	0525602	4	098268604047	1	26	198.50
	BF-03-111-25 M2	0525638	6	098268604399	1	30	312.00
	BF-03-111-25 M2	0525656	8	098268604573	1	46	421.00
	BF-03-111-25 M2	0525674	10	098268604757	1	94	591.50
	BF-03-111-25 M2	0525692	12	098268604931	1	108	947.00
	BF-03-121-25 M2	0525550	2	098268603538	1	11	161.00
LEAD FREE*	BF-03-121-25 M2	0525568	2 1/2	098268603712	1	14	163.50
	BF-03-121-25 M2	0525586	3	098268603880	1	12	175.00
	BF-03-121-25 M2	0525604	4	098268604061	1	20	223.50
	BF-03-121-25 M2	0525640	6	098268604412	1	27	343.00
	BF-03-121-25 M2	0525658	8	098268604597	1	68	474.50
	BF-03-121-25 M2	0525694	12	098268604955	1	108	1,046.00
	BF-03-131-25 M2	0525552	2	098268603552	1	14	196.00
	BF-03-131-25 M2	0525588	3	098268603903	1	14	243.00
	BF-03-131-25 M2	0525606	4	098268604085	1	26	298.00
LEAD FREE*	BF-03-131-25 M2	0525624	5	098268604252	1	25	413.50
	BF-03-131-25 M2	0525642	6	098268604436	1	31	496.50
	BF-03-131-25 M2	0525660	8	098268604610	1	42	619.50
	BF-03-131-25 M2	0525678	10	098268604795	1	72	931.50
	BF-03-131-25 M2	0525696	12	098268604979	1	108	1,365.00

*The wetted surface of this product contacted by consumable water contains less than 0.25% of lead by weight.

Consult factory for ordering code numbers of special models/options.

Butterfly Valves



Model BF-03
Lug, Gear Operator

Model	Ordering Code	Size (in.)	UPC	Qty. Per Carton	Weight Per Carton (lbs.)	List Price (each)
-------	---------------	------------	-----	-----------------	--------------------------	-------------------

Lug, Gear Operator

Model	Ordering Code	Size (in.)	UPC	Qty. Per Carton	Weight Per Carton (lbs.)	List Price (each)
BF-03-111-1G M2	0525577	2 1/2	098268605303	1	31	\$ 356.00
BF-03-111-1G M2	0525595	3	098268603972	1	30	365.00
BF-03-111-1G M2	0525613	4	098268604153	1	42	410.50
BF-03-111-1G M2	0525631	5	098268604320	1	47	480.00
BF-03-111-1G M2	0525649	6	098268604504	1	40	556.50
BF-03-111-1G M2	0525667	8	098268604689	1	75	723.50
BF-03-111-1G M2	0525685	10	098268604863	1	61	946.00
BF-03-111-1G M2	0525703	12	098268605044	1	141	1,461.00
BF-03-121-1G M2	0525541	2	098268603644	1	27	184.50
BF-03-121-1G M2	0525579	2 1/2	098268603811	1	31	356.00
BF-03-121-1G M2	0525597	3	098268603996	1	30	371.00
BF-03-121-1G M2	0525615	4	098268604177	1	30	432.50
BF-03-121-1G M2	0525633	5	098268604344	1	47	505.00
BF-03-121-1G M2	0525651	6	098268604528	1	39	480.00
BF-03-121-1G M2	0525669	8	098268604702	1	56	1,065.00
BF-03-121-1G M2	0525687	10	098268604887	1	84	1,517.00
BF-03-121-1G M2	0525705	12	098268605068	1	102	2,173.00
BF-03-121-1G M2	0525717	14	098268605372	1	345	1,982.00
BF-03-121-1G M2	0525729	16	098268605495	1	271	3,876.00
BF-03-121-1G M2	0525741	18	098268605617	1	295	4,782.00
BF-03-121-1G M2	0525753	20	098268605730	1	407	6,034.00
BF-03-121-1G M2	0525765	24	098268605907	1	646	10,831.00
BF-03-131-1G M2	0525563	2	098268603668	1	27	399.50
BF-03-131-1G M2	0525581	2 1/2	098268603835	1	31	431.00
BF-03-131-1G M2	0525599	3	098268604016	1	30	458.00
BF-03-131-1G M2	0525617	4	098268604191	1	42	529.00
BF-03-131-1G M2	0525635	5	098268604368	1	47	678.50
BF-03-131-1G M2	0525653	6	098268604542	1	39	785.50
BF-03-131-1G M2	0525671	8	098268604726	1	66	953.50
BF-03-131-1G M2	0525689	10	098268604900	1	92	1,401.00
BF-03-131-1G M2	0525707	12	098268605082	1	141	2,064.00

*The wetted surface of this product contacted by consumable water contains less than 0.25% of lead by weight.

Consult factory for ordering code numbers of special models/options.

Butterfly Valves

Model	Ordering Code	Size (in.)	UPC	Qty. Per Carton	Weight Per Carton (lbs.)	List Price (each)
-------	---------------	------------	-----	-----------------	--------------------------	-------------------

Wafer, Lever Handle



Model BF-04-M2
Wafer, Lever Handle

LEAD FREE*	BF-04-111-15 M2	0525769	2	098268605945	1	8.9	\$ 138.50
	BF-04-111-15 M2	0525789	2 1/2	098268606126	1	13	148.50
	BF-04-111-15 M2	0525807	3	098268606300	1	14	155.50
	BF-04-111-15 M2	0525825	4	098268606485	1	14	178.00
	BF-04-111-15 M2	0525843	5	098268606669	1	6.3	208.50
	BF-04-111-15 M2	0525861	6	098268606843	1	21	266.00
	BF-04-111-15 M2	0525879	8	098268607024	1	53	372.50
	BF-04-111-15 M2	0525897	10	098268607208	1	53	505.50
LEAD FREE*	BF-04-111-15 M2	0525915	12	098268607383	1	62	844.00
	BF-04-121-15 M2	0525771	2	098268605969	1	12	142.50
	BF-04-121-15 M2	0525791	2 1/2	098268606140	1	10	151.00
	BF-04-121-15 M2	0525809	3	098268606324	1	14	161.00
	BF-04-121-15 M2	0525827	4	098268606508	1	19	193.50
	BF-04-121-15 M2	0525845	5	098268606683	1	18	241.00
	BF-04-121-15 M2	0525863	6	098268606867	1	31	288.50
	BF-04-121-15 M2	0525881	8	098268607048	1	53	445.00
LEAD FREE*	BF-04-121-15 M2	0525899	10	098268607222	1	47	682.50
	BF-04-121-15 M2	0525917	12	098268607406	1	115	958.50
	BF-04-131-15 M2	0525773	2	098268605983	1	4.5	179.50
	BF-04-131-15 M2	0525793	2 1/2	098268606164	1	11	205.00
	BF-04-131-15 M2	0525811	3	098268606348	1	10	224.50
	BF-04-131-15 M2	0525829	4	098268606522	1	14	274.00
	BF-04-131-15 M2	0525847	5	098268606706	1	30	356.00
	BF-04-131-15 M2	0525865	6	098268606881	1	22	461.00
LEAD FREE*	BF-04-131-15 M2	0525883	8	098268607062	1	32	573.00
	BF-04-131-15 M2	0525901	10	098268607246	1	76	919.00
	BF-04-131-15 M2	0525919	12	098268607420	1	115	1,350.00

*The wetted surface of this product contacted by consumable water contains less than 0.25% of lead by weight.

Consult factory for ordering code numbers of special models/options.

Butterfly Valve Options

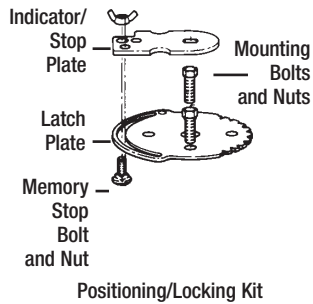
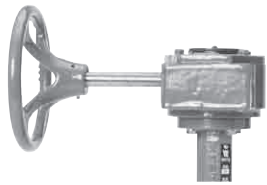

Model	Ordering Code	Size (in.)	UPC	Qty. Per Carton	Weight Per Carton (lbs.)	List Price (each)
-------	---------------	------------	-----	-----------------	--------------------------	-------------------

Gear Operators for Butterfly Valves

GO-1-M4	0812200	2, 2 1/2, 3	098268443608	1	20	\$ 318.00
GO-2-M4	0812201	4	098268443615	1	20	330.00
GO-3-M4	0812202	5-6	098268443622	1	20	336.50
GO-4-M4	0812203	8	098268443639	1	29	346.00
GO-5-M4	0812204	10	098268443646	1	29	366.50
GO-6-M4	0812205	12-14	098268443653	1	40	570.00
GO-7-M4	0812206	16	098268443660	1	58	1,049.00
GO-8-M4	0812207	18	098268443677	1	105	1,144.00
GO-9-M4	0812208	20	098268443684	1	105	1,245.00
GO-10-M4	0812209	24	098268443691	1	105	1,279.00

Positioning/ Locking Kits

#1 POS-LOCK-M2	0530405	2	098268639407	1	1.6	30.00
#1 POS-LOCK-M2	0530405	2 1/2	098268639407	1	1.6	30.00
#1 POS-LOCK-M2	0530405	3	098268639407	1	1.6	30.00
#2 POS-LOCK-M2	0530406	4	098268639414	1	1.8	33.50
#3 POS-LOCK-M2	0530407	5	098268639421	1	3.0	36.75
#3 POS-LOCK-M2	0530407	6	098268639421	1	3.0	36.75

Chain Wheel Kits Less Chain

#2 BCWK	0523042	2	098268239720	1	13	226.00
#2 BCWK	0523042	2 1/2	098268239720	1	13	226.00
#2 BCWK	0523042	3	098268239720	1	13	226.00
#2 BCWK	0523042	4	098268239720	1	13	226.00
#2 BCWK	0523042	5	098268239720	1	13	226.00
#2 BCWK	0523042	6	098268239720	1	13	226.00
#3 BCWK	0523046	8	098268239713	1	19	423.00
#3 BCWK	0523046	10	098268239713	1	19	423.00
#3 BCWK	0523046	12	098268239713	1	19	423.00
#3 BCWK	0523046	14	098268239713	1	19	423.00
#4 BCWK	0523047	16	098268863062	1	13	952.50
#4 BCWK	0523047	18	098268863062	1	13	952.50
#4 BCWK	0523047	20	098268863062	1	13	952.50
#5 BCWK	0523048	24	098268863055	1	12	1,753.00

Chain Wheel Chains

# 2 BCWC	0523065	2	098268892215	1	1.0	3.75
# 2 BCWC	0523065	2 1/2	098268892215	1	1.0	3.75
# 2 BCWC	0523065	3	098268892215	1	1.0	3.75
# 2 BCWC	0523065	4	098268892215	1	1.0	3.75
# 2 BCWC	0523065	5	098268892215	1	1.0	3.75
# 2 BCWC	0523065	6	098268892215	1	1.0	3.75
# 3 BCWC	0523066	8	098268892222	1	1.0	9.75
# 3 BCWC	0523066	10	098268892222	1	1.0	9.75
# 3 BCWC	0523066	12	098268892222	1	1.0	9.75
# 3 BCWC	0523066	14	098268892222	1	1.0	9.75
# 3 BCWC	0523066	16	098268892222	1	1.0	9.75
# 3 BCWC	0523066	18	098268892222	1	1.0	9.75
# 3 BCWC	0523066	20	098268892222	1	1.0	9.75
# 5 BCWC	0523067	24	098268892239	1	1.0	7.25

*The wetted surface of this product contacted by consumable water contains less than 0.25% of lead by weight.

Consult factory for ordering code numbers of special models/options.

Butterfly Valve Options

Model	Ordering Code	Size (in.)	UPC	Qty. Per Carton	Weight Per Carton (lbs.)	List Price (each)
Handle Kits						
HK-2000-M2	0523003	2, 2 1/2, 3	098268639469	1	3.4	\$ 62.75
HK-2000-M2	0523004	4	098268639476	1	4.0	66.25
HK-2000-M2	0523005	5-6	098268639483	1	3.5	75.75
HK-2000-M2	0523006	8	098268639490	1	6.6	78.00
HK-2000-M2	0523007	10	098268639506	1	7.2	83.50
HK-2000-M2	0523008	12	098268639513	1	6.8	87.00
Gear Operator 2 Sq. Nut**						
OPN-BFG	0530453	5-6	098268856101	1	4.0	23.00
OPN-BFG	0530453	8	098268856101	1	4.0	23.00
OPN-BFG	0530453	10	098268856101	1	4.0	23.00

**2 sq. nut attaches to gear operator shaft (remove hand wheel) and gear shaft positioned vertically to operate valve.

*The wetted surface of this product contacted by consumable water contains less than 0.25% of lead by weight.
 Consult factory for ordering code numbers of special models/options.

Hydronics/Steam Heating Products

Model	Ordering Code	Connection	Size (in.)	Body	UPC	Qty. Per Carton	Weight Per Carton (lbs.)	List Price (each)
-------	---------------	------------	------------	------	-----	-----------------	--------------------------	-------------------

Series 1156

Highest Purging Capacity Feed Water Pressure Regulators



1156F	0386425	Threaded	1/2	Iron	098268023107	12	24	\$ 77.75
1156F-A	0386427	Threaded	1/2	Iron	098268023121	12	27	87.50
T1156F	0386500	Threaded union	1/2	Iron	098268023169	12	25	84.25
S1156F	0386450	Union solder	1/2	Iron	098268023152	12	26	84.25
B1156F	0386423	Threaded	1/2	Bronze	098268023084	12	19	84.25
SB1156F	0386422	Union solder	1/2	Bronze	098268023077	12	19	95.50
TB1156F	0386421	Threaded union	1/2	Bronze	098268023060	12	19	95.50
N256	0322825	Threaded	3/4	Bronze	098268016536	6	17	177.00

Series 1450

Dual Controls - Regulator and Relief Valve



1450F	0388798	Threaded	1/2	Iron	098268025545	10	32	169.00
T1450F	0388805	Threaded Union	1/2	Iron	098268025569	10	33	179.00
S1450F	0388800	Union Solder	1/2	Iron	098268025552	10	32	179.00

Series T156B

Feed Water Pressure Regulator - With Separate Strainer

T156B	0270105	Threaded Union	1/2		098268012804	12	30	269.50
-------	---------	----------------	-----	--	--------------	----	----	--------

Series 911

Combination 1156F Feedwater Regulator and 9D Backflow Preventer For hydronic Heating †Solder ends



911-M3	0386460	Threaded Union	1/2	Iron	098268918502	6	19	177.50
911S-M3	†0386461	Union Solder	1/2	Iron	098268918519	6	20	177.50

Combination B1156 Feedwater Regulator and 9D Backflow Preventer

B911-M3	0386463	Threaded Union	1/2	Bronze	098268918533	6	16	161.50
B911S-M3	†0386462	Union Solder	1/2	Bronze	098268918526	6	17	161.50

Model	Ordering Code	Size (in.)	UPC	Qty. Per Carton	Weight Per Carton (lbs.)	List Price (each)
-------	---------------	------------	-----	-----------------	--------------------------	-------------------

Residential Boiler Fill Fitting

Series RBFF

RBFF	0386466	1/2	098268461596	20	33	\$ 88.25
------	---------	-----	--------------	----	----	----------



Series 2000

Iron Body Two-Way Universal Flow Checks

2000-M5	0856760	3/4	098268263848	12	43	67.75
2000-M5	0856761	1	098268263862	12	43	69.50
2000-M5	0856762	1 1/4	098268263886	6	33	91.50
2000-M5	0856769	1 1/2	098268300437	5	40	183.00
2000-M5	0856770	2	098268300444	3	38	225.00
2000-M5	0856771	2 1/2	098268300451	2	51	518.00
2000-M5	0856772	3	098268300468	2	48	564.00

Bronze Solder Flow Check - Straight Pattern

2000S-M5	0856763	3/4	098268263855	12	16	56.75
2000S-M5	0856764	1	098268263879	12	24	72.75



*The wetted surface of this product contacted by consumable water contains less than 0.25% of lead by weight.

Consult factory for ordering code numbers of special models/options.

Hydronics/Steam Heating Products

Model	Ordering Code	Size (in.)	UPC	Qty. Per Carton	Weight Per Carton (lbs.)	List Price (each)
-------	---------------	------------	-----	-----------------	--------------------------	-------------------

Air Separators

Series AS

Cast Iron

AS-M1	0858535	1	098268215359	6	30	\$ 25.25
AS-M1	0858536	1 1/4	098268215366	6	28	26.00
AS-M1	0858537	1 1/2	098268872095	1	9	92.75
AS-M1	0858538	2	098268872101	1	8	105.50
AS-M1	0858539	2 1/2	098268872118	1	18	180.00
AS-M1	0858529	3	098268872125	1	15	260.00



AS-M1-T

Cast Iron with 1/2" Feed Water Tapping

AS-M1-T	0858557	1	098268039573	6	30	34.75
AS-M1-T	0858558	1 1/4	098268039580	6	30	36.50

AS-MB

Micro-Bubble Air Separator

AS-MB 75	0858546	3/4	098268476194	6	15	148.50
AS-MB 100	0858547	1	098268476224	6	16	173.50
AS-MB 125	0858548	1 1/4	098268476231	6	17	185.50
AS-MB 150	0858553	1 1/2	098268567854	6	18	335.50
AS-MB 200	0858554	2	098268476231	6	18	369.50
AS-MB FL	0858549	Flanged	098268567861	6	18	193.00
AS-MB-S-75	0858550	3/4	098268537314	6	15	143.00
AS-MB-S-100	0858551	1	098268537321	6	16	167.00
AS-MB-S-125	0858552	1 1/4	098268537352	6	17	179.00



AS-MB 75

*The wetted surface of this product contacted by consumable water contains less than 0.25% of lead by weight.
Consult factory for ordering code numbers of special models/options.

Hydronics/Steam Heating Products

Model	Ordering Code	Size (in.)	UPC	Qty. Per Carton	Weight Per Carton (lbs.)	List Price (each)
-------	---------------	------------	-----	-----------------	--------------------------	-------------------

Isolation Pump Flange Series IPF



IPF-T-M1

Threaded

IPF-T	0067777	1/2	098268085655	20	29	\$ 32.00
IPF-T-M1	0068090	3/4	098268344325	20	36	33.00
IPF-T-M1	0068091	1	098268344332	20	39	41.00
IPF-T-M1	0068092	1 1/4	098268344349	20	48	54.25
IPF-T-M1	0068093	1 1/2	098268344356	20	56	60.25
IPF-T-M1	0068094	2	098268344363	10	28	105.50

LEAD FREE*

LFIPFM1-T-HV	0123029	3/4	098268651003	20	36	42.75
LFIPFM1-T-HV	0123030	1	098268651140	20	39	55.25
LFIPFM1-T-HV	0123031	1 1/4	098268651201	20	48	73.50
LFIPFM1-T-HV	0123032	1 1/2	098268651218	20	56	90.00
LFIPFM2-T-HV	0123023	2	098268650853	10	28	139.00

Solder

IPF-S	0067783	1/2	098268085754	20	28	32.00
IPF-S-M1	0068095	3/4	098268344370	20	33	33.00
IPF-S-M1	0068096	1	098268344387	20	38	41.00
IPF-S-M1	0068097	1 1/4	098268344394	20	48	54.25
IPF-S-M1	0068098	1 1/2	098268344301	20	58	60.25
IPF-S-M1	0068099	2	098268344318	10	28	105.50

LEAD FREE*

LFIPFM1-S-HV	0123034	3/4	098268651263	20	33	42.75
LFIPFM1-S-HV	0123036	1	098268652758	20	38	73.50
LFIPFM1-S-HV	0123035	1 1/4	098268651324	20	48	55.25
LFIPFM1-S-HV	0123037	1 1/2	098268652765	20	58	90.00
LFIPFM2-S-HV	0123028	2	098268650952	10	28	139.00

Isolation Pump Flange with Purge Port and Swivel Flange Series PIPF



PIPF-T

Threaded

PIPFM1-T	0067771	3/4	098268554755	18	39	58.50
PIPFM1-T	0067772	1	098268554762	12	30	69.25
PIPFM1-T	0067773	1 1/4	098268554779	9	27	81.50

Solder

PIPFM1-S	0067774	3/4	098268554786	18	38	58.50
PIPFM1-S	0067775	1	098268554793	12	29	69.25
PIPFM1-S	0067776	1 1/4	098268554809	9	26	81.50

Threaded

PIPF-T	0067790	3/4	098268302141	24	50	41.00
PIPF-T	0067791	1	098268302165	18	45	50.25
PIPF-T	0067792	1 1/4	098268302172	12	36	66.50

Solder

PIPF-S	0067793	3/4	098268302189	24	48	41.00
PIPF-S	0067794	1	098268302196	18	41	50.25
PIPF-S	0067795	1 1/4	098268302202	12	33	66.50

*The wetted surface of this product contacted by consumable water contains less than 0.25% of lead by weight.

Consult factory for ordering code numbers of special models/options.

Hydronics/Steam Heating Products

Model	Ordering Code	Connection Size (in.)	Volume (gals.)	Accept Volume (gals.)	UPC	Qty. Per Carton	Weight Per Carton (lbs.)	List Price (each)
-------	---------------	-----------------------	----------------	-----------------------	-----	-----------------	--------------------------	-------------------

Expansion Tanks - For hot water heating systems

Series ETX

Pipe Mount - Max. temp. 240°F - Max pressure 75psi, ETX-90 100psi



ETX

ETX-15	0066605	1/2 MNPT	2.1	1.0	098268219340	1	5.4	\$ 52.75
ETX-30	0066606	1/2 MNPT	4.5	2.5	098268219357	1	9.0	63.25
ETX-60	0066607	1/2 MNPT	6.0	3.0	098268219364	1	12	76.25
ETX-90	0066608	3/4 MNPT	15.0	6.0	098268219470	1	23	210.00

Series ETSX

Free Standing - Max. temp. 240°F - Max pressure 100psi



ETSX

ETSX-30	0066609	1 FNPT	15.0	6.0	098268219487	1	28	268.50
ETSX-40	0066610	1 FNPT	20.0	8.0	098268219494	1	34	286.00
ETSX-60	0066611	1 FNPT	33.0	13.3	098268219500	1	52	361.50
ETSX-90	0066612	1 1/4 FNPT	44.0	17.7	098268219562	1	66	658.50
ETSX-110	0066613	1 1/4 FNPT	62.0	24.9	098268219593	1	86	769.00
ETSX-160	0066614	1 1/4 FNPT	81.0	32.6	098268219609	1	102	821.50

Series ETA

ASME Pressurized Expansion Tanks for Heating and Cooling Systems with Fixed Bladder



ETA

ETA-15	0212000	3/4	7.8	2.5	098268913224	1	44	907.50
ETA-20	0212001	3/4	10.9	2.5	098268913231	1	46	928.50
ETA-40	0212002	1	25	10	098268913248	1	82	1,437.00
ETA-60	0212003	1	35	10	098268913255	1	110	1,658.00
ETA-80	0212004	1	45	21	098268913262	1	148	2,139.00
ETA-100	0212005	1	60	21	098268913279	1	168	2,243.00
ETA-120	0212006	1 1/2	70	48	098268913286	1	225	2,763.00
ETA-144	0212007	1 1/2	80	48	098268913293	1	245	2,967.00
ETA-180	0212008	1 1/2	90	48	098268913309	1	283	3,408.00
ETA-200	0212009	1 1/2	115	48	098268913316	1	325	3,500.00
ETA-240	0212010	1 1/2	140	52	098268913323	1	362	4,068.00

Series ETRA

ASME Pressurized Expansion Tanks for Heating and Cooling Systems with Removable Bladder



ETRA

ETRA-35	0212011	3/4	10	-	098268913330	1	40	3,002.00
ETRA-50	0212012	3/4	13	-	098268913347	1	50	3,204.00
ETRA-85	0212013	1	23	-	098268913354	1	90	3,290.00
ETRA-130	0212014	1	35	-	098268913361	1	125	3,500.00
ETRA-200	0212015	1 1/2	53	-	098268913378	1	209	4,049.00
ETRA-300	0212016	1 1/2	79	-	098268913385	1	225	4,439.00
ETRA-400	0212017	1 1/2	105	-	098268913392	1	300	4,532.00
ETRA-500	0212018	1 1/2	132	-	098268913408	1	335	4,780.00
ETRA-600	0212019	1 1/2	158	-	098268913415	1	360	7,050.00
ETRA-800	0212020	1 1/2	211	-	098268913422	1	475	7,792.00
ETRA-1000	0212021	1 1/2	264	-	098268913439	1	710	9,556.00
ETRA-1200	0212022	1 1/2	317	-	098268913446	1	720	9,994.00
ETRA-1400	0212023	1 1/2	370	-	098268913453	1	875	10,875.00
ETRA-1600	0212024	1 1/2	422	-	098268913460	1	1100	14,970.00
ETRA-2000	0212025	1 1/2	528	-	098268913477	1	1280	16,429.00

Expansion Tank Package: Contains one ET, one AS and one FV-4M1

*The wetted surface of this product contacted by consumable water contains less than 0.25% of lead by weight.

Consult factory for ordering code numbers of special models/options.

Hydronics/Steam Heating Products



ETX-15-ASF

Model	Ordering Code	Connection Size (in.)	Volume (gals.)	Accept Volume (gals.)	UPC	Qty. Per Carton	Weight Per Carton (lbs.)	List Price (each)
-------	---------------	-----------------------	----------------	-----------------------	-----	-----------------	--------------------------	-------------------

Series ETX

With 1" Air Separator

ETX-15-ASF	0235086	1	2.1	1.0	098268340181	1	16	\$ 133.50
ETX-30-ASF	0235087	1	4.5	2.5	098268340198	1	16	146.00
ETX-60-ASF	0235088	1	6.0	3.0	098268340204	1	19	158.50

With 1 1/4" Air Separator

ETX-15-ASF	0235089	1 1/4	2.1	1.0	098268340211	1	16	133.50
ETX-30-ASF	0235090	1 1/4	4.5	2.5	098268340228	1	16	144.00
ETX-60-ASF	0235091	1 1/4	6.0	3.0	098268339796	1	19	158.50

Model	Ordering Code	Size (in.)	UPC	Qty. Per Carton	Weight Per Carton (lbs.)	List Price (each)
-------	---------------	------------	-----	-----------------	--------------------------	-------------------

Boiler Trim Out Packages

Series HP

Includes FV-4M1, SCV (1/8" & 1/2"), AS, ET-30 and 911S

HPX-C	0235070	1	098268340044	1	19	\$ 251.50
HPX-D	0235071	1 1/4	098268340051	1	19	251.50

Includes (1/8") FV-4M1, SCV (1/8" & 1/2"), AS, ET-15 and 911S

HPX-15C	0235072	1	098268340068	1	19	239.50
HPX-15D	0235073	1 1/4	098268340075	1	19	239.50

Includes Float Vent, SCV (1/8" & 1/2"), AS, ET-15 and Bronze Fill Valve

HPX-15BC	0235076	1	098268340105	1	19	251.00
HPX-15BD	0235077	1 1/4	098268340112	1	18	251.50

Includes (1/8") DuoVent, SCV (1/8" & 1/2"), AS-M1, ETX-60 and B911S

HPX-60D-B	0235092	1 1/4	098268373516	1	23.5	287.50
-----------	---------	-------	--------------	---	------	--------

Includes (1/8") DuoVent, (1/8") SCV, AS-M1, RBFF, ETX-30 and B911S

HPX-30BC-PRO	0235068	1	098268464788	1	19	312.00
HPX-30BD-PRO	0235069	1 1/4	098268464795	1	19	312.00

Boiler Header Module includes AS-MB-FL, RBFF and PIPF-T

HP-BHM-75	0235093	3/4	098268524277	1	7.5	264.50
HP-BHM-100	0235094	1	098268524284	1	8.0	275.00
HP-BHM-125	0235095	1 1/4	098268524291	1	8.5	285.00

HP-30Pro P's includes AS-MB-FL, RBFF, PIPF-T, B911S M3, ETX-30

HP-30PRO-P100	0235098	1	098268524321	1	19	413.50
HP-30PRO-P125	0235099	1 1/4	098268524338	1	20	423.50

HP-30Pro includes AS-MB, RBFF, B911S, ETX-30

HP-30PRO-100	0235096	1	098268524307	1	16	330.00
HP-30PRO-125	0235097	1 1/4	098268524314	1	17	338.00
HP-30PRO-100S	0235101	1	098268573473	1	16.0	265.50
HP-30PRO-125S	0235102	1 1/4	098268573466	1	17.0	271.50



HP-BHM-75



HP-30PRO-P100

*The wetted surface of this product contacted by consumable water contains less than 0.25% of lead by weight.

Consult factory for ordering code numbers of special models/options.

Hydronics/Steam Heating Products

Model	Ordering Code	Size (in.)	UPC	Qty. Per Carton	Weight Per Carton (lbs.)	List Price (each)
-------	---------------	------------	-----	-----------------	--------------------------	-------------------

Service Check Valves

Series SCV



SCV	0376455	1/8	098268472059	50	1.8	\$ 9.00
SCV	0376456	1/4	098268472066	50	5.0	14.75
SCV	0376457	3/8	098268472073	50	15	14.75
SCV	0376458	1/2	098268472080	50	7.7	15.00

Residential Purge and Balancing Valve

Series RPV-M1



RPV-M1-S	0207532	3/4	098268502107	24	26	50.50
RPV-M1-ST	0207535	3/4	098268572216	24	26	43.75
RPV-M1-S	0207533	1	098268502114	18	28	87.00
RPV-M1-ST	0207536	1	098268572223	18	29	74.00
RPV-M1-S	0207534	1 1/4	098268502121	12	24	100.00
RPV-M1-ST	0207537	1 1/4	098268572230	12	24	85.25

Multi-Orifice Flow Control

Series LFP3



For Tankless Heaters

LEAD FREE*

LFP3	0008499	1/2	098268739442	50	22	65.75
------	---------	-----	--------------	----	----	-------

Duovent Automatic Air Vent With Inline High Capacity Manual Vent

For Automatic Air Venting - Max. Temperature 240°F - Max. Pressure 150psi



DuoVent	0590719	1/8	098268861884	144	60	17.25
---------	---------	-----	--------------	-----	----	-------

Automatic Air Vent

Series FV

DuoVent

For Automatic Air Venting, Max. Temperature 240°F - Max. Pressure 150psi



FV-4M1	0590715	1/8	098268373622	144	50	15.75
FV-4M1	0590716	1/4	098268373615	144	58	17.25
FV-4M1	0590722	1/2	098268066708	120	84	23.00
FV-4M1	0590723	3/4	098268066715	120	58	24.75
FV-4M1	0590721	1	098268066692	120	84	27.00

Automatic Air Vent With Manual Override

Series HAV

FV-4M1

Max. Pressure 125psi - Max. Temperature 240°F - Steam Rating 10psi



HAV	0590712	1/8	098268106527	400	20	10.25
HAV	0590713	1/4	098268106534	400	8.0	10.50

HAV

*The wetted surface of this product contacted by consumable water contains less than 0.25% of lead by weight.

Consult factory for ordering code numbers of special models/options.

Hydronics/Steam Heating Products

Model	Ordering Code	Size (in.)	UPC	Qty. Per Carton	Weight Per Carton (lbs.)	List Price (each)
-------	---------------	------------	-----	-----------------	--------------------------	-------------------

Series SAN89S and N50S, and SAN50S

Low Water Cut-Offs - Single Switch Assembly - Single Pole, Single Throw Switch

SAN89S	0226080	15	098268012217	6	10	\$ 579.00
N50S	0183801	50	098268010053	4	26	657.50
SAN50S	0183821	50	098268010077	6	10	655.00

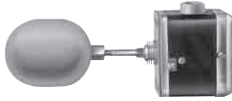

SAN50D

Dual Switch Assembly for independent line voltage and low (or high) voltage alarm, feed valve or pump starter service. Switch actuates just before the burner switch cuts the firing.

SAN89D	0226060	15	098268012200	6	10	594.50
N50D	0182405	50	098268010022	4	25	661.50
SAN50D	0182421	50	098268010039	6	12	509.50

Series 142 and 144

Process Boiler Water Feeders

142	0267687	100	098268012583	4	53	909.00
142S	0268499	100	098268012613	4	57	928.50
144	0268905	100	098268012637	4	54	943.00
144S	0269311	100	098268012668	4	56	1,061.00



142

*The wetted surface of this product contacted by consumable water contains less than 0.25% of lead by weight.

Consult factory for ordering code numbers of special models/options.

Hydronics/Steam Heating Products

Model	Ordering Code	Size (in.)	UPC	Qty. Per Carton	Weight Per Carton (lbs.)	List Price (each)
-------	---------------	------------	-----	-----------------	--------------------------	-------------------

Float & Thermostatic Steam Traps Series WFT



WFT

WFT-15	0037100	3/4	098268478488	4	51	\$ 181.50
WFT-15	0037105	1	098268478495	4	51	204.00
WFT-15	0037106	1 1/4	098268502534	4	56	210.50
WFT-15	0037107	1 1/2	098268502558	1	23	323.50
WFT-15	0037108	2	098268502565	1	28	621.50
WFT-30	0037109	3/4	098268502572	4	12	202.50
WFT-30	0037110	1	098268502589	4	11	228.50
WFT-30	0037111	1 1/4	098268502527	4	14	264.00
WFT-30	0037112	1 1/2	098268502596	1	22	391.50
WFT-30	0037113	2	098268502602	1	30	679.50
WFT-75	0037114	3/4	098268502497	4	13	286.00
WFT-75	0037115	1	098268502510	4	12	311.50
WFT-75	0037116	1 1/4	098268502657	1	22	406.00
WFT-75	0037117	1 1/2	098268502619	1	22	439.00
WFT-75	0037118	2	098268502626	1	29	981.50
WFT-125	0037119	3/4	098268535044	4	51	318.00
WFT-125	0037120	1	098268502503	4	52	358.50
WFT-125	0037121	1 1/4	098268502541	1	22	435.00
WFT-125	0037122	1 1/2	098268502633	1	22	491.50
WFT-125	0037123	2	098268502640	1	29	1,168.00

Model	Ordering Code	Spirax Sarco No.	Size (in.)	UPC	Qty. Per Carton	Weight Per Carton (lbs.)	List Price (each)
-------	---------------	------------------	------------	-----	-----------------	--------------------------	-------------------

Float & Thermostatic Steam Trap Repair Kits

Replacement Steam Trap Cover Assemblies For Spirax Sarco FT Series and Watts



WFTC



WFTK

WFTC-15	0038100	FT-15	3/4	098268488128	12	38	\$ 192.50
WFTC-15	0038101	FT-15	1	098268488135	12	38	192.50
WFTC-15	0038102	FT-15	1 1/4	098268488142	12	37	298.50
WFTC-30	0038105	FT-30	3/4	098268488173	12	37	240.50
WFTC-30	0038106	FT-30	1	098268488180	12	37	250.00
WFTC-30	0038107	FT-30	1 1/4	098268488197	6	19	373.00
WFTC-75	0038110	FT-75	3/4	098268488227	12	40	269.50
WFTC-75	0038111	FT-75	1	098268488234	12	40	279.00
WFTC-125	0038115	FT-125	3/4	098268488272	12	40	336.50
WFTC-125	0038116	FT-125	1	098268488289	12	41	346.00
WFTK-15	0038103	FT-15	1 1/2	098268488159	6	7.7	438.00
WFTK-15	0038104	FT-15	2	098268488166	6	7.2	666.00
WFTK-30	0038108	FT-30	1 1/2	098268488203	6	3.0	571.00
WFTK-30	0038109	FT-30	2	098268488210	6	7.8	765.50
WFTK-75	0038112	FT-75	1 1/4	098268488241	6	6.6	595.00
WFTK-75	0038113	FT-75	1 1/2	098268488258	6	6.6	666.50
WFTK-75	0038114	FT-75	2	098268488265	6	7.2	1,027.00
WFTK-125	0038117	FT-125	1 1/4	098268488296	6	7.3	714.50
WFTK-125	0038119	FT-125	1 1/2	098268488302	6	6.6	714.50
WFTK-125	0038120	FT-125	2	098268488319	6	13	887.50

WFTC Includes cover and cover gasket, condensate valve assembly, float & linkage, thermostatic vent.

WFTK – Includes float linkage, thermostatic air vent, valve head & seat, and gasket.

*The wetted surface of this product contacted by consumable water contains less than 0.25% of lead by weight.

Consult factory for ordering code numbers of special models/options.

Hydronics/Steam Heating Products

Model	Ordering Code	Size (in.)	UPC	Qty. Per Carton	Weight Per Carton (lbs.)	List Price (each)
-------	---------------	------------	-----	-----------------	--------------------------	-------------------



WIB 80

Series WIB

Inverted Bucket Steam Traps

WIB 80-20	0039500	1/2	098268592900	6	33	\$ 225.50
WIB 80-80	0039501	1/2	098268592467	6	33	225.50
WIB 80-150	0039502	1/2	098268592474	6	44	225.50
WIB 80-20	0039504	3/4	098268592481	6	43	225.50
WIB 80-80	0039505	3/4	098268592498	6	46	225.50
WIB 80-150	0039506	3/4	098268592504	6	45	225.50
WIB 81-15	0039508	1/2	098268592511	6	45	292.00
WIB 81-70	0039509	1/2	098268592528	6	36	292.00
WIB 81-125	0039510	1/2	098268592535	6	46	292.00
WIB 81-250	0039511	1/2	098268592542	6	50	292.00
WIB 81-15	0039514	3/4	098268592559	6	50	292.00
WIB 81-70	0039515	3/4	098268592566	6	44	292.00
WIB 81-125	0039516	3/4	098268592573	6	50	292.00
WIB 81-250	0039517	3/4	098268592580	6	48	292.00
WIB 81-15	0039520	1	098268592597	6	52	292.00
WIB 81-70	0039521	1	098268592603	6	50	292.00
WIB 81-125	0039522	1	098268592610	6	47	292.00
WIB 81-250	0039523	1	098268592627	6	47	292.00



QF

Quick Fix™ Steam Trap Replacement Kits

QF-1	0800001	-	098268218657	6	1.0	120.50
QF-2	0800002	-	098268218664	6	1.2	120.50
QF-3	0800003	-	098268218671	6	1.0	120.50
QF-4	0800004	-	098268218688	6	1.2	120.50
QF-5	0800005	-	098268218695	6	0.7	120.50
QF-6	0800006	-	098268218701	6	0.9	120.50
QF-7	0800007	-	098268218718	6	1.2	120.50
QF-8	0800008	-	098268218725	6	1.8	120.50
QF-9	0800009	-	098268218732	6	0.6	120.50
QF-10	0800110	-	098268407402	6	0.6	120.50
QF-11	0800111	-	098268422917	6	1.8	120.50
QF-12	0800112	-	098268422900	6	0.9	120.50
QF-13	0800113	-	098268422894	6	0.6	120.50
QF-14	0800114	-	098268587616	6	1.2	120.50
QF-15	0800115	-	098268575163	6	1.2	120.50
QF-16	0800116	-	098268582055	6	1.8	120.50
QF-25	0800125	-	098268587623	6	1.2	120.50
QF-26	0800126	-	098268587630	6	0.9	120.50
QFC-10	0800010	-	098268218749	6	1.2	120.50



WTD 600

Series WTD

Thermo Dynamic Steam Traps

WTD 600	0038200	3/8	098268634358	1	0.9	271.00
WTD 600	0038201	1/2	098268634365	1	1.4	278.00
WTD 600	0038202	3/4	098268634372	1	2.2	352.00
WTD 600	0038203	1	098268634389	1	36	534.50

*The wetted surface of this product contacted by consumable water contains less than 0.25% of lead by weight.

Consult factory for ordering code numbers of special models/options.

Hydronics/Steam Heating Products

Model	Ordering Code	Size (in.)	Pattern	Pressure Range	UPC	Qty. Per Carton	Weight Per Carton (lbs.)	List Price (each)
-------	---------------	------------	---------	----------------	-----	-----------------	--------------------------	-------------------

Series G, GH, MG and MGH

Thermostatic/Radiator Steam Traps



1 GAP

1 GAP	0036040	1/2	Angle	25" Hg to 25 psig	098268395419	6	9.1	\$ 125.00
1 GSW	0036041	1/2	Straightway	25" Hg to 25 psig	098268395426	6	10	130.00
1 GRHC	0036042	1/2	Right Hand Corner	25" Hg to 25 psig	098268395433	6	9.6	204.50
1 GLHC	0036043	1/2	Left Hand Corner	25" Hg to 25 psig	098268395440	12	16	204.50
1 VG	0036044	1/2	Vertical	25" Hg to 25 psig	098268395457	12	20	160.50
1 VGDU	0036045	1/2	Vertical Dbl. Union	25" Hg to 25 psig	098268395464	6	7.8	239.00
3 GHAP	0036046	3/4	Angle	25" Hg to 25 psig	098268395471	6	11	159.50
3 GHSW	0036047	3/4	Straightway	25" Hg to 25 psig	098268395488	6	13	199.50
1 MGAP	0036048	1/2	Angle	25" Hg to 65 psig	098268395495	6	9.0	139.00
1 MGSW	0036049	1/2	Straightway	25" Hg to 25 psig	098268395501	6	14	152.50
3 MGHAP	0036050	3/4	Angle	25" Hg to 65 psig	098268395518	6	11	175.00
3 MGHSW	0036051	3/4	Straightway	25" Hg to 25 psig	098268395525	6	13	189.50
5 MGHAP	0036052	1	Angle	25" Hg to 65 psig	098268395532	6	16	290.00

Model	Ordering Code	Size (in.)	Pattern	Trap Being Replaced	UPC	Qty. Per Carton	Weight Per Carton (lbs.)	List Price (each)
-------	---------------	------------	---------	---------------------	-----	-----------------	--------------------------	-------------------

SERIES G

Replacement Steam Traps

1GT/MON25A	0036068	1/2	Angle (Outboard only)	Illinois 1T, 2T/ Monash 35A (3)	098268395600	12	1.2	\$ 240.50
------------	---------	-----	-----------------------	---------------------------------	--------------	----	-----	-----------

Model	Ordering Code	Size (in.)	Pressure Range	UPC	Qty. Per Carton	Weight Per Carton (lbs.)	List Price (each)
-------	---------------	------------	----------------	-----	-----------------	--------------------------	-------------------

Series G and MG

Float and Thermostatic (F&T) Steam Traps



6G-15

6G-15	0036096	3/4	25" Hg to 15 psig	098268395822	6	41	\$ 449.00
7G-15	0036097	1		098268395846	4	39	607.00
8G-15	0036098	1 1/4		098268395877	4	49	643.00
91G-15	0036099	1 1/2		098268395921	1	40	1,352.00
101G-15	0036100	2		098268395952	1	64	1,962.00
111MG-15	0036101	2	25" Hg to 30 psig	098268395969	1	85	2,761.00
8MG-30	0036104	1 1/4		098268395983	4	49	782.50
91MG-30	0036105	1 1/2		098268395990	1	40	1,540.00
111MG-30	0036107	2		098268396010	1	85	3,031.00
6MG-50	0036109	3/4		098268396027	6	40	534.00
7MG-50	0036110	1	098268396034	4	38	654.00	
91MG-50	0036112	1 1/2	098268396058	1	37	1,540.00	
101MG-50	0036113	2	098268396065	1	64	2,189.00	

*The wetted surface of this product contacted by consumable water contains less than 0.25% of lead by weight.

Consult factory for ordering code numbers of special models/options.

Hydronics/Steam Heating Products

Model	Ordering Code	Size (in.)	Pressure Range	UPC	Qty. Per Carton	Weight Per Carton (lbs.)	List Price (each)
-------	---------------	------------	----------------	-----	-----------------	--------------------------	-------------------



Series GF and MGF

Series GF and MGF

Float Traps

6GF-15	0036142	3/4	25" Hg to 15 psig	098268396140	6	40	\$ 618.50
7GF-15	0036143	1		098268396164	4	38	731.50
8GF-15	0036144	1 1/4		098268396195	4	49	880.50
91GF-15	0036145	1 1/2		098268396225	1	39	1,670.00
101GF-15	0036146	2		098268396256	1	59	2,378.00
111MGF-15	0036147	2		098268396263	1	85	3,306.00
8MGF-30	0036150	1 1/4	25" Hg to 30 psig	098268396287	4	48	880.50
91MGF-30	0036151	1 1/2		098268396294	1	37	1,670.00
111MGF-30	0036153	2		098268396317	1	85	3,306.00
6MGF-50	0036155	3/4	25" Hg to 50 psig	098268396324	6	40	618.50
7MGF-50	0036156	1		098268396331	4	38	731.50
8MGF-50	0036157	1 1/4		098268396348	4	50	880.50
91MGF-50	0036158	1 1/2		098268396355	1	37	1,670.00
101MGF-50	0036159	2		098268396362	1	59	2,378.00
111MGF-50	0036160	2		098268396379	1	85	3,306.00

Model	Ordering Code	Size (in.)	End Pattern	Connections	UPC	Qty. Per Carton	Weight Per Carton (lbs.)	List Price (each)
-------	---------------	------------	-------------	-------------	-----	-----------------	--------------------------	-------------------

Radiator Supply Valves

Series 65



Series 65

AP-65	0036001	1/2	Angle	Thread-Male Union	098268395051	6	8.4	\$ 220.50
SW-65	0036002	1/2	Straightway	Thread-Male Union	098268395068	6	8.8	257.50
AP-65	0036003	3/4	Angle	Thread-Male Union	098268395075	6	11	259.00
SW-65	0036004	3/4	Straightway	Thread-Male Union	098268395082	12	11	305.00
AP-65	0036005	1	Angle	Thread-Male Union	098268395099	12	2.4	354.00
SW-65	0036006	1	Straightway	Thread-Male Union	098268395105	6	117	508.50

Series 65 Radiator Supply Valves are suited only for two pipe steam or two pipe forced circulation hot/chilled water systems and are not applicable to one pipe steam or one pipe gravity water systems.

Model	Ordering Code	Size (in.)	UPC	Qty. Per Carton	Weight Per Carton (lbs.)	List Price (each)
-------	---------------	------------	-----	-----------------	--------------------------	-------------------

Heating Valves and Fittings

Series RA

Steam Angle Radiator Valve - Bronze - FIP x Male Union



RA-1-AP

RA-1-AP	0067450	1/2	098268394863	60	48	\$ 50.00
RA-1-AP	0067451	3/4	098268394870	48	52	59.25
RA-1-AP	0067452	1	098268394887	36	57	70.75
RA-1-AP	0067453	1 1/4	098268394894	24	53	90.00
RA-1-AP	0067454	1 1/2	098268394900	18	59	135.00
RA-1-AP	0067600	2	098268589511	12	57	220.00

Steam Angle Radiator Valve - Brass - FIP x Male Union

RA-2-AP	0067545	1/2	098268815733	60	47	41.75
RA-2-AP	0067455	3/4	098268401554	48	47	38.00
RA-2-AP	0067456	1	098268401561	36	54	49.00
RA-2-AP	0067457	1 1/4	098268401578	24	46	66.75

*The wetted surface of this product contacted by consumable water contains less than 0.25% of lead by weight.

Consult factory for ordering code numbers of special models/options.

Hydronics/Steam Heating Products

Model	Ordering Code	Size (in.)	UPC	Qty. Per Carton	Weight Per Carton (lbs.)	List Price (each)
-------	---------------	------------	-----	-----------------	--------------------------	-------------------

Heating Valves and Fittings

Series RA (cont.)



RA-1-SW

Steam Angle Convector Valve - Bronze - Female Union x FIP

RA-CV	0067615	1	098268589580	36	68	\$ 99.00
RA-CV	0067616	1 1/4	098268589603	24	60	109.00

Steam Radiator Gate Valve - Bronze - FIP x Male Union

RA-1-SW	0067605	1/2	098268589528	60	51	66.25
RA-1-SW	0067606	3/4	098268589542	48	56	79.75
RA-1-SW	0067607	1	098268589559	36	65	87.25
RA-1-SW	0067608	1 1/4	098268589566	24	64	116.00
RA-1-SW	0067609	1 1/2	098268589573	18	64	152.50



OTV-FL

Series OTV-M1

Oil Tank Valves

OTV-FL-M1	0067652	1/2 M X 3/8 FL	098268560909	72	63	46.75
OTV-M-M1	0067653	1/2 M X 3/8 M	098268560916	72	68	44.25



HBV

Series HBV

Hydronic Balancing (Ball) Valve - Solder x Solder 600 WOG

HBV	0067640	1/2	098268589689	240	48	20.00
HBV	0067641	3/4	098268589696	108	41	29.00
HBV	0067642	1	098268589702	108	86	41.50

Series HWA

Hot Water Angle Valve - Bronze - FIP x Male Union

HWA	0067620	1/2	098268589610	70	53	52.75
HWA	0067621	3/4	098268589627	70	66	61.75
HWA	0067622	1	098268589634	36	57	74.50
HWA	0067623	1 1/4	098268589641	24	53	115.50



HWA

Hot Water Angle Valve - Bronze - Solder x Male Union

HWA	0067458	1/2	098268394917	70	53	48.00
HWA	0067459	3/4	098268394924	70	61	55.25

Series UL

Union Elbow - Bronze - FIP x Male Union

UL-1	0067460	1/2	098268394931	150	75	25.00
UL-1	0067461	3/4	098268394948	100	59	32.25
UL-1	0067630	1	098268589665	70	67	52.50
UL-1	0067631	1 1/4	098268589672	50	67	81.25



UL-1

Union Elbow - Bronze - Solder x Male Union

UL-2	0067462	1/2	098268394955	150	57	25.00
UL-2	0067463	3/4	098268394962	100	53	32.25

Series SV, SVA, SVS

Steam Air Vents

SV	0841000	1/8 angle non-adjustable	098268543506	144	22	18.75
SVA	0841005	1/8 angle adjustable	098268543513	144	24	23.25
SVS-1	0841010	1/8 straight, non-adjustable	098268543520	144	23	21.00
SVS-2	0841015	1/4 straight, non-adjustable	098268543537	144	23	25.50
SVS-3	0841020	3/4 MIP or 1/2 FIP, straight non-adjustable	098268543544	144	29	26.00



SVA

*The wetted surface of this product contacted by consumable water contains less than 0.25% of lead by weight.

Consult factory for ordering code numbers of special models/options.

Tempering Valves



LFUSG-B-QC-M2

Model	Ordering Code	Size (in.)	UPC	Qty. Per Carton	Weight Per Carton (lbs.)	List Price (each)
-------	---------------	------------	-----	-----------------	--------------------------	-------------------

Thermostatic Tempering Valves - ASSE 1070 - 80°F - 120°F Series USG

LEAD FREE*	LFUSG-B M2	0204143	3/8" compression bronze body	098268548457	24	20	\$ 220.00
	LFUSG-B-SC M2	0204144	3/8" compression bronze body – satin chrome	098268548389	24	20	345.50
	LFUSG-B-QC-M2	0204146	3/8 Quick-Connect bronze body	098268548365	12	13	242.00
	LFUSG-B-QC-SC-M2	0204139	3/8 Quick-Connect bronze body-satin chrome	098268469479	12	17	333.00

LavSafe™ Thermostatic Faucet 60°F - 120°F Series 1070 and P1070

ASSE 1070, cUPC, NSF 61 Annex 9-G, ADA



1070



P1070

LEAD FREE*	1070	0205258	3/8" compression, 2.0 gpm aerator	098268536850	6	21	\$ 330.50
	1070-6	0205259	3/8" compression, 2.0 gpm aerator, 6" lever handle	098268536867	6	22	343.50
	1070A5	0205260	3/8" compression, 0.5 gpm Outlet	098268536898	6	21	336.50
	1070A15	0205261	3/8" compression, 1.5 gpm aerator †	098268536904	6	21	336.50
	1070PW	0205262	3/8" compression, 2.0 gpm aerator, pop-up waste	098268536911	6	23	361.50
	1070L	0205230	3/8" compression, 2 gpm laminar outlet	098268536010	6	21	342.50
	1070L5	0205231	3/8" compression, 0.5 gpm laminar outlet	098268536027	6	21	354.00
	1070VA	0205232	3/8" compression, 2 gpm vandal-resistant Aerator	098268536089	6	21	342.50
	1070V5	0205233	3/8" compression, 0.5 gpm vandal-resistant Aerator	098268536119	6	21	344.50
	1070VL	0205234	3/8" compression, 2 gpm vandal-resistant laminar outlet	098268536126	6	21	344.50
	1070VL5	0205235	3/8" compression, 0.5 gpm vandal-resistant laminar outlet	098268536133	6	21	360.50
	P1070	0205263	3/8" compression, deck plate, 2.0 gpm aerator	098268536928	6	24	355.00
	P1070-6	0205264	3/8" compression, deck plate, 2.0 gpm aerator, 6" lever handle	098268536935	6	26	368.00
	P1070A5	0205265	3/8" compression, deck plate, 0.5 gpm Outlet	098268536942	6	24	362.50
	P1070A15	0205266	3/8" compression, deck plate, 1.5 gpm aerator †	098268536959	6	24	362.50
P1070PW	0205267	3/8" compression, deck plate, 2.0 gpm aerator, pop-up waste	098268536966	6	26	386.00	
P1070L	0205236	3/8" compression, deck plate, 2 gpm laminar outlet	098268536188	6	24	367.00	
P1070L5	0205237	3/8" compression, deck plate, 0.5 gpm laminar outlet	098268536195	6	24	379.00	
P1070VA	0205238	3/8" compression, deck plate, 2 gpm vandal-resistant Aerator	098268536218	6	24	367.00	
P1070V5	0205239	3/8" compression, deck plate, 0.5 gpm vandal-resistant Aerator	098268536225	6	24	369.00	
P1070VL	0205240	3/8" compression, deck plate, 2 gpm vandal-resistant laminar outlet	098268536232	6	24	369.00	
P1070VL5	0205241	3/8" compression, deck plate, 0.5 gpm vandal-resistant laminar outlet	098268536416	6	24	385.00	

†WaterSense® applies to 1.5 gpm aerator models only.

WaterSense® is a registered trademark of the EPA.

*The wetted surface of this product contacted by consumable water contains less than 0.25% of lead by weight.

Consult factory for ordering code numbers of special models/options.

Tempering Valves

Model	Ordering Code	Size (in.)	UPC	Qty. Per Carton	Weight Per Carton (lbs.)	List Price (each)
-------	---------------	------------	-----	-----------------	--------------------------	-------------------

LavSafe™ Thermostatic Faucet 60°F - 120°F Series G1070 and GP1070 (cont.)

ASSE 1070, cUPC, NSF 61 Annex 9-G, ADA



G1070



GP1070-6

LEAD FREE*

G1070	0205268	3/8" compression, gooseneck spout, 2.0 gpm aerator	098268536973	6	26	\$ 432.50
G1070A5	0205269	3/8" compression, gooseneck spout, 0.5 gpm Outlet	098268536980	6	28	437.50
GP1070	0205270	3/8" compression, gooseneck spout, deck plate, 2.0 gpm aerator	098268536997	6	30	470.00
GP1070A5	0205271	3/8" compression, gooseneck spout, deck plate, 0.5 gpm Outlet	098268537000	6	30	477.00
G1070-6	0205242	3/8" compression, gooseneck spout, 6" lever handle	098268536423	6	28	444.00
G1070A15	0205243	3/8" compression, gooseneck spout, 1.5 gpm aerator†	098268536430	6	26	437.50
G1070L	0205244	3/8" compression, gooseneck spout, 2 gpm laminar outlet	098268536447	6	26	443.00
G1070L5	0205245	3/8" compression, gooseneck spout, 0.5 gpm laminar outlet	098268536454	6	26	456.00
G1070VA	0205246	3/8" compression, gooseneck spout, 2.0 gpm vandal-resistant Aerator	098268536461	6	26	443.00
G1070V5	0205247	3/8" compression, gooseneck spout, 0.5 gpm vandal-resistant Aerator	098268536478	6	26	446.00
G1070VL	0205248	3/8" compression, gooseneck spout, 2 gpm vandal-resistant laminar outlet	098268536485	6	26	446.00
G1070VL5	0205249	3/8" compression, gooseneck spout, 0.5 gpm vandal-resistant laminar outlet	098268536492	6	26	461.00
GP1070-6	0205250	3/8" compression, gooseneck spout, deck plate, 6" lever handle	098268536607	6	32	482.50
GP1070A15	0205251	3/8" compression, gooseneck spout, deck plate, 1.5 gpm aerator†	098268536768	6	31	476.00
GP1070L	0205252	3/8" compression, gooseneck spout, deck plate, 2 gpm laminar outlet	098268536782	6	31	481.00
GP1070L5	0205253	3/8" compression, gooseneck spout, deck plate, 0.5 gpm laminar outlet	098268536799	6	31	493.00
GP1070VA	0205254	3/8" compression, gooseneck spout, deck plate, 0.2 gpm vandal-resistant Aerator	098268536805	6	31	481.00
GP1070V5	0205255	3/8" compression, gooseneck spout, deck plate, 0.5 gpm vandal-resistant Aerator	098268536812	6	31	484.00
GP1070VL	0205256	3/8" compression, gooseneck spout, deck plate, 2 gpm vandal-resistant laminar outlet	098268536829	6	31	484.00
GP1070VL5	0205257	3/8" compression, gooseneck spout, deck plate, 0.5 gpm vandal-resistant laminar outlet	098268536843	6	31	499.50

†WaterSense® applies to 1.5 gpm aerator models only.

WaterSense® is a registered trademark of the EPA.

*The wetted surface of this product contacted by consumable water contains less than 0.25% of lead by weight.

Consult factory for ordering code numbers of special models/options.

Tempering Valves

Model	Ordering Code	Size (in.)	UPC	Qty. Per Carton	Weight Per Carton (lbs.)	List Price (each)
-------	---------------	------------	-----	-----------------	--------------------------	-------------------

Thermostatic Tempering Valves - ASSE 1017, 1069, 1070 - Maximum Temperature 80°F - 120°F

Series LFMMV

Union Threaded Ends

LEAD FREE*	Model	Ordering Code	Size (in.)	UPC	Qty. Per Carton	Weight Per Carton (lbs.)	List Price (each)
	LFMMVM1-UT	0559116	1/2	098268451795	12	25	\$ 233.00
	LFMMVM1-UT	0559119	3/4	098268451825	12	34	290.50
	LFMMVM1-UT	0559122	1	098268451856	6	22.6	381.50

Union Solder Ends

LEAD FREE*	Model	Ordering Code	Size (in.)	UPC	Qty. Per Carton	Weight Per Carton (lbs.)	List Price (each)
	LFMMVM1-US	0559115	1/2	098268451788	12	24	233.00
	LFMMVM1-US	0559118	3/4	098268451818	12	31	290.50
	LFMMVM1-US	0559121	1	098268451849	6	16	381.50

Union PEX Ends

LEAD FREE*	Model	Ordering Code	Size (in.)	UPC	Qty. Per Carton	Weight Per Carton (lbs.)	List Price (each)
	LFMMVM1-PEX	0559114	1/2	098268451771	12	24	233.00
	LFMMVM1-PEX	0559117	3/4	098268451801	12	30	290.50
	LFMMVM1-PEX	0559120	1	098268451832	6	21	381.50

Union CPVC Ends

LEAD FREE*	Model	Ordering Code	Size (in.)	UPC	Qty. Per Carton	Weight Per Carton (lbs.)	List Price (each)
	LFMMVM1-CPVC	0559161	1/2	098268452396	12	23	233.00
	LFMMVM1-CPVC	0559162	3/4	098268452402	12	28	290.50
	LFMMVM1-CPVC	0559163	1	098268452419	6	16	381.50

Union Quick-Connect Ends

LEAD FREE*	Model	Ordering Code	Size (in.)	UPC	Qty. Per Carton	Weight Per Carton (lbs.)	List Price (each)
	LFMMVM1-QC	0559164	1/2	098268452426	12	28	253.50
	LFMMVM1-QC	0559165	3/4	098268452433	6	20	311.50
	LFMMVM1-QC	0559166	1	098268452440	6	23	402.50



LFMMVM1-UT



LFMMVM1-QC

Thermostatic Tempering Valves - ASSE 1017 - Maximum Temperature 90°F - 160°F

Series LF1170

Union Threaded Ends

LEAD FREE*	Model	Ordering Code	Size (in.)	UPC	Qty. Per Carton	Weight Per Carton (lbs.)	List Price (each)
	LF1170M2-UT	0559101	1/2	098268451641	12	28	236.00
	LF1170M2-UT	0559104	3/4	098268451672	12	36	308.50
	LF1170M2-UT	0559106	1	098268451696	6	23	383.50

Union Solder Ends

LEAD FREE*	Model	Ordering Code	Size (in.)	UPC	Qty. Per Carton	Weight Per Carton (lbs.)	List Price (each)
	LF1170M2-US	0559100	1/2	098268451634	12	24	236.00
	LF1170M2-US	0559103	3/4	098268451665	12	35	308.50
	LF1170M2-US	0559105	1	098268451689	6	20	383.50

Union PEX Ends

LEAD FREE*	Model	Ordering Code	Size (in.)	UPC	Qty. Per Carton	Weight Per Carton (lbs.)	List Price (each)
	LF1170M2-PEX	0559143	1/2	098268452211	12	24	236.00
	LF1170M2-PEX	0559102	3/4	098268451658	12	35	308.50
	LF1170M2-PEX	0559144	1	098268452228	6	19	383.50

Union CPVC Ends

LEAD FREE*	Model	Ordering Code	Size (in.)	UPC	Qty. Per Carton	Weight Per Carton (lbs.)	List Price (each)
	LF1170M2-CPVC	0559145	1/2	098268452235	12	23	236.00
	LF1170M2-CPVC	0559146	3/4	098268452242	12	28	308.50
	LF1170M2-CPVC	0559147	1	098268452259	6	16	383.50

Union Quick-Connect Ends

LEAD FREE*	Model	Ordering Code	Size (in.)	UPC	Qty. Per Carton	Weight Per Carton (lbs.)	List Price (each)
	LF1170M2-QC	0559148	1/2	098268452266	12	28	256.50
	LF1170M2-QC	0559149	3/4	098268452273	6	20	330.00
	LF1170M2-QC	0559150	1	098268452280	6	23	405.00



LF1170-M2-UT

*The wetted surface of this product contacted by consumable water contains less than 0.25% of lead by weight.

Consult factory for ordering code numbers of special models/options.

Tempering Valves

Model	Ordering Code	Size (in.)	UPC	Qty. Per Carton	Weight Per Carton (lbs.)	List Price (each)
-------	---------------	------------	-----	-----------------	--------------------------	-------------------



LFL1170-PEX

Thermostatic Tempering Valves - ASSE 1017 - Low Temperature, 60°F - 120°F

Series LF1170

Union Threaded Ends

LEAD FREE*	Model	Ordering Code	Size (in.)	UPC	Qty. Per Carton	Weight Per Carton (lbs.)	List Price (each)
	LFL1170M2-UT	0559108	1/2	098268451719	12	26	\$ 236.00
	LFL1170M2-UT	0559110	3/4	098268451733	12	31	308.50
	LFL1170M2-UT	0559160	1	098268452389	6	19	383.50

Union Solder Ends

LEAD FREE*	Model	Ordering Code	Size (in.)	UPC	Qty. Per Carton	Weight Per Carton (lbs.)	List Price (each)
	LFL1170M2-US	0559107	1/2	098268451702	12	24	236.00
	LFL1170M2-US	0559109	3/4	098268451726	12	34	308.50
	LFL1170M2-US	0559111	1	098268451740	6	19	383.50

Union PEX Ends

LEAD FREE*	Model	Ordering Code	Size (in.)	UPC	Qty. Per Carton	Weight Per Carton (lbs.)	List Price (each)
	LFL1170M2-PEX	0559151	1/2	098268452297	12	24	236.00
	LFL1170M2-PEX	0559152	3/4	098268452303	12	31	308.50
	LFL1170M2-PEX	0559153	1	098268452310	6	19	383.50

Union CPVC Ends

LEAD FREE*	Model	Ordering Code	Size (in.)	UPC	Qty. Per Carton	Weight Per Carton (lbs.)	List Price (each)
	LFL1170M2-CPVC	0559154	1/2	098268452327	12	23	236.00
	LFL1170M2-CPVC	0559155	3/4	098268452334	12	28	308.50
	LFL1170M2-CPVC	0559156	1	098268452341	6	14	383.50

Union Quick-Connect Ends

LEAD FREE*	Model	Ordering Code	Size (in.)	UPC	Qty. Per Carton	Weight Per Carton (lbs.)	List Price (each)
	LFL1170M2-QC	0559157	1/2	098268452358	12	28	256.50
	LFL1170M2-QC	0559158	3/4	098268452365	6	20	330.00
	LFL1170M2-QC	0559159	1	098268452372	6	23	405.00

Hot Water Extender Tempering Valves

Series LF70A and LFL70A

Hot Water Extender Tempering Valves - 120°-160°F - For Residential Installations

LEAD FREE*	Model	Ordering Code	Size (in.)	UPC	Qty. Per Carton	Weight Per Carton (lbs.)	List Price (each)
	LF70A-F **	0559129	1/2	098268451870	25	14	146.50
	LF70A-T	0559130	1/2	098268451887	25	28	162.00
	LF70A **	0559133	3/4	098268451917	25	20	170.00
	LF70A T	0559134	3/4	098268451924	25	23	199.00

Low Temperature Hot Water Extender Tempering Valves - 100° - 130°F - For Residential Installations

LEAD FREE*	Model	Ordering Code	Size (in.)	UPC	Qty. Per Carton	Weight Per Carton (lbs.)	List Price (each)
	LFL70A-F **	0559131	1/2	098268451894	25	13	180.50
	LFL70AT	0559132	1/2	098268451900	25	40	189.00
	LFL70A **	0559135	3/4	098268451931	25	28	209.50
	LFL70AT	0559136	3/4	098268451948	25	23	233.50

** Solder Connections



LF70A

Master Tempering Valves

Series LFN170

Master Tempering Valves - ASSE 1017 90° -180°F - For Commercial Installations

LEAD FREE*	Model	Ordering Code	Size (in.)	UPC	Qty. Per Carton	Weight Per Carton (lbs.)	List Price (each)
	LFN170M3	0559124	3/4	686408611972	6	29	1,032.00
	LFN170M3	0559125	1	686408611989	6	29	1,162.00
	LFN170M3	0559126	1 1/4	686408611996	4	38	1,796.00
	LFN170M3	0559127	1 1/2	686408612009	4	36	1,963.00
	LFN170M3	0559128	2	686408612016	3	31	2,945.00

Master Tempering Valves with Check Stops- ASSE 1017 90° -180°F - For Commercial Installations

LEAD FREE*	Model	Ordering Code	Size (in.)	UPC	Qty. Per Carton	Weight Per Carton (lbs.)	List Price (each)
	LFN170M3-CSUT	0559167	3/4	686408612177	1	10	1,296.00
	LFN170M3-CSUT	0559168	1	686408612184	1	10	1,479.00
	LFN170M3-CSUT	0559169	1 1/4	686408612191	1	19	1,972.00
	LFN170M3-CSUT	0559170	1 1/2	686408612207	1	20	2,192.00
	LFN170M3-CSUT	0559171	2	686408612214	1	21	3,075.00



LFN170M3



LFN170M3 CSUT

*The wetted surface of this product contacted by consumable water contains less than 0.25% of lead by weight.

Consult factory for ordering code numbers of special models/options.

Wall Hydrants

Model	Ordering Code	Wall Thickness Size (in.)	UPC	Qty. Per Carton	Weight Per Carton (lbs.)	List Price (each)
-------	---------------	---------------------------	-----	-----------------	--------------------------	-------------------

Freezeless Wall Hydrants

Series FH and LFFH

Less Vacuum Breaker - Inlet 1/2" Solder or 1/2" Male I.P.S.

FH-1-M1	0723160	4	098268493184	40	40	\$ 38.75
FH-1-M1	0723161	6	098268493177	40	44	40.25
FH-1-M1	0723162	8	098268493160	40	47	41.25
FH-1-M1	0723163	10	098268493191	40	48	42.25
FH-1-M1	0723164	12	098268493207	40	51	42.50
FH-1-M1	0723165	14	098268493214	40	55	43.75

Inlet 1/2" PEX

FH-1-M1-PEX	0723035	4	098268325560	40	41	44.50
FH-1-M1-PEX	0723036	6	098268325737	40	44	48.00
FH-1-M1-PEX	0723037	8	098268325577	40	42	49.00
FH-1-M1-PEX	0723038	10	098268325584	40	49	51.00
FH-1-M1-PEX	0723040	14	098268325607	40	55	54.25



FH-1-M1-PEX



FHB

Series FHB and LFFHB

With Vacuum Breaker - Inlet 1/2" Solder or 1/2" Male I.P.S.-

ASSE Std. 1019, IAPMO Listed

FHB-1	0723010	4	098268678109	20	22	42.25
FHB-1	0723011	6	098268678123	20	25	46.00
FHB-1	0723012	8	098268678130	20	29	48.75
FHB-1	0723013	10	098268678147	20	27	49.00
FHB-1	0723014	12	098268678154	20	29	54.25
FHB-1	0723015	14	098268678161	20	30	55.50

*The wetted surface of this product contacted by consumable water contains less than 0.25% of lead by weight.

Consult factory for ordering code numbers of special models/options.

Wall Hydrants and Water Hammer Arrestors

Model	Ordering Code	Size (in.)	UPC	Qty. Per Carton	Weight Per Carton (lbs.)	List Price (each)
-------	---------------	------------	-----	-----------------	--------------------------	-------------------



FHB-1-PEX

Series FHB and LFFHB (cont.)

With Vacuum Breaker - Inlet 1/2" PEX - ASSE 1019, IAPMO

FHB-1-PEX	0723025	4	098268324532	20	22	\$ 57.50
FHB-1-PEX	0723026	6	098268324549	20	24	59.50
FHB-1-PEX	0723027	8	098268324556	20	25	60.25
FHB-1-PEX	0723028	10	098268324273	20	27	62.25
FHB-1-PEX	0723029	12	098268324280	20	29	64.00
FHB-1-PEX	0723030	14	098268324358	20	30	66.75

Inlet 3/4" Male I.P.S. or 1/2" Female I.P.S.

FHB-2	0723016	4	098268678178	20	21	55.50
FHB-2	0723017	6	098268678185	20	21	57.75
FHB-2	0723018	8	098268678192	20	23	59.75
FHB-2	0723019	10	098268678208	20	24	62.25
FHB-2	0723020	12	098268678222	20	25	64.00
FHB-2	0723021	14	098268678239	20	32	69.00

Inlet 3/4" Solder or 3/4" Male I.P.S.

FHB-2-3/4"	0723022	12	098268701913	20	28	64.00
------------	---------	----	--------------	----	----	-------

*The wetted surface of this product contacted by consumable water contains less than 0.25% of lead by weight.

Consult factory for ordering code numbers of special models/options.

Water Hammer Arrestors

Model	Ordering Code	Size (in.)	UPC	Qty. Per Carton	Weight Per Carton (lbs.)	List Price (each)
-------	---------------	------------	-----	-----------------	--------------------------	-------------------

Water Hammer Arrestors

Series LF05

Mini Water Hammer Arrestors - ASSE Std 1010, IAPMO Listed



LEAD FREE*	Straight Models		Inlet Size			
	Model	Ordering Code	Size (in.)	UPC	Qty. Per Carton	List Price (each)
	LF05 (NPT)	0009850	3/8	098268430110	30	\$ 50.50
	LF05 (NPT)	0009851	1/2	098268430127	30	50.75
	LF05H (Hose)	0009852	3/4	098268430134	12	58.50
	LF05H-M1 (Hose)	0009853	3/4	098268430141	12	60.50
	LF05-S (Solder)	0009854	1/2	098268430158	30	50.75
	LF05-S (Solder)	0009856	3/4	098268430172	24	60.50
	LF05A-CH (NPT)	0009855	3/4	098268430165	12	63.50

Tee Models

LEAD FREE*	Model	Ordering Code	Size (in.)	UPC	Qty. Per Carton	List Price (each)
	LF05-C-T (Compression)	0121272	3/8	098268582222	30	67.50
	LF05-CXT (Comp x Rrvs Comp Nut)	0121273	3/8	098268582239	30	65.00
	LF05-PEX-T	0009857	1/2	098268430189	12	66.00

Series LF15

Water Hammer Arrestors - Stops Banging Pipes -

P.D.I. approved, ASSE Std. 1010, IAPMO Listed



LEAD FREE*	Model	Ordering Code	Size (in.)	UPC	Qty. Per Carton	List Price (each)
	LF15M2-AS	0750150	1/2	098268499384	30	\$ 23.75
	LF15M2-BS	0750151	3/4	098268499391	24	28.50
	LF15M2-CS	0750152	1	098268499407	12	71.00
	LF15M2-DS	0750153	1	098268499414	6	90.50
	LF15M2-ES	0750154	1	098268499421	4	122.00
	LF15M2-FS	0750155	1	098268499438	4	188.00
	LF15M2-A	0750160	1/2	098268526127	30	32.50
	LF15M2-B	0750161	3/4	098268526134	24	38.00
	LF15M2-C	0750162	1	098268526141	12	98.75
	LF15M2-D	0750163	1	098268526158	6	125.00
	LF15M2-E	0750164	1	098268526165	4	168.00
	LF15M2-F	0750165	1	098268526172	4	271.50

Series LF150

Water Hammer Arrestor For Washing Machines



LEAD FREE*	Model	Ordering Code	Size (in.)	UPC	Qty. Per Carton	List Price (each)
	LF150A	0121227	1/2	098268580266	12	80.75

Fitting For 1/2" Shock Arrestor For Washing Machines

LEAD FREE*	Model	Ordering Code	Size (in.)	UPC	Qty. Per Carton	List Price (each)
	LF150HA	0121229	3/4 H.T.	098268580280	50	23.00

Water Hammer Arrestor and Fitting For Washing Machines

LEAD FREE*	Model	Ordering Code	Size (in.)	UPC	Qty. Per Carton	List Price (each)
	LF150A-HA	0121231	3/4 H.T.	098268580303	12	103.50

*The wetted surface of this product contacted by consumable water contains less than 0.25% of lead by weight.

Consult factory for ordering code numbers of special models/options.

Plumbing Specialties

Model	Ordering Code	Size (in.)	Adapter Fitting/Description	UPC	Qty. Per Carton	Weight Per Carton (lbs.)	List Price (each)
-------	---------------	------------	-----------------------------	-----	-----------------	--------------------------	-------------------

IntelliFlow® Automatic Water Shutoff Valves For Washing Machines

Series A2



A2C-M1

A2C-M1	0004640	1/2	surface mount – solder; with leak sensor	098268910537	8	20	\$ 309.00
A2C-WB-M1**	0004646	1/2	with wall box-solder and/or thread; with leak sensor	098268910544	6	27	332.00
A2C-LS	0004647	1/2	leak sensor for A2C-M1, A2C-WB-M1	098268923506	12	3.2	64.25
A2-Intellitimer	0004650		allows A2 to be used with 220VAC appliance	098268183085	6	3.3	220.00
KA2-BD	0004800	1/2	retrofit kit for straight or angle shutoffs	098268922769	12	19	113.00
KA2-A	0004804	1/2	retrofit kit for 2, A2, A2C, A2C-M	098268922806	12	9.8	113.00
KA2-R	0004805	1/2	retrofit kit for 2, A2-WB, A2C-WB, A2C-WB-M	098268922813	12	9.6	113.00

** With wall mount box

Decorative Wall Box With Duo-Cloz™

Series 2M2



2M2 DWB

2M2 DWB	0006625	–	Decorative Wall Box	098268858389	–	19	144.50
2M2 DWB	0006626	–	Finish Kit	098268253146	–	18	50.75
2M2 DWB	0006627	–	Rough-In Kit	098268253153	–	12	50.75

DUO-CLOZ™ Water Shutoff Valves For Washing Machines

Series 2

Plain Brass Body



2M2

2-M2	0006644	1/2	Solder Copper Ell	098268302417	24	31	73.25
2T-M2	0006643	1/2	Male Threaded Brass †Satin Chrome Body	098268302400	24	22	73.25
2-M2-SC	0006364	1/2	Solder Copper Ell	098268371741	24	34	92.00
2T-M2-SC	0006363	1/2	Male Threaded Brass	098268371734	24	28	92.00

*The wetted surface of this product contacted by consumable water contains less than 0.25% of lead by weight.

Consult factory for ordering code numbers of special models/options.

Plumbing Specialties

Model	Ordering Code	Size (in.)	Adapter Fitting/Description	UPC	Qty. Per Carton	Weight Per Carton (lbs.)	List Price (each)
-------	---------------	------------	-----------------------------	-----	-----------------	--------------------------	-------------------

Boiler Drains

Series BD and LFBD

BD1C	0820901	1/2	M.I.P. or Solder inlet, angle	098268260441	100	51	\$ 11.00
BD2	0820905	3/4	M.I.P. inlet, angle	098268092806	72	32	10.75
BD2C	0820902	3/4	M.I.P. inlet, angle	098268260458	100	51	12.25
BD3F	0820906	1/2	F.I.P. inlet, angle pattern	098268092813	100	55	9.50
BD4F	0820908	3/4	F.I.P. inlet, angle pattern	098268092820	72	37	10.00
BD5	0820903	1/2	M.I.P. or Solder inlet, straight pattern	098268650464	144	58	9.00
BD6	0820904	3/4	M.I.P. inlet, straight pattern	098268650471	72	37	8.00
LFBD-1C	0123618	1/2	M.I.P. or Solder inlet, angle	098268701272	100	51	14.50
LFBD2	0123622	3/4	M.I.P. inlet, angle	098268701364	72	32	14.25
LFBD-2C	0123619	3/4	M.I.P. inlet, angle	098268701289	100	51	16.00
LFBD3F	0123623	1/2	F.I.P. inlet, angle pattern	098268701418	100	55	12.50
LFBD4F	0123624	3/4	F.I.P. inlet, angle pattern	098268701425	72	37	13.00
LFBD5	0123620	1/2	M.I.P. or Solder inlet, straight pattern	098268701302	144	58	11.75
LFBD6	0123621	3/4	M.I.P. inlet, straight pattern	098268701340	72	37	10.25

LEAD FREE

Quarter-Turn Boiler Drains

BD-QT	0820955	1/2	Dual Pattern, MIP or Solder with 3/4 hose connection	098268919875	120	46	13.50
BD-QT	0820956	3/4	M.I.P. x 3/4 hose connection	098268919882	80	40	16.00
LFBD-QT	0123631	1/2	Dual Pattern, MIP or Solder with 3/4 hose connection	098268701517	120	46	17.50
LFBD-QT	0123632	3/4	M.I.P. x 3/4 hose connection	098268701531	80	40	21.00

LEAD FREE



BD-QT



Spring Fit Access Panels

Series APU

APU9	0958042		8" x 8"	098268965001	5	3	25.00
APU15	0958046		14" x 14"	098268965018	5	8	34.75

Spring Fit Access Panel

*The wetted surface of this product contacted by consumable water contains less than 0.25% of lead by weight.

Consult factory for ordering code numbers of special models/options.

Plumbing Specialties

Model	Ordering Code	Size (in.)	Adapter Fitting/Description	UPC	Qty. Per Carton	Weight Per Carton (lbs.)	List Price (each)
-------	---------------	------------	-----------------------------	-----	-----------------	--------------------------	-------------------



No-Kink Hose Bibb With Tee Handle and Vacuum Breaker

SC8-1	0611150	1/2	Male I.P. or Solder	098268308563	24	19	\$ 59.25
SC8-2	0611250	3/4	Solder	098268308570	24	19	60.00

Lawn Faucet (Sillcock With Cast Iron Handwheel and Vacuum Breaker)

SC8-3	0611350	1/2	Solder	098268308587	24	19	59.75
SC8-4	0611450	3/4	Female I.P.	098268308495	24	24	59.75

Hose Bibb, Hex Shoulder With Tee Handle and Vacuum Breaker

SC8-5	0611550	1/2	Male I.P. or solder inlet	098268308488	24	19	56.00
SC8-6	0611650	3/4	Male I.P. inlet, hose end	098268308471	24	22	59.25

Trap Primer - Ensures Trap Seal

Series TP300 and LFTP300

LFTP300T	0121238	1/2	Threaded Connections	098268580433	24	25	245.50
LFTP300S	0121239	1/2	Union Solder Ends	098268580440	24	23	245.50
TP300-DU	0295137	1/2	Distribution Unit	098268560619	24	20	48.50



Anti-Sweat Valve For Toilet Tanks - Adjustable

Series WAS

WAS	0215476	1/2	IPS and/or compression	098268633337	100	75	115.00
-----	---------	-----	------------------------	--------------	-----	----	--------

Brass Angle Meter Valve With Waste

Series WAMV

LFWAMV-W FLxIPS	0123015	3/4	3/4 FL x 3/4 IPS	098268650525	60	66	70.25
LFWAMV-W FLxIPS	0123016	1	1 FL x 3/4 IPS	098268734911	60	67	124.50

*The wetted surface of this product contacted by consumable water contains less than 0.25% of lead by weight.
Consult factory for ordering code numbers of special models/options.

Model	Ordering Code	Size (in.)	UPC	Qty. Per Carton	Weight Per Carton (lbs.)	List Price (each)
-------	---------------	------------	-----	-----------------	--------------------------	-------------------

Heavy Duty Float Valves and Components

Heavy Duty Float Valves

375	0780001	3/8	098268090840	40	24	\$ 56.50
500	0780003	1/2	098268090864	40	35	49.50
750	0780007	3/4	098268090901	40	46	64.00
1000	0780011	1	098268090949	10	19	111.00
1250	0780012	1 1/4	098268090956	10	35	198.50
1500	0780013	1 1/2	098268090963	10	34	199.00
2000	0780014	2	098268090970	10	39	204.00

Heavy Duty Float Valves Plus Locknut and Gasket

375-12	0780002	3/8	098268090857	40	36	50.00
500-12	0780004	1/2	098268090871	40	40	53.50
750-12	0780008	3/4	098268090918	40	50	68.75

Heavy Duty Float Valves with Threaded Outlet Valve

500TO	0780005	1/2	098268090888	40	36	51.50
750TO	0780009	3/4	098268090925	40	52	69.75

Heavy Duty Float Valves Plus Locknut and Gasket

500TO-12	0780006	1/2	098268090895	40	40	53.50
750TO-12	0780010	3/4	098268090932	40	52	68.00

Heavy Duty Stems

11	0780318	10	098268702965	10	1.4	15.00
11.5	0780319	12	098268702972	10	3.0	18.25
11-12	0780322	12	098268703009	10	2.3	16.75
12	0780320	12	098268702989	10	2.8	18.00
12.5	0780349	12	098268818321	10	12	18.00
13	0780321	12	098268702996	10	13	17.75

Additional Sizes Available. Consult Factory.

Nuzzle Assemblies for Heavy Duty Stems and Floats

N1	0780021	10	098268091045	10	2.4	24.25
N1-7	0780022	10	098268091052	10	7.0	24.25
N5	0780023	12	098268091069	10	3.0	31.25
N5-1	0780024	12	098268091076	10	3.0	31.25
N5-3	0780025	12	098268091083	50	15	31.50
N8	0780026	12	098268091090	10	4.5	34.75
N8-7	0780027	12	098268091106	10	5.0	34.75

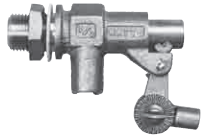
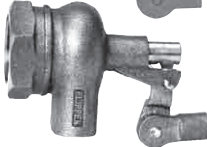

Plumbing Specialties

Model	Ordering Code	Size (in.)	UPC	Qty. Per Carton	Weight Per Carton (lbs.)	List Price (each)
-------	---------------	------------	-----	-----------------	--------------------------	-------------------

Heavy Duty Floats and Adapters

Copper Floats



CX	0780351	4 x 5	098268818291	8	6.4	\$ 62.75
C4	0780352	4	098268818307	4	2.4	48.50
C5	0780329	5	098268703078	12	10	60.50
C6	0780330	6	098268703085	8	8.8	70.25
C6-3	0780032	6	098268091151	24	27	70.25
C6-7	0780331	6	098268703092	8	8.4	70.25
C7	0780332	7	098268703108	12	17	122.00
C8	0780333	8	098268703115	8	19	189.00
C10	0780036	10	098268091199	4	14	366.50
C12	0780037	12	098268091205	4	26	658.00

Plastic Floats



PX	0780325	4 x 5	098268703030	10	2.8	19.00
P6	0780326	6	098268703047	10	6.5	22.00
P6-7	0780327	6	098268703054	10	6.9	22.00
P8	0780328	8	098268703061	10	10	26.75
P8-1	0780357	8	098268818314	10	11	26.75
P8-7	0780356	8	098268818338	10	10	26.75
P12***	0780221	2 x 6	098268474527	1	1.9	55.25
P16**	0780044	2 x 8	098268091274	1	3.3	72.00

**Assembly of two P8's

***Assembly of two P6's

Thread Adapters for Floats

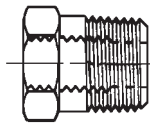

AD1 through AD4

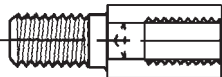

AD10 through AD15

		Male Thread	Female Thread				
AD1	0780045	3/8 NPT	5/16-18	098268091281	100	5.0	\$ 44.00
AD2	0780046	3/8 NPT	3/8-16	098268091298	100	7.3	44.00
AD3	0780047	1/2 NPT	3/8-16	098268091304	100	15	44.00
AD4	0780048	3/4 NPT	3/8-16	098268091311	100	40	44.00
AD10	0780049	1/4-20	5/16-18	098268091328	100	40	29.75
AD11	0780050	1/4-20	3/8-16	098268091335	100	6.2	29.75
AD12	0780051	5/16-18	1/4-20	098268091342	100	85	29.75
AD13	0780052	3/8	5/16-18	098268091359	100	45	32.75
AD14	0780053	3/8-16	1/4-20	098268091366	100	20	32.75
AD15	0780054	5/16-18	3/8-16	098268091373	100	7.0	38.25

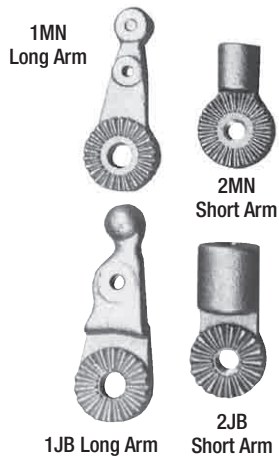

Model	Ordering Code	Size (in.)	UPC	Qty. Per Carton	Weight Per Carton (lbs.)	List Price (each)
-------	---------------	------------	-----	-----------------	--------------------------	-------------------

Float Valves and Components Replacement Parts

Heavy Duty Valve Arms

1MN	0780337		098268703153	100	10	\$ 9.75
2MN-1	0780334	For	098268703122	100	10	11.50
2MN-7	0780064	valve sizes	098268091472	100	7.0	31.25
2MN 3	0780065	3/8, 1/2	098268091489	50	3.3	31.25
2MN-9	0780066	and 3/4.	098268091496	50	3.4	20.75
1JB	0780338		098268703160	100	15	24.25
2JB-1	0780072	For	098268091557	50	7.8	29.25
2JB-7	0780335	valve sizes	098268703139	100	10	24.75
2JB-3	0780336	1 and	098268703146	100	15	24.75
2JB-9	0780070	larger.	098268091533	50	7.7	28.25
2JB-4	0780071		098268091540	50	6.8	36.00

Valve Arm Sets

A1214	0780073	For 3/8, 1/2, 3/4	098268091564	100	6.0	28.75
A1210	0780074	1 & larger	098268091571	100	50	55.25

Plunger Assembly

375A785	0780075	3/8	098268091588	100	9.3	21.00
500A785	0780076	1/2	098268091595	100	17	26.25
750A785	0780077	3/4	098268091601	100	26	30.25
1000A785	0780078	1	098268091618	50	15	54.50
JA785	0780079	1 1/4-2	098268091625	50	24	83.00

Lock Nuts

375-6	0780080	3/8	098268091632	50	0.5	3.50
750-6	0780082	3/4	098268091656	50	4.0	5.75

Plunger End Discs

375-5	0780341	3/8	098268703191	100	1.0	5.75
500-5	0780342	1/2	098268703207	100	0.3	4.50
750-5	0780343	3/4	098268703214	100	1.0	4.50
1000-5	0780344	1	098268703221	100	1.0	5.75
J-5	0780345	1 1/4-2	098268703238	100	1.0	7.75

Leather Rings

375-8	0780346	3/8	098268703245	100	0.2	9.25
500-8	0780347	1/2, 1-2	098268703252	100	0.3	4.75
750-8	0780348	3/4	098268703269	100	0.3	4.75

Machine Screws

10	0780339	For 1 - 2	098268703177	100	3.0	5.75
----	---------	-----------	--------------	-----	-----	------

Thumb Screws

15	0780340	For 3/8 - 3/4	098268703184	25	0.4	6.00
----	---------	---------------	--------------	----	-----	------

Stainless Steel Nut and Bolt Assembly

3B	0780095	For 3/8, 1/2, 3/4	098268091786	50	0.3	4.50
4B	0780096	For 1 - 2	098268091793	100	2.0	5.75

Plumbing Specialties

Model	Ordering Code	Size (in.)	UPC	Qty. Per Carton	Weight Per Carton (lbs.)	List Price (each)
-------	---------------	------------	-----	-----------------	--------------------------	-------------------



3/8" - 1" Threaded Outlet



1 1/4" - 2" Threaded Outlet

Standard Duty Float Valves and Components

Standard Duty Float Valves

ST375	0770179	3/8	0098268194487	100	57	\$ 40.75
ST500	0770180	1/2	0098268194494	100	50	44.00
ST750	0770181	3/4	0098268194500	80	36	54.50
ST1000	0770182	1	0098268225938	40	24	86.25
ST1250	0780282	1 1/4	0098268475135	20	56	154.50
ST1500	0780283	1 1/2	0098268475142	20	29	168.00
ST2000	0780284	2	0098268475159	10	28	176.50

Standard Duty Float Valves Replacement Parts

Valve Arms

ST2-LA Long	0770183	3/8-1	098268225945	20	1.4	13.75
ST2-1 Short	0770184	3/8-1	098268225952	25	1.8	11.25
ST2-LA Long	0780155	1 1/4-2	098268844832	100	18	16.75
ST2-1 Short	0780156	1 1/4-2	098268844849	50	7.7	14.25

Plunger Assembly

ST375-PA	0770185	3/8	098268225969	100	12	18.25
ST500-PA	0770186	1/2	098268225976	100	18	19.25
ST750-PA	0770187	3/4	098268225983	100	0.5	24.75
ST1000-PA	0770188	1	098268225990	100	4.0	49.50
ST1250-PA	0780368	1 1/4	098268828450	100	30	62.50
ST1500-PA	0780368	1 1/2	098268828450	100	30	62.50
ST2000-PA	0780368	2	098268828450	100	30	62.50

Plunger End Discs

ST 375 Disc	0770255	3/8	098268252330	100	0.2	4.50
ST 500 Disc	0770256	1/2	098268252347	100	0.03	4.50
ST 750 Disc	0770257	3/4	098268252354	100	0.04	4.50
ST 1000 Disc	0770258	1	098268252361	100	0.4	7.00

Fasteners (Brass)

15 Thumb Screw	0780340	3/8 - 1	098268703184	25	0.4	6.00
3 Cotter Pin	2322000	1/8 - 1	098268477245	50	0.3	3.75
10 Machine Screw	0780339	1 1/4 - 2	098268703177	100	0.3	5.75
4 Cotter Pin	2322001	1 1/4 - 2	098268477252	100	0.9	2.00



Long Arm Short Arm



Long Arm Short Arm



Plumbing Specialties

Model	Ordering Code	Size (in.)	UPC	Qty. Per Carton	Weight Per Carton (lbs.)	List Price (each)
-------	---------------	------------	-----	-----------------	--------------------------	-------------------



Automatic Livestock Watering Kits

Automatic Livestock Watering Kits

RL600	0780105	1.1	0098268240450	1	1.4	\$ 98.25
RL600A	0780173	0.1	0098268474046	1	0.9	25.00
RL600V	0780174	0.2	0098268474053	24	6.4	37.50
RL600-SC	0780365	0.2	0098268824933	50	7.0	25.50
UA600	0780245	1.4	0098268474763	10	20	61.50
AP112	0780242	0.1	0098268474732	1	0.4	6.50



Evaporative Cooler Valve Kits

Bronze body, machined in-seat, Buna-N seals, adjustable brass arms, polyethylene float. - 3 GPM @ 100psi Capacity.

3/8" MIP OD x 1/8" FIP ID pipe connection

STD-CA3/8x1/8	0770178	8 x 3/4	098268194470	25	9.5	\$ 21.75
---------------	---------	---------	--------------	----	-----	----------

3/8" Copper Tube Connection

C3/8TF	0780274	12 x 3/4	098268475050	25	7.4	21.50
--------	---------	----------	--------------	----	-----	-------

1/4" Copper Tube Connection

C1/4TF	0780269	12 x 3/4	098268475005	25	10	19.00
--------	---------	----------	--------------	----	----	-------

1/4" Copper Tube Connection

C1/4TFAEA	0780270	11 x 3/4	098268475012	100	33	19.00
-----------	---------	----------	--------------	-----	----	-------



Tube Fitting Mini-Cooler Valves

M1/4TF	0770175	1/4" copper	098268194449	100	2.9	13.75
M1/4TFSS	0770176	1/4" copper	098268194456	100	30	13.75

Dielectric Unions

Model	Ordering Code	Size (in.)	UPC	Qty. Per Carton	Weight Per Carton (lbs.)	List Price (each)
-------	---------------	------------	-----	-----------------	--------------------------	-------------------

Series LF3001A

Female Iron Pipe Thread to Copper Solder Joint



LEAD FREE*	LF3001A	0009864	1/2	098268430196	24	8.6	\$ 14.50
	LF3001A	0009865	3/4	098268430202	24	10	14.50
	LF3001A	0009866	1	098268430219	12	7.1	31.75
	LF3001A	0009867	1 1/4	098268430226	12	11	52.00
	LF3001A	0009868	1 1/2	098268430233	12	16	76.00
	LF3001A	0009869	2	098268430240	6	16	107.00

Series LF3002

Female Iron Pipe Thread to Reduced Copper Solder Joint



LEAD FREE*	LF3002	0121292	1/2 x 3/8	098268582444	25	8.7	20.00
	LF3002	0009872	3/4 x 1/2	098268430271	24	11	21.50
	LF3002	0009873	1 x 3/4	098268430288	12	7.6	31.50

Series LF3003

Female Iron Pipe Thread to Female Brass Pipe Thread



LEAD FREE*	LF3003	0009874	1/2	098268430295	24	12	30.25
	LF3003	0009875	3/4	098268430301	12	8.5	37.00
	LF3003	0009876	1	098268430318	12	12	56.75
	LF3003	0009877	1 1/4	098268430325	12	18	85.00
	LF3003	0009878	1 1/2	098268430332	6	18	116.50
	LF3003	0009879	2	098268430349	6	26	155.00

Series LF3004

Female Iron Pipe Thread to Female Iron Pipe Thread - Galvanized

LEAD FREE*	LF3004	0821930	1/2	098268461480	24	12	22.25
	LF3004	0821931	3/4	098268461497	12	8	25.25
	LF3004	0821932	1	098268461503	12	12	33.25
	LF3004	0821933	1 1/4	098268461510	12	18	44.75
	LF3004	0821934	1 1/2	098268461527	6	17	68.25
	LF3004	0821935	2	098268461534	6	25	100.50

Series LF3005

Male Iron Pipe Thread to Copper Solder Joint



LEAD FREE*	LF3005A	0009870	1/2	098268430257	12	5.6	20.50
	LF3005A	0009871	3/4	098268430264	24	13	24.50

Series LF3006

Female Iron Pipe Thread to Female Iron Pipe Thread - Black - Gas Service



LEAD FREE*	LF3006	0821786	1/2	098268786231	24	11	22.25
	LF3006	0821787	3/4	098268786255	12	8	25.25
	LF3006	0821788	1	098268786262	12	8	33.25
	LF3006	0821789	1 1/4	098268786279	12	17	44.75
	LF3006	0821790	1 1/2	098268786286	6	16	68.25
	LF3006	0821791	2	098268786293	6	16	100.50

Series LF3007

Male Iron Pipe Thread to Reduced Solder Connection

LEAD FREE*	LF3007	0821937	3/4 x 1/2	098268461558	24	14	31.50
------------	--------	---------	-----------	--------------	----	----	-------

Series LF3008

Female Brass Pipe Thread to Female Solder Connection

LEAD FREE*	LF3008	0009880	1/2	098268430356	25	9.6	30.50
	LF3008	0009881	3/4	098268430363	24	11	31.75
	LF3008	0009882	1	098268430370	12	7.8	54.75

*The wetted surface of this product contacted by consumable water contains less than 0.25% of lead by weight.

Consult factory for ordering code numbers of special models/options.

Model	Ordering Code	Size (in.)	UPC	Qty. Per Carton	Weight Per Carton (lbs.)	List Price (each)
-------	---------------	------------	-----	-----------------	--------------------------	-------------------

Series LF4001E

Iron Pipe Thread to Copper Solder Joint

LEAD FREE*	Model	Ordering Code	Size (in.)	UPC	Qty. Per Carton	Weight Per Carton (lbs.)	List Price (each)
	LF4001E	0821460	1/2	098268570915	24	4.9	\$ 15.75
	LF4001E	0821461	3/4	098268570922	24	10	15.75
	LF4001E	0821462	1	098268570939	12	7.1	35.00
	LF4001E	0821463	1 1/4	098268570977	12	10	57.25
	LF4001E	0821464	1 1/2	098268570984	12	16	83.50
	LF4001E	0821465	2	098268570991	6	15	117.00

Flanged Fittings

Series LF3100

Iron Pipe Thread to Copper Solder Joint

LEAD FREE*	Model	Ordering Code	Size (in.)	UPC	Qty. Per Carton	Weight Per Carton (lbs.)	List Price (each)
	LF3100M3	0821747	2 1/2	098268430394	1	13	246.50
	LF3100M3	0821748	3	098268430400	1	16	339.50
	LF3100M3	0821749	4	098268430417	1	33	898.50



LF3100/3200

Series 3200

Iron Pipe Thread to Iron Pipe Thread

LEAD FREE*	Model	Ordering Code	Size (in.)	UPC	Qty. Per Carton	Weight Per Carton (lbs.)	List Price (each)
	3200	0822400	2	098268094305	1	8.5	197.00
	3200	0822420	2 1/2	098268094312	1	15	249.00
	3200	0822440	3	098268094329	1	18	308.00
	3200	0822460	4	098268094336	1	32	463.50

Series LF3110

Bronze Solder Copper - Class 125 - Flange, Insulators, gasket, Bolts & Nuts

LEAD FREE*	Model	Ordering Code	Size (in.)	UPC	Qty. Per Carton	Weight Per Carton (lbs.)	List Price (each)
	LF3110	0009887	2 1/2	098268430424	1	7.7	432.50
	LF3110	0009888	3	098268430431	1	9.3	495.00
	LF3110	0121304	4	098268582604	1	15	704.00



LF3110

Series LF3110-LF

Flange Only

LEAD FREE*	Model	Ordering Code	Size (in.)	UPC	Qty. Per Carton	Weight Per Carton (lbs.)	List Price (each)
	LF3110-LF	0121303	2 1/2	098268582598	1	6.2	284.00
	LF3110-LF	0009889	3	098268430448	1	8.3	407.50
	LF3110-LF	0121305	4	098268582611	1	13	584.50

Series INS-KIT

Bolt Insulators - For Insulating Flange Bolts

Model	Ordering Code	Size (in.)	UPC	Qty. Per Carton	Weight Per Carton (lbs.)	List Price (each)
INS-KIT	0889142	1/2	098268267792	100	1.1	5.00
INS-KIT	0889144	5/8	098268267785	100	1.6	5.75
INS-KIT	0889146	3/4	098268267778	100	2	6.50
INS-KIT	0889148	7/8	098268267761	100	2	6.50

*The wetted surface of this product contacted by consumable water contains less than 0.25% of lead by weight.

Consult factory for ordering code numbers of special models/options.



HOW TO ORDER FloodSafe® FLEXIBLE CONNECTORS

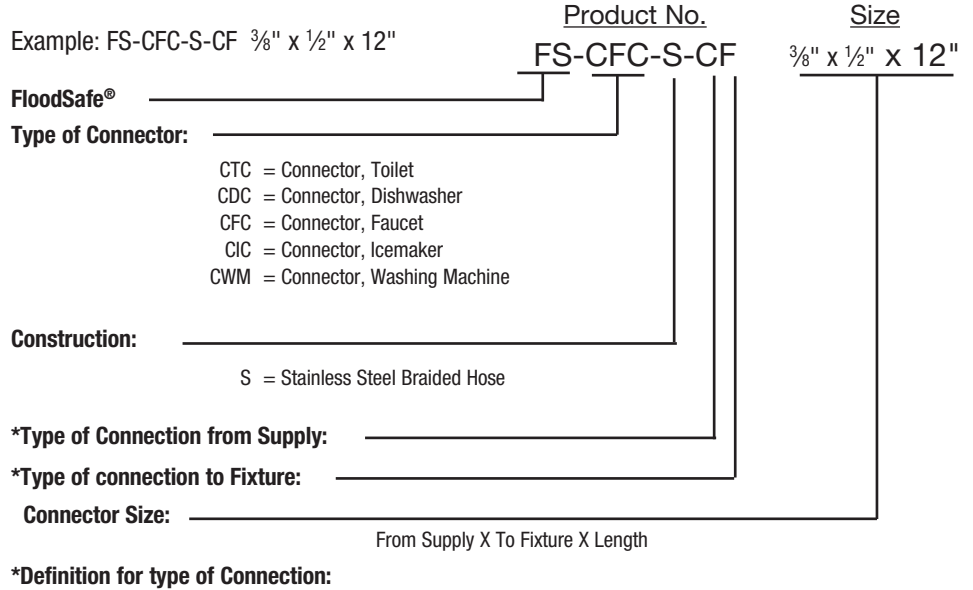

Connection Type

- B = Ballcock End Fitting
- C = Compression End Fitting
- F = FIP End Fitting

Connection Type

- H = Female Hose End Fitting
- M = MIP End Fitting
- O = OD Compression End Fitting
- T = Fine Thread FIP End Fitting

*The wetted surface of this product contacted by consumable water contains less than 0.25% of lead by weight.
 Consult factory for ordering code numbers of special models/options.

FloodSafe Connectors

Model	Ordering Code	Size (in.)	UPC	Qty. Per Carton	Weight Per Carton (lbs.)	List Price (each)
-------	---------------	------------	-----	-----------------	--------------------------	-------------------

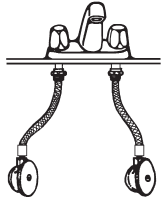

Braided Stainless Steel Faucet Connectors



Max. Temperature 180°F / Max. Pressure 125psi

LEAD FREE	Model	Ordering Code	Size (in.)	UPC	Qty. Per Carton	Weight Per Carton (lbs.)	List Price (each)
LEAD FREE	LFFSCFC-S-CC	0392408	3/8 x 3/8 x 12	098268485905	100	58	\$ 20.50
LEAD FREE	LFFSCFC-S-CC	0392409	3/8 x 3/8 x 16	098268485912	100	33	22.50
LEAD FREE	LFFSCFC-S-CC	0392410	3/8 x 3/8 x 20	098268485929	100	38	23.75
LEAD FREE	LFFSCFC-S-CF	0392233	1/2 x 1/2 x 12	098268297126	100	30	19.50
LEAD FREE	LFFSCFC-S-CF	0392400	3/8 x 1/2 x 12	098268485820	100	33	20.50
LEAD FREE	LFFSCFC-S-CF	0392401	3/8 x 1/2 x 16	098268485837	100	34	22.50
LEAD FREE	LFFSCFC-S-CF	0392402	3/8 x 1/2 x 20	098268485844	100	79	23.75
LEAD FREE	LFFS-CFC-S-CF	0392236	7/16 x 1/2 x 12	098268297157	100	32	8.75
LEAD FREE	LFFS-CFC-S-CF	0392237	7/16 x 1/2 x 16	098268296990	100	36	19.25
LEAD FREE	LFFS-CFC-S-CF	0392238	7/16 x 1/2 x 20	098268297003	100	79	20.50
LEAD FREE	LFFSCFC-S-FF	0392415	1/2 x 1/2 x 12	098268486032	100	37	18.50
LEAD FREE	LFFSCFC-S-FF	0392403	1/2 x 1/2 x 16	098268485851	100	41	23.50
LEAD FREE	LFFSCFC-S-FF	0392404	1/2 x 1/2 x 20	098268485868	100	90	25.25
LEAD FREE	LFFSCFC-S-TF	0392419	3/8 x 1/2 x 12	098268486087	100	32	14.75
LEAD FREE	LFFSCFC-S-TF	0392420	3/8 x 1/2 x 16	098268486094	100	72	15.25
LEAD FREE	LFFSCFC-S-TF	0392421	3/8 x 1/2 x 20	098268486124	100	42	16.00
LEAD FREE	LFFSCFC-S-TF	0392416	1/2 x 1/2 x 12	098268486049	100	65	15.50
LEAD FREE	LFFSCFC-S-TF	0392417	1/2 x 1/2 x 16	098268486056	100	72	20.25
LEAD FREE	LFFSCFC-S-TF	0392418	1/2 x 1/2 x 20	098268486063	100	81	21.25



“Delta Style” Braided Stainless Faucet Connectors



Max. Temperature 180°F / Max. Pressure 125psi

LEAD FREE	Model	Ordering Code	Size (in.)	UPC	Qty. Per Carton	Weight Per Carton (lbs.)	List Price (each)
LEAD FREE	LFFS-CFC-S-CO	0392205	3/8 x 3/8 x 12	098268244212	25	6.75	\$ 23.50
LEAD FREE	LFFS-CFC-S-CO	0392246	3/8 x 3/8 x 20	098268297096	25	8.50	24.50



*The wetted surface of this product contacted by consumable water contains less than 0.25% of lead by weight.

Consult factory for ordering code numbers of special models/options.

FloodSafe Connectors

Model	Ordering Code	Size (in.)	UPC	Qty. Per Carton	Weight Per Carton (lbs.)	List Price (each)
-------	---------------	------------	-----	-----------------	--------------------------	-------------------

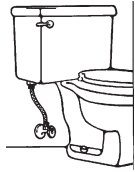

Braided Stainless Steel Toilet Connectors



Max. Temperature 180°F / Max. Pressure 125psi

FS-CTC-S-CB	0392247	3/8 x 7/8 x 6	098268296860	100	64	\$ 14.25
FS-CTC-S-CB	0392248	3/8 x 7/8 x 9	098268296877	100	51	14.50
FS-CTC-S-CB	0392206	3/8 x 7/8 x 12	098268244229	100	30	16.25
FS-CTC-S-CB	0392249	7/16 x 7/8 x 6	098268296884	100	45	13.00
FS-CTC-S-CB	0392250	7/16 x 7/8 x 9	098268296891	100	27	14.25
FS-CTC-S-CB	0392251	7/16 x 7/8 x 12	098268296907	100	56	17.50
FS-CTC-S-CB	0392253	1/2 x 7/8 x 9	098268296921	100	54	14.00
FS-CTC-S-FB	0392254	1/2 x 7/8 x 6	098268296938	100	55	14.50
FS-CTC-S-FB	0392255	1/2 x 7/8 x 9	098268296983	100	33	10.00
FS-CTC-S-FB	0392207	1/2 x 7/8 x 12	098268244236	100	69	16.00
FS-CTC-S-TB	0392256	3/8 x 7/8 x 6	098268296754	100	47	13.50
FS-CTC-S-TB	0392258	3/8 x 7/8 x 12	098268296778	100	32	18.00
FS-CTC-S-TB	0392261	1/2 x 7/8 x 12	098268296808	100	60	17.25

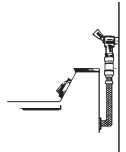

Braided Stainless Washing Machine Connectors



Max. Temperature 180°F / Max. Pressure 125psi

FS-CWM-S-HH	0392262	3/4 x 3/4 x 48	098268296815	40	37	34.50
FS-CWM-S-HH	0392208	3/4 x 3/4 x 60	098268244243	40	43	37.75
FS-CWM-S-HH	0392209	3/4 x 3/4 x 72	098268244250	40	48	42.50

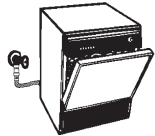

Braided Stainless Dishwasher Connectors



Max. Temperature 180°F / Max. Pressure 125psi

FS-CDC-S-CE	0392212	3/8 x 3/8 x 48	098268244298	40	31	31.25
FS-CDC-S-CE	0392263	3/8 x 3/8 x 60	098268296822	40	36	42.75
FS-CDC-S-CE	0392264	3/8 x 3/8 x 72	098268296839	40	38	38.75
FS-CDC-S-FE	0392265	1/2 x 3/8 x 48	098268296853	40	33	31.00
FS-CDC-S-FE	0392266	1/2 x 3/8 x 60	098268296723	40	37	31.00
FS-CDC-S-FE	0392267	1/2 x 3/8 x 72	098268296730	40	41	38.75



Braided Stainless Ice Maker Connectors



Max. Temperature 140°F / Max. Pressure 125psi

LFFS-CIC-S	0392210	1/4 x 1/4 x 6'	098268244267	40	53	12.25
LFFS-CIC-S	0392211	1/4 x 1/4 x 10'	098268244274	40	53	13.50
LFFS-CIC-S	0392268	1/4 x 1/4 x 20'	098268296747	40	97	19.50



LEAD FREE

LEAD FREE

*The wetted surface of this product contacted by consumable water contains less than 0.25% of lead by weight. Consult factory for ordering code numbers of special models/options.

Flexible Connectors

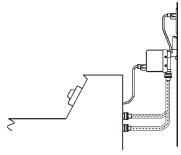

HOW TO ORDER FLEXIBLE CONNECTORS

Example: CWH-S-AM 7/8" x 3/4" x 18"

Product No.	CWH-S-AM
Size	7/8" x 3/4" x 18"
Type of Connector:	_____
CWM = Connector, Washing Machine	
CWH = Connector, Water Heater	
CTC = Connector, Toilet	
CDC = Connector, Dishwasher	
CFC = Connector, Faucet	
CIC = Connector, Icemaker	
Construction:	_____
S = Stainless Steel Braided Hose	
P = Reinforced PVC	
Type of Connection from Supply:	_____
Type of connection to Fixture:	_____
Connector Size:	_____
From Supply X To Fixture X Length	

*Definition for type of Connection:

Connection Type

- A = AI End Fitting
- B = Ballcock End Fitting
- C = Compression End Fitting
- E = MIP Elbow End Fitting
- F = FIP End Fitting

Connection Type

- H = Female Hose End Fitting
- L = Female Hose ELL End Fitting
- M = MIP End Fitting
- O = OD Compression End Fitting
- T = Fine Thread FIP End Fitting

Model	Ordering Code	Size (in.)	UPC	Qty. Per Carton	Weight Per Carton (lbs.)	List Price (each)
-------	---------------	------------	-----	-----------------	--------------------------	-------------------



CWM-S-HH
Washing Machine Connector



CWM-S-HL
Washing Machine Connector

Stainless Steel Washing Machine Connectors



Max. Intermittent Temperature 180°F / Max. Pressure 125psi

CWM-S-HH	0298000	3/4 x 3/4 x 48	098268625172	40	33	\$ 23.75
CWM-S-HH	0298001	3/4 x 3/4 x 60	098268625189	40	39	24.25
CWM-S-HH	0298002	3/4 x 3/4 x 72	098268625196	40	43	26.00
CWM-S-HL	0298003	3/4 x 3/4 x 48	098268625202	40	28	26.00
CWM-S-HL	0298004	3/4 x 3/4 x 60	098268625219	40	42	31.75
CWM-S-HL	0298005	3/4 x 3/4 x 72	098268625226	40	47	34.25

*The wetted surface of this product contacted by consumable water contains less than 0.25% of lead by weight.

Consult factory for ordering code numbers of special models/options.

Flexible Connectors

Model	Ordering Code	Size (in.)	UPC	Qty. Per Carton	Weight Per Carton (lbs.)	List Price (each)
-------	---------------	------------	-----	-----------------	--------------------------	-------------------

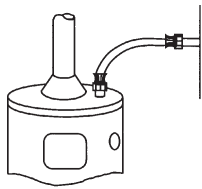

LFCWH-S-FF-L
Water Heater Connector
Large Diameter

Large Diameter Stainless Steel Water Heater Connectors

Max. Intermittent Temperature 180°F / Max. Pressure 125psi



LEAD FREE*	LFCWH-S-FF-L	0298441	3/4 x 3/4 x 12	098268485615	40	26	\$ 30.75	
	LFCWH-S-FF-L	0298442	3/4 x 3/4 x 15	098268485622	40	28	33.50	
	LFCWH-S-FF-L	0298443	3/4 x 3/4 x 18	098268485639	40	32	35.50	
	LFCWH-S-FF-L	0298444	3/4 x 3/4 x 24	098268485646	40	38	37.75	
	LFCWH-S-FF-L	0298274	3/4 x 3/4 x 36	098268733051	40	50	50.75	
	LFCWH-S-FF-L	0298275	3/4 x 3/4 x 48	098268733068	40	63	69.75	
LEAD FREE*	LFCWH-S-FF-L	0298276	3/4 x 3/4 x 60	098268733075	40	71	80.00	
	LEAD FREE*	LFCWH-S-AF-L	0298450	5/8 x 3/4 x 15	098268485707	40	31	34.75
		LFCWH-S-AF-L	0298451	5/8 x 3/4 x 18	098268485714	40	36	42.25
LFCWH-S-AF-L		0298452	5/8 x 3/4 x 24	098268485721	40	48	50.25	
LEAD FREE*	LEAD FREE*	LFCWH-S-AF-L	0298445	7/8 x 3/4 x 12	098268485653	40	29	41.50
		LFCWH-S-AF-L	0298446	7/8 x 3/4 x 15	098268485660	40	34	44.50
		LFCWH-S-AF-L	0298447	7/8 x 3/4 x 18	098268485677	40	37	48.50
LEAD FREE*	LEAD FREE*	LFCWH-S-FM-L	0298281	7/8 x 3/4 x 48	098268733129	40	61	56.75
		LFCWH-S-FM-L	0298453	3/4 x 3/4 x 12	098268485738	40	25	36.00
		LFCWH-S-FM-L	0298454	3/4 x 3/4 x 15	098268485745	40	28	30.75
LEAD FREE*	LEAD FREE*	LFCWH-S-FM-L	0298455	3/4 x 3/4 x 18	098268485752	40	30	41.25
		LFCWH-S-AM-L	0298456	3/4 x 3/4 x 24	098268485769	40	40	46.50
		LFCWH-S-AM-L	0298457	7/8 x 3/4 x 12	098268485776	40	31	41.25
		LFCWH-S-AM-L	0298458	7/8 x 3/4 x 15	098268485783	40	34	44.25
		LFCWH-S-AM-L	0298459	7/8 x 3/4 x 18	098268485790	40	36	48.25
LEAD FREE*	LFCWH-S-AM-L	0298460	7/8 x 3/4 x 24	098268485806	40	48	52.75	

*The wetted surface of this product contacted by consumable water contains less than 0.25% of lead by weight.
Consult factory for ordering code numbers of special models/options.

Flexible Connectors

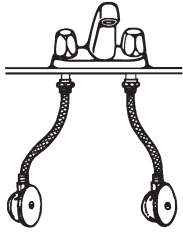

LFCFC-S-CC
Faucet Connector



LFCFC-S-CF
Faucet Connector



LFCFC-S-FF
Faucet Connector

Model	Ordering Code	Size (in.)	UPC	Qty. Per Carton	Weight Per Carton (lbs.)	List Price (each)
-------	---------------	------------	-----	-----------------	--------------------------	-------------------

Stainless Steel Faucet Connectors



Max. Temperature 180°F / Max. Pressure 125psi

Model	Ordering Code	Size (in.)	UPC	Qty. Per Carton	Weight Per Carton (lbs.)	List Price (each)
LFCFC-S-CC	0298400	3/8 x 3/8 x 12	098268485202	100	20	\$ 6.00
LFCFC-S-CC	0298401	3/8 x 3/8 x 16	098268485219	100	25	7.25
LFCFC-S-CC	0298402	3/8 x 3/8 x 20	098268485226	100	31	7.50
LFCFC-S-CC	0298403	3/8 x 3/8 x 24	098268485233	100	31	7.75
LFCFC-S-CC	0298113	3/8 x 3/8 x 30	098268628210	40	16	7.75
LFCFC-S-CC	0298114	3/8 x 3/8 x 36	098268628227	40	19	15.75
LFCFC-S-CC	0298115	3/8 x 3/8 x 48	098268628234	40	24	19.00
LFCFC-S-CC	0298116	3/8 x 3/8 x 60	098268628241	40	28	22.50
LFCFC-S-CC	0298117	3/8 x 3/8 x 72	098268628258	40	34	25.50
LFCFC-S-CF	0298404	1/2 x 1/2 x 12	098268485240	100	24	6.00
LFCFC-S-CF	0298405	1/2 x 1/2 x 16	098268485257	100	27	7.25
LFCFC-S-CF	0298406	1/2 x 1/2 x 20	098268485264	100	31	8.50
LFCFC-S-CF	0298407	1/2 x 1/2 x 24	098268485271	100	35	9.50
LFCFC-S-CF	0298122	1/2 x 1/2 x 30	098268628302	40	17	10.50
LFCFC-S-CF	0298123	1/2 x 1/2 x 36	098268628319	40	16	12.50
LFCFC-S-CF	0298124	1/2 x 1/2 x 48	098268628326	40	48	17.25
LFCFC-S-CF	0298125	1/2 x 1/2 x 60	098268628333	40	30	22.00
LFCFC-S-CF	0298126	1/2 x 1/2 x 72	098268628340	40	72	15.25
LFCFC-S-CF	0298408	3/8 x 1/2 x 12	098268485288	100	22	7.50
LFCFC-S-CF	0298409	3/8 x 1/2 x 16	098268485295	100	26	8.00
LFCFC-S-CF	0298410	3/8 x 1/2 x 20	098268485301	100	31	8.50
LFCFC-S-CF	0298411	3/8 x 1/2 x 24	098268485318	100	39	8.75
LFCFC-S-CF	0298131	3/8 x 1/2 x 30	098268628395	40	18	9.25
LFCFC-S-CF	0298132	3/8 x 1/2 x 36	098268628401	40	19	10.00
LFCFC-S-CF	0298133	3/8 x 1/2 x 48	098268628418	40	25	14.00
LFCFC-S-CF	0298134	3/8 x 1/2 x 60	098268628425	40	28	22.50
LFCFC-S-CF	0298135	3/8 x 1/2 x 72	098268628432	40	37	15.50
LFCFC-S-CF	0298416	7/16 x 1/2 x 12	098268485363	100	24	6.25
LFCFC-S-CF	0298417	7/16 x 1/2 x 16	098268485370	100	28	7.50
LFCFC-S-CF	0298418	7/16 x 1/2 x 20	098268485387	100	33	9.00
LFCFC-S-CF	0298419	7/16 x 1/2 x 24	098268485394	100	20	9.75
LFCFC-S-CF	0298149	7/16 x 1/2 x 30	098268628579	40	32	10.50
LFCFC-S-CF	0298150	7/16 x 1/2 x 36	098268628586	10	9.0	14.00

Max. Temperature 180°F / Max. Pressure 125psi



Model	Ordering Code	Size (in.)	UPC	Qty. Per Carton	Weight Per Carton (lbs.)	List Price (each)
LFCFC-S-FF	0298420	1/2 x 1/2 x 12	098268485400	100	25	\$ 6.25
LFCFC-S-FF	0298421	1/2 x 1/2 x 16	098268485417	100	31	7.50
LFCFC-S-FF	0298422	1/2 x 1/2 x 20	098268485424	100	33	8.75
LFCFC-S-FF	0298423	1/2 x 1/2 x 24	098268485431	100	38	10.00
LFCFC-S-FF	0298155	1/2 x 1/2 x 30	098268628630	40	18	10.50
LFCFC-S-FF	0298156	1/2 x 1/2 x 36	098268628647	40	21	11.00
LFCFC-S-FF	0298157	1/2 x 1/2 x 48	098268628654	40	25	15.75
LFCFC-S-FF	0298158	1/2 x 1/2 x 60	098268628661	40	30	20.00
LFCFC-S-FF	0298159	1/2 x 1/2 x 72	098268628678	40	30	21.75
LFCFC-S-TF	0298412	3/8 x 1/2 x 12	098268485325	100	24	8.00
LFCFC-S-TF	0298413	3/8 x 1/2 x 16	098268485332	100	20	8.25
LFCFC-S-TF	0298414	3/8 x 1/2 x 20	098268485349	100	29	8.75
LFCFC-S-TF	0298415	3/8 x 1/2 x 24	098268485356	100	37	8.75

*The wetted surface of this product contacted by consumable water contains less than 0.25% of lead by weight.

Consult factory for ordering code numbers of special models/options.

Flexible Connectors

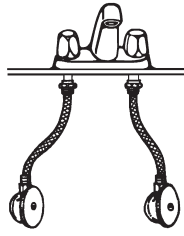

LFCFC-P-CF
Faucet Connector



LFCFC-P-FF
Faucet Connector

Model	Ordering Code	Size (in.)	UPC	Qty. Per Carton	Weight Per Carton (lbs.)	List Price (each)
-------	---------------	------------	-----	-----------------	--------------------------	-------------------

Faucet Connectors - "Delta® Style"



Max. Temperature 180°F / Max Pressure 125psi

LEAD FREE	LFCFC-S-CO	0298440	3/8 x 3/8 x 12	098268485608	100	24	\$ 4.25
	LFCFC-S-CO	0298439	3/8 x 3/8 x 20	098268485592	100	30	5.00

Reinforced PVC Faucet Connectors



Max. Temperature 140°F / Max. Pressure 125psi (†See note below)

LEAD FREE	LFCFC-P-CC	0298424	3/8 x 3/8 x 12	098268485448	100	22	\$ 3.00	
	LFCFC-P-CC	0298425	3/8 x 3/8 x 16	098268485455	100	22	3.50	
	LFCFC-P-CC	0298426	3/8 x 3/8 x 20	098268485462	100	23	4.00	
	LFCFC-P-CC	0298427	3/8 x 3/8 x 24	098268485479	100	37	4.25	
	LFCFC-P-CC	0298175	3/8 x 3/8 x 30	098268626919	40	32	4.50	
	LFCFC-P-CC	0298176	3/8 x 3/8 x 36	098268626926	40	36	5.00	
	LFCFC-P-CC	0298177	3/8 x 3/8 x 48	098268626933	40	16	5.25	
	LFCFC-P-CC	0298178	3/8 x 3/8 x 60	098268626940	40	23	5.50	
	LFCFC-P-CC	0298179	3/8 x 3/8 x 72	098268626957	40	25	5.50	
LEAD FREE	LFCFC-P-CF	0298428	1/2 x 1/2 x 12	098268485486	100	22	6.00	
	LFCFC-P-CF	0298429	1/2 x 1/2 x 16	098268485493	100	20	6.25	
	LFCFC-P-CF	0298430	1/2 x 1/2 x 20	098268485509	100	33	6.25	
	LFCFC-P-CF	0298184	1/2 x 1/2 x 30	098268627008	10	4.1	7.25	
	LFCFC-P-CF	0298185	1/2 x 1/2 x 36	098268627015	10	4.0	4.00	
	LFCFC-P-CF	0298186	1/2 x 1/2 x 48	098268627022	40	48	5.00	
	LFCFC-P-CF	0298187	1/2 x 1/2 x 60	098268627039	40	60	5.50	
	LFCFC-P-CF	0298188	1/2 x 1/2 x 72	098268627046	10	18	6.00	
	LEAD FREE	LFCFC-P-CF	0298431	3/8 x 1/2 x 12	098268485516	100	21	5.50
LFCFC-P-CF		0298432	3/8 x 1/2 x 16	098268485523	100	24	5.50	
LFCFC-P-CF		0298433	3/8 x 1/2 x 20	098268485530	100	27	6.25	
LFCFC-P-CF		0298434	3/8 x 1/2 x 24	098268485547	100	29	7.00	
LFCFC-P-CF		0298202	3/8 x 1/2 x 30	098268627183	40	16	7.50	
LFCFC-P-CF		0298203	3/8 x 1/2 x 36	098268627190	40	18	7.75	
LFCFC-P-CF		0298204	3/8 x 1/2 x 48	098268627206	40	25	5.00	
LFCFC-P-CF		0298205	3/8 x 1/2 x 60	098268627213	40	18	5.50	
LFCFC-P-CF		0298206	3/8 x 1/2 x 72	098268627220	40	72	6.25	
LEAD FREE	LFCFC-P-TF	0298208	3/8 x 1/2 x 16	098268627244	100	20	6.50	
	LFCFC-P-TF	0298211	3/8 x 1/2 x 30	098268627282	40	32	4.00	
	LFCFC-P-TF	0298213	3/8 x 1/2 x 48	098268627305	40	48	4.75	
	LFCFC-P-TF	0298215	3/8 x 1/2 x 72	098268627329	40	72	6.25	
	CFC-P-CF	0298217	7/16 x 1/2 x 16	098268627350	100	20	5.50	
	CFC-P-CF	0298219	7/16 x 1/2 x 24	098268627374	100	20	2.50	
	LEAD FREE	LFCFC-P-FF	0298435	1/2 x 1/2 x 12	098268485554	100	23	3.50
		LFCFC-P-FF	0298461	1/2 x 1/2 x 15	098268485813	100	29	3.25
		LFCFC-P-FF	0298436	1/2 x 1/2 x 16	098268485561	100	29	4.50
LFCFC-P-FF		0298437	1/2 x 1/2 x 20	098268485578	100	30	5.25	
LFCFC-P-FF		0298438	1/2 x 1/2 x 24	098268485585	100	34	6.00	
LFCFC-P-FF		0298226	1/2 x 1/2 x 30	098268627442	40	17	6.50	
LFCFC-P-FF		0298227	1/2 x 1/2 x 36	098268627459	40	18	7.25	
LFCFC-P-FF		0298228	1/2 x 1/2 x 48	098268627466	40	8.0	8.00	
LFCFC-P-FF		0298229	1/2 x 1/2 x 60	098268627473	40	26	8.75	
LFCFC-P-FF	0298230	1/2 x 1/2 x 72	098268627480	40	24	9.50		

†NOTE: National residential plumbing codes reference the maximum operating temperature as 140°F (60°C). Plumbing fixtures are designed to ANSI-ASME A112.18.1 at 125psi. For other applications requiring higher operating temperatures or pressures, please contact local Watts agent.

*The wetted surface of this product contacted by consumable water contains less than 0.25% of lead by weight.

Consult factory for ordering code numbers of special models/options.

Flexible Connectors

Model	Ordering Code	Size (in.)	UPC	Qty. Per Carton	Weight Per Carton (lbs.)	List Price (each)
-------	---------------	------------	-----	-----------------	--------------------------	-------------------

Stainless Steel Toilet Connectors - Max. Temperature 180°F / Max Pressure 125psi

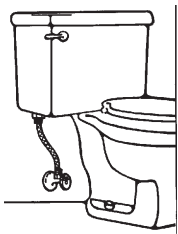

CTC-S-FB
Toilet Connector

CTC-S-CB	0298042	3/8 x 7/8 x 6	098268627497	100	15	\$ 3.75
CTC-S-CB	0298043	3/8 x 7/8 x 9	098268627503	100	18	3.75
CTC-S-CB	0298044	3/8 x 7/8 x 12	098268627510	100	20	4.75
CTC-S-CB	0298045	3/8 x 7/8 x 16	098268627527	100	25	5.50
CTC-S-CB	0298046	3/8 x 7/8 x 20	098268627534	100	25	6.50
CTC-S-CB	0298054	7/16 x 7/8 x 12	098268627633	100	24	5.25
CTC-S-CB	0298055	7/16 x 7/8 x 16	098268627640	100	31	3.75
CTC-S-CB	0298056	7/16 x 7/8 x 20	098268627657	100	35	7.25
CTC-S-CB	0298058	1/2 x 7/8 x 9	098268627671	100	19	3.50
CTC-S-CB	0298059	1/2 x 7/8 x 12	098268627688	100	23	4.00
CTC-S-CB	0298060	1/2 x 7/8 x 16	098268627695	100	31	3.25
CTC-S-CB	0298061	1/2 x 7/8 x 20	098268627701	100	25	3.75
CTC-S-FB	0298062	1/2 x 7/8 x 6	098268627718	100	10	2.75
CTC-S-FB	0298063	1/2 x 7/8 x 9	098268627725	100	20	4.75
CTC-S-FB	0298064	1/2 x 7/8 x 12	098268627732	100	24	5.50
CTC-S-FB	0298065	1/2 x 7/8 x 16	098268627749	100	25	6.50
CTC-S-FB	0298242	1/2 x 7/8 x 20	098268630091	100	32	4.25
CTC-S-TB	0298048	3/8 x 7/8 x 9	098268627565	25	5.2	3.25
CTC-S-TB	0298049	3/8 x 7/8 x 12	098268627572	100	21	5.50
CTC-S-TB	0298050	3/8 x 7/8 x 16	098268627589	100	20	6.25
CTC-S-TB	0298051	3/8 x 7/8 x 20	098268627596	100	20	7.50
CTC-S-TB	0298067	1/2 x 7/8 x 6	098268627756	100	20	2.75
CTC-S-TB	0298068	1/2 x 7/8 x 9	098268627763	100	18	3.25
CTC-S-TB	0298069	1/2 x 7/8 x 12	098268627770	100	24	6.00
CTC-S-TB	0298070	1/2 x 7/8 x 16	098268627787	100	20	7.00
CTC-S-TB	0298071	1/2 x 7/8 x 20	098268627794	25	7.0	7.75

Toilet Connectors - Reinforced PVC - Max. Temp. 140°F / Max Press. 125psi.

CTC-P-CB	0298075	3/8 x 7/8 x 6	098268627831	100	15	4.75
CTC-P-CB	0298076	3/8 x 7/8 x 9	098268627848	100	21	3.00
CTC-P-CB	0298077	3/8 x 7/8 x 12	098268627855	100	22	3.25
CTC-P-CB	0298078	3/8 x 7/8 x 16	098268627862	25	7.2	3.50
CTC-P-CB	0298079	3/8 x 7/8 x 20	098268627879	100	26	3.75
CTC-P-CB	0298080	3/8 x 7/8 x 30	098268627886	40	15	2.75
CTC-P-CB	0298094	1/2 x 7/8 x 9	098268628029	100	21	2.50
CTC-P-CB	0298095	1/2 x 7/8 x 12	098268628036	100	22	3.75
CTC-P-CB	0298096	1/2 x 7/8 x 16	098268628043	100	20	2.50
CTC-P-CB	0298097	1/2 x 7/8 x 20	098268628050	100	33	2.75
CTC-P-CB	0298098	1/2 x 7/8 x 30	098268628067	40	8	2.75
CTC-P-TB	0298082	3/8 x 7/8 x 9	098268627909	100	10	2.50
CTC-P-TB	0298083	3/8 x 7/8 x 12	098268627916	100	22	3.75
CTC-P-TB	0298084	3/8 x 7/8 x 16	098268627923	100	20	2.75
CTC-P-TB	0298085	3/8 x 7/8 x 20	098268627930	100	20	4.25
CTC-P-TB	0298086	3/8 x 7/8 x 30	098268627947	40	20	3.00
CTC-P-TB	0298100	1/2 x 7/8 x 9	098268628081	100	10	2.75
CTC-P-TB	0298101	1/2 x 7/8 x 12	098268628098	100	10	4.00
CTC-P-TB	0298102	1/2 x 7/8 x 16	098268628104	100	20	2.75
CTC-P-TB	0298103	1/2 x 7/8 x 20	098268628111	100	20	3.00
CTC-P-FB	0298105	1/2 x 7/8 x 9	098268628135	100	21	3.50
CTC-P-FB	0298106	1/2 x 7/8 x 12	098268628142	25	5.6	3.75
CTC-P-FB	0298107	1/2 x 7/8 x 16	098268628159	100	20	3.50
CTC-P-FB	0298108	1/2 x 7/8 x 20	098268628166	100	20	2.75



CTC-P-FB
Toilet Connector

*The wetted surface of this product contacted by consumable water contains less than 0.25% of lead by weight.

Consult factory for ordering code numbers of special models/options.

Flexible Connectors

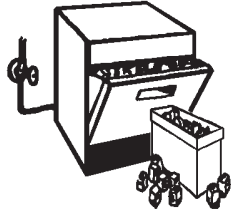

Model	Ordering Code	Size (in.)	UPC	Qty. Per Carton	Weight Per Carton (lbs.)	List Price (each)
-------	---------------	------------	-----	-----------------	--------------------------	-------------------

Reinforced PVC Ice Maker Connectors - Nylon Braided Hose



Max. Temperature 140°F / Max. Pressure 125psi.

Model	Ordering Code	Size (in.)	UPC	Qty. Per Carton	Weight Per Carton (lbs.)	List Price (each)
LFCIC-P	0298231	1/4 x 1/4 x 6'	098268626780	40	26	\$ 4.00
LFCIC-P	0298232	1/4 x 1/4 x 10'	098268626797	40	41	4.25
LFCIC-P	0298233	1/4 x 1/4 x 20'	098268626803	40	84	5.00

LEAD FREE

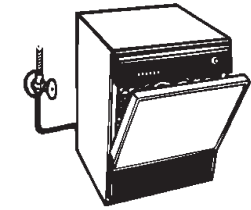

CDC-S-FE
Dishwasher Connector

Model	Ordering Code	Size (in.)	UPC	Qty. Per Carton	Weight Per Carton (lbs.)	List Price (each)
-------	---------------	------------	-----	-----------------	--------------------------	-------------------

Stainless Steel Dishwasher Connectors



Max. Temperature 180°F / Max. Pressure 125psi

Model	Ordering Code	Size (in.)	UPC	Qty. Per Carton	Weight Per Carton (lbs.)	List Price (each)
CDC-S-CE	0298234	3/8 x 3/8 x 48	098268626810	40	27	\$ 18.75
CDC-S-CE	0298235	3/8 x 3/8 x 60	098268626827	40	31	20.25
CDC-S-CE	0298236	3/8 x 3/8 x 72	098268626834	40	34	21.50
CDC-S-FE	0298237	1/2 x 3/8 x 48	098268626841	40	29	18.50
CDC-S-FE	0298238	1/2 x 3/8 x 60	098268626858	40	28	19.25
CDC-S-FE	0298239	1/2 x 3/8 x 72	098268626865	40	37	12.00

Model	Ordering Code	Size (in.)	UPC	Qty. Per Carton	Weight Per Carton (lbs.)	List Price (each)
-------	---------------	------------	-----	-----------------	--------------------------	-------------------

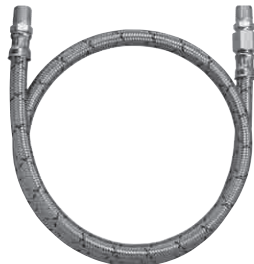

COC-S-MMx36
Oil Burner Connector

Braided Stainless Steel Connectors for Oil Burners

Max. Temperature 200°F / Max. Pressure 145psi

Model	Ordering Code	Size (in.)	UPC	Qty. Per Carton	Weight Per Carton (lbs.)	List Price (each)
COC-S-MMx24	0291400	1/4x1/4	098268549911	10	3.4	\$ 17.75
COC-S-MMx36	0291401	1/4x1/4	098268549928	10	4.9	19.50
COC-S-TTx24	0291402	3/8x3/8	098268549935	10	3.4	21.00
COC-S-TTx36	0291403	3/8x3/8	098268549942	10	4.9	23.00

*The wetted surface of this product contacted by consumable water contains less than 0.25% of lead by weight.
Consult factory for ordering code numbers of special models/options.

Dial Pressure Gauges

Model	Ordering Code	Size (in.)	UPC	Qty. Per Carton	Weight Per Carton (lbs.)	List Price (each)
-------	---------------	------------	-----	-----------------	--------------------------	-------------------

Bottom Entry Series LFDPG1

Dial Size: 2"



LFDPG1-2

LEAD FREE*	LFDPG1-2 0-60	0121632	1/4 NPT	098268588057	36	6.7	17.50
	LFDPG1-2 0-100	0121633	1/4 NPT	098268588064	36	7.4	17.50
	LFDPG1-2 0-160	0121634	1/4 NPT	098268588071	36	6.7	17.50
	LFDPG1-2 0-200	0121635	1/4 NPT	098268588088	36	6.7	17.50

Dial Size: 2 1/2"



LFDPG1-2 1/2

LEAD FREE*	LFDPG1-2 1/2 0-15	0121637	1/4 NPT	098268588101	24	5.5	19.00
	LFDPG1-2 1/2 0-30	0121638	1/4 NPT	098268588118	24	5.5	19.00
	LFDPG1-2 1/2 0-60	0121639	1/4 NPT	098268588323	24	5.5	19.00
	LFDPG1-2 1/2 0-100	0121640	1/4 NPT	098268588330	24	6.1	19.00
	LFDPG1-2 1/2 0-160	0121641	1/4 NPT	098268588378	24	5.5	19.00
	LFDPG1-2 1/2 0-200	0121642	1/4 NPT	098268588446	24	5.5	19.00
	LFDPG1-2 1/2 0-300	0121643	1/4 NPT	098268588453	24	5.5	19.00

Dial Size: 3"



LFDPG1-3

LEAD FREE*	LFDPG1-3 0-60	0121646	1/4 NPT	098268588552	18	6.0	25.75
	LFDPG1-3 0-100	0121647	1/4 NPT	098268588569	18	5.4	25.75
	LFDPG1-3 0-160	0121648	1/4 NPT	098268588576	18	0.6	25.75
	LFDPG1-3 0-200	0121649	1/4 NPT	098268588583	18	5.5	25.75
	LFDPG1-3 0-300	0121650	1/4 NPT	098268588590	18	6.0	25.75

Dial Size: 4"



LFDPG1-4

LEAD FREE*	LFDPG1-4 0-30	0121652	1/4 NPT	098268588613	12	5.4	31.50
	LFDPG1-4 0-60	0121653	1/4 NPT	098268588620	12	4.9	31.50
	LFDPG1-4 0-100	0121654	1/4 NPT	098268588637	12	11	31.50
	LFDPG1-4 0-160	0121655	1/4 NPT	098268588644	12	5.4	31.50
	LFDPG1-4 0-200	0121656	1/4 NPT	098268588651	12	5.4	31.50
	LFDPG1-4 0-300	0121657	1/4 NPT	098268588668	12	5.4	31.50

*The wetted surface of this product contacted by consumable water contains less than 0.25% of lead by weight.

Consult factory for ordering code numbers of special models/options.

Dial Pressure Gauges

Model	Ordering Code	Connection Size (in.)	UPC	Qty. Per Carton	Weight Per Carton (lbs.)	List Price (each)
-------	---------------	-----------------------	-----	-----------------	--------------------------	-------------------



LFDPG3-1½

Center Back Entry Series DPG3 and LFDPG3

Dial Size: 1 1/2"

LEAD FREE*	LFDPG3-1 1/2 0-160	0121712	1/8 NPT	098268590364	100	11	\$ 31.75
-------------------	--------------------	---------	---------	--------------	-----	----	----------

Dial Size: 2"

	DPG3-2 0-15	0615700	1/4 NPT	098268066357	100	1.0	24.50
--	-------------	---------	---------	--------------	-----	-----	-------



LFDPG3

LEAD FREE*	LFDPG3-2 0-60	0121697	1/4 NPT	098268590029	100	18	31.75
-------------------	---------------	---------	---------	--------------	-----	----	-------

LEAD FREE*	LFDPG3-2 0-160	0121699	1/4 NPT	098268590043	100	23	31.75
-------------------	----------------	---------	---------	--------------	-----	----	-------

Top Entry Series DPG5 and LFDPG5

Dial Size: 2"

LEAD FREE*	LFDPG5-2 0-160	0121713	1/8 NPT	098268590371	36	7.2	31.75
-------------------	----------------	---------	---------	--------------	----	-----	-------



LFDPG5

LEAD FREE*	LFDPG5-2 0-160	0121691	1/4 NPT	098268589924	36	6.5	31.75
-------------------	----------------	---------	---------	--------------	----	-----	-------

*The wetted surface of this product contacted by consumable water contains less than 0.25% of lead by weight.
Consult factory for ordering code numbers of special models/options.

Combination Pressure/Temperature Gauges

Model	Ordering Code	Connection Size (in.)	Temperature Range (°F)	UPC	Qty. Per Carton	Weight Per Carton (lbs.)	List Price (each)
-------	---------------	-----------------------	------------------------	-----	-----------------	--------------------------	-------------------

Bottom Entry

Series LFDPTG-1

Dial Size: 3"



LFDPTG-1

LEAD FREE	LFDPTG1-3 0-50	0121663	1/2 NPT	60 - 320	098268589122	40	21	\$ 89.50
	LFDPTG1-3 0-75	0121664	1/2 NPT	60 - 320	098268589139	50	21	89.50
	LFDPTG1-3 0-200	0121665	1/2 NPT	60 - 320	098268589146	50	26	89.50

Center Back Entry - Includes 1/4" x 1/2" DPG-VR Retaining Valve

Series LFDPTG-3

Dial Size: 3"



LFDPTG3-3

LEAD FREE	LFDPTG3-3 0-50	0121660	1/2 NPT	60 - 320	098268588989	40	17	87.25
	LFDPTG3-3 0-75	0121661	1/2 NPT	60 - 320	098268589092	40	22	87.25
	LFDPTG3-3 0-200	0121662	1/2 NPT	60 - 320	098268589115	40	18	87.25

Dial Size: 2 1/2"

LEAD FREE	LFDPTG3-2 1/2 0-50	0121685	1/2 NPT	60 - 320	098268589481	50	18	76.25
	LFDPTG3-2 1/2 0-75	0121686	1/2 NPT	60 - 320	098268589863	50	18	76.25
	LFDPTG3-2 1/2 0-75	0121722	1/4 NPT	60 - 320	098268590708	50	16	76.25
	LFDPTG3-2 1/2 0-200	0121687	1/2 NPT	60 - 320	098268589870	50	24	76.25

Series LFDPTG3L

Dial Size: 2 1/2" *

LEAD FREE	LFDPTG3A-2 1/2 0-75	0121723	1/4 NPT	60 - 320	098268590719	40	21	87.25
	LFDPTG3L-2 1/2 0-75	0121724	1/4 NPT	60 - 320	098268590760	40	21	88.75

*Do not include DPG-VR Retaining Valve

*The wetted surface of this product contacted by consumable water contains less than 0.25% of lead by weight.

Consult factory for ordering code numbers of special models/options.

Temperature Gauges

Model	Ordering Code	Connection Size (in.)	UPC	Qty. Per Carton	Weight Per Carton (lbs.)	List Price (each)
-------	---------------	-----------------------	-----	-----------------	--------------------------	-------------------



276H300

Hose Connection Gauges

Series 276H300

Dial Size: 2 1/2"

276H300 0-300	0069721	3/4 H.T.	098268007947	24	9.6	\$ 27.50
---------------	---------	----------	--------------	----	-----	----------

Series IWTG

Dial Size: 2 1/2"

IWTG 0-200	0069770	3/4 H.T.	098268847444	8	5.4	20.75
------------	---------	----------	--------------	---	-----	-------



IWTG-Gas-2

Air Test Assembly Gauges

Series IWTG-Gas-2

IWTG-GAS-2 0-30	0069780	3/4	098268182842	100	82	14.00
-----------------	---------	-----	--------------	-----	----	-------

IWTG-GAS-2 0-100	0069782	3/4	098268182866	100	82	14.00
------------------	---------	-----	--------------	-----	----	-------

Series IWTG-NYC

Dial Size: 2 1/2", 2% Accuracy

IWTG-NYC 0-5	0069786	3/4	098268258561	20	25	103.50
--------------	---------	-----	--------------	----	----	--------

IWTG-NYC 0-10	0069785	3/4	098268258585	10	13	103.50
---------------	---------	-----	--------------	----	----	--------



IWTG-NYC

Series IWTG-HTX

Dial Size: 4", 1% Accuracy

IWTG-HTX 0-5	0069788	3/4	098268258028	10	13	140.00
--------------	---------	-----	--------------	----	----	--------

IWTG-HTX 0-10	0069787	3/4	098268258578	10	14	140.00
---------------	---------	-----	--------------	----	----	--------



IWTG-HTX

*The wetted surface of this product contacted by consumable water contains less than 0.25% of lead by weight.

Consult factory for ordering code numbers of special models/options.

Temperature Gauges

Model	Ordering Code	Probe Length Size (in.)	Temperature Range (°F)	UPC	Qty. Per Carton	Weight Per Carton (lbs.)	List Price (each)
-------	---------------	-------------------------	------------------------	-----	-----------------	--------------------------	-------------------

Center Back Entry - Includes 1/2" NPT Thermowell With Set Screw Series LFTB

Dial Size: 1 1/2"

LEAD FREE*	LFTB-1 1/2-1	0121666	1	32-176	098268045536	24	5.8	\$ 20.00
-------------------	--------------	---------	---	--------	--------------	----	-----	----------

Dial Size: 2 1/2"

LEAD FREE*	LFTB-2 1/2-2	0121667	2	32 - 140	098268589191	12	4.6	41.00
	LFTB-2 1/2-2	0121668	2	32 - 248	098268589283	12	5.1	41.00
	LFTB-2 1/2-4	0121669	4	32 - 248	098268589290	12	5.1	41.25

Dial Size: 3"

LEAD FREE*	LFTB-3-2	0121670	2	-22 - 122	098268589337	12	6.3	77.00
	LFTB-3-2	0121672	2	32 - 248	098268589351	12	6.1	77.00

Dial Size: 4"

LEAD FREE*	LFTB-4-4	0121676	4	32 - 248	098268589399	4	3.4	109.00
-------------------	----------	---------	---	----------	--------------	---	-----	--------

Bottom Entry - includes 1/2" NPT snap in thermowell Series TBR and LFTBR

Dial Size: 3"

LEAD FREE*	LFTB-3-2	0121679	2	32 - 248	098268589429	8	5.5	134.00
-------------------	----------	---------	---	----------	--------------	---	-----	--------

Pipe Mount

Series LFTBP-M

Spring Mount - Dial Size: 2 1/2"

LEAD FREE*	LFTBP-M-2 1/2	0615658	2 1/2"	32 - 248	098268045857	16	0.3	50.75
-------------------	---------------	---------	--------	----------	--------------	----	-----	-------

Series LFTBP-F

Strap Mount - Dial Size: 2 1/2"

	LFTBP-F	0121683	-	32 - 248	098268589467	14	4.9	66.25
	LFTBP-F 2 1/2	0615659	-	32 - 248	098268045864	14	4.9	50.75

Series TBC

Chimney Mount - Dial Size: 2 1/2"

LEAD FREE*	TBC-2 1/2-12	0615663	12	32 - 932	098268045901	16	18	44.50
-------------------	--------------	---------	----	----------	--------------	----	----	-------



LFTB



TBR



LFTBP-M

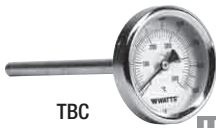

TBC

*The wetted surface of this product contacted by consumable water contains less than 0.25% of lead by weight.

Consult factory for ordering code numbers of special models/options.

T&P Test Plugs and Accessories

Model	Ordering Code	Probe Length Size (in.)	Temperature Range (°F)	UPC	Qty. Per Carton	Weight Per Carton (lbs.)	List Price (each)
-------	---------------	-------------------------	------------------------	-----	-----------------	--------------------------	-------------------

Liquid Fill Thermometers

9" Adjustable Angle Series TA

LEAD FREE*	Model	Ordering Code	Probe Length Size (in.)	Temperature Range (°F)	UPC	Qty. Per Carton	Weight Per Carton (lbs.)	List Price (each)
	LFTA-9-3.5	0121727	3 1/2	0 – 120	098268590838	25	41	\$ 213.50
	LFTA-9-3.5	0121728	3 1/2	0 – 160	098268590845	25	40	213.50
	LFTA-9-3.5	0121729	3 1/2	30 – 240	098268590852	25	41	213.50
	LFTA-9-6	0121732	6	30 – 240	098268590883	25	50	336.00

5" Angle Series TL

LEAD FREE*	Model	Ordering Code	Probe Length Size (in.)	Temperature Range (°F)	UPC	Qty. Per Carton	Weight Per Carton (lbs.)	List Price (each)
	LFTL-5-2	0121735	5/16	30 – 240	098268590913	20	10.5	111.00



Model	Ordering Code	Size (in.)	UPC	Qty. Per Carton	Weight Per Carton (lbs.)	List Price (each)
-------	---------------	------------	-----	-----------------	--------------------------	-------------------

Temperature or Pressure Test Plugs Series LFTP

LEAD FREE*	Model	Ordering Code	Size (in.)	UPC	Qty. Per Carton	Weight Per Carton (lbs.)	List Price (each)
	LFTP-N (Neoprene)	0123012	1/4 Brass	098268650440	180	18	\$ 20.00
	LFTP-E (EPDM)	0123005	1/4 Brass	098268650358	180	5.4	28.50
	LFTP-V (Viton®)	0123008	1/4 Brass	098268650396	180	1.8	41.25
	LFTP-N (Neoprene)	0123013	1/2 Brass	098268650495	72	11	36.50
	LFTP-E (EPDM)	0123006	1/2 Brass	098268650372	72	14	31.25

Extensions

LEAD FREE*	Model	Ordering Code	Size (in.)	UPC	Qty. Per Carton	Weight Per Carton (lbs.)	List Price (each)
	LFTP-X (3")	0123007	1/4 NPT Brass	098268650389	90	18	55.25
	LFTP-X (3")	0123009	1/2 NPT Brass	098268650402	50	15	68.25

Gauge Adapter

Series LFTPG

LEAD FREE*	Model	Ordering Code	Size (in.)	UPC	Qty. Per Carton	Weight Per Carton (lbs.)	List Price (each)
	LFTP-GA1	0123014	1/4"	098268650518	90	7.9	163.50



Viton® is a registered trademark of DuPont Dow Elastomers

*The wetted surface of this product contacted by consumable water contains less than 0.25% of lead by weight.
Consult factory for ordering code numbers of special models/options.

Anti-Scale Systems

OneFlow®



OF744 OF1252 OF1465



OF817 OF1019



OF110 OF210



OF-TWH-RM

Model	Ordering Code	Connection Option or Description	UPC	Qty. Per Carton	Weight Per Carton (lbs.)	List Price (each)
-------	---------------	----------------------------------	-----	-----------------	--------------------------	-------------------

Cold Water Tank Systems

OF744-10-A	0002100	3/4 Sweat	098268360677	1	22	\$ 1,271.00
OF744-10-B	0002101	1 Sweat	098268360684	1	22	1,271.00
OF744-10-C	0002102	1 Plastic MPT	098268360691	1	22	1,271.00
OF744-10-D	0002103	1 1/4 Plastic MPT	098268360707	1	22	1,271.00
OF744-10-E	0002104	1 Plastic MPT 90° Elbow	098268360714	1	22	1,271.00
OF844-12-A	0002105	3/4 Sweat	098268360721	1	25	1,390.50
OF844-12-B	0002106	1 Sweat	098268360738	1	25	1,390.50
OF844-12-C	0002107	1 Plastic MPT	098268360745	1	25	1,390.50
OF844-12-D	0002108	1 1/4 Plastic MPT	098268360752	1	25	1,390.50
OF844-12-E	0002109	1 Plastic MPT 90° Elbow	098268360769	1	25	1,390.50
OF948-16-A	0002110	3/4 Sweat	098268360776	1	29	1,629.50
OF948-16-B	0002111	1 Sweat	098268360783	1	29	1,629.50
OF948-16-C	0002112	1 Plastic MPT	098268360790	1	29	1,629.50
OF948-16-D	0002113	1 1/4 Plastic MPT	098268360806	1	29	1,629.50
OF948-16-E	0002114	1 Plastic MPT 90° Elbow	098268360813	1	29	1,629.50
OF1054-20-A	0002115	3/4 Sweat	098268360820	1	35	1,935.50
OF1054-20-B	0002116	1 Sweat	098268360837	1	35	1,935.50
OF1054-20-C	0002117	1 Plastic MPT	098268360844	1	35	1,935.50
OF1054-20-D	0002118	1 1/4 Plastic MPT	098268360851	1	35	1,935.50
OF1054-20-E	0002119	1 Plastic MPT 90° Elbow	098268360868	1	35	1,935.50
OF1252-30-A	0002120	3/4 Sweat	098268360875	1	43	2,904.50
OF1252-30-B	0002121	1 Sweat	098268360882	1	43	2,904.50
OF1252-30-C	0002122	1 Plastic MPT	098268360899	1	43	2,904.50
OF1252-30-D	0002123	1 1/4 Plastic MPT	098268360905	1	43	2,904.50
OF1252-30-E	0002124	1 Plastic MPT 90° Elbow	098268360912	1	43	2,904.50
OF1465-50	0002125	2 Socket (plastic sweat)	098268360929	1	79	6,328.50
OF1665-75	0002126	2 Socket (plastic sweat)	098268360936	1	97	7,998.50

LEAD FREE*

Hot Water Tank Systems

OF817-8H-B	0002128	1 FNPT	098268360950	1	17	1,671.75
OF817-12H-B	0002133	1 FNPT	098268361001	1	24	1,912.75
OF1019-20H-B	0002138	1 FNPT	098268361056	1	32	2,570.75
OF1465-75H	0002147	2 Socket	098268361094	1	68	9,984.75

Cold Water Cartridge-based Systems

OF110-1	0002148	OF 1-Housing 10 (1 gpm)	098268361100	1	5.0	359.50
OF120-2	0002149	OF 1-Housing 20 (2 gpm)	098268361117	1	8.0	576.50
OF140-4	0002150	OF 1-Housing BB (4 gpm)	098268361124	1	18	980.50

Cold Water Cartridge-based Filter Systems

OF210-1	0002151	OF 2-Housing 10 (1 gpm)	098268361131	1	9.0	676.75
OF220-2	0002152	OF 2-Housing 20 (2 gpm)	098268361148	1	14	982.50
OF240-4	0002153	OF 2-Housing BB (4 gpm)	098268361155	1	31	1,909.50

Tankless Water Heater Systems

OF-TWH	0002182	3/4" FNPT	098268493887	1	5.0	588.50
--------	---------	-----------	--------------	---	-----	--------

Replacement Media for Tankless Water Heater Systems

OF-TWH-RM	0002183		098268493894	1	6.0	326.00
-----------	---------	--	--------------	---	-----	--------

*The wetted surface of this product contacted by consumable water contains less than 0.25% of lead by weight.

Consult factory for ordering code numbers of special models/options.

Anti-Scale Systems

OneFlow®



OF110RC



CK-V3006

Model	Ordering Code	Connection Option or Description	UPC	Qty. Per Carton	Weight Per Carton (lbs.)	List Price (each)
-------	---------------	----------------------------------	-----	-----------------	--------------------------	-------------------

Replacement Media for Cold Water Tank Systems

Model	Ordering Code	Connection Option or Description	UPC	Qty. Per Carton	Weight Per Carton (lbs.)	List Price (each)
OF744RM	0002154	OF Media for 744 (10 gpm)	098268361162	1	6.0	\$ 505.25
OF844RM	0002155	OF Media for 844 (12 gpm)	098268361179	1	8.0	606.75
OF948RM	0002156	OF Media for 948 (16 gpm)	098268361186	1	10	809.00
OF1054RM	0002157	OF Media for 1054 (20 gpm)	098268361193	1	12	1,011.00
OF1252RM	0002158	OF Media for 1252 (30 gpm)	098268361209	1	15	1,516.25
OF1465RM	0002159	OF Media for 1465 (50 gpm)	098268361216	1	25	2,526.50
OF1665RM	0002160	OF Media for 1665 (75 gpm)	098268361223	1	34	3,839.75

Replacement Media for Hot Water Tank Systems

Model	Ordering Code	Connection Option or Description	UPC	Qty. Per Carton	Weight Per Carton (lbs.)	List Price (each)
OF817-8HRM	0002178	RM for 8 gpm Hot Tank	098268427233	1	5.0	421.75
OF817-12HRM	0002179	RM for 12 gpm Hot Tank	098268427240	1	8.0	606.75
OF1019-20HRM	0002180	RM for 20 gpm Hot Tank	098268427257	1	12	1,011.00
OF1465-75HRM	0002181	RM for 75 gpm Hot Tank	098268427264	1	34	3,840.00

Replacement Cartridges for Filter Systems

Model	Ordering Code	Connection Option or Description	UPC	Qty. Per Carton	Weight Per Carton (lbs.)	List Price (each)
OF110RM	0002161	OF Ctg for 10 housing	098268361230	6	36	156.00
OF120RM	0002162	OF Ctg for 20 housing	098268361247	6	12	254.50
OF140RM	0002163	OF Ctg for BB housing	098268361254	15	60	466.50
OF110RC	0002164	Carbon Block Ctg for 10	098268361261	84	336	37.00
OF120RC	0002165	Carbon Block Ctg for 20	098268361278	42	294	62.00
OF140RC	0002166	Carbon Block Ctg for BB	098268361285	14	98	170.00

Accessories

Model	Ordering Code	Connection Option or Description	UPC	Qty. Per Carton	Weight Per Carton (lbs.)	List Price (each)
CK-V3006	0002167	CK-2-way Bypass valve	098268361292	1	0.8	45.75
CK-V3191-01	0002168	CK-Bypass elbow for vertical	098268361308	1	0.8	22.50
CK-V3007	0002169	CK-1 90° Male NPT	098268361315	1	0.8	11.50
CK-V3007-04	0002172	CK-1 Plastic Male NPT	098268361346	1	0.8	16.50
CK-V3007-05	0002173	CK-1 1/4 Plastic Male NPT	098268361353	1	0.8	17.60
OFSSS8	0002174	polished SS jacket for 8" tank	098268361360	1	14	117.00
OFSSS9	0002175	polished SS jacket for 9" tank	098268361377	1	16	117.00
OFSSS10	0002176	polished SS jacket for 10" tank	098268361384	1	19	170.50
OFSSS12	0002177	polished SS jacket for 12" tank	098268361391	1	24	306.50

*The wetted surface of this product contacted by consumable water contains less than 0.25% of lead by weight.

Consult factory for ordering code numbers of special models/options.

Vinyl Tubing

Model	Ordering Code	Color	I.D.	O.D.	Wall	Length FT/Coil	Working Pressure (psi @ 70°F)	Qty.	Weight Each	List Price (each)
-------	---------------	-------	------	------	------	----------------	-------------------------------	------	-------------	-------------------

Bulk Open Coil

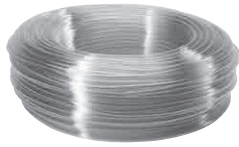

LEAD FREE*

C1001	C003141	Clear	1/16	1/8	1/32	500	55	1	3.3	\$ 44.75
C1003-500	C000774	Clear	1/8	1/4	1/16	500	55	1	11	73.25
C1004-500	C000784	Clear	3/16	5/16	1/16	500	55	1	15	88.75
C1005	C003144	Clear	3/16	7/16	1/8	500	55	1	32	164.00
C1006-500	C000790	Clear	1/4	3/8	1/16	500	55	1	20	98.00
C1008	C003146	Clear	1/4	1/2	1/8	500	55	1	11	192.00
C1010-1	C003148	Clear	5/16	9/16	1/8	500	55	1	11	226.00
C1011-500	C001322	Clear	3/8	1/2	1/16	500	45	1	27	117.00
C1013	C003149	Clear	3/8	5/8	1/8	250	55	1	25	123.50
C1016	C003153	Clear	1/2	5/8	1/16	250	45	1	15	79.00
C1017-250	C001109	Clear	1/2	3/4	1/8	250	55	1	36	165.00
C1019-1	C003156	Clear	9/16	3/4	3/32	250	50	1	28	151.50
C1020	C003157	Clear	5/8	3/4	1/16	250	30	1	18	99.75
C1024-100	C001316	Clear	3/4	1	1/8	100	35	1	21	91.50
C1027	C000875	Clear	1 1/4	1 3/4	1/4	50	25	1	35	134.50
C1027-1	C000876	Clear	1 1/4	1 5/8	3/16	50	25	1	28	112.00
C1028	C001245	Clear	1 1/2	2	1/4	50	25	1	36	157.50
C1029	C000881	Clear	1 1/2	1 7/8	3/16	50	25	1	23	126.00

Coil Packaged in a Cardboard Box



LEAD FREE*

C1002A	C000771	Clear	1/8	3/16	1/32	500	55	1	6.0	67.75
C1003A	C000775	Clear	1/8	1/4	1/16	100	55	1	2.5	18.00
C1004A	C000785	Clear	3/16	5/16	1/16	100	55	1	7.0	23.25
C1006A	C000791	Clear	1/4	3/8	1/16	100	55	1	4.3	24.50
C1009A	C000805	Clear	5/16	7/16	1/16	100	50	1	5.3	27.00
C1010A	C000811	Clear	5/16	1/2	3/32	100	55	1	8.0	38.00
C1011A	C000815	Clear	3/8	1/2	1/16	100	45	1	6.4	29.25
C1014A	C000829	Clear	7/16	9/16	1/16	100	45	1	6.5	34.25
C1016A	C000834	Clear	1/2	5/8	1/16	100	45	1	8.1	34.50
C1016-1A	C000833	Clear	1/2	1 1/16	3/32	100	50	1	12	46.25
C1017A	C000841	Clear	1/2	3/4	1/8	100	55	1	17	70.50
C1020A	C000845	Clear	5/8	3/4	1/16	100	30	1	10	42.50
C1022A	C000852	Clear	5/8	7/8	1/8	100	40	1	18	85.25
C1023A	C000858	Clear	3/4	7/8	1/16	100	30	1	13	55.75
C1024A	C000861	Clear	3/4	1	1/8	100	35	1	22	95.25
C1025A	C001116	Clear	7/8	1 1/8	1/8	100	30	1	26	113.50
C1026A	C000869	Clear	1	1 1/4	1/8	100	25	1	35	134.50

*The wetted surface of this product contacted by consumable water contains less than 0.25% of lead by weight.

Consult factory for ordering code numbers of special models/options.

Vinyl Tubing

Model	Ordering Code	Color	I.D.	O.D.	Wall	Length FT/Coil	Working Pressure (psi @ 70°F)	Qty.	Weight Each	List Price (each)
-------	---------------	-------	------	------	------	----------------	-------------------------------	------	-------------	-------------------

E-Z Dispenser Boxes



LEAD FREE*

XVDC	43132100	Clear	1/8	3/16	1/32	100	55	1	1.4	\$ 17.00
XVEC	43132200	Clear	1/8	1/4	1/16	100	55	1	2.7	22.00
XVFD	43132300	Clear	3/16	5/16	1/16	100	55	1	3.8	25.00
XVGE	43132400	Clear	1/4	3/8	1/16	100	55	1	4.1	28.75
XVHF	43132500	Clear	5/16	7/16	1/16	100	50	1	6.0	32.00
XVIF	43132600	Clear	5/16	1/2	3/32	100	55	1	7.4	46.25
XVIG	43132640	Clear	3/8	1/2	1/16	100	45	1	5.4	34.75
XVJG	43132641	Clear	3/8	9/16	3/32	100	55	1	8.9	57.25
XVKI	43132700	Clear	1/2	5/8	1/16	100	45	1	7.4	45.25
XVLI	43132800	Clear	1/2	3/4	1/8	100	55	1	15	83.50
XVMK	43132900	Clear	5/8	7/8	1/8	100	40	1	18	102.00
XVNL	43132950	Clear	3/4	1	1/8	50	35	1	9.9	66.75
XVPN	43132951	Clear	1	1 1/4	1/8	50	25	1	14	80.25

Dispenser Spools

LEAD FREE*

C1011SC-230	C000821	Clear	3/8	1/2	1/16	230	45	1	11	70.00
C1016SC-100	C001463	Clear	1/2	5/8	1/16	100	45	1	7.0	39.50
C1024SC-50	C001162	Clear	3/4	1	1/8	50	35	1	11	57.25
C1026SC-40	C000874	Clear	1	1 1/4	1/8	40	25	1	10.4	55.50

*The wetted surface of this product contacted by consumable water contains less than 0.25% of lead by weight.
Consult factory for ordering code numbers of special models/options.

Braided Reinforced Vinyl Tubing

Model	Ordering Code	Color	I.D.	O.D.	Wall	Length FT/Coil	Working Pressure (psi @ 70°F)	Qty.	Weight Each	List Price (each)
-------	---------------	-------	------	------	------	----------------	-------------------------------	------	-------------	-------------------



Bulk Open Coil

LEAD FREE*	B5001-300	C000738	Clear	1/4	1/2	1/8	300	250	1	25	\$ 127.00
	B5002	C000742	Clear	3/8	5/8	1/8	100	225	1	10	58.50
	B5003	C000746	Clear	1/2	3/4	1/8	100	200	1	15	68.25
	B5004	C000750	Clear	5/8	7/8	1/8	100	175	1	9.6	80.25
	B5005	C000753	Clear	3/4	1	1/8	100	150	1	21	91.00
	B5006	C000759	Clear	1	1 3/8	3/16	100	125	1	30	176.50
	B5008	C000762	Clear	1 1/2	2	1/4	50	75	1	31	177.50
	B5009	C000764	Clear	2	2 5/8	1/4	50	70	1	46	237.50



Coil in Cardboard Box

LEAD FREE*	B5001A	C000739	Clear	1/4	1/2	1/8	100	250	1	9.3	48.25
------------	--------	---------	-------	-----	-----	-----	-----	-----	---	-----	-------



E-Z Dispenser Boxes

LEAD FREE*	XBVIE	43133200	Clear	1/4	1/2	1/8	100	250	1	10	52.50
	XBVKG	43133400	Clear	3/8	5/8	1/8	100	225	1	11	72.00
	XBVLI	43133600	Clear	1/2	3/4	1/8	100	200	1	15	87.00
	XBVMK	43133700	Clear	5/8	7/8	1/8	100	175	1	11	99.50
	XBVNL	43133850	Clear	3/4	1	1/8	50	150	1	11	60.25
	XBVQN	43133950	Clear	1	1 3/8	3/16	50	125	1	19	110.50



Dispenser Spools

LEAD FREE*	B5002SC-150	C001136	Clear	3/8	5/8	1/8	150	225	1	16	93.00
------------	-------------	---------	-------	-----	-----	-----	-----	-----	---	----	-------

*The wetted surface of this product contacted by consumable water contains less than 0.25% of lead by weight.

Consult factory for ordering code numbers of special models/options.

Polyethylene Tubing - Low Density

Model	Ordering Code	Color	I.D.	O.D.	Wall	Length FT/Coil	Working Pressure (psi @ 70°F)	Qty.	Weight Each	List Price (each)
-------	---------------	-------	------	------	------	----------------	-------------------------------	------	-------------	-------------------



Bulk Open Coils

LEAD FREE*	P2003-500	C000954	White	.170	¼	.040	500	140	1	6.0	\$ 67.75
	P2006-500	C000980	White	¼	⅜	⅛	500	120	1	14	111.50
	P2007-500	C000992	White	⅜	½	⅛	500	100	1	19	133.50



Cardboard Boxes

LEAD FREE*	P2006A-100	C001290	White	¼	⅜	⅛	100	120	1	4.0	25.50
------------	------------	---------	-------	---	---	---	-----	-----	---	-----	-------



E-Z Dispenser Boxes

LEAD FREE*	XPEB	43131200	White	.170	¼	.040	100	140	1	1.4	19.00
	XPFD	43131300	White	⅜	⅝	⅛	100	130	1	3.3	27.50
	XPGE	43131400	White	¼	⅜	⅛	100	120	1	2.9	32.50
	XPIG	43131600	White	⅜	½	⅛	100	100	1	4.0	36.25
	XPKI	43131800	White	½	⅝	⅛	100	85	1	5.3	40.75



Dispenser Spools

LEAD FREE*	P2003SC-500	C000965	White	.170	¼	.040	500	140	1	6.8	74.00
	P2006SC-500	C000988	White	¼	⅜	⅛	500	120	1	13	131.50

*The wetted surface of this product contacted by consumable water contains less than 0.25% of lead by weight.
Consult factory for ordering code numbers of special models/options.

Reel Tubing Program



Model	Ordering Code	Color	I.D.	O.D.	Wall	Length FT/Coil	Working Pressure (psi @ 70°F)	Qty.	Weight Each	List Price (each)
-------	---------------	-------	------	------	------	----------------	-------------------------------	------	-------------	-------------------

Clear Vinyl Tubing

RVDC	42160041	Clear	1/8	3/16	1/32	400	55	1	5.6	\$ 74.50
RVEC	42161140	Clear	1/8	1/4	1/16	400	55	1	10	94.25
RVEB	42160401	Clear	.170	1/4	.040	400	55	1	6.9	101.50
RVFD	42161300	Clear	3/16	5/16	1/16	300	55	1	10	85.75
RVGE	42162250	Clear	1/4	3/8	1/16	250	55	1	10	87.00
RVHF	42163200	Clear	5/16	7/16	1/16	200	50	1	10	81.25
RVIF	42165200	Clear	5/16	1/2	3/32	150	50	1	11	69.50
RVIG	42164100	Clear	3/8	1/2	1/16	100	45	1	6.1	50.00
RVJG	42164210	Clear	3/8	9/16	3/32	100	45	1	8.9	58.00
RVKI	42166100	Clear	1/2	5/8	1/16	100	45	1	7.5	54.00
RVLI	42167210	Clear	1/2	3/4	1/8	75	55	1	12	69.00
RVLK	42167100	Clear	5/8	3/4	1/16	100	30	1	8.5	59.00
RVMK	42167310	Clear	5/8	7/8	1/8	100	40	1	18	104.50
RVNL	42168075	Clear	3/4	1	1/8	75	35	1	15	102.50
RVPN	42169150	Clear	1	1-1/4	1/8	100	25	1	28	155.00
RVSP	42169160	Clear	1 1/4	1 5/8	3/16	50	25	1	28	146.50
RVUR	42169170	Clear	1 1/2	1 7/8	3/16	50	25	1	31	168.00
RVXV	42169190	Clear	2	2 3/8	3/16	25	20	1	20	114.00

Black Vinyl Tubing

RVDEB	42160400	Black	.170	1/4	.040	500	55	1	8.7	127.00
RVBIG	42169210	Black	3/8	1/2	1/16	100	45	1	6.5	50.00
RVBKI	42169310	Black	1/2	5/8	1/16	100	45	1	7.0	53.50
RVBLK	42169410	Black	5/8	3/4	1/16	100	30	1	11	59.50



Braided Vinyl Tubing

RBVIE	42172250	Clear	1/4	1/2	1/8	250	250	1	24	137.00
RBVKG	42174150	Clear	3/8	5/8	1/8	150	225	1	18	111.50
RBVLI	42176100	Clear	1/2	3/4	1/8	100	200	1	15	90.75
RBVMK	42177075	Clear	5/8	7/8	1/8	75	175	1	15	83.00
RBVNL	42178075	Clear	3/4	1	1/8	75	150	1	16	92.75
RBVQN	42178150	Clear	1	1 3/8	3/16	50	125	1	21	116.00
RBVTP	42178250	Clear	1 1/4	1 3/4	1/4	50	100	1	28	187.50
RBVVR	42178350	Clear	1 1/2	2	1/4	50	75	1	34	216.50



Tracer Hose

RBVRL	42178085	Red	3/4	1	1/8	75	150	1	14	174.50
RBVBL	42178095	Blue	3/4	1	1/8	75	150	1	17	174.50

Reel Tubing is marked every foot with notch mark and UPC code

*The wetted surface of this product contacted by consumable water contains less than 0.25% of lead by weight.
Consult factory for ordering code numbers of special models/options.

Reel Tubing Program

Model	Ordering Code	Color	I.D.	O.D.	Wall	Length FT/Coil	Working Pressure (psi @ 70°F)	Qty.	Weight Each	List Price (each)
-------	---------------	-------	------	------	------	----------------	-------------------------------	------	-------------	-------------------

Polyethylene Tubing - Low Density



LEAD FREE

RPEB	42152400	White	.170	1/4	.040	400	140	1	6.2	\$ 84.75
RPFD	42153300	White	3/16	5/16	1/16	300	130	1	6.8	78.25
RPGE	42154300	White	1/4	3/8	1/16	300	120	1	9.1	97.00
RPIG	42156200	White	3/8	1/2	1/16	200	100	1	8.6	70.00
RPKI	42157100	White	1/2	5/8	1/16	100	85	1	5.9	50.25



Latex Tubing

RLGE	42241050		1/4	3/8	1/16	50	N/A	1	2.5	74.50
------	----------	--	-----	-----	------	----	-----	---	-----	-------



Garden Hose

RGMK	42217150	Green	5/8	7/8	1/8	150	125	1	20	171.50
------	----------	-------	-----	-----	-----	-----	-----	---	----	--------



Air Hose

RALI	42185100	Orange	1/2	3/4	1/8	100	150	1	15	100.00
------	----------	--------	-----	-----	-----	-----	-----	---	----	--------



Spray Hose

RSPKG	42220100	Yellow	3/8	5/8	1/8	100	300	1	10	87.00
-------	----------	--------	-----	-----	-----	-----	-----	---	----	-------



Washer Hose

LEAD FREE

RWNK	42197050	Black	5/8	1	1/8	50	200	1	17	\$ 90.00
RWPM	42198025	Black	7/8	1 1/4	1/8	25	125	1	11	61.00



Heater Hose

RHLK	42327100	Black	5/8	3/4	1/8	100	80	1	21	174.00
RHNL	42328100	Black	3/4	1	1/8	75	80	1	26	161.50

Reel Tubing is marked every foot with notch mark and UPC code

*The wetted surface of this product contacted by consumable water contains less than 0.25% of lead by weight.
Consult factory for ordering code numbers of special models/options.

Reel Tubing Program

Model	Ordering Code	Color	I.D.	O.D.	Wall	Length FT/Coil	Working Pressure (psi @ 70°F)	Qty.	Weight Each	List Price (each)
-------	---------------	-------	------	------	------	----------------	-------------------------------	------	-------------	-------------------



Utility Hose

RUTLI	42291100	Red	½	¾	⅛	100	200	1	22	\$ 175.50
RUTOL	42293075	Red	¾	1⅛	⅜	75	200	1	31	189.50



Polyurethane Micro Fuel Line

RUFE	42206150		7/64	¼	.071	100	133	1	1.8	104.00
------	----------	--	------	---	------	-----	-----	---	-----	--------



Fuel Line

RFKF	42203100	Black	5/16	5/8	.156	100	175	1	10	114.50
------	----------	-------	------	-----	------	-----	-----	---	----	--------



Spa Flex Hose

RSFI	42280100	White	½	.84	⅛	100	100	1	19	\$ 179.00
RSFL	42281100	White	¾	1.05	⅛	100	100	1	27	215.50
RSFN	42282050	White	1	1.31	⅛	50	100	1	20	124.50
RSFP	42284050	White	1¼	1.66	⅛	50	80	1	24	176.00
RSFR	42283050	White	1½	1.90	⅛	50	65	1	28	176.50



Pool & Spa Vacuum Hose

RPSP	42260050	Blue	1¼	1.58	.165	50	n/a	1	10	115.50
RPSR	42261050	Blue	1½	1.81	.155	50	n/a	1	11	161.50



Pump & Bilge Discharge Hose

RBBO	42180785	White	1⅛	1⅝	¼	50	n/a	1	7.5	132.00
RBBP	42180795	White	1¼	1¾	¼	50	n/a	1	8.0	142.50
RBBR	42180765	White	1½	2	¼	50	n/a	1	8.5	197.00



Flat Discharge Hose

RCDR	42252050	Blue	1½		.051	150	70	1	17	223.50
RCDV	42252150	Blue	2		.053	150	65	1	17	324.50

Reel Tubing is marked every foot with notch mark and UPC code

*The wetted surface of this product contacted by consumable water contains less than 0.25% of lead by weight.

Consult factory for ordering code numbers of special models/options.

Tubing Rack

Description	Ordering Code	Qty.	List Price (each)
UPRIGHT - 1 HK	94630590	1 ea.	\$ 47.90
UPRIGHT - 4 HK	94630571	1 ea.	88.65
UPRIGHT - 7 HK	94630591	1 ea.	159.45
CROSS BRACE - 8"	94630575	1 ea.	11.30
CROSS BRACE - 13"	94630574	1 ea.	13.15
REEL HOLDER - 8"	94630573	1 ea.	4.70
REEL HOLDER - 13"	94630572	1 ea.	6.05
LARGE ARM	94630598	1 ea.	17.75
X- LARGE ARM	94630579	1 ea.	14.45
SIGN HANGER	94630596	1 ea.	13.60
1/4 - 20 X 2" BOLTS	94630584	1 ea.	0.20
1/4 - 20 HEX NUTS	94630585	1 ea.	0.05
LABELS FOR RACK	94635003	1 ea.	5.20

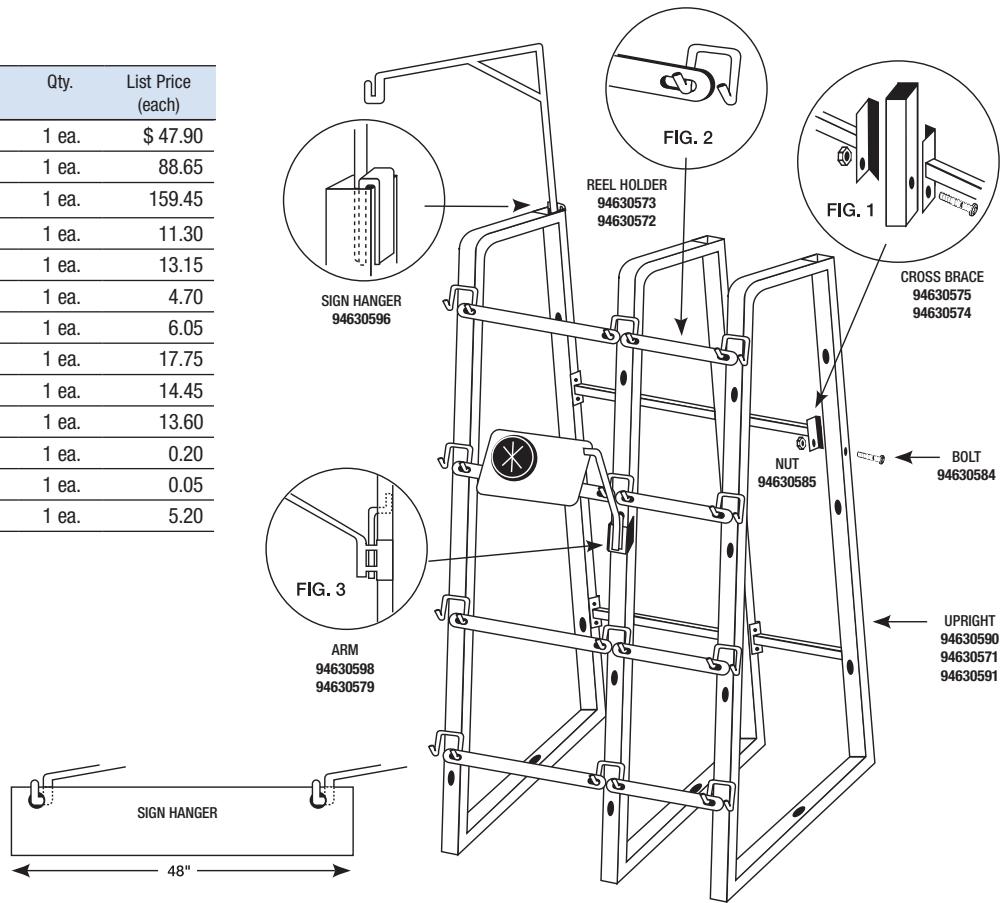

*The wetted surface of this product contacted by consumable water contains less than 0.25% of lead by weight.
Consult factory for ordering code numbers of special models/options.

Tubing (Chemical Resistance Characteristics)

Chemical Resistance Characteristics Of Polyethylene (Milky White) Excellent Resistance

Acetamide	Calcium Hypochloride	Formaldehyde (40%)	Oxalic Acid (Sat.)	Sodium Benzoate (35%)
Acetic Acid (100%)	Calcium Nitrate (50%)	Formic Acid (100%)	Palmitic Acid	Sodium Bicarbonate (Sat.)
Acrylic Emulsions	Calcium Sulfate	Fructose (Sat.)	Perchloric Acid (10%)	Sodium Bisulfate (Sat.)
Adipic Acid	Carbozole	Fruit Pulp	Phenol (50%)	Sodium Bisulfite (Sat.)
Alanine	Carbon Dioxide Wet/Dry (100%)	Gallic Acid (Sat.)	Phosphorous Pentoside (100%)	Sodium Bromide (Conc.)
Allyl Alcohol	Carbone Monoxide	Gin	Phosphorous Trichloride (100%)	Sodium Carbonate
Aluminum Chloride (Cons.)	Carbonic Acid	Glucose	Photographic Solutions	Sodium Chlorate (Sat.)
Aluminum Fluoride (Conc.)	Castor Oil	Glycerine	Pickling Baths:	Sodium Chloride (Sat.)
Aluminum Hydroxide	Cellosolve Acetate	Glycols	Sulfuric Acid, Hydrochloric Acid	Sodium Cyanide
Aluminum Sulfate (Conc.)	Ceslum Salts	Glycolic Acid (30%)	Sulfuric-Nitric	Sodium Dichromate (Sat.)
Alums (All Types Conc.)	Chloride Water (Sat.)	Grape Sugar (Sat.)	Picric Acid (1%)	Sodium Ferricyanide (Sat.)
Amino Acids	Chromic Acid (50%)	Hydrobromic Acid (50%)	Plating Solutions:	Sodium Ferrocyanide (Sat.)
Ammonia Dry Gas (100%)	Chrome Alum (Sat.)	Hydrochloric Acid (40%)	Brass, Cadmium, Chromium, Copper	Sodium Fluoride (Sat.)
Ammonium Acetate (Sat.)	Cider	Hydrocyanic Acid (Sat.)	Gold, Indium, Lead, Nickel, Rhodium	Sodium Hexametaphosphate
Ammonium Carbonate	Citric Acid	Hydrofluoric Acid (60%)	Silver, Tin, Zinc	Sodium Hydroxide
Ammonium Chloride (Sat.)	Coconut Oil	Hydrogen (100%)	Potassium Bicarbonate (Sat.)	Sodium Hypochlorite
Ammonium Fluoride (Sat.)	Cottonseed Oil	Hydrogen Chloride Gas (Dry)	Potassium Borate (1%)	Sodium Nitrate
Ammonium Hydroxide (Conc.)	Cupric Chloride (Sat.)	Hydrogen Peroxide (30%)	Potassium Bromate (10%)	Sodium Sulfate
Ammonium Metaphosphate (Sat.)	Cupric Cyanide (Sat.)	Hydrogen Phosphide (100%)	Potassium Bromide (Sat.)	Sodium Sulfide (Sat.)
Ammonium Nitrate (Sat.)	Cupric Fluoride (Sat.)	Hydroquinone	Potassium Carbonate	Sodium Sulfite
Ammonium Oxalate	Cupric Nitrate (Sat.)	Hydrogen Sulfide	Potassium Chlorate (Sat.)	Sour Crude
Ammonium Sulfate (Sat.)	Cupric Sulfate	Hypochlorous Acid (Conc.)	Potassium Chloride (Sat.)	Stannous Chloride (Sat.)
Ammonium Sulfide (Sat.)	Cuprous Chloride (Sat.)	Inks	Potassium Chromate (40%)	Stannic Chloride (Sat.)
Aniline	Cyclohexane	Isopropyl Acetate	Potassium Dichromate (Sat.)	Starch Solution (Sat.)
Antimony Salts	Detergents, Synthetic	Isopropyl Alcohol	Potassium Cyanide (Sat.)	Stearic Acid (100%)
Arsenic Acid (80%)	Developers, Photographic	Lactic Acid	Potassium Ferri/Ferro Cyanide (Sat.)	Sulfur
Arsenic Salts	DeXtrin	Latex	Potassium Fluoride	Sulfuric Acid To 70%
Barium Carbonate (Sat.)	Dextrose	Lead Salts	Potassium Hydroxide	Sulfur Dioxide
Barium Chloride (Sat.)	Diethyl Ketone	Lithium Salts	Potassium Nitrate (Sat.)	Sulfur Salts
Barium Hydroxide	Dimethyl Formamide	Magnesium Carbonate (Sat.)	Potassium Perborate (Sat.)	Sulfurous Acid
Sulfate (Sat.)	Dimethyl Sulfoxide	Magnesium Chloride (Sat.)	Potassium Perchlorate (10%)	Tallow
Barium Sulfide (Sat.)	Dipropylene Glycol	Magnesium Hydroxide (Sat.)	Potassium Permanganate (20%)	Tannic Acid (Conc.)
Beer	Disodium Phosphate	Magnesium Nitrate (Sat.)	Potassium Sulfate (Conc.)	Tartaric Acid (Sat.)
Benzenesulfonic Acid (10%)	Diazo Salts	Malic Acid (10%)	Potassium Sulfide (Conc.)	Triethylene Glycol
Benzoic Acid (Sat.)	Emulsions, Photographic	Mercuric Chloride (Sat.)	Potassium Sulfite (Conc.)	Tripropylene Glycol
Benzyl Acetate	Ethyl Acetate (100%)	Mercuric Cyanide (Sat.)	Potassium Persulfate (Sat.)	Trisodium Phosphate
Bismuth Salts	Ethyl Alcohol (100%)	Mercurous Nitrate (Sat.)	Propargyl Alcohol	Turkey Red Oil
Bleach Lye (10%)	Ethyl Benzoate	Mercury	Propyl Alcohol	Undacyl Alcohol
Boric Acid	Ethyl Cyanoacetate	Methyl Alcohol (100%)	Propylene Glycol	Urea
Boron Salts	Ethyl Lactate	Methyl Isobutyl Ketone	Resorcinol	Urine
Brine	Ethylene Glycol	Methyl Propyl Ketone	Salicylaldehyde	Vinegar
N-Butyl Acetate (100%)	Fatty Acids	Methyl Sulfuric Acid	Salicylic Acid	Vanilla Extract
N-Butyl Alcohol (100%)	Ferric Chloride (Sat.)	Milk	Salt Solutions	Wetting Agents
Iso-Butyl Alcohol (100%)	Ferric Nitrate (Sat.)	Molasses	Sea Water	Whiskey
Butanediol	Ferrous Chloride (Sat.)	Nickel Chloride (Sat.)	Selinic Acid	Wines
Cadmium Salts	Ferrous Sulphate	Nickel Nitrate (Conc.)	Shortening	Yeast
Calcium Hydroxide	Fish Solubles	Nickel Sulfate (Sat.)	Silver Acetate	Zinc Chloride (Sat.)
Calcium Bisulfide	Fluoboric Acid	Nicotine (Dilute)	Silver Nitrate	Zinc Stearate
Calcium Carbonate (Sat.)	Fluosilicic Acid (Conc.)	Nicotinic Acid (55%)	Silver Salts	Zinc Sulfate (Sat.)
Calcium Chlorate (Sat.)	Fluorides	N-Octane	Soap Solution	
Calcium Chloride (Sat.)	Freon 12	Orange Extract	Sodium Acetate (Sat.)	

Fair To Good Resistance

Acetaldehyde	Chlorine Gas (100%)	Fluorine	Methyl Ethyl Ketone (100%)	Ozone
Acetone	Chloroform (100%)	Fuel Oil	Methylene Chloride (100%)	Petroleum Ether
Ammonia Liquid	Cyclohexanone	Furfural (100%)	Mineral Oils	Propylene Dichloride
Amyl Acetate (100%)	Decalin	Furfural Alcohol	Naphtha	Sulfuric Acid (80%)
Benzene	Diocylphthalate	Heptane	Naphthalene	Tetrahydrofuran
Bromine Water	Ethyl Bromide	Iodine	Nitric Acid (70%)	Transformer Oil
Camphor Oil	Ethyl Chloride	Linseed Oil	Oils And Fats	Trichloroethylene
Chloroacetic Acid (100%)	Ethylene Oxide	Methyl Bromide	Oleic Acid	

Poor Resistance

Amyl Chloride (100%)	Carbon Disulfide	O-Dichlorobenzene	Hexane	Thionyl Chloride
Aqua Regia	Carbon Tetrachloride	P-Dichlorobenzene	Nitrobenzene (100%)	Trichloroethane
Benzaldehyde	Cedarwood Oil	Diethyl Benzene	Lube Oil	Trichloroethylene
Benzyl Alcohol	Chlorine Liquid	Ether	Perchloric Acid	Vinylidene Chloride
Bromine Gas/Liquid	Chlorobenzene	Ethyl Benzene	Perchloroethylene	
Bromobenzene	Chlorosulfonic Acid	Ethyl Butyrate	Sulfur Dioxide (40 Psi)	
Butadiene	Cinnamon Oil	Ethyl Chloride	Sulfuric Acid (96%)	
Butyric Acid	Cresol	Ethylene Chloride	Sulfuric Acid, Fuming	

*The wetted surface of this product contacted by consumable water contains less than 0.25% of lead by weight.

Consult factory for ordering code numbers of special models/options.

Tubing (Chemical Resistance Characteristics)

Chemical Resistance Characteristics Of Vinyl Or Pvc (Clear Tubing) Excellent Resistance

Acetic Acid	Essential Oils	Oil
Air	Ethyl Alcohol	Oxalic Acid
Alcohols	Ethyl Chloride	Oxygen
Aluminum Chloride	Ethylene Glycol	Palmitic Acid
Aluminum Sulphate	Fatty Acid	Picric Acid
Alums	Ferric Chloride	Phosphoric Acid
Ammonia Gas	Ferric Sulphate	Potassium Chloride
Ammonium Chloride	Fluoboric Acid	Potassium Sulphate
Ammonium Nitrate	Fluosilicic Acid	Propane
Ammonium Phosphate	Formic Acid	Pyrethrum
Ammonium Sulphate	Formaldehyde	Sodium Bisulfite
Amyl Alcohol	Freon	Sodium Bicarbonate
Animal Oils	Gallic Acid	Sodium Borate
Antimony Salts	Gas (Natural)	Sodium Carbonate
Arsenic Salts	Gasoline (Non-Aromatic)	Sodium Chloride
Barium Salts	Gelatin	Sodium Cyanide
Basic Copper Arsenate	Glue (Depending On Type)	Sodium Hydroxide
Beer	Glucose	Sodium Hypochlorite
Benzoic Acid	Glycerine	Sodium Nitrate
Benzyl Alcohol	Hydrochloric Acid	Sodium Phosphate
Boric Acid	Hydrocyanic Acid	Sodium Silicate
Boric Copper Sulphate	Hydrofluoric Acid	Sodium Sulphide
Bordeaux Mixture	Hydraulic Oil	Sodium Sulphate
Butanol	Hydrogen Gas	Sodium Thiosulphate
Butter	Hydrogen Peroxide (Dil.)	Stearic Acid
Calcium Hydroxide	Hydrogen Sulphide	Stannous Chloride
Calcium Hypochlorite	Lactic Acid	Sulphur Dioxide
Calcium Salts	Lard	Sulphuric Acid (Dil.)
Carbolic Acid	Lead Arsenate	Sulphurous Acid
Carbon Monoxide	Lead Sulphate	Tannic Acid
Corn Oil	LimE	Tartaric Acid
Cottonseed Oil	Linseed Oil	Tar Oil
Caustic Potash (-20%)	Magnesium Chloride	Trupentine
Caustic Soda (-20%)	Magnesium Hydroxide	Urea
Chloroform	Magnesium Sulphate	Uric Acid
Chromic Acid	Maleic Acid	Vinegar
Chlorine (Dry)	Milk	Water
Chlorine (Water)	Mineral Oil	Whiskey
Chromium Salts	Molasses	Wine
Copper Chloride	Nickel Chloride	Wool Oil
Copper Sulphate	Nicotine	Zinc Chloride
Citric Acid	Nitric Acid 20%	Zinc Hydrate
Cresylic Acid	Nitrogen Oxide	Zinc Sulphate
Cupric Sulphate	Nitrous Acid	

Fair To Good Resistance

Aniline	Caustic Soda (+20%)	Pentane
Benzene	Chlordane	Perchloric Acid
Benzol	Creosote	Perchloroethylene
Borax	Ether	Phenolates
Butane	Gasoline (Aromatic)	Phenols
Bromine	Hydrogen Peroxide (Conc.)	Stoddard Solvent
Calcium Bisulphide	Kerosene	Sulphuric Acid (Conc.)
Calcium Chloride	Mercuric Chloride	Trichloroethylene
Carbon Tetrachloride	Oleic Acid	Trichloroacetic Acid
Caustic Potash (+20%)		

Poor Resistance

Acetic Anhydride	Chloroacetic Acid	Lacquer Solvents
Acetone	Cresols	Naphtha
Acetyl Bromide	Cyclohexanone	Nitrobenzene
Acetyl Chloride	Ethyl Acetate	Paint Solvents
Ammonium Hydroxide	Ethylene Dichloride	Pyridine
Amyl Acetate	Fuel Oil (Aromatic Gas)	Toluene
Aromatic Hydrocarbons	Fuel Oil (Aromatic Gas)	Toluol
Butyl Acetate	Isopropyl Acetate	Xylol
Carbon Bisulfide	Ketones	Xylene

The above table and recommendations are accurate to the best of our knowledge. No guarantees are expressed or implied.

*The wetted surface of this product contacted by consumable water contains less than 0.25% of lead by weight.

Consult factory for ordering code numbers of special models/options.

It Pays to Buy and Sell the Whole Watts Line!

The Watts line offers tremendous leverage to the stocking wholesaler because of its breadth and versatility. Plus, with a continuous stream of new and innovative products, you have the opportunity to profit from the creative engineering and manufacturing expertise for which Watts has been known since 1874.

Notes

Notes

Notes

Notes

For Technical Assistance Call Your Authorized Watts Representative.

			Telephone	E-mail
	HEADQUARTERS: Watts Water Technologies	815 Chestnut St., North Andover, MA 01845-6098 U.S.A.	978 688-1811	watts@wattswater.com
North East	Edwards, Platt & Deely, Inc.	277 Royal Ave., Hawthorne, NJ 07506	973 427-2898	p044@watts.com
	Edwards, Platt & Deely, Inc.	368 Wyandanch Ave., North Babylon, NY 11703	631 253-0600	p073@watts.com
	Vernon Bitzer Associates, Inc.	980 Thomas Drive, Warminster, PA 18974	215 443-7500	P009@watts.com
	WMS Sales, Inc. (Main office)	9580 County Rd., Clarence Center, NY 14032	716 741-9575	p091@watts.com
	W. P. Haney Company, Inc.	51 Norfolk Ave., South Easton, MA 02375	508 238-2030	p088@watts.com
Mid Atlantic	Disney McLane & Associates	428 McGregor Ave., Cincinnati, OH 45206	800 542-1682	p017@watts.com
	J. B. O'Connor Company, Inc.	P.O. Box 12927, Pittsburgh, PA 15241	724 745-5300	p047@watts.com
	The Joyce Agency, Inc.	3933 Avion Park Court Suite B102B, Chantilly, VA 20151	703 866-3111	p069@watts.com
South East	Francisco J. Ortiz & Co., Inc.	Charlyn Industrial Pk., Road 190 KM1.9 - Lot #8, Carolina, Puerto Rico 00983	787 769-0085	fjortiz@wntpr.com
	Mid-America Marketing, Inc.	203 Industrial Drive, Birmingham, AL 35211	205 879-3469	p032@watts.com
	Mid-America Marketing, Inc.	2611 Grandview Avenue, Nashville, TN 37211	615 259-9944	john@midamericamktg.com
	Mid-America Marketing, Inc.	5466 Old Hwy. 78, Memphis, TN 38118	901 795-0045	sales@midamericamktg.com
	Smith & Stevenson Co., Inc.	4935 Chastain Ave., Charlotte, NC 28217	704 525-3388	p003@watts.com
	Harry Warren, Inc.	1400 North Orange Blossom Trail, Orlando, FL 32804	407 841-9237	p071@watts.com
North Central	Harry Warren, Inc.	2861-B Bankers Industrial Drive, Atlanta, GA 30360	770 209-3310	p059@watts.com
	Dave Watson Associates	1325 West Beecher, Adrian, MI 49221	517 263-8988	p085@watts.com
	Mid-America Marketing Services Ltd.	1275 Lakeside Drive, Romeoville, IL 60446	630 953-1211	p072@watts.com
	Soderholm & Associates, Inc.	7150 143rd Ave. N.W., Ramsey, MN 55303	763 427-9635	company@soderholmrep.com
South Central	Soderholm & Associates, Inc.	W 140 N5086 Lilly Road, Menomonee Falls, WI 53051	763 427-9635	company@soderholmrep.com
	Billingsley-BWC	2728 Crestview Ave., Kenner, LA 70062-4829	504 602-8100	p013@watts.com
	Billingsley-BWC	478 Cheyenne Lane, Madison, MS 39110	601 856-7565	ckenny@billingsley.com
	Hugh M. Cunningham, Inc.	2029 Westgate Drive, Suite 120, Dallas, TX 75006	972 852-3441	hughcunningham.com
	Sandia Group, Inc.	902 W. Hadley Ave. Las Cruces, NM 88005	800 339-0191	p131@watts.com
	Sandia Group, Inc.	2915 Girard Blvd. NE, Albuquerque, NM 87107	800 339-0191	p005@watts.com
	Mack McClain & Associates, Inc.	4407 Meramec Bottom, Suite G, St. Louis, MO 63129	314 894-8188	p045@watts.com
	Mack McClain & Associates, Inc.	1045 76th St., Suite 1000, West Des Moines, IA 50266	515 288-0184	p049@watts.com
	Mack McClain & Associates, Inc.	15090 West 116th St., Olathe, KS 66062	913 339-6677	p083@watts.com
	OK! Sales, Inc.	214 NE 12th. St., Ste A, Moore, OK 73160	405 794-5200	p015@watts.com
Western	Delco Sales, Inc.	5375 E. Hunter Ave., Anaheim, CA 92807	714 888-2444	sales@delcosales.com
	Delco Sales, Inc.	111 Sand Island Access Rd., Unit I-4, Honolulu, HI 96819	808 842-7900	p021@watts.com
	Rocky Mountain Sales, Inc.	6765 Franklin St., Denver, CO 80229-7111	303 289-4191	info@rockymountainsales.com
	Hollabaugh Brothers & Associates	6915 South 194th St., Kent, WA 98032	253 867-5040	p001@watts.com
	Hollabaugh Brothers & Associates	3028 S.E. 17th Ave., Portland, OR 97202	503 238-0313	p006@watts.com
	P I R Sales, Inc.	3050 North San Marcos Place, Chandler, AZ 85225	480 892-6000	sales@pirsales.com
	REPCOR	2455 Mercantile Drive, Ste.100, Rancho Cordova, CA 95742	916 386-2233	sales@repcor1.com
	R. E. Fitzpatrick Sales, Inc.	4109 West Nike Dr. (8250 South), West Jordan, UT 84088	801 282-0700	p007@watts.com
Canada	Watts Water Technologies (Canada) Inc.	5435 North Service Road, Burlington, Ontario L7L 5H7	905 332-4090	info@wattscanada.ca
1518	EXPORT Hdqtrs.: Watts Water Technologies	815 Chestnut St., North Andover, MA 01845-6098 U.S.A.	978 688-1811	watts@wattswater.com



A Watts Water Technologies Company

USA: Tel: (978) 688-1811 • Fax: (978) 794-1848 • watts.com

Canada: Tel: (905) 332-4090 • Fax: (905) 332-7068 • watts.ca

Latin America: Tel: (52) 81-1001-8600 • watts.com