



Quality Tools for Smart Cleaning



PRODUCT ASSORTMENT & PRICE LIST 2014

Valid from 01.01.2014

EN / DPRDE





50 YEARS OF PROFESSIONAL QUALITY

In 1964, a young window cleaner decided that he would take a chance. It was in that year that Henry Unger took the latest window cleaning innovations from the United States and introduced them to German window cleaners. With the unwavering support of his wife, he launched his new business from his grandmother's attic in Hamburg. From this dream, a business that now spans the globe was born. Henry's discerning eye for quality products and tireless pursuit of new and better ways to clean still serve as inspiration for **UNGER**, and continue through his three sons, who reaffirm their father's core values of quality, trust and customer service in **UNGER** today.

The fact that Henry Unger started as a window cleaner gave him the deep understanding and knowledge that would drive the business from its humble Hamburg beginning to the global company that **UNGER** is today. Today, we continue to build on Henry's belief that knowing your customers is the only way to serve them. A key to our success has always been working in partnership with cleaning professionals to develop the very best cleaning solutions that deliver the right results, every time. Our customer's priorities are **UNGER's** priorities – we share the same goals in wanting to make cleaning better, easier and more efficient. Together with our customers, we are shaping the next generation of cleaning solutions.



THE 50TH ANNIVERSARY EDITION

As a special "Thank you" for all faithful customers over last 50 years we offer an exclusive and limited product range as well as nice "50 years" branded clothes.

1 ErgoTec® SQUEEGEE



- Green soft rubber
- Premium grey colour with metallic effect and 50 years laser engraved stamp
- Ergonomic bi-component handle
- S-Spring for quick replacement of rubber and channel

ESA30	30 cm	5 Pack	14,86 €/pcs
ESA35	35 cm	5 Pack	16,08 €/pcs
ESA45	45 cm	5 Pack	17,48 €/pcs

2 SQUEEGEE RUBBER "SOFT" GREEN

- Highly durable and efficient
- Sharp edges enable thorough wiping for superior finish

RR30V	30 cm	10 Pack	2,04 €/pcs
RR35V	35 cm	10 Pack	2,16 €/pcs
RR45V	45 cm	10 Pack	2,32 €/pcs

3 ErgoTec® WASHER



- Premium grey colour with metallic effect and 50 years logo on velcro tag
- Ergonomic bi-component handle with water wells
- High performance Ninja sleeve Highly absorbent material with built-in scrub pad, superior cleaning performance with minimum effort

EHA35	35 cm	5 Pack	18,16 €/pcs
-------	-------	--------	-------------

LIMITED EDITION
exclusive
2014

1 ErgoTec® SQUEEGEE



2 SQUEEGEE RUBBER "SOFT" GREEN
in stock from 01.04.14



3 ErgoTec® WASHER



4 ErgoTec® KIT



- Includes all 50 years anniversary products including BUCKET ON A BELT, ErgoTec® Squeegee and ErgoTec® Washer (35 cm)
- High value grey color with metallic effect
- Bucket fits 1 washer, 2 squeegees, 1 scraper
- Ideal for use indoors or in narrow spaces, clip for quick fastening

EKA30	30 cm	1 Pack	48,50 €/pcs
EKA35	35 cm	1 Pack	48,90 €/pcs
EKA45	45 cm	1 Pack	49,90 €/pcs



SOFTSHELL JACKET

Versatile, wind resistant and water repellent jacket with warm lining for greater comfort. Features two zipped handwarmer pockets and one zipped chest pocket.

WW053	L	1 Pack	39,90 €/pcs*
WW054	XL	1 Pack	39,90 €/pcs*
WW055	XXL	1 Pack	39,90 €/pcs*



HOODIE

Practical hooded jacket with two front kangaroo pockets and inner headphone pocket.

WW056	L	1 Pack	29,90 €/pcs*
WW057	XL	1 Pack	29,90 €/pcs*
WW058	XXL	1 Pack	29,90 €/pcs*



SOFTSHELL WAISTCOAT

Wind resistant and water repellent waistcoat with warm lining for greater comfort. Features two zipped handwarmer pockets and one zipped chest pocket.

WW050	L	1 Pack	29,90 €/pcs*
WW051	XL	1 Pack	29,90 €/pcs*
WW052	XXL	1 Pack	29,90 €/pcs*



BEANIE

Warming knit hat with 50 years anniversary logo

WW059	One Size	1 Pack	9,90 €/pcs*
-------	----------	--------	-------------



Fits on Locking Cone for secure fit on telescopic pole.

*Special terms of payment apply

TABLE OF CONTENT

PRODUCT ASSORTMENT

WINDOW CLEANING

Introduction..... 6

HiFlo™ WATER FED POLE SYSTEMS

Overview **HiFlo™** Water Fed Pole System 8

A: Water Fed Pole Systems 10

B: Brushes..... 11

C: Goosenecks..... 11

D: Pure Water Filter 11

A: HiFlo™ Water Fed Pole System

- **LITE**
 - Introduction 12
 - A: Master Poles, Extensions & Spare Parts 14
 - B: Brushes..... 17
 - C: Goosenecks..... 19
- **CARBONTEC**
 - Introduction 20
 - Modular Poles & Accessories..... 20
 - Spare Parts..... 21
- **ADVANCE**
 - Introduction 22
 - Telescopic Poles..... 22
 - Spare Parts..... 23

B: HiFlo™ Brushes..... 25

C: HiFlo™ Goosenecks..... 26

D: HiFlo™ Pure Water Filter

- RO Filter 28
- RO Filter Spare Parts..... 30
- DI Filter..... 32
- DI Filter Spare Parts 34
- Accessories 37

CLASSICAL WINDOW CLEANING

Introduction Classical Window Cleaning
Icons and Overview..... 38

ERGOtec® NINJA System 40

Squeegees 41

Washers..... 46

Indoor Cleaning..... 50

Telescopic Poles..... 52

Adapters & Maintenance 55

Scrapers 56

Cloths..... 58

Gloves 59

Belts & Pouches..... 60

Buckets & Soap 62

Cleaning Sets 63



LITTER PICKING & REACHING AIDS

Introduction.....	64
Waste Collection	
NIFTYNABBER® Bagger	64
Paper Picker	65
Grabber	
NIFTYNABBER® Pro.....	65
NIFTYNABBER® Trigger.....	65



MAINTENANCE

Introduction.....	66
Floor Cleaning	
Floor Squeegees	68
Floor Handles	71
Floor Scrapers.....	72
Double Bucket & Mopholder.....	73
Microfibre Mops	74
Mophandles, Brushes, Sets	75
Microfibre Cloth System	
Microfibre Cloths, Grading System.....	76
Cloths & Sprayer	77
Restroom Cleaning	
Toilet Cleaning.....	78
Surface Cleaning	78
Inspection Tools	78
Dusting & Brushes	
Brushes & Dusters.....	80
Microfibre Dusters	81



p. XXX **Quick Productfinder**



p. XXX **Further Information**



Professional Window Cleaning

50 years expertise – expert solutions – best service

UNGER is driven to continually develop new products that offer real value to cleaning professionals. All products are customer-oriented developed and approved by customers, before going to the market. The past 50 years have been filled with major milestones, many of which you will find in this catalogue.

MARKET LEADER UNGER has gained considerable international reputation as leading manufacturer of professional cleaning and maintenance tools. Cleaning contractors in more than 80 countries around the world trust in **UNGER** quality.

UNGER BRAND STANDS FOR

- INNOVATION
- QUALITY
- SERVICE

Every **UNGER** product is designed with end user safety, comfort and efficiency in mind.

100% Customer Satisfaction Guarantee

At **UNGER**, we aim to stand apart from the rest thanks to our special “Yes We Can!” service spirit. We love what we do and as proof of that, we promise to deliver a 100% Customer Satisfaction Guarantee on every product and service we offer.

This ensures that every **UNGER** product you purchase meets your high standards – or you can return it for a replacement or refund.

We have been manufacturing cleaning products and systems since 1964. In that time we’ve learned a lot about what makes great tools. Plus, we listen to your feedback – all of it. You can count on everything we offer to be highly functional and provided with an exceptional service level at all times. Which means you can’t go wrong with products from **UNGER**, this is our promise to you... or you get your money back.



WINDOW CLEANING

HiFlo™ WATER FED POLE SYSTEMS

WATER FED – PURE WATER: applied with water fed pole system such as **HiFlo™** is the most efficient way of cleaning at heights of up to 20 m safely from the ground. What’s more, it requires no chemicals or drying the glass – saving time and money!

MULTI COMPONENT SYSTEM: A **HiFlo™** System is a modular system. The individual items can be chosen and combined according to the working requirements.

TYPICAL APPLICATIONS: Residential or commercial window cleaning, large areas of glass, building facades, vehicles, signs and solar panels.

CLASSICAL WINDOW CLEANING

CLEANING TOOLS: Traditional handheld tools, designed to meet the demands of the professional window cleaning industry.

TYPICAL APPLICATIONS: Suitable for most types of window and glass cleaning, outdoors or indoor. Perfect for hard to reach areas and low level cleaning.

WINDOW CLEANING > WATER FED POLE SYSTEMS

HiFLO™

The innovative Water Fed Pole Cleaning System from UNGER

TYPICAL APPLICATIONS



WINDOW AND FACADE CLEANING:

- Fast and effective method – great results!
- Easy access to hard to reach areas



PV- AND SOLAR PANEL CLEANING:

- Solar yield can be increased by up to 30%!
- Regular cleaning prevents build up of dirt for greater energy output
- Cleaning with 100% pure water leaves no streaks or detergent residue

ADVANTAGES



SAFETY

- **UNGER** Pole Systems allow to clean at heights of up to 20 m safely from the ground
- No need to use dangerous ladders or hire expensive equipment

LABOUR EFFICIENCY

- One step cleaning – no need to dry windows
- Large areas can be cleaned faster than using traditional methods

ECONOMIC BENEFITS

- Improved safety = lower insurance cost
- Greater efficiency – more work can be done in the same time
- No need to use expensive chemicals – good for environment too!



PERFECTLY MATCHED

HiFlo™ is a modular system. The individual components can be selected and put together to create a unique system to suit personal requirements.

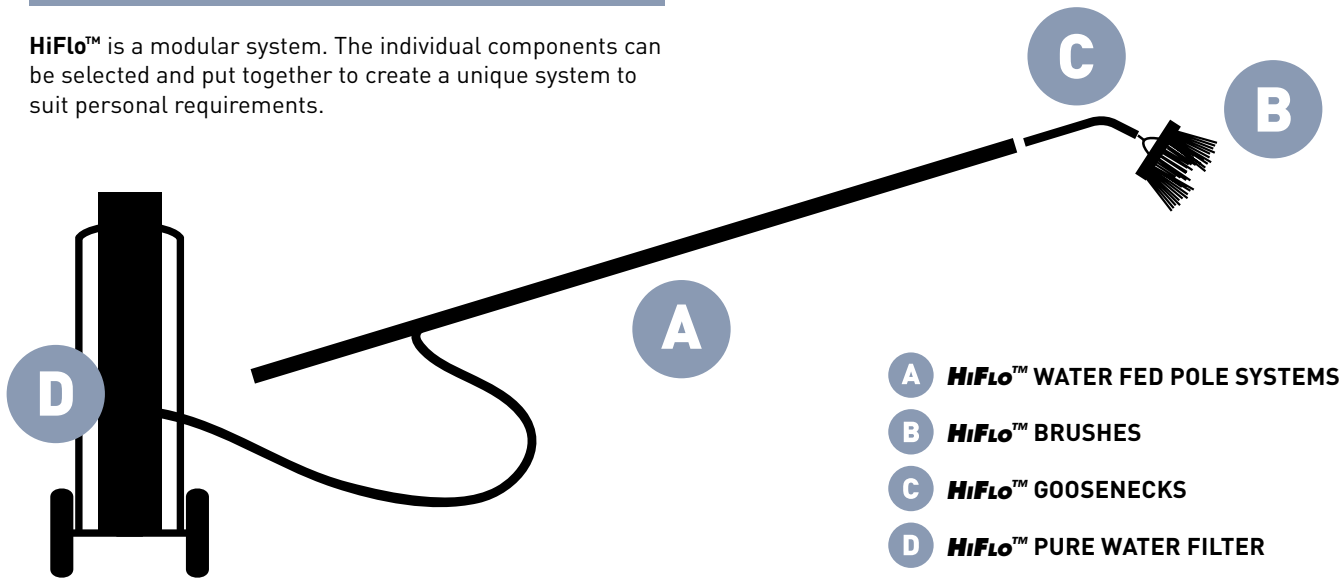

- A HiFlo™ WATER FED POLE SYSTEMS**
- B HiFlo™ BRUSHES**
- C HiFlo™ GOOSENECKS**
- D HiFlo™ PURE WATER FILTER**

A HiFlo™ WATER FED POLE SYSTEMS

CHOSING THE POLE

When selecting the pole, the following points have to be considered:

- required pole height – greater heights require poles with greater rigidity
- duration of the job – the longer you work, the lighter pole you need to reduce fatigue.

MODULAR, TELESCOPIC OR EVEN BOTH!

The overview of each pole type below will help you to identify the best system for any cleaning challenge.

M Modular Poles – individual sections can be added to each other to build up the pole to required reach.

T Telescopic Poles. Available in different lengths and materials. Easy and quick change of length.

T&M TeleMod Poles – the best of both! Telescopic Master Pole can be further extended by adding one or several telescopic Extension Poles. This means that operator holds minimum required weight and length of the pole at any time, with a flexibility to quickly increase the reach at any time.

SELECTING THE RIGHT MATERIAL

HIMOD ULUS CARBON

HiM The ultimate in rigidity, super light pole.

CARBON

CAR 100% carbon fibre pole. Superior rigidity.

HYBRID

HYB Glass Fibre / Carbon Composite Pole. Excellent rigidity and value.

GLASS FIBRE

GLA High rigidity and maximum working comfort.

ALU

ALU Aluminium pole with excellent rigidity thanks to modern construction technology.

WINDOW CLEANING > WATER FED POLE SYSTEMS

nLiTETM HiFlo



UK, Birmingham, Cleaning Show 2013
USA, Chicago, ISSA InterClean 2012
2012 ISSA INNOVATION AWARD
Supplier Category Winner



A HiFloTM WATER FED POLE SYSTEMS

nLiTETM HiFlo

TELESCOPIC & MODULAR
WATER FED POLE SYSTEM

With 5 grades of material to choose from, **HiFloTM nLiTE** provides perfect balance between weight and rigidity. The four section Master Pole can be used on its own, or in combination with Extension Pole(s) for greater reach. Crucially, the Extension Poles don't add anything to the width, grip and feel of the Pole which always measures 35 mm in diameter – an optimum size that fits easily into the hands of the professional for quick and comfortable cleaning.

- **HiFloTM nLiTE** meets the highest standards in terms of comfort, value and cleaning results
- **HiFloTM nLiTE** is the ultimate system for professional and No. 1 in Europe

T&M max. 20 m **HiM** **CAR** **HYB** **GLA** **ALU**



p. 14

CARBONTEC MODULAR WATER FED POLE SYSTEM

This Award Winning modular water fed Pole System with internal hose in every section, capable of reaching heights up to 15 metres. It's every pole size you will ever need, in one portable Gear Bag that you can carry.

M max. 15 m **CAR**



p. 20

ADVANCE TELESCOPIC WATER FED POLE SYSTEM

These durable glass and carbon fibre Poles with internal hose, extending up to 20 metres high, are light, very strong and offer optimum Pole stiffness and Brush control. Perfect for users who have frequent high level cleaning jobs or long periods of continual Pole work.

T max. 20 m **CAR** **HYB** **GLA**



p. 22

B **HiFlo™ BRUSHES**



p. 17

Superlight **UNGER** Brushes are designed to get into the smallest corners and effectively lift dirt from the surfaces with scrubbing action. Depending on the cleaning task, you can choose from universally applicable rectangular shaped brush or radius brush, designed for easy cleaning of sills and other angled objects.

Brush Bristles types:

NATURAL BOAR BRISTLE: Coarse to the touch, naturally split along the length, each fibre cleans the surface with its entire body, effectively removing dirt from the tiniest of crevices.

POLYESTER BRISTLES are highly durable, with a choice of flagged or unflagged structure.

YELLOW POLYESTER, featured on solar brushes, will remove even stubborn dirt yet are gentle enough not to damage delicate surface of the PV-/Solar panels.

C **HiFlo™ GOOSENECKS**



p. 19

Strong yet lightweight angle adapters enable you to achieve any working angle, keeping weight to a minimum.

D **HiFlo™ PURE WATER FILTER**

REVERSE OSMOSIS FILTERS (RO)



These filter apply mechanical filtration process, where water is purified of minerals by being pushed under pressure through a semi-permeable Reverse Osmosis membrane.

Despite comparatively substantial set up cost, RO filters require minimal maintenance and offer a cost-effective way for constant, high volume production of pure water.

Mobile for immediate set up anywhere with electricity and tap water supply.

Incoming water is split into pure and waste water during filtration process, requiring drainage facility for waste water.

p. 28

DEIONISATION FILTERS (DI)



These filters utilise ion exchange resins which removes ionised salts from water, producing 100% deionised water.

Though DI filters require relatively inexpensive initial investment, regular repurchase of the new resin is necessary for pure water production.

Mobile for immediate set up anywhere – all you need is tap water supply.

All generated water can be consumed.

p. 32



Evolutionary Pole Technology for Professionals







- **Innovative engineering**
- **Ease of use**
- **Adaptability**

Light, modular and easy to use. Our HiFlo™ nLite System sets a new benchmark in professional cleaning technology. The use of modern materials delivers perfect balance between weight and rigidity. With 5 different mix and match pole materials, the HiFlo™ nLite System is the perfect choice for every cleaning challenge and budget. "Made in Germany", of course.

- The Length Deflection Ratio (LDR) has been developed to provide a quantifiable way of measuring the perfect balance between length and rigidity of water fed poles.
- Strong carbon angle adapters enable you to achieve any working angle, keeping weight to a minimum.
- Superlight Brushes feature high quality polyester or natural bristles designed to get into the smallest corner and help with scrubbing actions. With up to 12 different Jet locations, depending on the Brush size, hundreds of spray patterns are possible.

The perfect 4-Step-System:

- A** **nLITE^{HiFlo™} WATER FED POLE SYSTEM**  p. 14
- B** **nLITE^{HiFlo™} BRUSHES**  p. 17
- C** **nLITE^{HiFlo™} GOOSENECKS**  p. 19
- D** **PURE WATER FILTER**  p. 28

i nLITE^{HiFlo™} ONLINE CONFIGURATOR

Build your personal HiFlo™ nLite System at www.ungerglobal.com!



A

mLITE^{HiFlo} WATER FED POLE SYSTEM

MASTER POLE

- Length** 4 sections (Ø 26 / 29 / 32 / 35 mm)
6,63 m/22 ft – or 6,00 m/20 ft or 4,50 m/15 ft.
- Endcap** Durable plastic with rubber insert. Prevents accidental damage to the end of the pole. Features side aperture for Hose.
- Print** Complete specifications, including Length Deflection Ratio for measuring Pole rigidity.
- Clamps** Easy one handed operation to change pole length. Yellow clamps identify the next modular component to prevent unintentional separation.
- Water fed** The water hose can be led inside or outside the pole in guiding clamps.

EXTENSION POLE

- Length** 2 sections (Ø 32 / 35 mm)
3,41 m/11 ft – or 3,00 m/10 ft.
- Application** Add on up to 4 Extension Poles to Master Pole to reach the required height (number of Extension Poles depends on pole material).
- Colour** Yellow visual warning area at the top of Extension Pole helps to avoid unintentional separation from the Master Pole.
- Print** Complete specifications, including Length Deflection Ratio for measuring Pole rigidity.

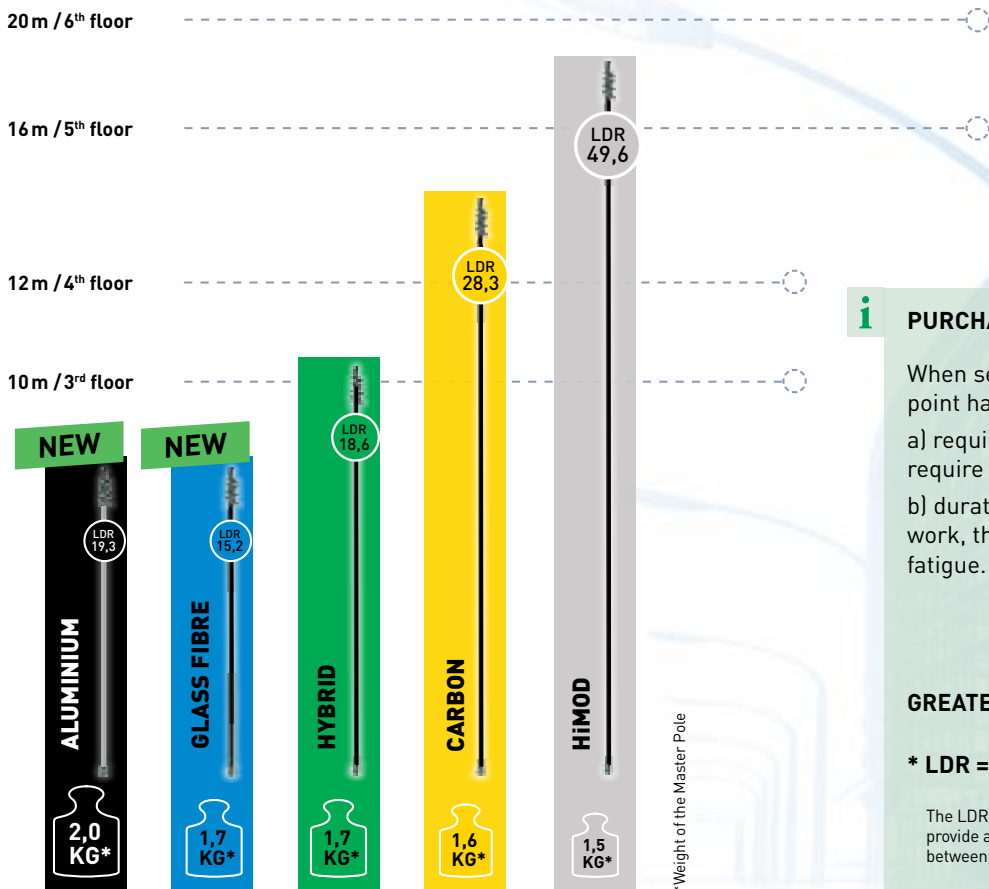

i PURCHASING GUIDE

When selecting the pole, the following point have to be considered:

- a) required pole height – greater heights require poles with greater rigidity.
- b) duration of the job – the longer you work, the lighter pole you need to reduce fatigue.

GREATER LDR VALUE = GREATER RIGIDITY!

* $LDR = \frac{(\text{overall length})^3}{(\text{deflection}) \times (7)^2}$

The LDR (Length Deflection Ratio) has been developed to provide a quantifiable way of measuring the perfect balance between length and rigidity of water fed poles.

*Weight of the Master Pole

WINDOW CLEANING > WATER FED POLE SYSTEM > TELE MOD > **nLITE**^{HiFlo™}

A

nLITE^{HiFlo™} WATER FED POLE SYSTEM

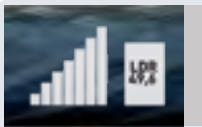

HIMOD CARBON



CARBON



HYBRID



GLASS FIBRE



ALU



NL27A



NL11G



NLBJP



NLBJF



FTG0S

HT67G – Hybrid



Example

HiFlo™ nLITE HYBRID STARTER KIT

Basic equipment for starters.

Part No.	Size ext.	Size short	Elements	Weight	Pack	€/piece
HTK14	6,63 m	1,87 m	4	1,7 kg	1	360,87

HiFlo™ nLITE BAG

For storage, protection and transportation of a complete nLite Kit.

- Made from solid nylon material
- Can be carried in hand or over shoulder
- Fits 5 or more poles, 2 brushes, 1 gooseneck, 1 hose. Extra pocket for spare jets and small pieces
- Bag is not filled

Part No.	Pack	€/piece
NLBA1	1	143,73

HiFlo™ nLITE HIMOD CARBON MASTER POLE							HiFlo™ nLITE HIMOD CARBON EXTENSION POLE						
Telescopic Master Pole. The ultimate in rigidity, superlight pole. Recommended for working at heights of up to 20 m/65 ft. Inkl. Thread Adapter and Endcap							The corresponding Telescopic Extension Pole. Yellow visual warning area to avoid unintentional separation.						
Part No.	Size ext.	Size short	Elements	Weight	Pack	€/piece	Part No.	Size ext.	Size short	Elements	Weight	Pack	€/piece
UC67G	6,63 m	1,87 m	4	1,5 kg	1	826,17	UC35G	3,41 m	1,91 m	2	0,7 kg	1	443,59
HiFlo™ nLITE CARBON MASTER POLE							HiFlo™ nLITE CARBON EXTENSION POLE						
Telescopic Master Pole. Superior rigidity, lightweight pole. Recommended for working at heights of up to 16 m/53 ft. Inkl. Thread Adapter and Endcap							The corresponding Telescopic Extension Pole. Yellow visual warning area to avoid unintentional separation.						
Part No.	Size ext.	Size short	Elements	Weight	Pack	€/piece	Part No.	Size ext.	Size short	Elements	Weight	Pack	€/piece
CT67G	6,63 m	1,87 m	4	1,6 kg	1	515,97	CT35G	3,41 m	1,91 m	2	0,8 kg	1	257,47
HiFlo™ nLITE HYBRID MASTER POLE							HiFlo™ nLITE HYBRID EXTENSION POLE						
Telescopic Master Pole. Excellent rigidity and value. Recommended for working at heights of up to 10 m/35 ft. Inkl. Thread Adapter and Endcap							The corresponding Telescopic Extension Pole. Yellow visual warning area to avoid unintentional separation.						
Part No.	Size ext.	Size short	Elements	Weight	Pack	€/piece	Part No.	Size ext.	Size short	Elements	Weight	Pack	€/piece
HT67G	6,63 m	1,87 m	4	1,7 kg	1	309,17	HT35G	3,41 m	1,91 m	2	0,9 kg	1	154,07
							AK081	1,10 m	0,81 m	2	0,5 kg	1	71,34
HiFlo™ nLITE GLASS FIBRE MASTER POLE							HiFlo™ nLITE GLASS FIBRE EXTENSION POLE						
Telescopic Master Pole. Superior rigidity, lightweight pole. Recommended for working at heights of up to 10 m/35 ft. Inkl. Thread Adapter and Endcap							The corresponding Telescopic Extension Pole. Yellow visual warning area to avoid unintentional separation.						
Part No.	Size ext.	Size short	Elements	Weight	Pack	€/piece	Part No.	Size ext.	Size short	Elements	Weight	Pack	€/piece
GF60G	6,00 m	1,71 m	4	1,7 kg	1	129,00	GF30G	3,00 m	1,69 m	2	0,9 kg	1	79,00
GF45G	4,50 m	1,34 m	4	1,4 kg	1	119,00							
HiFlo™ nLITE ALUMINIUM MASTER POLE							HiFlo™ nLITE ALUMINIUM EXTENSION POLE						
Telescopic Master Pole. Excellent rigidity thanks to modern construction technology. Recommended for working at heights of up to 10 m/35 ft. Inkl. Thread Adapter and Endcap							The corresponding Telescopic Extension Pole. Yellow visual warning area to avoid unintentional separation.						
Part No.	Size ext.	Size short	Elements	Weight	Pack	€/piece	Part No.	Size ext.	Size short	Elements	Weight	Pack	€/piece
AN60G	6,00 m	1,71 m	4	2,0 kg	1	69,00	AN30G	3,00 m	1,69 m	2	1,1 kg	1	42,00
AN45G	4,50 m	1,34 m	4	1,6 kg	1	59,00							

HiFlo™ nLITE TOOL ADAPTER

Plastic adapter for attaching tools on nLite poles.
 - FTTHR: Thread adapter for attaching brushes on the pole
 - HFNLC: Cone adapter for attaching classic window cleaning tools on the pole

Part No.	Pack	€/piece
FTTHR	1	5,07
HFNLC	1	5,90

HiFlo™ nLITE ENDCAP

Plastic protection cap with rubber end.
 - Prevents damage of the lower pole end
 - Side opening for the hose
 - Simply push in the pole and fix with the clamp

Part No.	Pack	€/piece
TMECP	1	5,07



HiFlo™ Control

Instant water flow control at the pole.
 - Easy hose fit mechanism
 - Complete water flow control
 - Quick fitting with clips or velcro straps
 - Fits all poles Ø 20–70 mm
 - Fits hoses Ø 8 and 9 mm

Art. Nr.	Info	VPE	€/Stück
TMOOV	Complete with nLite Clips + Velcro Straps	1	24,90
TMOON	Clips for fitting to Ø 35 mm nLite pole	1	2,90
TMOOT	Universal Velcro Straps	1	2,90

WINDOW CLEANING > WATER FED POLE SYSTEM >

nLITE™ HiFlo™ > POLES / SPARE PARTS



HiFlo™ nLITE POLE TUBE, HIMOD MASTER

Part No.	Ø mm	Segment	Clamp	Pack	€/piece
17254	26	1	●	1	186,33
17260	29	2	●	1	202,40
17266	32	3	●	1	216,79
17272	35	4	●●	1	247,16



HiFlo™ nLITE POLE TUBE, HIMOD EXTENSION

Part No.	Ø mm	Segment	Clamp	Pack	€/piece
17279	32	1	-	1	226,44
17396	35	2	●●	1	247,16



HiFlo™ nLITE POLE TUBE, CARBON MASTER

Part No.	Ø mm	Segment	Clamp	Pack	€/piece
17253	26	1	●	1	112,61
17259	29	2	●	1	118,70
17265	32	3	●	1	123,90
17271	35	4	●●	1	156,27



HiFlo™ nLITE POLE TUBE, CARBON EXTENSION

Part No.	Ø mm	Segment	Clamp	Pack	€/piece
17278	32	1	-	1	126,04
17394	35	2	●●	1	156,24



HiFlo™ nLITE POLE TUBE, HYBRID MASTER

Part No.	Ø mm	Segment	Clamp	Pack	€/piece
17252	26	1	●	1	64,20
17258	29	2	●	1	69,20
17264	32	3	●	1	69,66
17270	35	4	●●	1	96,59



HiFlo™ nLITE POLE TUBE, HYBRID EXTENSION

Part No.	Ø mm	Segment	Clamp	Pack	€/piece
17277	32	1	-	1	71,34
17395	35	2	●●	1	96,59

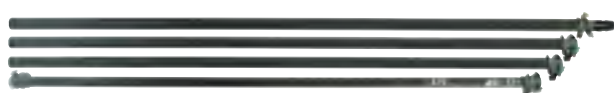

HiFlo™ nLITE POLE TUBE, GLASS FIBRE MASTER

Part No.	Ø mm	Segment	Clamp	Pack	€/piece
17818	26	1 (4,50 m)	●	1	30,90
17819	29	2 (4,50 m)	●	1	31,90
17820	32	3 (4,50 m)	●	1	32,90
17821	35	4 (4,50 m)	●●	1	35,90
17814	26	1 (6,00 m)	●	1	31,90
17815	29	2 (6,00 m)	●	1	32,90
17816	32	3 (6,00 m)	●	1	33,90
17817	35	4 (6,00 m)	●●	1	39,90



HiFlo™ nLITE POLE TUBE, GLASS FIBRE EXTENSION

Part No.	Ø mm	Segment	Clamp	Pack	€/piece
17822	32	3 (6,00 m)	-	1	37,90
17823	35	4 (6,00 m)	●●	1	41,90



HiFlo™ nLITE POLE TUBE, ALU MASTER

Part No.	Ø mm	Segment	Clamp	Pack	€/piece
17828	26	1 (4,50 m)	●	1	15,50
17829	29	2 (4,50 m)	●	1	15,90
17830	32	3 (4,50 m)	●	1	16,50
17831	35	4 (4,50 m)	●●	1	19,90
17824	26	1 (6,00 m)	●	1	17,50
17825	29	2 (6,00 m)	●	1	17,90
17826	32	3 (6,00 m)	●	1	18,50
17827	35	4 (6,00 m)	●●	1	22,90



HiFlo™ nLITE POLE TUBE, ALU EXTENSION

Part No.	Ø mm	Segment	Clamp	Pack	€/piece
17832	32	3 (6,00 m)	-	1	18,90
17833	35	4 (6,00 m)	●●	1	22,90



HiFlo™ nLITE CLAMP COMPLETE, 26 mm 

Yellow

Part No.	Version	Hose Clip	Pack	€/piece
17152	26 mm	✓	1	4,89
17282	26 mm	-	1	4,37



HiFlo™ nLITE CLAMP COMPLETE, 29 mm 

Grey

Part No.	Version	Pack	€/piece
17157	29 mm	1	5,00



HiFlo™ nLITE CLAMP COMPLETE, 32 mm 

Grey

Part No.	Version	Pack	€/piece
17162	32 mm	1	5,03



HiFlo™ nLITE CLAMP COMPLETE, 35 mm 

Grey

Part No.	Version	Pack	€/piece
17170	35 mm	1	6,20



HiFlo™ nLITE CLAMP COMPLETE, 35 mm 

Yellow

Part No.	Version	Pack	€/piece
17169	35 mm	1	6,20



HiFlo™ nLITE CLAMP HOSE CLIP 

Part No.	Pack	€/piece
17149	10	0,50



HiFlo™ nLITE HOSE

Water hose to connect nLite pole with water filter.
 - High pressure hose
 - Provides standard male hose connector, alu for water filter connection

Part No.	Length	Pack	€/piece
NL11G	11 m	1	16,44
NL20G	20 m	1	23,69
NL25G	25 m	1	26,79



HiFlo™ nLITE HOSE EXTENSION KIT

For quick connection of two hoses.
 - Simply push the adapter parts into hose and get a quick release connection between two hoses
 - Includes 2x hose end piece adapter, 1x quick connector

Part No.	Pack	€/piece
NLQUI	1	11,37

B nLITE ^{HiFlo™} BRUSHES

GENERAL INFORMATION

Types Rectangular, Radius and Solar

Sizes 27 / 40 / 60 cm

Bristle Guide

Lightweight, solvent resistant synthetic bristles are hard wearing and effective in removing even the most stubborn dirt.

Application Area



Jet types Pencil Jets for Hydrophilic Glass
 Fan Jets for Hydrophobic Glass



Brush Rotation

The brush can be rotated by 180°, using the built-in adapter. Changing the position provides greater flexibility and control over cleaning and rinsing different surfaces, angles and structures.



Pressure Guide

Adding more Jets allows you to clean larger areas quicker and better. The higher the water pressure, the higher number of Jets you can use at one time.

WINDOW CLEANING > WATER FED POLE SYSTEM >

nLITE^{HiFlo™} > BRUSHES



NEW

long & short bristles



NLR27
NLR40

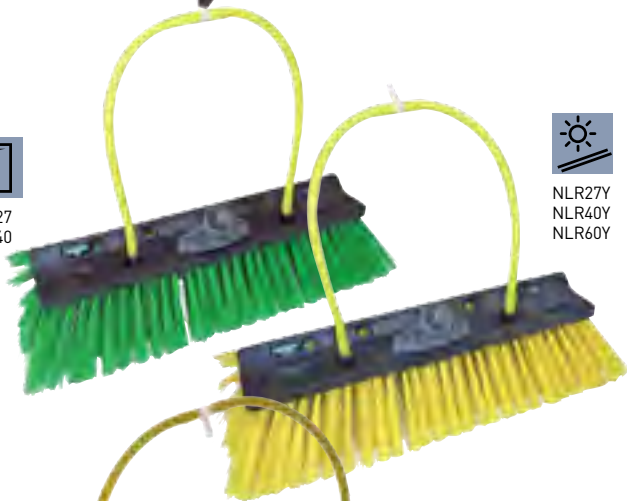

NLR27Y
NLR40Y
NLR60Y



NL27A
NL40A
NL60A



i



RADIUS BRUSH

- Angled brush body creates bigger surface
- Optimal for big areas or window sills or frames



RECTANGULAR BRUSH

- Flat brush body
- Best cleaning performance for all standard tasks

HiFlo™ nLITE BOARS BRISTLE BRUSH

Super tight water fed brush with best cleaning power.

- Best cleaning power as bristles clean with full length
- High quality boars bristles
- Short bristles, less weight, long bristles for big surfaces

Part No.	Size	Weight	Jet Pos.	Bristles	Pack	€/piece
NLE27	27 cm	280 g	4	short	1	69,00
NLE40	40 cm	360 g	8	short	1	89,00
NLB27	27 cm	295 g	4	long	1	89,00
NLB40	40 cm	415 g	8	long	1	119,00

i

BOARS BRISTLE

UNGER has selected the best quality bristles from the boar, which are close to the body.

Watching these under a microscope the bristles look like a fly leg with many side hairs that pick up dirt over the whole bristle length.

Short Bristles: Daily usage, big areas

Long bristles: Special usage, heavy soiled windows.

HiFlo™ nLITE RADIUS BRUSH/SOLAR RADIUS BRUSH

Supertight Water Fed Brush with jet connections.

- Radius shape for bigger surface and angled bristles for sills etc.
- Multiple jet locations
- One set of pencil jets included as standard
- Yellow solar bristles: unsplit

Part No.	Size	Weight	Jet Pos.	Pack	€/piece
NLR27	27 cm	408 g	4	1	36,19
NLR40	40 cm	579 g	8	1	46,51
NL27Y	27 cm	408 g	4	1	36,19
NL40Y	40 cm	579 g	8	1	46,51
NL60Y	60 cm	916 g	12	1	56,86

HiFlo™ nLITE RECTANGULAR BRUSH

Supertight Water Fed Brush with jet connections.

- Multiple jet locations for interchangeable jets
- One set of pencil jets included as standard
- Green unsplit bristles, especially for windows and surfaces

Part No.	Size	Weight	Jet Pos.	Pack	€/piece
NL27A	27 cm	314 g	4	1	31,01
NL40A	40 cm	452 g	8	1	41,34
NL60A	60 cm	850 g	12	1	51,69



HiFlo™ nLITE BRUSH SOCKET

Spare socket to connect brush to gooseneck.

- Can be turned to change angle of the brush and arrangement of jets

Part No.	Pack	€/piece
NLBRS	1	6,20



HiFlo™ nLITE BRUSH CONNECTION KIT

Connects two jets to the brush.
- 2 hose pieces + 1 T-piece

Part No.	Pack	€/piece
NLHPC	1	3,61



HiFlo™ nLITE JETS

For quick connection on nLite Brushes.

- NLBJF: Fan Jets, great for spraying water to get a constant film
- NLBJP: Pencil Jets, great for rinsing and removing dirt with pressure
- Attention: The more jets are used the more the waterpressure decreases

Part No.	Info	Pack	€/piece
NLBJF	1 Set = 2 Jets	1 Set	4,64
NLBJP	1 Set = 2 Jets	1 Set	4,64

i JET CONFIGURATIONS

2 JETS =

- Included with brush
- 1 x NLBJP 1 Set Pencil Jets
- 1 x NLHPC Hose Kit

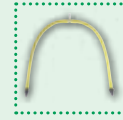

4 JETS =

- Extra parts required:
- 1 Set of jets
- 2 x NLHPC Hose Kit

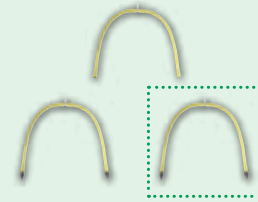

6 JETS =

- Extra parts required:
- 2 Sets of jets
- 4 x NLHPC Hose Kit

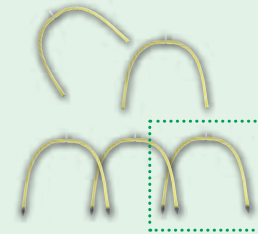

C nLITE^{HiFlo™} GOOSENECKS

GENERAL INFORMATION

Length	20 and 30 cm / 150 cm
Material	Carbon / Hybrid

Use Strong carbon fibre gooseneck attachments enable you to achieve any working angle, keeping weight to a minimum. Modern carbon material ensures long life and high rigidity. The angle adapters are available in sizes of 20 cm, 30 cm and 150 cm. Choose between the different versions depending on the size, type and angle of the surface on which you want to work.

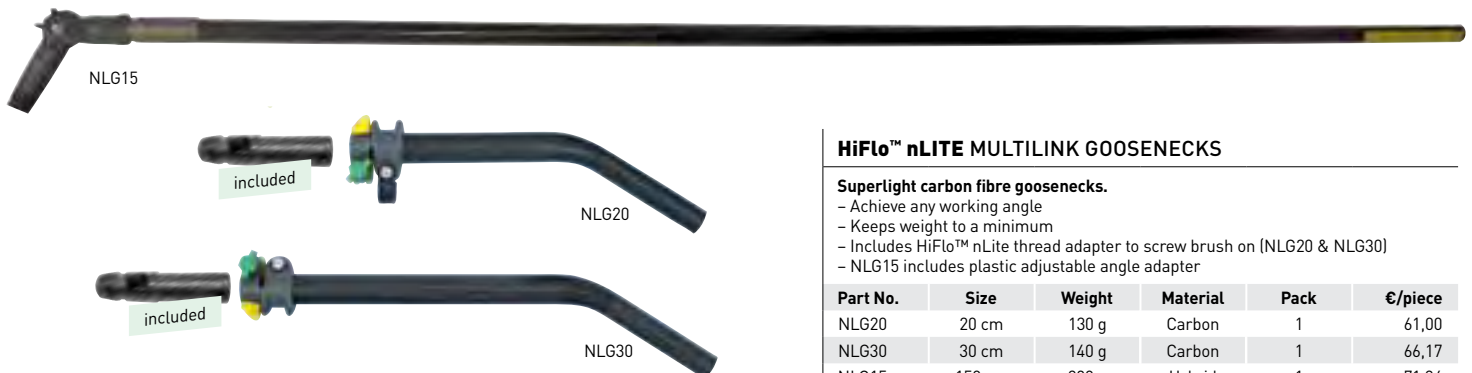

HiFlo™ nLITE MULTILINK GOOSENECKS

Superlight carbon fibre goosenecks.

- Achieve any working angle
- Keeps weight to a minimum
- Includes HiFlo™ nLite thread adapter to screw brush on (NLG20 & NLG30)
- NLG15 includes plastic adjustable angle adapter

Part No.	Size	Weight	Material	Pack	€/piece
NLG20	20 cm	130 g	Carbon	1	61,00
NLG30	30 cm	140 g	Carbon	1	66,17
NLG15	150 cm	390 g	Hybrid	1	71,34

WINDOW CLEANING > WATER FED POLE SYSTEM > MODULAR POLES > CARBONTEC

A

HiFlo™ CARBONTEC WATER FED POLE SYSTEM

This Award Winning modular water fed pole system, capable of reaching heights up to 15 metres / 50 feet and beyond, is by far the best on the market. Quality engineered and manufactured in Germany, the patent pending carbon fibre system is extremely rigid and lightweight. It's every pole size you will ever need, in one portable Gear Bag that you can carry.

FEATURES:

- Carbon fibre sections are super-light-weight, yet extremely rigid
- Easily assembled, sections screw together with robust and durable hard anodized aluminium connectors
- Internal hose in every section – quickly connected.
- Comfortable to hold – slip resistant textured connections between sections

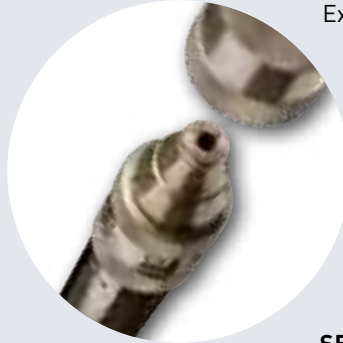

- Convenient Waterfeed Adapter with on-off water control – saves water
- Fully compatible with HiFlo™ MultiLink Goosenecks, Extensions and Brushes

WHY CHOOSE MODULAR?

Adding individual sections allows user to build up their Pole to the exact length required to reach a specific height. This means that you work with the exact Pole length required but with the least Pole weight necessary – the sections you don't need can stay in the Gear Bag!

SECTION INFO:

- Diameter: 45 mm
- 2 Lengths available: 1,5 m and 0,75 m



HiFlo™ CarbonTec POLE

Solid carbon fibre Pole sections, reinforced with glass fibre.

- Light, yet extremely robust and durable
- Strong, with secure connection
- Internal hose – quick connection
- Available in 2 sizes

Part No.	Size	Pack	€/piece
CT15B	1,50 m	1	235,87
CT075	0,75 m	1	176,61



HiFlo™ CarbonTec MODULAR POLE KIT

Complete Kit consisting of poles and all accessories. Comes in durable Gear Bag.
Includes: 10 x (or 6 x) CT15B CarbonTec Pole sections 1,50 m, 1 x CT27A Brush, 1 x FTGOA Adapter, 1 x FTMGS Gooseneck short, 1 x CTWFC Waterfeed Adapter, 1 x CTH10 Hose 10 m, 1 x CTECP Endcap.

Part No.	Size	Sections	Pack	€/piece
CTKI3	15 m	10	1	2.487,87
CTKI6	9 m	6	1	1.783,16



HiFlo™ CarbonTec GEAR BAG

For storage, protection and transportation of CarbonTec Pole Kit.

- Made from solid nylon material
- Can be carried in hand or over shoulder
- Additional compartments for accessories

Part No.	Size (H x W x D)	Pack	€/piece
CTBA2	20 x 160 x 30 cm	1	188,46



HiFlo™ CarbonTec HOSE COMPLETE

Durable hose for water supply from water filter to the Brush.

- High pressure hose
- Complete with standard hose connector for water supply and CarbonTec waterfeed

Part No.	Size	Pack	€/piece
CTH10	10 m	1	41,50
CTH25	25 m	1	53,09



HiFlo™ CarbonTec WATERFEED ADAPTER

Anodised aluminium adapter for water flow control.

- Strong, with secure connection
- Can be installed at the system base or in-between any 2 pole sections
- Allows to reduce water consumption

Part No.	Pack	€/piece
CTWFC	1	81,79



HiFlo™ CarbonTec END CAP

Anodised aluminium end cap for secure positioning of the Pole.

- Strong, with secure connection
- Attaches to the last pole section
- Slip resistant to help user manage the Pole
- Solid rubber end protects the connector

Part No.	Pack	€/piece
CTECP	1	41,50



HiFlo™ CarbonTec BRUSH JETS

Part No.	Pack	€/piece
CTBRJ	2	11,74



HiFlo™ HOSE EXTENSION KIT

Part No.	Pack	€/piece
16900	1	14,37



HiFlo™ CarbonTec POLE/WATER ADAPTER

Part No.	Pack	€/piece
CTHPC	1	10,24



HiFlo™ CONNECTION HOSE REPLACEMENT

Part No.	Info	Pack	€/piece
16474	1 m + CTHPC	1	10,86
16475	2 m + CTHPC	1	11,69



HiFlo™ CarbonTec HOSELOCK CONNECTOR

Part No.	Pack	€/piece
CTHLC	10	5,07



HiFlo™ CarbonTec O-RING

Part No.	Pack	€/piece
CTORI	10	0,86



HiFlo™ CarbonTec WATER VALVE

Part No.		Pack	€/piece
CTWV	complete	1	16,47
14259	connection to pole	1	1,97
14260	valve	1	7,13
14261	water connection	1	2,49

WINDOW CLEANING > WATER FED POLE SYSTEM > TELESCOPIC > **HiFlo™ ADVANCE**

A

HiFlo™ ADVANCE WATER FED POLE SYSTEM

NUMEROUS ADVANTAGES:

- Safely clean up to 20 metres high, without ladders, from the ground
- Significant time savings: no setup times for ladders or lift trucks
- Quick access to hard to reach areas
- Easily adjustable due to clamp system
- Twice as fast as conventional glass cleaning
- Saves money: lower rental and personnel costs
- More efficiency in less time
- Image improvement – modern presentation to the client, convincing results and a better price

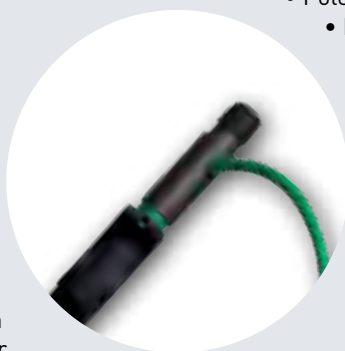

TOP FEATURES:

- Pole sections made of strong and sturdy material
- Robust and easy to operate clamp connections – quick adjustment of height
- Internal hose, including standard connector for water filter
- 4 metres extra length when pole is fully extended.
- Ideal for high and narrow buildings
- Ultra-compatible thanks to numerous MultiLink adapters and a great range of HiFlo™ brushes
- Glass Fibre and Hybrid (Glass Fibre & Carbon)



HiFlo™ Advance POLES

Extremely flexible HiFlo™ Advanced Poles reach up to 10,00 m / 45 ft high. Complete with Internal Hose and Hoselock Connector. Ready to use with HiFlo™ MultiLink Gooseneck System and Brushes.

- Very solid and lightweight due to carbon and glass fibre
- Resistant against chemicals
- Solid clamps permit one-handed operation

HiFlo™ Advance Glass Fibre

Part No.	Sections	Weight	Length	Pack	€/piece
FT28G	2	1,1 kg	2,80 m	1	71,00
FT40G	3	1,5 kg	4,00 m	1	93,89
FT52G	4	2,0 kg	5,20 m	1	128,21
FT70G	5	3,0 kg	7,00 m	1	162,53
FT84G	6	3,6 kg	8,40 m	1	208,29

HiFlo™ Advance+ Hybrid (Glass Fibre + Carbon)

Part No.	Sections	Weight	Length	Pack	€/piece
FT94H	7	3,7 kg	9,40 m	1	574,30
FT1XH	8	4,3 kg	10,00 m	1	688,67



HiFlo™ CarbonTec TELESCOPIC POLES

Flexible and long carbon fibre telescopic Poles reach up to 20 m / 65 ft high. Complete with Internal Hose and Hoselock Connector.

Ready to use with HiFlo™ MultiLink Gooseneck System and Brushes.

- Stiff and robust. Entirely made from carbon fibre
- High accessibility, work up to 20 metres high
- Easy to use: convenient height adjustment with clamps

Part No.	Sections	Weight	Length	Material	Pack	€/piece
FT5XC	9	5,7 kg	13,50 m	Carbon Fibre	1	1.062,91
FT6XC	9	6,6 kg	16,00 m	Carbon Fibre	1	1.328,90
FT7XC	10	8,2 kg	20,00 m	Carbon Fibre	1	1.594,91

HiFlo™ ADVANCE SPARE PARTS



Quality Tools for Smart Cleaning

HiFlo™ Advance GLASS FIBRE

Pole Section 1,50 m, green

FT28G (2 Sections, 2,80 m)
FT40G (3 Sections, 4,00 m)
FT52G (4 Sections, 5,20 m)

Part No.	Ø	Segment	Pack	€/piece
16342	22 mm	1	1	27,57
16343	26 mm	2	1	29,69
16344	30 mm	3	1	31,81
16345	34 mm	4	1	32,89

Pole Section 1,80 m, green

FT70G (5 Sections, 7,00 m)
FT84G (6 Sections, 8,40 m)

16274	22 mm	1	1	30,76
16275	26 mm	2	1	33,94
16276	30 mm	3	1	35,01
16277	34 mm	4	1	36,07
16278	38 mm	5	1	37,13
16279	42 mm	6	1	38,20

HiFlo™ Advance HYBRID

Pole Section 1,80 m, green

FT84H (6 Sections, 8,40 m)
FT94H (7 Sections, 9,40 m)
FT1XH (8 Sections, 10,00 m)

Part No.	Ø	Segment	Pack	€/piece
16280	22 mm	1	1	65,87
16281	26 mm	2	1	90,33
16282	30 mm	3	1	97,79
16283	34 mm	4	1	103,10
16284	38 mm	5	1	112,67
16285	42 mm	6	1	117,99
16286	46 mm	7	1	123,31
16287	50 mm	8	1	125,43

Pole Section 1,80 m, green

FT2XH (8 Sections, 13,50 m)

16346	22 mm	1	1	76,50
16347	26 mm	2	1	100,99
16348	30 mm	3	1	108,43
16349	34 mm	4	1	113,74
16350	38 mm	5	1	123,31
16351	42 mm	6	1	128,63
16352	46 mm	7	1	133,97
16353	50 mm	8	1	136,09

HiFlo™ CarbonTec TELESCOPIC

Black, for FT5XC

FT5XC (9 Sections, 13,50 m)

Part No.	Ø	Segment	Pack	€/piece
16354	22 mm	1	1	158,41
16355	26 mm	2	1	160,54
16356	30 mm	3	1	165,86
16357	34 mm	4	1	293,56
16358	38 mm	5	1	313,77
16359	42 mm	6	1	325,47
16360	46 mm	7	1	197,80
16361	50 mm	8	1	200,99
16379	54 mm	9	1	204,19

Black, for FT6XC

FT6XC (9 Sections, 16 m)

16289	22 mm	1	1	178,64
16290	26 mm	2	1	180,77
16291	30 mm	3	1	188,21
16292	34 mm	4	1	336,11
16293	38 mm	5	1	360,59
16294	42 mm	6	1	378,66
16295	46 mm	7	1	229,71
16296	50 mm	8	1	235,03
16297	54 mm	9	1	240,36

Black, for FT7XC

FT7XC (10 Sections, 20 m)

16380	22 mm	1	1	178,64
16381	26 mm	2	1	180,77
16382	30 mm	3	1	188,21
16383	34 mm	4	1	336,11
16384	38 mm	5	1	360,59
16385	42 mm	6	1	378,66
16386	46 mm	7	1	241,43
16387	50 mm	8	1	247,81
16388	54 mm	9	1	251,00
16389	58 mm	10	1	254,19

WINDOW CLEANING > WATER FED POLE SYSTEM > HiFlo™ ADVANCE SPARE PARTS



HiFlo™ Advance LEVER

Part No.	Size	Segment	Pack	€/piece
16255	small	2 + 3	1	1,80
16260	medium	4 + 5	1	2,03
16265	big	6 - 9	1	2,34
16272	XXL (FT7XC)	10	1	2,56



HiFlo™ Advance RING FOR LEVER

Part No.	Diameter	Segment	Pack	€/piece
16256	22/26	2	1	2,56
16257	26/30	3	1	2,56
16261	30/34	4	1	2,66
16262	34/38	5	1	2,66
16266	38/42	6	1	2,76
16267	42/46	7	1	2,76
16268	46/50	8	1	2,76
16269	50/54	9	1	2,76
16273	54/58	10	1	2,86



HiFlo™ Advance LEVER SCREW

Part No.	Size	Segment	Pack	€/piece
16258	A4 M3-26 mm	2 + 3	1	0,53
16263	A4 M4-30 mm	4 + 5	1	0,53
16270	A4 M5-32 mm	6 - 10	1	0,53



HiFlo™ Advance LEVER NUT

Part No.	Size	Segment	Pack	€/piece
16259	M3	2 + 3	1	0,53
16264	M4	4 + 5	1	0,53
16271	M5	6 - 10	1	0,53



HiFlo™ Advance LEVER KIT (2 EACH)

Part No.	Size	Segment	Pack	€/piece
15728	small	2 + 3	1	21,17
15729	medium	4 + 5	1	23,30



HiFlo™ Advance LEVER KIT (3 EACH)

Part No.	Size	Segment	Pack	€/piece
15730	big	6 - 10	1	27,57



HiFlo™ Advance BRUSH JET

Part No.		Pack	€/piece
14875	for FTxxx Brushes	1	3,09



HiFlo™ Advance T-PIECE

Part No.	Pack	€/piece
14954	1	0,96



HiFlo™ Advance VELCROBAND

Part No.	Pack	€/piece
10790	1	0,73



HiFlo™ Advance HOSE CONNECTOR

2 x 11 cm hose pieces + T-piece

Part No.	Pack	€/piece
16221	1	1,27



HiFlo™ Advance ENDCAP

Part No.	Ø	Segment	Pack	€/piece
15721	25 mm	2	1	9,04
15722	30 mm	3	1	9,47
15723	34 mm	4	1	10,10
15724	38 mm	5	1	10,54
15725	42 mm	6	1	11,17
15726	45 mm	7	1	11,59
15727	50 mm	8	1	12,23
16240	54 mm	9	1	12,66
16241	58 mm	10	1	13,30



HiFlo™ Advance HOSE

Green

Part No.	Size	For Pole	Pack	€/piece
15438	1/4 x 7,02 m	FT28G	1	16,91
15439	1/4 x 8,22 m	FT40G	1	19,04
15440	1/4 x 9,44 m	FT52G	1	20,10
15441	1/4 x 11,22 m	FT70G	1	22,23
15442	1/4 x 12,66 m	FT84G/H	1	24,36
15443	1/4 x 13,66 m	FT94H	1	25,44
15437	1/4 x 14,22 m	FT1XH	1	26,50
16299	17,50 m	FT2XH/5XC	1	29,69
16300	21,00 m	FT6XC	1	35,01
16301	24,00 m	FT7XC	1	38,20



HiFlo™ Advance REGULATING VALVE

Part No.	Pack	€/piece
15831	1	20,90

B BRUSHES



HiFlo™ SOLAR BRUSH SOFT

Soft, flagged bristles.

- Specially designed for photovoltaic panels
- Highly effective in removing dirt
- Will not damage the panel surface
- Complete with hose connection

Part No.	Size	Pack	€/piece
FTS0Y	27 cm	1	48,04



HiFlo™ BRUSH RECTANGULAR

Soft polyester brush.

- Square edges ideal for corners
- Very strong
- Complete with hose connection

Part No.	Size	Brushes	Pack	€/piece
FTS27	27 cm	Soft	1	48,04



HiFlo™ CarbonTec BRUSHES

Nylon grey monofilament bristles.

- Back made of robust solid plastic
- Complete with 1 x FTCBA and hose connection
- Available in two sizes

Part No.	Size	Pack	€/piece
CT27A	27 cm	1	55,33
CT40A	40 cm	1	69,16



HiFlo™ ANGLE BRUSH

Soft or hard polyester brush.

- Angled back
- Ideal for sills, corners and frames
- Complete with hose connection

Part No.	Size	Brushes	Pack	€/piece
FTR27	27 cm	Soft	1	53,76
FBR27	27 cm	Hard	1	53,76



HiFlo™ OVAL BRUSH

Soft polyester brush.

- Very strong
- Complete with hose connection
- Available in two sizes
- 40 cm ideal for large areas

Part No.	Size	Brushes	Pack	€/piece
FTO27	27 cm	Soft	1	40,03
FTO40	40 cm	Soft	1	54,90

WINDOW CLEANING > WATER FED POLE SYSTEM > HiFlo™ MULTILINK



HiFlo™ MultiLink GOOSENECKS

Hard anodised aluminium angle adapter.

- Strong, with secure connection
- Brush can be locked in any position through 360° creating the perfect working angle
- Combine 2 or more to achieve your perfect angle

Part No.	Size	Pack	€/piece
FTMGS	Short	1	62,77
FTMGL	Long	1	73,41



HiFlo™ MultiLink EXTENSION

Hard anodised aluminium extension adapter.

- Strong: Anodized aluminium, secure connection
- Convenient: Extends the angle adapter to the required distance
- Compatible: Can be combined with all MultiLinks

Part No.	Pack	€/piece
FTPLS	1	37,23



HiFlo™ MultiLink Y-ADAPTER

Anodized aluminium adapter for using 2 tools on a Pole.

- Strong, with secure connection
- Saves time - just turn the Pole to change the tool
- Can be combined with MultiLink Goosenecks to achieve your perfect angle

Part No.	Pack	€/piece
FTYAD	1	80,86



HiFlo™ MultiLink ADAPTER

Plastic angle adapter with screw adjustment.

- Simple to adjust
- Robust
- Compatible with all HiFlo™ Brushes

Part No.	Pack	€/piece
FTGOS	1	5,21



HiFlo™ MultiLink CONE ADAPTER

Hard anodised aluminium adapter for Classic cleaning tools.

- Strong, with secure connection
- Compatible with ErgoTec® Locking Cone NCAN0 - all Classic tools can be connected to HiFlo™ Poles
- Fits on all MultiLink Goosenecks

Part No.	Pack	€/piece
FTLCA	1	18,63



HiFlo™ MultiLink CarbonTec ADAPTER

Hard anodised aluminium adapter that connects HiFlo™ CarbonTec to MultiLink Adapters.

- Strong, with secure connection
- Includes water outlet, connector and 1 m hose

Part No.	Pack	€/piece
FTGOA	1	41,50



HiFlo™ MultiLink CarbonTec BRUSH ADAPTER

Hard anodised aluminium adapter for the connection of CarbonTec Brushes to the MultiLink System.

- Strong, with secure connection
- Includes 2 nozzles and hoses
- Attaches to the CarbonTec Brushes using the jets

Part No.	Pack	€/piece
FTCBA	1	30,86



HiFlo™ LUBRICANT

Spray to produce adhesive lubricant films and protective films on metals.

- For maintenance of threads
- Use for all threads of HiFlo™ poles and MultiLinks

Part No.	Pack	€/piece
FTLUB	1	15,86



HiFlo™ MultiLink UNION NUT

Part No.	Pack	€/piece
16638	1	3,91



HiFlo™ MultiLink CONNECTION GOOSENECK

Part No.	Pack	€/piece
16961	1	6,81



**WINDOW CLEANING > PURE WATER FILTER >
HiFlo™ RO FILTER**



R030G



R030C



R060S

**RO
FILTER**

D

REVERSE OSMOSIS FILTERS (RO)

These filters purify water by flushing out the minerals with high pressure through a semipermeable membrane.

HiFlo™ RO FILTER

THE ULTIMATE REVERSE-OSMOSIS FILTER

Perfect for constant, high capacity, pure water production.

Easy Operation: No switch, "Plug & Play"

- Automatic pump control with dry run protection for added safety
- Pure water output improved to 60% at 350 l/hr
- Built in resin filter ensures 100% water purity
- Economic way of pure water production for general cleaning purposes
- Built in TDS meter monitors water and resin quality
- Includes robust trolley frame for complete mobility
- Weight app. 50 kg
- No control valves or covers that could accidentally be adjusted
- R030C: Special Carbon Pre-Filter against chlorine in the water (lasts app. 100.000 l at 2 ppm chlorine)

HiFlo™ RO FILTER

Part No.	Product	Pack	€/piece
R030G	Mobile RO Filter	1	4.651,97
R030C	Mobile RO Filter "Chlorine"	1	4.807,07

HiFlo™ HIGH PERFORMANCE RO FILTER

HIGH PERFORMANCE FOR BIG AREAS OR WHERE MANY WATER IS NEEDED

→ **Top Features like R030G plus more:**

- Double Membrane for extended water output (more than 700 l/h)
- Extra high power pump to support high water flow
- Big Pre-Filter, optimal security for the membranes
- Big Carbon Pre-Filter (instead of resin polisher) to save membranes from chlorine
- Ideal for two workers with no loss of water capacity or one worker with increased performance
- Perfect for solar cleaning – more water on the panel, better rinsing and cleaning
- Carbon filter lasts app. 200.000 litres at 2 ppm chlorine

HiFlo™ RO HIGH PERFORMANCE FILTER

Part No.	Pack	€/piece
R060S	1	7.227,66

WINDOW CLEANING > PURE WATER FILTER > HiFlo™ RO FILTER > SPARE PARTS

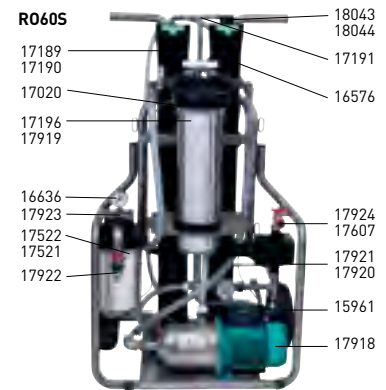
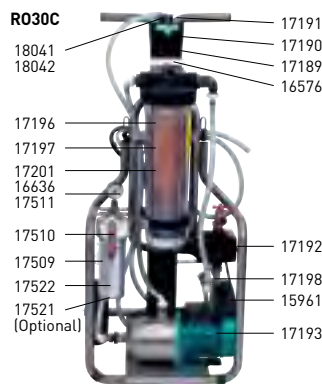
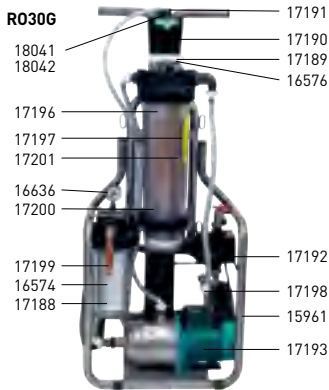

PREFILTER



HiFlo™ PREFILTER CASE 2,5" x 10" (RO30G)

Part No.	Info	Pack	€/piece
16574	No drilling	1	39,90
18075	w/drilling & manometer	1	51,90



HiFlo™ PREFILTER (RO30G)

Part No.	Size	Pack	€/piece
17188	2,5" x 10"	1	11,80



HiFlo™ PREFILTER CASE (RO30C/RO60S)

Part No.	Size	Pack	€/piece
17522	4,5" x 10"	1	139,00



HiFlo™ CHLORINE FILTER (RO30C)

Part No.	Size	Pack	€/piece
17509	4,5" x 10"	1	81,90



HiFlo™ PREFILTER (RO30C)

ATTENTION: Does not filter chlorine!

Part No.	Size	Pack	€/piece
17521	4,5" x 10"	1	28,90



HiFlo™ PRE-FILTER "CHLORINE" (RO60S)

Part No.	Size	Pack	€/piece
17919	20"	1	110,90



HiFlo™ O-RING FOR PREFILTER CASE (RO30G)

Part No.	Pack	€/piece
15886	1	7,90



HiFlo™ FILTER KEY (PRE-FILTER) (RO30G)

Part No.	Pack	€/piece
16637	1	9,50

WATER IN & OUT



HiFlo™ WATER CONNECTOR, FEMALE (RO30G/RO30C/RO60S)

Part No.	Size	Pack	€/piece
14393	3/4"	1	5,90



HiFlo™ WATER CONNECTOR, MALE (RO30G/RO30C/RO60S)

Part No.	Size	Pack	€/piece
17915	1"	1	4,50
17024	1/2"	1	4,10



HiFlo™ WATER IN COMPONENTS

Part No.	Position	Pack	€/piece
17199	Before Prefilter (RO30G)	1	43,90
17510	Before Prefilter (RO30C)	1	51,90



HiFlo™ MANOMETER INCOMING PRESSURE (RO30G/RO30C/RO60S)

Part No.	Pack	€/piece
16636	1	11,90



HiFlo™ WATER IN COMPONENTS (RO30G)

Part No.	Position	Pack	€/piece
17200	After Prefilter	1	27,90



HiFlo™ WATER IN COMPONENTS (RO30C)

Part No.	Position	Pack	€/piece
17511	After Prefilter	1	34,90



HiFlo™ WATER OUT COMPONENT 2 (RO60S)

Part No.	Pack	€/piece
17607	1	48,90



HiFlo™ WATER IN COMPONENTS (RO60S)

Part No.	Position	Pack	€/piece
17922	Before Prefilter	1	99,90



HiFlo™ WATER IN COMPONENTS (RO60S)

Part No.	Position	Pack	€/piece
17923	After Prefilter	1	142,90



HiFlo™ WATER OUT COMPONENT 1

Part No.	Product	Pack	€/piece
17924	RO60S	1	189,90

PUMP

HiFlo™ PUMP CONTROL (R030G/R030C)

Part No.	Pack	€/piece
17192	1	62,90

HiFlo™ PRESSURE PUMP (R030G/R030C)

Part No.	Product	Pack	€/piece
17193	R030G/R030C	1	690,00
17918	R060S	1	830,00

MEMBRANE

HiFlo™ MEMBRANE (R030G/R030C/R060S)

Part No.	Size	Pack	€/piece
17189	4" x 40" (Membrane)	1	425,90
17190	4" x 40" (Pressure Tube)	1	417,90

HiFlo™ MANOMETER WORKING PRESSURE (R030G/R030C/R060S)

Part No.	Pack	€/piece
17191	1	46,90

HiFlo™ MEMBRANE PRESSURE TUBE TOP PLATE (R030G/R030C)

Part No.	Pack	€/piece
18041	1	97,90

HiFlo™ MEMBRANE PRESSURE TUBE BOTTOM PLATE (R030G/R030C/R060S)

Part No.	Pack	€/piece
18042	1	95,90

HiFlo™ MEMBRANE PRESSURE TUBE TOP PLATE, CPL (R060S)

Part No.	Pack	€/piece
18043	1	141,90

HiFlo™ MEMBRANE PRESSURE TUBE TOP PLATE (R060S)

Part No.	Pack	€/piece
18044	1	95,90

RESIN FILTER

HiFlo™ RESIN FILTER HOUSING (R030G/R030C/R060S)

Part No.	Info	Pack	€/piece
17195	without drilling	1	199,50
17196	with drilling	1	275,90

HiFlo™ CARTRIDGE 20" CLEAR (R030G/R030C)

Part No.	Size	Pack	€/piece
17197	empty	1	28,90
17201	filled with resin	1	83,90

HiFlo™ FILTER KEY (RESIN) (R030G/R030C/R060S)

Part No.	Info	Pack	€/piece
17194	für 4,5" cups	1	11,90

TUBES

HiFlo™ CAPILLARY TUBE (R030G/R030C)

Part No.	Info	Pack	€/piece
17198	concentrate	1	47,46
17202	Membrane to Pump	1	35,06

HiFlo™ CAPILLARY TUBE (R060S)

Part No.	Info	Pack	€/piece
17920	Membrane to Pump, black	1	57,80
17921	concentrate		39,19

HiFlo™ O-RING HOSE CONNECTION

Part No.	Size	Pack	€/piece
18045	1" (R060S)	1	2,35
18074	3/4" (R030G/R030C)	1	1,90

ACCESSORIES

HiFlo™ MEMBRANE MAINTENANCE (R030G/R030C/R060S)

Part No.	Size	Pack	€/piece
15436	1 l	1	19,90

HiFlo™ PRESERVATION TUBE (R030G/R030C)

Part No.	Pack	€/piece
17605	1	9,83

HiFlo™ DI TDS-MONITOR (R030G/R030C/R060S)

Part No.	Type	Pack	€/piece
16576	DM-2	1	54,90

HiFlo™ DOUBLE THREAD (R030G, R030C/R060S)

Part No.	Size	Pack	€/piece
18164	3/4"	1	2,70

HiFlo™ REPLACEMENT WHEEL (R030G/R030C/R060S)

Part No.	Pack	€/piece
15961	2	32,99

HiFlo™ CHLORINE TESTSTRIPES (R030C)

Part No.	Content	Pack	€/piece
17512	50 stripes	1	82,61

HiFlo™ ENDPLUGS FOR CART HANDLE (R030G/R030C/R060S)

Part No.	Pack	€/piece
15731	1	1,90

WINDOW CLEANING > PURE WATER FILTER > HiFlo™ DI FILTER

DI
FILTER



DI400

DI800

D DEIONISATION FILTERS (DI)

These filters utilise ion exchange resins which remove ionised salts from water, producing 100 % deionised water.

HiFlo™ DI FILTER

THE ULTIMATE RESIN FILTER FOR LARGER CLEANING JOBS.

The UNGER resin filter produces 100 % pure water immediately. Ideal for mobile and quick use.

By way of a chemical process, water is being purified and desalted. This allows glass cleaning without any detergents, using only a water pole and a brush.

- 2 Bottle sizes available: 25 l, 50 l
- Water production (at water hardness of 180 ppm):
 - 25 litre bottle = 4,000 litre
 - 50 litre bottle = 8,000 litre
- Produces 100% Ultra-pure water (<math><10\mu\text{S}/\text{cm}</math>)
- Including fine filter, for pre-filtering of the water
- Immediately usable on site
- Mounted on convenient trolley with big rubber wheels and anti-tipping device
- No electricity required
- Standard hosepipe connection

HiFlo™ DI FILTER

Part No.	Bottle (Resin)	Capacity*	Pack	€/piece
DI400	25 l	4000 l	1	1.735,89
DI800	50 l	8000 l	1	2.232,20

* at 180 ppm

HiFlo™ DI140-FILTER

IDEAL ENTRY LEVEL SYSTEM FOR SMALLER CLEANING JOBS.

- Immediately produces 100% pure water
- Ready to use: "Plug & Play" – just connect the hoses and turn on the System! No electricity required
- Includes two 4,5 l cartridges filled with Premium Grade Resin
- Produces 1,440 l of pure water before the resin has to be replaced
- Built in TDS meter monitors water and resin quality
- Air release buttons speed up first time pure water production and increase resin longevity



HiFlo™ DI140-FILTER

Part No.	Bottle (Resin)	Capacity*	Pack	€/piece
DI140	2 x 4,5 l	1440 l	1	722,77

* at 180 ppm

HiFlo™ DI100-FILTER

EASY & CONVENIENT STARTER SYSTEM. VALUE FOR MONEY.

- New water distribution system: 30% more output, much more effective use of resin
- Easy to use: Just connect hoses
- No Power required
- Immediately 100% pure water production
- Lightweight bottle, can be hand carried
- Contains 4,7 litres resin
- Produces app. 1.000 l pure water (at 180 ppm)
- Standard 3/4" hose connectors
- Easy to change resin
- Accessory: special resin exchange funnel. Quickest way to fill resin into bottle



HiFlo™ DI100 FILTER

Part No.	Bottle (Resin)	Capacity*	Pack	€/piece
DI100	4,7 l	1000 l	1	205,77

* at 180 ppm



MIXED-BED RESIN

High capacity mixed bed ion exchange resin.

- Immediately produces 100% pure water for streak free glass cleaning
- Ideal for all **UNGER** HiFlo™ DI cartridges
- Consisting of a mixture of a gel, Type I strong base anion resin and a gel strong acid cation resin for direct purification of water. 40% cation, 60% anion.
- pH range: 0-14

Part No.	Product	Pack	€/piece
DIB25	Bag 25 litres	1	92,03
DIP25	Bucket 25 litres	1	102,37



FUNNEL FOR RESIN CHANGE

Part No.	Pack	€/piece
PWFUN	1	51,60

i



WATER DISTRIBUTION SYSTEM

Special construction, that leads the water through the complete bottle. So the complete resin is used = 30% more output of pure water.

WINDOW CLEANING > PURE WATER FILTER > HiFlo™ SPARE PARTS

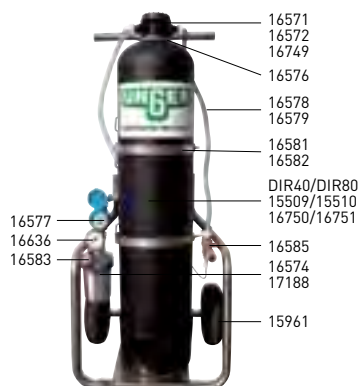

HiFlo™ DI400/DI800



HiFlo™ PREFILTER CASE

Part No.	Size	Pack	€/piece
16574	2,5" x 10"	1	39,90
18075	2,5" x 10" w/ drilling & manometer	1	51,90



HiFlo™ PREFILTER 80 µm

Part No.	Pack	€/piece
16575	1	30,50

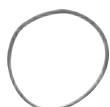

HiFlo™ O-RING FOR PREFILTER CASE

Part No.	Pack	€/piece
15886	1	7,90



HiFlo™ WATER CONNECTOR, MALE

Part No.	Size	Pack	€/piece
17024	1/2"	1	4,10



HiFlo™ PLASTIC CONNECTOR, FEMALE

Part No.	Size	Pack	€/piece
14393	3/4"	1	5,90



HiFlo™ WATER IN COMPONENTS

Part No.	Pack	€/piece
16583	1	67,90



HiFlo™ WATER OUT COMPONENTS

Part No.	Pack	€/piece
16585	1	41,90



HiFlo™ DI HOSE WITH CONNECTORS

Part No.	Product	Pack	€/piece
16578	DI400	1	34,90
16579	DI800	1	38,90



HiFlo™ DI TENSION BAND FOR THE BOTTLE

Part No.	Product	Pack	€/piece
16581	DI400	1	69,90
16582	DI800	1	69,90



HiFlo™ REPLACEMENT BOTTLES

Part No.	Size	Info	Pack	€/piece
15509	25 l	empty bottle, no accessories DI400	1	169,00
DIR40	25 l	complete, w/resin DI400	1	379,00
15510	50 l	empty bottle, no accessories DI800	1	219,00
DIR80	50 l	DI800 – complete, w/resin DI800	1	619,00



HiFlo™ BOTTLE LOCK

Part No.	Size	Info	Pack	€/piece
16571	3/4"	without inserts	1	57,90



HiFlo™ O-RING FOR BOTTLE LOCK

Part No.	Pack	€/piece
16572	1	2,10



HiFlo™ DI TDS-MONITOR

Part No.	Type	Pack	€/piece
16576	DM-2	1	54,90



HiFlo™ DI NOZZLE ROD

Part No.	Product	Pack	€/piece
16750	DI400	1	16,90
16751	DI800	1	17,90



HiFlo™ WATER METRE

Part No.	Size	Pack	€/piece
16577	1/2"	1	79,90



HiFlo™ DI TRANSPORT PLUG

Part No.	Pack	€/piece
16749	1	0,90



HiFlo™ ELECTRODE WATER IN

Part No.	Pack	€/piece
16584	1	29,90



HiFlo™ DI WATER-OUT-CONDUCTIVITY ELECTRODE

Part No.	Pack	€/piece
16586	1	15,90



HiFlo™ DI WATER-OUT-SAMPLE VALVE

Part No.	Pack	€/piece
16573	1	25,74



HiFlo™ REPLACEMENT WHEEL

Part No.	Pack	€/piece
15961	2	32,99

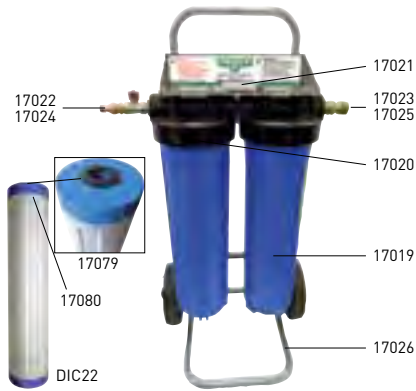
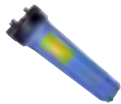
HiFlo™ DI140
HiFlo™ FILTER HOUSING

Part No.	Info	Pack	€/piece
17019	blue, empty, no drilling	1	89,90
18076	blue, empty, with drilling	1	89,90
17195	transparent, empty, no drilling	1	199,50

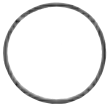
HiFlo™ SEALING FOR FILTER HOUSING

Part No.	Pack	€/piece
17020	1	13,96

HiFlo™ RESIN CARTRIDGE

Part No.	Content	Pack	€/piece
16214	empty	1	28,90
DIC22	filled	1 pair	169,90

HiFlo™ SEALING FOR CARTRIDGE

Part No.	Pack	€/piece
17079	1	3,93

HiFlo™ FOAM FOR CARTRIDGE

Part No.	Pack	€/piece
17080	1	7,13

**HiFlo™ FILTER KEY (RESIN)
(R030G/R030C/R060S)**

Part No.	Info	Pack	€/piece
17194	für 4,5" cups	1	11,90

HiFlo™ TDS-MONITOR



Part No.	Pack	€/piece
17021	1	27,90

HiFlo™ WATER-IN-COMPONENT

Part No.	Pack	€/piece
17022	1	83,80

HiFlo™ WATER CONNECTOR, MALE

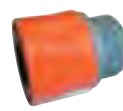
Part No.	Size	Pack	€/piece
17024	1/2"	1	4,10

HiFlo™ PLASTIC CONNECTOR, FEMALE

Part No.	Size	Pack	€/piece
14393	3/4"	1	5,90

HiFlo™ MOUNTING SCREWS KIT

Part No.	Pack	€/piece
17028	1	13,34

HiFlo™ REPLACEMENT WHEEL

Part No.	Pack	€/piece
17203	2	22,90

WINDOW CLEANING > PURE WATER FILTER > HiFlo™ SPARE PARTS

HiFlo™ DI100



HiFlo™ CLOSURE STOPPER INNER PIPE

Part No.	Pack	€/piece
12346	1	0,30



HiFlo™ PRESSURE VESSEL

Part No.	Material	Pack	€/piece
17413	Polypropylen	1	166,37



HiFlo™ DISTRIBUTION HEAD, CPL.

Part No.	Pack	€/piece
17414	1	52,63



HiFlo™ O-RING FOR VESSEL PLUG

Part No.	Pack	€/piece
17417	1	3,90



HiFlo™ MOLDED PIPE ADAPTER

Part No.	Pack	€/piece
17418	1	20,57



HiFlo™ VESSEL PLUG

Part No.	Pack	€/piece
17419	1	13,34



HiFlo™ SECURING CLIP, RED

Part No.	Pack	€/piece
17420	1	4,03



HiFlo™ HOSE CONNECTOR MALE

Part No.	Size	Pack	€/piece
17421	3/4"	1	5,70



HiFlo™ HOSE CONNECTOR FEMALE

Part No.	Size	Pack	€/piece
17422	3/4"	1	14,90



HiFlo™ ACCESSORIES



Quality Tools for Smart Cleaning



HiFlo™ HOSE REEL

Have your hose under control.

- Solid aluminium construction
- Easy to operate and easy to assemble
- Secure stand, easy to manoeuvre
- Comfortable crank
- Standard hose connectors, included to UNGER hoses

Part No.	Pack	€/piece
PHR40	1	147,90



PH50Y



PH80Y

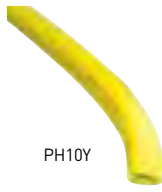

PH10Y

HiFlo™ HOSE SET

PH50Y

- 1 x male adapter for hose reel
- 2 x female adapter for pole connection

PH80Y

- 1 x male adapter for hose reel
- 1 x female adapter for pole connection

PH10Y

- 1 x male adapter for hose reel
- 1 x female adapter for pole connection

Part No.	Size	Ø	Pack	€/piece
PH50Y	50 m	13 mm	1	105,33
PH80Y	80 m	9 mm	1	115,97
PH10Y	100 m	5 mm	1	73,41



HiFlo™ SOAP DISPENSER

The professional solution for severely soiled glass surfaces.

- Fits to every pure water filter
- Just fix with a belt
- No electricity needed, water driven pump
- Rate of additive: 0,3% to 2%
- Water pressure: 0,2–8 bar (2,9–120 PSI)
- Flowrate: 20–2.500 l/h (5,3–660 gal/h)
- Size: 56 x 18,5 cm (22" x 7,72")
- Weight: 1,8 kg (4 pound)
- Standard coupling 3/4"
- Complete incl. Connection Kit

Part No.	Pack	€/piece
HC25	1	521,36



HiFlo™ SOAP DISPENSER

The practical solution for severely soiled glass surfaces.

- Adding soap to pure water
- Simple connection to standard garden hose
- Easy filling

Part No.	Pack	€/piece
HCDEU	1	34,20



HiFlo™ TDS-METRE

For all RO and DI Filters.

- Measures the ppm-Value of the Water
- Battery Power
- Protection Cap
- Hang Clip and Protection pouch

Part No.	Pack	€/piece
ROTDS	1	23,90

WINDOW CLEANING > CLASSICAL WINDOW CLEANING



All **UNGER** products are expertly designed to meet the high demands of the Professional Window Cleaning Industry. Innovation and ergonomics are always at the forefront of our research and product development to enable professionals to work faster, more efficiently and above all safely.

Today our range includes wide selection of traditional, handheld tools and accessories, built to last and withstand continuous use, day after day.

From the classic washer and squeegee to the latest microfiber pads for indoor cleaning – we have a solution to any cleaning challenge. What's more, all of our tools can be fitted to **UNGER** telescopic pole, allowing you to clean at heights of up to 10 m safely from the ground.

Look out for the **ErgoTec®** Locking Cone symbol, identifying products that can be locked securely on the pole with a quick-release button preventing falling off or spinning.



PREMIUM

Top of the range product, loaded with features.



BEST

High on features bestseller.



BETTER

Standard version.



GOOD

Basic version. Good value option.

SOLID CONNECTION



PUSH ON / SCREW ON

These tools are simply attached to the **UNGER** cone, hence hard to reach areas can easily be cleaned. The special grooves on the cone ensure a secure fit of the tools. These tools are screwed onto the Acme thread of the **UNGER** cone to ensure tight and secure fit. Hard to reach areas can be cleaned easily and safely.



CLICK ONTO LOCKING CONE

All tools with a slot in the handle and "LOCK" inscribed on it, securely lock into the **ErgoTec®** Locking Cone. Eliminating twisting or dropping during work the **ErgoTec®** Locking Cone is a standard feature on all **OptiLoc™** and **TelePlus™** poles.

Professional Window Cleaning



SQUEEGEES



p. 41

UNGER squeegees feature comfortable handles, high quality rubber and special locking mechanism for quick and easy change of the channel.

NINJA, ***ERGOtec***[®], ***ERGOtec***[®] SwivelLoc, ***S***, ***PRO***, ***VISAVERSA***, ***GC***, ***UNITec***, ***UNITec*** Light



WASHERS



p. 46

UNGER washers are available in a choice of materials with different features and absorbency, as well as various T-Bar designs.

NINJA, ***ERGOtec***[®], ***ALU***, ***SWIVEL***, ***UNITec***, ***MICROSTRIP***[™], ***MONSOON***, ***ORIGINAL***, ***PAD***, ***KLETT***



INDOOR CLEANING SYSTEM



p. 50

Easy-to-use, one step system, ideal for every day cleaning as well as polishing of glass and mirrors. Perfect for any user without window cleaning experience.



TELESCOPIC POLES



p. 52

Lightweight, yet durable telescopic pole in various lengths put everything within arm's reach. Clean at heights of up to 10 m safely from the ground, without ladders.



SCRAPERS



p. 56

UNGER scrapers are perfect for removing stubborn dirt and glue residue. With various designs, safety features and blade sizes, there is an option to suit any budget and task.



ACCESSORIES



p. 58

Our extensive range includes everything to build up a professional kit – from waterproof gloves, belts and pouches to specialist detergents, buckets and cloth.



ErgoTec® NINJA SQUEEGEE

The ultimate performance



Clips



T6 Alu



1.



2.

Ergonomic bi-component swivel handle with TriLoc mechanism for secure hold of the channel. Extruded Aircraft Aluminium T6 channel will not bend or break. Complete with Soft Rubber.

ErgoTec® NINJA WASHER

Makes tough jobs a lot easier



2 x



Alu

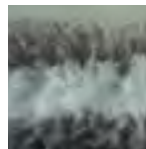

Strong yet lightweight hard anodised aluminium T-Bar with 180° swivel.

Highly absorbent sleeve with 2 abrasive side pads features built-in rows of scrubbing fibres.

ErgoTec® NINJA BUCKET ON A BELT



2 x



1 x



1 x



Fits all **UNGER** squeegees. Holds 2 squeegees, 1 washer and 1 scraper. Suitable for left or right handed work. Clip lock for quick fitting to any belt.

ErgoTec® NINJA MICRO WIPE

High performance microfibre cloth



4 x Scrub Edges

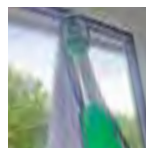

Made of highly absorbent, lint free microfibre with 4 scrubbing corners for removing stubborn dirt or hanging the cloth on the pole for easy spot and corner cleaning at height. Machine washable up to 500 times. Available in 3 sizes.

WINDOW CLEANING > CLASSICAL WINDOW CLEANING



Quality Tools for Smart Cleaning

SQUEEGEES



PRODUCT OVERVIEW

Use the guide below to compare various models of **UNGER** Squeegees and identify the right one for your cleaning tasks and budget.

	BUDGET	HANDLE		SWIVEL	CHANNEL			RUBBER*				
		Material	Fits to Locking Cone	Tension adjustment	Fitting	Sizes	Material	Type	Soft	Hard		Fitting
NINJA The ultimate high performance squeegee, featuring TriLoc mechanism for reliable hold of channel and freely adjustable and lockable swivel head.	***	2k (Plastic with rubber insert)		Metal screw needs coin or screwdriver	TriLoc: clip press & release	25 – 105 cm	T6 Aluminium	Molded	✓	-	Side Clips on Ninja Channel	p. 42
ERGOtec® Stainless steel squeegee with bi-component handle. Advanced ergonomic design for comfortable use every day. Quick and simple channel change.	***	2k (Plastic with rubber insert)		-	S-Spring: press & release	25 – 55 cm	Stainless Steel	Molded	✓	✓	Press S-Spring	p. 43
ERGOtec® Swiveloc Swivel squeegee head, freely adjustable and lockable – a problem solver for hard-to-reach areas. Available in 2 head angles – straight and 30° version, ideal for working at height.	***	Metal + Rubber sleeve		Plastic screw turn 0° position fixable with button	0° screwed plate 30° S-Spring	only handle 0° / 30°	Stainless Steel	Only handle	-	-	0°: screw off plate 30° press S-Spring	p. 43
S Solid, stainless steel squeegee with rubber coated handle. S-Spring for easy & quick channel and rubber change.	**	Metal + Rubber sleeve		-	S-Spring: press & release	25 – 55 cm	Stainless Steel	Molded	✓	✓	Press S-Spring	p. 43
PRO Standard Squeegee for daily work. Clip for easy & quick channel and rubber change. Rubber sleeve for comfortable grip.	**	Metal + Rubber sleeve		-	Clip lock easy release	25 – 55 cm	Stainless Steel	Molded	✓	✓	Open clip	p. 43
VISA-VERSA Squeegee and washer in one tool. Great time saving choice for cleaning at height – no need to change the tool!	**	Plastic Finger grooves		-	S-Spring: press & release	25 – 45 cm	Stainless Steel	Molded	✓	✓	Press S-Spring	p. 43
GC Classic style brass. Sturdy and durable.	*	Brass		-	Screwed Plate needs screwdriver	25 – 55 cm	Brass	Extruded	✓	-	Screw off plate	p. 45
UNITEc Basic metal squeegee. Quick channel release.	*	Metal		-	Squeezed by button	25 – 55 cm	Stainless Steel	Extruded	✓	-	Turn button	p. 45
UNITEc Light Lightweight squeegee for glass or flat surfaces, ideal for household use.	*	Plastic		-	Channel hold by handle	30 cm	Aluminium	Extruded	✓	-	Fixed to channel	p. 45

* Soft and Hard Rubber are interchangeable and available to order separately.



PURCHASING GUIDE You have to take 5 decisions:

- BUDGET:** How long do you work, how big is the area, how many extra features do you need?
- HANDLE:** Weight, Feature, Ergonomics
- SWIVEL FUNCTION:** Do you need to reach hard to reach areas? Do you work with telescopic poles?
- CHANNEL:** How big is the surface to be cleaned? How important is a quick channel change?
- RUBBER:** Soft or hard rubber? Professional quality or is standard quality enough?



This product securely locks on ErgoTec® Locking cone.



This product fits on **UNGER** Poles without safety locking mechanism.

WINDOW CLEANING > CLASSICAL WINDOW CLEANING > SQUEEGEES

ERGOtec® NINJA



ErgoTec® NINJA WINDOW SQUEEGEE



Complete with Ninja-channel and Soft rubber.

- Ergonomic swivel handle
- Extruded Aircraft Aluminum T6 Channel: will not bend or break
- Professional Soft Rubber
- Fits securely to pole with Locking Cone

Part No.	Size	Rubber	Pack	€/piece
EN300	30 cm	Soft	5	25,00
EN350	35 cm	Soft	5	26,26
EN450	45 cm	Soft	5	27,70

ErgoTec® NINJA SQUEEGEE CHANNELS



Complete with soft rubber and SmartClip end clips.

- Extruded Aircraft Aluminum T6 Channel: will not bend or break
- Perfect pressure distribution
- Fast and easy rubber change

Part No.	Size	Rubber	Pack	€/piece
AC200	20 cm	Soft	5	8,18
AC250	25 cm	Soft	5	8,60
AC300	30 cm	Soft	5	9,48
AC350	35 cm	Soft	5	10,02
AC400	40 cm	Soft	5	10,76
AC450	45 cm	Soft	5	11,46
AC500	50 cm	Soft	5	12,24
AC550	55 cm	Soft	5	13,14
AC600	60 cm	Soft	5	15,86
AC650	65 cm	Soft	5	17,32
AC750	75 cm	Soft	5	19,52
AC920	92 cm	Soft	5	22,78
AC105	105 cm	Soft	5	24,96



ErgoTec® NINJA CLIPS



Part No.	Pack	€/piece
PPLUG	5 Sets	7,52



ErgoTec® NINJA HANDLE



- Ergonomic: bi-component handle
- Swivel: perfect for pole work
- TriLoc for secure channel hold
- Fits securely to pole with Locking Cone

Part No.	Pack	€/piece
EN000	5	16,26



RUBBER INFO



SOFT

- Shore hardness: 53 ± 2
- Ideal for colder temperatures
- Adjusts better to uneven surfaces

HARD

- Shore hardness: 60 ± 2
- Ideal for warmer temperatures
- Ideal for large, smooth surfaces

ErgoTec® SQUEEGEE
 50TH ANNIVERSARY EDITION

p. 2

ErgoTec® SWIVEL LOC HANDLE

Swivel squeegee head, freely adjustable and lockable.
Problem solver for hard to-reach places.

- Advanced ergonomic bi-component handle for comfortable use
- Available in two head angles (0°, 30°)
- Compatible with S-Channel
- Fits securely to pole with Locking Cone for extra safety

Part No.	Version	Pack	€/piece
LS000	0°	5	14,16
LA000	30°	5	14,16

ErgoTec® SQUEEGEE

Ergonomic two-component handle.

Complete with S-channel and Soft rubber.

- Comfortable: Optimal handling, less injuries
- Quick: Simple replacement of rubber and channel
- Safe: No twisting or dropping (Locking Cone)

Part No.	Size	Rubber	Pack	€/piece
ES250	25 cm	Soft	10	14,76
ES350	35 cm	Soft	10	16,08
ES450	45 cm	Soft	10	17,48
ES550	55 cm	Soft	10	18,92
ES25H	25 cm	Hard	10	14,76
ES35H	35 cm	Hard	10	16,08
ES45H	45 cm	Hard	10	17,48
ES55H	55 cm	Hard	10	18,92
ETG00		Handle	10	10,20
ETX00	+2,5 cm	Handle XL	10	10,90

S SQUEEGEE

Stainless steel squeegee with rubber coating.

Complete with S-channel.

- Comfortable: Ergonomically designed handle
- Simple: Clip lock, quick channel change
- Convenient: Fits on telescopic pole

Part No.	Size	Rubber	Pack	€/piece
SE250	25 cm	Soft	10	11,70
SE350	35 cm	Soft	10	12,94
SE450	45 cm	Soft	10	14,38
SE25H	25 cm	Hard	10	11,70
SE35H	35 cm	Hard	10	12,94
SE45H	45 cm	Hard	10	14,38
SG000		Handle	10	7,54

VisaVersa®

Squeegee and washer in one tool. Complete with S-Channel, Original Sleeve and Rubber.

- Time saving performance without changing tool
- Fits securely to pole with Locking Cone for extra safety

Part No.	Size	Rubber	Pack	€/piece
VP250	25 cm	Soft	10	25,72
VP350	35 cm	Soft	10	27,58
VP450	45 cm	Soft	10	30,44

Pro SQUEEGEE

Stainless steel squeegee with rubber coating.

Complete with S-channel.

- Comfortable: Ergonomically designed handle
- Simple: Clip lock, quick channel change
- Convenient: Fits on telescopic pole

Part No.	Size	Rubber	Pack	€/piece
PR250	25 cm	Soft	10	11,70
PR350	30 cm	Soft	10	12,94
PR450	45 cm	Soft	10	14,38
PR000		Handle	10	7,54

WINDOW CLEANING > CLASSICAL WINDOW CLEANING > SQUEEGEES



Pro SQUEEGEE RUBBER

25 rubbers per storage box. Professional quality.

- Highly durable and efficient
- Sharp edges enable thorough wiping for superior finish
- Sturdy plastic box for dirt and bending free storage

Part No.	Size	Rubber	Pack	€/piece
RP300	30 cm	Soft	25	2,01
RP350	35 cm	Soft	25	2,18
RP450	45 cm	Soft	25	2,36
RP35H	35 cm	Hard	25	2,18
RP45H	45 cm	Hard	25	2,36



Pro SQUEEGEE RUBBER

10 rubbers per bag. Professional quality.

- Highly durable and efficient
- Sharp edges enable thorough wiping for superior finish

Part No. Soft	Part No. Hard	Size	Pack	€/piece
RR200	RR20H	20 cm	10	1,86
RR250	RR25H	25 cm	10	1,94
RR300	RR30H	30 cm	10	2,04
RR350	RR35H	35 cm	10	2,16
RR400	RR40H	40 cm	10	2,24
RR450	RR45H	45 cm	10	2,32
RR500	RR50H	50 cm	10	2,42
RR550	RR55H	55 cm	10	2,48
RR600	RR60H	60 cm	10	2,58
RR650	RR65H	65 cm	10	2,70
RR750	RR75H	75 cm	10	2,90
RR920	RR92H	92 cm	10	4,16
RR990	RR99H	106 cm	10	4,72

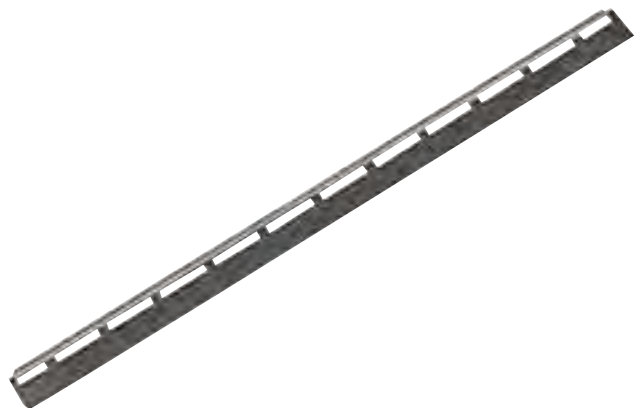

S CHANNEL

Stainless steel channel with variable positioning options.

Complete with soft and hard rubber.

- Strong and durable
- Easy change of rubber.
- Fits on ErgoTec, S and Pro squeegees

Part No.	Size	Rubber	Pack	€/piece
NE250	25 cm	Soft	10	4,58
NE300	30 cm	Soft	10	5,08
NE350	35 cm	Soft	10	5,92
NE450	45 cm	Soft	10	7,30
NE550	55 cm	Soft	10	8,76
NE15H	15 cm	Hard	10	3,86
NE25H	25 cm	Hard	10	4,58
NE30H	30 cm	Hard	10	5,08
NE35H	35 cm	Hard	10	5,92
NE45H	45 cm	Hard	10	7,30
NE55H	55 cm	Hard	10	8,76



Plastic Clips™

For improved hold of rubber in the channel. Available in solid plastic or brass.

- Effectively tensions and secures squeegee rubber
- Detachable one at a time
- Practical sturdy storage box

Part No.	Info	Pack	€/piece
PCLIP	Plastic Clips 40/Box	10	3,60
MCLIP	Brass Clips 100/Box	1	19,24



Ergo HANDLE EXTENSION

Additional 14 cm reach for cleaning glass.

- Offers additional reach for safer cleaning without ladders
- Fits to all cone tools

Part No.	Size	Pack	€/piece
HH000	14 cm	10	6,00



RUBBER INFO

Soft

- Shore hardness: 53 ± 2
- Ideal for colder temperatures
- Adjusts better to uneven surfaces

Hard

- Shore hardness: 60 ± 2
- Ideal for warmer temperatures
- Ideal for large, smooth surfaces



GC SQUEEGEE



The classic. Brass handle.

Brass channels, complete with soft rubber.

- Quality: Particularly sturdy
- Safe: Firm channel fit, screwed down. Channel with soft rubber
- Durable: Stainless

Part No.	Size	Rubber	Pack	€/piece
GS000		Brass Handle	10	10,50
GC250	25 cm	Brass Channel	10	4,74
GC300	30 cm	Brass Channel	10	5,32
GC350	35 cm	Brass Channel	10	5,80
GC450	45 cm	Brass Channel	10	6,92
GC550	55 cm	Brass Channel	10	8,32



HIGHWAY RUBBER



Cut to fit 15 m rubber roll. Household quality.

- Convenient and practical
- Good value deal
- Cardboard box with easy rubber access.

Part No.	Size	Pack	€/piece
HIXXL	15 m	10	46,02



UniTec™ SQUEEGEE



Convenient metal squeegee, good value.

- Sturdy
- Firm channel fit with screws
- Fits on telescopic pole

Part No.	Size	Info	Pack	€/piece
OW250	25 cm	Complete	10	8,32
OW350	35 cm	Complete	10	9,16
OW450	45 cm	Complete	10	10,22
OG000		Handle	10	5,40



RUBBER GRIP



Black for squeegee handle.
For SG000, PR000, SExxx, PRxxx.

Part No.	Pack	€/piece
GG000	10	0,74



VisaVersa® HANDLE



Part No.	Info	Pack	€/piece
VH000	for VPxxx	1	5,38



VisaVersa® HEAD



Part No.	Info	Pack	€/piece
VS000	for VPxxx	1	6,30



UniTec™ SQUEEGEE LIGHT



Extra light squeegee for glass or flat surfaces in household area.

- Lightweight design for comfortable use
- Ideal for smooth surfaces
- Fits on telescopic pole

Part No.	Size	Info	Pack	€/piece
US300	30 cm	Complete	10	3,90



LASSO

Practical safety tool to secure a squeegee.

- Safe: Prevents squeegee from dropping
- Sturdy: Flexible and solid
- Effective: Secure hold

Part No.	Size	Pack	€/piece
SL010	55 cm	10	36,86

WINDOW CLEANING > CLASSICAL WINDOW CLEANING > WASHERS

WASHERS



PRODUCT OVERVIEW

Use the guide below to compare various models of **UNGER** washers and sleeves and identify the right one for your cleaning tasks and budget.

T-BARS

	BUDGET	HANDLE		SWIVEL FUNCTION		T-BAR				
		Material	Fits to Locking Cone	Swivel Head	Tension adjustment	Material	Weight	Available Sizes	Function	
NINJA	★★★	2k (Plastic, rubber)		✓	screw	Alu	Very light	25 – 75 cm	Swivel head	p. 48
ERGOtec®	★★★	2k (Plastic, rubber)		-	-	Plastic	Light	25 – 45 cm	Water wells	p. 48
ALU	★★	plastic finger rills		-	-	Alu	Very light	15 – 55 cm	Low weight	p. 48
SWIVEL	★★	plastic finger rills		✓	knob	Alu	Very light	35 – 45 cm	Swivel head	p. 48
UNITEC	★	plastic ergonomic shape		-	-	Plastic	Light	25 – 45 cm	Water wells	p. 48

SLEEVES

	BUDGET	MATERIAL	FEATURES	AVAILABLE SIZES	CLOSING	SCRUB PAD	
NINJA	★★★	Microfibre Extra long blend fibres Scrub fibres	Superb water absorption and scrubbing action	25 – 75 cm	Velcro	2 x	p. 49
MICROSTRIP™	★★★	Microfibre	High water retention 6 times its own weight	25 – 55 cm	Velcro	1 x	p. 49
MONSOON	★★★	Long blend fibres	High water retention	15 – 55 cm	Velcro	1 x	p. 49
ORIGINAL	★★	Blend fibres	Good cleaning power	25 – 55 cm	Velcro	1 x	p. 49
PAD	★★	Scrub Surface Blend fibres	Removes tough dirt	35 + 45 cm	Velcro	-	p. 49
KLETT	★★	Velcro surface Blend fibres	Brings microfibre cloths to height	35 cm	Velcro	-	p. 49
UNITEC	★	Synthetic fibres	Standard cleaning power	25 – 45 cm	snap fasteners	-	p. 49

ERGOtec® NINJA

 i
p. 2

ErgoTec® WASHER
50TH ANNIVERSARY EDITION

ErgoTec® NINJA WINDOW WASHER

Complete with Ninja Washer Sleeve and Black Alu T-Bar.

- Superior water retention and cleaning power
- Extra long fibre with built-in scrubbing bristles incl. microfibre
- Lightweight and solid anodised aluminium T-Bar
- Swivel function T-Bar securely locks onto **UNGER** telescopic poles

Part No.	Size	Pack	€/piece
NA350	35 cm	5	23,34
NA450	45 cm	5	25,96



StripWasher® MICROSTRIP PAC

Complete washer with microfibre sleeve.

- High water retention
- Superior cleaning power
- Lightweight plastic T-bar with water wells
- Machine washable up to 500 times sleeve with side scrub pad

Part No.	Size	Material	Pack	€/piece
NC350	35 cm	Microfibre	10	14,20
NC450	45 cm	Microfibre	10	16,44



StripWasher® MONSOON STRIP PAC

Complete squeegee with sleeve, extra long fibres (blend).

- High water retention
- Excellent cleaning power
- Handles large areas
- Machine washable up to 500 times sleeve with side scrub pad

Part No.	Size	Material	Pack	€/piece
MC350	35 cm	Blended fabric	10	12,80
MC450	45 cm	Blended fabric	10	14,82



StripWasher® ORIGINAL STRIP PAC

Complete squeegee with blended fabric standard sleeve.

- Good cleaning power
- Lightweight plastic T-bar with water wells
- Machine washable up to 500 times sleeve

Part No.	Size	Material	Pack	€/piece
WC250	25 cm	Blended fabric	10	10,16
WC350	35 cm	Blended fabric	10	11,62
WC450	45 cm	Blended fabric	10	13,14



StripWasher® PADSTRIP PAC

Complete squeegee with multifunctional sleeve.
Sleeve features scrub pad and standard fabric sides.

- Removes tough dirt
- Lightweight plastic T-bar with water wells
- Machine washable up to 500 times sleeve

Part No.	Size	Material	Pack	€/piece
RC350	35 cm	Scrub Pad + Fabric	10	12,98
RC450	45 cm	Scrub Pad + Fabric	10	14,82

WINDOW CLEANING > CLASSICAL WINDOW CLEANING > WASHERS

ERGOtec® NINJA



ErgoTec® NINJA T-BAR



Durable, super solid T-Bar.

- Lightweight yet strong anodized aluminium T-Bar
- Purposeful design guarantees superior performance without causing excessive strain on arms and shoulders
- 180° Swivel function

Part No.	Size	Pack	€/piece
NI250	25 cm	5	11,02
NI350	35 cm	5	11,56
NI450	45 cm	5	11,96
NI550	55 cm	5	12,50
NI750	75 cm	5	13,54



StripWasher® ErgoTec® T-BAR



Ergonomic bi-component washer handle.

- Ergonomic bi-component handle
- Water wells for increased water retention
- Fits securely to pole with Locking Cone for extra safety

Part No.	Size	Pack	€/piece
EH250	25 cm	10	5,66
EH350	35 cm	10	6,34
EH450	45 cm	10	6,90

StripWasher® ALU T-BAR



Lightweight aluminium washer handle.

- Lightweight solid aluminium with plastic handle
- Finger grooves on the handle for secure grip
- Fits securely to pole with Locking Cone for extra safety

Part No.	Size	Pack	€/piece
AT150	15 cm	10	3,54
AT250	25 cm	10	3,92
AT350	35 cm	25	4,40
AT450	45 cm	25	4,82
AT550	55 cm	10	5,26



StripWasher® SWIVEL T-BAR



Lightweight aluminium T-bar with adjustable head.

- Angle adjustable to 7 positions with set screw
- Lightweight solid aluminium with plastic handle

Part No.	Size	Pack	€/piece
SV350	35 cm	5	10,30
SV450	45 cm	5	10,66



StripWasher® UniTec™ T-BAR



Lightweight plastic washer handle.

- Water wells for increased water retention
- Lightweight monolithic plastic

Part No.	Size	Pack	€/piece
OE250	25 cm	10	2,80
OE350	35 cm	10	3,14
OE450	45 cm	10	3,42



StripWasher® ORIGINAL SLEEVE ★★

Blended fabric standard sleeve with Velcro fastener.
 - Good cleaning power
 - Machine washable up to 500 times

Part No.	Size	Material	Pack	€/piece
WS250	25 cm	Blended fabric	10	6,28
WS350	35 cm	Blended fabric	10	7,26
WS450	45 cm	Blended fabric	10	8,48
WS550	55 cm	Blended fabric	10	9,40



StripWasher® PAD SLEEVE ★★

Blended fabric standard sleeve with scrub pad strip and Velcro fastener.
 - Removes tough dirt
 - Good cleaning power
 - Time efficient cleaning
 - Machine washable up to 500 times

Part No.	Size	Material	Pack	€/piece
RS350	35 cm	Scrub Pad + Fabric	10	9,00
RS450	45 cm	Scrub Pad + Fabric	10	10,06

ErgoTec® NINJA WASHER SLEEVE ★★★

Ultimate Performance Washer Sleeve.
 - Long, Absorbent Fibre Mix, including scrub material and microfibre
 - Two Side Scrub Pads
 - Velcro Fastener
 - Machine washable up to 500 times

Part No.	Size	Pack	€/piece
NJ250	25 cm	5	11,02
NJ350	35 cm	5	11,80
NJ450	45 cm	5	14,02
NJ550	55 cm	5	16,36
NJ750	75 cm	5	19,54

StripWasher® MICRO SLEEVE ★★★

Microfibre sleeve with scrub pad and Velcro fastener.
 - High water retention - up to 6 times its own weight
 - Superior cleaning power
 - Machine washable up to 500 times

Part No.	Size	Material	Pack	€/piece
NS250	25 cm	Microfibre	10	8,68
NS350	35 cm	Microfibre	10	9,30
NS450	45 cm	Microfibre	10	11,04
NS550	55 cm	Microfibre	10	12,88

StripWasher® MONSOON SLEEVE ★★★

Blended fabric sleeve with extra long fibres, scrub pad and Velcro fastener.
 - High water retention
 - Excellent cleaning power
 - Machine washable up to 500 times

Part No.	Size	Material	Pack	€/piece
MS150	15 cm	Blended fabric	10	7,36
MS250	25 cm	Blended fabric	10	7,86
MS350	35 cm	Blended fabric	10	8,40
MS450	45 cm	Blended fabric	10	9,94
MS550	55 cm	Blended fabric	10	10,92



StripWasher® KLETT SLEEVE ★★

Synthetic fibre washer sleeve with snap fasteners.
 - Rough textured, non-abrasive nylon cleaning pad removes tough dirt
 - Perfect for bringing a microfibre cloth to height

Part No.	Size	Pack	€/piece
KS350	35 cm	10	9,00



StripWasher® UniTec™ SLEEVE ★

Synthetic fibre washer sleeve with snap fasteners.
 - Good cleaning power
 - Good value deal
 - Machine washable up to 500 times

Part No.	Size	Material	Pack	€/piece
ON250	25 cm	Synthetic fibre	10	4,38
ON350	35 cm	Synthetic fibre	10	5,14
ON450	45 cm	Synthetic fibre	10	5,90

WINDOW CLEANING > CLASSICAL WINDOW CLEANING > INDOOR CLEANING SYSTEM

EFFECTIVE WINDOW CLEANING

EASY OPERATION:



THE UNGER INDOOR WINDOW CLEANING SYSTEM

Indoor windows are not as dirty as outdoors. The **UNGER** Indoor Cleaning System provides effective and easy tools to clean light soiled windows in one step. Also perfect for unexperienced persons.

- Extends the reach up to 2,50 m high safely from the floor
- Quick Window Cleaning at hard to reach areas
- Saves Water
- Only one cleaning step – no wiping of windows
- Windows dry streakfree by cleaning with pure water
- Flexible aluminium padholder with velcro and microfibre pads

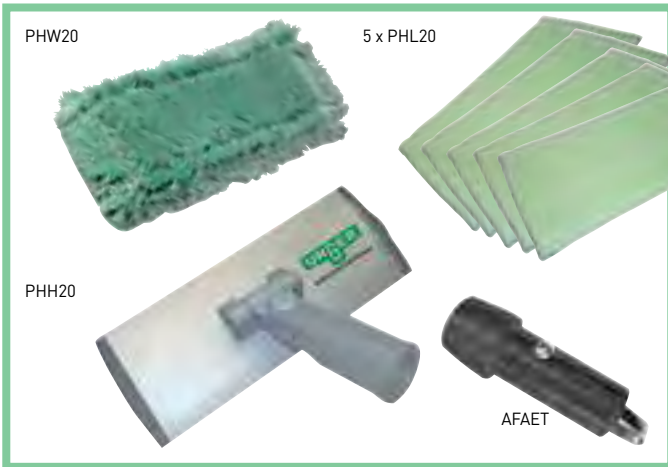

STARTER SET

INDOOR CLEANING STARTER SET

Content:
 PHL20 (5 x) Microfibre Cleaning Pad 20 cm
 PHW20 Microfibre Wash Pad 20 cm
 PHH20 Padholder 20 cm
 AFAET Thread adapter for Alu-Poles

Part No.	Pack	€/piece
PFK20	1	62,78



INDOOR CLEANING MASTER SET

Content:
 PHL20 (5 x) Microfibre Cleaning Pad 20 cm
 PHW20 Microfibre Wash Pad 20 cm
 PHH20 Padholder 20 cm
 AFAET Thread adapter for Alu-Poles
 TZ250 TelePlus™ Telescopic pole 2,50 m, 2-sections
 SOABG Sprayer On A Belt, 1 Liter
 BSTBT ErgoTec® Belt
 BSPOU ErgoTec® Pouch

Part No.	Pack	€/piece
IDKTE	1	137,26

STARTER SET

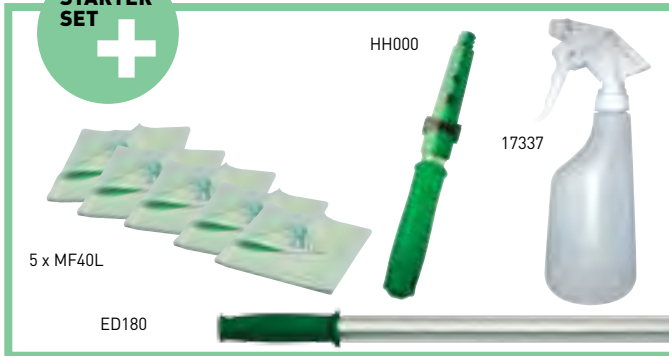

INDOOR WINDOW CLEANING KIT

- Content:**
- PHL20 (5 x) Microfibre Cleaning Pad 20 cm
 - PHW20 Microfibre Wash Pad 20 cm
 - PHH20 Padholder 20 cm
 - AFAET Thread adapter for Alu-Poles
 - ED180 OptiLoc™ Telescopic pole 1,85 m, 3-sections
 - 17337 Spray bottle, 650 ml
 - MF40L (5 x) MicroWipe™ Microfibre cloth 40 x 40 cm
 - HH000 Ergo Handle Extension 14 cm

Part No.	Pack	€/piece
CK05G	1	105,34

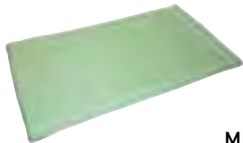

MICROFIBRE CLEANING PAD

- Microfibre cleaning pad with velcro for pad PHH20 & PHD20.**
- Provides perfect glide on the window
 - Removes dust, fingerprints, grease and other light dirt from glass
 - Strong velcro backing for strong fitting at pad holder

Part No.	Size	Pack	€/piece
PHL20	20 cm	5	6,36

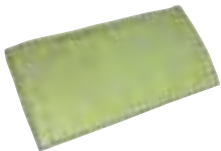

MICROFIBRE POLISH PAD

- Microfibre polish pad for regular cleaning.**
- Removes dust, fingerprints, grease and other light dirt from glass and mirrors
 - Strong Velcro backing for attaching to Padholder PHH20 & PHD20

Part No.	Size	Pack	€/piece
PHP20	20 cm	5	6,36



MICROFIBRE WASH PAD

- Microfibre wash pad for periodic washing and heavy soil.**
- 15 mm long, thick fibres easily remove tough dirt
 - Strong Velcro backing for attaching to Padholder PHH20 & PHD20

Part No.	Size	Pack	€/piece
PHW20	20 cm	5	7,42

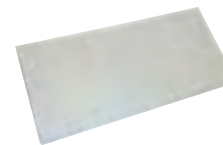

SCRUB PAD, WHITE

- Abrasive scrub pad for removing tough dirt.**
- Removes stubborn dirt, ideal for outdoor cleaning
 - Reliably sticks to the backing of Padholder PHH20 & PHD20

Part No.	Size	Pack	€/piece
OPS20	20 cm	10	0,84



PAD HOLDER (HANDHELD)

- Aluminium hand holder for indoor cleaning pads.**
- Fullspace velcro backing for strong hold of pads
 - Handle for perfect control by hand and best power distribution.
 - Ergonomic shape

Part No.	Size	Pack	€/piece
PHD20	20 cm	5	21,18



PAD HOLDER

- Aluminium holder for indoor cleaning pads.**
- Fullspace velcro backing for strong hold of pads
 - Swivel pole holder for flexible work, even in height
 - Thread for secure fixing a pole

Part No.	Size	Pack	€/piece
PHH20	20 cm	5	21,18



THREAD ADAPTER FOR ALU-POLES

- Anodized aluminium Adapter for fitting the Padholder to Alu-Poles.**
- Fits into any UNGER aluminium pole - just click in
 - Enables connection between Alu-Poles and MultiLink Goosenecks, Extensions and Brushes

Part No.	Pack	€/piece
AFAET	5	14,08

WINDOW CLEANING > CLASSICAL WINDOW CLEANING > TELESCOPIC POLE SYSTEM

TELESCOPIC POLE SYSTEM

The **UNGER Telescopic Pole System** puts everything within arm's reach.

Telescopic poles in various lengths and with ergonomic handles allow for secure operation from the ground – without ladder – and in addition save time and money.

OptiLoc™

- 2 or 3 section telescopic pole
- Available in 9 different lengths
- Reach in excess of 9 m (30 ft)
(max. pole length 9 m (30 ft) + body height)
- **ErgoTec®** Locking Cone included

TelePlus™ System

- Extendable modular telescopic pole
- 2 or 3 section unit
- Extensions 1,25 m (4 ft) or 2,00 m (6,5 ft) – simply attach
- Reach in excess of 10 m (32 ft)
(max. pole length 10 m (32 ft) + body height)
- **ErgoTec®** Locking Cone included

UniTec™

- 2 section telescopic pole
- Available in 3 different lengths
- Interior lock, twist right or left for locking
- Reach in excess of 4 m (13 ft)
(max. pole length 4 m (13 ft) + body height)

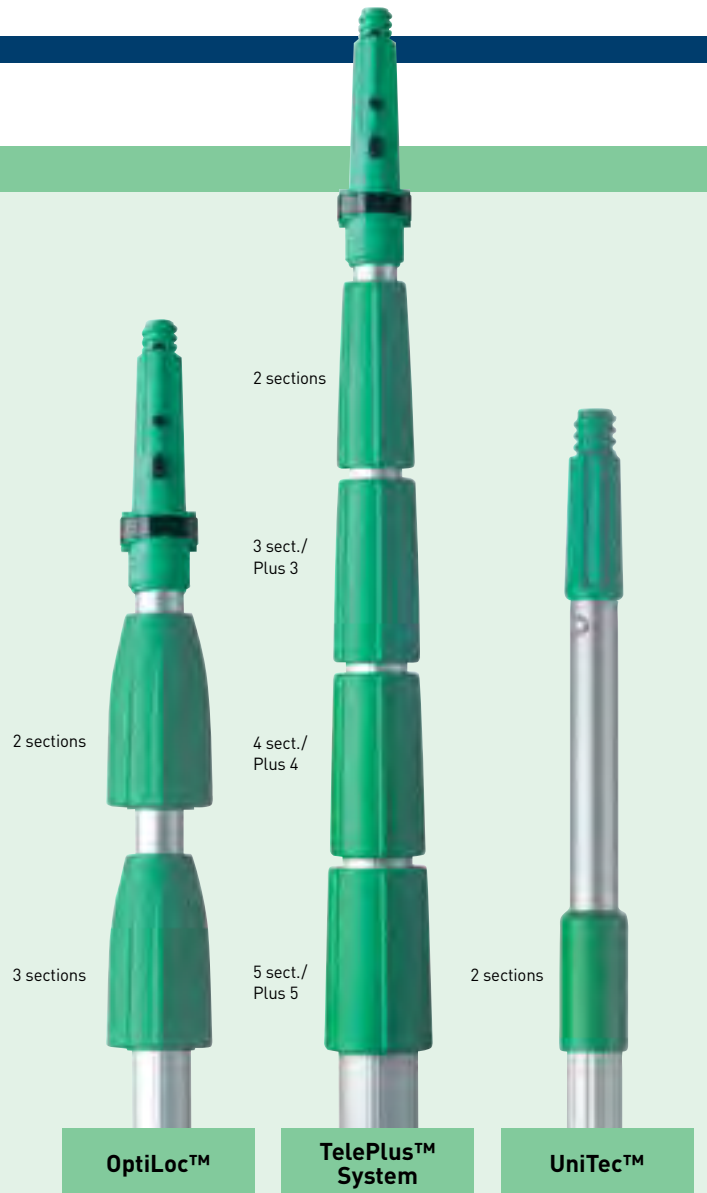

AVOID WORKING ON LADDERS

- **UNGER** telescopic poles allow you to work safely reaching up to 10 m height, while standing on the ground.
- The **UNGER** Locking Cone ensures safer operation, since the tools lock in place and cannot drop.
- Most accidents with ladders are caused by wrong handling, and not their damage.
- Always check whether cleaning from the ground is a safe option. If not, discuss safe alternatives and corresponding costs with your client.
- Always insist on safe working conditions. Do not risk your life just because the client does not accept certain services!
- Always choose the safest way. Ladders should not automatically be first choice simply due to convenience.
- Ladders become extremely unsafe under certain conditions: Rain makes the ground slippery; uneven ground or contaminations can result in tilting, or even falling.

Put together your own 10 pack



OptiLoc™ 2 SECTIONS

Telescopic pole with ErgoTec® Locking Cone.

Part No.	Size	€/piece
EZ120	1,25 m	17,46
EZ250	2,50 m	23,90
EZ300	3,00 m	27,72
EZ400	4,00 m	32,12
EZ500	5,00 m	37,98
EZ600	6,00 m	43,72

OptiLoc™ 3 SECTIONS

Telescopic pole with ErgoTec® Locking Cone.

Part No.	Size	€/piece
ED180	1,85 m	22,32
ED370	3,75 m	36,44
ED450	4,50 m	47,62
ED600	6,00 m	58,58
ED750	7,50 m	78,46
ED900	9,00 m	98,44



TelePlus™ 1,25 m SECTIONS

Modular Telescopic pole with ErgoTec® Locking Cone.

Part No.	Size	Sections	€/piece
TZ250	2,50 m	2	26,12
TD370	3,70 m	3	45,16
TV500	5,00 m	4	65,70
TF620	6,20 m	5	88,66



TelePlus3™ EXTENSION

Extension for 2 section units.

Part No.	Size	€/piece
T3120	1,25 m	19,06
T3200	2,00 m	29,32



TelePlus™ 2,00 m SECTIONS

Modular Telescopic pole with ErgoTec® Locking Cone.

Part No.	Size	Sections	€/piece
TZ400	4,00 m	2	35,14
TD600	6,00 m	3	64,52
TV800	8,00 m	4	95,84
TF100	10,00 m	5	129,88



TelePlus4™ EXTENSION

Extension for 3 section units.

Part No.	Size	€/piece
T4120	1,25 m	20,44
T4200	2,00 m	31,34



UniTec™ 2 SECTIONS

Telescopic pole with standard nylon cone.

Part No.	Size	€/piece
OS210	2,00 m	14,26
OS250	3,00 m	17,46
OS260	4,00 m	21,38



ONE STAGE POLE, 1 SECTION

With ErgoTec® Locking cone.

Part No.	Size	€/piece
HH240	60 cm	8,62

WINDOW CLEANING > CLASSICAL WINDOW CLEANING > TELESCOPIC POLE SYSTEM

i SWITCH YOUR ALUMINIUM POLE TO A WATERFED POLE

Practical entry level system that allows you to turn your **UNGER** aluminium pole into a waterfed pole for a minimum investment. Available as ready to use Pole Kits or a Conversion Kit to adapt your current pole. Combined with **UNGER's** best selling **HiFlo™** MultiLink Connectors and Brushes, these innovate Pole Kits deliver all the benefits of pure water cleaning at a low cost.

TelePlus™ CONVERTING KIT

Content:
 AFAET Thread adapter for Alu-Poles
 TPH10 **HiFlo™** Water hose 10 m, cpl. w/ connector
 FTG05 **HiFlo™** Plastic angle adapter, adjustable
 FTS27 **HiFlo™** Rectangular brush, soft

Part No.	Pack	€/piece
HAPCK	1	89,14



WATER HOSE COMPLETE

Durable hose for water supply from resin filter to the Brush.
 – High pressure hose
 – Standard hose connector for water filter included

Part No.	Size	Pack	€/piece
TPH10	10 m	1	21,18



HiFlo™ KIT

For cleaning walls, boats, caravans, etc. Complete with 11 m hose, brush, cleaning pills, angle & thread adapter.

Part No.	Content	Pack	€/piece
HF10G	HiFlo™ Kit Complete	1	132,24



TOOL HOLDER

Ideal for paint rollers, scrapers and other tools with handle.
 – Enables safe operation from the ground with secure tool handle lock
 – Adjustable angle that locks securely via bolt with nut
 – Fits to telescopic pole

Part No.	Pack	€/piece
PBR00	5	12,42



OptiLoc™ 3-SECTION, OUTER TUBE Ø 29 mm

Part No.	Size	For	Pack	€/piece
AP100	1,00 m	ED180, ED370	1	22,02
AP200	2,00 m	ED600	1	33,20



OptiLoc™ GRIP

Part No.	Size	For	Pack	€/piece
GR250	25 mm	OptiLoc & Lance+	5	1,26
GR300	29 mm		5	1,78



OptiLoc™ 3-SECTION, MIDDLE TUBE Ø 25 mm

Part No.	Size	For	Pack	€/piece
MR125	1,25 m	ED370	1	7,98
MR150	1,50 m	ED450	1	17,04
MR200	2,00 m	ED600	1	18,84



OptiLoc™ LOCKING COLLAR

Part No.	Size	For	Pack	€/piece
VS250	25 mm	OptiLoc & Lance+	5	4,44
VS300	29 mm		5	6,30

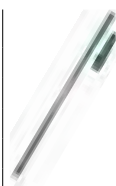

OptiLoc™ INNER TUBE Ø 21 mm

Part No.	Size	For	Pack	€/piece
IR060	0,60 m	EZ120, ED180	1	7,76
IR110	1,00 m	ED370	1	9,82
IR125	1,25 m	EZ250	1	10,90
IR150	1,50 m	EZ300, ED450	1	12,88
IR200	2,00 m	EZ400/500, ED600/750	1	15,66
IR300	3,00 m	EZ600, ED900	1	21,44



TelePlus™ THREADED CLAMP

Part No.	Size	For	Pack	€/piece
GKL25	25 mm	TelePlus Base	10	1,36

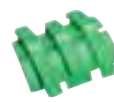

TelePlus™ THREADED PLATE

Part No.	Size	For	Pack	€/piece
GKL29	29 mm	TelePlus 3+4+5	10	1,42

ADAPTERS & MAINTENANCE



TelePlus™ GRIP 

Part No.	Size	Pack	€/piece
TPG25	25 mm	5	1,26
TPG29	29 mm	5	1,78
TPG33	33 mm	5	2,30
TPG37	37 mm	5	2,34



TelePlus™ LOCKING COLLAR 

Part No.	Size	Info	Pack	€/piece
YE250	25 mm	Sect. 2	5	3,82
YE290	29 mm	Plus 3	5	4,44
YE330	33 mm	Plus 4	5	6,30
YE370	37 mm	Plus 5	5	7,90





ANGLE JOINTS

Freely adjustable angle allows access to hard-to-reach places.

- Available in sturdy zinc version or lightweight plastic version
- Fits to telescopic pole

Part No.	Version	Pack	€/piece
CJA00	Zinc	5	12,58
CJN00	Plastic	5	9,24



GUTTER CLEANER  

Practical tool for safe cleaning of gutters from the ground.

- Easy to use - simply pick up and remove leaves and debris
- Fits securely to **UNGER** poles with Locking Cone to prevent falling off
- Angle adjustable, robust construction for durability

Part No.	Pack	€/piece
79600	10	12,90



THREAD ADAPTER 1/2"

With 1/2" thread. Fits conventional brooms.

- Adapter is inserted into pole and locks in place via stand spring

Part No.	Pack	€/piece
BE000	5	5,32



BULB CHANGER

For changing round light bulbs in high access areas without ladders. Rubber coated spring steel fingers.

- Enables safer and faster bulb change from the ground
- Fits to telescopic pole

Part No.	Pack	€/piece
BS010	5	19,22



ErgoTec® LOCKING CONE 

Securely locks tools on the telescopic pole.

- Compatible with all **UNGER** systems
- Quick and easy tool change via release button

Part No.	Pack	€/piece
NCA00	5	5,06



FLOOD SUCKER

For changing flat light bulbs in high access areas without ladders. With suction cups.

- Enables safer and faster bulb change from the ground
- Fits to telescopic pole

Part No.	Pack	€/piece
FS000	5	14,50



CONE

For attaching or screwing on tools.

- Cone is inserted into pole and locks in place via stand spring

Part No.	Pack	€/piece
NCA00	5	4,54





FIXI-SYSTEM

Innovative cleaning system, ideal for cleaning large and high surfaces such as boats and vehicles.

- Firmly retains sponge, cloth, by tightening the locking collar
- Fits on telescopic pole
- Stiff bristle brush effectively removes stubborn dirt

Part No.	Version	Pack	€/piece
FIXI0	Clamp	5	20,08
HBR00	Brush	5	7,26
SP010	Sponge	10	2,24



SPRING FOR NYLON CONE 

Part No.	Size	Pack	€/piece
STF00	for NCA00	10	0,58

WINDOW CLEANING > CLASSICAL WINDOW CLEANING > GLASS SCRAPERS



ErgoTec® SAFETY SCRAPER

Ergonomic scraper with safety mechanism.
Spare blades: SRB10, SRB20, SRBDB.

- Sturdy and durable
- Made of metal and rubber grip
- Retractable blade for safety

Part No.	Size	Info	Pack	€/piece
SR03K	4 cm	20 in a box	20	3,72
SR04K	4 cm	50 in a display box	50	3,72

SAFETY SCRAPER

**

Convenient scraper with safety mechanism.
Spare blades: SRB10, SRB20, SRBDB.

- Sturdy and durable
- Made of metal
- Retractable blade for safety

Part No.	Size	Info	Pack	€/piece
SR20K	4 cm	20 in a box	20	3,06
SR50K	4 cm	50 in a display box	50	3,06



ErgoTec® GLASS SCRAPER

Large surface blade with ergonomic bi-component handle.
Spare blades: TR100 (10 cm), TR150 (15 cm).

- Reversible sharp/blunt blade
- Simple slide blade change, with protective cap for safety
- Fits securely to pole with Locking Cone for extra safety

Part No.	Size	Info	Pack	€/piece
EG100	10 cm	Packed in display box	10	10,58
EG150	15 cm	Packed in display box	10	14,16



MINI SCRAPER

*

Handy plastic scraper with special locking mechanism.

- Extremely handy - fits anywhere!
- Reversible blade for safety

Part No.	Size	Info	Pack	€/piece
STMIN	4 cm	In plastic bucket	100	2,14

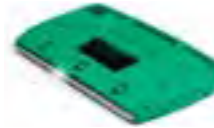

PROTRIM 10

The convenient lightweight scraper for every day.

Spare blades: TR100, KL100.

- Convenient and compact
- Retractable blade for safety
- Blade replacement and cleaning at push of a button

Part No.	Size	Info	Pack	€/piece
TX100	10 cm	Packed in display box	10	9,40



TRIM 10+1

**

Glass scraper in stainless steel holder. In practical plastic box, with 10 blades.

Spare blades: TR100, KL100.

- Strong stainless steel
- Fits in UNGER squeegee handles for telescopic poles
- Folding mechanism for safety

Part No.	Size	Info	Pack	€/piece
TM100	10 cm	1 case = 1 holder+10 blades	10 cases	6,08
TH100	10 cm	1 Box = 25 holder in bundles of 5	25	3,14



TRIM® PLASTIC BOX FOR BLADES

⚙️

Part No.	Size	Pack	€/piece
PLET0	for TM100, TR100	10	1,26



GLASS SCRAPER BLADES 10/15 cm

Glass blades with reversible sharp/blunt edge.
For TX100, EG100, TM100.

Part No.	Size	Info	Pack	€/piece
KL100	10 cm	250 loose blades	1 Box	59,58
TR100	10 cm	1 case = 25 blades	10 cases	7,16
TR150	15 cm	1 case = 25 blades	10 cases	10,58



GLASS SCRAPER BLADES 4 cm

For SR03K, SR04K, SR20K, SR50K, STMIN.

- Single edge razor blade with alu holder
- Easy to replace
- Blades in 10 pcs. dispenser
- Dispenser with tray for old blades

Part No.	Size	Info	Pack	€/piece
SRB10	4 cm	1 box = 100 blades	1 Box	18,20
SRB20	4 cm	1 box = 250 blades	1 Box	61,68
SRBDB	4 cm	1 box = 10 blades in dispenser	48 Box	3,92

SURFACE SCRAPERS



ErgoTec® SCRAPER

Ergonomic surface scraper with bi-component handle. Spare blades: RB100.

- Advanced ergonomic handle design for comfortable use
- Angled, heavy metal head
- Reversible sharp/blunt blade

Part No.	Size	Pack	€/piece
SH000	10 cm	10	11,46



ErgoTec® LONGHANDLE SCRAPER

The surface scraper with extra power with bi-component handle. Spare blades: RB100.

- Extra power due to 25 cm handle
- Reversible sharp/blunt blade
- Blade protection cap for safety

Part No.	Size	Pack	€/piece
SH250	10 cm	10	12,12



MAXISCRAPER

**

The handy surface scraper. Spare blades: RB100.

- Rubber coated ergonomic handle
- Blade protection cap for extra safety
- Reversible sharp/blunt blade

Part No.	Size	Pack	€/piece
STMAX	10 cm	10	7,48

BLADES FOR SURFACE SCRAPER

Reversible sharp/blunt edge blade. For STMAX, LH120, SH000, SH250.

- Sharp edges for removal of glue and carpet, for instance
- Blunt edge for removal of stucco and severe dirt

Part No.	Size	Info	Pack	€/piece
RB100	10 cm	1 dispenser = 10 blades	10 disp	5,72



i



SCRAPER INFO

→ BLADES

- Made of extra-sharp carbon steel and each blade is 4-way sharpened.
- Two sharp sides for twice the wear on selected scraper blades.
- Both sides lacquered for longer rust protection.
- Individual wrapping in wax paper helps to protect blades from rusting and sticking together.
- Safely packed and stored in convenient plastic dispenser. Blades remain dry and always available in safe dispenser.

ATTENTION! **UNGER** blades are razor-sharp. Always handle with greatest care.

→ EXPERT TIPS

- Check if glass is scratch-resistant and suitable for scraper use. Unsuitable for use – e.g. Plexiglas, crown glass, solar glass, safety glass (ESG). Follow the manufacturer's care instructions.
- Perform a scrape test in advance on an inconspicuous section.
- Before starting work, check the glass for damage and report it, if necessary.
- Check the blade for damage and change it, if necessary, or reverse it.
- The surface to be scraped should always be wet.
- It is best to use a release agent, e.g. „UNGER's Liquid“.
- Always scrape in one direction! Never pull the scraper back – scratch risk!
- After scraping, check if adhesive or stucco residues are stuck to blade. If necessary, change or reverse blade.

WINDOW CLEANING > CLASSICAL WINDOW CLEANING > CLOTHS, GLOVES

WINDOW MICROFIBRE CLOTH SYSTEM



WHY MICROWIPES ARE BETTER CLEANING TOOLS

Conventional cleaning tools often just redistribute dirt, creating dust (and more work!) leaving behind chemical residues and odor-causing bacteria.

Wet or dry, each **UNGER** MicroWipe is a powerful tool: it absorbs much water and even collects fine dust through static charge when used dry.

WHY DIFFERENT QUALITY GRADES?

- Purchase the right cloth for your needs and budget – get best ROI
- Decide between advanced features, standard quality or the basic version



ErgoTec® NINJA MICROWIPE™



Best in Class premium Microfibre cloth.

- 400 g/m² material thickness (very high water absorption)
- Withstands 500 wash cycles
- Extra reinforced edge seam
- Corner pockets for detailing at height (fits on telescopic pole)
- Scrubbing corners for spot cleaning

Part No.	Size	Info	Pack	€/piece
MN40H	40 x 40 cm	Standard size	5	4,80
MN55H	55 x 55 cm	Medium size	5	7,80
MN60H	80 x 60 cm	Extra size	5	12,80
MN40B	40 x 40 cm	5 cloths in a washbag	5	5,80
MN55B	55 x 55 cm	5 cloths in a washbag	5	8,80
MN60B	80 x 60 cm	5 cloths in a washbag	5	13,80

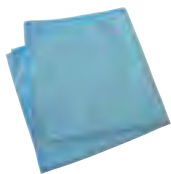

NEW

MICROWIPE™ LITE



Microfibre Cloth with great value.

- 300 g/m² material thickness
- Withstands 200 wash cycles

Part No.	Size	Pack	€/piece
MF40E	40 x 40 cm	5	1,58
MF60E	60 x 80 cm	5	3,98



MICROWIPE™



The "Original" microfibre cloth.

- 350 g/m² material thickness
- Withstands 500 wash cycles
- Reinforced edge seam

Part No.	Size	Info	Pack	€/piece
MF40L	40 x 40 cm	Standard size	10	3,80
MF60L	60 x 80 cm	Extra size	5	8,80



CHAMOIS BEST QUALITY

Professional quality sheepskin chamois. Available in two sizes.

- Excellent for glass cleaning
- Quality checked by hand

Part No.	Size	Pack	€/piece
FS450	ca. 0,4 m ²	5	29,00
FS550	ca. 0,5 m ²	5	33,70



SCRIM

For polishing and spot cleaning of glass surfaces.

- Robust and durable
- Generous size for large surface
- Versatile best seller.

Part No.	Size	Pack	€/piece
SCRM1	92 x 92 cm	10	9,28

WINDOW GLOVES



PROTECTIVE GLOVES

- Two quality grades of neoprene gloves to protect your hands in winter from cold.
- Tip 1: Slip in with wet hands. Body warmth will warm the water and keep hands warm.
- Tip 2: The gloves are smaller than usual sizes. Order one size bigger than you wear normally.
- Pole gloves protect your hands when working with telescopic poles.
- No more injuries and no problem with hot poles in summer.



NOTE

The gloves are relatively small.
In case of doubt, please order one size larger.



ErgoTec® NEOPRENE GLOVES

★★★

Protective gloves against cold, Textile Neoprene.

- Tear resistant stitching and glue seal along seams for durability
- Knuckle inserts and flexible curved shape for ultra comfort
- Non slip palm with screened-on silicone for secure grip
- Adjustable Velcro wrist strap

Part No.	Size	Info	Pack	€/piece
GLO2S	S	Small	5	39,60
GLO2L	L	Medium	5	39,60
GLO2X	XL	Large	5	39,60
GLO2Z	XXL	Extra Large	5	39,60



NEOPRENE GLOVES

★★

Protective gloves against cold. Rubber Neoprene.

- Tear resistant stitching and glue seal along seams for durability
- Soft and comfortable on inside
- Non slip palm for secure grip
- Adjustable Velcro wrist strap

Part No.	Size	Info	Pack	€/piece
GLOV1	S	Small	10	29,04
GLOV2	L	Medium	10	29,04
GLOV3	XL	Large	10	29,04
GLOV4	XXL	Extra Large	10	29,04



POLE GLOVES

★★★

Protective gloves for pole work.

- Reinforced, tripple seams, water resistant coating
- Security and protection combined with extremely high durability
- Knuckle inserts and flexible curved shape for ultra comfort
- Superior comfort
- Hook and loop for secure fitting
- Webbing loop for added ease while putting glove on

Part No.	Size	Info	Pack	€/piece
GLOC1	S	Small	5	42,46
GLOC2	L	Medium	5	42,46
GLOC3	XL	Large	5	42,46
GLOC4	XXL	Extra Large	5	42,46

WINDOW CLEANING > CLASSICAL WINDOW CLEANING > BELTS, POUCHES



ErgoTec® BELT

Solid belt for carrying tool holders. 4 eyes, padding, quick release.

Part No.	Size	Pack	€/piece
BSTBT	80 – 130 cm	1	18,60



ErgoTec® SCRAPER HOLDER

3 compartments for all UNGER scrapers. Locks with Velcro fastener.

Part No.	Size	Pack	€/piece
BSSCH	18 x 22 cm	1	26,62



ErgoTec® STRAPPAIR

Supports the belt and distributes the weight. With padding and solid spring hooks. Fits into eyes of belt.

Part No.	Size	Pack	€/piece
BSSTP	max. 140 cm	1	13,24



ErgoTec® BOTTLE HOLDER

Perfect for carrying along cleaning agents, soap, etc.

Part No.	Size	Pack	€/piece
BSBTH	10 x 18 cm	1	10,56



ErgoTec® POUCH

3 compartments. Dry and damp cloths can be stored separately. Front pocket with flap and Velcro fastener.

Part No.	Size	Pack	€/piece
BSPOU	30 x 37 cm	1	17,24



ErgoTec® DOUBLE HOLSTER

Strong leather holster with two loops. With snap fasteners for easy attachment to belt.

Part No.	Size	Pack	€/piece
BSDHR	8 x 13 cm	1	19,94



ErgoTec® PERSONAL BAG

For personal items, like note pad, mobile phone, pen. Includes key hook.

Part No.	Size	Pack	€/piece
BSPBG	15 x 20 cm	1	13,24

ErgoTec® BELT SYSTEM MASTERKIT

Complete – all 7 parts
Belt, Strapspair, Pouch, Personal Bag, Scraper Holder, Bottle Holder, Double Holster

Part No.	Pack	€/piece
BSMKT	1	120,24



BUCKET ON A BELT

Holder for squeegee, washer, scraper.

- Conveniently holds all important tools
- Ideal for use on ladders, indoors or in narrow spaces
- Clip lock for quick fastening

Part No.	Info	Pack	€/piece
BB010	Ninja: 1 washer, 2 squeegees, 1 scraper	5	21,12
BB020	Classic: 1 squeegee, 1 washer, 1 scraper	5	21,12



CANVAS APRON

Made of solid nylon with 2 large compartments for cloths, scraper, etc.

- All cloths quickly available
- Protected storage for cloths and leather
- Sturdy, solid and very durable.

Part No.	Pack	€/piece
SRZ10	10	29,06



THE BELT

For attaching bucket and other tools on a belt.

- Convenient loops for tools (squeegee, etc.)
- Clip lock for quick fastening
- Made of solid nylon material

Part No.	Pack	€/piece
UB000	5	18,90



HENRY'S DOUBLEHOLSTER

Leather tool holder, two compartments. For fastening to belt.

- Convenient for holding squeegees and washers
- Extremely solid quality leather
- Fits on most belts

Part No.	Pack	€/piece
HT000	5	19,04

WINDOW CLEANING > CLASSICAL WINDOW CLEANING > BUCKETS, SOAP



BUCKET 28 L

Large bucket for glass cleaning.

- Holds 45 cm squeegee
- Features measuring marks and 2 drains
- Available accessories: lid, bucket barge, castors, bucket sieve

Part No.	Size	Pack	€/piece
QB220	28 ltr	5	22,58



UNGER's GEL

Window cleaning soap for direct application onto washer.

- Economic, covers large areas
- Excellent cleaning power
- Apply directly onto washer

Part No.	Size	Pack	€/bottle
FG050	0,5 ltr	10	6,70



RUB OUT

Professional stain remover.

- Removes hard-water stains, rust, mineral deposits, lime scale and scum
- Scrubs stains without harming the surface

Part No.	Size	Pack	€/bottle
RUB20	0,5 ltr	12	13,74

BUCKET 18 L

Bucket for glass cleaning.

- Lightweight and easy to handle
- Metal handle with plastic enclosure
- Includes plastic holder for washer and squeegee

Part No.	Content	Info	Pack	€/piece
QB120	18 ltr	Complete w/ accessories	10	12,42



ACCESSORIES FOR BUCKET 28 L

Part No.	Product	Pack	€/piece
QB060	Bucket Sieve	5	11,96
QB080	Lid	5	13,24
QB070	Set of Castors (1 Set = 4 casters)	5 Sets	11,20
QB230	Bucket Barge	5	31,60



UNGER's LIQUID

Window cleaning soap, liquid. Concentrate. Mixing ratio 1:100.

- Economic and eco-friendly
- Excellent cleaning power
- Simply add to water

Part No.	Size	Pack	€/bottle
FR100	1 ltr	12	6,04
FR500	5 ltr	2	22,96



THE PILL

Window cleaner. 1 pill for 10 litres of water.

- Economic and eco-friendly
- Excellent cleaning power

Part No.	Info	Pack	€/strip
PL100	10 pills on a strip	10 strips	3,68

CLEANING SETS



Quality Tools for Smart Cleaning



ErgoTec® SET

★★★

Top of the range complete glass cleaning set in a solid nylon bag.

- Contains comprehensive selection of ErgoTec® and other UNGER tools
- Compact for transportation

Content

MF40L	(3x) MicroWipe™ Microfibre Cloth, 40 x 40 cm
ETG00	ErgoTec® Squeegee Handle
NS350	StripWasher® Micro Sleeve, 35 cm
EH350	ErgoTec® T-bar, 35 cm
SH000	ErgoTec® Glass Scraper, 10 cm
PCLIP	Plastic Clips
RR920	Soft Rubber, 92 cm
SR03K	ErgoTec® Safety Scraper
NE250	S-Channel with Soft Rubber, 25 cm
NE350	S-Channel with Soft Rubber, 35 cm
NE450	S-Channel with Soft Rubber, 45 cm
PL100	The Pill, Glass Cleaner, 10 pills on a strip
EZ250	OptiLoc™ Telescopic pole, 2 sections, 2,50 m (8 ft)

Part No.	Pack	€/piece
ETSET	1	120,24



TRANSET

★★

Cleaning set in convenient nylon bag.

- Contains selection of UNGER window cleaning tools
- Ideal for new starter in window cleaning
- Compact for transportation

Content

PR000	Pro-Squeegee Handle
NE250	S-Channel with Soft Rubber, 25 cm
NE350	S-Channel with Soft Rubber, 35 cm
NE450	S-Channel with Soft Rubber, 45 cm
RR920	Soft Rubber, 92 cm
WC350	StripWasher® Original Strip Pac, 35 cm
EZ250	OptiLoc™ Telescopic Pole, 2 sections, 2,50 m (8 ft)
FIX10	FIXI Clamp
HBR00	FIXI Brush
SP010	FIXI Sponge
SR20K	Safety Scraper
TX100	ProTRIM10 Scraper

Part No.	Pack	€/piece
TRS00	1	138,58



PRO GLASS CLEANING SET

★★

Starter kit with all essential UNGER window cleaning tools.

- Ideal for new starter in window cleaning

Content

EZ250	OptiLoc™ Telescopic Pole, 2 sections, 2,50 m (8 ft)
WC450	StripWasher® OriginalStripPac, 45 cm
WS450	StripWasher® Original Sleeve, 45 cm
PR000	Pro Squeegee Handle
NE350	S-Channel with Soft Rubber, 35 cm
NE450	S-Channel with Soft Rubber, 45 cm
RR92H	Replacement Hard Rubber, 92 cm
TX100	ProTRIM10 Scraper
SP010	Sponge for FIXI Clamp

Part No.	Pack	€/piece
PWK00	1	77,34



WINDOW CLEANING SET

★★★

The practical Starter Set.

Part No.	Pack	€/piece
AK013	1	39,78

LITTER PICKING & REACHING AIDS

NiftyNabber® GRABBER AND BAGGER SYSTEM

Perfect for eco-friendly waste removal, indoor and outdoors, in industrial or domestic environment. Durable, ergonomic and reliable **UNGER** grabbers are also perfect for easy reach and bend-free pick up of many daily objects.



NiftyNabber® BAGGER

A durable and weatherproof 180 l waste carrier that is a great multi-tasking alternative to plastic bags and the perfect companion to **UNGER**'s super tough litter pickers.

Robust

Can be pulled across the floor, asphalt or ground due to solid plastic bottom and carry loops. Protects plastic bags from splitting.

Practical

Collapses flat and fastens with Velcro for compact storage and transportation. Can be used indoors or outdoors as a temporary waste disposal or recycling unit during the event.

Ergonomic

Allows to avoid unnecessary bending or lifting heavy bags. Always open for easy and safe access without touching litter. Made of robust material for reduced injury risk from sharp waste.

Part No.	Size	Colour	Pack	€/piece
NB300	180 l	●	1	33,08
NB30B	180 l	●	1	33,08



PAPER PICKER

A lightweight tool with a strong metal pin for removing debris such as paper and cans.

Ergonomic Design

No bending or back strain.
Handle design positions arm and hand in the optimal position for reaching debris.

Carbon Steel Shaft

Lightweight and rust resistant.

Strong Metal Pin

Long enough for picking up several pieces of debris at once.
Will punch through and hold even thick, aluminium cans.

Part No.	Size	Pack	€/piece
PPPP0	100 cm	10	10,48
PINP0	Replacement Pin Plugs for Picker	10	3,14



NiftyNabber® TRIGGER GRIP

Durable litter picker with a strong internal metal bar, a 360° fully rotating head and a highly responsive trigger grip handle. Available in 4 lengths.

Robust metal bar inside

For extra durability and grab power. Will not stretch or snap, like string mechanism on other grabbers.

Trigger Grip Handle

Responsive mechanism for greater comfort. Made with glass-reinforced plastic for increased durability.

Rubber Claws

Reliable grip even with most difficult shapes. Opens up to 13 cm wide and holds items up to 4,5 kg.

Rotating Head

Access narrow areas with 360° rotating head. Locks securely every 90°.

Aluminum Shaft

Durable and rust-resistant. Lightweight, designed to decrease fatigue.

Part No.	Size	Pack	€/piece
NT060	60 cm	5	14,26
NT080	80 cm	5	16,48
NT090	90 cm	5	18,70
NT100	100 cm	5	19,82

NiftyNabber® PRO

A heavy duty litter picker with a strong internal metal bar, powerful claws and robust steel shaft. Available in 4 lengths, including 2,50 m long reach version!

Steel Claws

Molded rubber overlay for an extra-secure grip.
Powerful hold of small or oddly shaped objects – broken glass, cigarettes or coins.
Opens up to 15 cm wide.

Rugged Design

Shaft made from durable steel with rust resistant coating for dependable use over long time. Strong enough for heavy-duty work, light enough to protect from back and arm strain. Overall steel construction wears well under the rigours of every day use.

Part No.	Size	Pack	€/piece
NN400	40 cm	5	16,52
NN900	90 cm	10	22,12
NN140	140 cm	5	26,56
NN960	250 cm	6	46,06

MAINTENANCE CLEANING

Professional Tools for daily and project cleaning tasks.





Efficient, Ergonomic, Hygienic

UNGER Maintenance Cleaning tools provide simple solutions for many cleaning tasks. They help professionals to perform their job better, faster and easier.

Their ergonomic design and state of the art functionality ensure full compliance with modern cleaning requirements.

 **COLOUR CODING** Products are coded or can be coded for usage in specific area.

RECOMMENDED USAGE

-  Restroom Cleaning
-  Wash basin and Mirror
-  Food and Bar Area
-  General Low Risk Area
-  Bespoke or Site Specific



The World of Maintenance



FLOOR CLEANING



p. 68

UNGER Floor Care & Maintenance Tools provide simple solutions for many cleaning tasks. This range includes Floor Squeegees, Floor Scrapers and a Waxing System.

SMARTFIT™
AQUADOZER®

WATERWAND™
SMARTCOLOR™



RESTROOM CLEANING



p. 78

The **UNGER** Bathroom and Toilet Cleaning System consists of ideally matched and ergonomically designed tools with an effective flow process for highly hygienic daily and project cleaning. The System is colour coded in red to prevent bacterial cross contamination.

ERGOtec®
NIFTYNABBER®



DUSTING & BRUSHES



p. 80

A wide range of helpful and innovative dusting tools. Can be used as hand tools or on telescopic poles. Always work safe and quick from the ground.

STARDUSTER®



MICROFIBRE CLOTH SYSTEM



p. 76

Five-colour system for optical coding optimises cleaning by dividing tools and areas... Matching coded tools assigned to specific cleaning areas prevent dangerous bacterial contamination.

SMARTCOLOR™
MICROWIPE™

**With microfibre
Guideline!**

MAINTENANCE CLEANING > FLOOR CARE > SmartFit™ > FLOOR SQUEEGEES



FLOOR CLEANING

A Global Revolution in Floor Cleaning: SmartFit™

The innovative Floor Squeegee System, designed to save money and built to last.

Solid design for many floor types. Move large volumes of debris with high quality closed cell twin foam rubber blades.



FLEXIBLE COLOUR CODING

- Prevents cross contamination
- Clear assignment of cleaning areas
- Flexible chip system
- One item with 4 colour options
- Smart inventory control

RECOMMENDED USAGE

- Restroom Cleaning
- Wash basin and Mirror
- Food and Bar Area
- General Low Risk Area
- Bespoke or Site Specific

UNIVERSAL POWER SOCKET

- Secure hold, squeegee stays attached
- Easy tightening and loosening of socket
- Fits wide range of industry handle
- Longer product life cycle, no breaking

EASY FLUSH & RINSE

- Open socket design
- Fast cleaning and drying of socket
- Minimizes bacteria build up
- Washable in dishwasher



i FLOOR RUBBER INFO

- **EPDM = Ethylen-Propylen-Dien Characteristics**
High weather and water resistance. Ozone and thermo resistance. High elasticity. Also frequently used for seals or roof coverings. When applied for floor care, best characteristics due to hardness and resistance in AquaDozer squeegee.
- **SBR = Styrol-Butadien Characteristics**
Good resistance to water, alcohol, acids and bases, low moisture expansion, not suitable for oil, etc.
Thermal application range: Approx. -40 °C to +70 °C.
- **Natural Foam rubber**
All-purpose application on uneven surfaces. Good abrasion resistance. Primary use in water. Only medium resistance against acid solvents and oil.

FLOOR SQUEEGEES

SmartFit™ SANITARY STANDARD

Floor Squeegee with double black foam rubber and plastic body.
 – Universal Power Socket, fits all standard handles Ø 20 – 29,5 mm
 – Flexible Colour Coding with colour chips
 – Open socket design for hygienic maintenance

Part No.	Size	Pack	€/piece
PM45G	45 cm	10	18,02
PM55G	55 cm	10	21,74

SmartFit™ BRUSH

Floor Squeegee with double black foam rubber and plastic body with brush. 2 in 1. Complete Kit with 3-Section Pole. Ready to work. Heavy Duty Squeegee.
 – Universal Power Socket, fits all standard handles Ø 20 – 29,5 mm
 – Red foam rubber, oil and acid resistant
 – Open socket design for hygienic maintenance

Part No.	Size	Pack	€/piece
PB45G	45 cm	10	23,96
PB55G	55 cm	10	26,90

SANITARY SQUEEGEE

Squeegee with twin foam rubber blade, black. ACME thread.
 – Plastic body for increased hygiene.
 – Acid-proof, rust-proof, scratch-proof
 – With splash-guard

Part No.	Size	Pack	€/piece
PM45A	45 cm	10	14,98
PM55A	55 cm	10	18,76

SANITARY COMBI BRUSH

2 tools in one: Brush with polypropylene bristles and squeegee with twin foam rubber blade, black. ACME thread.
 – Scrubber to remove dirt
 – Foam rubber blade for drying floors and joints
 – Very sturdy, but lightweight

Part No.	Size	Pack	€/piece
PB45A	45 cm	10	21,02
PB55A	55 cm	10	23,98

WaterWand™ STANDARD

For lighter jobs with double-lip black foam rubber.

- Great for cleaning joints
- Sturdy metal body
- For streak free floor drying

Part No.	Size	Pack	€/piece
MW450	45 cm	10	3,82

WaterWand™ HEAVYDUTY

Reinforced version for heavier jobs with double-lip black rubber.

- Great for cleaning joints
- Sturdy metal body
- For streak free floor drying

Part No.	Size	Pack	€/piece
HM450	45 cm	10	7,82
HM550	55 cm	10	8,54
HM750	75 cm	10	12,40

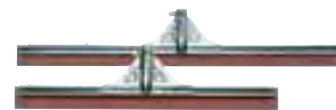
WaterWand™ HEAVYDUTY RED

Reinforced version for heavy duty jobs with double-lip red foam rubber, oil and acid resistant.

- Great for cleaning joints
- Sturdy metal body
- For streak free floor drying

Part No.	Size	Pack	€/piece
HW550	55 cm	10	11,10
HW750	75 cm	10	16,42

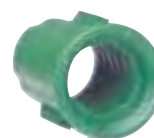
WaterWand™ ACME-THREAD-INSERT

For all WaterWand™.

Part No.	Pack	€/piece
FWA10	10	2,98

MAINTENANCE CLEANING > FLOOR CARE > FLOOR SQUEEGEES, MAINTENANCE



AquaDozer®

For heavy-duty jobs, black EPDM rubber. Ideal for industrial environment.
 - Sturdy construction
 - Solid handle socket
 - Optimal for industrial application

Part No.	Size	Version	Pack	€/piece
FP600	60 cm	straight	6	33,08
FP900	90 cm	straight	6	41,34
FP60C	60 cm	curved	6	37,62
FP90C	90 cm	curved	6	45,80



**AquaDozer®
SPARE RUBBER**

Black EPDM rubber, for all AquaDozer®.

Part No.	Size	Pack	€/piece
FRR60	60 cm	10	14,96
FRR90	90 cm	10	22,54



**AquaDozer®
ACME-THREAD-INSERT**

For all AquaDozer®.

Part No.	Pack	€/piece
FAA10	10	3,70



PUSH PULL

For heavy-duty jobs. Ideal for industrial environment. For pushing and pulling of standard water volumes.

- Straight, hard SBR rubber
- Frame made of lightweight, solid aluminium
- Adjustable handle socket

Part No.	Size	Pack	€/piece
FH600	60 cm	10	16,84
FH800	80 cm	10	20,54



EDTBG

EDPBR

ERGO DUST PAN

For quick and thorough waste removal.

- Ergonomic and convenient
- Dust pan opens when raised, and retains the waste
- Telescopic handle (EDTBG), fits perfect to body size

Part No.	Size	Type	Pack	€/piece
EDTBG	83 x 30 cm	telescopic	6	53,08
EDPBR	83 x 30 cm	standard	6	51,08



WonderWaxer

Wax applicator. Complete, 140 cm handle.

- For applying wax to wooden floors
- Convenient operation while standing
- Flexible head, sleeve with snap fasteners

Part No.	Size	Pack	€/piece
QS140	40 cm	10	23,38

WonderWaxer REPLACEMENT SLEEVE

Part No.	Size	Pack	€/piece
QS010	40 cm	10	11,68

i WONDER WAXER





The super light and flexible WonderWaxer is ideal to reach almost all floor areas. Its flexible head can be angled as required. The sleeve is replaceable and due to a special holding fixture sits firmly on the T-bar. Makes a perfect team, together with the large bucket.

> FLOOR HANDLES



Quality Tools for Smart Cleaning

HANDLES

HANDLE DIAGRAMM				
	AL140	AL14A	AL14T	AL14G
AquaDozer®				
with ACME thread insert		●	●	
without thread insert			●	
WaterWand™				
with ACME thread insert		●	●	
without thread insert	●			●
SANITARY & COMBI		●	●	
PUSH PULL	●			●
SmartFit®	●	●	●	●



ProAlu 1,5° HANDLE, 3 SECTIONS

Conical handle socket, 1,40 m, Ø 25 mm.
 – Aluminium, lightweight and solid
 – 3-sections knock down, for better transport
 – Optimal for WaterWand™

Part No.	Size	Pack	€/piece
AL14G	1,40 m	5	9,32

ProAlu 1,5° HANDLE

Conical handle socket, 1,40 m, Ø 25 mm.
 – Lightweight and solid aluminium
 – Ø 25 mm, length 1,40 m
 – Optimal Sanitary and Sanitary Combi Brush

Part No.	Size	Pack	€/piece
AL140	1,40 m	10	9,32



ProAlu ACME

Top made of zinc alloy, ACME thread. 1,40 m, Ø 25 mm.
 – Lightweight and solid aluminium
 – Ø 25 mm, length 1,40 m
 – Optimal for WaterWand™ Squeegee

Part No.	Size	Pack	€/piece
AL14A	1,40 m	10	13,50



ProAlu 3,0°

Conical handle socket, also for ACME thread. 1,40 m, Ø 25 mm.
 – Lightweight and solid aluminium
 – Ø 25 mm, length 1,40 m
 – Optimal for WaterWand™ Squeegee

Part No.	Size	Pack	€/piece
AL14T	1,40 m	10	14,98



MOP HANDLE

For Standard Mops. 1,40 m, Ø 23 mm.
 – Lightweight and solid aluminium
 – Ø 23 mm, length 1,40 m
 – To snap in mop holders

Part No.	Size	Pack	€/piece
MH140	1,40 m	20	5,28

MAINTENANCE CLEANING > FLOOR CARE > FLOOR SCRAPERS



FLOOR SCRAPER LIGHT DUTY

For light jobs, with ergonomic two-component handle.
 - Efficient for light-duty jobs
 - Convenient operation while standing
 - Reversible sharp/blunt blade

Part No.	Handle	Blade	Pack	€/piece
LH120	1,20 m	10 cm	10	16,70

FloorScraper Blades 10 cm - Double sided blade sharp/dull.

RB100	1 Dispenser = 10 blades	10 disp.	5,72
-------	-------------------------	----------	------



FLOOR SCRAPER MEDIUM DUTY

For medium-duty jobs, alu handle 1,50 m.
 - Efficient for medium-duty jobs
 - For industrial scraping
 - Reversible sharp/blunt blade

Part No.	Handle	Blade	Pack	€/piece
MDSC0	1,50 m	15 cm	10	30,04

FloorScraper Blades 15 cm - Double-edged blade sharp/dull.

MDSB0	1 Dispenser = 10 blades	5 disp.	10,96
-------	-------------------------	---------	-------



FLOOR SCRAPER HEAVY DUTY

For heavy duty jobs, steel handle, 1,50 m.
 - Efficient for heavy duty jobs
 - Convenient operation while standing
 - Reversible sharp/blunt blade

Part No.	Handle	Blade	Pack	€/piece
HDSS0	1,50 m	20 cm	1	56,42



FLOOR SCRAPER HEAVY DUTY TELE

For heavy duty jobs, telescopic pole, 0,90-1,50 m.
 - Efficient for heavy duty jobs
 - Extendable
 - Reversible sharp/dull blade

Part No.	Handle	Blade	Pack	€/piece
HDSC0	0,90-1,50 m	20 cm	5	75,22

Floor Scraper Blades 20 cm - Double-edged blade sharp/dull

Part No.	Info	Pack	€/piece
HDSB0	1 Dispenser = 10 blades	5 disp.	28,52

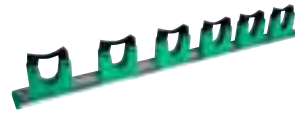

HANG UP

All-purpose tool holder. Tools are inserted from front.
Available in 2 versions (3 or 6 holders).
 - Tools snap into rubber rolls in front
 - Practical and ideal for quick access
 - Simply attach to wall, using dowels

Part No.	Size	Info	Pack	€/piece
H0350	35 cm	3 holders	5	13,98
H0700	70 cm	6 holders	5	23,24

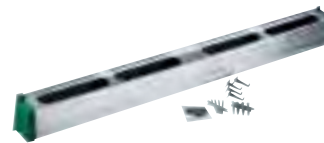

HOLD UP

Tools are inserted from the bottom and held in place by strong rubber grips.
 - Simply attach to wall, using dowels
 - Equipped with small hooks on front to hang up smaller tools

Part No.	Size	Pack	€/piece
HU450	45 cm	5	21,16
HU900	90 cm	5	35,24



HOLD UP REPLACEMENT RUBBER

Part No.	Pack	€/piece
EG450	10	3,12

DOUBLE BUCKET & MOPHOLDER



SmartColor™ COMBO 30 L



Complete dual bucket with press.

- Two compartments keep clean and dirty water separated
- 2 convenient handles keeps bucket straight
- Emptying via drain spout and dump spout
- Labels included for colour coding
- Complete with vertical press
- Available accessories: Adapter hose WH180, side bucket SMSBG

Part No.	Content	Colour	Pack	€/piece
COMBG	30 L	●	1	133,20
COMBR	30 L	●	1	133,20



SmartColor™ SIDE BUCKET



Additional storage on dual bucket.

- Easy assembly
- Snaps to side of 30 l bucket
- 1 unit contains 1 side bucket
- Fits on 15 l and 30 l buckets

Part No.	Colour	Pack	€/piece
SMSBG	●	1	9,98



SmartColor™ SIDE PRESS



Part No.	Colour	Pack	€/piece
SPREG	●	1	66,56
SPRER	●	1	66,56



SmartColor™ COMBO 15 L



Compact complete dual bucket with press.

- Two compartments keep clean and dirty water separated
- Convenient handle, keeps bucket straight
- Labels included for colour coding
- Complete with vertical press
- Available accessories: Adapter hose WH180, side bucket SMSBG

Part No.	Content	Colour	Pack	€/piece
COMSG	15 l	●	1	99,00
COMSR	15 l	●	1	99,00

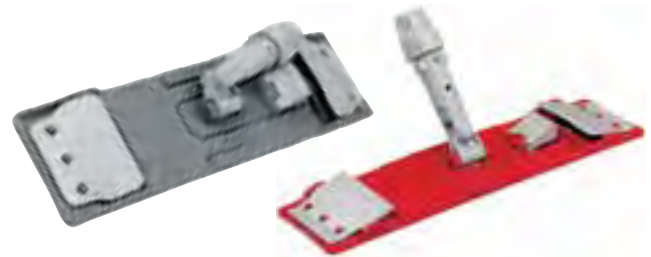

SmartColor™ MOPHOLDER



Flat mop holder with holding clips.

- UNGER mops fit securely and can stay on mop holder during wringing
- Universal joint; reaches all corners and is flat
- Reduces cleaning time by up to 10 %
- Folds at the push of a button, for wringing or replacing mop
- New handle socket, for cone or handles with 23 and 25 mm diameter, respectively

Part No.	Size	Colour	Pack	€/piece
SM40G	40 cm	●	5	33,22
SM40R	40 cm	●	5	33,22



EASY ADAPTER WATERHOSE

Heavy duty adapter hose for dual bucket.

- Fits on every standard water tap
- Bucket is filled on site
- Prevents unnecessary walks

Part No.	Size	Pack	€/piece
WH180	180 cm	10	12,60

MAINTENANCE CLEANING > FLOOR CARE > MICROFIBRE MOPS



SmartColor™ MICRO MOP 15.0

Microfibre mop for severe contamination and rough floors.

- 15 mm long fibres, ideal for tiles and stone floors
- Cut microfibre for improved dirt absorption and streak-free cleaning
- Reduces bacterial contaminations up to 96%
- Holds 6 times its own weight in water - manages large areas
- Easy to wash (machine wash and dry up to 500 times)
- Available in 4 colours for proper colour coding
- Fits on **UNGER** flat mop holder SM40G

Part No.	Size	Colour	Pack	€/piece
MM40R	40 cm	●	5	11,34
MM40Y	40 cm	●	5	11,34
MM40G	40 cm	●	5	11,34
MM40B	40 cm	●	5	11,34



SmartColor™ MICRO MOP 7.0

Microfibre mop for medium contamination and rough floors.

- 7 mm long fibres - ideal for floors with rough surface and flat joints
- Cut microfibre for improved dirt absorption and streak-free cleaning
- Reduces bacterial contaminations up to 96%
- Holds 6 times its own weight in water - manages large areas
- Easy to wash (machine wash and dry up to 500 times)
- Fits on **UNGER** flat mop holder SM40G

Part No.	Size	Colour	Pack	€/piece
MD40R	40 cm	●	5	10,00
MD40Y	40 cm	●	5	10,00
MD40G	40 cm	●	5	10,00
MD40B	40 cm	●	5	10,00



SmartColor™ DAMP MOP

Microfibre mop for damp cleaning of smooth floors.

- Optimal in areas that need to dry quickly
- Cleans streak-free and uniformly
- High absorption and low moisture release. High loop density
- Easy to wash (machine wash and dry up to 500 times)
- Fits on **UNGER** flat mop holder SM40G

Part No.	Size	Colour	Pack	€/piece
DM40R	40 cm	●	5	8,78
DM40Y	40 cm	●	5	8,78
DM40G	40 cm	●	5	8,78
DM40B	40 cm	●	5	8,78

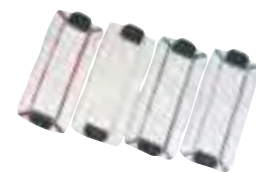

SmartColor™ SPILL MOP 1 L

Microfibre mop for absorption of large amounts of liquid.

- 14 mm long microfibrils, extra-large surface
- Absorbs up to 1 l liquid immediately
- Easy to wash (machine wash and dry up to 500 times)
- Fits on **UNGER** flat mop holder SM40G

Part No.	Size	Colour	Pack	€/piece
MA45R	47 x 21 cm	●	5	15,18
MA45Y	47 x 21 cm	●	5	15,18
MA45G	47 x 21 cm	●	5	15,18
MA45B	47 x 21 cm	●	5	15,18



SmartColor™ DAMP MOP PADHOLDER

- Swivel head - glides easily across floors
- Features Velcro backing for easy pad fitting
- Use with SmartColor DV40 Series damp mop pads

Part No.	Size	Pack	€/piece
SV40G	50 cm	5	20,80

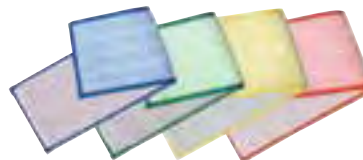

SmartColor™ DAMP MOP PAD

- 100% microfibre pad features high density looped pile for streak free results
- Machine washable up to 500 times
- Uses less water and solution so floors dry quicker
- Attaches to PadHolder with Velcro backing
- Use with SV40G DampMop Pad Holder or any standard 40 cm pad holder

Part No.	Size	Colour	Pack	€/piece
DV40R	50 cm	●	5	8,78
DV40Y	50 cm	●	5	8,78
DV40G	50 cm	●	5	8,78
DV40B	50 cm	●	5	8,78

> MOPHANDLES, BRUSHES, SETS



SmartColor™ MICROFIBRE STRING MOP

- Microfibre strings increase liquid and dirt absorption
- Looped ends provide greater floor coverage and control; no tangling while laundering
- Faster and streak free floor drying
- Use with **UNGER** String Mop Holder Clip or any standard mop holder and handle
- Heavy duty weights 450 g, 32 strands

Part No.	Colour	Quality	Pack	€/piece
ST30R	●	310 g	5	11,42
ST30Y	●	310 g	5	11,42
ST30G	●	310 g	5	11,42
ST30B	●	310 g	5	11,42
ST45R	●	450 g	5	17,16
ST45Y	●	450 g	5	17,16
ST45G	●	450 g	5	17,16
ST45B	●	450 g	5	17,16
FC02G		StringMop Holder	5	4,42



SmartColor™ TELEPOLE 250

Ergonomic aluminium telescopic handles.

- 2 sections, 2,50 m long. (2 x 1,25 m)
- Can be adapted to body height
- Solid and light, made of aluminium, with screw mechanism
- Cone with thread and hole for fixture on mop holder
- Also for accessing higher places, without ladder
- Labels included for colour coding

Part No.	Size	Colour	Pack	€/piece
EZ25G	1,30 - 2,50 m	●	10	23,14
EP24R	1,30 - 2,50 m	●	10	23,14



SmartColor™ MOPHANDLE

Lightweight aluminium mop handles.

- Mop holder snaps into place
- Solid and light, made of aluminium, with ergonomic plastic handle
- Labels included for colour coding

Part No.	Size	Ø	Colour	Pack	€/piece
MH14G	1,40 m	21 mm	●	10	5,08
HH13R	1,30 m	23 mm	●	10	13,62
MS14G	1,40 m	21 mm	●	10	14,74
MS18G	1,30 - 1,80 m	25 mm	●	10	13,34



SmartColor™ FLOOR CLEANING SET

The convenient floor care sets.

- Complete with mop holder and telescopic handle
- SF14G also with large dual bucket
- Perfect for professional floor care
- Select a floor mop from our wide range of products.
- Pay attention to correct colour coding

Part No.	MS18G	SM40G	COMBG	Pack	€/piece
SC14G	●	●		1	36,48
SF14G	●	●	●	1	173,06

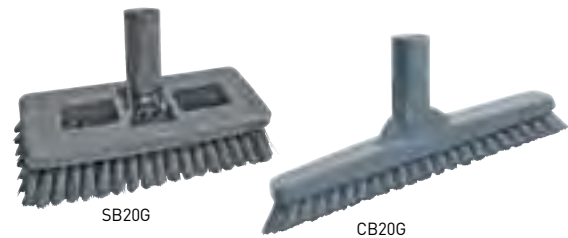

SmartColor™ SWIVEL BRUSH & SmartColor™ SWIVEL CORNER BRUSH

Narrow brush for corners and edges.

- Hard polypropylene bristles remove even severe dirt
- Labels included for colour coding
- Flat pivoting head - easy to manoeuvre, easy on the back
- Bristles are at an angle, for optimal cleaning in corners and edges
- Handle socket with thread (ACME) for **UNGER** cone

Part No.	Size	Pack	€/piece
SB20G	20 x 8 cm	10	13,18
CB20G	22 cm	10	10,96

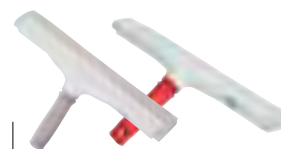

ERGO WALL SQUEEGEE, 35 cm

- Light twin blade foam rubber - for drying tiles and grout lines
- Streak-free cleaning
- T-bar material made of acid proof polypropylene
- Ergonomic handle, detachable - squeegee also fits on pole

Part No.	Size	Colour	Pack	€/piece
EW35G	35 cm	●	10	14,26
EW35R	35 cm	●	10	14,26

MAINTENANCE CLEANING > MICROFIBRE CLOTH SYSTEM > MICROFIBRE CLOTHS



MICROFIBRE CLOTH SYSTEM

AVOID BACTERIAL CONTAMINATION!

- Five-colour system for optical coding optimises cleaning by dividing tools and areas.
- Matching coded tools assigned to specific cleaning areas prevent dangerous bacterial contamination.
- Colour-coding facilitates the application of specific chemicals, thus protecting valuables like furniture and floor coverings.

CLOTH SURFACE GUIDE

- Guidelines for choosing the right microfiber for the right task.
- Optimization of your return on investment (ROI) by purchasing the best grade for your needs.
- Best Quality – Microfibre available in each grade.



**MICROWIPE™
4000**



**MICROWIPE™
2000**

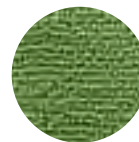

**MICROWIPE™
500**



**MICROWIPE™
200**



WHY A GRADING SYSTEM?

The range of cleaning products that microfiber may be used for is dictated by many qualities, including fibre thickness, length, finishing, abrasiveness, absorbency, cloth dimension, edging and quality manufacturing techniques. **UNGER** has established several

performance factors that have been tested, measured and validated by ASTM independent laboratories and other US standard industry tests. This criteria is designed to assist end users in the selection process when purchasing microfiber cloths.

DURABILITY

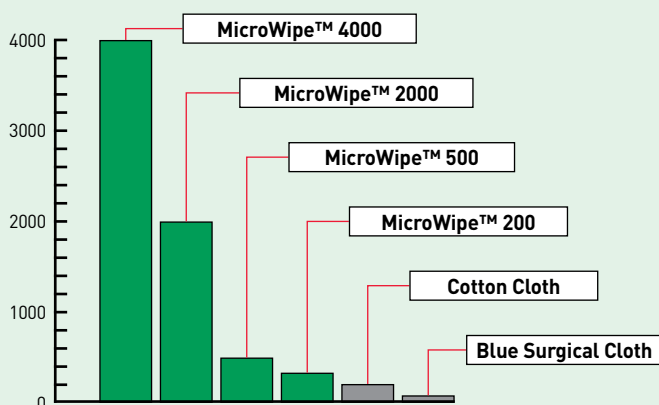

TEST DESCRIPTIONS

- **Durability (Wear Cycles)**** The higher the factor, the greater number of times the microfiber cloth can be moved across an abrasive surface before wearing through and degrading or developing holes.
- **Scrub Factor (Abrasiveness)**** The higher the scrub factor, the better the performance of the cloth in removing dirt and bacteria from surfaces and microscopic crevices.
- **Absorbency*** The higher the factor, the more liquid the cloth will absorb and hold.
- **Wash Cycles** A higher number of wash cycles indicates the longevity of the cloth through machine wash and dry cycles before deteriorating.

** ASTM Tests *Standard US Industry Tests

GRADING SYSTEM CLOTHS & SPRAYER



Quality Tools for Smart Cleaning

** ASTM Tests, * Standard US Industry Tests, Details p. 76

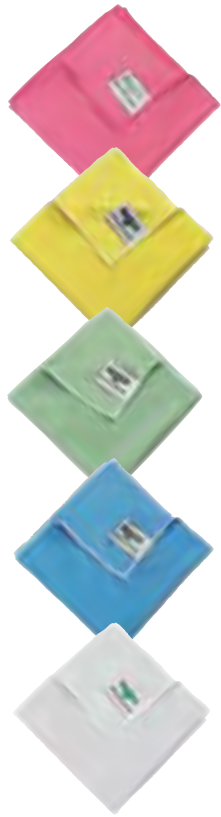

SmartColor™ MicroWipe™

High quality microfibre cloth. Resistant against frequent commercial wash cycles.
Use the table below to choose the right grade to maximise the return on your investment.

Part No.	Size	Colour	Weight/m ²	Durability	Scrub Factor (Abrasiveness)	Absorbency	Wash Cycles	Pack	€/piece
4000									
MF40R	40 x 38 cm	●	450 g	4000**	38**	1700 ml/5,2 oz.*	1500	10	5,02
MF40J	40 x 38 cm	●	450 g	4000**	38**	1700 ml/5,2 oz.*	1500	10	5,02
MF400	40 x 38 cm	●	450 g	4000**	38**	1700 ml/5,2 oz.*	1500	10	5,02
MF40B	40 x 38 cm	●	450 g	4000**	38**	1700 ml/5,2 oz.*	1500	10	5,02
2000									
MB40R	40 x 40 cm	●	350 g	2000**	36**	1400 ml/4,4 oz.*	1000	10	3,40
MB40J	40 x 40 cm	●	350 g	2000**	36**	1400 ml/4,4 oz.*	1000	10	3,40
MB400	40 x 40 cm	●	350 g	2000**	36**	1400 ml/4,4 oz.*	1000	10	3,40
MB40B	40 x 40 cm	●	350 g	2000**	36**	1400 ml/4,4 oz.*	1000	10	3,40
500									
MC40R	40 x 40 cm	●	300 g	500**	34**	1100 ml/3,3 oz.*	500	10	2,42
MC40J	40 x 40 cm	●	300 g	500**	34**	1100 ml/3,3 oz.*	500	10	2,42
MC400	40 x 40 cm	●	300 g	500**	34**	1100 ml/3,3 oz.*	500	10	2,42
MC40B	40 x 40 cm	●	300 g	500**	34**	1100 ml/3,3 oz.*	500	10	2,42
200									
ME40R	40 x 40 cm	●	250 g	200**	39**	250 ml/0,8 oz.*	200	10	0,98
ME40J	40 x 40 cm	●	250 g	200**	39**	250 ml/0,8 oz.*	200	10	0,98
ME400	40 x 40 cm	●	250 g	200**	39**	250 ml/0,8 oz.*	200	10	0,98
ME40B	40 x 40 cm	●	250 g	200**	39**	250 ml/0,8 oz.*	200	10	0,98
ME40W	40 x 40 cm	○	250 g	200**	39**	250 ml/0,8 oz.*	200	10	0,98



SmartColor™ MICRO MITT HD

Perfect for cleaning countertops, wood, glass metal and paintwork.

- Thick, soft strands on one side have increased surface area for incredible absorbency and dirt pick up.
- Premium grade low pile microfibre on the other side is good for dusting and polishing
- Ideal for washing cars

Part No.	Size	Pack	€/piece
MMIRG	22 cm	5	8,74



SPRAYER ON A BELT

Fits to the belt for optimum weight support.

- Flexible hose allows upside down spraying
- 1 l bottle included
- Cloth storage compartment
- Compatible with standard bottles
- Includes colour coding labels

Part No.	Content	Pack	€/piece
SOABG	1 l	5	30,62



BELT FOR SPRAYER ON A BELT

Strong Nylon Belt with quick snap closing.

Part No.	Pack	€/piece
BSOAB	5	13,62

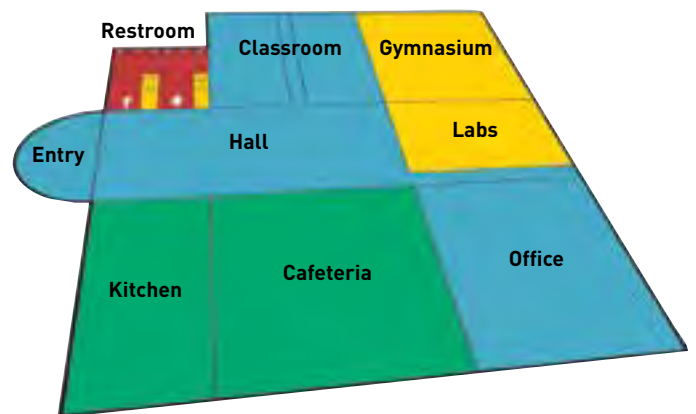

RECOMMENDED USAGE

- Restroom Cleaning
- Wash basin and Mirror
- Food and Bar Area
- General Low Risk Area
- Bespoke or Site Specific

MAINTENANCE CLEANING > RESTROOM CLEANING > TOILET, SURFACE, INSPECTION



ERGO TOILETBURSH/SWAB COMPLETE

Complete kit.

- Ergonomic toilet brush for professional application (66 cm handle)
- No bending, distance to bowl, no splashes on clothing
- Increased productivity - replaceable brush heads and 360° cleaning radius
- Swab for optimal application of cleaning products
- Hygienic and ergonomic holder
- Brush stands firmly; holder can be hand-carried or hung on cart
- Detachable base, brush remains dry, holder can be disinfected

Part No.	Content	Pack	€/piece
BBWHR	Brush, cpl., holder, repl. head	5	22,30
BSWHR	Swab, cpl., holder, repl. head	5	21,08



ERGO TOILETBURSH/SWAB: HANDLE + 2 BRUSH HEADS

Ergonomic toilet brush.

- Ergonomic toilet brush for professional application (66 cm handle)
- No bending, distance to bowl
- Increased productivity - replaceable brush heads and 360° Cleaning radius
- Swab for optimal application of cleaning products

Part No.	Content	Pack	€/piece
BBCOR	2 x Brush, handle	5	13,14
BSCOR	2 x Swab, handle	5	11,92
BBHLR	Brush Holder	5	9,84
BBRHR	2 x Brush heads	5	7,86
BSRHR	2 x Swab heads	5	6,64



RESTROOM SANITARY BRUSH

2 tools in one: Brush with polypropylene bristles and squeegee with black twin foam rubber blade and ACME Thread.

Part No.	Size	Pack	€/piece
PB45R	45 cm	10	20,34



NiftyNabber® RESTROOM, 45 cm

The hygienic all-purpose grabber.

- Keeps refuse at a distance - 45 cm long handle
- Solid design made of aluminium and metal
- Powerful rubber-coated claws - for firm and precise grip of objects

Part No.	Size	Pack	€/piece
NN40R	45 cm	10	15,98



ErgoTec® SQUEEGEE, RED, 35 cm

Ergonomic squeegee for mirrors and smooth surfaces.

- Ergonomic two-component handle
- Optimal grip for a comfortable hold
- Stainless steel S-Channel for quick rubber replacement
- Pro quality soft rubber for optimal cleaning results

Part No.	Size	Pack	€/piece
ES35R	35 cm	10	15,56
NE350	35 cm	10	5,92
RR350	35 cm	10	2,16



StripWasher® RESTROOM 45 cm

For cleaning of mirrors and walls.

- Superior cleaning power
- High water retention - up to 6 times its own weight, ideal for cleaning larger areas
- Machine washable up to 500 times sleeve with side scrub pad
- Lightweight plastic T-bar with water wells

Part No.	Size	Pack	€/piece
EC45R	45 cm	10	13,62
NS45R	45 cm	10	10,70



INSPECTION KIT MIRROR

For control of hard-to-see areas.

- Telescopic, 29 - 46 cm
- 5 cm mirror diameter
- Convenient pocket size
- Red vinyl handle
- Optimal for toilet rims and fittings

Part No.	Size	Pack	€/piece
IMIRR	29 - 46 cm	5	10,46



INSPECTION KIT UV BLACKLIGHT

Shows markings, as well as traces of calcium and urine.

- Shows markings, as well as traces of calcium and urine
- Convenient pocket size
- UV blacklight and pen with invisible ink
- Power supply: 4 x AA batteries (not included)

Part No.	Size	Pack	€/piece
IKITR	16 cm	1	24,90



MAINTENANCE CLEANING > DUSTING BRUSHES & DUSTERS



StarDuster®
COBWEB



For dusting of walls, surfaces and corners. Perfect on telescopic pole.

- Electrostatic energy attracts and holds dust
- Split-tipped soft poly fibres for effective dusting
- Fits on telescopic pole

Part No.	Size	Pack	€/piece
COBW0	20 cm	6	7,64



StarDuster®
LAMBSWOOL



Made of lambswool. For shelves, surfaces, etc. Flexible, very adjustable.

- Optimal dust absorption
- Handle fits to pole
- Bendable

Part No.	Pack	€/piece
LWDU0	6	10,80



StarDuster®
WALL BRUSH



Oval shape ideal for cleaning fans, walls, etc.

- Perfect for dusting rough surfaces and removing dust on flat objects
- Fits on telescopic pole

Part No.	Pack	€/piece
WALB0	5	13,64



StarDuster®
OSTRICH FEATHER



Made of ostrich feathers. Perfect for glass cabinets and furniture.

- Optimal dust absorption
- Reaches smallest gaps
- Fits on telescopic pole

Part No.	Pack	€/piece
FEDU0	6	28,36



StarDuster®
PIPE BRUSH



Round and bendable for cleaning pipes and round surfaces.

- Perfect for dusting on curved surfaces
- Fits on telescopic pole

Part No.	Pack	€/piece
PIPE0	5	13,50



SOOTMASTER SPONGE

Optimal for fire damages. Dry sponge absorbs dust and soot particles.

- Easy to wash
- If necessary, can also be cut off
- Rubber material

Part No.	Pack	€/piece
SP060	6	6,64

MICROFIBRE DUSTERS



StarDuster®
PRO FLAT 75



Bendy plastic duster with microfibre sleeve, ideal for small gaps.

- Sturdy but flexible design
- Ergonomic handle
- Optimal dirt absorption
- Machine washable
- Fits securely to pole with Locking Cone

Part No.	Size	Pack	€/piece
PFD7G	75 cm	10	19,94



StarDuster®
PRO FLAT/FLEX SLEEVES

Disposable and reusable microfibre spare sleeves.

- Optimal dirt absorption
- Machine washable
- Standard with microfibre sleeve

Part No.	Size	Info	Pack	€/piece
PS50W	75 cm	Disposable Sleeve	1 Bag (50)	11,06
PM05W	75 cm	Microfibre Sleeve	1 Bag (5)	42,82



StarDuster®
PRO FLEX 75



Great for cleaning above, underneath and around corners.

- Bendable to any shape you need
- Washable/Replaceable Microfibre Sleeve
- Fits securely to pole with Locking Cone

Part No.	Size	Pack	€/piece
PXD7G	75 cm	10	27,14



StarDuster® PRO CEILING FAN



For dusting of ceiling fan blades and other flat surfaces.

Holds dirt like a magnet with microfibre strands.

- Easy and quick dusting
- Work secure from the floor
- Fits on telescopic pole

Part No.	Size	Pack	€/piece
CEDUG	25 cm	5	16,48



StarDuster®
PRO DUSTER

Three-piece, telescopic lambswool duster.

Ideal for dusting in high places. Incl. spare sleeves.

- Extendable from 70 to 150 cm
- Bendable head
- Keeps dirt away from cleaning person

Part No.	Size	Info	Pack	€/piece
LWDUR	70 - 150 cm	Duster + 1 Disp. Sleeves	10	23,80
DS10Y	46 x 18 cm	Disposable Sleeve	1 Bag (10)	3,76
DS50Y	46 x 18 cm	Disposable Sleeve	1 Bag (50)	12,18





























Quality Tools for Smart Cleaning





CONTENT COLOUR-CODE

	WINDOW CLEANING	 p. 6
	HiFlo™ WATER FED POLE SYSTEMS	 p. 8
	CLASSICAL WINDOW CLEANING	 p. 38
	LITTER PICKING & REACHING AIDS	 p. 64
	MAINTENANCE	 p. 66

ICONS

	Window and facade cleaning
	PV- and solar panel cleaning
	Safety
	Modular Poles
	Telescopic Poles
	TeleMod Poles
	Product securely locks on ErgoTec® Locking cone.
	Product fits on UNGER Poles without safety locking mechanism.
	Premium products
	Best products
	Better products
	Good products

COLOUR CODING

	Restroom Cleaning
	Wash basin and Mirror
	Food and Bar Area
	General Low Risk Area
	Bespoke or Site Specific



Quality Tools for Smart Cleaning

Terms of delivery and payment: This price list replaces all previous price lists - All prices are recommended retail prices, plus VAT
The general terms of delivery and payment of **UNGER** Germany GmbH apply - No responsibility accepted for accuracy; subject to change without notice.

UNGER Germany GmbH

Piepersberg 44
D-42653 Solingen
GERMANY
Tel.: (49) 212 2207 0
Fax: (49) 212 2207 222
ungereurope@ungerglobal.com

UNGER Enterprises Inc.

425 Asylum Street
Bridgeport, CT 06610
USA
Tel.: (1) 800 431 2324
Fax: (1) 800 367 1988
unger@ungerglobal.com

UNGER UK Ltd.

9 Planetary Ind. Est.
Willenhall, WV13 3XA
UNITED KINGDOM
Tel.: (44) 01902 306633
Fax: (44) 01902 306644
ungeruk@ungerglobal.com

UNGER France SARL

114 bis rue Michel-Ange
75016 Paris
FRANCE
Tél.: (33) 1 40 71 28 70
Fax: (33) 1 40 71 28 45
ungerfrance@ungerglobal.com



ungerglobal.com