

CATALOG

PELLET PIPE™

# VP Pellet Pipe

*For pellet burning stoves.*



Selkirk® gives you the safe, efficient, and cost-effective venting system that's engineered precisely for pellet burning stoves.

## FEATURES

- Available in 3" and 4" diameters
- 1" clearance to combustibles
- Gasketed joint design
- Inner wall stainless steel
- Outer wall available as galvanized or black



 **SELKIRK®**



# VP PELLET PIPE™

## VP Pellet Pipe™

Selkirk® gives you the safe, efficient, and cost-effective venting system that's engineered precisely for pellet burning stoves. Model VP Pellet Pipe has been tested and listed by Underwriters' Laboratories, Inc., in accordance with UL®-641 Standard for Low Temperature Venting Systems, as well as the applicable requirements from UL®-103 Standard for Residential Type and Building Heating Appliance Chimneys. VP Pellet Pipe, when installed according to Selkirk's® installation instructions, complies with National Safety Standards, such as NFPA -211. The system is rated for flue temperatures up to 570°F.

- Available in 3" and 4" diameters
- Full line of fittings and full range of pipe lengths increase installation flexibility
- Proven coupling joint connects in seconds to assure joint integrity
- Gasketed joint design
- Painted pipe lengths available for interior use
- Double wall design with 1/4" airspace
- Inner wall 304 stainless steel, outer wall paintable galvanized
- Rolled-over male end eliminates sharp edges
- 1" clearance to combustibles
- Removable tee cap for inspection and cleaning
- Internal spacing bead assures uniform insulating airspace between pipe walls



**PELLET PIPE™**

### PELLET PIPE LENGTHS:

#### Vent Pipe & Adjustable Pipe Lengths

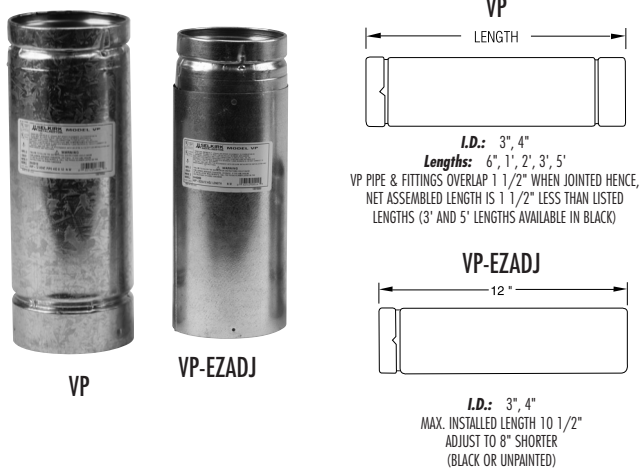

#### Pellet Pipe Lengths

- Available in lengths of 5', 3', 2', 12" and 6"
- Available in galvanized and black

#### Adjustable Pipe Lengths

- Adjustable length eliminates the need to cut pipe
- Adjustable length simply slides over another VP length

Item Description	3" Diameter		4" Diameter	
	Product No.	Part No.	Product No.	Part No.
5' Length – Black	243060B	3VP-60B	244060B	4VP-60B
5' Length	243060	3VP-60	244060	4VP-60
3' Length – Black	243036B	3VP-36B	244036B	4VP-36B
3' Length	243036	3VP-36	244036	4VP-36
2' Length	243024	3VP-24	244024	4VP-24
12" Length	243012	3VP-12	244012	4VP-12
6" Length	243006	3VP-6	244006	4VP-6
12" EZ Adj. – Black	243086B	3VP-EZAJ12B	244086B	4VP-EZAJ12B
12" EZ Adj.	243086	3VP-EZAJ12	244086	4VP-EZAJ12

### PELLET PIPE TEES & ELBOWS:

#### Tees & Double Tee w/ Tee Cap

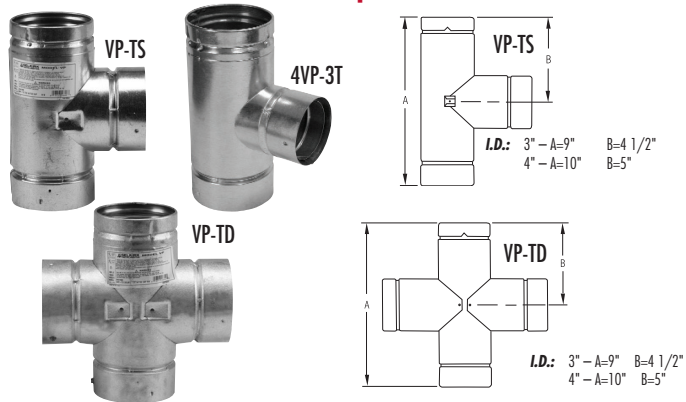

#### Tee

- Used to transition from horizontal to vertical orientation
- Provides easy access for inspection and maintenance
- Includes Tee Cap

#### Double Tee

- Provides access to clean horizontal portion of chimney system

Item Description	3" Diameter		4" Diameter	
	Product No.	Part No.	Product No.	Part No.
Tee w/Tee Cap – Black	243100B	3VP-TSB	244100B	4VP-TSB
Tee w/Tee Cap	243100	3VP-TS	244100	4VP-TS
Double Tee w/Cap	243103	3VP-TD	244104	4VP-TD
Increaser Tee			244113	4VP-3T
Increaser Tee – Black			244113B	4VP-3TB

#### 4 x 3 Adjustable Tee w/ Tee Cap

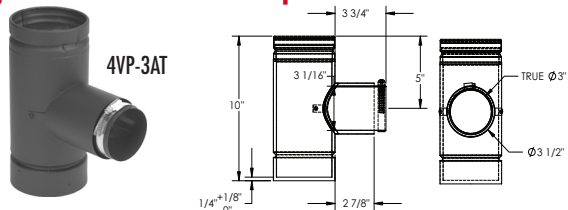

- Replaces Pipe Connector, 3" – 4" Increaser and 4" Tee

Item Description	4" Diameter	
	Product No.	Part No.
4 x 3 Adjustable Tee w/Tee Cap	244133B	4VP-3AT

# VP PELLET PIPE™

## 90° Elbow

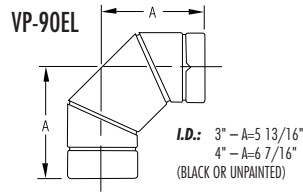

- Used to orient pipe between vertical and horizontal orientation
- Factory sealed at couplers to prevent leakage

Item Description	3" Diameter		4" Diameter	
	Product No.	Part No.	Product No.	Part No.
90° Elbow – Black	243230B	3VP-90°ELB	244230B	4VP-90°ELB
90° Elbow	243230	3VP-90°EL	244230	4VP-90°EL

## 45° Elbow

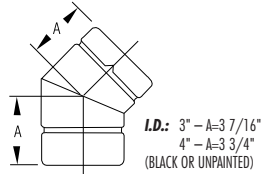

- Used to offset pipe around construction obstacles
- Factory sealed at couplers to prevent leakage

Item Description	3" Diameter		4" Diameter	
	Product No.	Part No.	Product No.	Part No.
45° Elbow – Black	243215B	3VP-45°ELB	244215B	4VP-45°ELB
45° Elbow	243215	3VP-45°EL	244215	4VP-45°EL

## PELLET PIPE SUPPORTS:

### Ceiling Support/Firestop

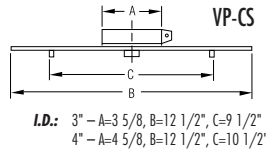

- Used to support pipe from the ceiling joist
- Maintains clearance to combustibles

Item Description	3" Diameter		4" Diameter	
	Product No.	Part No.	Product No.	Part No.
Ceiling Support/Firestop	243410	3VP-CS	244410	4VP-CS

### Wall Bracket/Support

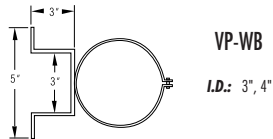

- Used to stabilize the pipe against an outside wall
- Maintains clearance to combustibles

Item Description	3" Diameter		4" Diameter	
	Product No.	Part No.	Product No.	Part No.
Wall Support/Support	243520	3VP-WB	244520	4VP-WB

### Tee Support

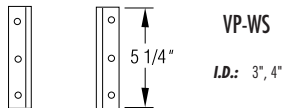
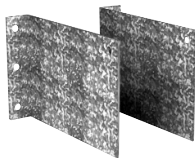

- Two plates used to stabilize and support the Tee

Item Description	3"/4" Diameter	
	Product No.	Part No.
Tee Support	243430	3/4VP-WS

### Cathedral Ceiling Support

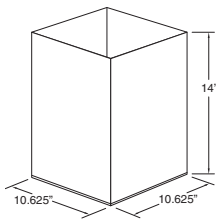

- Used in cathedral-style installations
- Paint black for decorative finish

Item Description	3" Diameter		4" Diameter	
	Product No.	Part No.	Product No.	Part No.
Cathedral Ceiling Support	243424	3VP-CCS	244424	4VP-CCS

# VP PELLET PIPE™

## PELLET PIPE KITS:

### Pellet Pipe Insert (Flex) Kits



4" Pellet Pipe Flex Kit has the following:

- 25' of 4" diameter stainless flex
- 4" flex termination
- 4" flex flashing adapter
- 4" flex flashing
- 3 - 4" Pellet Increaser
- 3" Pellet Pipe Connector
- Silicone sealant

Product No.	Part No.
284855	4VP-25IK

4" Pellet Pipe Flex Kit has the following:

- 35' of 4" diameter stainless flex
- 4" flex termination
- 4" flex flashing adapter
- 4" flex flashing
- 3 - 4" Pellet Increaser
- 3" Pellet Pipe Connector
- Silicone sealant

Product No.	Part No.
284865	4VP-35IK

### Thru-the-Wall Pellet Stove Kits

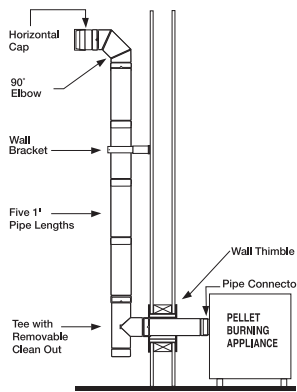

The 3VP Thru-the-Wall Pellet Kit has the following:

- 1 - 3" Horizontal Cap
- 1 - 3" 90° Elbow
- 1 - 3" Wall Bracket
- 5 - 3" One-foot Pipe Lengths
- 1 - 3" Tee with Cleanout
- 1 - 3" Wall Thimble
- 1 - 3" Pipe Connector
- 1 - 3" Tee Support

Product No.	Part No.
283870	3VP-KIT
284875	3/4VP-KIT

The 3/4VP Thru-the-Wall Pellet Kit has the following:

- 1 - 4" Horizontal Cap
- 1 - 4" 90° Elbow
- 1 - 4" Wall Bracket
- 5 - 4" One-foot Pipe Lengths
- 1 - 4" Tee with Cleanout
- 1 - 4" Wall Thimble
- 1 - 4" Tee Support
- 1 - 3" to 4" Pellet Increaser
- 1 - 4" Pipe Connector
- 1 - 3" Pipe Connector

## RAIN CAPS & COLLAR:

### Storm Collar



VP-SC

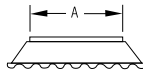

Sizes: 3" - A=3 5/8" B=3 9/16"  
4" - A=4 5/8" B=4 9/16"

- Used to provide a weather proof seal to pipe above roof flashing
- Seal inner edge with hi-temp silicone sealant

Item Description	3" Diameter		4" Diameter	
	Product No.	Part No.	Product No.	Part No.
Storm Collar	243810	3VP-SC	244810	4VP-SC

### Horizontal & Vertical Terminations



I.D.: 3" - A=8" B=3 9/16"  
4" - A=8" B=4 9/16"

VP-HC

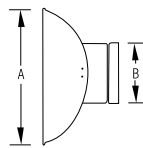

I.D.: 3" - A=6" B=3 1/4"  
4" - A=8" B=4 1/4"

VP-VC

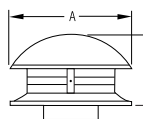

- Vent Termination for horizontal (thru-the-wall) installations
- Vent Termination for vertical (thru-the-roof) installations
- Designed to prevent rain & snow from entering the pipe

Item Description	3" Diameter		4" Diameter	
	Product No.	Part No.	Product No.	Part No.
Vertical Termination	243800	3VP-VC	244800	4VP-VC
Horizontal Termination	243805	3VP-HC	244805	4VP-HC

### Exit Cap and Screens

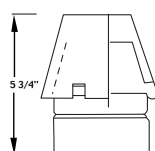

VP-EC

Sizes: 3", 4"

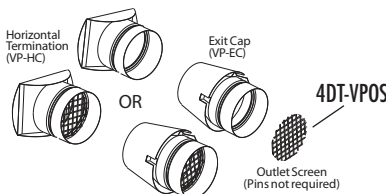

- Used with Horizontal installations

Item Description	Product No.	Part No.
3" Exit Cap	243803	3VP-EC
4" Exit Cap	244803	4VP-EC
Outlet Screen	1604790	4DT-VPOS



# VP PELLET PIPE™

## PELLET PIPE FLASHINGS:

### Tall Cone Flashing

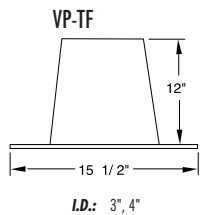

- Used to waterproof installations through a flat roof

Item Description	3" Diameter		4" Diameter	
	Product No.	Part No.	Product No.	Part No.
Tall Cone Flashing	243815	3VP-TF	244815	4VP-TF

### Adjustable Flashing

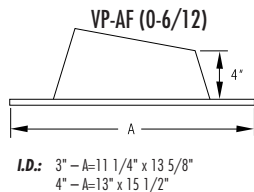

- Used to waterproof installations that penetrate the roof line

Item Description	3" Diameter		4" Diameter	
	Product No.	Part No.	Product No.	Part No.
Adj. Flashing	243825	3VP-AF	244825	4VP-AF

### Universal Rubber Boot Flashing Kit



- Used to waterproof installations that penetrate flat to 12/12 pitch corrugated roofs.

Item Description	Product No.	Part No.
Un. Rubber Boot Flsh Kit	200275	URBAK

## PELLET PIPE SHIELDS:

### Attic Insulation Shield

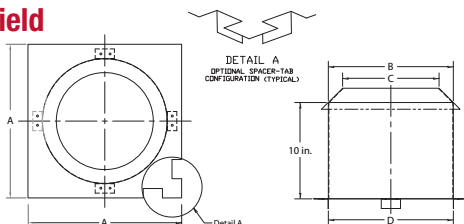

- The attic insulation shield is required to guard against the hazard of blown in or blanket insulation occupying the required 1" airspace around the vent.

Item Description	3" Diameter		4" Diameter	
	Product No.	Part No.	Product No.	Part No.
Attic Insulation Shield	243490	3VP-AIS	244490	4VP-AIS

I.D.: 3" - A=7 1/2" B=5 1/2" C=3 5/8" D=5 1/2"  
4" - A=8 1/2" B=6 1/2" C=4 5/8" D=6 1/2"

### Wall Thimble

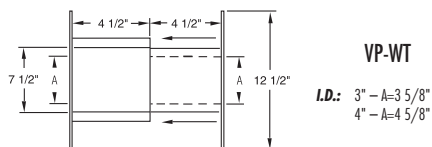

- Used in Thru-the-Wall installations
- Maintains airspace clearance
- Centers pipe between walls
- Telescopic design can be used on standard walls 5" to 9" thick

Item Description	3" Diameter		4" Diameter	
	Product No.	Part No.	Product No.	Part No.
Wall Thimble	243460	3VP-WT	244460	4VP-WT
Wall Thimble, Thick	243461	3VP-WTT	244461	4VP-WTT

### Trim Plate & Exterior Shield

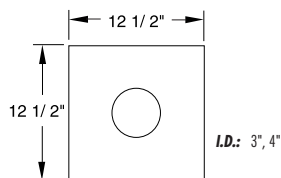

- Used to seal Thru-the-Wall installations
- Trim Plate painted black for decorative finish

Item Description	3" Diameter		4" Diameter	
	Product No.	Part No.	Product No.	Part No.
Trim Plate - Black	243502	3VP-TP	244502	4VP-TP
Exterior Shield	243500	3VP-ES	244500	4VP-ES

### SUSI (Selkirk Universal Shielding Insulation)

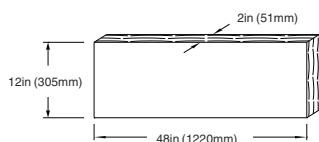

- Optional Insulation for use with the Cathedral Ceiling Support, Wall Thimble, and Attic Insulation Shield.

Item Description	Product No.	Part No.
Universal Shielding Insulation	200001	SUSI

# VP PELLET PIPE™

## PELLET PIPE ACCESSORIES:

### 3" to 4" Increaser



- Used to adapt 3" pipe to 4" pipe

Item Description	Product No.	Part No.
3" to 4" Increaser	243304	3VP-I4

### Pipe Connector

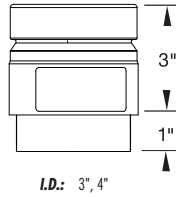

Item Description	3" Diameter		4" Diameter	
	Product No.	Part No.	Product No.	Part No.
Pipe Connector	243240	3VP-PC	244240	4VP-PC
Pipe Connector — Black	243240B	3VP-PCB		
Multi-Fit Connector	243241	3VP-MFC		
Adjustable Pipe Connector	243243	3VP-APC	244243	4VP-APC

### Adjustable Pipe Connector

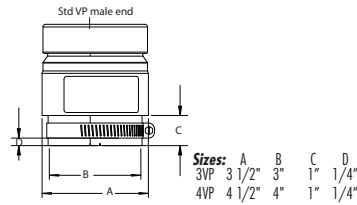

- Used to accommodate wider range of 3" or 4" flue collar variances for better fit

Item Description	3" Diameter		4" Diameter	
	Product No.	Part No.	Product No.	Part No.
Adjustable Pipe Connector	243243	3VP-APC	244243	4VP-APC

### Multi-Fit Connector

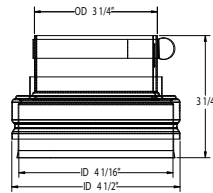

- Connects 3" flue collar to 4" VP parts

Item Description	3" Diameter	
	Product No.	Part No.
Multi-Fit Connector	243241	3VP-MFC

### Thick Collar Pipe Connector

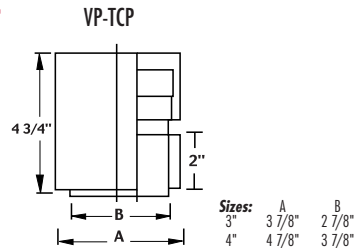

- Used on appliances with a thicker flue outlet collar

Item Description	3" Diameter		4" Diameter	
	Product No.	Part No.	Product No.	Part No.
Thick Collar Pipe Connector	243242	3VP-TPC	244242	4VP-TPC

### Chimney Adapter

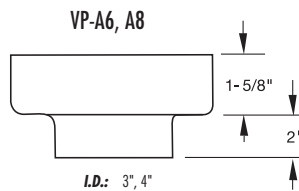

- Used to transition VP Pellet Pipe to Ultra-Temp Chimney

Item Description	3" Diameter		4" Diameter	
	Product No.	Part No.	Product No.	Part No.
6" Chimney Adapter	243246	3VP-A6	244246	4VP-A6
8" Chimney Adapter	243248	3VP-A8	244248	4VP-A8

### Vacuum Cleanout Cap

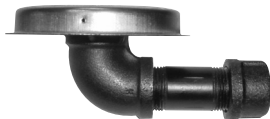

- Safely remove ash with no mess
- Eliminate need to remove tee cap to clean pipe
- Available for 3" or 4" Pellet Pipe Tees

Item Description	3" Diameter		4" Diameter	
	Product No.	Part No.	Product No.	Part No.
Vacuum Cleanout Cap	243185	3VP-VCC	244185	4VP-VCC

Installs on base of Tee and replaces Tee Cap.  
Tee sold separately.

# VP PELLETT PIPE™

## MINIMUM CLEARANCE TO COMBUSTIBLES

Selkirk® VP Pellet Pipe™ may be installed with a minimum 1" airspace clearance to combustible surfaces, such as framing lumber, drywall, plywood, or other building materials. VP Pellet Pipe™ may be exposed in occupied areas and painted pipe lengths help make your venting system an attractive accent to your interior decor. However, your venting system should be enclosed whenever it passes through closets, storage rooms, or accessible attics to ensure that the minimum 1" airspace clearance is maintained. This is particularly true in attics where cellulose-type or other blown-in insulation materials could settle against the exposed vent pipe.

It is also advisable to provide an enclosed chase for exterior vent systems to aid in reducing condensation and to protect the pipe from cold outdoor temperatures. VP Pellet Pipe™ features a proven joint design that allows for easy assembly. Special rope gaskets incorporated into the joint reduce leakage and help to minimize any accumulation of combustion powder residues. In addition, VP Pellet Pipe™ is listed for use with an optional, high-temperature silicon sealant which enhances the integrity of the joint assembly. Selkirk® is the world's leading manufacturer of venting and air distribution products for residential, commercial, and industrial use. VP Pellet Pipe™ vent for pellet stoves is just one of the family of fine products sold worldwide. Selkirk® — it's a name you can rely on.

## TYPICAL VP PELLETT PIPE INSTALLATIONS

The following illustrations show the most common types of Model VP installations and the variety of parts required.

### Horizontal Exit Termination

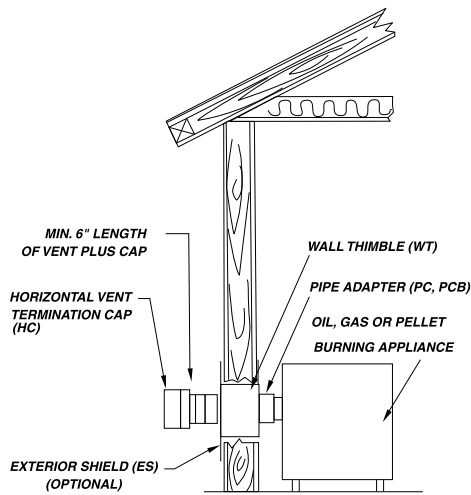

### Through the Ceiling Rear Vent

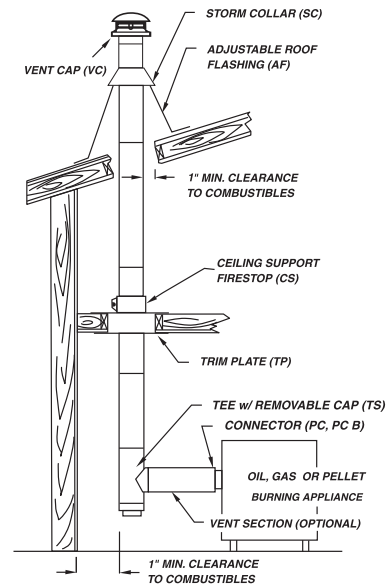

### Through the Wall Installation

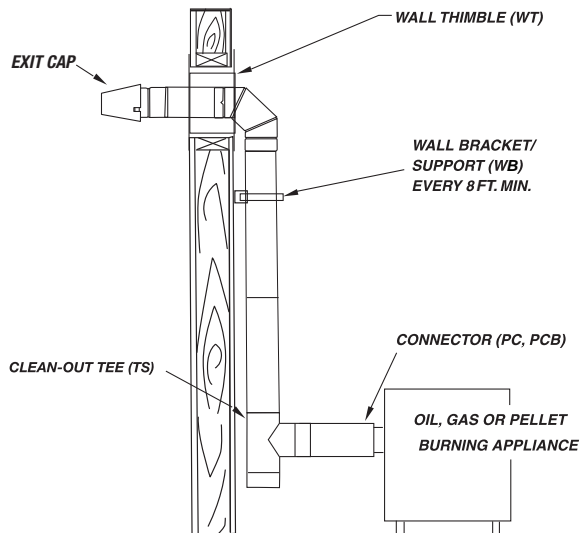

### Through the Wall Rear Vent

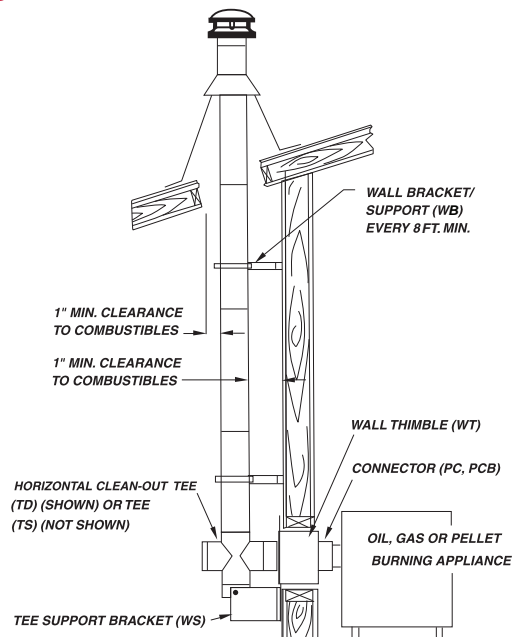



Selkirk Hearth Products

**Chimney:**

- Ultra-Temp
- Ultra-Temp Large
- Galva-Temp
- Galva-Temp Large

**MAX! Fireplaces:**

- Bordeaux
- Merlot
- Chardonnay

**Venting:**

- Direct-Temp/Gas
- Direct-Temp/Pellet
- Direct-Temp/Multi-Fuel
- Double Wall Stove Pipe
- Saf-T Pipe
- VP Pellet Pipe
- Flexi-Liner
- Versa-Liner
- Saf-T Liner

All Hearth Products Are Not Created Equal.

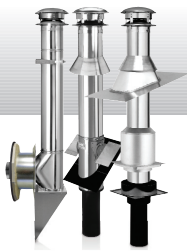

All-Fuel Chimney



Stove Pipe

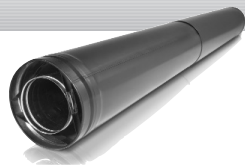

Direct-Vent



Aluminum Chimney Liner



Stainless Steel Chimney Liner

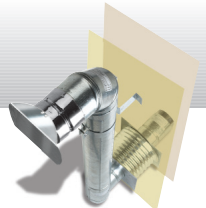

Pellet Pipe

Get the Selkirk® Advantage – The tradition continues...Selkirk is the original innovator of prefabricated Venting systems – and we continue to move forward. Count on Selkirk, the world's most recognizable name in Chimney & Venting, for the widest range of high-performance products to meet your needs.



Selkirk Corporation  
 5030 Corporate Exchange Blvd.  
 Grand Rapids, MI 49512  
 Toll Free: 1.800.433.6341



www.selkirkcorp.com



Selkirk Canada Corporation  
 375 Green Road  
 Stoney Creek, ON L8E 4A5  
 Toll Free: 1.888.SELKIRK (735.5475)