



**DrainTech**<sup>®</sup>

2013 Product Catalog

## ***Drain Basins, Channels and Grates***





Over 30 years ago, NDS began producing plastic drainage and landscape products. From the beginning, our commitment to leading the industry has been unwavering, leading to remarkable innovations and state-of-the-art products that fit every environment, every schedule, every need.

Today, our commitment to providing one-source solutions has led to the development of superior quality drainage products, landscape products, fittings, valve and meter boxes, equipment pads, and drip and micro irrigation products. No product is added to our line without meeting exhaustive testing and extensive research requirements. Plus, NDS is uniquely able to offer our complete inventory of products from regional warehouses in the US.

Our goal: one-business-day delivery. Our track record: outstanding.

Take a moment to look through this catalog, noting the depth of our product offering. If you have any questions or would like place an order, call us at 800-726-1994 from 6 a.m. to 5 p.m. PST and let us offer the best solution for you.

## Index

Drain Basins, Grates & Filters .....	4
Pipe Adapters and End Caps .....	9
Round Drop-In Grates .....	11
Atrium & Square Drop-In Grates .....	12
PRO+ Series Channels, Drains & Grates .....	13
Load Recommendation Guide.....	15

**Applications:** Use to collect low-volume water flow from wet areas in yards, lawns, fairways and sports fields. Can also be used in patios, garages and driveways.

### 6" Round 1 & 2 Hole Basin

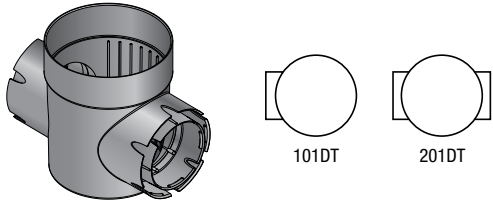

**Use with:** 3", 4" corrugated singlewall pipe; 3", 4" TripleWall pipe; 3", 4" SDR 35 & SCH 40 pipe; singlewall and dual wall HDPE pipe. Use 6" pipe for a riser and 6" SDR35 for extensions.

Product #	Description	Package Quantity
101DT	6" Round One-hole Basin	5
201DT	6" Round Two-hole Basin	5

### 6" Round Drop-In Grate

ADA Compliant

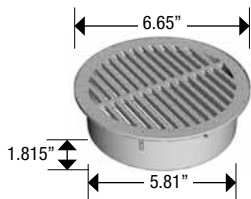

**Use with:** 6" round basin, 6" corrugated singlewall pipe or 6" SDR 35 pipe.



Product #	Description	Package Quantity
0660SDB	6" Round Black Grate	10
0660SDG	6" Round Green Grate	10

### 6" Atrium Drop-In Grate

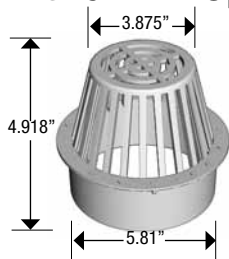

**Use with:** 6" round basin, 6" corrugated singlewall pipe or 6" SDR 35 pipe where debris would clog a flat grate.

Product #	Description	Package Quantity
0663SDB	6" Black Atrium Grate	10
0663SDG	6" Green Atrium Grate	10

### Square Drop-In Grate

ADA Compliant

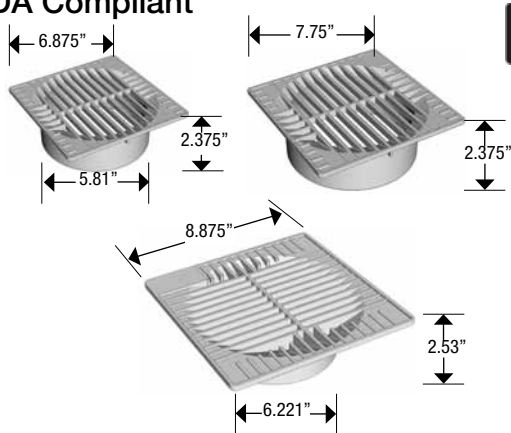

**Use with:** 6" round basin, 6" corrugated singlewall pipe or 6" SDR 35 pipe.



Product #	Description	Package Quantity
0762SDB	7" Square Black Grate for 6" pipe	10
0762SDG	7" Square Green Grate for 6" pipe	10
0862SDB	8" Square Black Grate for 6" pipe	10
0862SDG	8" Square Green Grate for 6" pipe	10
0962SDB	9" Square Black Grate for 6" pipe	10
0962SDG	9" Square Green Grate for 6" pipe	10

**Applications:** Use to collect medium-volume water flow from wet areas in yards, lawns, fairways and sports fields. Can also be used in patios, garages and driveways.

### 9" Square 2 & 4 Hole Basin

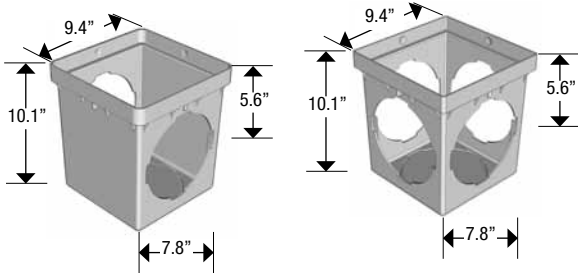

**Use with:** 3", 4", 6" corrugated singlewall pipe; 3", 4" TripleWall pipe; 3", 4", 6" SDR 35 pipe; singlewall HDPE fittings; DrainTech 9" square riser; DrainTech Universal End Plug and DrainTech pipe adapters.

Product #	Description	Package Quantity
0909SD2	9" Square Two-hole Basin	4
0909SD4	9" Square Four-hole Basin	4

### 9" Square 2-Hole Basin Kit

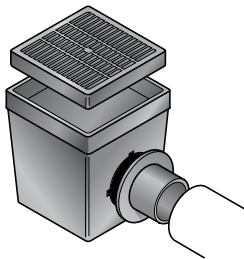

**A complete package:** Kit contains one 9-inch square 2-hole basin, one 9" square grate, one Universal End Plug and two adapters to connect 3" or 4" drainage pipe to the basin.



Product #	Description	Package Quantity
0909SD2KB	9" Square Kit with Black Grate	1
0909SD2KG	9" Square Kit with Green Grate	1

### 9" Square Riser

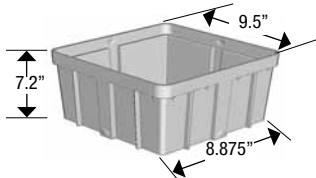

**Uses:** Adds 6" of height to 9" square 2- or 4-hole basin.

Product #	Description	Package Quantity
0906SD	9" Square Riser	4

### 9" Square Grate

ADA Compliant

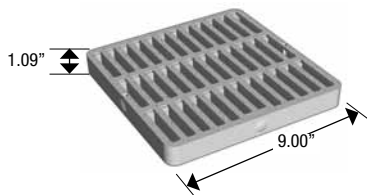

**Use with:** 9" square basin or 9" low profile drain.



Product #	Description	Package Quantity
0902SDB	9" Square Black Grate	8
0902SDG	9" Square Green Grate	8



\*When encased in concrete, please see load classifications, pg 15.

### 9" Atrium Grate

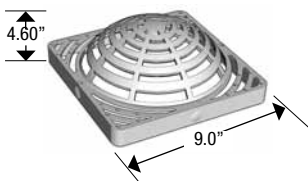

**Use with:** 9" square basin or 9" low-profile drain where debris would clog a flat drain.

Product #	Description	Package Quantity
0903SDB	9" Square Black Atrium Grate	8
0903SDG	9" Square Green Atrium Grate	8

### 9" Square Low-Profile Drain

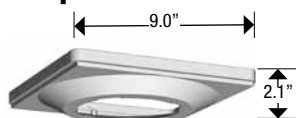

**Use with:** DrainTech 9" square grate or DrainTech 9" atrium grate; dual or single wall HDPE fittings; DrainTech pipe adapters; 3", 4", 6", 8" corrugated singlewall pipe; 3", 4" TripleWall pipe; 3", 4", 6", 8" SDR 35 pipe.

Product #	Description	Package Quantity
0907SD	9" Square Drain	8

**Applications:** Use to collect medium- to high-volume water flow from wet areas in yards, lawns, fairways and sports fields. Can also be used in patios, garages and driveways.

### 12" Square 2 & 4 Hole Basin

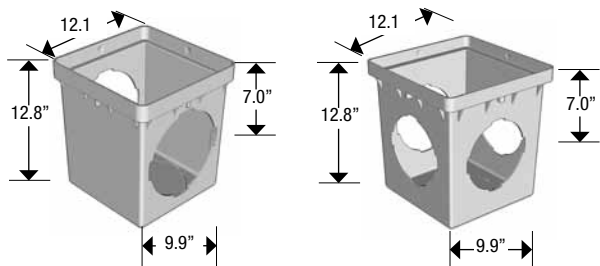

**Use with:** 3", 4", 6", 8" corrugated singlewall pipe; 3", 4" TripleWall pipe; 3", 4", 6", 8" SDR 35 pipe; singlewall HDPE fittings; DrainTech 12" square riser; DrainTech Universal End Plug and DrainTech offset adapters.

Product #	Description	Pkg. Qty.
1212SD2	12" Square Two-hole Basin	4
1212SD4	12" Square Four-hole Basin	4

### 12" Square 2-Hole Basin Kit

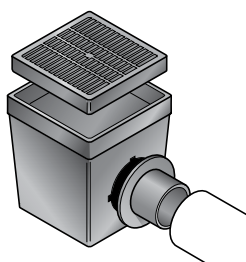

**A complete package:** Kit contains one 12-inch square 2-hole basin, one 12" square grate, one Universal End Plug and two offset adapters to connect 3" or 4" drainage pipe to the basin.

Product #	Description	Pkg. Qty.
1212SD2KB	12" Square Basin Kit with Black Grate	1
1212SD2KG	12" Square Basin Kit with Green Grate	1

### 12" Square Riser

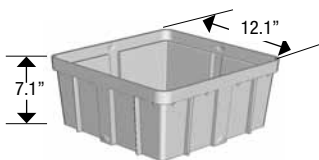

**Uses:** Adds 6" of height to 12" square 2- or 4-hole basin.

Product #	Description	Pkg. Qty.
1206SD	12" Square Riser	4

## 12" Square Grate

ADA Compliant

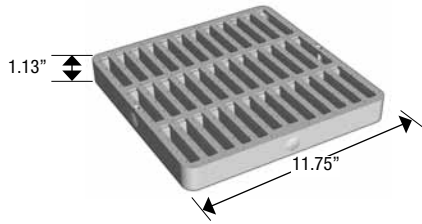

**Use with:** 12" square basin or 12" low profile drain.



Product #	Description	Pkg. Qty.
1202SDB	12" Square Black Grate	8
1202SDG	12" Square Green Grate	8



\*When encased in concrete, please see load classifications, pg 15.

## 12" Atrium Grate

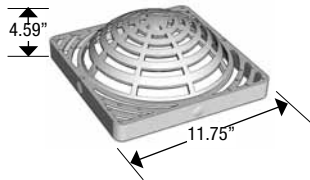

**Use with:** 12" square basin or 12" low-profile drain where debris would clog a flat drain.

Product #	Description	Pkg. Qty.
1203SDB	12" Square Black Atrium Grate	8
1203SDG	12" Square Green Atrium Grate	8

## 12" Square Low-Profile Drain



**Use with:** DrainTech 12" square grate or DrainTech 12" atrium grate; singlewall HDPE fittings; DrainTech pipe adapters; 3", 4", 6", 8", 10" corrugated singlewall pipe; 3", 4" TripleWall pipe; 3", 4", 6", 8", 10" SDR 35 pipe.

Product #	Description	Package Quantity
1207SD	12" Square Drain	8

**Applications:** Use to collect high-volume water flow from wet areas in yards, lawns, fairways and sports fields. Can also be used in patios, garages and driveways.

### 18" Square 2 & 4 Hole Basin

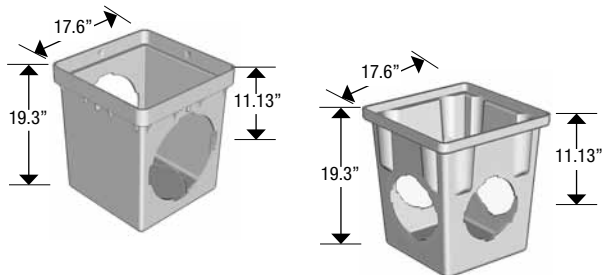

**Use with:** 3", 4", 6", 8", 10" corrugated singlewall pipe; 3", 4" Triple-Wall pipe; 3", 4", 6", 8", 10" SDR 35 pipe; singlewall HDPE fittings; DrainTech 18" square riser; DrainTech Universal End Plug; 2 reducing rings included.

Product #	Description	Package Quantity
1818SD2	18" Square Two-hole Basin	1
1818SD4	18" Square Four-hole Basin	1

### 18" Square Riser

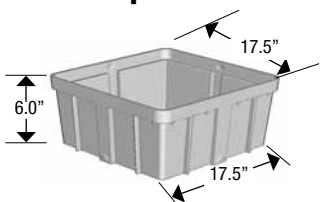

**Uses:** Adds 6" of height to 18" square 2- or 4-hole basin.

Product #	Description	Package Quantity
1806SD	18" Square Riser	1

### 18" Square Grate

ADA Compliant

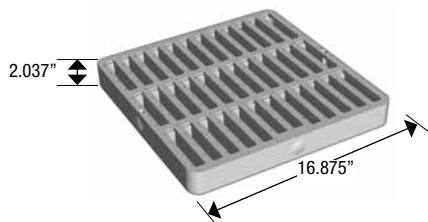

**Use with:** 18" square basin



Product #	Description	Package Quantity
1802SDB	18" Square Black Grate	4
1802SDG	18" Square Green Grate	4

\*When encased in concrete, please see load classifications, pg 15.

### 18" Atrium Grate

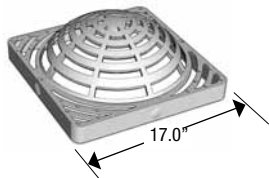

**Uses:** Use where debris would clog a flat drain.

Product #	Description	Package Quantity
1803SDB	18" Square Black Atrium Grate	4
1803SDG	18" Square Green Atrium Grate	4



### Universal End Plug

**Use:** Cap off unused outlets in 9", 12" & 18" drain basins.

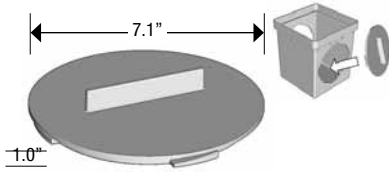

Product #	Description	Package Quantity
0633SD	6" Universal Plug	20

### 3" & 4" Offset Locking Adapter

**Uses:** Used to attach 3", 4" pipe to 9", 12" & 18" square DrainTech basin & low-profile drain where an offset connection is needed. Works as a locking fitting to 3", 4" corrugated singlewall pipe, SDR 35, SCH 40, 2729 S&D and TripleWall pipe. Also, may be used with 4" dual wall pipe.

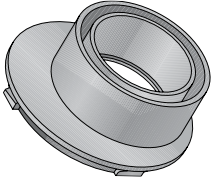

Product #	Description	Package Quantity
1245DT	3" Offset Locking Adapter	20

### 3" & 4" Locking Adapter

**Uses:** Used to attach 3", 4" pipe to 3", 4" pipe to 9", 12" & 18" square DrainTech basin & low-profile drain where a straight-line connection is needed. Works as a locking fitting to 3", 4" corrugated singlewall pipe, SDR 35, SCH 40, 2729 S&D and TripleWall pipe. Also, may be used with 4" dual wall pipe.

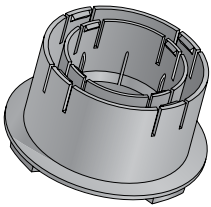

Product #	Description	Package Quantity
1243DT	3" Locking Adapter	20

### 6" Locking Adapter

**Uses:** Use to attach 6" single wall & dual wall corrugated, SDR 35 and TripleWall pipe to 3", 4" pipe to 9", 12" & 18" square DrainTech basin & low-profile drain where a straight-line connection is needed.

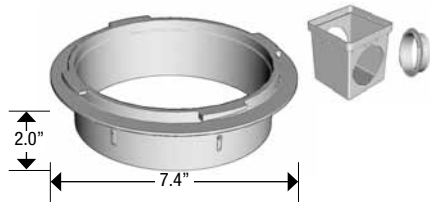

Product #	Description	Package Quantity
0612SD	6" Locking Adapter	20

## 8" Offset Adapter

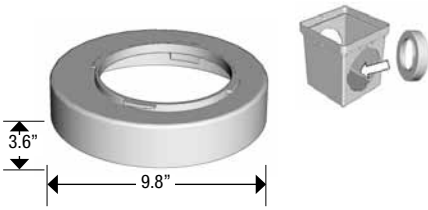

**Uses:** Use to attach 8" & 10" singlewall pipe to 9", 12" square DrainTech basin and low-profile drains where an offset connection is needed. Reduces 8" pipe to a 6" opening.

Product #	Description	Package Quantity
0811SD	8" Offset Adapter	8

## 8" Locking Adapter

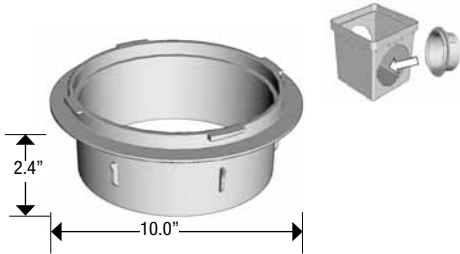

**Uses:** Use to attach 8" corrugated single wall & SDR 35 pipe to 18" DrainTech drain basin where a straight-line connection is needed.

Product #	Description	Package Quantity
0812SD	8" Locking Adapter	8

## 18" Locking Adapter

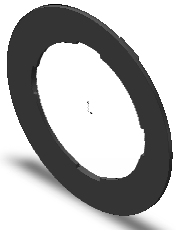

**Uses:** Use to connect 3", 4" & 6" pipe to 18" catch basin.

Product #	Description	Package Quantity
1812SD	18" Locking Adapter	1

**Applications:** Use with pipe and connecting fittings where a drain basin is not needed.

**Grates for 3", 4", 6" Pipe**  
**ADA Compliant**

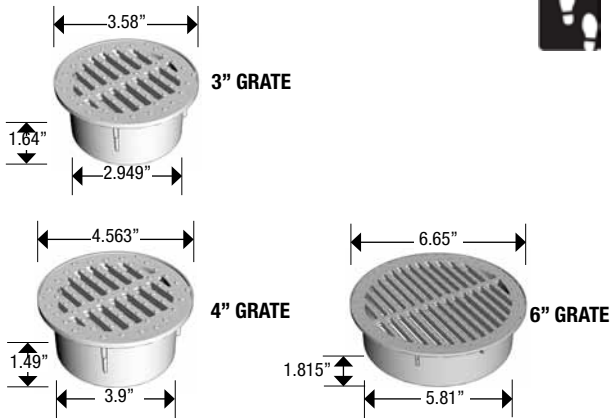

**With:** 3", 4" & 6" corrugated single wall and dual wall pipe, SDR 35, 2729 S&D and TripleWall pipe. All 6" grates may be used with 6" round basins.

Product #	Description	Package Quantity
0330SDB	3" Round Black Grate for 3" Pipe	40
0330SDG	3" Round Green Grate for 3" Pipe	40
0440SDB	4" Round Black Grate for 4" Pipe	25
0440SDG	4" Round Green Grate for 4" Pipe	25
0660SDB	6" Round Black Grate for 6" Pipe	10
0660SDG	6" Round Green Grate for 6" Pipe	10

**8" Grate for 6" Pipe**  
**ADA Compliant**

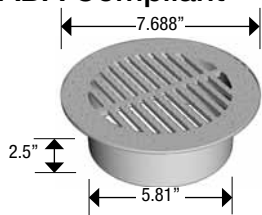

**Use With:** 3", 4" & 6" corrugated single wall and dual pipe, SDR 35, 2729 S&D and TripleWall pipe.

Product #	Description	Package Quantity
0860SDB	8" Round Black Grate	10
0860SDG	8" Round Green Grate	10

**10" Grate for 8" Pipe**  
**ADA Compliant**

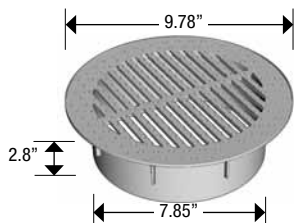

**Use With:** 3", 4" & 6" corrugated single wall and dual pipe, SDR 35, 2729 S&D and TripleWall pipe.

Product #	Description	Package Quantity
1080SDB	10" Round Black Grate	10
1080SDG	10" Round Green Grate	10

**12" Grate for 12" Pipe**  
**ADA Compliant**

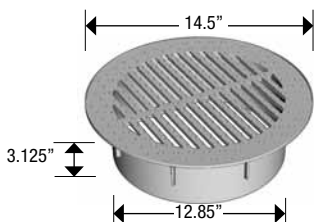

Product #	Description	Package Quantity
1210SDB	12" Round Black Grate	6
1210SDG	12" Round Green Grate	6

**Applications:** Use with pipe and connecting fittings where a drain basin is not needed or where space doesn't allow the use of a basin. Use with corrugated singlewall pipe, TripleWall pipe, SDR 35 pipe or 2729 S&D.

### Atrium Grates for Pipe

**Use With:** 3", 4" & 6" corrugated single wall and dual pipe, SDR 35, 2729 S&D and TripleWall pipe. All 6" grates may be used with 6" round basins.

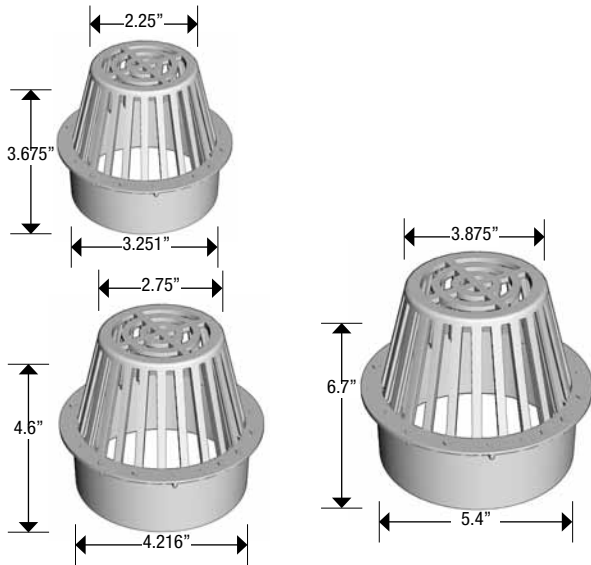

Product #	Description	Pkg. Qty.
0333SDB	3" Round Black Atrium Grate for 3" Pipe	20
0333SDG	3" Round Green Atrium Grate for 3" Pipe	20
0443SDB	4" Round Black Atrium Grate for 4" Pipe	20
0443SDG	4" Round Green Atrium Grate for 4" Pipe	20
0663SDB	6" Round Black Atrium Grate for 6" Pipe	10
0663SDG	6" Round Green Atrium Grate for 6" Pipe	10

### Square Grates for Pipe

ADA Compliant

**Use With:** 3", 4" & 6" corrugated single wall and dual pipe, SDR 35, 2729 S&D and TripleWall pipe.

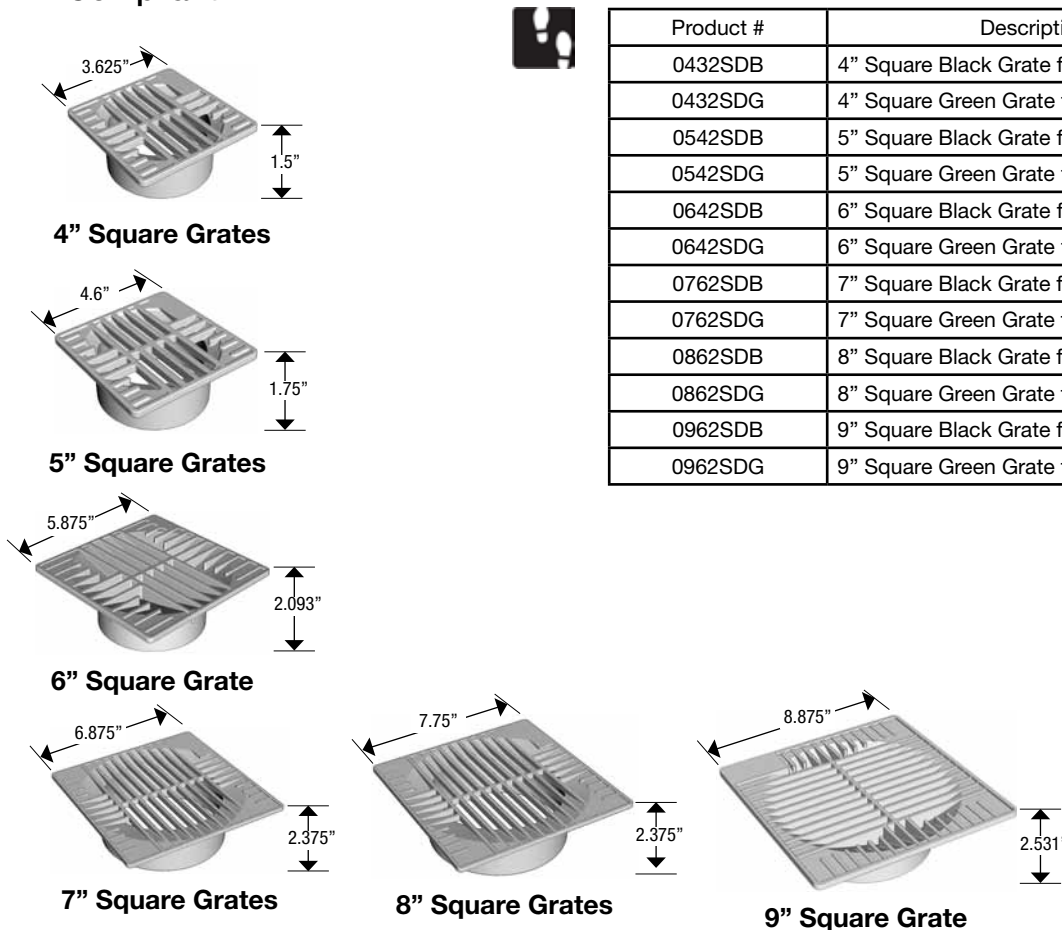

Product #	Description	Pkg. Qty.
0432SDB	4" Square Black Grate for 3" Pipe	40
0432SDG	4" Square Green Grate for 3" Pipe	40
0542SDB	5" Square Black Grate for 4" Pipe	40
0542SDG	5" Square Green Grate for 4" Pipe	25
0642SDB	6" Square Black Grate for 4" Pipe	10
0642SDG	6" Square Green Grate for 4" Pipe	10
0762SDB	7" Square Black Grate for 6" Pipe	10
0762SDG	7" Square Green Grate for 6" Pipe	10
0862SDB	8" Square Black Grate for 6" Pipe	10
0862SDG	8" Square Green Grate for 6" Pipe	10
0962SDB	9" Square Black Grate for 6" Pipe	10
0962SDG	9" Square Green Grate for 6" Pipe	10

Grates that fit 6" pipe can also be used with 6" round basins  
\* Grate also fits around 3" pipe

## 5" PRO+ Channel Kits



**Uses:** Installation in light traffic areas\*, garage door entrances, patios and landscaped areas. Kits include 4 feet of 5" PRO+ channel, 4 feet of 5" PRO+ channel grate, one end plug and 4 metal clips. Easily field cut to desired lengths. Clips or screws used to attach field cut sections. Bottom outlets adaptable to the following pipe types: 3" & 4" corrugated single and dual wall, SDR 35, SCH 40, TripleWall and 3" SDR 35 Bell.

Product #	Description	Pkg. Qty.
0584CHBK	5" Black Channel, 4' length/Black Grate Kit	1
0584CHGK	5" Black Channel, 4' length/Green Grate Kit	1
0584CHYK	5" Gray Channel, 4' length/Gray Grate Kit	1
0588CHBK	5" Black Channel, 8' length/Black Grate Kit	2
0588CHYK	5" Gray Channel, 8' length/Gray Grate Kit	2

\*When encased in concrete, please see load classifications, pg 15.

## 5" PRO+ Channel

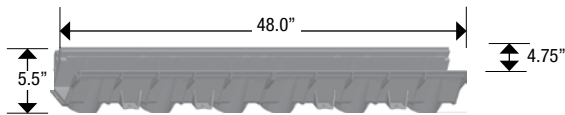

**Uses:** Add a grate to fit the color needed.

Product #	Description	Pkg. Qty.
0584CHB	5" Black Channel, 4' length	1
0584CHY	5" Gray Channel, 4' length	1

## 5" PRO+ Channel Grate

ADA Compliant

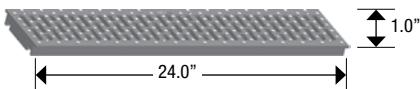

**Uses:** Variety of colors for specific applications. Screws ordered separately for ductile iron and brass grates. See Page 21.

Product #	Description	Pkg. Qty.
0501CHSBR	1-foot Satin Brass Grate for 5" Channel	10
0524CHB	2-foot Black Grate for 5" Channel	12
0524CHG	2-foot Green Grate for 5" Channel	12
0524CHY	2-foot Gray Grate for 5" Channel	12

\*When encased in concrete, please see load classifications, pg 15.

## 5" PRO+ Channel Solid End Cap/Adapter

**Uses:** Used to close either end of PRO+ channel.

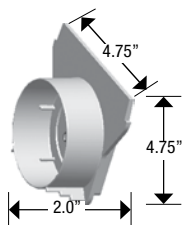

Product #	Description	Pkg. Qty.
0583CHB	5" Channel Black End Cap/Adapter	10
0583CHY	5" Channel Gray End Cap/Adapter	10

## 5" PRO+ Channel Atrium Outlet

**Uses:** Can be used as a direct connection to channel ports to create a screened outlet. Adapts to 3" & 4" corrugated single and dual wall fittings, SDR 35, TripleWall, SCH 40 and 2729 S&D fittings.

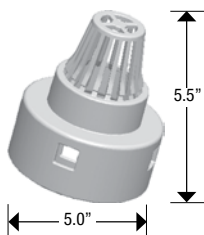

Product #	Description	Package Quantity
0585CHY	5" Gray Atrium Outlet	10
0585CHB	5" Black Atrium Outlet	10

### 5" PRO+ 45 Degree Elbow



Product #	Description	Package Quantity
0545CHY	5" Gray Channel Grate 45° Elbow	1
0545CHB	5" Black Channel Grate 45° Elbow	1

### 5" PRO+ 90 Degree Elbow



Product #	Description	Package Quantity
0590CHB	5" Black Channel Grate, 90° Elbow	1
0590CHY	5" Gray Channel Grate, 90° Elbow	1

### Channel Screws/Clips

Product #	Description	Package Quantity
0600CHSS	Flat Phillips Stainless Steel Screw	1
0600CHCLIP	Metal Clips for connecting channels	1

\*When encased in concrete, please see load classifications, pg 15.

---

## LOAD RECOMMENDATION GUIDE



### **CLASS A:**

- Loads of 1-60 psi.
- Recommended for pedestrians, bicycles and wheel chair traffic.



### **CLASS B:**

- Loads of 61-175 psi.
- Recommended for medium-duty pneumatic tire traffic, autos and light trucks at speeds less than

Note: Some installations may require a concrete collar to meet load rating. Loads are based on encasing product in concrete. Product must be installed using NDS instructions.

- Catch Basins & Grates
- Channel Drains
- Dura Slope™ Pre-Sloped Trench Drain Systems
- EZflow® Gravel Free French Drain
- Flo-Well® Manufactured Dry Well
- Flo Control™ Ball Valves
- Flo Control™ Check Valves
- Flo Control™ Transition, Compression & Repair Fittings
- Backwater & Diverter Valves
- Sewer & Drain Fittings
- Permeable Pavers
- Root Barriers
- Valve Boxes
- Meter Boxes
- Flexible Couplings
- Flexible Saddles
- Agrifim™ Drip Irrigation

## PARTIAL CLIENT LIST

The White House	Riviera Country Club
Los Angeles Country Club	Buchart Gardens
Pebble Beach	Disney World
Cypress Point	Disneyland
Spyglass Hill	Florida University
PGA West Stadium Golf Course	Harbortown Golf Links
Princeville Golf Course	Hyatt Grand Champions
Ritz Carlton	La Quinta Resort
Santa Barbara Zoo	Marriott Hotels
Sheraton Hotels	MGM Grand Hotel & Theme Park
Sherwood Country Club	Mirage Hotel
Soldier Field	Jack La Lane Athletic Clubs
Del Webb & Sun City Country Clubs	Olympic Training Center
Westin Hotels	Los Angeles National Cemetery

## REGIONAL WAREHOUSES:

- Mineola, TX
- Powder Springs, GA
- Visalia, CA
- Fresno, CA
- New Jersey, NJ

851 N. Harvard Avenue  
Lindsay, CA 93247  
Phone: 800-726-1994  
Fax: 800-726-1998  
International Phone: 559-562-9888  
International Fax: 559-562-4488  
e-mail: [nds@ndspro.com](mailto:nds@ndspro.com)

FOR TECHNICAL INFORMATION,  
CONTACT:

Technical Services  
(888) 825-4716  
[TechService@NDSPRO.com](mailto:TechService@NDSPRO.com)

## TERMS AND CONDITIONS OF SALE

**Terms:** Standard terms are 2% NET 10 days. A 1 1/2% per month (18% per annum) service charge will be added to all past due accounts. All invoices are to be paid in US Currency. Title and risk of loss pass to buyer upon shipment.

**Freight Allowance: (US and PR Orders:)** Freight prepaid on orders of \$1000.00 NET or more, with the exception of shipments to HI, AK, and PR for which freight is prepaid on orders of \$2500.00 NET or more. Prepaid freight levels are based on shipments to one location only. It is the responsibility of the customer to determine if its purchase order meets the minimum freight allowance required. NDS reserves the right to select the carrier and point of shipment.

**Canadian Orders:** Freight prepaid on orders of \$2,000.00 (US\$) NET or more. Custom DuraCast only orders freight prepaid on orders of \$2500.00 (US\$) NET or more.

The above freight policies apply to the continental US and Canada only. For other areas please contact NDS.

**Errors & Claims:** All claims for shortage in shipment or damaged material must be noted on the "Bill of Lading" and a written request for credit submitted to NDS within 15 days of shipment. NDS responsibility ceases upon delivery to the carrier.

**Returned Goods:** Returned goods will be accepted only after written approval and shipping instructions are received from NDS. A return goods authorization number is required and must be on all cartons, documents, and correspondence. All returns (except EZflow) are subject to a 25% restocking charge, and freight cost of returned goods (plus "out freight if applicable"). EZflow returns are subject to a 50% restocking charge, and freight cost of returned goods (plus "out freight if applicable"). A higher restocking charge may be assessed against any return requiring extraordinary handling costs.

**Minimum Order:** \$100.00 minimum order net billing. A 15% broken box charge will be added for other than full box quantities.

**General Limited One Year Warranty:** Subject to the limitations set forth herein, NDS warrants to the original owner of its products, that the products will remain free from manufacturing defects that are the result of faulty workmanship or materials for a period of one year from the date of purchase. This warranty does not apply to defects not caused by NDS. NDS must be notified of all claims under this warranty within thirty (30) days of the owner becoming aware of the defect. NDS's sole liability for any claim, including any claim under this warranty, shall be limited solely and exclusively to replacement of the defective product as set forth in NDS's standard "Statement of Warranty".

**Limited Lifetime Warranty On Select Products:** Subject to the limitations set forth herein, NDS warrants to the original owner of its NDS catch basins, grates, channels and Pro Series valve boxes that the NDS catch basins, grates, channels and Pro Series valve boxes will remain free from manufacturing defects that are the result of faulty workmanship or materials for the lifetime of the product. This warranty does not apply to defects not caused by NDS or to subsequent owners. NDS must be notified of all claims under this warranty within thirty (30) days of the owner becoming aware of the defect. NDS's sole liability for any claim, including any claim under this warranty, shall be limited solely and exclusively to replacement of the defective product as set forth in NDS's standard "Statement of Warranty".

**Exclusive Warranties and Remedies:** THE FOREGOING REMEDIES ARE EXCLUSIVE AND ARE GIVEN AND ACCEPTED IN LIEU OF (I) ANY AND ALL OTHER WARRANTIES, EXPRESSED OR IMPLIED, INCLUDING WITHOUT LIMITATION THE IMPLIED WARRANTIES OF MERCHANTABILITY AND FITNESS FOR PARTICULAR PURPOSE; AND (II) ANY OBLIGATION, LIABILITY, RIGHT, CLAIM OR REMEDY IN CONTRACT OR TORT, WHETHER OR NOT ARISING FROM NDS'S NEGLIGENCE, ACTUAL OR IMPUTED. NDS EXPRESSLY EXCLUDES AND DISCLAIMS ANY IMPLIED WARRANTIES FOR MERCHANTABILITY, ANY WARRANTIES OF FITNESS FOR A PARTICULAR PURPOSE, APPLICATION OR USE, AND ANY WARRANTIES OF NON-INFRINGEMENT. UNDER NO CIRCUMSTANCES WILL NDS BE LIABLE FOR SPECIAL, INCIDENTAL, CONSEQUENTIAL OR OTHER DAMAGES OR ANY KIND WHATSOEVER, WHETHER SUCH CLAIM IS BASED UPON THEORIES OF CONTRACT, WARRANTY, NEGLIGENCE, TORT (INCLUDING BUT NOT LIMITED TO STRICT LIABILITY) OR OTHERWISE. ALSO, IN NO EVENT SHALL NDS BE RESPONSIBLE FOR SHIPPING CHARGES, LABOR, INSTALLATION OR ANY OTHER LOSSES OR EXPENSES INCURRED IN OPERATION OF ANY REPLACEMENT SPECIALTY ITEM OR FITTING. NO AGREEMENT VARYING OR EXTENDING THE FOREGOING WARRANTIES OR THESE LIMITATIONS WILL BE BINDING ON NDS.

NDS Drainage products are designed to be used for exterior surface drainage only. NDS products are designed to be used with other NDS component / parts. The use of NDS products in conjunction with non-NDS supplied components / parts voids all warranties.

NDS shall not be liable for any failure that is due to causes beyond NDS's control, including but not limited to, acts of God, acts of civil or military authority, priorities, strikes, floods, epidemics, war, riots, and other causes that are beyond the manufacturers' control. These provisions are complete and exclusive statements of all terms and conditions between NDS, Inc., and the consumer. These provisions may not be varied, supplemented, qualified or interpreted by any prior course of dealings, written or oral or by trade usage. No NDS, Inc. agent, officer or employee has authority to make any representation, promise or warranty concerning these provisions. No agreement varying or extending the foregoing warranties or limitations shall be binding on NDS unless in writing and signed by an authorized officer of NDS.