

Professional
BACKROOM

Window And Screen
Repair Solutions

MAKE **2** FIT[®]

- Attractive ROI
Low investment/high profit
- Optimizes your selling floor/backroom
by using a minimum of space
- Easy to use training options

**SEE INSIDE
FOR DETAILS**



Welcome to Prime-Line Products Backroom Screening Program!

Today's market is extremely competitive and Prime-Line's Backroom Program helps store owners drive store traffic, sales transactions and build customer relationships based on great service. Our program offers:

- Attractive ROI - Low investment / high profit
- Optimizes your selling floor / backroom by using a minimum of space
- Easy to use training options:

- On-site training*
- Easy to learn videos
- Industry trade show demonstrations

We know great service is what keeps customers, and attracts new ones. Let us partner with you and show you how our Backroom program can add value to your business and help you keep your competitive edge.

Contact us at: 800-255-3505, or visit us at primeline.net for more information. We look forward to hearing from you!

*For an additional fee

PRIME-LINE[®]

26950 San Bernardino Ave., Redlands, CA 92374
(800) 255-3505 • FAX (909) 880-2906

primeline.net





WHO WE ARE

Prime-Line Products has been supplying repair and replacement parts for windows and doors since 1978. Over 35 years of business acumen has led Prime-Line to the top of its trade. The worldwide need for residential maintenance has motivated our company to develop over 18,000 unique items for our customers. We service the professional trades with repair solutions throughout North America and abroad.

We also provide products to the Do-It-Yourself industry through home centers, hardware stores and lumber yards, with a wide variety of specialized repair parts that fit various individual and regional demands. We currently supply many manufacturers with OEM components that are in wide demand.

OUR VALUE PROPOSITION

- Extensive product assortment
- Competitive wholesale pricing
- Largest selection of current and hard-to-find hardware
- In stock, ready to ship inventory
- Nationwide coverage
- Outstanding customer service
- Personalized account management
- State of the art ordering systems



CUSTOMER SERVICE

Prime-Line is ready to fulfill any large capacity order, we can take your order from inception to completion in stride. With customer service available from 6 A.M. to 5 P.M. PST every weekday, you'll get the answers you want, when you want them.

Pages

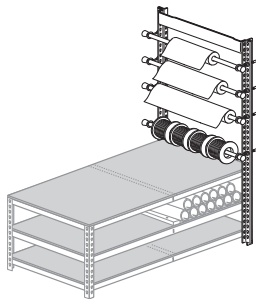

Backroom Fixtures 3-5

- Storage Rack Kits
- Screen / Glass Table Kit
- Cut-Off Saw Table Kit
- Portable Chop Saw Table Kit
- E-Z Slide Cut-Off Gauge



Screen & Window Components 6-43

- Screen Frame - Various Shapes & Sizes
- Corners - Metal & Plastic
- Screen Frame K.D. Kits
- Window Frame & Corners
- Triple Track Frame & Accessories
- Screen Retainer Splines - Gray & Charcoal
- Glass Retainer Splines - Flexible & Rigid



Glazing & Screening Components 44-51

- Glass Adhesive
- Weatherstrip
- Screen Rolling Tools
- Professional Specialty Tools
- Re-Screening Kits
- Fiberglass Screening
- Plastic Wickets

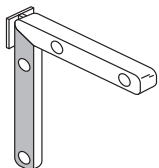

Storm Door Window Accessories 52-91

- Storm Door Window & Screen Repair Kits
- Corner & Tilt Keys
- Slide Bolts & Springs
- Insert Clips
- Panel Clips (Pages 107-109)

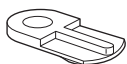

Window Screen Clips & Fasteners 92-106

- Screen Clips - Diecast & Plastic
- Awning & Casement Clips
- Screen Frame Fasteners & Hangers
- Window Grid Retainers

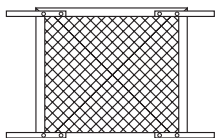

Screen Door Components 110-116

- Sliding Screen Door K.D. Kits
- Speciality Tools
- Screen Door Grilles - Swinging & Sliding
- Patio Door Repair Track
- Sliding Screen Door Closer



Support Material & Merchandising Aids 117-126

- Signage & Racks
- Regional Planograms

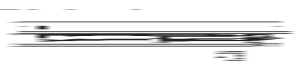

Window Balances 127-139

- Channel Balances & Accessories
- Spiral Balances

Item Index 140-152

Part #	Pack Qty.	Fr
PL-7724	4/Card	Gr
PL-7725	4/Card	Brof
PL-7726	4/Card	Wh
PL-8145	4/Card	G
PL-14258	100/Box	

Part Numbers in Red indicate retail packaging.

SCREEN TABLE KIT

- P-8101-G (48" x 96" with carpet)
- P-8060-G (48" x 96")
- P-8701-G (48" x 84")
- P-8700-G (48" x 72")
- P-8699-G (48" x 60")
- P-8698-G (48" x 48")

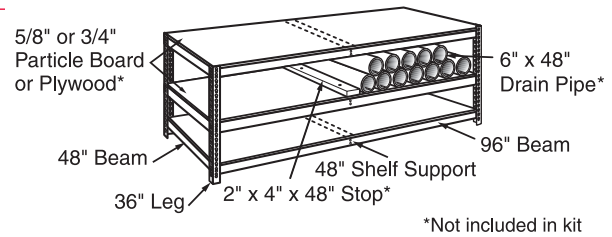
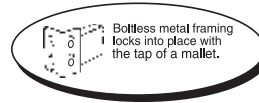

*Not included in kit

Table Specs

4	36" Legs
3 (or 6)	48" Shelf Supports
6	Beams (Length varies by kit)
6	48" Beams
12	Shelf Support Screws and Wing Nuts

Materials Not Included in Kit:

- 3 - 48" x 96" x 5/8" (or 3/4") Particle Board or Plywood Shelving
- 13 - 6" x 48" Drain Pipe (to house rolls of screen)
- 2 - Drain Pipe Stops
- 8 - #8 x 5/8" Phillips Pan Head Sheet Metal Screws
- 1 - Screen Table Jig (P-7924)
- 1 - 60" x 108" Indoor / Outdoor Felt Carpeting (P-8099)
- 1 - Tower Kit (P-8076)

- Boltless metal framing locks into place with the tap of a mallet.
- Adjustable shelving for storing screen and glass supplies.
- Comfortable 36" working height.
- Designed for 3/4" particle board or plywood (not included).

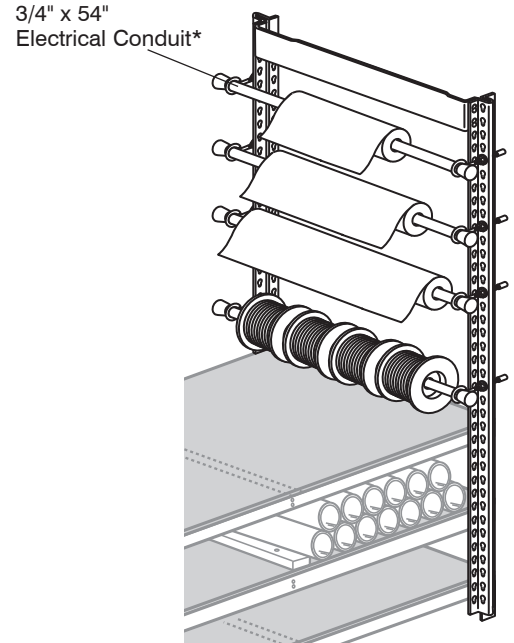

TOWER KIT

P-8076-G

- Accessory item for the screen table kit (P-8060 & P-8101).
- Conveniently stores most commonly used screening material and splines.
- Painted steel uprights and top brace.
- Supplied with (8) eye bolts and end caps to accommodate (4) 3/4" electrical conduit spindles.
- Easy to install.

P-8083 Eye Bolt Set (2)

P-8076-G SPECIFICATIONS	
2	96" Steel Uprights
1	48" Steel Top Brace
8	Eyebolts
16	1/2" Washers
16	1/2" Nuts
8	1/2" Safety Caps
8	7/8" Rubber End Caps
*Materials Not Included in Kit:	
4	3/4" x 54" Electrical Conduit (Spindles)

SCREEN TABLE TOP CARPETING

P-8099

- Protects window and screen frames from scratches.
- Tough indoor/outdoor felt carpet.
- 72" wide x 108" long piece, overlaps top and is fastened to underside of table top.
- Cleans with standard hand held vacuum cleaner.



P-8061 SPECIFICATIONS	
4	36" Legs
4	36" Connector Legs
10	Shelf Supports
12	96" Beams
20	24" Beams
40	Shelf Support Screws and Wing Nuts
*Materials Not Included in Kit:	
4	24" x 96" x 5/8" Thick Particle Board or Plywood
2	24" x 96" x 3/4" Thick Particle Board or Plywood
1	24" x 24" x 5/8" Thick Particle Board or Plywood
1	24" x 24" x 3/4" Thick Plywood
6	4" x 4" x 96" Posts
—	1/2" x 16" Galvanized Pipe
—	Other Fasteners

CUT-OFF SAW TABLE KIT

P-8061

- Sturdy 18' painted steel cut-off saw work bench designed for mounting the E-Z Slide Cut-Off Gauge (P-7925 & P-7926).
- Boltless metal framing locks into place with the tap of a mallet.
- Adjustable shelving for screen and glass frame components.
- Designed for 3/4" particle board or plywood (not included).
- We suggest using the Delta MS-250 cut-off saw and our (P-7929 or P-7930) fine toothed 10" saw blades.

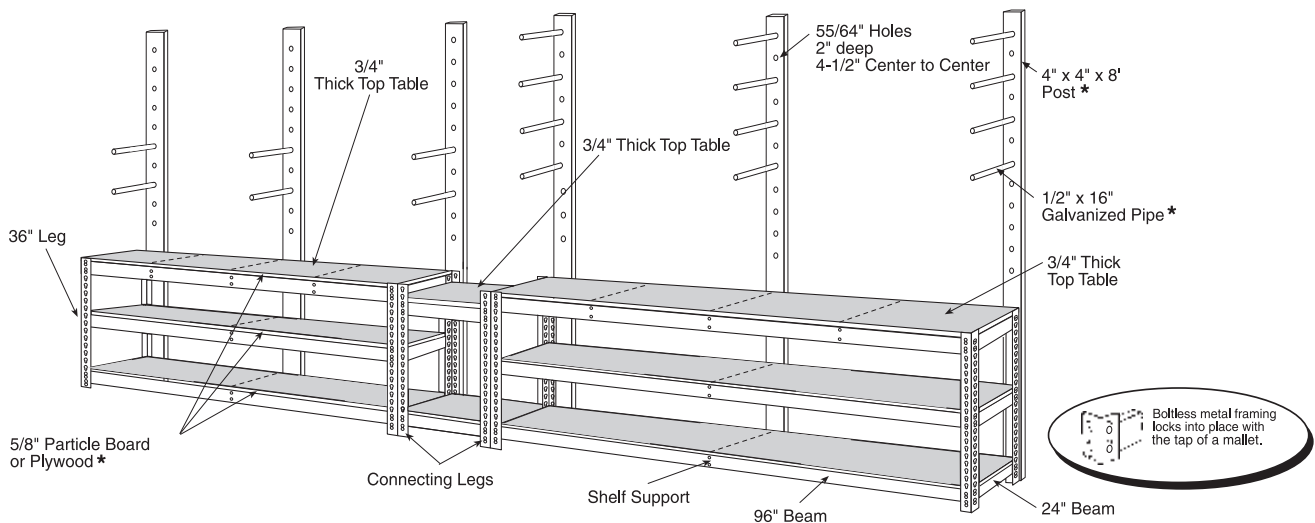

FENCE STOP CLAMP

P-8079 (1 per pack)

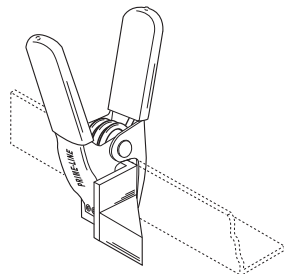

PORTABLE CHOP-SAW TABLE KIT*

P-8077

- A small facility can now make new window screens and storm window panels.
- Overall dimensions (when hinged arms are extended in up position): 107-3/4" Wide x 15-15/16" Deep x 40-1/4" High.
- Table Kit is partially assembled and ready for immediate use.
- Fence clamp for accurately measuring length of pre-mitered screen frame and built-in adjustable measuring device that allows for extended length measuring, (11" min. to 84" max.).

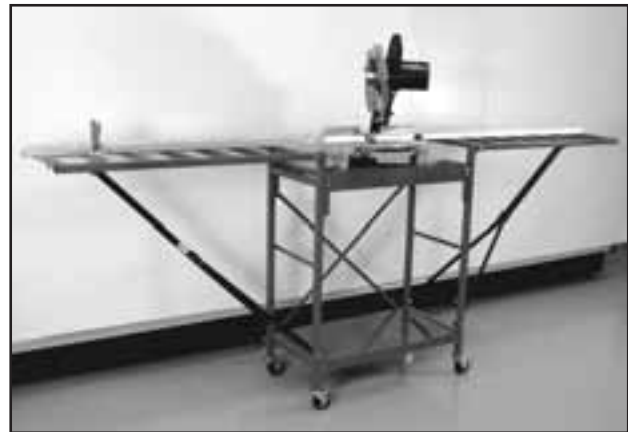

* Chop Saw is not included.

Can be adjusted to accommodate most any brand of saw.

FINISHED WINDOW SCREEN & GLASS REPAIR RACK

P-8115

- Sturdy painted steel rack helps prevent damage to finished goods.
- Overall dimensions 24" wide x 24" deep x 96" high.
- Boltless metal framing locks into place with the tap of a mallet.
- Bottom shelf designed for 3/4" particle board or plywood (not included).

P-8115 SPECIFICATIONS	
4	96" Legs
8	24" Beams
*Materials Not Included in Kit:	
1	24" x 24" x 3/4" Thick Particle Board or Plywood

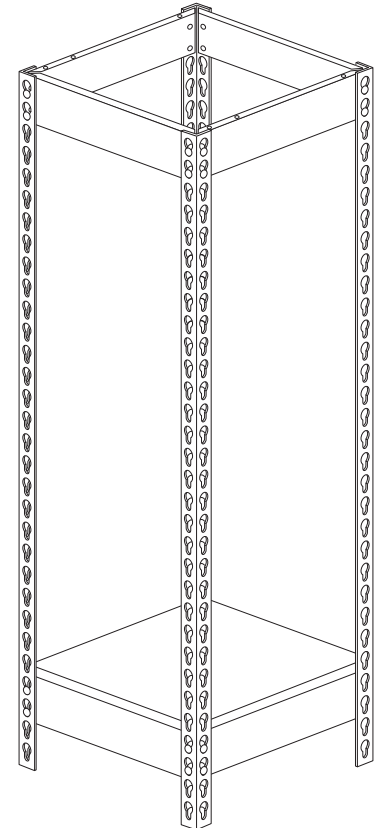

E-Z SLIDE CUT-OFF GAUGE

1. A unique measuring device for cut-off saws requiring fast and accurate lineal measuring.
2. Ideal for use with Prime-Line's full size chop saw table kit (Part No. P-8061).
3. Accurately measures screen frame lengths from 6" to 108".
4. All measurements are read directly in front of chop saw, for maximum operator efficiency.

P-7926 (Left Hand Stop Gauge)

P-7927 (Right Hand Stop Replacement Tape For P-7925 measurement starts at zero and increases to the left)

P-7928 (Left Hand Stop Replacement Tape For P-7926 measurement starts at zero and increases to the right)

P-8056 (Indicator)

Cut-off Saw is Not Included

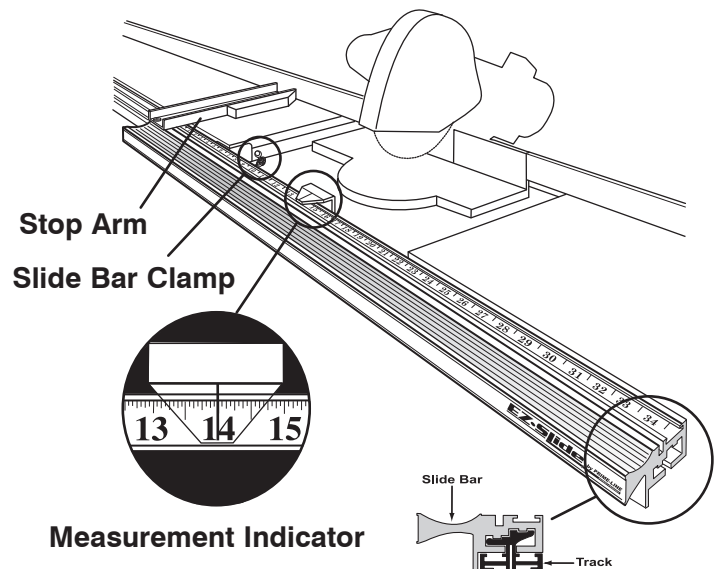

P-7926 (LH-Stop) Shown

NOW AVAILABLE!
BY POPULAR DEMAND

**Andersen
and
Pella**

Screen Frame Corners
Molded Plastic

Now you can replace those broken frame corners!!!



PL-8164



PL-8165



PL-8166

Frame Manufacturer	Frame Size	Color	Part # 4 per card	Part # 20 per tub
Andersen	7/16" x 3/4"	Sandstone (Tan)	PL-8164	PL-15756
		Terratone (Bronze)	PL-8165	PL-15757
		Cream	PL-8166	PL-15758

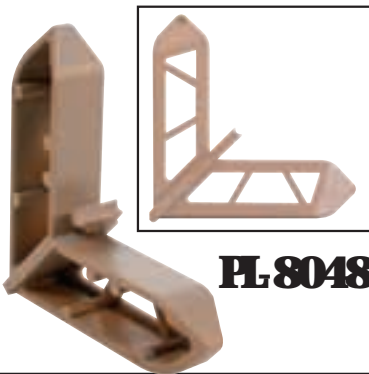

PL-8048



PL-8100



PL-8099

Frame Manufacturer	Frame Size	Color	Part # 4 per card	Part # 20 per tub
Pella	7/16" x 3/4"	Champagne (Tan)	PL-8048	PL-15759
		Bronze	PL-8100	PL-15767
		Cream	PL-8099	PL-15766



Andersen Window

Replacement Screening System



Sandstone Terratone Cream

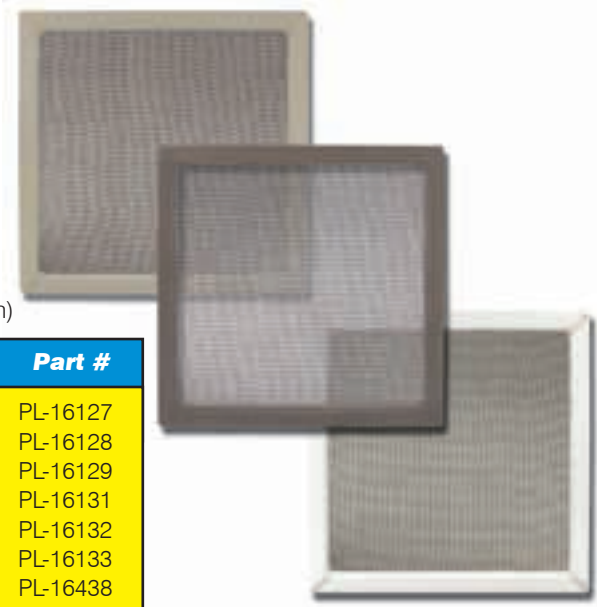

3/4" X 7/16" SCREEN FRAME

• Use spline size: .165 (Aluminum mesh) or .185 (Fiberglass mesh)

Frame Length	Pieces per Carton	Color	Part #
72"	20	Sandstone (Tan)	PL-16127
94"	20	Sandstone (Tan)	PL-16128
12' 2"	40	Sandstone (Tan)	PL-16129
72"	20	Terratone (Bronze)	PL-16131
94"	20	Terratone (Bronze)	PL-16132
12' 2"	40	Terratone (Bronze)	PL-16133
94"	20	Cream	PL-16438
12' 2"	40	Cream	PL-16439



PL-8045 PL-8046 PL-8047

Frame Manufacturer	Frame Size	Color	Part# 4 per card	Part# 20 per tub
Andersen Molded Plastic	7/16" x 3/4"	Sandstone (Tan)	PL-8045	PL-16263
		Terratone (Bronze)	PL-8046	PL-16264
		Cream	PL-8047	PL-16265

Our generic frame system allows you to color match **Andersen Windows.** Outside miter corners completes the look. To achieve a perfect match, use our color-matched spline below.

COLOR MATCHED SPLINE

Make your new Andersen screen a perfect match by using our .165 (for aluminum mesh) or .185 colored spline (for fiberglass mesh)

Color	Spline Size	Length	Part #
Sandstone (Tan)	.165	500 ft.	P-8374
White	.165	500 ft.	P-8283
Sandstone (Tan)	.185	500 ft.	P-8350
White	.185	500 ft.	P-8287
Bronze	.185	500 ft.	P-8352



ALUMINUM SCREEN FRAME & CORNERS

1-1/4" X 7/16" SCREEN FRAME

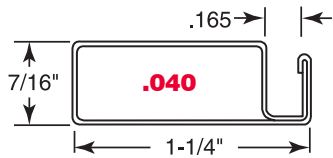

ORDER FULL CAR TONS ONLY

Actual Size

Part #	Length	Pieces per Ctn.	Finish
PL-14000	72"	12	Gray
PL-14001	72"	12	Bronze
PL-15600	12' 2"	30	Gray
PL-15601	12' 2"	30	Bronze
PL-14002	12' 2"	65	Gray
PL-14003	12' 2"	65	Bronze

- Use spline size: .165 (Aluminum mesh) See Page 28
- .185 (Fiberglass mesh)

1-1/4" CORNERS

Metal Miter Cut

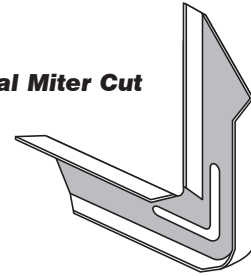

Part #	Pack Qty.	Finish
PL-14250	20/Tub	Mill
PL-14251	100/Box	Mill

Minimum order: 1 Tub / Box

1" X 7/16" SCREEN FRAME

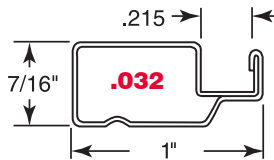
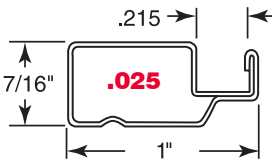

ORDER FULL CAR TONS ONLY

Actual Size

Part #	Length	Pieces per Ctn.	Thickness	Finish
PL-14012	72"	20	.025	Mill
PL-14013	72"	20	.025	Gray
PL-14014	72"	20	.025	Bronze
PL-14015	72"	20	.025	White
PL-14016	72"	20	.025	Almond
PL-15606	12' 2"	36	.025	Mill
PL-15607	12' 2"	36	.025	Gray
PL-15608	12' 2"	36	.025	Bronze
PL-15609	12' 2"	36	.025	White
PL-15610	12' 2"	36	.025	Almond
PL-16477	12' 2"	36	.025	Adobe
PL-14018	12' 2"	65	.025	Mill
PL-14019	12' 2"	65	.025	Gray
PL-14020	12' 2"	65	.025	Bronze
PL-14021	12' 2"	65	.025	White
PL-14022	12' 2"	65	.025	Almond
PL-14023	12' 2"	65	.025	Adobe
PL-14005	72"	20	.032	Gray
PL-14006	72"	20	.032	Bronze
PL-14007	72"	20	.032	White
PL-15603	12' 2"	36	.032	Gray
PL-15604	12' 2"	36	.032	Bronze
PL-15605	12' 2"	36	.032	White
PL-14009	12' 2"	65	.032	Gray
PL-14010	12' 2"	65	.032	Bronze
PL-14011	12' 2"	65	.032	White

- Use spline size: .225 (Aluminum mesh) See Page 28
- .235 (Fiberglass mesh)

1" CORNERS

**Metal Miter Cut
.050 Gauge**

Part #	Pack Qty.	Finish
PL-14252	20/Tub	Mill
PL-14253	100/Box	Mill
PL-16474	500/Box	Mill

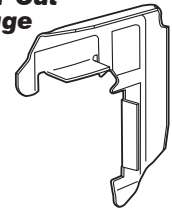

**Plastic Miter Cut
Adjustable from 45° to 135°**

Part #	Pack Qty.	Finish
PL-15924	20/Tub	Black
PL-16070	100/Box	Black
PL-16071	1000/Box	Black

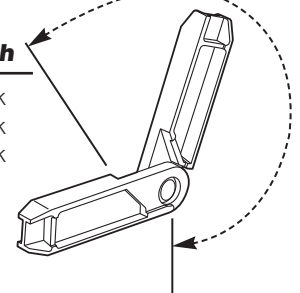

Minimum order: 1 Tub / Box

ALUMINUM SCREEN FRAME & CORNERS

7/8" X 5/16" EXTRUDED SCREEN FRAME

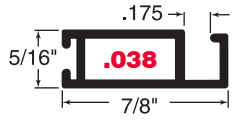

Actual Size

ORDER FULL CAR TONS ONLY

Part #	Length	Pieces per Ctn.	Finish
PL-15974	96"	10	Mill
PL-15975	96"	10	Bronze
PL-15976	96"	10	White

• Use spline size: .190 Foam Spline - See Page 29

7/8" X 5/16" CORNERS

Part #	Pack Qty.	Finish
PL-15977	20/Tub	Mill
PL-15978	100/Box	Mill

Minimum order: 1 Tub / Box

Metal Miter Cut

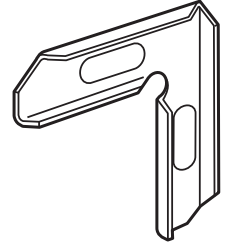

ALUMINUM SCREEN FRAME & CORNERS

3/4" X 7/16" SCREEN FRAME

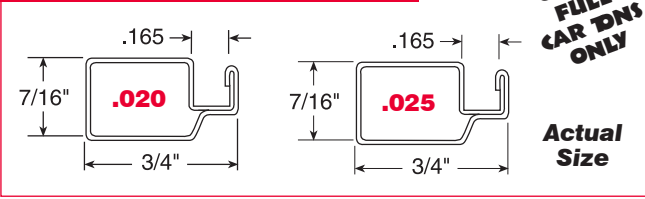

ORDER FULL CAR DNS ONLY

Actual Size

Part #	Length	Pieces per Ctn.	Thickness	Finish
PL-14035	72"	20	.020	Mill
PL-14036	72"	20	.020	Gray
PL-14037	72"	20	.020	Bronze
PL-14038	72"	20	.020	White
PL-14231	72"	40	.020	Mill
PL-14232	72"	40	.020	Gray
PL-14233	72"	40	.020	Bronze
PL-14234	72"	40	.020	White
PL-14039	94"	20	.020	Mill
PL-14040	94"	20	.020	Gray
PL-14041	94"	20	.020	Bronze
PL-14042	94"	20	.020	White
PL-15998	94"	20	.020	Almond
PL-14210	94"	40	.020	Mill
PL-14211	94"	40	.020	Gray
PL-14212	94"	40	.020	Bronze
PL-14213	94"	40	.020	White
PL-15999	94"	40	.020	Almond
PL-15617	12' 2"	40	.020	Mill
PL-15618	12' 2"	40	.020	Gray
PL-15619	12' 2"	40	.020	Bronze
PL-15620	12' 2"	40	.020	White
PL-14043	12' 2"	100	.020	Mill
PL-14044	12' 2"	100	.020	Gray
PL-14045	12' 2"	100	.020	Bronze
PL-14046	12' 2"	100	.020	White
PL-16000	12' 2"	100	.020	Almond
PL-14027	72"	20	.025	Mill
PL-14028	72"	20	.025	Gray
PL-14029	72"	20	.025	Bronze
PL-14030	72"	20	.025	White
PL-15613	12' 2"	40	.025	Mill
PL-15614	12' 2"	40	.025	Gray
PL-15615	12' 2"	40	.025	Bronze
PL-15616	12' 2"	40	.025	White
PL-14031	12' 2"	100	.025	Mill
PL-14032	12' 2"	100	.025	Gray
PL-14033	12' 2"	100	.025	Bronze
PL-14034	12' 2"	100	.025	White

• Use spline size: .165 (Aluminum mesh) See Page 28
 .185 (Fiberglass mesh)

3/4" X 7/16" CORNERS

Part #	Pack Qty.	Finish
PL-7724	4/Card	Gray
PL-7725	4/Card	Bronze
PL-7726	4/Card	White
PL-8145	4/Card	Gold
PL-14258	100/Box	Gray
PL-14259	100/Box	Bronze
PL-14260	100/Box	White
PL-14261	100/Box	Almond
PL-16014	250/Box	Gray
PL-16015	250/Box	Bronze
PL-16016	250/Box	White
PL-14263	1000/Box	Gray
PL-14264	1000/Box	Bronze
PL-14265	1000/Box	White

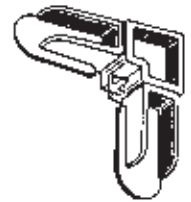

Plastic Square Cut

Part #	Pack Qty.	Finish
PL-14268	100/Box	Mill
PL-16028	500/Box	Mill
PL-14269	1000/Box	Mill

Metal Miter Cut .040 Gauge

Part #	Pack Qty.	Finish
PL-14270	100/Box	Mill
PL-14271	1000/Box	Mill

Fits .025 wall screen frame

Metal Miter Cut .050 Gauge

Part #	Pack Qty.	Handing	Finish
PL-16229	20/Tub	Left	White
PL-16230	20/Tub	Right	White

Plastic Square Cut

Left Hand Shown

Part #	Pack Qty.	Finish
PL-16138	20/Tub	Black
PL-16139	100/Box	Black

Plastic Miter Cut Adjustable from 45° to 135°

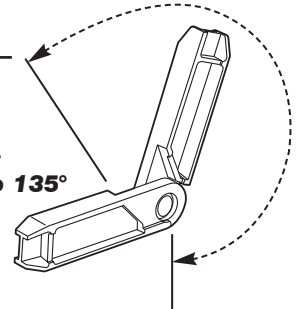

Minimum order: 6 cards per Carton - 1 Tub / Box

ALUMINUM SCREEN FRAME & CORNERS

3/4" X 3/8" SCREEN FRAME

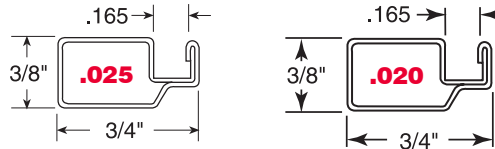

**ORDER
FULL CARDS
ONLY**

Actual Size

Part #	Length	Pieces per Ctn.	Thickness	Finish
PL-14053	72"	20	.020	Mill
PL-14054	72"	20	.020	Gray
PL-14055	72"	20	.020	Bronze
PL-14056	72"	20	.020	White
PL-14057	72"	20	.020	Almond
PL-14059	94"	20	.020	Mill
PL-14060	94"	20	.020	Gray
PL-14061	94"	20	.020	Bronze
PL-14062	94"	20	.020	White
PL-14063	94"	20	.020	Almond
PL-14218	94"	48	.020	Mill
PL-14219	94"	48	.020	Gray
PL-14220	94"	48	.020	Bronze
PL-14221	94"	48	.020	White
PL-14222	94"	48	.020	Almond
PL-16495	94"	48	.020	Adobe
PL-15624	12' 2"	48	.020	Mill
PL-15625	12' 2"	48	.020	Gray
PL-15626	12' 2"	48	.020	Bronze
PL-15627	12' 2"	48	.020	White
PL-15628	12' 2"	48	.020	Almond
PL-16496	12' 2"	48	.020	Adobe
PL-14065	12' 2"	100	.020	Mill
PL-14066	12' 2"	100	.020	Gray
PL-14067	12' 2"	100	.020	Bronze
PL-14068	12' 2"	100	.020	White
PL-14069	12' 2"	100	.020	Almond
PL-14047	72"	20	.025	Gray
PL-14048	72"	20	.025	Bronze
PL-14049	72"	20	.025	White
PL-15621	12' 2"	48	.025	Gray
PL-15622	12' 2"	48	.025	Bronze
PL-15623	12' 2"	48	.025	White
PL-14050	12' 2"	100	.025	Gray
PL-14051	12' 2"	100	.025	Bronze
PL-14052	12' 2"	100	.025	White

- Use spline size: .165 (Aluminum mesh) See Page 28
.185 (Fiberglass mesh)

3/8" CORNERS

Part #	Pack Qty.	Finish
PL-7721	4/Card	Gray
PL-7722	4/Card	Bronze
PL-7723	4/Card	White
PL-14272	100/Box	Gray
PL-14273	100/Box	Bronze
PL-14274	100/Box	White
PL-16017	250/Box	Gray
PL-16018	250/Box	Bronze
PL-16019	250/Box	White
PL-14277	1000/Box	Gray
PL-14278	1000/Box	Bronze
PL-14279	1000/Box	White

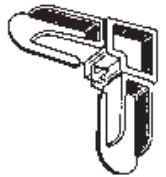

Plastic Square Cut

Part #	Pack Qty.	Finish
PL-14282	100/Box	Mill
PL-16029	500/Box	Mill
PL-14283	1000/Box	Mill

• For .020 Frame

PL-16472	100/Box	Mill
PL-16473	500/Box	Mill

• For .025 Frame

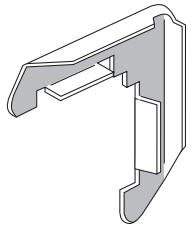

Metal Miter Cut .040 Gauge

Part #	Pack Qty.	Finish
PL-7873	4/Card	Almond
PL-14275	100/Box	Almond
PL-16020	250/Box	Almond
PL-14280	1000/Box	Almond

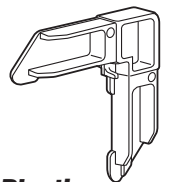

Plastic Square Cut

Minimum order: 6 cards per Carton - 1 Tub / Box

ALUMINUM SCREEN FRAME & CORNERS

3/4" X 5/16" SCREEN FRAME

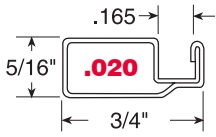

Actual Size

**ORDER
FULL CARTRIDGES
ONLY**

Part #	Length	Pieces per Ctn.	Finish
PL-14071	72"	20	Mill
PL-14072	72"	20	Gray
PL-14073	72"	20	Bronze
PL-14074	72"	20	White
PL-14075	72"	20	Almond
PL-14214	72"	56	Mill
PL-14216	72"	56	Bronze
PL-14217	72"	56	White
PL-14077	94"	20	Mill
PL-14078	94"	20	Gray
PL-14079	94"	20	Bronze
PL-14080	94"	20	White
PL-14081	94"	20	Almond
PL-14082	94"	20	Adobe
PL-14223	94"	56	Mill
PL-14224	94"	56	Gray
PL-14225	94"	56	Bronze
PL-14226	94"	56	White
PL-14227	94"	56	Almond
PL-15629	12' 2"	56	Mill
PL-15630	12' 2"	56	Gray
PL-15631	12' 2"	56	Bronze
PL-15632	12' 2"	56	White
PL-15633	12' 2"	56	Almond
PL-16476	12' 2"	56	Adobe
PL-14083	12' 2"	100	Mill
PL-14084	12' 2"	100	Gray
PL-14085	12' 2"	100	Bronze
PL-14086	12' 2"	100	White
PL-14087	12' 2"	100	Almond
PL-14088	12' 2"	100	Adobe

• Use spline size: .165 (Aluminum mesh) See Page 28
.185 (Fiberglass mesh)

Used on storm door screen panels

Part #	Pack Qty.	Finish	Part #	Pack Qty.	Handing	Finish
PL-16158	20/Tub	White	PL-16156	20/Tub	Left / Right	White
PL-16159	20/Tub	Brown	PL-16157	20/Tub	Left / Right	Brown

• 10 right hand & 10 left hand corner per tub

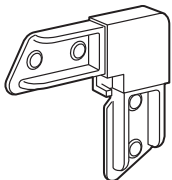

Plastic Square Cut

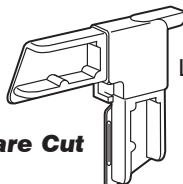

Plastic Square Cut

Left Hand Shown

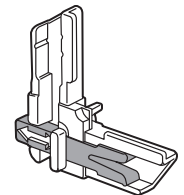

**Plastic Square Cut
Locking Screen**

3/4" X 5/16" CORNERS

Part #	Pack Qty.	Finish
PL-7727	4/Card	Gray
PL-7728	4/Card	Bronze
PL-7729	4/Card	White
PL-14284	100/Box	Gray
PL-14285	100/Box	Bronze
PL-14286	100/Box	White
PL-16078	100/Box	Black
PL-16021	250/Box	Gray
PL-16022	250/Box	Bronze
PL-16023	250/Box	White
PL-14289	1000/Box	Gray
PL-14290	1000/Box	Bronze
PL-14291	1000/Box	White
PL-16079	1000/Box	Black

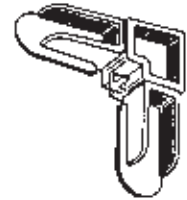

Plastic Square Cut

Part #	Pack Qty.	Finish
PL-7871	4/Card	Almond
PL-14287	100/Box	Almond
PL-16024	250/Box	Almond
PL-14292	1000/Box	Almond

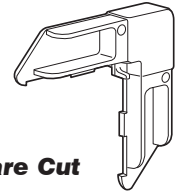

Plastic Square Cut

Part #	Pack Qty.	Finish
PL-8152	4/Card	Mill
PL-14294	100/Box	Mill
PL-16030	500/Box	Mill
PL-14295	1000/Box	Mill



Metal Miter Cut

Part #	Pack Qty.	Finish
PL-8096	4/Card	White
PL-16404	20/Tub	White
PL-16405	100/Box	White

Minimum order: 6 cards per Carton - 1 Tub / Box

ALUMINUM SCREEN FRAME & CORNERS

3/4" X 1/4" SCREEN FRAME

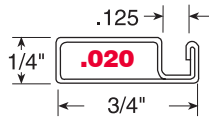

**ORDER
FULL CARDS
ONLY**
Actual Size

Part #	Length	Pieces per Ctn.	Finish
PL-14089	72"	20	Mill
PL-14090	72"	20	Bronze
PL-14091	72"	20	White
PL-14092	94"	20	Mill
PL-14093	94"	20	Bronze
PL-14094	94"	20	White
PL-14228	94"	48	Mill
PL-14229	94"	48	Bronze
PL-14230	94"	48	White
PL-15634	12' 2"	48	Mill
PL-15635	12' 2"	48	Bronze
PL-15636	12' 2"	48	White
PL-14095	12' 2"	90	Mill
PL-14096	12' 2"	90	Bronze
PL-14097	12' 2"	90	White

- Use spline size: .135 (Aluminum mesh) See Page 28
.150 (Fiberglass mesh)

3/4" X 1/4" CORNERS

Part #	Pack Qty.	Finish
PL-7718	4/Card	Gray
PL-7719	4/Card	Bronze
PL-7720	4/Card	White
PL-14296	100/Box	Gray
PL-14297	100/Box	Bronze
PL-14298	100/Box	White
PL-16025	250/Box	Gray
PL-16026	250/Box	Bronze
PL-16027	250/Box	White
PL-14301	1000/Box	Gray
PL-14302	1000/Box	Bronze
PL-14303	1000/Box	White

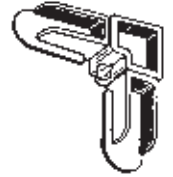

Plastic Square Cut

Part #	Pack Qty.	Finish
PL-14306	100/Box	Mill
PL-16031	500/Box	Mill
PL-14307	1000/Box	Mill

Metal Miter Cut

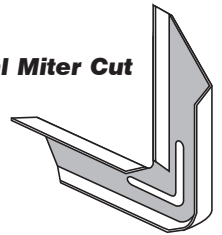

Minimum order: 6 cards per Carton - 1 Tub / Box

1/2" LIP FRAME

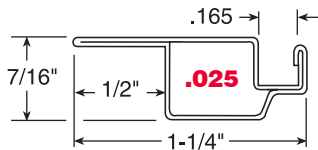

**ORDER
FULL CARDS
ONLY**
Actual Size

Part #	Length	Pieces per Ctn.	Finish
PL-14098	72"	15	Mill
PL-14099	72"	15	Gray
PL-14100	72"	15	Bronze
PL-14101	72"	15	White
PL-16371	94"	15	Mill
PL-16372	94"	15	Gray
PL-16373	94"	15	Bronze
PL-16374	94"	15	White
PL-15637	12' 2"	36	Mill
PL-15638	12' 2"	36	Gray
PL-15639	12' 2"	36	Bronze
PL-15640	12' 2"	36	White
PL-14106	12' 2"	70	Mill
PL-14107	12' 2"	70	Gray
PL-14108	12' 2"	70	Bronze
PL-14109	12' 2"	70	White

- Use spline size: .165 (Aluminum mesh) See Page 28
.185 (Fiberglass mesh)

1/2" LIP FRAME CORNERS

Part #	Pack Qty.	Finish
PL-14268	100/Box	Mill
PL-16028	500/Box	Mill
PL-14269	1000/Box	Mill

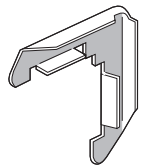

**Metal Miter Cut
.040 Gauge**

Part #	Pack Qty.	Finish
PL-14270	100/Box	Mill
PL-14271	1000/Box	Mill



**Metal Miter Cut
.050 Gauge**

Minimum order: 1 Tub / Box

ALUMINUM SCREEN FRAME & CORNERS

5/16" LIP FRAME - REVERSE LIP

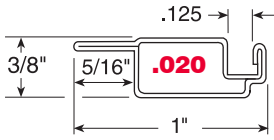

**ORDER
FULL CAR DNS
ONLY**

Actual Size

Part #	Length	Pieces per Ctn.	Finish
PL-16594	72"	15	Mill
PL-16595	72"	15	Bronze
PL-16596	72"	15	White
PL-15989	94"	15	Mill
PL-15991	94"	15	Bronze
PL-15992	94"	15	White
PL-16383	12' 2"	48	Mill
PL-16384	12' 2"	48	Bronze
PL-16385	12' 2"	48	White

- Use spline size: .140 (Aluminum mesh) See Page 28
- .150 (Fiberglass mesh)

5/16" CORNERS

Part #	Pack Qty.	Finish
PL-16387	100/Box	Gray
PL-16389	100/Box	Bronze
PL-16391	100/Box	White
PL-16388	250/Box	Gray
PL-16390	250/Box	Bronze
PL-16392	250/Box	White

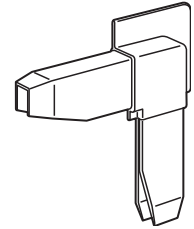

Plastic Square Cut

Part #	Pack Qty.	Finish
PL-14330	20/Tub	Mill
PL-14331	100/Box	Mill

Metal Miter Cut

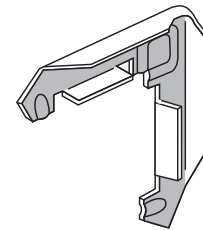

Minimum order: 1 Tub / Box

5/16" LIP FRAME - STANDARD LIP

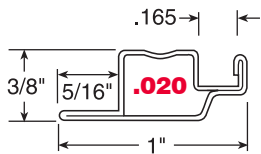

**ORDER
FULL CAR DNS
ONLY**

Actual Size

Part #	Length	Pieces per Ctn.	Finish
PL-15730	72"	24	Mill
PL-16367	72"	24	Gray
PL-14235	72"	24	Bronze
PL-15648	72"	24	White
PL-15649	72"	24	Almond
PL-16362	94"	24	Mill
PL-16368	94"	24	Gray
PL-16363	94"	24	Bronze
PL-16364	94"	24	White
PL-16365	94"	24	Almond
PL-15731	12' 2"	48	Mill
PL-16369	12' 2"	48	Gray
PL-14236	12' 2"	48	Bronze
PL-15650	12' 2"	48	White
PL-15651	12' 2"	48	Almond
PL-15732	12' 2"	120	Mill
PL-16370	12' 2"	120	Gray
PL-14237	12' 2"	120	Bronze
PL-15652	12' 2"	120	White
PL-15653	12' 2"	120	Almond

- Use spline size: .165 (Aluminum mesh) See Page 28
- .185 (Fiberglass mesh)

5/16" CORNERS

Part #	Pack Qty.	Finish
PL-14330	20/Tub	Mill
PL-14331	100/Box	Mill

Metal Miter Cut

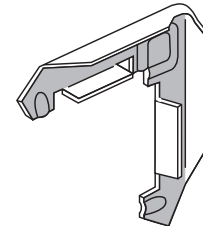

Minimum order: 1 Tub / Box

ALUMINUM SCREEN FRAME & CORNERS

3/8" EXTRUDED LIP FRAME

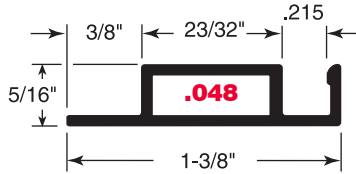

**ORDER
FULL CAR TONS
ONLY**

Actual Size

Part #	Length	Pieces per Ctn.	Finish
PL-15981	94"	10	Mill
PL-15982	94"	10	Bronze
PL-15983	94"	10	White

- Use spline size: .270 Foam spline - See Page 28
- .250 (Aluminum mesh) See Page 28
- .260 (Fiberglass mesh)

3/8" CORNERS

Part #	Pack Qty.	Finish
PL-15979	20/Tub	Mill
PL-15980	100/Box	Mill

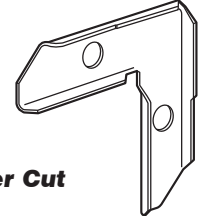

Metal Miter Cut

Minimum order: 1 Tub / Box

STAND-OFF FRAME

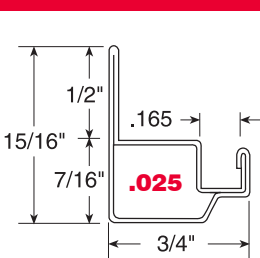

1/2" stand-off

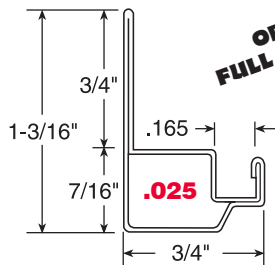

3/4" stand-off

Actual Size

**ORDER
FULL CAR TONS
ONLY**

Part #	Length	Pieces per Ctn.	Lip	Finish
PL-14125	72"	16	1/2"	Gray
PL-14126	72"	16	1/2"	Bronze
PL-14127	72"	16	1/2"	White
PL-15645	12' 2"	36	1/2"	Gray
PL-15646	12' 2"	36	1/2"	Bronze
PL-15647	12' 2"	36	1/2"	White
PL-14131	12' 2"	90	1/2"	Gray
PL-14132	12' 2"	90	1/2"	Bronze
PL-14133	12' 2"	90	1/2"	White
PL-14110	72"	16	3/4"	Mill
PL-14111	72"	16	3/4"	Gray
PL-14112	72"	16	3/4"	Bronze
PL-14113	72"	16	3/4"	White
PL-15641	12' 2"	36	3/4"	Mill
PL-15642	12' 2"	36	3/4"	Gray
PL-15643	12' 2"	36	3/4"	Bronze
PL-15644	12' 2"	36	3/4"	White
PL-14120	12' 2"	60	3/4"	Mill
PL-14121	12' 2"	60	3/4"	Gray
PL-14122	12' 2"	60	3/4"	Bronze
PL-14123	12' 2"	60	3/4"	White

- Use spline size: .165 (Aluminum mesh) See Page 28
- .185 (Fiberglass mesh)

CORNERS

**Metal Miter Cut
.040 Gauge**

Part #	Pack Qty.	Finish
PL-14268	100/Box	Mill
PL-16028	500/Box	Mill
PL-14269	1000/Box	Mill

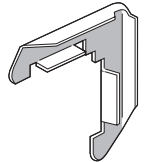

**Metal Miter Cut
.050 Gauge**

Part #	Pack Qty.	Finish
PL-14270	100/Box	Mill
PL-14271	1000/Box	Mill

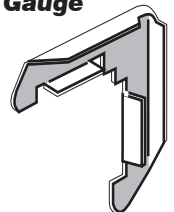

Minimum order: 1 Tub / Box

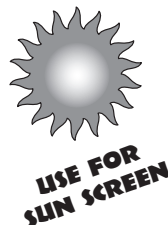

CORNERS

5/8" x 5/16" Corner

Part #	Pack Qty.	Finish
PL-14332	20/Box	Tan
PL-14333	100/Box	Tan
PL-14334	1000/Box	Tan

- Frame Not Available

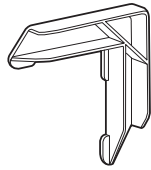

Plastic Miter Cut

1" x 7/16" Corner

Part #	Pack Qty.	Finish
PL-14941	20/Tub	Bronze
PL-14939	20/Tub	White
PL-14943	20/Tub	Almond
PL-14942	100/Box	Bronze
PL-14940	100/Box	White
PL-14944	100/Box	Almond

- Frame Not Available Fits Kolbe Windows and others

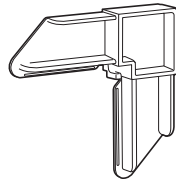

Plastic Square Cut

3/4" x 3/8" Corner

Part #	Pack Qty.	Finish
PL-15664	100/Box	Gray
PL-15666	100/Box	Bronze
PL-15665	100/Box	White
PL-15667	100/Box	Almond

- Fits Elgar Frame

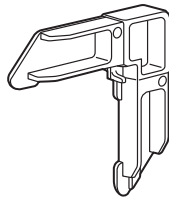

Plastic Square Cut

5/8" x 1/4" Corner

Part #	Pack Qty.	Finish
PL-14335	20/Tub	Gray
PL-14336	20/Tub	White
PL-14337	20/Tub	Black
PL-14338	100/Box	Gray
PL-14339	100/Box	White
PL-14340	100/Box	Black

- Frame Not Available
- Use 3/4" x 1/4" System

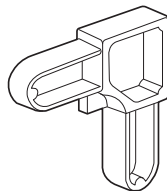

Plastic Square Cut

5/16" x 3/4" Stand-Off Corner (5/32" Stand-off)

Part #	Pack Qty.	Finish
PL-8163	4/Card	White
PL-16441	20/Tub	White
PL-16442	100/Box	White

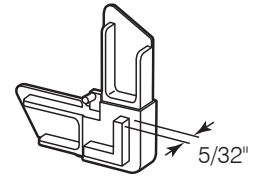

Plastic Square Cut

3/4" x 3/8" Corner

Part #	Pack Qty.	Finish
PL-16424	100/Box	White

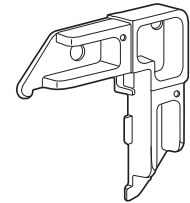

Plastic Square Cut

7/16" x 1/4" Corner

Part #	Pack Qty.	Finish
PL-16419	20/Tub	White
PL-16420	100/Box	White

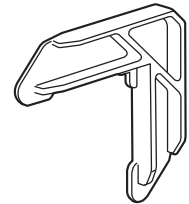

Plastic Miter Cut

3/4" x 7/16" Corner

Part #	Pack Qty.	Finish
PL-16080	20/Tub	Gray
PL-16081	20/Tub	Bronze
PL-16082	20/Tub	White

- Frame Not Available

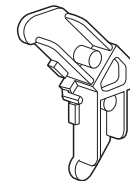

Octagon Screen Corner

Part #	Pack Qty.	Finish
PL-8204	4/Card	White
PL-16607	20/Tub	White
PL-16608	100/Box	White

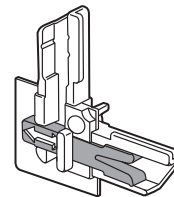

Plastic Square Cut Locking Screen

Minimum order: 6 cards per Carton - 1 Tub / Box

CORNERS

1" x 7/16" Screen Corner (Andersen)

Part #	Pack Qty.	Finish
PL-15943	20/Tub	Bronze
PL-15944	20/Tub	White
PL-15945	20/Tub	Tan
PL-15946	100/Box	Bronze
PL-15947	100/Box	White
PL-15948	100/Box	Tan

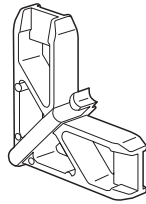

Plastic Outside Miter

- Frame Not Available
- See page 6 for 3/4" Corners

Octagon Frame Splice Plate

Part #	Pack Qty.	Finish
PL-15094	20/Tub	Mill
PL-15095	100/Tub	Mill

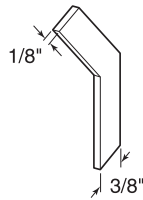

135° Surface Mount

Screen Door Corner (Andersen & Others)

Part #	Pack Qty.	Finish
PL-16039	20/Box	Bronze
PL-16124	20/Box	White

- Frame Not Available

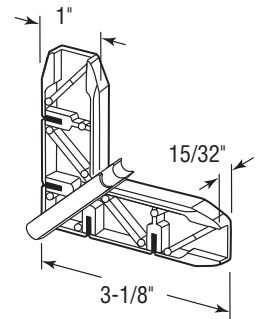
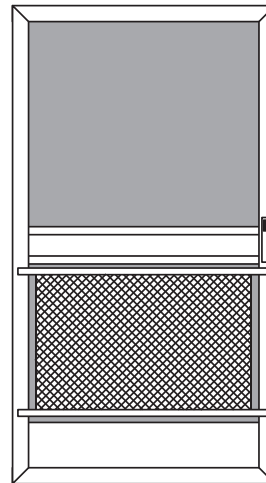

Plastic Outside Miter

ALUMINUM SCREEN FRAME & CORNERS

SPREADER BAR

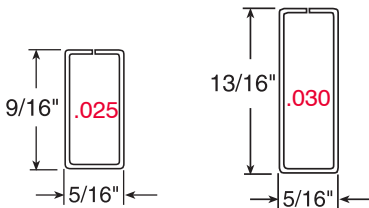

ORDER FULL CAR DNS ONLY

Actual Size

Part #	Length	Pieces per Ctn.	Size	Finish
PL-7795	48"	3	5/8"	Mill
PL-7796	48"	3	5/8"	Bronze
PL-7797	48"	3	5/8"	White
PL-14138	72"	20	5/8"	Mill
PL-14139	72"	20	5/8"	Gray
PL-14140	72"	20	5/8"	Bronze
PL-14141	72"	20	5/8"	White
PL-14142	72"	20	5/8"	Almond
PL-14134	72"	20	7/8"	Mill
PL-14135	72"	20	7/8"	Gray
PL-14136	72"	20	7/8"	Bronze
PL-14137	72"	20	7/8"	White

CLIPS

Part #	Pack Qty.	Finish
PL-14308	100/Tub	Mill
PL-14309	1000/Box	Mill

Metal (7/8")

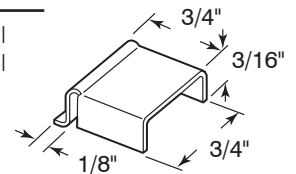

Part #	Pack Qty.	Finish
PL-7794	6/Card	Mill
PL-14310	100/Tub	Mill
PL-14311	1000/Box	Mill

Metal (5/8")

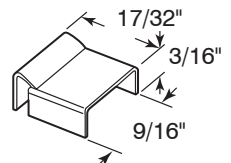

Minimum order: 6 cards per Carton - 1 Tub / Box

ALUMINUM SCREEN FRAME

SCREEN ADJUSTMENT CHANNEL - ROLL FORMED

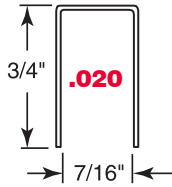

Actual Size

ORDER FULL CAR DNS ONLY

Used as a top mount slip channel for double hung wood window screens.

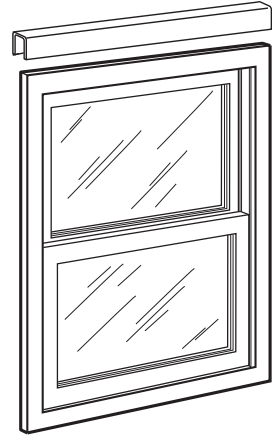

Part #	Length	Pieces per Ctn.	Size	Finish
PL-14145	72"	12	3/4"	Gray

7/16" EXTRUDED "H" SECTION

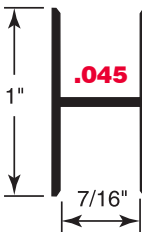

Actual Size

ORDER FULL CAR DNS ONLY

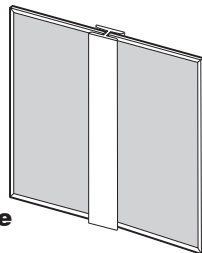

Solar screen center connecting mullion

Part #	Length	Pieces per Ctn.	Finish
PL-14146*	72"	12	Gray
PL-14147	72"	12	Bronze
PL-14148	72"	12	White

* Satin Anodized

1/2" x 1/2" ANGLE STOP

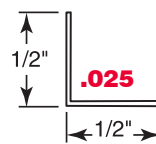

Actual Size

ORDER FULL CAR DNS ONLY

Part #	Length	Pieces per Ctn.	Finish
PL-14149	72"	20	Mill
PL-14151	72"	20	White

• 1/8" holes, 8" apart

Part #	Min. Order	Pack Qty.
--------	------------	-----------

PL-14708	1	1000/Ctn.
----------	---	-----------

• 3/4" x 14ga.



7/16" SOLAR SCREEN HANGER BRACKETS

Part #	Pack Qty.	Finish
PL-8146	2 Pair	Mill
PL-8147	2 Pair	Bronze
PL-8148	2 Pair	White

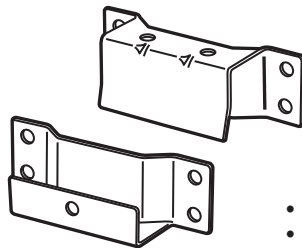

• Fits 7/16" frame
• Aluminum material

SCREEN FRAME KITS

Description: 10 kits per carton; sold in carton quantity only.

**ORDER
FULL CAR TONS
ONLY**

Kit Part Number	Size	Finish	Length
PL-8036	1/4" x 3/4"	Mill	3'
PL-8037	"	"	4'
PL-8038	"	"	5'
PL-8039	1/4" x 3/4"	Bronze	3'
PL-8040	"	"	4'
PL-8041	"	"	5'
PL-8042	1/4" x 3/4"	White	3'
PL-8043	"	"	4'
PL-8044	"	"	5'
PL-7803	5/16" x 3/4"	Mill	3'
PL-7804	"	"	4'
PL-7805	"	"	5'
PL-7856	5/16" x 3/4"	Gray	3'
PL-7857	"	"	4'
PL-7858	"	"	5'
PL-7806	5/16" x 3/4"	Bronze	3'
PL-7807	"	"	4'
PL-7808	"	"	5'
PL-7812	5/16" x 3/4"	White	3'
PL-7813	"	"	4'
PL-7814	"	"	5'
PL-7815	3/8" x 3/4"	Mill	3'
PL-7816	"	"	4'
PL-7817	"	"	5'
PL-7818	3/8" x 3/4"	Bronze	3'
PL-7819	"	"	4'
PL-7820	"	"	5'
PL-7821	3/8" x 3/4"	White	3'
PL-7822	"	"	4'
PL-7823	"	"	5'
PL-7800	7/16" x 3/4"	Mill	3'
PL-7801	"	"	4'
PL-7802	"	"	5'
PL-7839	7/16" x 3/4"	Gray	3'
PL-7840	"	"	4'
PL-7841	"	"	5'
PL-7809	7/16" x 3/4"	Bronze	3'
PL-7810	"	"	4'
PL-7811	"	"	5'
PL-7836	7/16" x 3/4"	White	3'
PL-7837	"	"	4'
PL-7838	"	"	5'



MAKE-TO-FIT

Square Cut
**SCREEN
FRAME
KIT**

Square-Cut Screen
or Storm Window Kit

**3 EASY
STEPS**

**TO BUILD YOUR OWN
CUSTOM SIZE SCREENS**



Measure and Cut



Assemble



Roll and Trim

Kit Contains:

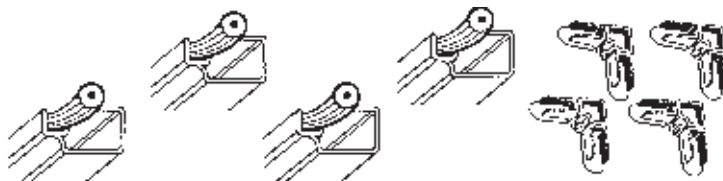

- Easy To Follow Instructions Enclosed.
- Accepts Aluminum or Fiberglass Mesh Screen or Flexible Poly Film.
- Remove spline from spline channel before cutting frame.

Glass Thickness:
 Single - .085 to .101
 Double - .115 to .134

Note: .100 thick plexiglass can be .085 to .090 thick.

ALUMINUM WINDOW FRAME & ACCESSORIES

3/8" WINDOW FRAME

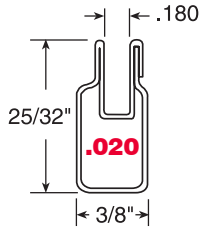

Actual Size

ORDER FULL CAR TONS ONLY

Part #	Length	Pieces per Ctn.	Finish
PL-14152	72"	12	Mill
PL-14153	72"	12	Bronze
PL-14154	72"	12	White
PL-14155	94"	12	Mill
PL-14156	94"	12	Bronze
PL-14157	94"	12	White
PL-14247	94"	25	Mill
PL-14248	94"	25	Bronze
PL-14249	94"	25	White
PL-14158	12' 2"	50	Mill
PL-14159	12' 2"	50	Bronze
PL-14160	12' 2"	50	White

3/8" RIGID VINYL FRAME

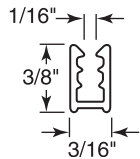

Actual Size

ORDER FULL CAR TONS ONLY

Part #	Length	Pieces per Ctn.	Finish
PL-15966	72"	25	White

- Single strength glass or .80 Acrylic sheet
- Requires no vinyl insert
- Uses no corner
- Used on basement and storm windows

3/8" GLASS SURROUND

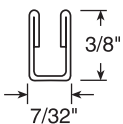

Actual Size

ORDER FULL CAR TONS ONLY

Part #	Length	Pieces per Ctn.	Finish
PL-14170	72"	12	Mill
PL-14171	72"	12	White

- Single strength glass or .100 Acrylic sheet
- No corner required
- Use with glass sealant P-7868 (See page 45)

3/8" ACCESSORIES

Part #	Pack Qty.	Finish
PL-14312	20/Tub	Gray
PL-14313	20/Tub	Bronze
PL-14314	20/Tub	White
PL-14315	100/Box	Gray
PL-14316	100/Box	Bronze
PL-14317	100/Box	White

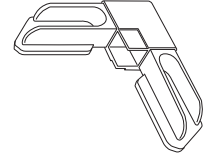

Plastic Square Cut

Minimum order: 1 Tub / Box

Part #	Pack Qty.	Finish
PL-14318	20/Tub	Mill
PL-14319	100/Box	Mill
PL-14320	1000/Box	Mill

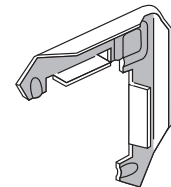

Metal Miter Cut

Minimum order: 1 Tub / Box

Part #	Length	Vinyl
P-7734	100 ft.	Gray
P-7735	200 ft.	Gray
P-7736	1000 ft.	Gray

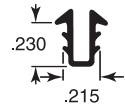

Glazing Channel Single Strength Glass

Minimum order: 1 Carton

Part #	Length	Vinyl
P-7743	100 ft.	Gray
P-7744	200 ft.	Gray
P-7745	1000 ft.	Gray

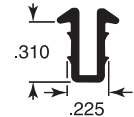

Glazing Channel Double Strength Glass

Minimum order: 1 Carton

1" RIGID VINYL LIP FRAME

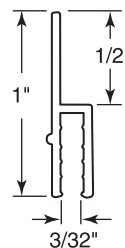

Actual Size

ORDER FULL CAR TONS ONLY

Part #	Length	Pieces per Ctn.	Finish
PL-15967	72"	25	White

- Single strength glass or Acrylic sheet
- Requires no vinyl insert
- Uses no corner
- Used on basement and storm windows

Glass Thickness:
Single - .085 to .101
Double - .115 to .134

Note: .100 thick plexiglass can be .085 to .090 thick.

ALUMINUM WINDOW FRAME & ACCESSORIES

5/16" EXTRUDED WINDOW FRAME

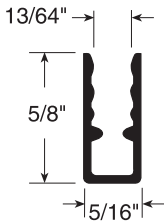

**ORDER
FULL CAR TDNS
ONLY**

Actual Size

Part #	Length	Pieces per Ctn.	Finish
PL-14161	72"	12	Mill
PL-14162	72"	12	Bronze
PL-14163	72"	12	White
PL-14164	94"	12	Mill
PL-14165	94"	12	Bronze
PL-14166	94"	12	White
PL-16113	94"	25	Mill
PL-16114	94"	25	Bronze
PL-16115	94"	25	White
PL-14167	12' 2"	50	Mill
PL-14168	12' 2"	50	Bronze
PL-14169	12' 2"	50	White

- Painted finishes are powder coated

5/16" EXTRUDED H-SECTION WINDOW FRAME

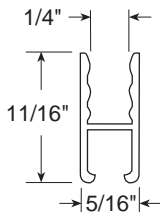

**ORDER
FULL CAR TDNS
ONLY**

Actual Size

Part #	Length	Pieces per Ctn.	Finish
PL-14172	72"	12	Mill
PL-16559	72"	12	Bronze
PL-16558	72"	12	White

Part # Length Vinyl

Glazing Channel Single Strength Glass

P-7731	100 ft.	Gray
P-7732	200 ft.	Gray
P-7733	1000 ft.	Gray

Minimum order: 1 Carton

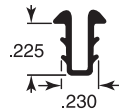

Glazing Channel Double Strength Glass

P-7743	100 ft.	Gray
P-7744	200 ft.	Gray
P-7745	1000 ft.	Gray

Minimum order: 1 Carton

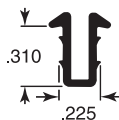

5/16" ACCESSORIES

Part # Pack Qty.

PL-14964	20/Tub
PL-14965	100/Tub

Minimum order: 1 Tub



Nylon Corner Key

Part # Pack Qty.

PL-15030	20/Tub
PL-15031	100/Tub

Minimum order: 1 Tub



Aluminum Corner Key

Part # Length Vinyl

P-7734	100 ft.	Gray
P-7735	200 ft.	Gray
P-7736	1000 ft.	Gray

Minimum order: 1 Carton

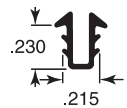

**Glazing Channel
Single Strength Glass**

Part # Length Vinyl

P-7743	100 ft.	Gray
P-7744	200 ft.	Gray
P-7745	1000 ft.	Gray

Minimum order: 1 Carton

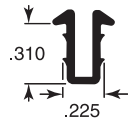

**Glazing Channel
Double Strength Glass**

Part # Length Vinyl

P-7755	100 ft.	Gray
P-7756	200 ft.	Gray
P-7757	1000 ft.	Gray

Minimum order: 1 Carton

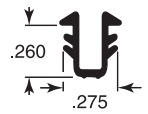

**Glazing Channel
.085 Plexiglass
(Known as .100 thick)**

H-SECTION ACCESSORIES

Part # Pack Qty.

Corner Key - Nylon

PL-16276	20/Tub
PL-16277	100/Tub

Minimum order: 1 Tub



Corner Key - Aluminum

PL-15052	20/Tub
PL-15053	100/Tub

Minimum order: 1 Tub

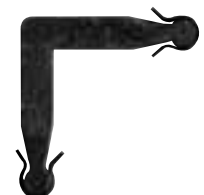

Glass Thickness:
 Single - .085 to .101
 Double - .115 to .134

Note: .100 thick plexiglass can be .085 to .090 thick.

UNIVERSAL "C" SASH

UNIVERSAL SASH

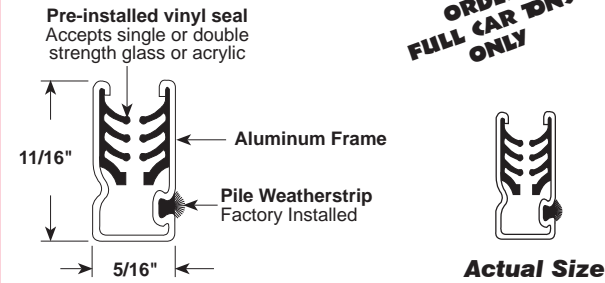

ORDER FULL CAR TONS ONLY

Part #	Length	Pieces per Ctn.	Finish
PL-14177	72"	12	Mill
PL-14178	72"	12	Bronze
PL-14179	72"	12	White
PL-14174	12'	20	Mill
PL-14175	12'	20	Bronze
PL-14176	12'	20	White

- Ready to assemble.
- Easy frame assembly by either miter cutting or square cutting.
- Frame combines roll-formed aluminum, pile weatherstrip and vinyl glass seal.
- For interior or exterior use.

CORNERS

Part #	Pack Qty.	Finish
PL-8001	4/Card	Gray
PL-8002	4/Card	Bronze
PL-8003	4/Card	White
PL-14321	20/Tub	Gray
PL-14322	20/Tub	Bronze
PL-14323	20/Tub	White
PL-14324	100/Tub	Gray
PL-14325	100/Tub	Bronze
PL-14326	100/Tub	White

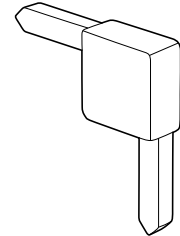

Plastic Square Cut

Part #	Pack Qty.	Finish
PL-8000	4/Card	Mill
PL-14327	20/Tub	Mill
PL-14328	100/Tub	Mill

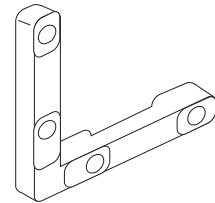

Metal Miter Cut

Minimum order: 6 cards per Carton - 1 Tub / Box

GLASS MOLD INSULATING FRAMES

UNIVERSAL SASH

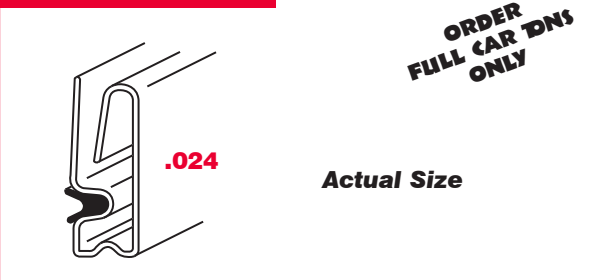

ORDER FULL CAR TONS ONLY

Part #	Length	Pieces per Ctn.	Finish
PL-16241	72"	12	Mill
PL-16242	72"	12	Bronze
PL-16243	72"	12	White

- Fits single or double strength glass or plexi-glass.
- With vinyl weatherstrip.

ACCESSORIES

Part #	Pack Qty.	Finish
Metal Miter Cut Corner		
PL-16244	20/Tub	Mill
PL-16245	100/Box	Mill

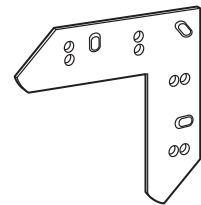

Part #	Pack Qty.	Finish
Corner Clip		
PL-16246	100/Box	Mill

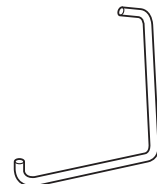

Minimum order: 1 Tub / Box

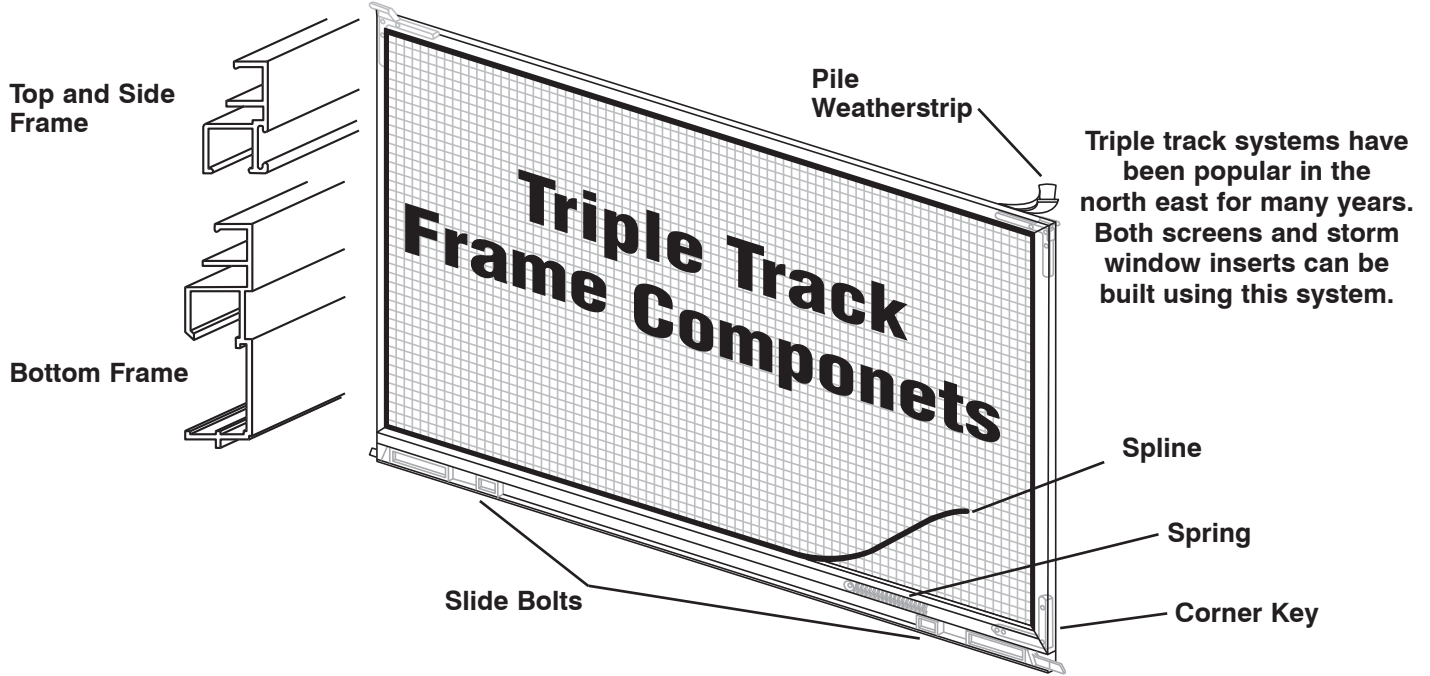

Standard Style Window Frame



Drop-in Style Window Frame



Wrap Around Style Screen Frame

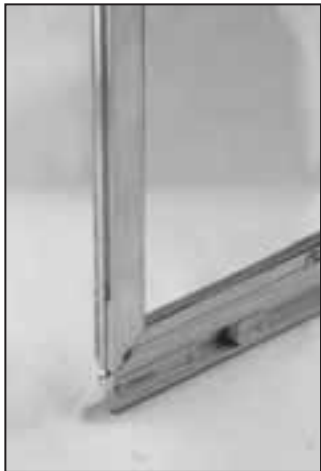

TRIPLE TRACK WINDOW FRAME - STANDARD STYLE

SIDE AND TOP WINDOW FRAME

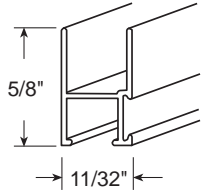

Actual Size

ORDER FULL CAR TONS ONLY

Standard Style

Part #	Length	Pieces per Ctn.	Finish
PL-14189	72"	12	Mill
PL-14190	72"	12	Bronze
PL-14191	72"	12	White
PL-16107	94"	12	Mill
PL-16108	94"	12	White

• Painted finishes are powder coated

BOTTOM WINDOW FRAME

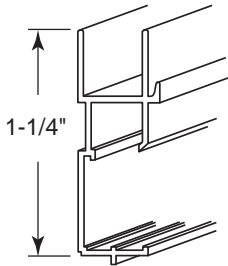

Actual Size

ORDER FULL CAR TONS ONLY

Standard Style

Part #	Length	Pieces per Ctn.	Finish
PL-14192	72"	6	Mill
PL-14193	72"	6	Bronze
PL-14194	72"	6	White
PL-16105	94"	6	Mill
PL-16106	94"	6	White

• Painted finishes are powder coated

Part #	Length	Vinyl
P-7740	100 ft.	Gray
P-7741	200 ft.	Gray
P-7742	800 ft.	Gray

Minimum order: 1 Carton

**Glazing Channel
Single Strength Glass**

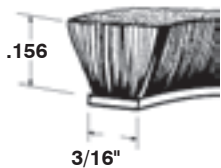
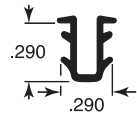

Part #	Length	Color
Weatherstrip		
T-8658	18 ft.	Gray
P-7823	100 ft.	Gray
P-7824	1000 ft.	Gray

Minimum order: 1 Carton

Part #	Pack Qty.
Slide Bolt Spring	
PL-14895	20/Tub
PL-14896	100/Tub

Minimum order: 10

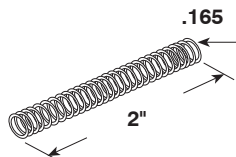

WINDOW FRAME ACCESSORIES

Part #	Pack Qty.
PL-14952	20/Tub
PL-14953	100/Tub



Nylon Corner Key

Part #	Pack Qty.
PL-15052	20/Tub
PL-15053	100/Tub



Diecast Corner Key

Part #	Pack Qty.
PL-15132	20/Tub
PL-15133	100/Tub



Nylon Tilt Key

Part #	Pack Qty.
PL-15228	20/Tub
PL-15229	100/Tub



Diecast Tilt Key

Part #	Pack Qty.
PL-15360	20/Tub
PL-15361	100/Box



Nylon Slide Bolt - Left Hand

Part #	Pack Qty.
PL-15362	20/Tub
PL-15363	100/Box



Nylon Slide Bolt - Right Hand

Part #	Pack Qty.
PL-15492	20/Tub
PL-15493	100/Box



Diecast Slide Bolt - Left Hand

Part #	Pack Qty.
PL-15494	20/Tub
PL-15495	100/Box



Diecast Slide Bolt - Right Hand

Minimum order: 1 Tub / Box

TRIPLE TRACK WINDOW FRAME - DROP-IN STYLE

SIDE AND TOP WINDOW FRAME

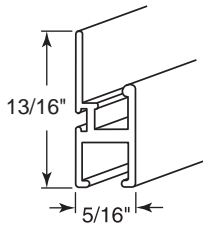

Actual Size

ORDER FULL CAR TONS ONLY

Drop-in Style

Part #	Length	Pieces per Ctn.	Finish
PL-15968	72"	12	Mill
PL-15969	72"	12	Bronze
PL-15970	72"	12	White
PL-16411	94"	12	Mill
PL-16412	94"	12	White

• Painted finishes are powder coated

BOTTOM WINDOW FRAME

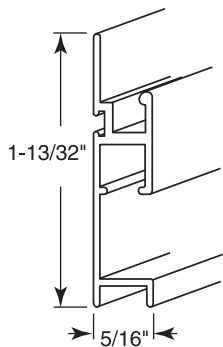

Actual Size

ORDER FULL CAR TONS ONLY

Drop-in Style

Part #	Length	Pieces per Ctn.	Finish
PL-15971	72"	6	Mill
PL-15972	72"	6	Bronze
PL-15973	72"	6	White
PL-16413	94"	6	Mill
PL-16414	94"	6	White

• Painted finishes are powder coated

Part #	Length	Vinyl
P-7770	100 ft.	Gray
P-7771	200 ft.	Gray
P-7772	1000 ft.	Gray

Minimum order: 1 Carton

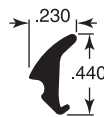

Glazing Spline

Part #	Pack Qty.
PL-14895	20/Tub
PL-14896	100/Tub

Minimum order: 10

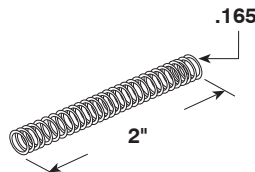

Slide Bolt Spring

WINDOW FRAME ACCESSORIES

Part #	Pack Qty.
PL-14952	20/Tub
PL-14953	100/Tub



Nylon Corner Key

Part #	Pack Qty.
PL-15052	20/Tub
PL-15053	100/Tub



Diecast Corner Key

Part #	Pack Qty.
PL-15132	20/Tub
PL-15133	100/Tub



Nylon Tilt Key

Part #	Pack Qty.
PL-15228	20/Tub
PL-15229	100/Tub



Diecast Tilt Key

Part #	Pack Qty.
PL-15492	20/Tub
PL-15493	100/Box



Diecast Slide Bolt - Left Hand

Part #	Pack Qty.
PL-15494	20/Tub
PL-15495	100/Box



Diecast Slide Bolt - Right Hand

Part #	Pack Qty.
PL-15304	20/Tub
PL-15305	100/Box



Nylon Slide Bolt - Left Hand

Part #	Pack Qty.
PL-15306	20/Tub
PL-15307	100/Box



Nylon Slide Bolt - Right Hand

Minimum order: 1 Tub / Box

TRIPLE TRACK SCREEN FRAME

SIDE AND TOP SCREEN FRAME

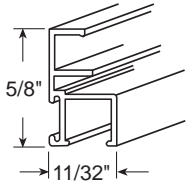

Actual Size

Wrap Around Style

ORDER FULL CAR TONS ONLY

Part #	Length	Pieces per Ctn.	Finish
PL-14201	72"	12	Mill
PL-14202	72"	12	Bronze
PL-14203	72"	12	White
PL-16111	94"	12	Mill
PL-16112	94"	12	White

• Painted finishes are powder coated

BOTTOM SCREEN FRAME

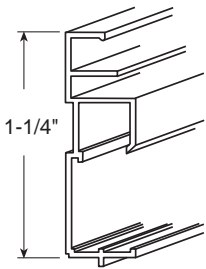

Actual Size

Wrap Around Style

ORDER FULL CAR TONS ONLY

Part #	Length	Pieces per Ctn.	Finish
PL-14204	72"	6	Mill
PL-14205	72"	6	Bronze
PL-14206	72"	6	White
PL-16109	94"	6	Mill
PL-16110	94"	6	White

• Painted finishes are powder coated

Retainer Spline

Part #	Length	Vinyl
P-7633	25 ft.	Gray
P-7660	100 ft.	Gray
P-7661	250 ft.	Gray
P-7662	500 ft.	Gray

Minimum order: 1 Carton

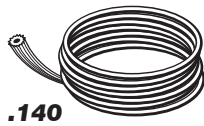

Weatherstrip

Part #	Length	Color
T-8658	18 ft.	Gray
P-7823	100 ft.	Gray
P-7824	1000 ft.	Gray

Minimum order: 1 Carton

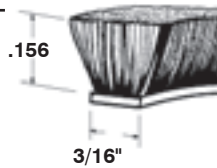

Slide Bolt Spring

Part #	Pack Qty.
PL-14895	20/Tub
PL-14896	100/Tub

Minimum order: 10

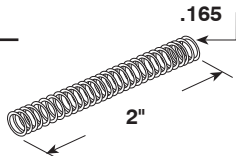

SCREEN FRAME ACCESSORIES

Part #	Pack Qty.
PL-14952	20/Tub
PL-14953	100/Tub



Nylon Corner Key

Part #	Pack Qty.
PL-15052	20/Tub
PL-15053	100/Tub



Diecast Corner Key

Part #	Pack Qty.
PL-15132	20/Tub
PL-15133	100/Tub

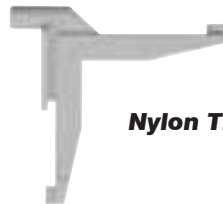

Nylon Tilt Key

Part #	Pack Qty.
PL-15228	20/Tub
PL-15229	100/Tub



Diecast Tilt Key

Part #	Pack Qty.
PL-15360	20/Tub
PL-15361	100/Box



Nylon Slide Bolt - Left Hand

Part #	Pack Qty.
PL-15362	20/Tub
PL-15363	100/Box



Nylon Slide Bolt - Right Hand

Part #	Pack Qty.
PL-15492	20/Tub
PL-15493	100/Box



Diecast Slide Bolt - Left Hand

Part #	Pack Qty.
PL-15494	20/Tub
PL-15495	100/Box



Diecast Slide Bolt - Right Hand

Minimum order: 1 Tub / Box

OFFSET INSULATING GLASS ADAPTER CHANNEL (Accommodates 1/2" Insulating Glass Units)

OFFSET CHANNEL

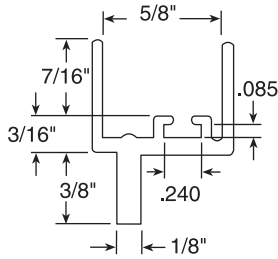

Actual Size

**ORDER
FULL CARTONS
ONLY**

Part #	Length	Pieces per Ctn.	Finish
PL-16443	96"	6	Clear
PL-16444	12' 2"	6	Clear
PL-16445	96"	6	Bronze
PL-16446	12' 2"	6	Bronze

- Used to replace single glaze windows with a sealed insulating glass unit.
- Window adapter channel can be fastened with the PL-16447 corner or 8 x 5/8" undercut panhead screws.

ACCESSORIES

Part #	Pack Qty.
PL-16447	20/Tub
PL-16448	100/Tub

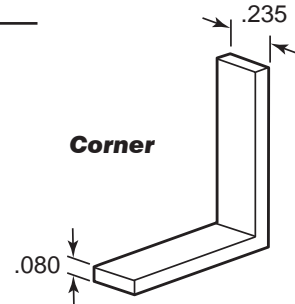

Corner

Part #	Pack Qty.
PL-16449	100/Tub

- For wood window reglazing to secure window pane.

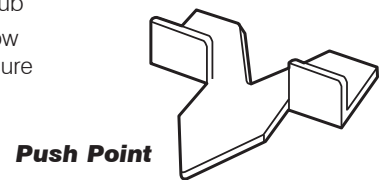

Push Point

Part #	Length	Vinyl
P-8417	100 ft.	Black
P-8418	200 ft.	Black
P-8419	500 ft.	Black

Minimum order: 1 Carton

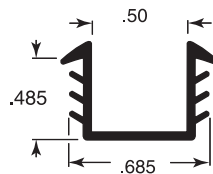

IG Glass Insert

Converts any single glazed window into a Dual Glazed window

- Simply replace existing glass with new framing system you build
- Uses 1/2" standard insulated glass units you order from your local glass supplier.

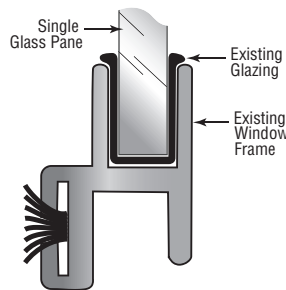
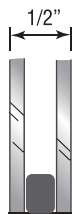

- The new IG pane fits right into the customers existing window system.

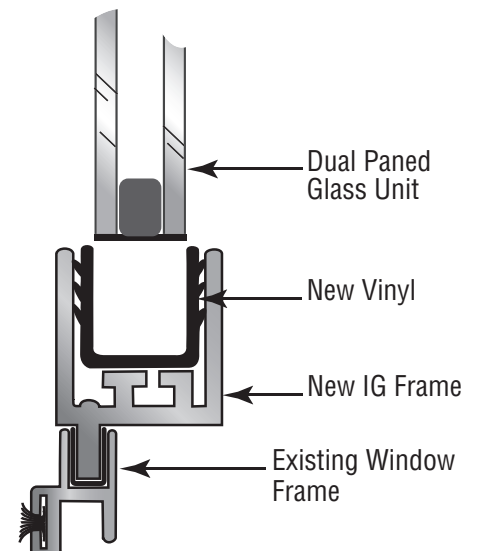

**Savings of 200% or more for the customer.
Profits of 70-80% for you!**

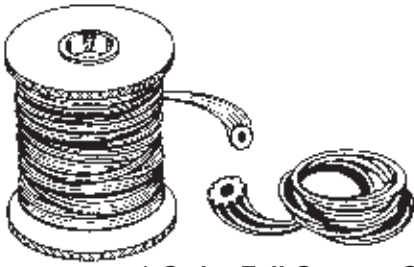

SCREEN RETAINER SPLINE

- FOR ALUMINUM AND FIBERGLASS SCREENING

Description: Top quality vinyl, round, hollow core, serrated.

* Order Full Cartons Only

SIZE/ DECIMAL	POLY-BAG 25 FT. * 10 Bags/Ctn.		BULK												APPROX. FT. PER 15 LB. ROLL
	Black	Gray	100 FT.			250 FT.			500 FT.			15 LBS.			
			Black	Gray	White	Black	Gray	White	Black	Gray	White	Black	Gray	White	
.120 - 1/8"	P-7516	P-7630	P-7550	P-7648	P-8231	P-7551	P-7649	P-8254	P-7552	P-7650	P-8277	P-7553	P-7651	P-8300	2670
.130	P-7517	P-7631	P-7554	P-7652	P-8232	P-7555	P-7653	P-8255	P-7556	P-7654	P-8278	P-7557	P-7655	P-8301	2400
.135	P-7518	P-7632	P-7558	P-7656	P-8233	P-7559	P-7657	P-8256	P-7560	P-7658	P-8279	P-7561	P-7659	P-8302	2190
.140 - 9/64"	P-7519	P-7633	P-7562	P-7660	P-8234	P-7563	P-7661	P-8257	P-7564	P-7662	P-8280	P-7565	P-7663	P-8303	1920
.150	P-7533	P-7634	P-7612	P-7664	P-8235	P-7613	P-7665	P-8258	P-7614	P-7666	P-8281	P-7615	P-7667	P-8304	1815
.155 - 5/32"	P-7520	P-7635	P-7566	P-7668	P-8236	P-7567	P-7669	P-8259	P-7568	P-7670	P-8282	P-7569	P-7671	P-8305	1710
.165 - 11/64"	P-7521	P-7636	P-7570	P-7672	P-8237	P-7571	P-7673	P-8260	P-7572	P-7674	P-8283	P-7573	P-7675	P-8306	1500
.170	P-7522	P-7637	P-7574	P-7676	P-8238	P-7575	P-7677	P-8261	P-7576	P-7678	P-8284	P-7577	P-7679	P-8307	1400
.175	P-7523	P-7638	P-7578	P-7680	P-8239	P-7579	P-7681	P-8262	P-7580	P-7682	P-8285	P-7581	P-7683	P-8308	1320
.180	P-7524	P-7639	P-7582	P-7684	P-8240	P-7583	P-7685	P-8263	P-7584	P-7686	P-8286	P-7585	P-7687	P-8309	1200
.185 - 3/16"	P-7940	P-7941	P-7942	P-7943	P-8241	P-7944	P-7945	P-8264	P-7946	P-7947	P-8287	P-7948	P-7949	P-8310	1140
.190	P-7525	P-7640	P-7586	P-7688	P-8242	P-7587	P-7689	P-8265	P-7588	P-7690	P-8288	P-7589	P-7691	P-8311	1095
.195	P-7950	P-7951	P-7952	P-7953	P-8243	P-7954	P-7955	P-8266	P-7956	P-7957	P-8289	P-7958	P-7959	P-8312	1005
.200 - 13/64"	P-7526	P-7641	P-7590	P-7692	P-8244	P-7591	P-7693	P-8267	—	—	—	P-7593	P-7695	P-8313	990
.210 - 7/32"	P-7527	P-7642	P-7594	P-7696	P-8245	P-7595	P-7697	P-8268	—	—	—	P-7596	P-7699	P-8314	915
.215	P-7960	P-7961	P-7962	P-7963	P-8246	P-7964	P-7965	P-8269	—	—	—	P-7968	P-7969	P-8315	865
.220	P-7528	P-7643	P-7597	P-7700	P-8247	P-7598	P-7701	P-8270	—	—	—	P-7599	P-7703	P-8316	855
.225	P-7970	P-7971	P-7972	P-7973	P-8248	P-7974	P-7975	P-8271	—	—	—	P-7978	P-7979	P-8317	800
.230 - 15/64"	P-7529	P-7644	P-7600	P-7704	P-8249	P-7601	P-7705	P-8272	—	—	—	P-7602	P-7707	P-8318	780
.235	P-7980	P-7981	P-7982	P-7983	P-8250	P-7984	P-7985	P-8273	—	—	—	P-7988	P-7989	P-8319	750
.250 - 1/4"	P-7530	P-7645	P-7603	P-7708	P-8251	P-7604	P-7709	P-8274	—	—	—	P-7605	P-7711	P-8320	675
.260	P-7531	P-7646	P-7606	P-7712	P-8252	P-7607	P-7713	P-8275	—	—	—	P-7608	P-7715	P-8321	645
.270 - 17/64"	P-7532	P-7647	P-7609	P-7716	P-8253	P-7610	P-7717	P-8276	—	—	—	P-7611	P-7719	P-8322	615

Flat Spline / "T" Spline on Page 30

RIGID SCREEN SPLINE

**Pcs.
per
Length Ctn.**

RIGID SCREEN SPLINE - Fits Forever & Emco Andersen Brand Doors

80" 25 P-8167

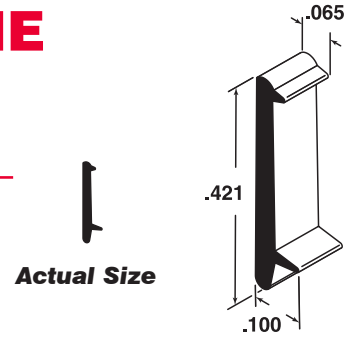

RIGID SCREEN SPLINE - Black

80" 25 P-8479

Call for availability

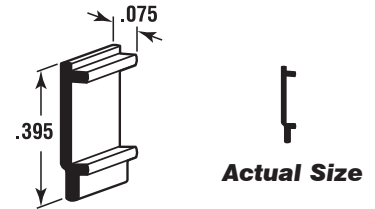

SIZE/ DECIMAL	BULK (1 Reel per Ctn.)	
	500 FT.	1000 FT.
	Black	Black
.120	P-8121	P-8122
.135	P-8469	P-8470
.140	P-8471	P-8472
.145	P-8123	P-8124
.150	P-8473	P-8474
.155	P-8475	P-8476
.160	P-8125	P-8126
.165	P-8465	P-8466
.170	P-8477	P-8478
.175	P-8485	P-8486
.180	P-8127	P-8128
.185	P-8481	P-8482
.190	P-8328*	P-8329*
.195	P-8487	P-8488
.200	P-8129	P-8130
.215	P-8483	P-8484
.225	P-8131	P-8132
.235	P-8467	P-8468
.240	P-8395	P-8396
.250	P-8133	P-8134
.270**	P-8135**	P-8136**

FOAM SCREEN SPLINE

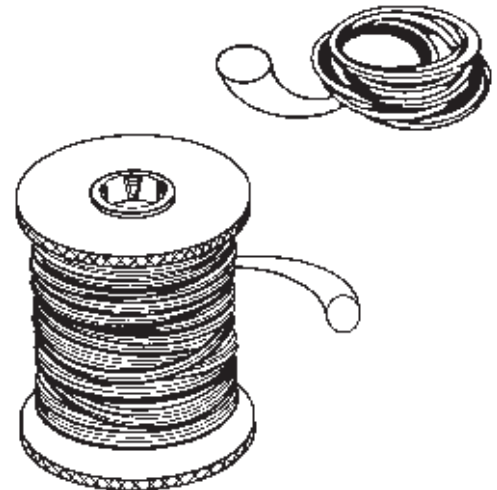

* For 7/8" x 5/16" Extruded Frame
 ** Excellent Substitute for Metal Spline
 Easy to Install

MULTI-SPLINE - 3 SIZES IN ONE

Finish (Part Number)
Length Gray Black





20' P-8163 P-8164

- 3 sizes in one - .120, .145 and .165
- Fits most screens
- Replaces lost or broken spline
- Ideal for aluminum or fiberglass
- Flexible and easy to use

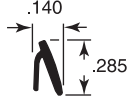

Minimum order; 10 bag Carton

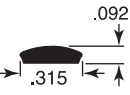
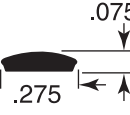
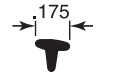
GLASS RETAINER SPLINES

Actual Size	Length (Part Number)					
	25 FT.	100 FT.	200 FT.	500 FT.	1000 FT.	
	GLAZING SPLINE - Gray Vinyl					
	—	P-8198	P-8199	—	P-8200	
	FLAT SCREEN SPLINE - Vinyl					
	Gray	P-8337	P-8085	P-8086	P-8087	P-8088
	Black	P-8338	P-8089	P-8090	P-8091	P-8092
	• Fits Pella Screens					
	Gray	P-8335	P-7839	P-7840	P-7841	P-7842
	Black	P-8336	P-7843	P-7844	P-7845	P-7846
	Brown	—	P-8324	P-8325	P-8326	P-8327
	Black	—	P-8331	P-8332	P-8333	P-8334
	Call for availability					
	" T " SCREEN SPLINE - Black Semi-Rigid Vinyl					
	—	P-7805	P-7806	P-7807	P-7808	
	—	P-8213	P-8214	P-8215	P-8216	
	—	P-8217	P-8218	P-8219	P-8220	

Minimum order; 1 carton

Glass Thickness:
 Single - .085 to .101
 Double - .115 to .134

Note: .100 thick plexiglass
 can be .085 to .090 thick.

GLASS RETAINER SPLINES

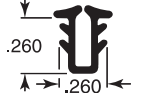
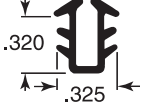
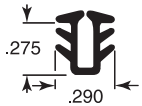
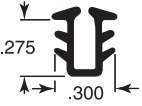
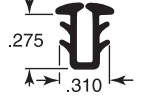
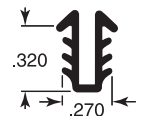
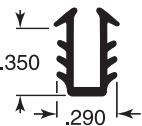
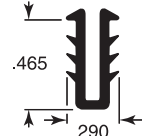
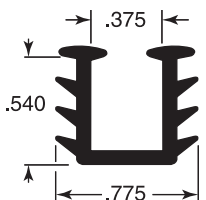
Glass Thickness	Length (Part Number)				Actual Size
	20 FT.	100 FT.	200 FT.	Bulk	
GLAZING CHANNEL - Gray Vinyl					
Single	P-7616	P-7620	P-7831	P-7835 (1000 Ft.)	
Double	—	P-8410	—	—	
GLAZING CHANNEL - Black Vinyl					
Single	—	P-7621	P-7832	P-7836 (750 Ft.)	
Double	—	P-7622	P-7833	P-7837 (750 Ft.)	
Double	—	P-7623	P-7834	P-7838 (750 Ft.)	
Double	—	P-8462	P-8463	P-8464 (800 Ft.)	
Double	—	P-8416	—	—	
Single	—	P-7752	P-7753	P-7754 (800 Ft.)	
3/8" Plate	—	P-8413	—	—	

Minimum order; 1 carton

Glass Thickness:
 Single - .085 to .101
 Double - .115 to .134

Note: .100 thick plexiglass
 can be .085 to .090 thick.

GLASS RETAINER SPLINES

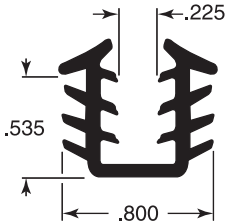
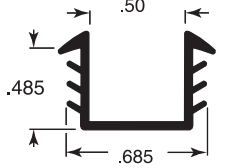
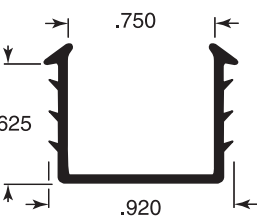
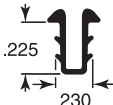
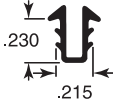
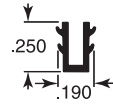
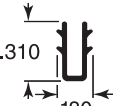
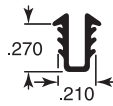
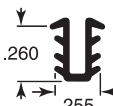
Actual Size	Glass Thickness	Length (Part Number)		
		100 FT.	200 FT.	Bulk
		GLAZING CHANNEL - Black Vinyl		
	1/4" Plate	P-8414	—	—
		GLAZING CHANNEL - Black Vinyl		
	Dual Glazed 1/2"	P-8417	P-8418	P-8419 (500 FT.)
		GLAZING CHANNEL - Black Vinyl		
	Dual Glazed 3/4"	P-8409	—	—
		GLAZING CHANNEL - Gray Vinyl		
	Single	P-7731	P-7732	P-7733 (1000 Ft.)
		GLAZING CHANNEL - Gray Vinyl		
	Single	P-7734	P-7735	P-7736 (1000 Ft.)
		GLAZING CHANNEL - Gray Vinyl		
	Single	P-7728	P-7729	P-7730 (1000 Ft.)
		GLAZING CHANNEL - Gray Vinyl		
	Single	P-7737	P-7738	P-7739 (1000 Ft.)
		GLAZING CHANNEL - Gray Vinyl		
	Single	P-8112	P-8113	P-8114 (1000 Ft.)
		GLAZING CHANNEL - Gray Vinyl		
	Single	P-7749	P-7750	P-7751 (800 Ft.)

Minimum order; 1 carton

Glass Thickness:
 Single - .085 to .101
 Double - .115 to .134

Note: .100 thick plexiglass
 can be .085 to .090 thick.

GLASS RETAINER SPLINES

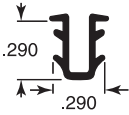
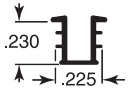
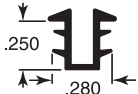
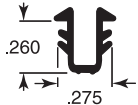
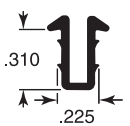
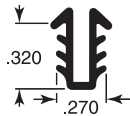
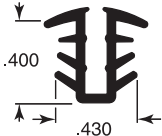

Glass Thickness	Length (Part Number)			Actual Size
	100 FT.	200 FT.	Bulk	
GLAZING CHANNEL - Gray Vinyl				
Single	P-7740	P-7741	P-7742 (800 Ft.)	
Double	P-8171	P-8172	P-8173 (1000 Ft.)	
Double	P-8168	P-8169	P-8170 (1000 Ft.)	
Double	P-7755	P-7756	P-7757 (1000 Ft.)	
Double	P-7743	P-7744	P-7745 (1000 Ft.)	
Double	P-7746	P-7747	P-7748 (800 Ft.)	
Double	P-8174	P-8175	P-8176 (1000 Ft.)	

Minimum order; 1 carton

Glass Thickness:
Single - .085 to .101
Double - .115 to .134

Note: .100 thick plexiglass can be .085 to .090 thick.

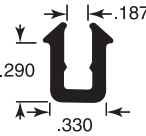
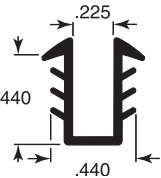
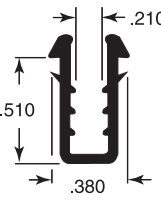
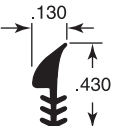
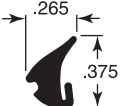
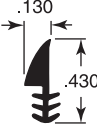
GLASS RETAINER SPLINES

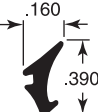
Actual Size	Glass Thickness	Length (Part Number)		
		100 FT.	200 FT.	Bulk
	GLAZING CHANNEL - Gray Vinyl			
	3/16"	P-7758	P-7759	P-7760 (800 Ft.)
	3/16" - 1/4"			
		P-8177	P-8178	P-8179 (1000 Ft.)
	1/4"			
		P-7761	P-7762	P-7763 (800 Ft.)
		Length (Part Number)		
		100 FT.	200 FT.	1000 FT.
	GLAZING SPLINE - Black Vinyl			
		P-7625	P-7858	P-7859
				
		P-8385	P-8386	P-8387
	GLAZING SPLINE - Gray Vinyl			
		P-7794	P-7795	P-7796
				
		P-7770	P-7771	P-7772
				
		P-7773	P-7774	P-7775

Minimum order; 1 carton

GLASS RETAINER SPLINES

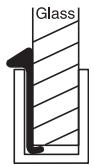

Actual Size

Length (Part Number)

100 FT 200 FT. 1000 FT.

GLAZING SPLINE - Gray Vinyl

P-7767 P-7768 P-7769

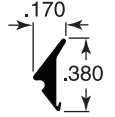

P-7776 P-7777 P-7778

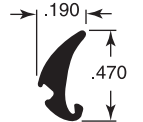

P-7779 P-7780 P-7781

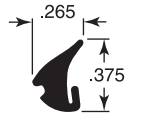

P-7782 P-7783 P-7784

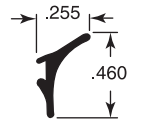

P-7785 P-7786 P-7787

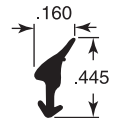

P-7788 P-7789 P-7790

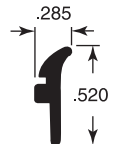

P-7791 P-7792 P-7793

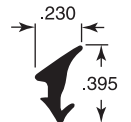

P-7797 P-7798 P-7799



P-7800 P-7801 P-7802

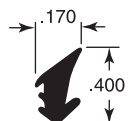

Minimum order; 1 carton

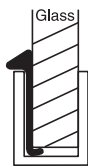

GLASS RETAINER SPLINES

Length (Part Number)

Actual Size

100 FT.

200 FT.

1000 FT.

GLAZING SPLINE - Gray Vinyl

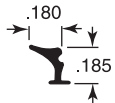

P-8180

P-8181

P-8182

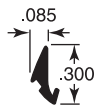

P-8183

P-8184

P-8185

P-8401 (Black)

P-8402 (Black)

P-8403 (Black)

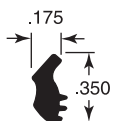

P-8186

P-8187

P-8188

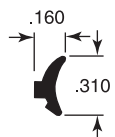

P-8189

P-8190

P-8191

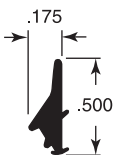

P-8192

P-8193

P-8194

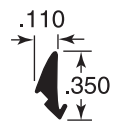

P-8195

P-8196

P-8197

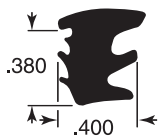

P-8411

—

—

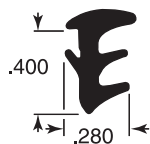

P-8412

—

—

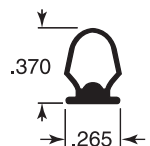

P-8415











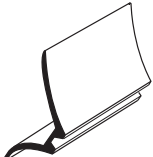

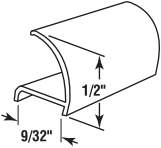



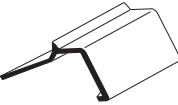

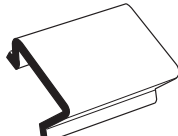

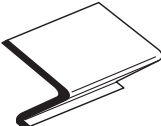
—

—

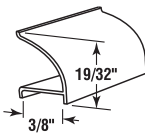

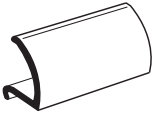

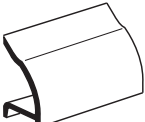





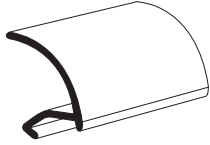

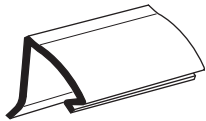

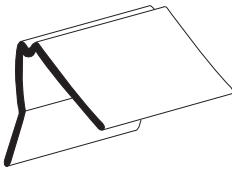
Minimum order; 1 carton

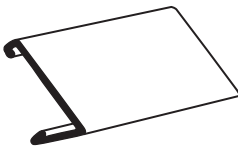
GLASS RETAINERS - RIGID VINYL

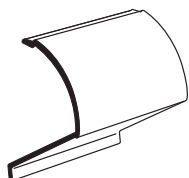
**ORDER
FULL CAR TONS
ONLY**

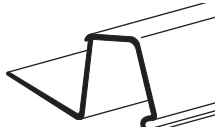

Pcs. per Ctn.	Length	Color (Part Number)					Actual Size	
		Gray	Black	White	Bronze	Brown		
SNAP-IN RIGID VINYL								
25	72"	—	P-7809	P-7860	—	—		
25	72"	P-8047	P-7810	P-7861	—	P-8205		
25	72"	P-8048	P-7811	P-7862	—	—		
25	72"	P-8049	P-7812	P-7863	—	—		
25	72"	P-8050	P-7813	P-7864	—	—		
25	72"	P-8051	P-7814	P-7865	—	—		
25	72"	P-8052	P-7815	P-7866	—	—		
25	72"	P-8053	P-7816	P-7867	—	P-8204		
25	72"	P-7872	—	P-7873	P-7874	—		
25	72"	P-7875	—	P-7876	P-7877	—		

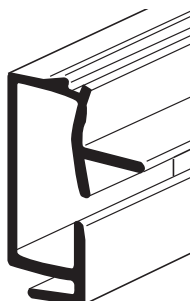
GLASS RETAINERS - RIGID VINYL

Actual Size	Pcs. per Ctn.	Length	Color (Part Number)					
			Gray	Black	White	Brown	Bronze	
SNAP-IN RIGID VINYL								
		25	72"	P-8208	—	P-7851	—	—
		25	72"	P-8210	P-7852	P-7853	—	—
		25	72"	P-8207	P-7854	P-7855	—	—
		25	72"	P-8206	P-7856	P-7857	—	—
		25	72"	P-8203	P-8201	—	—	—
		25	72	—	—	P-8383	—	P-8384
		25	72"	—	—	P-8211	—	—
		25	72	—	—	P-8227	—	—

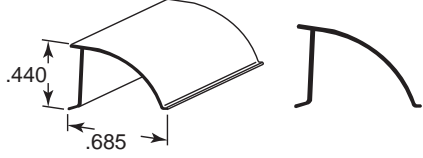
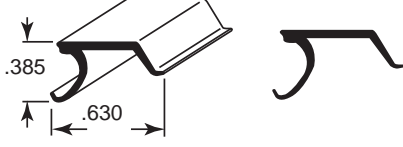
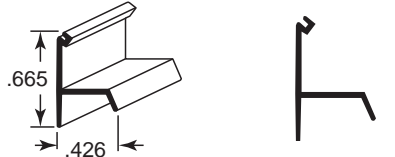
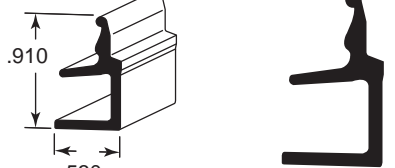
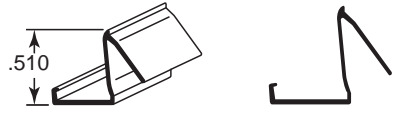
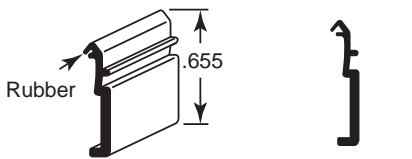
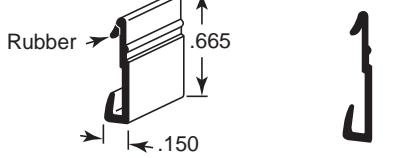
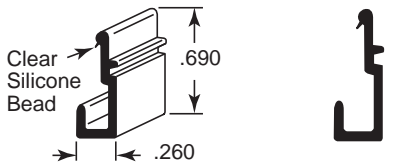

Minimum order; 1 carton

GLASS RETAINERS - RIGID VINYL





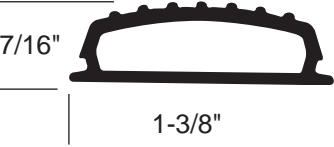

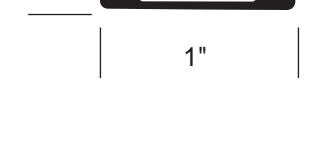
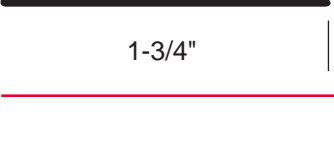
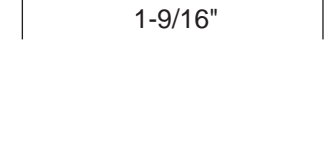



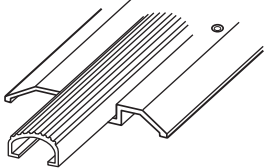
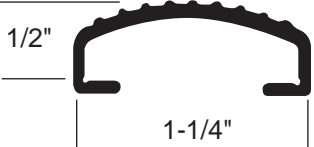
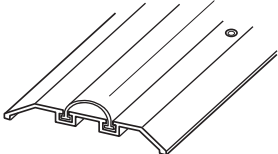

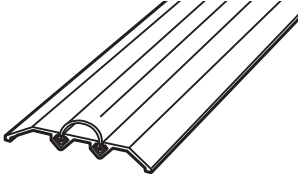
Pcs. per Ctn.	Length	Color (Part Number)					Actual Size
		Gray	Black	White	Brown	Bronze	
SNAP-IN RIGID VINYL							
25	72"	—	—	P-8426	—	P-8425	
25	72"	—	—	P-8427	—	P-8428	
25	72"	P-8429	—	—	—	—	
10	72"	—	—	P-8430	—	—	
25	72"	—	—	P-8431	—	—	
25	72"	—	P-8432	—	—	—	
25	72"	—	—	P-8433	—	—	
25	72"	—	—	P-8434	—	—	
25	72"	—	PL-16463	—	—	—	

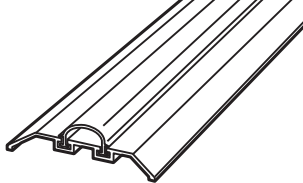
Minimum order; 1 carton

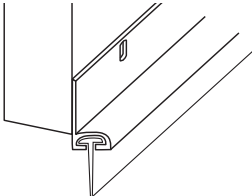

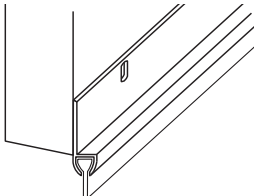
THRESHOLD INSERT

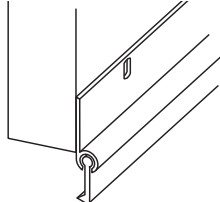
Actual Size	Length	Pcs. per Ctn.	Finish (Part Number)	
			Gray	Black
THRESHOLD INSERT - Snap-in Style				
 <p>3/8" 1-1/4"</p>	37"	6	T-8700	—
	100'	1	P-8353	—
<ul style="list-style-type: none"> • Fits: DPI# 350; MD# 08664, 08672, 13524, 19438647 and 19438654. 				
 <p>7/16" 1-3/8"</p>	37"	6	T-8701	—
	100'	1	P-8354	—
<ul style="list-style-type: none"> • Fits: DPI# 351 				
 <p>1/4" 3/4"</p>	37"	6	T-8702	—
	100'	1	P-8355	—
<ul style="list-style-type: none"> • Fits: DPI# 352 				
 <p>5/16" 7/8"</p>	37"	6	T-8703	—
	100'	1	P-8356	—
<ul style="list-style-type: none"> • Fits: DPI# 354; Frost King# T-35 				
 <p>3/8" 1"</p>	37"	6	T-8704	—
	100'	1	P-8357	—
<ul style="list-style-type: none"> • Fits: DPI# 356; MD# 13417, X and XH styles 				
 <p>1-3/4"</p>	37"	6	T-8707	—
	100'	1	P-8360	—
<ul style="list-style-type: none"> • Fits: DPI# 370; MD# 08383, 08409, 13466; Frost King# T-36 				
THRESHOLD INSERT - Slide-in Style				
 <p>1-9/16"</p>	37"	6	T-8705	—
	100'	1	P-8358	—
<ul style="list-style-type: none"> • Fits: DPI# 360 				

THRESHOLD INSERT

Length	Pcs. per Ctn.	Finish (Part Number)			Actual Size
		Gray	Black		
THRESHOLD INSERT - Slide-in Style					
37"	6	T-8706	—		
100'	1	P-8359	—		
<ul style="list-style-type: none"> • Fits: DPI# 362; MD# 08102, 08029, 08185, 13219. 					
37"	6	T-8708	—		
100'	1	P-8361	—		
<ul style="list-style-type: none"> • Fits: DPI# 372 					
37"	6	T-8709	—		
100'	1	P-8362	—		
<ul style="list-style-type: none"> • Fits: DPI# 374 					
37"	6	T-8710	—		
100'	1	P-8363	—		
<ul style="list-style-type: none"> • Fits: DPI# 376 					
DOOR BOTTOM SWEEP					
37"	10	T-8680	—		
100'	1	P-8371	—		
37"	10	T-8681	—		
100'	1	P-8372	—		
37"	10	T-8713	—		
100'	1	P-8366	—		
<ul style="list-style-type: none"> • Fits: DPI# 910; Larson doors 					

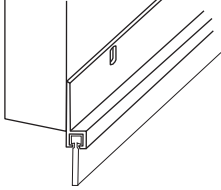
THRESHOLD INSERT

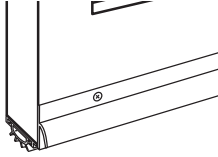
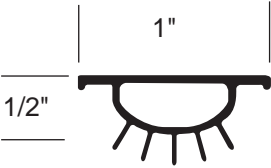
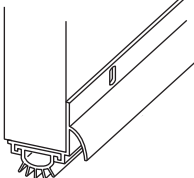
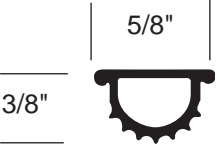
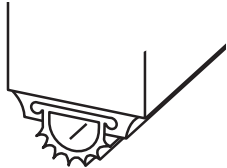
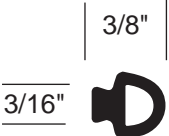
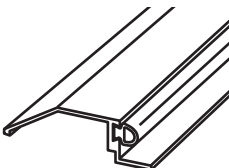
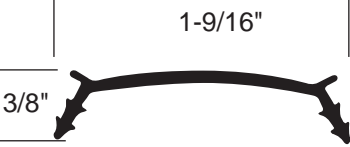
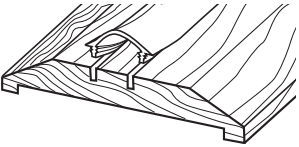
Actual Size	Length	Pcs. per Ctn.	Finish (Part Number)	
			Gray	Black
		DOOR BOTTOM SWEEP		
	37" 100'	6 1	T-8717 P-8370	— —
		DOOR BOTTOM INSERT		
	37" 100'	6 1	T-8712 P-8365	— —
			• Fits: DPI# 380	
		DOOR BOTTOM INSERT		
	37" 100'	6 1	T-8714 P-8367	— —
			• Fits: MD# DB-001, DB-002, DB-003 DB-004; Frost King# U-36	
		DOOR BOTTOM INSERT		
	37" 100'	6 1	T-8716 P-8369	— —
			• Fits: MD# 13318; DPI# 356; Frost King# U-36	
		DOOR BOTTOM INSERT		
	37" 100'	6 1	T-8715 P-8368	— —
			• Fits: MD# 13409	
		WOOD THRESHOLD INSERT		
	37" 100'	6 1	T-8711 P-8364	— —
			• Fits: DPI# 378	

SCREEN DOOR BUG SEAL

UNI-FIT BUG SEAL - Aluminum molding with black vinyl flap

PL-14701	84"	1 /bag	Clear Anodized
PL-14702	96"	1 /bag	Clear Anodized
PL-14703	84"	1 /bag	Black Anodized
PL-14704	96"	1 /bag	Black Anodized
B-801	84"	1 /bag	White Painted
B-802	96"	1 /bag	White Painted

- Deluxe seal with tear strips.
- Pre-punched molding.
- Supplied with screws.
- 5 pieces/carton

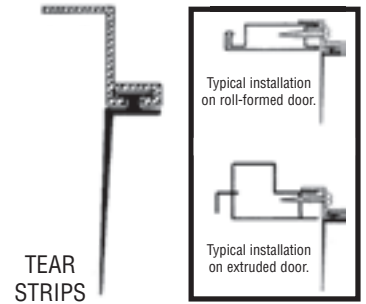

VINYL BUG STRIP - Black vinyl flap with tear strips

B-621	84"	
PL-14697	250 ft. roll	

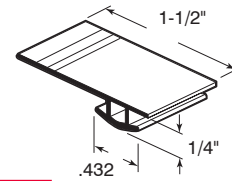

B-660	84"	
PL-16172	100 ft. roll	

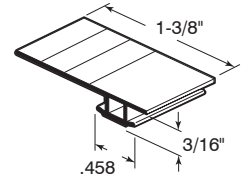

B-708	84"	
PL-16160	100 ft. roll	

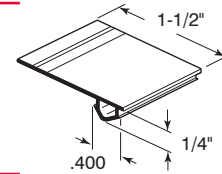

B-771	84"	
PL-16173	100 ft. roll	

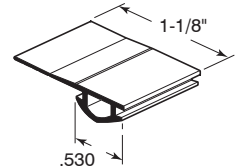

B-705	84"	
PL-16062	96"	
PL-16063	100 ft. roll	

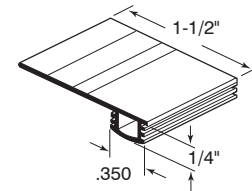

B-716	84"	
--------------	------------	--

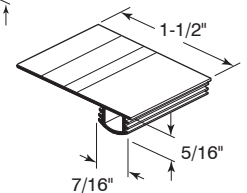

B-791	84"	
PL-16066	96"	

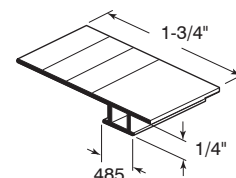

Minimum order; 1 carton

WEATHERSTRIP

Roll Length 20 FT.*

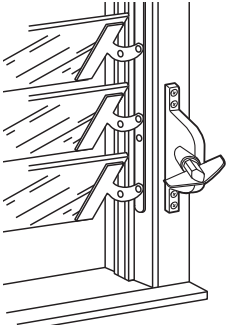

LOUVER STRIP - Clear Vinyl - Fits Over 3/16" Louver Glass

P-7627

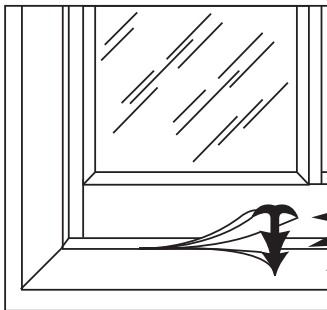

AIR & DUST WINDOW STRIP - Clear Vinyl - Fits Into 1/8" Gap

P-7628 Package contains 10' piece of twin vinyl with tear strip yields 2—10' pieces.

Economic Weatherization Kit

Roll Length (Part Number)

18 FT.* 100 FT. 1000 FT.

PILE WEATHERSTRIP - Gray

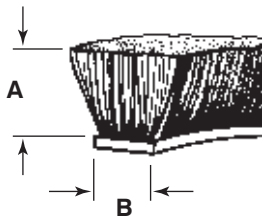

"A" Height	"B" Width	18 FT.*	100 FT.	1000 FT.
.140	3/16"	T-8695	P-7821	P-7822
.150	1/4" (Adhesive Backed)	T-8722	P-8225	P-8226
.156	3/16"	T-8658	P-7823	P-7824
.160	1/4"	T-8659	P-7827	P-7828
.180	1/8"	T-8698	P-8221	P-8222
.180	3/16"	T-8696	P-7825	P-7826
.200	1/4"	T-8697	P-7829	P-7830
.250	3/16" (White)	T-8749	—	—
.300	3/16"	T-8699	P-8223	P-8224
.320	1/4"	T-8741	P-8389	P-8390



To remove worn pile: Using a sharp utility knife, firmly draw the knife down the center of the pile across it's entire length.



Then pull out old pile and debris. Use a screwdriver or scratch awl to pry out old pile if necessary.



To install new pile: Insert one side of the length of pile and use a slot screwdriver to push in the other side

***Minimum order; 1 carton**

GLASS SEALANT

10 fl. oz.
Cartridge

CLEAR SEALANT - Use With Slip-On Frames

P-7868 (12/Ctn.)

- High Performance Sealant.
- For Storm Window & Door Frames.
- Apply Adhesive Into Channel and Slip-On To Glass.
- Use Miter or Square-Cut Corners.
- Lifetime Warranty.

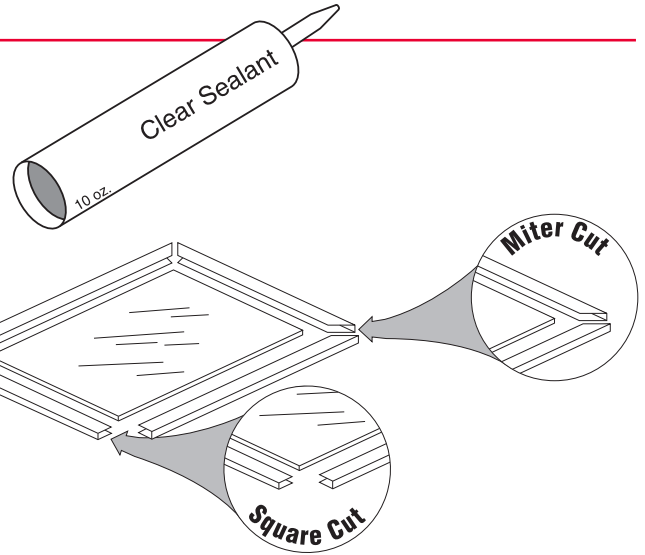

GLAZING ADHESIVE

P-7848 Pint
P-7869 Quart

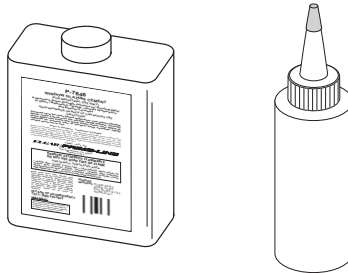

GLAZING ADHESIVE APPLICATION BOTTLE

P-7871

SCREEN ROLLING TOOLS

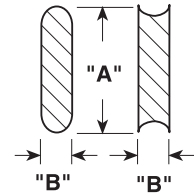

Part No.	Min. Order Qty.	Handle	Wheel	Convex Wheel		Concave Wheel		Spline Size
				"A"	"B"	"A"	"B"	

STANDARD DUTY - Blister Card Pack

P-7503 1 Plastic Nylon 1-5/8" 3/32" 1-5/8" 3/32" .115 - .165



P-7505 1 Wood Steel 1-5/16" 3/32" 1-5/16" 3/32" .115 - .165



P-7506 1 Metal Steel 1-1/4" 3/32" 1-1/4" 3/32" .115 - .165



HEAVY DUTY (Steel Ball Bearing) - Blister Card Pack

P-7508 1 Wood Steel 1-1/2" 3/32" 1-1/2" 1/8" .130 - .180



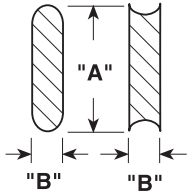

SCREEN ROLLING TOOLS

	Part No.	Min. Order Qty.	Handle	Wheel	Convex Wheel		Concave Wheel		Spline Size
					"A"	"B"	"A"	"B"	
PROFESSIONAL - White Nylon Ball Bearing Wheels									
	P-7880	1	Wood	Nylon	—	—	2"	3/32"	.115 - .145
	P-7881	1	Wood	Nylon	—	—	2"	1/8"	.150 - .180
	P-7882	1	Wood	Nylon	—	—	2"	5/32"	.185 - .215
	P-7883	1	Wood	Nylon	—	—	2"	3/16"	.220 - .260
	P-7884	1	Wood	Nylon	2"	1/16"	—	—	—
P-7885	1	Wood	Nylon	2-1/2"	1/16"	—	—	—	
PROFESSIONAL - White Nylon Ball Bearing Wheels									
	P-7886	1	Wood	Nylon	2"	1/16"	2"	1/8"	.150 - .180
	P-7720	1	Wood	Nylon	2-1/2"	1/16"	2"	1/8"	.150 - .180
	P-8058	1	Wood	Nylon	2-1/2"	1/16"	2"	3/32"	.115 - .165
	P-8435	1	Wood	Nylon	2"	2" Flat	2"	1/8"	.150 - .180
WHITE NYLON BALL BEARING WHEELS - 1 Nylon Wheel, 1 Ball Bearing, 1 Axle Pin									
	P-7990	1	—	Nylon	—	—	2"	3/32"	.115-.145
	P-7991	1	—	Nylon	—	—	2"	1/8"	.150-.180
	P-7992	1	—	Nylon	—	—	2"	5/32"	.185-.215
	P-7993	1	—	Nylon	—	—	2"	3/16"	.220-.260
	P-7994	1	—	Nylon	2"	1/16"	—	—	—
	P-7995	1	—	Nylon	2-1/2"	1/16"	—	—	—
PROFESSIONAL - Steel Ball Bearing Wheels									
	P-7887	1	Wood	Steel	—	—	1-1/2"	3/32"	.115 - .145
	P-7888	1	Wood	Steel	—	—	1-1/2"	1/8"	.150 - .180
	P-7889	1	Wood	Steel	—	—	1-1/2"	5/32"	.185 - .215
	P-7890	1	Wood	Steel	—	—	2"	3/32"	.115 - .145
	P-7891	1	Wood	Steel	—	—	2"	1/8"	.150 - .180
	P-7892	1	Wood	Steel	—	—	2"	5/32"	.185 - .215
	P-7893	1	Wood	Steel	—	—	3"	1/8"	.150 - .180
	P-7894	1	Wood	Steel	2"	1/16"	—	—	—
	P-7895	1	Wood	Steel	2-1/2"	1/16"	—	—	—
	P-7896	1	Wood	Steel	2-1/2"	3/32"	—	—	—
	P-7897	1	Wood	Steel	2-1/2"	1/8"	—	—	—
P-7898	1	Wood	Steel	3"	1/16"	—	—	—	
PROFESSIONAL - Steel Ball Bearing Wheels									
	P-7727	1	Wood	Steel	2"	1/16"	2"	1/8"	.150 - .180
	P-7629	1	Wood	Steel	2-1/2"	1/16"	2"	1/8"	.150 - .180
	P-7900	1	Wood	Steel	3"	1/16"	3"	1/8"	.150 - .180
	P-8059	1	Wood	Steel	2-1/2"	1/16"	2"	3/32"	.115 - .165
	P-7879	1	Wood	Steel	2-1/2"	1/16"	2"	5/32"	.185 - .215
	P-8228	1	Wood	Steel	2"	3/16" Flat	1-1/2"	1/8"	.150 - .180

For Flat Spline

PROFESSIONAL SPECIALTY TOOLS

Part No.	Min. Order Qty.	Handle	Wheel	Wheel Specifications			
				Diameter	Edge Width	Flat Area	Step Drop
STEP TOOL - Steel Ball Bearing Wheels							
P-7909	1	Wood	Steel	2"	1/16"	1/2"	3/16"
For "T" spline							

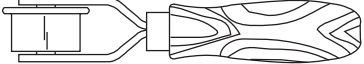

Part No.	Min. Order Qty.	Handle	Wheel	Wheel Specifications	
				Diameter	Width

FLAT ROLLER - Steel Ball Bearing Wheels

P-7908	1	Wood	Steel	2"	2"
--------	---	------	-------	----	----

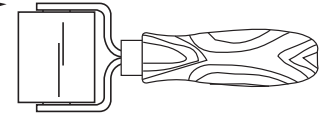

BEVEL ROLLER - Steel Ball Bearing

P-7910	1	Wood	Steel	2-1/4"	1/16"
--------	---	------	-------	--------	-------



COMBINATION CUTTING & ROLLING TOOL - For Fiberglass Screening

P-7911	1	Wood	Nylon*	2"	3/32" Concave
P-7912	1	Wood	Nylon*	2"	1/8" Concave
P-7913	1	Wood	Steel*	2"	3/32" Concave
P-7914	1	Wood	Steel*	2"	1/8" Concave

* Ball Bearing Wheels



COMBINATION SHEAR & ROLLING TOOL - Steel Ball Bearing Wheels

P-7915	5	—	Steel	2-1/2"	1/16" Convex
--------	---	---	-------	--------	--------------

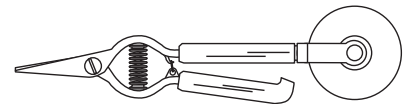

SCREEN FRAME NOTCHING JIG - 1 per Box

- P-7916
- Allows frame to be securely held while being notched.
 - Notched frame allows application of slide locks, tension springs and knife latches.
 - Notching tool included.

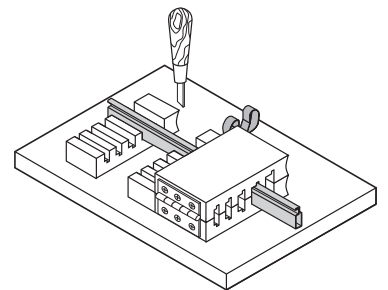

SCREEN FRAME NOTCHING TOOL - 1 per Pkg.

- P-7920
- Notches frame for slide locks, tension springs and knife latches.

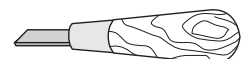

PROFESSIONAL SPECIALTY TOOLS

Part No.	Min. Order Qty.	Handle	Wheel	Wheel Specifications	
				Diameter	Width

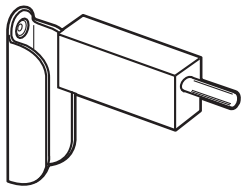

NAIL SET - 1 per Pkg. (6/Box)

P-7921*

- Cadmium plated steel.
- For installing top hangers.
- Drives nail into jamb.

* Use to install top hangers on pages 101-102.

1. Insert nail into tool.

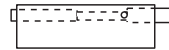

Nail Set

2. Attach Jiffy Hanger.

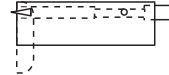

Retract

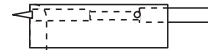

Hit with Hammer

3. Locate in upper corner of window jamb and set nail.



STEP DRILL - 1 per Pkg. (10/Box)

P-7922

- Used to easily drill correct hole sizes for installation of plunger latches.

SCREEN TABLE JIG - 1 Set per Pkg.

P-7924 - 5 bar set includes:

- 2 bars drilled for attachment to table.
- 3 free moving bars.
- 12 aluminum screen frame clips (for 3/4" frame).
- With screws and installation instructions.

- Allows the screen frame to be held firmly & squarely in place while installing screen fabric.

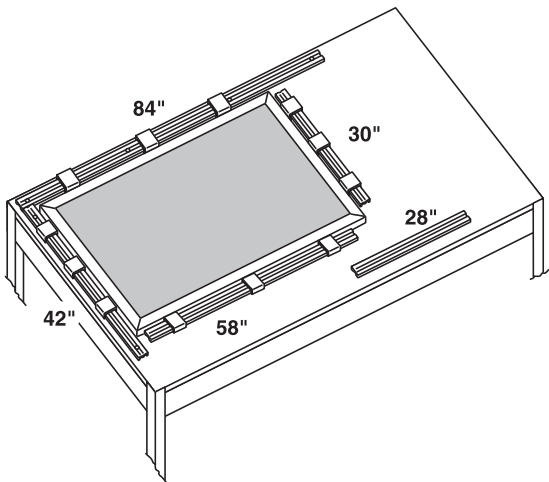

SCREEN JIG CLIPS - 4 per Pkg.

P-7932

3/4" jig clips

P-7933

1" jig clips

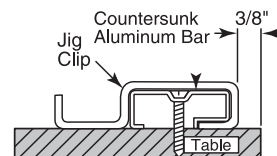

PROFESSIONAL SPECIALTY TOOLS

DELUXE SCREEN SHEARS - 10" Blades (1 per Pkg.)

P-8062

- Moly steel edge, resists abrasion.
- Offers easier cutting action.
- Use for fiberglass or aluminum screen.

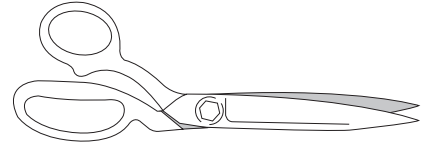

SEMI-HIGH SPEED STEEL SAW BLADES - 10" Aluminum Cutting Blades

P-7929 (200 Teeth) - 1 per pkg.

P-7930 (250 Teeth) - 1 per pkg.

- Carbon tool steel
- For use on bench, radial arm and chop saws.
- Type "A" teeth.
- Used for cutting screen and window frame.

1/16" Thick
5/8" Arbor

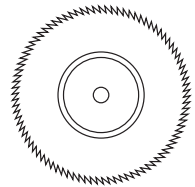

SAW WAX - 1 per Pkg.

P-7931

- Lubricant for chop saw blades.
- Allows for smoother saw cut and eliminates burring.
- Adds life to saw blades.



SCREEN WARNING LABEL - 100 per Pkg.

P-8081

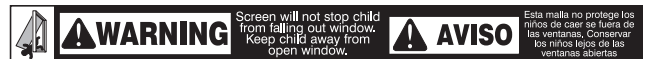

STORM WINDOW TOOLS

P-8420 (Zinc)

- Corner key crimp tool

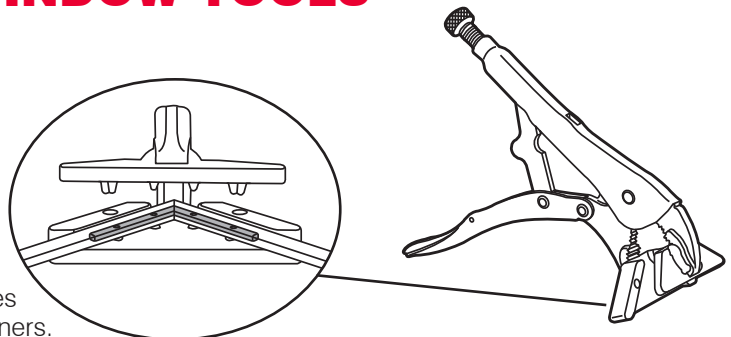

Spikes align with dimples to crimp frame onto corners.

PLASTIC WICKETS

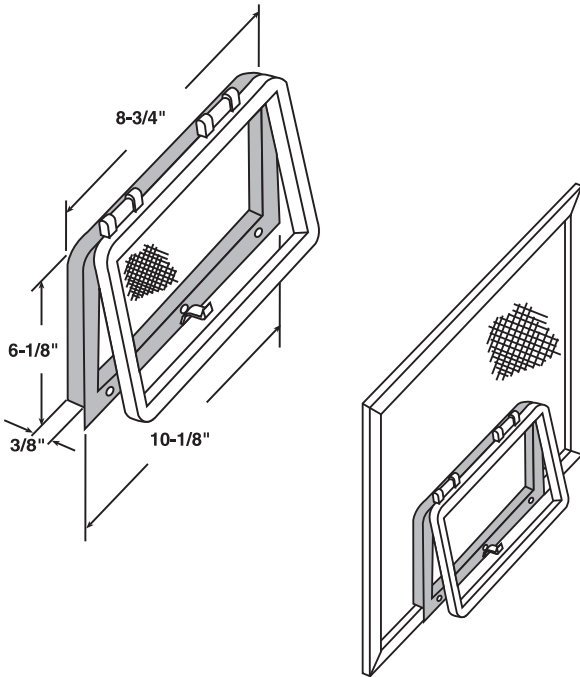

- Allows access to awning or casement window operators.
- Available in three colors: Gray, Bronze and White.
- Use either aluminum or fiberglass screen mesh to match the existing mesh in window screen.
- Requires a 12" minimum window screen width.
- Includes .175 black spline.
- Individually packaged, 10/Cartron.

Part Number	Color
PL-14698	Gray
PL-14699	Bronze
PL-14700	White
PL-14695	Black

FIBERGLASS SCREEN CLOTH

- 18 x 16 mesh x 100 foot rolls.
- Gray & charcoal colors.
- 17 widths available.
- Offers ease of installation and long term durability.

Also Available

Pet Screen Cloth (100 ft. rolls)

- PL-16036 - 36" Gray
- PL-15964 - 36" Charcoal
- PL-16037 - 48" Gray
- PL-15965 - 48" Charcoal

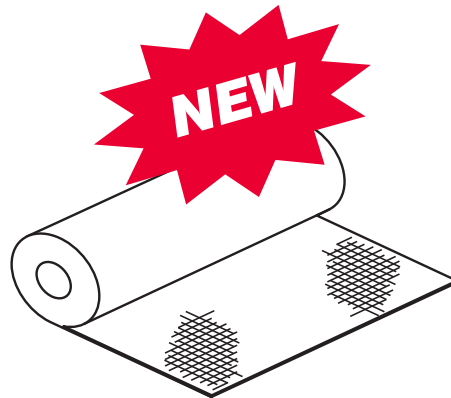

Width	Part Number	
	Gray	Charcoal
18"	PL-15800	PL-15820
20"	PL-15801	PL-15821
22"	PL-15802	PL-15822
24"	PL-15803	PL-15823
26"	PL-15804	PL-15824
28"	PL-15805	PL-15825
30"	PL-15806	PL-15826
32"	PL-15807	PL-15827
34"	PL-15808	PL-15828
36"	PL-15809	PL-15829
38"	PL-15810	PL-15830
40"	PL-15811	PL-15831
42"	PL-15812	PL-15832
48"	PL-15813	PL-15833
54"	PL-15814	PL-15834
60"	PL-15815	PL-15835
72"	PL-15816	PL-15836

RE-SCREENING KITS

**ORDER
FULL CAR TONS
ONLY**

- 2 Sizes of Charcoal Fiberglass screen cloth.
- Sufficient amount to re-screen 2 window screens or 1 screen door.
- Attractively packaged in self-displaying bag.

FIBERGLASS SCREEN CLOTH

- P-7510 **36" x 84"** (10 Bags per pack)
 P-7540 **48" x 84"** (10 Bags per pack)



FIBERGLASS SCREEN CLOTH KIT

- | | | | |
|--------|--|--------|---------------------------------------|
| P-7511 | 36" x 84" * (10 Bags per pack) | P-8069 | 36" x 84" * (30 Bags per box) |
| P-7541 | 48" x 84" * (10 Bags per pack) | P-8070 | 48" x 84" * (30 Bags per box) |
| P-7515 | 36" x 84" ** (10 Bags per pack) | P-8071 | 36" x 84" ** (30 Bags per box) |
| P-7542 | 48" x 84" ** (10 Bags per pack) | P-8072 | 48" x 84" ** (30 Bags per box) |

* Includes: 30' of **.180 black vinyl spline** & a combination screen rolling tool (P-7503)

** Includes: 30' of **.155 black vinyl spline** & a combination screen rolling tool (P-7503)



ALUMINUM & FIBERGLASS SCREEN REPAIR PATCHES

- P-7548 **3" x 3"** (5 per bag / 25 bags per pack - Aluminum Finish)
 P-8098 **3" x 3"** (5 per card / 10 cards per pack - Aluminum Material, Aluminum Finish)
 P-7549 **3" x 3"** (5 per card / 10 cards per pack - Aluminum Material, Charcoal Finish)
 P-8095 **3" x 3"** (5 per card / 10 cards per pack - Self-Stick Fiberglass Material, Gray Finish)
 P-8096 **3" x 3"** (5 per card / 10 cards per pack - Self-Stick Fiberglass Material, Charcoal Finish)

**ORDER
FULL CAR TONS
ONLY**

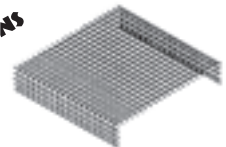

Aluminum

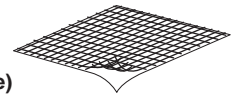

Fiberglass
(Self Adhesive)

RETAIL MERCHANDISERS - CLIP STRIPS

- SCP-7503 Rolling tool (20 per clipstrip)
 SCP-7505 Rolling tool (20 per clipstrip)
 SCP-8095 **3" x 3"** Patch (20 per clipstrip - Gray Fiberglass)
 SCP-8096 **3" x 3"** Patch (20 per clipstrip - Charcoal Fiberglass)
 SCP-8098 **3" x 3"** Patch (20 per clipstrip - Aluminum Finish)
 SCP-7549 **3" x 3"** Patch (20 per clipstrip - Charcoal Aluminum Finish)

SCP-8095
SCP-8096

SCP-7503
SCP-7505



SCP-7549
SCP-8098

Ideal impulse sales item
High volume, high profit categories
Attractive packaging that sells

HELPFUL HINTS FOR REPAIRING / REPLACING Corner & Tilt Keys • Slide Bolts

CORNER AND TILT KEYS

1. Removal of corners or tilt keys requires drilling out indentations holding corners into frame. Using a 3/32" drill bit, drill out indentation only. Do not drill all the way through corner (See Photo 1).
2. Secure window frame to work bench and lightly tap frame apart using a block of wood and hammer (See Photo 2).
3. Remove broken corners using a screwdriver or similar tool, drive broken piece out, or back into frame (if piece will not come out).
4. Select proper replacement corner or tilt key and insert into frame and re-assemble.
5. Using a nail set indent frame into corner key. Indent in two places on each leg of key (See Photo 3).

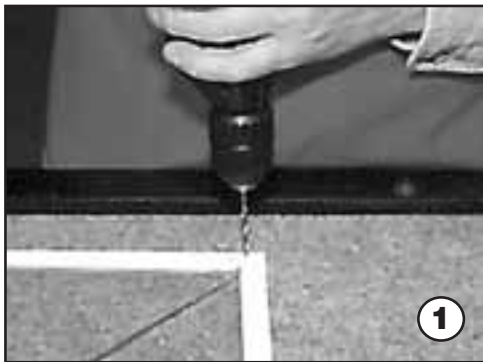

SLIDE BOLTS

1. Remove bottom frame, using the same procedure as Step 1 and 2 above.
2. Slide bolt and spring will slide out when corner key is removed.
3. Select proper slide bolt, insert spring and slide bolt into frame (See Photo 4).
4. Assemble frame and using a nail set indent frame into corner key (See Photo 3).

PARTS KITS

PL-7991 STORM DOOR PANEL ACCESSORIES

• 25 of Each Item (In Bulk)

Part No.	Description
PL-14634	Turn Button (Nylon)
PL-14750	Panel Clip (Mill)
PL-14753	Panel Clip (White)
PL-14756	Panel Clip (Mill)
PL-14759	Panel Clip (White)
PL-14762	Thumbscrew (Mill)
PL-14765	Thumbscrew (White)
PL-14768	Thumbscrew (Mill)
PL-14771	Thumbscrew (White)
PL-14774	Panel Clip (Mill)
PL-14777	Panel Clip (White)
PL-14780	Panel Clip (Mill)
PL-14783	Panel Clip (White)
PL-14786	Panel Clip (Mill)
PL-14789	Panel Clip (White)
PL-14792	Panel Clip (Mill)
PL-14795	Panel Clip (White)
PL-14798	Panel Clip (Mill)
PL-14804	Panel Clip (Mill)
PL-14810	Panel Clip (Mill)
PL-14816	Panel Clip (Mill)
PL-14819	Panel Clip (Mill)
PL-14828	Panel Clip (Mill)
PL-14840	Turn Button (Mill)
PL-14859	Jet Clip
PL-14861	Insert Clip
PL-14863	Insert Clip
PL-14865	Insert Clip
PL-14867	Insert Clip
PL-14869	Insert Clip
PL-14871	Insert Clip
PL-14875	Insert Clip



- 35 Drawer Storage Bin
- Labels Included
- Stackable Cabinets
- See Pages 57 thru 109 for Bulk Product

PL-7992 CORNER & TILT KEY ACCESSORIES

• 20 of Each Item (In Bulk)

Part No.	Handing	Description
PL-14950	—	Corner Key (Nylon)
PL-14952	—	Corner Key (Nylon)
PL-14954	—	Corner Key (Nylon)
PL-14956	—	Corner Key (Nylon)
PL-14958	—	Corner Key (Nylon)
PL-14960	Left	Corner Key (Nylon)
PL-14962	Right	Corner Key (Nylon)
PL-14964	—	Corner Key (Nylon)
PL-14966	—	Corner Key (Nylon)
PL-14968	Left	Corner Key (Nylon)
PL-14970	Right	Corner Key (Nylon)
PL-14972	—	Corner Key (Nylon)
PL-14974	—	Corner Key (Nylon)
PL-14976	—	Corner Key (Nylon)
PL-14978	—	Corner Key (Nylon)
PL-14980	—	Corner Key (Nylon)
PL-15130	—	Tilt Key (Nylon)
PL-15132	—	Tilt Key (Nylon)
PL-15134	—	Tilt Key (Nylon)
PL-15136	—	Tilt Key (Nylon)
PL-15138	—	Tilt Key (Nylon)
PL-15140	Left	Tilt Key (Nylon)
PL-15142	Right	Tilt Key (Nylon)
PL-15144	—	Tilt Key (Nylon)
PL-15146	Left	Tilt Key (Nylon)
PL-15148	Right	Tilt Key (Nylon)
PL-15150	—	Tilt Key (Nylon)
PL-15152	—	Tilt Key (Nylon)
PL-15154	—	Tilt Key (Nylon)
PL-15164	—	Tilt Key (Nylon)
PL-15166	—	Tilt Key (Nylon)
PL-15168	Left	Tilt Key (Nylon)
PL-15170	Right	Tilt Key (Nylon)
PL-15172	—	Tilt Key (Nylon)
PL-15176	—	Tilt Key (Nylon)

PL-7993 CORNER & TILT KEY ACCESSORIES

• 20 of Each Item (In Bulk)

Part No.	Handing	Description
PL-15030	—	Corner Key (Metal)
PL-15032	Left	Corner Key (Metal)
PL-15034	Right	Corner Key (Metal)
PL-15036	—	Corner Key (Metal)
PL-15038	—	Corner Key (Metal)
PL-15040	—	Corner Key (Metal)
PL-15042	—	Corner Key (Metal)
PL-15052	—	Corner Key (Metal)
PL-15062	—	Corner Key (Metal)
PL-15064	—	Corner Key (Metal)
PL-15078	Right	Corner Key (Metal)
PL-15080	Left	Corner Key (Metal)
PL-15096	—	Corner Key (Metal)
PL-15212	Left	Tilt Key (Metal)
PL-15214	Right	Tilt Key (Metal)
PL-15216	—	Tilt Key (Metal)
PL-15218	Left	Tilt Key (Metal)
PL-15220	Right	Tilt Key (Metal)
PL-15222	—	Tilt Key (Metal)
PL-15224	—	Tilt Key (Metal)
PL-15226	—	Tilt Key (Metal)
PL-15228	—	Tilt Key (Metal)
PL-15230	Left	Tilt Key (Metal)
PL-15232	Right	Tilt Key (Metal)
PL-15234	Left	Tilt Key (Metal)
PL-15236	Right	Tilt Key (Metal)
PL-15238	Left	Tilt Key (Metal)
PL-15240	Right	Tilt Key (Metal)
PL-15242	—	Tilt Key (Metal)
PL-15248	Right	Tilt Key (Metal)
PL-15250	Left	Tilt Key (Metal)
PL-15252	—	Tilt Key (Metal)

PL-7994 CORNER KEY & SLIDE BOLT ACCESSORIES

Part No.	Handing	Description	Qty.
PL-14889	—	Slide Bolt Spring	20
PL-14893	—	Slide Bolt Spring	20
PL-14897	—	Slide Bolt Spring	20
PL-15044	Right	Corner Key (Metal)	10
PL-15046	Left	Corner Key (Metal)	10
PL-15048	Left	Corner Key (Metal)	10
PL-15050	Right	Corner Key (Metal)	10
PL-15054	Left	Corner Key (Metal)	10
PL-15056	Right	Corner Key (Metal)	10
PL-15058	Left	Corner Key (Metal)	10
PL-15060	Right	Corner Key (Metal)	10
PL-15070	Right	Corner Key (Metal)	10
PL-15072	Left	Corner Key (Metal)	10
PL-15086	Right	Corner Key (Metal)	10
PL-15088	Left	Corner Key (Metal)	10
PL-15300	Left	Slide Bolt (Nylon)	10
PL-15302	Right	Slide Bolt (Nylon)	10
PL-15304	Left	Slide Bolt (Nylon)	10
PL-15306	Right	Slide Bolt (Nylon)	10
PL-15388	Left	Slide Bolt (Metal)	10
PL-15390	Right	Slide Bolt (Metal)	10
PL-15396	Left	Slide Bolt (Metal)	10
PL-15398	Right	Slide Bolt (Metal)	10
PL-15400	Left	Slide Bolt (Metal)	10
PL-15402	Right	Slide Bolt (Metal)	10
PL-15404	Left	Slide Bolt (Metal)	10
PL-15406	Right	Slide Bolt (Metal)	10
PL-15412	Left	Slide Bolt (Metal)	10
PL-15414	Right	Slide Bolt (Metal)	10
PL-15428	Left	Slide Bolt (Metal)	10
PL-15430	Right	Slide Bolt (Metal)	10
PL-15444	Left	Slide Bolt (Metal)	10
PL-15446	Right	Slide Bolt (Metal)	10
PL-15488	Left	Slide Bolt (Metal)	10
PL-15490	Right	Slide Bolt (Metal)	10

PARTS KITS



- 35 Drawer Storage Bin
- Labels Included
- Stackable Cabinets
- See Pages 57 thru 103 for Bulk Product

PL-7995 CORNER & TILT KEY, SLIDE BOLT ACCESSORIES

Part No.	Handing	Description	Qty.
PL-15074	Right	Corner Key (Metal)	20
PL-15076	Left	Corner Key (Metal)	20
PL-15082	Right	Corner Key (Metal)	20
PL-15084	Left	Corner Key (Metal)	20
PL-16085	Left	Tilt Key (Nylon)	20
PL-16087	Right	Tilt Key (Nylon)	20
PL-15158	—	Tilt Key (Nylon)	20
PL-15176	—	Tilt Key (Nylon)	20
PL-15244	—	Tilt Key (Metal)	20
PL-15254	Right	Tilt Key (Metal)	20
PL-15256	Left	Tilt Key (Metal)	20
PL-15260	Right	Tilt Key (Metal)	20
PL-15262	Left	Tilt Key (Metal)	20
PL-15440	Left	Slide Bolt (Metal)	20
PL-15442	Right	Slide Bolt (Metal)	20
PL-15444	Left	Slide Bolt (Metal)	20
PL-15446	Right	Slide Bolt (Metal)	20
PL-15448	Left	Slide Bolt (Metal)	20
PL-15450	Right	Slide Bolt (Metal)	20
PL-15452	Left	Slide Bolt (Metal)	20
PL-15454	Right	Slide Bolt (Metal)	20
PL-15460	Left	Slide Bolt (Metal)	20
PL-15462	Right	Slide Bolt (Metal)	20
PL-15464	Left	Slide Bolt (Metal)	20
PL-15466	Right	Slide Bolt (Metal)	20
PL-15476	Left	Slide Bolt (Metal)	20
PL-15478	Right	Slide Bolt (Metal)	20
PL-15480	Left	Slide Bolt (Metal)	20
PL-15482	Right	Slide Bolt (Metal)	20
PL-15484	Left	Slide Bolt (Metal)	10
PL-15486	Right	Slide Bolt (Metal)	10
PL-15488	Left	Slide Bolt (Metal)	10
PL-15490	Right	Slide Bolt (Metal)	10

PL-7996 SLIDE BOLT ACCESSORIES

Part No.	Handing	Description	Qty.
PL-15308	Left	Slide Bolt (Nylon)	10
PL-15310	Right	Slide Bolt (Nylon)	10
PL-15312	—	Slide Bolt (Nylon)	10
PL-15314	Left	Slide Bolt (Nylon)	20
PL-15316	Right	Slide Bolt (Nylon)	20
PL-15318	Left	Slide Bolt (Nylon)	20
PL-15320	Right	Slide Bolt (Nylon)	20
PL-15322	Left	Slide Bolt (Nylon)	10
PL-15324	Right	Slide Bolt (Nylon)	10
PL-15326	Left	Slide Bolt (Nylon)	20
PL-15328	Right	Slide Bolt (Nylon)	20
PL-15330	Left	Slide Bolt (Nylon)	20
PL-15332	Right	Slide Bolt (Nylon)	20
PL-15334	Left	Slide Bolt (Nylon)	20
PL-15336	Right	Slide Bolt (Nylon)	20
PL-15338	Left	Slide Bolt (Nylon)	10
PL-15340	Right	Slide Bolt (Nylon)	10
PL-15342	Left	Slide Bolt (Nylon)	20
PL-15344	Right	Slide Bolt (Nylon)	20
PL-15346	—	Slide Bolt (Nylon)	20
PL-15348	Left	Slide Bolt (Nylon)	10
PL-15350	Right	Slide Bolt (Nylon)	10
PL-15352	Left	Slide Bolt (Nylon)	20
PL-15354	Right	Slide Bolt (Nylon)	20
PL-15356	Left	Slide Bolt (Nylon)	20
PL-15358	Right	Slide Bolt (Nylon)	20

PL-8123 CORNER, TILT KEY & SLIDE BOLT ACCESSORIES

Part No.	Handing	Description	Qty.
PL-14621	—	Plunger Latch (Nylon)	25
PL-14861	—	Insert Clip (Steel)	25
PL-14863	—	Insert Clip (Steel)	25
PL-14865	—	Insert Clip (Steel)	25
PL-14867	—	Insert Clip (Steel)	25
PL-14869	—	Insert Clip (Steel)	25
PL-14950	—	Corner Key (Nylon)	20
PL-14952	—	Corner Key (Nylon)	20
PL-14954	—	Corner Key (Nylon)	20
PL-14956	—	Corner Key (Nylon)	20
PL-14958	—	Corner Key (Nylon)	20
PL-14960	Left	Corner Key (Nylon)	20
PL-14962	Right	Corner Key (Nylon)	20
PL-14964	—	Corner Key (Nylon)	20
PL-14966	—	Corner Key (Nylon)	20
PL-14968	Left	Corner Key (Nylon)	20
PL-14970	Right	Corner Key (Nylon)	20
PL-15030	—	Corner Key (Diecast)	20
PL-15130	—	Tilt Key (Nylon)	20
PL-15132	—	Tilt Key (Nylon)	20
PL-15134	—	Tilt Key (Nylon)	20
PL-15136	—	Tilt Key (Nylon)	20
PL-15138	—	Tilt Key (Nylon)	20
PL-15140	Left	Tilt Key (Nylon)	20
PL-15142	Right	Tilt Key (Nylon)	20
PL-15144	—	Tilt Key (Nylon)	20
PL-15146	Left	Tilt Key (Nylon)	20
PL-15148	Right	Tilt Key (Nylon)	20
PL-15150	—	Tilt Key (Nylon)	20
PL-15176	—	Tilt Key (Nylon)	20
PL-15304	Left	Slide Bolt (Nylon)	20
PL-15306	Right	Slide Bolt (Nylon)	20
PL-15308	Left	Slide Bolt (Nylon)	20
PL-15310	Right	Slide Bolt (Nylon)	20
PL-15314	Left	Slide Bolt (Nylon)	20
PL-15316	Right	Slide Bolt (Nylon)	20
PL-15318	Left	Slide Bolt (Nylon)	20
PL-15320	Right	Slide Bolt (Nylon)	20
PL-15322	Left	Slide Bolt (Nylon)	20
PL-15324	Right	Slide Bolt (Nylon)	20
PL-15360	Left	Slide Bolt (Nylon)	20
PL-15362	Right	Slide Bolt (Nylon)	20
PL-15410	—	Slide Bolt (Diecast)	20
PL-15424	Left	Slide Bolt (Diecast)	20
PL-15426	Right	Slide Bolt (Diecast)	20

PARTS KITS

- 35 Drawer Storage Bin
- Labels Included
- Stackable Cabinets
- See Pages 57 thru 91 for Bulk Product

PL-8126 CORNER, TILT KEY & SLIDE BOLT ACCESSORIES

- 20 of Each Item (In Bulk)

Part No.	Handing	Description
PL-14978	—	Corner Key (Nylon)
PL-15052	—	Corner Key (Diecast)
PL-15054	Left	Corner Key (Diecast)
PL-15056	Right	Corner Key (Diecast)
PL-15058	Left	Corner Key (Diecast)
PL-15060	Right	Corner Key (Diecast)
PL-15062	—	Corner Key (Diecast)
PL-15064	—	Corner Key (Diecast)
PL-15158	—	Tilt Key (Nylon)
PL-15164	—	Tilt Key (Nylon)
PL-15228	—	Tilt Key (Diecast)
PL-15230	Left	Tilt Key (Diecast)
PL-15232	Right	Tilt Key (Diecast)
PL-15234	Left	Tilt Key (Diecast)
PL-15236	Right	Tilt Key (Diecast)
PL-15238	Left	Tilt Key (Diecast)
PL-15240	Right	Tilt Key (Diecast)
PL-15242	Left	Tilt Key (Diecast)
PL-15412	Left	Slide Bolt (Diecast)
PL-15414	Right	Slide Bolt (Diecast)
PL-15416	Left	Slide Bolt (Diecast)
PL-15418	Right	Slide Bolt (Diecast)
PL-16085	Left	Tilt Key (Nylon)
PL-16087	Right	Tilt Key (Nylon)

PL-8127 CORNER, TILT KEY & SLIDE BOLT ACCESSORIES

- 20 of Each Item (In Bulk)

Part No.	Handing	Description
PL-15032	Left	Corner Key (Diecast)
PL-15034	Right	Corner Key (Diecast)
PL-15036	—	Corner Key (Diecast)
PL-15038	—	Corner Key (Diecast)
PL-15040	—	Corner Key (Diecast)
PL-15042	—	Corner Key (Diecast)
PL-15044	Right	Corner Key (Diecast)
PL-15046	Left	Corner Key (Diecast)
PL-15048	Left	Corner Key (Diecast)
PL-15050	Right	Corner Key (Diecast)
PL-15212	Left	Tilt Key (Diecast)
PL-15214	Right	Tilt Key (Diecast)
PL-15216	—	Tilt Key (Diecast)
PL-15218	Left	Tilt Key (Diecast)
PL-15220	Right	Tilt Key (Diecast)
PL-15222	—	Tilt Key (Diecast)
PL-15224	—	Tilt Key (Diecast)
PL-15226	—	Tilt Key (Diecast)
PL-15400	Left	Slide Bolt (Diecast)
PL-15402	Right	Slide Bolt (Diecast)
PL-15404	Left	Slide Bolt (Diecast)
PL-15406	Right	Slide Bolt (Diecast)
PL-15408	—	Slide Bolt (Diecast)
PL-15410	—	Slide Bolt (Diecast)

PL-8128 CORNER, TILT KEY & SLIDE BOLT ACCESSORIES

- 20 of Each Item (In Bulk)

Part No.	Handing	Description
PL-14972	—	Corner Key (Nylon)
PL-14974	—	Corner Key (Nylon)
PL-14976	—	Corner Key (Nylon)
PL-14980	—	Corner Key (Nylon)
PL-15070	Right	Corner Key (Diecast)
PL-15072	Left	Corner Key (Diecast)
PL-15074	Right	Corner Key (Diecast)
PL-15076	Left	Corner Key (Diecast)
PL-15078	Right	Corner Key (Diecast)
PL-15080	Left	Corner Key (Diecast)
PL-15082	Right	Corner Key (Diecast)
PL-15084	Left	Corner Key (Diecast)
PL-15152	—	Tilt Key (Nylon)
PL-15154	—	Tilt Key (Nylon)
PL-15166	—	Tilt Key (Nylon)
PL-15176	—	Tilt Key (Nylon)
PL-15244	—	Tilt Key (Diecast)
PL-15248	Right	Tilt Key (Diecast)
PL-15250	Left	Tilt Key (Diecast)
PL-15252	—	Tilt Key (Diecast)
PL-15254	Right	Tilt Key (Diecast)
PL-15256	Left	Tilt Key (Diecast)
PL-15270	Left	Tilt Key (Diecast)
PL-15272	Right	Tilt Key (Diecast)
PL-15432	Left	Slide Bolt (Diecast)
PL-15434	Right	Slide Bolt (Diecast)
PL-15436	Left	Slide Bolt (Diecast)
PL-15438	Right	Slide Bolt (Diecast)
PL-15440	Left	Slide Bolt (Diecast)
PL-15442	Right	Slide Bolt (Diecast)
PL-15444	Left	Slide Bolt (Diecast)
PL-15446	Right	Slide Bolt (Diecast)
PL-15448	Left	Slide Bolt (Diecast)
PL-15450	Right	Slide Bolt (Diecast)
PL-15452	Left	Slide Bolt (Diecast)
PL-15454	Right	Slide Bolt (Diecast)

PARTS KITS

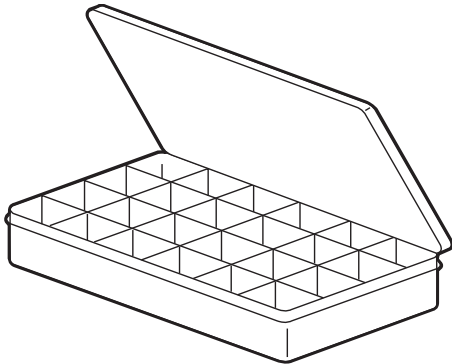

- Labels Included
- Stackable
- See Pages 57 thru 108 for Bulk Product

PL-8129 ASSORTED HARDWARE KIT

Part No.	Handing	Description	Qty.
PL-14518	—	Turn Button (Nylon)	25
PL-14566	—	Screen Clip (Nylon)	25
PL-14634	—	Turn Button (Nylon)	25
PL-14750	—	Panel Clip (Aluminum)	25
PL-14768	—	Thumbscrew (Aluminum)	25
PL-14798	—	Panel Clip (Aluminum)	25
PL-14828	—	Turn Button (Aluminum)	25
PL-14861	—	Insert Clip (Steel)	25
PL-14863	—	Insert Clip (Steel)	25
PL-14865	—	Insert Clip (Steel)	25
PL-14867	—	Insert Clip (Steel)	25
PL-14869	—	Insert Clip (Steel)	25
PL-14950	—	Corner Key (Nylon)	20
PL-14964	—	Corner Key (Nylon)	20
PL-14966	—	Corner Key (Nylon)	20
PL-14968	Left	Corner Key (Nylon)	20
PL-14970	Right	Corner Key (Nylon)	20
PL-15030	—	Corner Key (Aluminum)	20
PL-15130	—	Tilt Key (Nylon)	20
PL-15144	—	Tilt Key (Nylon)	20
PL-15146	Left	Tilt Key (Nylon)	20
PL-15148	Right	Tilt Key (Nylon)	20
PL-15150	—	Tilt Key (Nylon)	20
PL-15176	—	Tilt Key (Nylon)	20

PL-8130 ASSORTED HARDWARE KIT

• 25 of Each Item (In Bulk)

Part No.	Handing	Description
PL-14518	—	Turn Button (Nylon)
PL-14566	—	Screen Clip (Nylon)
PL-14590	—	Screen Clip (Nylon)
PL-14634	—	Turn Button (Nylon)
PL-14750	—	Panel Clip (Aluminum)
PL-14756	—	Panel Clip (Aluminum)
PL-14768	—	Thumbscrew (Aluminum)
PL-14774	—	Panel Clip (Aluminum)
PL-14780	—	Panel Clip (Aluminum)
PL-14786	—	Panel Clip (Aluminum)
PL-14792	—	Panel Clip (Aluminum)
PL-14798	—	Panel Clip (Aluminum)
PL-14804	—	Panel Clip (Aluminum)
PL-14810	—	Panel Clip (Aluminum)
PL-14822	—	Panel Clip (Aluminum)
PL-14816	—	Panel Clip (Aluminum)
PL-14819	—	Panel Clip (Aluminum)

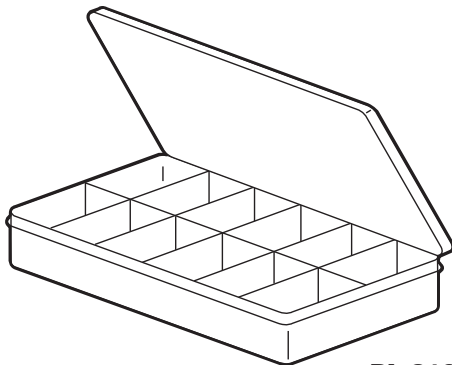

- Labels Included
- Stackable
- See Pages 57 thru 108 for Bulk Product

PL-8124 ASSORTED HARDWARE KIT

• 20 of Each Item (In Bulk)

Part No.	Handing	Description
PL-15322	Left	Slide Bolt (Nylon)
PL-15324	Right	Slide Bolt (Nylon)
PL-15326	Left	Slide Bolt (Nylon)
PL-15328	Right	Slide Bolt (Nylon)
PL-15330	Left	Slide Bolt (Nylon)
PL-15332	Right	Slide Bolt (Nylon)
PL-15334	Left	Slide Bolt (Nylon)
PL-15336	Right	Slide Bolt (Nylon)
PL-15338	Left	Slide Bolt (Nylon)
PL-15340	Right	Slide Bolt (Nylon)
PL-15342	Left	Slide Bolt (Nylon)
PL-15344	Right	Slide Bolt (Nylon)

PL-8125 ASSORTED HARDWARE KIT

Part No.	Description	Qty.
PL-14621	Lift Tab (Plastic)	25
PL-14624	Flat Spring (Spring Steel)	25
PL-14630	Flat Spring (Spring Steel)	25
PL-14658	Bail Latch (Aluminum)	25
PL-14666	Plunger Latch (Nylon)	25
PL-14672	Knife Latch (Right)	25
PL-14674	Knife Latch (Left)	25
PL-14999	Turn Button (Aluminum)	25
PL-15001	Turn Button (Aluminum)	25
PL-15565	Screen Hanger (Aluminum)	10 Pair
PL-16116	Knife Latch (Right)	20
PL-16118	Knife Latch (Left)	20

Note: Fractional measurements are nominal only, decimal are actual dimensions.
"A" & "B" dimensions **ONLY** indicate that both legs are equal.

CORNER KEYS

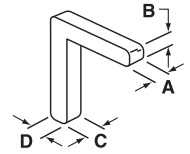

Pack Qty.	Min. Order Qty.	Part Number			Pack Qty.	Min. Order Qty.	Part Number		
20/Tub	1	PL-14950		Nylon	20/Tub	1	PL-14952		Nylon
100/Tub	1	PL-14951			100/Tub	1	PL-14953		
"A"	"B"	"C"	"D"		"A"	"B"	"C"	"D"	
.175	.180				.205	.178			
3/16"	3/16"				7/32"	3/16"			
					Related Parts: PL-15132 (Tilt Key)				
20/Tub	1	PL-14954		Nylon	20/Tub	1	PL-14956		Nylon
100/Tub	1	PL-14955			100/Tub	1	PL-14957		
"A"	"B"	"C"	"D"		"A"	"B"	"C"	"D"	
.190	.236				.164	.228			
5/32"	1/4"				5/32"	1/4"			
					Related Parts: PL-15138 (Tilt Key)				
20/Tub	1	PL-14960		Nylon Left Hand	20/Tub	1	PL-14962		Nylon Right Hand
100/Tub	1	PL-14961			100/Tub	1	PL-14963		
"A"	"B"	"C"	"D"		"A"	"B"	"C"	"D"	
.106	.200	.157	.200		.106	.200	.157	.200	
5/32"	7/32"	3/32"	7/32"		5/32"	7/32"	3/32"	7/32"	
					Related Parts: PL-15146 (Tilt Key)				
20/Tub	1	PL-14968		Nylon Left Hand	20/Tub	1	PL-14970		Nylon Right Hand
100/Tub	1	PL-14969			100/Tub	1	PL-14971		
"A"	"B"	"C"	"D"		"A"	"B"	"C"	"D"	
.198	.195	.132	.197		.198	.195	.132	.197	
3/16"	3/16"	1/8"	3/16"		3/16"	3/16"	1/8"	3/16"	
					Related Parts: PL-15140 (Tilt Key)				
20/Tub	1	PL-14958		Nylon	20/Tub	1	PL-14964		Nylon
100/Tub	1	PL-14959			100/Tub	1	PL-14965		
"A"	"B"	"C"	"D"		"A"	"B"	"C"	"D"	
.210	.175				.185	.190			
7/32"	3/16"				3/16"	3/16"			
					Related Parts: PL-15132 (Tilt Key)				

All Items Shown Are Actual Size

Note: Fractional measurements are nominal only, decimal are actual dimensions.

"A" & "B" dimensions **ONLY** indicate that both legs are equal.

CORNER KEYS

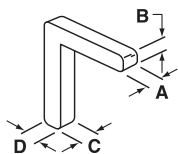

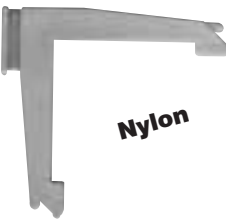

	Pack Qty.	Min. Order Qty.	Part Number	
 Nylon	20/Tub	1	PL-14966	
	100/Tub	1	PL-14967	
	"A"	"B"	"C"	"D"
	.238	.202		
	7/32"	7/32"		
Related Parts: PL-15144 (Tilt Key)				

	Pack Qty.	Min. Order Qty.	Part Number	
 Nylon	20/Tub	1	PL-14972	
	100/Tub	1	PL-14973	
	"A"	"B"	"C"	"D"
	.200	.130		
	3/16"	1/8"		
Related Parts: PL-15152 (Tilt Key)				

	Pack Qty.	Min. Order Qty.	Part Number	
 Nylon	20/Tub	1	PL-14974	
	100/Tub	1	PL-14975	
	"A"	"B"	"C"	"D"
	.180	.185		
	3/16"	3/16"		
Related Parts: PL-15154 (Tilt Key)				

	Pack Qty.	Min. Order Qty.	Part Number	
 Nylon	20/Tub	1	PL-14976	
	100/Tub	1	PL-14977	
	"A"	"B"	"C"	"D"
	.206	.295		
	5/32"	9/32"		
Related Parts: PL-15156 (Tilt Key)				

	Pack Qty.	Min. Order Qty.	Part Number	
 Nylon Left Hand	20/Tub	1	PL-14990	
	100/Tub	1	PL-14992	
	"A"	"B"	"C"	"D"
	.175	.495		
	3/16"	1/2"		

	Pack Qty.	Min. Order Qty.	Part Number	
 Nylon Right Hand	20/Tub	1	PL-14991	
	100/Tub	1	PL-14993	
	"A"	"B"	"C"	"D"
	.175	.495		
	3/16"	1/2"		

	Pack Qty.	Min. Order Qty.	Part Number	
 Nylon	20/Tub	1	PL-14978	
	100/Tub	1	PL-14979	
	"A"	"B"	"C"	"D"
	.185	.444		
	3/16"	7/16"		
Related Parts: PL-15164 (Tilt Key)				

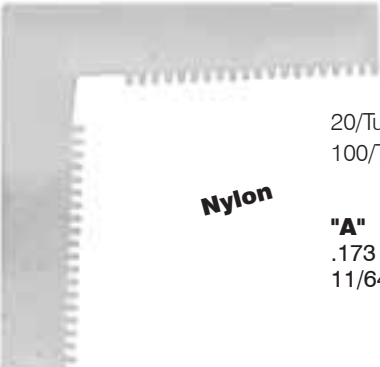
	Pack Qty.	Min. Order Qty.	Part Number	
 Nylon	20/Tub	1	PL-16278	
	100/Tub	1	PL-16279	
	"A"	"B"	"C"	"D"
	.173	.430		
	11/64"	7/16"		

All Items Shown Are Actual Size

Note: Fractional measurements are nominal only, decimal are actual dimensions.

"A" & "B" dimensions **ONLY** indicate that both legs are equal.

CORNER KEYS

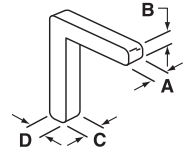

Pack Qty.	Min. Order Qty.	Part Number	"A"	"B"	"C"	"D"
20/Tub	1	PL-16320	.243	.245	.155	.245
100/Tub	1	PL-16321	1/4"	1/4"	5/32"	1/4"



Pack Qty.	Min. Order Qty.	Part Number	"A"	"B"	"C"	"D"
20/Tub	1	PL-16322	.243	.245	.155	.245
100/Tub	1	PL-16323	1/4"	1/4"	5/32"	1/4"



Related Parts: PL-16316

Related Parts: PL-16318

Pack Qty.	Min. Order Qty.	Part Number	"A"	"B"	"C"	"D"
20/Tub	1	PL-16324	.195	.195	.130	.195
100/Tub	1	PL-16325	3/16"	3/16"	1/8"	3/16"



Pack Qty.	Min. Order Qty.	Part Number	"A"	"B"	"C"	"D"
20/Tub	1	PL-16326	.195	.195	.130	.195
100/Tub	1	PL-16327	3/16"	3/16"	1/8"	3/16"



Pack Qty.	Min. Order Qty.	Part Number	"A"	"B"	"C"	"D"
20/Tub	1	PL-16270	.210	.310		
100/Tub	1	PL-16271	7/32"	5/16"		



Pack Qty.	Min. Order Qty.	Part Number	"A"	"B"	"C"	"D"
20/Tub	1	PL-16274	.265	.247		
100/Tub	1	PL-16275	9/32"	1/4"		



Related Parts: PL-16282

Pack Qty.	Min. Order Qty.	Part Number	"A"	"B"	"C"	"D"
20/Tub	1	PL-16276	.225	.210		
100/Tub	1	PL-16277	7/32"	7/32"		



Pack Qty.	Min. Order Qty.	Part Number	"A"	"B"	"C"	"D"
20/Tub	1	PL-16290	.250	.250	.	.
100/Tub	1	PL-16291	1/4"	1/4"	"	"



All Items Shown Are Actual Size

Note: Fractional measurements are nominal only, decimal are actual dimensions.

"A" & "B" dimensions **ONLY** indicate that both legs are equal.

CORNER KEYS

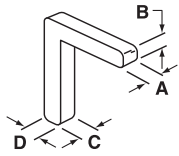

	Pack Qty.	Min. Order Qty.	Part Number			Pack Qty.	Min. Order Qty.	Part Number	
<p>Nylon</p>	20/Tub	1	PL-16352		<p>Nylon</p>	20/Tub	1	PL-16272	
	100/Tub	1	PL-16353			100/Tub	1	PL-16273	
	"A"	"B"	"C"	"D"		"A"	"B"	"C"	"D"
	.190	.190				.163	.205		
	3/16"	3/16"				5/32"	7/32"		
<p>Nylon</p>	20/Tub	1	PL-16302		<p>Nylon</p>	20/Tub	1	PL-16298	
	100/Tub	1	PL-16303			100/Tub	1	PL-16299	
	"A"	"B"	"C"	"D"		"A"	"B"	"C"	"D"
	.170	.180				.185	.185		
	5/32"	3/16"				3/16"	3/16"		
Related Parts: PL-16280									
<p>Nylon</p>	20/Tub	1	PL-16288		<p>Nylon</p>	20/Tub	1	PL-16300	
	100/Tub	1	PL-16289			100/Tub	1	PL-16301	
	"A"	"B"	"C"	"D"		"A"	"B"	"C"	"D"
	.185	.185				.185	.195		
	3/16"	3/16"				3/16"	13/64"		
Related Parts: PL-16292					Related Parts: PL-16296				
<p>Nylon</p>	20/Tub	1	PL-16284		<p>Nylon</p>	20/Tub	1	PL-16354	
	100/Tub	1	PL-16285			100/Tub	1	PL-16355	
	"A"	"B"	"C"	"D"		"A"	"B"	"C"	"D"
	.250	.178				.225	.205		
	1/4"	3/16"				7/32"	3/16"		
<p>Nylon</p>	20/Tub	1	PL-16286		<p>Nylon</p>	20/Tub	1	PL-14989	
	100/Tub	1	PL-16287						
	"A"	"B"	"C"	"D"		"A"	"B"	"C"	"D"
	.247	.175				.150	.220		
	1/4"	3/16"							

All Items Shown Are Actual Size

Note: Fractional measurements are nominal only, decimal are actual dimensions.
"A" & "B" dimensions **ONLY** indicate that both legs are equal.

CORNER KEYS

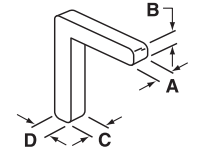

Pack Qty. **Min. Order Qty.** **Part Number**

20/Tub 1 PL-15003
100/Tub 1 PL-15004

"A" **"B"** **"C"** **"D"**
.200 .190
13/64" 3/16"



Pack Qty. **Min. Order Qty.** **Part Number**

20/Tub 1 PL-14980
100/Tub 1 PL-14981

"A" **"B"** **"C"** **"D"**
.211 .166
3/16" 5/32"



Related Parts: PL-15166 (Tilt Key)

20/Tub 1 PL-16268
100/Tub 1 PL-16269

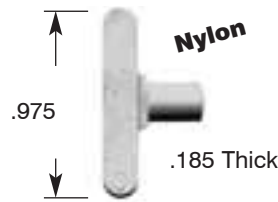

20/Tub 1 PL-15188
100/Tub 1 PL-15189

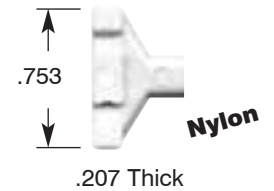

20/Tub 1 PL-14986
100/Tub 1 PL-14987



20/Tub 1 PL-16350
100/Tub 1 PL-16351

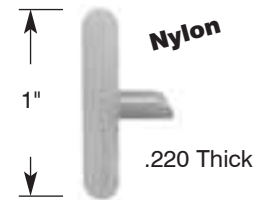

20/Tub 1 PL-15030
100/Tub 1 PL-15031

"A" **"B"** **"C"** **"D"**
.185 .189
3/16" 3/16"



20/Tub 1 PL-15036
100/Tub 1 PL-15037

"A" **"B"** **"C"** **"D"**
.250 .240
1/4" 7/32"



Related Parts: PL-15216 (Tilt Key)

20/Tub 1 PL-15032
100/Tub 1 PL-15033

"A" **"B"** **"C"** **"D"**
.250 .252 .177 .254
1/4" 7/32" 5/32" 7/32"



20/Tub 1 PL-15034
100/Tub 1 PL-15035

"A" **"B"** **"C"** **"D"**
.250 .252 .177 .254
1/4" 7/32" 5/32" 7/32"



Related Parts: PL-15212 (Tilt Key)

Related Parts: PL-15214 (Tilt Key)

All Items Shown Are Actual Size

Note: Fractional measurements are nominal only, decimal are actual dimensions.

"A" & "B" dimensions **ONLY** indicate that both legs are equal.

CORNER KEYS

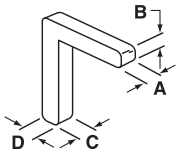

	Pack Qty.	Min. Order Qty.	Part Number			Pack Qty.	Min. Order Qty.	Part Number				
			"A"	"B"	"C"	"D"			"A"	"B"	"C"	"D"
 Diecast	20/Tub	1										
	100/Tub	1	.150	.236					.185	.188		
			1/8"	7/32"					5/32"	5/32"		
 Diecast	20/Tub	1										
	100/Tub	1										
			.122	.190					.158	.246		
			1/8"	5/32"					5/32"	1/4"		
 Diecast	20/Tub	1										
	100/Tub	1										
			.170	.173					.165	.175		
			11/64"	11/64"					11/64"	11/64"		
 Diecast	20/Tub	1										
	100/Tub	1										
			.146	.188	.190	.188			.146	.188	.190	.188
			5/32"	3/16"	3/16"	3/16"			5/32"	3/16"	3/16"	3/16"
 Diecast Left Hand	20/Tub	1										
	100/Tub	1										
			.191	.191	.150	.185			.191	.191	.150	.185
			3/16"	5/32"	5/32"	5/32"			3/16"	5/32"	5/32"	5/32"
 Diecast Right Hand	20/Tub	1										
	100/Tub	1										
			.191	.191	.150	.185			.191	.191	.150	.185
			3/16"	5/32"	5/32"	5/32"			3/16"	5/32"	5/32"	5/32"
 Diecast Left Hand	20/Tub	1										
	100/Tub	1										
			.191	.191	.150	.185			.191	.191	.150	.185
			3/16"	5/32"	5/32"	5/32"			3/16"	5/32"	5/32"	5/32"
 Diecast Right Hand	20/Tub	1										
	100/Tub	1										
			.191	.191	.150	.185			.191	.191	.150	.185
			3/16"	5/32"	5/32"	5/32"			3/16"	5/32"	5/32"	5/32"

Related Parts: PL-15256 (Tilt Key)

Related Parts: PL-15254 (Tilt Key)

All Items Shown Are Actual Size

Note: Fractional measurements are nominal only, decimal are actual dimensions.
"A" & "B" dimensions **ONLY** indicate that both legs are equal.

CORNER KEYS

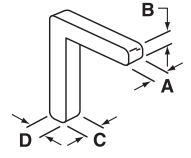

Pack Qty.	Min. Order Qty.	Part Number	"A"	"B"	"C"	"D"
20/Tub	1	PL-15104	.117	.195	.163	.165
100/Tub	1	PL-15105	1/8"	3/16"	5/32"	5/32"



Pack Qty.	Min. Order Qty.	Part Number	"A"	"B"	"C"	"D"
20/Tub	1	PL-15112	.117	.195	.163	.165
100/Tub	1	PL-15113	1/8"	3/16"	5/32"	5/32"



Fits Sears Windows

Fits Sears Windows

Pack Qty.	Min. Order Qty.	Part Number	"A"	"B"	"C"	"D"
20/Tub	1	PL-15102	.172	.176		
100/Tub	1	PL-15103	3/16"	3/16"		



Pack Qty.	Min. Order Qty.	Part Number	"A"	"B"	"C"	"D"
20/Tub	1	PL-15096	.191	.128	.192	.127
100/Tub	1	PL-15097	3/16"	1/8"	3/16"	1/8"



Fits C-Sash Frame

Pack Qty.	Min. Order Qty.	Part Number	"A"	"B"	"C"	"D"
20/Tub	1	PL-15052	.198	.197		
100/Tub	1	PL-15053	3/16"	3/16"		



Pack Qty.	Min. Order Qty.	Part Number	"A"	"B"	"C"	"D"
20/Tub	1	PL-15062	.246	.248		
100/Tub	1	PL-15063	1/4"	1/4"		



Pack Qty.	Min. Order Qty.	Part Number	"A"	"B"	"C"	"D"
20/Tub	1	PL-15046	.102	.275	.230	.656
100/Tub	1	PL-15047	3/32"	1/4"	5/32"	5/8"



Pack Qty.	Min. Order Qty.	Part Number	"A"	"B"	"C"	"D"
20/Tub	1	PL-15044	.102	.275	.230	.656
100/Tub	1	PL-15045	3/32"	1/4"	5/32"	5/8"



Related Parts:
PL-15218 (Tilt Key)
PL-15400 (Slide Bolt)

Related Parts:
PL-15220 (Tilt Key)
PL-15402 (Slide Bolt)

All Items Shown Are Actual Size

Note: Fractional measurements are nominal only, decimal are actual dimensions.

"A" & "B" dimensions **ONLY** indicate that both legs are equal.

CORNER KEYS

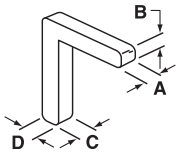

Pack Qty.	Min. Order Qty.	Part Number	"A"	"B"	"C"	"D"
20/Tub	1	PL-15048	.240	.250	.276	.824
100/Tub	1	PL-15049	7/32"	7/32"	7/32"	13/16"

Related Parts: PL-15404 (Slide Bolt)



Pack Qty.	Min. Order Qty.	Part Number	"A"	"B"	"C"	"D"
20/Tub	1	PL-15050	.240	.250	.276	.824
100/Tub	1	PL-15051	7/32"	7/32"	7/32"	13/16"

Related Parts: PL-15406 (Slide Bolt)



Pack Qty.	Min. Order Qty.	Part Number	"A"	"B"	"C"	"D"
20/Tub	1	PL-15088	.177	.179	.238	.648
100/Tub	1	PL-15089	3/16"	3/16"	1/4"	21/32"

Related Parts: PL-15428 (Slide Bolt)



Pack Qty.	Min. Order Qty.	Part Number	"A"	"B"	"C"	"D"
20/Tub	1	PL-15086	.177	.179	.238	.648
100/Tub	1	PL-15087	3/16"	3/16"	1/4"	21/32"

Related Parts: PL-15430 (Slide Bolt)



Pack Qty.	Min. Order Qty.	Part Number	"A"	"B"	"C"	"D"
20/Tub	1	PL-15072	.230	.471	.232	.472
100/Tub	1	PL-15073	7/32"	15/32"	7/32"	15/32"

Related Parts:
PL-15250 (Tilt Key)
PL-15446 (Slide Bolt)



Pack Qty.	Min. Order Qty.	Part Number	"A"	"B"	"C"	"D"
20/Tub	1	PL-15070	.230	.471	.232	.472
100/Tub	1	PL-15071	7/32"	15/32"	7/32"	15/32"

Related Parts:
PL-15248 (Tilt Key)
PL-15444 (Slide Bolt)



Pack Qty.	Min. Order Qty.	Part Number	"A"	"B"	"C"	"D"
20/Tub	1	PL-15076	.159	.247	.297	.832
100/Tub	1	PL-15077	5/32"	1/4"	1/4"	13/16"

Related Parts: PL-15404 (Slide Bolt)

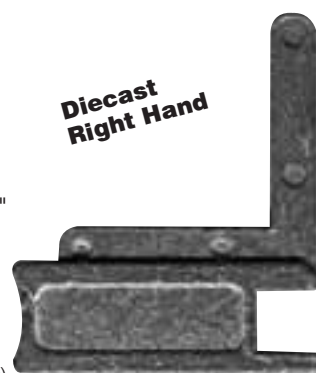

Pack Qty.	Min. Order Qty.	Part Number	"A"	"B"	"C"	"D"
20/Tub	1	PL-15074	.159	.247	.297	.832
100/Tub	1	PL-15075	5/32"	1/4"	1/4"	13/16"

Related Parts: PL-15406 (Slide Bolt)

All Items Shown Are Actual Size

Note: Fractional measurements are nominal only, decimal are actual dimensions.
"A" & "B" dimensions **ONLY** indicate that both legs are equal.

CORNER KEYS

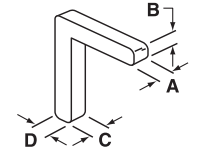

Pack Qty. **Min. Order Qty.** **Part Number**

20/Tub 1 PL-15092
100/Tub 1 PL-15093

"A" **"B"** **"C"** **"D"**
.168 .200 .253 .187
5/32" 7/32" 1/4" 3/16"



Pack Qty. **Min. Order Qty.** **Part Number**

20/Tub 1 PL-15090
100/Tub 1 PL-15091

"A" **"B"** **"C"** **"D"**
.168 .200 .253 .187
5/32" 7/32" 1/4" 3/16"



20/Tub 1 PL-15100
100/Tub 1 PL-15101

"A" **"B"** **"C"** **"D"**
.110 .270 .220 .770
3/32" 9/32" 7/32" 25/32"

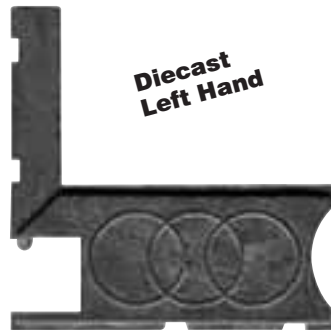

20/Tub 1 PL-15098
100/Tub 1 PL-15099

"A" **"B"** **"C"** **"D"**
.110 .270 .220 .770
3/32" 9/32" 7/32" 25/32"

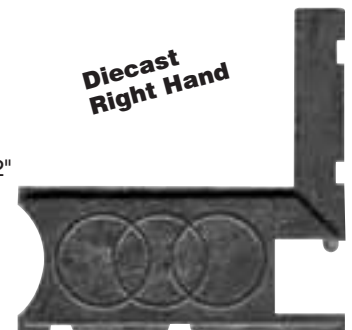

Use with PL-15392 Tilt Key

Use with PL-15394 Tilt Key

20/Tub 1 PL-15054
100/Tub 1 PL-15055

"A" **"B"** **"C"** **"D"**
.120 .267 .230 .643
1/8" 1/4" 7/32" 5/8"



20/Tub 1 PL-15056
100/Tub 1 PL-15057

"A" **"B"** **"C"** **"D"**
.120 .267 .230 .643
1/8" 1/4" 7/32" 5/8"



Related Parts: PL-15412 (Slide Bolt)
PL-15230 (Slide Bolt)

Related Parts: PL-15414 (Slide Bolt)
PL-15232 (Slide Bolt)

20/Tub 1 PL-15058
100/Tub 1 PL-15059

"A" **"B"** **"C"** **"D"**
.142 .205 .250 .700
15/64" 13/64" 1/4" 11/16"



20/Tub 1 PL-15060
100/Tub 1 PL-15061

"A" **"B"** **"C"** **"D"**
.142 .205 .250 .700
15/64" 13/64" 1/4" 11/16"



Related Parts: PL-15416 (Slide Bolt)

Related Parts: PL-15418 (Slide Bolt)

All Items Shown Are Actual Size

Note: Fractional measurements are nominal only, decimal are actual dimensions.

"A" & "B" dimensions **ONLY** indicate that both legs are equal.

TILT KEYS

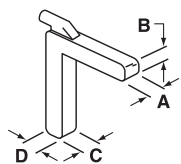

	Pack Qty.	Min. Order Qty.	Part Number			Pack Qty.	Min. Order Qty.	Part Number	
	20/Tub	1	PL-15130			20/Tub	1	PL-15132	
	100/Tub	1	PL-15131			100/Tub	1	PL-15133	
Nylon	"A"	"B"	"C"	"D"	Nylon	"A"	"B"	"C"	"D"
	.180	.202				.210	.180		
	3/16"	3/16"				7/32"	3/16"		

Related Parts: PL-14952, PL-14958 (Corner Keys)

	20/Tub	1	PL-15176			20/Tub	1	PL-15134	
	100/Tub	1	PL-15177			100/Tub	1	PL-15135	
Nylon	"A"	"B"	"C"	"D"	Nylon	"A"	"B"	"C"	"D"
	.171	.191				.163	.200		
	5/32"	5/32"				5/32"	7/32"		

	20/Tub	1	PL-15136			20/Tub	1	PL-15138	
	100/Tub	1	PL-15137			100/Tub	1	PL-15139	
Nylon	"A"	"B"	"C"	"D"	Nylon	"A"	"B"	"C"	"D"
	.184	.196				.169	.235		
	3/16"	3/16"				5/32"	1/4"		

Related Parts: PL-14954, PL-14956 (Corner Keys)

	20/Tub	1	PL-15140			20/Tub	1	PL-15142	
	100/Tub	1	PL-15141			100/Tub	1	PL-15143	
Nylon Left Hand	"A"	"B"	"C"	"D"	Nylon Right Hand	"A"	"B"	"C"	"D"
	.129	.196	.127	.193		.129	.196	.127	.193
	5/32"	3/16"	3/32"	3/16"		5/32"	3/16"	3/32"	3/16"

Related Parts: PL-14968 (Corner Key)

Related Parts: PL-14970 (Corner Key)

Note: Fractional measurements are nominal only, decimal are actual dimensions.
"A" & "B" dimensions **ONLY** indicate that both legs are equal.

TILT KEYS

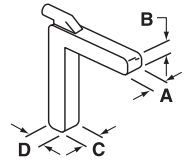

Pack Qty.	Min. Order Qty.	Part Number				Pack Qty.	Min. Order Qty.	Part Number					
20/Tub	1	PL-15144		Nylon		20/Tub	1	PL-15150		Nylon			
100/Tub	1	PL-15145				100/Tub	1	PL-15151					
"A"	"B"	"C"	"D"			"A"	"B"	"C"	"D"				
.230	.208					.160	.185						
7/32"	7/32"					3/16"	3/16"						
Related Parts: PL-14966 (Corner Key)					Related Parts: PL-14962 (Corner Key)								
20/Tub	1	PL-15146		Nylon Left Hand		20/Tub	1	PL-15148		Nylon Right Hand			
100/Tub	1	PL-15147				100/Tub	1	PL-15149					
"A"	"B"	"C"	"D"			"A"	"B"	"C"	"D"				
.101	.188					.101	.188						
3/32"	7/32"					3/32"	7/32"						
Related Parts: PL-14960 (Corner Key)					Related Parts: PL-14962 (Corner Key)								
20/Tub	1	PL-15152		Nylon		20/Tub	1	PL-15154		Nylon			
100/Tub	1	PL-15153				100/Tub	1	PL-15155					
"A"	"B"	"C"	"D"			"A"	"B"	"C"	"D"				
.172	.125					.178	.176						
3/16"	1/8"					3/16"	3/16"						
Related Parts: PL-14972 (Corner Key)					Related Parts: PL-14974 (Corner Key)								
20/Tub	1	PL-15156		Nylon		20/Tub	1	PL-15164		Nylon			
100/Tub	1	PL-15157				100/Tub	1	PL-15165					
"A"	"B"	"C"	"D"			"A"	"B"	"C"	"D"				
.208	.300					.174	.450						
5/32"	9/32"					3/16"	7/16"						
Related Parts: PL-14976 (Corner Key)					Related Parts: PL-14978 (Corner Key)								

All Items Shown Are Actual Size

Note: Fractional measurements are nominal only, decimal are actual dimensions.

"A" & "B" dimensions **ONLY** indicate that both legs are equal.

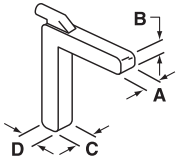

TILT KEYS

	Pack Qty.	Min. Order Qty.	Part Number			Pack Qty.	Min. Order Qty.	Part Number	
<p>Nylon</p>	20/Tub	1	PL-15158		<p>Nylon</p>	20/Tub	1	PL-14997	
	100/Tub	1	PL-15159			100/Tub	1	PL-14998	
	"A"	"B"	"C"	"D"		"A"	"B"	"C"	"D"
	.282	.285			.174	.188			
	9/32"	9/32"			11/64"	3/16"			
<p>Nylon Left Hand</p>	20/Tub	1	PL-15168		<p>Nylon Right Hand</p>	20/Tub	1	PL-15170	
	100/Tub	1	PL-15169			100/Tub	1	PL-15171	
	"A"	"B"	"C"	"D"		"A"	"B"	"C"	"D"
	.132	.308			.132	.308			
	1/8"	5/16"			1/8"	5/16"			
Related Parts: PL-15348 (Slide Bolt)					Related Parts: PL-15350 (Slide Bolt)				
<p>Plastic Left Hand</p>	20/Tub	10	PL-16085		<p>Plastic Right Hand</p>	20/Tub	10	PL-16087	
	100/Tub	10	PL-16086			100/Tub	10	PL-16088	
	"A"	"B"	"C"	"D"		"A"	"B"	"C"	"D"
	.125	.195			.125	.195			
	1/8"	3/16"			1/8"	3/16"			
<p>Nylon Left Hand</p>	20/Tub	1	PL-16304		<p>Nylon Right Hand</p>	20/Tub	1	PL-16306	
	100/Tub	1	PL-16305			100/Tub	1	PL-16307	
	"A"	"B"	"C"	"D"		"A"	"B"	"C"	"D"
	.183	.173			.183	.173			
	3/16"	3/16"			3/16"	3/16"			
Related Parts: PL-16302					Related Parts: PL-16302				

All Items Shown Are Actual Size

Note: Fractional measurements are nominal only, decimal are actual dimensions.

"A" & "B" dimensions **ONLY** indicate that both legs are equal.

TILT KEYS

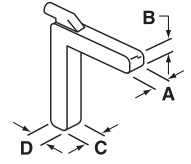

Pack Qty.	Min. Order Qty.	Part Number			Pack Qty.	Min. Order Qty.	Part Number		
20/Tub	1	PL-16312			20/Tub	1	PL-16314		
100/Tub	1	PL-16313			100/Tub	1	PL-16315		
"A"	"B"	"C"	"D"	Nylon Left Hand	"A"	"B"	"C"	"D"	Nylon Right Hand
.120	.195				.120	.195			
1/8"	3/16"				1/8"	3/16"			
Related Parts: PL-16308					Related Parts: PL-16310				

20/Tub	1	PL-16316			20/Tub	1	PL-16318		
100/Tub	1	PL-16317			100/Tub	1	PL-16319		
"A"	"B"	"C"	"D"	Nylon Left Hand	"A"	"B"	"C"	"D"	Nylon Right Hand
.150	.250				.150	.250			
5/32"	1/4"				5/32"	1/4"			
Related Parts: PL-16320					Related Parts: PL-16322				

20/Tub	1	PL-16328			20/Tub	1	PL-16330		
100/Tub	1	PL-16329			100/Tub	1	PL-16331		
"A"	"B"	"C"	"D"	Nylon Left Hand	"A"	"B"	"C"	"D"	Nylon Right Hand
.245	.240	.164	.240		.245	.240	.164	.240	
1/4"	1/4"	5/32"	1/4"		1/4"	1/4"	5/32"	1/4"	
Related Parts: PL-16320					Related Parts: PL-16322				

20/Tub	1	PL-16294			20/Tub	1	PL-16280		
100/Tub	1	PL-16295			100/Tub	1	PL-16281		
"A"	"B"	"C"	"D"	Nylon	"A"	"B"	"C"	"D"	Nylon
.248	.248				.178	.185			
1/4"	1/4"				3/16"	3/16"			
Related Parts: PL-16290					Related Parts: PL-16298				

All Items Shown Are Actual Size

Note: Fractional measurements are nominal only, decimal are actual dimensions.

"A" & "B" dimensions **ONLY** indicate that both legs are equal.

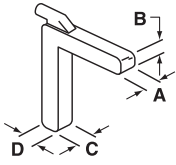

TILT KEYS

	Pack Qty.	Min. Order Qty.	Part Number			Pack Qty.	Min. Order Qty.	Part Number	
	20/Tub	1	PL-16282		Nylon	20/Tub	1	PL-16296	
	100/Tub	1	PL-16283			100/Tub	1	PL-16297	
	"A"	"B"	"C"	"D"		"A"	"B"	"C"	"D"
	.197	.335				.185	.195		
	3/16"	11/32"				3/16"	3/16"		
Related Parts: PL-16270					Related Parts: PL-16300				
	20/Tub	1	PL-16292		Nylon	20/Tub	1	PL-16266	
	100/Tub	1	PL-16293			100/Tub	1	PL-16267	
	"A"	"B"	"C"	"D"		"A"	"B"	"C"	"D"
	.180	.185				.170	.205		
	3/16"	3/16"				3/16"	7/32"		
Related Parts: PL-16288									
	20/Tub	1	PL-15196		Nylon	20/Tub	1	PL-15174	
	100/Tub	1	PL-15197			100/Tub	1	PL-15175	
	"A"	"B"	"C"	"D"		"A"	"B"	"C"	"D"
	.182	.190				.215	.134		
	3/16"	3/16"				7/32"	1/8"		
	20/Tub	1	PL-15180		Nylon Left Hand	20/Tub	1	PL-15182	
	100/Tub	1	PL-15181			100/Tub	1	PL-15183	
	"A"	"B"	"C"	"D"		"A"	"B"	"C"	"D"
	.186	.260				.186	.260		
	3/16"	1/4"				3/16"	1/4"		
For Sears Screen Frames					For Sears Screen Frames				

All Items Shown Are Actual Size

Note: Fractional measurements are nominal only, decimal are actual dimensions.
"A" & "B" dimensions **ONLY** indicate that both legs are equal.

TILT KEYS

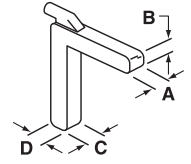

Pack Qty.	Min. Order Qty.	Part Number		Pack Qty.	Min. Order Qty.	Part Number	
20/Tub	1	PL-15178		20/Tub	1	PL-15166	
100/Tub	1	PL-15179		100/Tub	1	PL-15167	
"A"	"B"	"C"	"D"	"A"	"B"	"C"	"D"
.175 3/16"	.245 1/4"			.211 3/16"	.322 5/32"		

For Sears Screen Frames

Related Parts: PL-14980 (Corner Key)

20/Tub	1	PL-15172		20/Tub	1	PL-15216	
100/Tub	1	PL-15173		100/Tub	1	PL-15217	
"A"	"B"	"C"	"D"	"A"	"B"	"C"	"D"
.182 3/16"	.328 5/16"			.235 1/4"	.245 7/32"		

Related Parts: PL-15036 (Corner Key)

20/Tub	1	PL-15212		20/Tub	1	PL-15214	
100/Tub	1	PL-15213		100/Tub	1	PL-15215	
"A"	"B"	"C"	"D"	"A"	"B"	"C"	"D"
.240 7/32"	.242 7/32"	.217 5/32"	.242 7/32"	.240 7/32"	.242 7/32"	.217 5/32"	.242 7/32"

Related Parts: PL-15032 (Corner Key)

Related Parts: PL-15034 (Corner Key)

20/Tub	1	PL-15218		20/Tub	1	PL-15220	
100/Tub	1	PL-15219		100/Tub	1	PL-15221	
"A"	"B"	"C"	"D"	"A"	"B"	"C"	"D"
.111 3/32"	.271 1/4"	.111 3/32"	.271 1/4"	.111 3/32"	.271 1/4"	.111 3/32"	.271 1/4"

Related Parts:
PL-15046 (Corner Key)
PL-15400 (Slide Bolt)

Related Parts:
PL-15044 (Corner Key)
PL-15402 (Slide Bolt)

All Items Shown Are Actual Size

Note: Fractional measurements are nominal only, decimal are actual dimensions.

"A" & "B" dimensions **ONLY** indicate that both legs are equal.

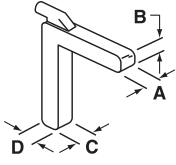

TILT KEYS

	Pack Qty.	Min. Order Qty.	Part Number			Pack Qty.	Min. Order Qty.	Part Number	
 Diecast	20/Tub	1	PL-15222		 Diecast	20/Tub	1	PL-15224	
	100/Tub	1	PL-15223			100/Tub	1	PL-15225	
	"A"	"B"	"C"	"D"		"A"	"B"	"C"	"D"
	.144	.191				.136	.207		
	1/8"	5/32"				3/32"	5/32"		

Related Parts: PL-15042 (Corner Key)

 Diecast	20/Tub	1	PL-15226		 Diecast	20/Tub	1	PL-15252	
	100/Tub	1	PL-15227			100/Tub	1	PL-15253	
	"A"	"B"	"C"	"D"		"A"	"B"	"C"	"D"
	.190	.184				.153	.192	.153	.192
	3/16"	5/32"				5/32"	3/16"	5/32"	3/16"

Related Parts:
PL-15102 (Corner Key)

 Diecast Left Hand	20/Tub	1	PL-15238		 Diecast Right Hand	20/Tub	1	PL-15240	
	100/Tub	1	PL-15239			100/Tub	1	PL-15241	
	"A"	"B"	"C"	"D"		"A"	"B"	"C"	"D"
	.165	.255				.165	.255		
	5/32"	7/32"				5/32"	7/32"		

Related Parts: PL-15064 (Corner Key)

Related Parts: PL-15064 (Corner Key)

 Diecast Left Hand	20/Tub	1	PL-15242	
	100/Tub	1	PL-15243	
	"A"	"B"	"C"	"D"
	.156	.248		
	5/32"	1/4"		

All Items Shown Are Actual Size

Note: Fractional measurements are nominal only, decimal are actual dimensions.

"A" & "B" dimensions **ONLY** indicate that both legs are equal.

TILT KEYS

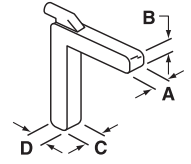

Pack Qty. **Min. Order Qty.** **Part Number**

20/Tub 10 PL-15270
100/Tub 10 PL-15271

"A" **"B"** **"C"** **"D"**
.118 .195
1/8" 3/16"



Replaces PL-15184

Pack Qty. **Min. Order Qty.** **Part Number**

20/Tub 10 PL-15272
100/Tub 10 PL-15273

"A" **"B"** **"C"** **"D"**
.118 .195
1/8" 3/16"



Replaces PL-15186

20/Tub 10 PL-15250
100/Tub 10 PL-15251

"A" **"B"** **"C"** **"D"**
.233 .470 .230 .477
7/32" 15/32" 7/32" 15/32"

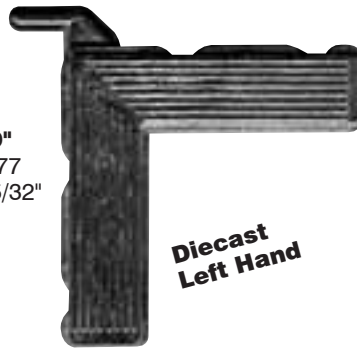

Related Parts:
PL-15072 (Corner Key)
PL-15440 (Slide Bolt)

20/Tub 10 PL-15248
100/Tub 10 PL-15249

"A" **"B"** **"C"** **"D"**
.233 .470 .230 .477
7/32" 15/32" 7/32" 15/32"

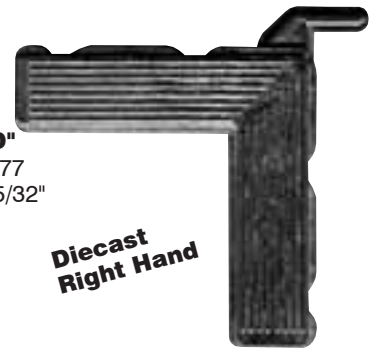

Related Parts:
PL-15070 (Corner Key)
PL-15442 (Slide Bolt)

20/Tub 10 PL-15256
100/Tub 10 PL-15257

"A" **"B"** **"C"** **"D"**
.156 .093 .156 .093
5/32" 3/32" 5/32" 3/32"



Related Parts: PL-15080 (Corner Key)

20/Tub 10 PL-15254
100/Tub 10 PL-15255

"A" **"B"** **"C"** **"D"**
.156 .093 .156 .093
5/32" 3/32" 5/32" 3/32"



Related Parts: PL-15078 (Corner Key)

20/Tub 10 PL-15244
100/Tub 10 PL-15245

"A" **"B"** **"C"** **"D"**
.167 .120 .167 .120
3/16" 1/8" 3/16" 1/8"



20/Tub 10 PL-15228
100/Tub 10 PL-15229

"A" **"B"** **"C"** **"D"**
.200 .195
3/16" 3/16"



Related Parts: PL-15052 (Corner Key)

All Items Shown Are Actual Size



Note: Fractional measurements are nominal only, decimal are actual dimensions.

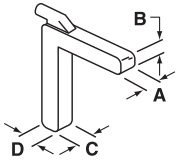

"A" & "B" dimensions **ONLY** indicate that both legs are equal.

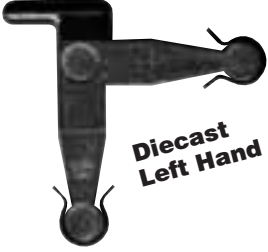
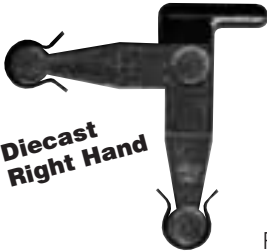



TILT KEYS

	Pack Qty.	Min. Order Qty.	Part Number			Pack Qty.	Min. Order Qty.	Part Number	
 Diecast Left Hand	20/Tub	10	PL-15230		 Diecast Right Hand	20/Tub	10	PL-15232	
	100/Tub	10	PL-15231			100/Tub	10	PL-15233	
	"A"	"B"	"C"	"D"		"A"	"B"	"C"	"D"
	.131	.262				.131	.262		
	1/8"	1/4"				1/8"	1/4"		
Related Parts: PL-15054 (Corner Key)					Related Parts: PL-15056 (Corner Key)				

 Diecast Left Hand	20/Tub	10	PL-15234		 Diecast Right Hand	20/Tub	10	PL-15236	
	100/Tub	10	PL-15235			100/Tub	10	PL-15237	
	"A"	"B"	"C"	"D"		"A"	"B"	"C"	"D"
	.145	.200				.145	.200		
	9/64"	13/64"				9/64"	13/64"		

 Diecast Left Hand	20/Tub	10	PL-15262		 Diecast Right Hand	20/Tub	10	PL-15260	
	100/Tub	10	PL-15263			100/Tub	10	PL-15261	
	"A"	"B"	"C"	"D"		"A"	"B"	"C"	"D"
	.100		.163	.147		.100	.163	.147	
	3/32"		5/32"	11/64"		3/32"	5/32"	11/64"	
Related Parts: PL-15464 (Slide Bolt) Fits Wepco® Windows					Related Parts: PL-15466 (Slide Bolt) Fits Wepco® Windows				

 Diecast	20/Tub	10	PL-15258		 Diecast	20/Tub	10	PL-15246	
	100/Tub	10	PL-15259			100/Tub	10	PL-15247	
	"A"	"B"	"C"	"D"		"A"	"B"	"C"	"D"
	.190	.186				.178	.178		
	3/16"	3/16"							

Note: Fractional measurements are nominal only, decimal are actual dimensions.

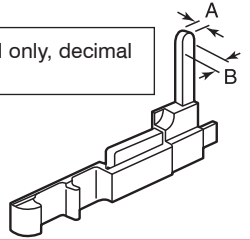

CORNER & LATCH ASSEMBLIES

Part No. **Handing** **Pack Qty.**

SCREEN CORNER LATCH

PL-15955	Left	20
PL-15956	Right	20

- Nylon
- 2 piece with spring
- Fits Sears window screen

"A"	"B"
.175	.245
3/16"	1/4"

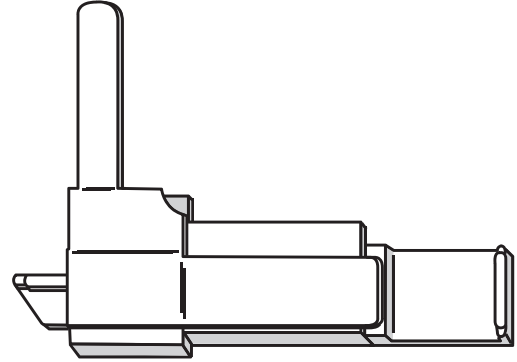

PL-15959	Left	20
PL-15960	Right	20

- Nylon
- 2 piece with spring
- Fits Sears window screen

"A"	"B"
.175	.250
3/16"	1/4"

NOT AVAILABLE
Use PL-15955 or PL-15960

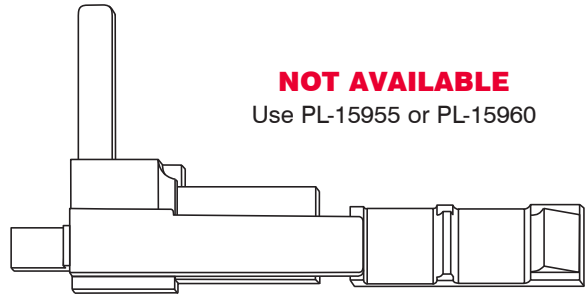

WINDOW CORNER LATCH

PL-15957	Left	20
PL-15958	Right	20

- Nylon corner / Zinc bolt
- 2 piece with spring
- Fits Sears window

"A"	"B"
.170	.240
3/16"	1/4"

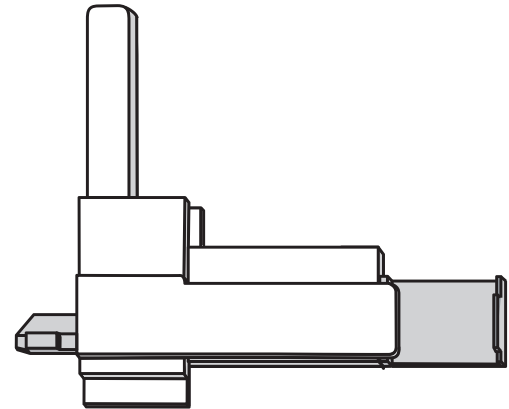







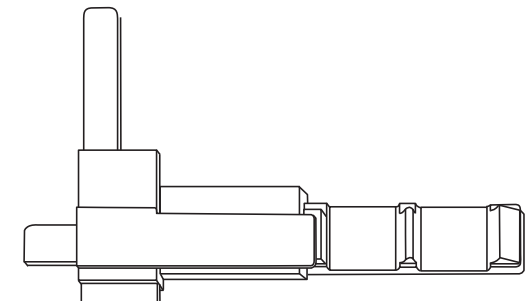

PL-15984	Left	20
PL-15985	Right	20

- Nylon corner / Zinc bolt
- 2 piece with spring
- Fits Sears window

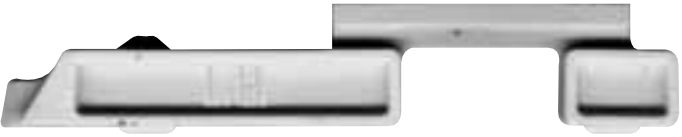
"A"	"B"
.170	.240
3/16"	1/4"











SLIDE BOLTS

	Description	Pack Qty.	Min. Order Qty.	Part Number
	Nylon, L.H.	20/Tub	1	PL-15300
		100/Box	1	PL-15301
	Nylon, R.H.	20/Tub	1	PL-15302
		100/Box	1	PL-15303
	Nylon, L.H.	20/Tub	1	PL-15304
		100/Box	1	PL-15305
	Nylon, R.H.	20/Tub	1	PL-15306
		100/Box	1	PL-15307
	Nylon, L.H.	20/Tub	1	PL-15308
		100/Box	1	PL-15309
	Nylon, R.H.	20/Tub	1	PL-15310
		100/Box	1	PL-15311
	Nylon, L.H.	20/Tub	1	PL-15314
		100/Box	1	PL-15315
	Nylon, R.H.	20/Tub	1	PL-15316
		100/Box	1	PL-15317







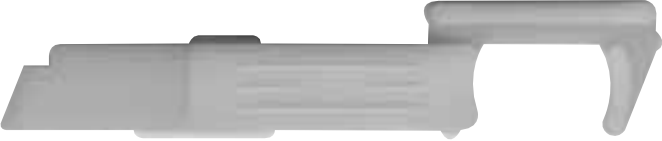

All Items Shown Are Actual Size

SLIDE BOLTS

Description	Pack Qty.	Min. Order Qty.	Part Number	
Nylon, L.H.	20/Tub	1	PL-15318	
	100/Box	1	PL-15319	
Nylon, R.H.	20/Tub	1	PL-15320	
	100/Box	1	PL-15321	
Nylon, L.H.	20/Tub	1	PL-15322	
	100/Box	1	PL-15323	
Nylon, R.H.	20/Tub	1	PL-15324	
	100/Box	1	PL-15325	
Nylon, L.H.	20/Tub	1	PL-15326	
	100/Box	1	PL-15327	
Nylon, R.H.	20/Tub	1	PL-15328	
	100/Box	1	PL-15329	
Nylon, L.H.	20/Tub	1	PL-15330	
	100/Box	1	PL-15331	
Nylon, R.H.	20/Tub	1	PL-15332	
	100/Box	1	PL-15333	







All Items Shown Are Actual Size

SLIDE BOLTS

	Description	Pack Qty.	Min. Order Qty.	Part Number
	Nylon, L.H.	20/Tub	1	PL-15334
		100/Box	1	PL-15335
	Nylon, R.H.	20/Tub	1	PL-15336
		100/Box	1	PL-15337
	Nylon, L.H.	20/Tub	1	PL-15338
		100/Box	1	PL-15339
	Nylon, R.H.	20/Tub	1	PL-15340
		100/Box	1	PL-15341
	Nylon, L.H.	20/Tub	1	PL-15342
		100/Box	1	PL-15343
	Nylon, R.H.	20/Tub	1	PL-15344
		100/Box	1	PL-15345
	Nylon, L.H.	20/Tub	1	PL-15348
		100/Box	1	PL-15349
	Related Parts: PL-15168 (Tilt Key)			
	Nylon, R.H.	20/Tub	1	PL-15350
		100/Box	1	PL-15351
	Related Parts: PL-15170 (Tilt Key)			

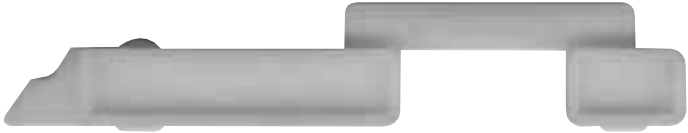
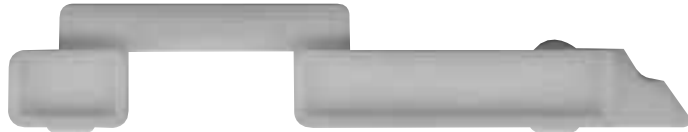







All Items Shown Are Actual Size

SLIDE BOLTS

Description	Pack Qty.	Min. Order Qty.	Part Number	
Nylon, L.H.	20/Tub	1	PL-15352	
	100/Box	1	PL-15353	
Nylon, R.H.	20/Tub	1	PL-15354	
	100/Box	1	PL-15355	
Nylon, L.H.	20/Tub	1	PL-15356	
	100/Box	1	PL-15357	
Nylon, R.H.	20/Tub	1	PL-15358	
	100/Box	1	PL-15359	
Nylon	20/Tub	1	PL-15312	
	100/Box	1	PL-15313	
Nylon	20/Tub	1	PL-15346	
	100/Box	1	PL-15347	
Nylon, L.H.	20/Tub	1	PL-15360	
	100/Box	1	PL-15361	
Nylon, R.H.	20/Tub	1	PL-15362	
	100/Box	1	PL-15363	









All Items Shown Are Actual Size

SLIDE BOLTS

	Description	Pack Qty.	Min. Order Qty.	Part Number
	Nylon, L.H.	20/Tub	1	PL-15368
		100/Box	1	PL-15369
	Nylon, R.H.	20/Tub	1	PL-15370
		100/Box	1	PL-15371
	Nylon, L.H.	20/Tub	1	PL-15372
		100/Box	1	PL-15373
	Nylon, R.H.	20/Tub	1	PL-15374
		100/Box	1	PL-15375
	Nylon, L.H.	20/Tub	1	PL-15376
		100/Box	1	PL-15377
	Nylon, R.H.	20/Tub	1	PL-15378
		100/Box	1	PL-15379
	Nylon, L.H.	20/Tub	1	PL-15380
		100/Box	1	PL-15381
	Nylon, R.H.	20/Tub	1	PL-15382
		100/Box	1	PL-15383







All Items Shown Are Actual Size

SLIDE BOLTS

Description	Pack Qty.	Min. Order Qty.	Part Number	
Nylon, L.H.	20/Tub	1	PL-16044	
	100/Box	1	PL-16045	
Nylon, R.H.	20/Tub	1	PL-16046	
	100/Box	1	PL-16047	
Nylon, L.H.	20/Tub	1	PL-16259	
	100/Box	1	PL-16260	
Nylon, R.H.	20/Tub	1	PL-16261	
	100/Box	1	PL-16262	
Nylon, L.H.	20/Tub	1	PL-16358	
	100/Box	1	PL-16359	
Nylon, R.H.	20/Tub	1	PL-16360	
	100/Box	1	PL-16361	
Nylon, L.H.	20/Tub	1	PL-16255	
	100/Box	1	PL-16256	
Nylon, R.H.	20/Tub	1	PL-16257	
	100/Box	1	PL-16258	

All Items Shown Are Actual Size

SLIDE BOLTS

	Description	Pack Qty.	Min. Order Qty.	Part Number
	Nylon, L.H.	20/Tub	1	PL-16251
		100/Box	1	PL-16252
	Nylon, R.H.	20/Tub	1	PL-16253
		100/Box	1	PL-16254
	Nylon	20/Tub	1	PL-16247
		100/Box	1	PL-16248
	Nylon	20/Tub	1	PL-16249
		100/Box	1	PL-16250
	Nylon	20/Tub	1	PL-16356
		100/Box	1	PL-16357
	Diecast, L.H.	20/Tub	1	PL-15400
		100/Box	1	PL-15401
Related Parts: PL-15046 (Corner Key), PL-15218 (Tilt Key)				
	Diecast, R.H.	20/Tub	1	PL-15402
		100/Box	1	PL-15403
Related Parts: PL-15044 (Corner Key), PL-15220 (Tilt Key) Fits Cole Sewel [®] and Peerless [®] Windows				

All Items Shown Are Actual Size

SLIDE BOLTS

Description	Pack Qty.	Min. Order Qty.	Part Number
--------------------	------------------	------------------------	--------------------

Diecast, L.H.	20/Tub	1	PL-15404
	100/Box	1	PL-15405
Related Parts: PL-15048, PL-15076 (Corner Keys)			



Diecast, R.H.	20/Tub	1	PL-15406
	100/Box	1	PL-15407
Related Parts: PL-15050, PL-15074 (Corner Keys)			



Diecast	20/Tub	1	PL-15408
	100/Box	1	PL-15409



Diecast	20/Tub	1	PL-15410
	100/Box	1	PL-15411



Diecast, L.H.	20/Tub	1	PL-15412
	100/Box	1	PL-15413
Related Parts: PL-15054 (Corner Key)			



Diecast, R.H.	20/Tub	1	PL-15414
	100/Box	1	PL-15415
Related Parts: PL-15056 (Corner Key)			



Diecast, L.H.	20/Tub	1	PL-15416
	100/Box	1	PL-15417
Related Parts: PL-15058 (Corner Key)			



Diecast, R.H.	20/Tub	1	PL-15418
	100/Box	1	PL-15419
Related Parts: PL-15060 (Corner Key)			



All Items Shown Are Actual Size

SLIDE BOLTS

Description	Pack Qty.	Min. Order Qty.	Part Number
--------------------	------------------	------------------------	--------------------



Diecast, L.H.	20/Tub	1	PL-15428
	100/Box	1	PL-15429
Related Parts: PL-15088 (Corner Key)			



Diecast, R.H.	20/Tub	1	PL-15430
	100/Box	1	PL-15431
Related Parts: PL-15086 (Corner Key)			

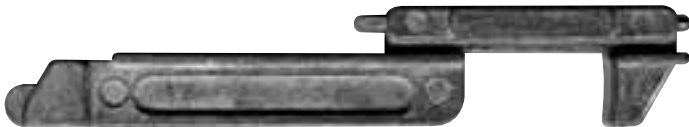

Diecast, L.H.	20/Tub	1	PL-15432
	100/Box	1	PL-15433

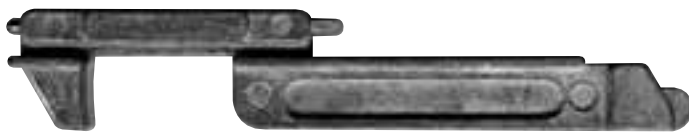

Diecast, R.H.	20/Tub	1	PL-15434
	100/Box	1	PL-15435



Diecast, L.H.	20/Tub	1	PL-15436
	100/Box	1	PL-15437



Diecast, R.H.	20/Tub	1	PL-15438
	100/Box	1	PL-15439









Diecast, L.H.	20/Tub	1	PL-15440
	100/Box	1	PL-15441
Related Parts: PL-15068 (Corner Key), PL-15246 (Tilt Key)			



Diecast, R.H.	20/Tub	1	PL-15442
	100/Box	1	PL-15443
Related Parts: PL-15066 (Corner Key), PL-15246 (Tilt Key)			
Fits V.E. Anderson [®] Windows			

All Items Shown Are Actual Size

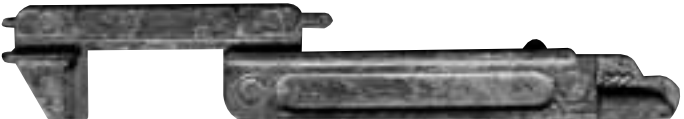
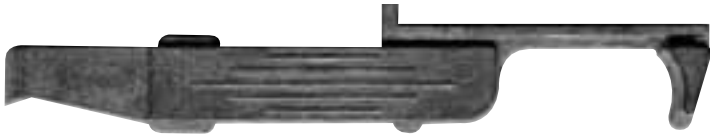
SLIDE BOLTS

Description	Pack Qty.	Min. Order Qty.	Part Number	
Diecast, L.H.	20/Tub	1	PL-15444	
	100/Box	1	PL-15445	
Diecast, R.H.	20/Tub	1	PL-15446	
	100/Box	1	PL-15447	
Diecast, L.H.	20/Tub	1	PL-15448	
	100/Box	1	PL-15449	
Call for availability				
Diecast, R.H.	20/Tub	1	PL-15450	
	100/Box	1	PL-15451	
Call for availability				
Diecast, L.H.	20/Tub	1	PL-15452	
	100/Box	1	PL-15453	
Diecast, R.H.	20/Tub	1	PL-15454	
	100/Box	1	PL-15455	
Diecast, L.H.	20/Tub	1	PL-15460	
	100/Box	1	PL-15461	
Diecast, R.H.	20/Tub	1	PL-15462	
	100/Box	1	PL-15463	

All Items Shown Are Actual Size

SLIDE BOLTS

	Description	Pack Qty.	Min. Order Qty.	Part Number
 <p>1/4" Thick</p>	Diecast, L.H.	20/Tub	1	PL-15464
		100/Box	1	PL-15465
Related Parts: PL-15262 (Tilt Key)				
 <p>1/4" Thick</p>	Diecast, R.H.	20/Tub	1	PL-15466
		100/Box	1	PL-15467
Related Parts: PL-15260 (Tilt Key) Fits Wepeco® Windows				
	Diecast, L.H.	20/Tub	1	PL-15468
		100/Box	1	PL-15469
	Diecast, R.H.	20/Tub	1	PL-15470
		100/Box	1	PL-15471
	Diecast, L.H.	20/Tub	1	PL-15396
		100/Box	1	PL-15397
	Diecast, R.H.	20/Tub	1	PL-15398
		100/Box	1	PL-15399
	Diecast, L.H.	20/Tub	1	PL-15476
		100/Box	1	PL-15477
	Diecast, R.H.	20/Tub	1	PL-15478
		100/Box	1	PL-15479

All Items Shown Are Actual Size

SLIDE BOLTS

Description	Pack Qty.	Min. Order Qty.	Part Number
--------------------	------------------	------------------------	--------------------

Diecast, L.H.	20/Tub 100/Box	1 1	PL-15480 PL-15481
----------------------	-------------------	--------	----------------------



Diecast, R.H.	20/Tub 100/Box	1 1	PL-15482 PL-15483
----------------------	-------------------	--------	----------------------



Diecast, L.H.	20/Tub 100/Box	1 1	PL-15484 PL-15485
----------------------	-------------------	--------	----------------------



Diecast, R.H.	20/Tub 100/Box	1 1	PL-15486 PL-15487
----------------------	-------------------	--------	----------------------



Diecast, L.H.	20/Tub 100/Box	1 1	PL-15488 PL-15489
----------------------	-------------------	--------	----------------------



Diecast, R.H.	20/Tub 100/Box	1 1	PL-15490 PL-15491
----------------------	-------------------	--------	----------------------











Diecast, L.H.	20/Tub 100/Box	1 1	PL-15492 PL-15493
----------------------	-------------------	--------	----------------------



Diecast, R.H.	20/Tub 100/Box	1 1	PL-15494 PL-15495
----------------------	-------------------	--------	----------------------









**All Items Shown Are Actual Size**

SLIDE BOLTS

	Description	Pack Qty.	Min. Order Qty.	Part Number
	Diecast, L.H.	20/Tub	1	PL-16040
		100/Box	1	PL-16041
	Diecast, R.H.	20/Tub	1	PL-16042
		100/Box	1	PL-16043
	Diecast, L.H.	20/Tub	1	PL-16050
		100/Box	1	PL-16051
	Diecast, R.H.	20/Tub	1	PL-16052
		100/Box	1	PL-16053
	Diecast, L.H.	20/Tub	1	PL-16074
		100/Box	1	PL-16075
	Diecast, R.H.	20/Tub	1	PL-16076
		100/Box	1	PL-16077
	Diecast, L.H.	20/Tub	1	PL-15388
		100/Box	1	PL-15389
	Diecast, R.H.	20/Tub	1	PL-15390
		100/Box	1	PL-15391

All Items Shown Are Actual Size

SLIDE BOLTS

Description	Pack Qty.	Min. Order Qty.	Part Number	
Diecast, L.H.	20/Tub	1	PL-15392	
	100/Box	1	PL-15393	
Diecast, R.H.	20/Tub	1	PL-15394	
	100/Box	1	PL-15395	
Diecast, L.H.	20/Tub	1	PL-15420	
	100/Box	1	PL-15421	
Diecast, R.H.	20/Tub	1	PL-15422	
	100/Box	1	PL-15423	
Diecast, L.H.	20/Tub	1	PL-15424	
	100/Box	1	PL-15425	
Diecast, R.H.	20/Tub	1	PL-15426	
	100/Box	1	PL-15427	
Diecast, L.H.	20/Tub	1	PL-15496	
	100/Box	1	PL-15497	
Diecast, R.H.	20/Tub	1	PL-15498	
	100/Box	1	PL-15499	

All Items Shown Are Actual Size

SLIDE BOLTS

	Description	Pack Qty.	Min. Order Qty.	Part Number
	Diecast	20/Tub	1	PL-16083
		100/Box	1	PL-16084
	Diecast, L.H.	20/Tub	1	PL-15472
		100/Box	1	PL-15473
	Diecast, R.H.	20/Tub	1	PL-15474
		100/Box	1	PL-15475

All Items Shown Are Actual Size

WINDOW FRAME INSERT CLIPS

Qty.	Min. Order Qty.	Part No.
-------------	------------------------	-----------------

WINDOW FRAME SPRING CORNER - Zinc Plated Spring Steel

25/Tub	1	PL-14861
100/Tub	1	PL-14862
1000/Ctn.	1	PL-14880

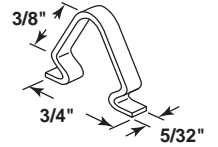

25/Tub	1	PL-14863
100/Tub	1	PL-14864
1000/Ctn.	1	PL-14899

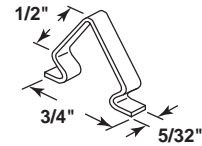

25/Tub	1	PL-14865
100/Tub	1	PL-14866
1000/Ctn.	1	PL-14900

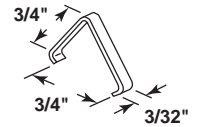

25/Tub	1	PL-14867
100/Tub	1	PL-14868
1000/Ctn.	1	PL-14901

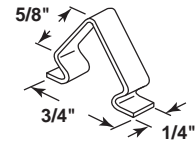

25/Tub	1	PL-14869
100/Tub	1	PL-14870
1000/Ctn.	1	PL-14902

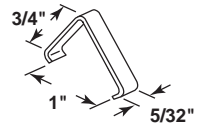

25/Tub	1	PL-14871
100/Tub	1	PL-14872
1000/Ctn.	1	PL-14903

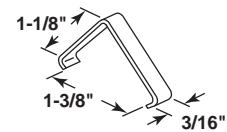

25/Tub	1	PL-14875
100/Tub	1	PL-14876
1000/Ctn.	1	PL-14886

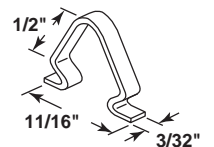

25/Tub	1	PL-14924
100/Tub	1	PL-14925
1000/Ctn.	1	PL-14926

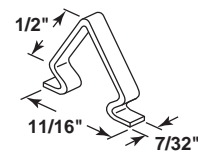

25/Tub	1	PL-14877
100/Tub	1	PL-14878
1000/Ctn.	1	PL-14879

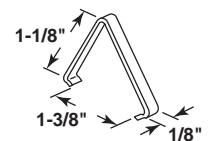

SLIDE BOLTS SPRINGS

Pack Qty.	Min. Order Qty.	Retainer	Part No.	Dim. "A"	Dim. "B"
-----------	-----------------	----------	----------	----------	----------

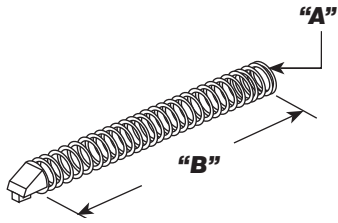

Plated Steel Spring

20/Tub	10	Plastic	PL-14889	.170 O.D.	1-3/16"
100/Tub	10	Plastic	PL-14890		
20/Tub	10	Plastic	PL-14893	.180 O.D.	1-1/2"
100/Tub	10	Plastic	PL-14894		
20/Tub	10	Diecast	PL-14897	.165 O.D.	1-7/16"
100/Tub	10	Diecast	PL-14898		

Plated Steel Spring

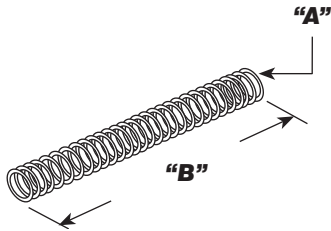

20/Tub	10	—	PL-14891	.170 O.D.	1-3/16"
100/Tub	10	—	PL-14892		
20/Tub	10	—	PL-14895	.165 O.D.	2"
100/Tub	10	—	PL-14896		
20/Tub	10	—	PL-14945	.183 O.D.	7/8"
100/Tub	10	—	PL-14946	.183 O.D.	7/8"

SCREEN CLIPS

Pack Qty.	Min. Order Qty.	With Screws?	Part No.
-----------	-----------------	--------------	----------

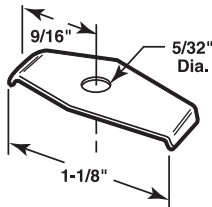

8/Card	6	Yes	PL-8032
25/Tub	1	No	PL-14909
100/Tub	1	No	PL-14910

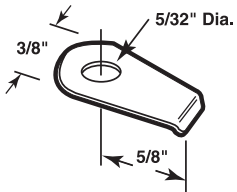

8/Card	6	Yes	PL-8033
25/Tub	1	No	PL-14911
100/Tub	1	No	PL-14912

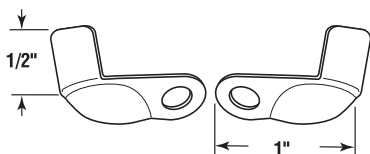

8/Card	6	Yes	PL-8139 (4 Pair)
25/Tub	1	No	PL-14999 (Left Hand)
25/Tub	1	No	PL-15001 (Right Hand)
100/Tub	1	No	PL-15000 (Left Hand)
100/Tub	1	No	PL-15002 (Right Hand)

STRETCH CLIPS

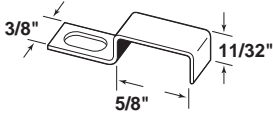
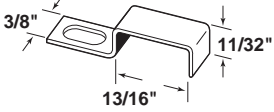
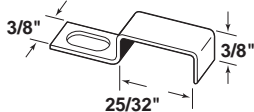
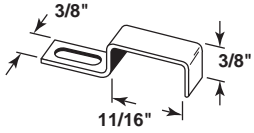
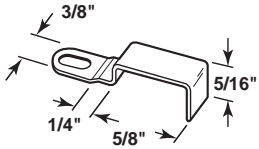
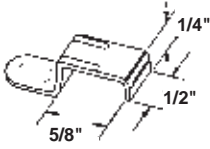
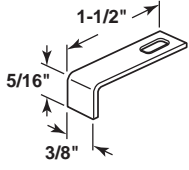





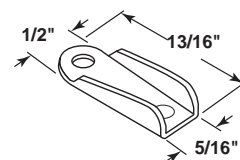

Pack Qty.	Min. Order Qty.	With Screws?	Part No.		
Awning Window Screen Stretch Clips - Aluminum					
12/Card	6	Yes	PL-7970	Most commonly used with 3/8" x 5/8" screen frame	
25/Tub	1	Yes	PL-14689		
100/Tub	1	No	PL-14690		
12/Card	6	Yes	PL-7971	Most commonly used with 5/16" x 3/4" screen frame	
25/Tub	1	Yes	PL-14691		
100/Tub	1	No	PL-14692		
12/Card	6	Yes	PL-7972	Most commonly used with 3/8" x 3/4" screen frame	
25/Tub	1	Yes	PL-14693		
100/Tub	1	No	PL-14694		
12/Card	6	Yes	PL-8028	Most commonly used with 7/16" x 11/16" screen frame	
25/Tub	1	Yes	PL-15738		
100/Tub	1	No	PL-15739		
12/Card	6	Yes	PL-8029	Most commonly used with lip or flange screen frames	
25/Tub	1	Yes	PL-15741		
100/Tub	1	No	PL-15742		
12/Card	6	Yes	PL-8030	Most commonly used with 5/16" x 5/8" Keller window screens	
25/Tub	1	Yes	PL-15744		
100/Tub	1	No	PL-15745		
12/Card	6	Yes	PL-8031	Most commonly used with recessed screen frames	
25/Tub	1	Yes	PL-15747		
100/Tub	1	No	PL-15748		

Flush Screen Clips - Aluminum

12/Card	6	Yes	PL-8009	
25/Tub	1	Yes	PL-15735	
100/Tub	1	No	PL-15736	







DIECAST SCREEN CLIPS

Size	Pack Qty.	Min. Order Qty.	With Screws?	Finish (Part Number)					
				Mill	Black	White	Bronze	Almond	Adobe
 Flush	12/Card	6	Yes	PL-7730	PL-7877	PL-7878	PL-7879	PL-7930	—
	25/Tub	1	Yes	PL-14400	PL-14401	PL-14402	PL-14403	PL-16182	PL-16498
	100/Tub	1	No	PL-14404	PL-14405	PL-14406	PL-14407	PL-16183	PL-16499
	1000/Ctn.	1	No	PL-14408	PL-14409	PL-14410	PL-14411	PL-16184	PL-16500
 1/16"	12/Card	6	Yes	PL-7731	PL-7880	PL-7881	PL-7882	PL-7931	—
	25/Tub	1	Yes	PL-14412	PL-14413	PL-14414	PL-14415	PL-16185	PL-16501
	100/Tub	1	No	PL-14416	PL-14417	PL-14418	PL-14419	PL-16186	PL-16502
	1000/Ctn.	1	No	PL-14420	PL-14421	PL-14422	PL-14423	PL-16187	PL-16503
 1/8"	12/Card	6	Yes	PL-7732	PL-7883	PL-7884	PL-7885	PL-7932	—
	25/Tub	1	Yes	PL-14424	PL-14425	PL-14426	PL-14427	PL-16188	PL-16504
	100/Tub	1	No	PL-14428	PL-14429	PL-14430	PL-14431	PL-16189	PL-16505
	1000/Ctn.	1	No	PL-14432	PL-14433	PL-14434	PL-14435	PL-16190	PL-16506
 3/16"	12/Card	6	Yes	PL-7733	PL-7886	PL-7887	PL-7888	PL-7933	—
	25/Tub	1	Yes	PL-14436	PL-14437	PL-14438	PL-14439	PL-16191	PL-16507
	100/Tub	1	No	PL-14440	PL-14441	PL-14442	PL-14443	PL-16192	PL-16508
	1000/Ctn.	1	No	PL-14444	PL-14445	PL-14446	PL-14447	PL-16193	PL-16509
 1/4"	12/Card	6	Yes	PL-7734	PL-7889	PL-7890	PL-7891	PL-7937	—
	25/Tub	1	Yes	PL-14448	PL-14449	PL-14450	PL-14451	PL-16194	PL-16510
	100/Tub	1	No	PL-14452	PL-14453	PL-14454	PL-14455	PL-16195	PL-16511
	1000/Ctn.	1	No	PL-14456	PL-14457	PL-14458	PL-14459	PL-16196	PL-16512
 5/16"	12/Card	6	Yes	PL-7735	PL-7842	PL-7893	PL-7894	PL-7934	—
	25/Tub	1	Yes	PL-14460	PL-14461	PL-14462	PL-14463	PL-16197	PL-16513
	100/Tub	1	No	PL-14464	PL-14465	PL-14466	PL-14467	PL-16198	PL-16514
	1000/Ctn.	1	No	PL-14468	PL-14469	PL-14470	PL-14471	PL-16199	PL-16515
 3/8"	12/Card	6	Yes	PL-7736	PL-7843	PL-7896	PL-7897	PL-7935	—
	25/Tub	1	Yes	PL-14472	PL-14473	PL-14474	PL-14475	PL-16200	PL-16516
	100/Tub	1	No	PL-14476	PL-14477	PL-14478	PL-14479	PL-16201	PL-16517
	1000/Ctn.	1	No	PL-14480	PL-14481	PL-14482	PL-14483	PL-16202	PL-16518
 7/16"	12/Card	6	Yes	PL-7737	PL-7844	PL-7899	PL-7900	PL-7936	—
	25/Tub	1	Yes	PL-14484	PL-14485	PL-14486	PL-14487	PL-16203	PL-16519
	100/Tub	1	No	PL-14488	PL-14489	PL-14490	PL-14491	PL-16204	PL-16520
	1000/Ctn.	1	No	PL-14492	PL-14493	PL-14494	PL-14495	PL-16205	PL-16521
 1-3/16"	12/Card	6	Yes	PL-7901	PL-7902	PL-7903	PL-7904	PL-7938	—
	25/Tub	1	Yes	PL-14496	PL-14497	PL-14498	PL-14499	PL-16206	PL-16522
	100/Box	1	No	PL-14500	PL-14501	PL-14502	PL-14503	PL-16207	PL-16523
	1000/Ctn.	1	No	PL-14504	PL-14505	PL-14506	PL-14507	PL-16208	PL-16524

PLASTIC SCREEN CLIPS

Size	Pack Qty.	Min. Order Qty.	With Screws?	Color (Part Number)					
				Gray	Black	White	Bronze	Clear	
Flush	12/Card	6	Yes	PL-7905	PL-7906	PL-7738	PL-7907	PL-8121	
	25/Tub	1	Yes	PL-14516	PL-14517	PL-14518	PL-14519	PL-14994	
	100/Tub	1	No	PL-14520	PL-14521	PL-14522	PL-14523	PL-14995	
	1000/Ctn.	1	No	PL-14524	PL-14525	PL-14526	PL-14527	PL-14996	
1/16"	12/Card	6	Yes	PL-7739	PL-7908	PL-7909	PL-7910	—	
	25/Tub	1	Yes	PL-14528	PL-14529	PL-14530	PL-14531	—	
	100/Tub	1	No	PL-14532	PL-14533	PL-14534	PL-14535	—	
	1000/Ctn.	1	No	PL-14536	PL-14537	PL-14538	PL-14539	—	
1/8"	12/Card	6	Yes	PL-8049	PL-8050	PL-8051	PL-8052	—	
	25/Tub	1	Yes	PL-15699	PL-15700	PL-15701	PL-15702	—	
	100/Tub	1	No	PL-15703	PL-15704	PL-15705	PL-15706	—	
	1000/Ctn.	1	No	PL-15707	PL-15708	PL-15709	PL-15710	—	
3/16"	12/Card	6	Yes	PL-7740	PL-7911	PL-7912	PL-7913	—	
	25/Tub	1	Yes	PL-14540	PL-14541	PL-14542	PL-14543	—	
	100/Tub	1	No	PL-14544	PL-14545	PL-14546	PL-14547	—	
	1000/Ctn.	1	No	PL-14548	PL-14549	PL-14550	PL-14551	—	
1/4"	12/Card	6	Yes	PL-7914	PL-7788	PL-7790	PL-7915	—	
	25/Tub	1	Yes	PL-14552	PL-14553	PL-14554	PL-14555	—	
	100/Tub	1	No	PL-14556	PL-14557	PL-14558	PL-14559	—	
	1000/Ctn.	1	No	PL-14560	PL-14561	PL-14562	PL-14563	—	
5/16"	12/Card	6	Yes	PL-7741	PL-7770	PL-7773	PL-7916	—	
	25/Tub	1	Yes	PL-14564	PL-14565	PL-14566	PL-14567	—	
	100/Tub	1	No	PL-14568	PL-14569	PL-14570	PL-14571	—	
	1000/Ctn.	1	No	PL-14572	PL-14573	PL-14574	PL-14575	—	
3/8"	12/Card	6	Yes	PL-7742	PL-7771	PL-7774	PL-7917	—	
	25/Tub	1	Yes	PL-14576	PL-14577	PL-14578	PL-14579	—	
	100/Tub	1	No	PL-14580	PL-14581	PL-14582	PL-14583	—	
	1000/Ctn.	1	No	PL-14584	PL-14585	PL-14586	PL-14587	—	
7/16"	12/Card	6	Yes	PL-7743	PL-7772	PL-7775	PL-7918	—	
	25/Tub	1	Yes	PL-14588	PL-14589	PL-14590	PL-14591	—	
	100/Tub	1	No	PL-14592	PL-14593	PL-14594	PL-14595	—	
	1000/Ctn.	1	No	PL-14596	PL-14597	PL-14598	PL-14599	—	
1-1/8"	25/Tub	1	Yes	PL-16529	PL-16532	PL-16535	PL-16538	PL-16541	
	100/Tub	1	No	PL-16530	PL-16533	PL-16536	PL-16539	PL-16542	
	1000/Ctn.	1	No	PL-16531	PL-16534	PL-16537	PL-16540	PL-16543	
1-3/16"	25/Tub	1	Yes	PL-15711	PL-16544	PL-16547	PL-16550	PL-16553	
	100/Tub	1	No	PL-15715	PL-16545	PL-16548	PL-16551	PL-16554	
	1000/Ctn.	1	No	PL-15719	PL-16546	PL-16549	PL-16552	PL-16555	

ALUMINUM CASEMENT CLIPS

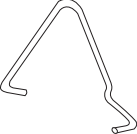
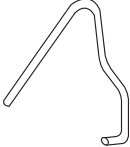
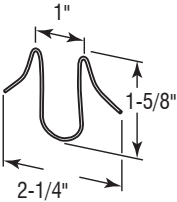
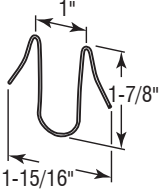
	Size	Pack Qty.	Min Order Qty.	With Screws?	Part Number
	5/16"	12/Card	6	Yes	PL-7744
		25/Tub	1	Yes	PL-14600
		100/Tub	1	No	PL-14601
		1000/Ctn.	1	No	PL-14602
	3/8"	12/Card	6	Yes	PL-7745
		25/Tub	1	Yes	PL-14603
		100/Tub	1	No	PL-14604
		1000/Ctn.	1	No	PL-14605
	7/16"	12/Card	6	Yes	PL-7746
		25/Tub	1	Yes	PL-14606
		100/Tub	1	No	PL-14607
		1000/Ctn.	1	No	PL-14608
	7/8"	12/Card	6	Yes	PL-7747
		25/Tub	1	Yes	PL-14609
		100/Tub	1	No	PL-14610
		1000/Ctn.	1	No	PL-14611
	1-3/16"	12/Card	6	Yes	PL-7748
		25/Tub	1	Yes	PL-14612
		100/Box	1	No	PL-14613
		1000/Ctn.	1	No	PL-14614
RAMS HORN CLIP - SPRING STEEL					
		50/Tub	1	—	PL-14853
		250/Tub	1	—	PL-14854
		1000/Ctn.	1	—	PL-14855
STEEL SASH WINDOW GLAZING CLIP - SPRING STEEL					
		50/Tub	1	—	PL-14856
		250/Tub	1	—	PL-14857
		1000/Ctn.	1	—	PL-14858
ALUMINUM SASH WINDOW GLAZING CLIP - SPRING STEEL					
		50/Tub	1	—	PL-14883
		250/Tub	1	—	PL-14884
		1000/Ctn.	1	—	PL-14885
AUTO-LOCK SPRING					
		50/Tub	1	—	PL-16588
		250/Tub	1	—	PL-16589
		1000/Ctn.	1	—	PL-16590
		50/Tub	1	—	PL-16591
		250/Tub	1	—	PL-16592
		1000/Ctn.	1	—	PL-16593

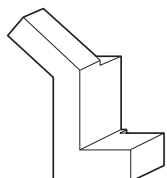

Pack Qty.	Min. Order Qty.	Material	Part Number
WINDOW CLIPS - White (Fits Acorn Windows)			
25/Tub	1	Plastic	PL-15190
100/Tub	1	Plastic	PL-15191
1000/Ctn.	1	Plastic	PL-15192

SCREEN FRAME FASTENERS

Pack Qty.	Min. Order Qty.	With Screws?	Material	Color (Part Number)		
				Black	White	Clear

DOUBLE WING CLIPS

12/Card	6	Yes	Plastic	PL-7975	PL-7749	—
25/Tub	1	Yes	Plastic	PL-15726	PL-14615	—
100/Tub	1	No	Plastic	PL-15727	PL-14616	—
1000/Ctn.	1	No	Plastic	PL-15728	PL-14617	—



FLUSH PANEL CLIPS

8/Card	6	Yes	Nylon	—	PL-7919	—
25/Tub	1	Yes	Nylon	—	PL-14634	—
100/Tub	1	No	Nylon	—	PL-14635	—
1000/Ctn.	1	No	Nylon	—	PL-14636	—

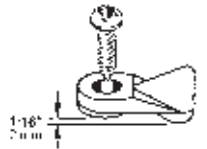

8/Card	6	Yes	Nylon	—	—	PL-8034
25/Tub	1	Yes	Nylon	—	—	PL-15750
100/Tub	1	No	Nylon	—	—	PL-15751
1000/Ctn.	1	No	Nylon	—	—	PL-15752

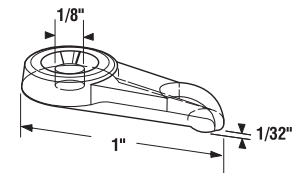

TURN BUTTONS

12/Card	6	Yes	Nylon	—	PL-7920	—
25/Tub	1	Yes	Nylon	—	PL-14637	—
100/Tub	1	No	Nylon	—	PL-14638	—
1000/Ctn.	1	No	Nylon	—	PL-14639	—

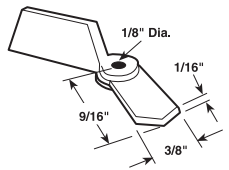

POINTER LATCHES

6/Card	6	Yes	Plastic	PL-8170	PL-8169	—
25/Tub	1	Yes	Plastic	PL-16459	PL-16456	—
100/Tub	1	No	Plastic	PL-16460	PL-16457	—
1000/Ctn.	1	No	Plastic	PL-16461	PL-16458	—

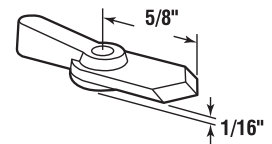

TOP AND BOTTOM CLIPS

8/Card=4 Sets	6	—	Plastic	PL-7765	—	4 Sets: 4 Tops, 4 Bottoms
25 Sets per Tub	1	—	Plastic	PL-14632	—	1 Set: 1 Top, 1 Bottom
100 Sets per Box	1	—	Plastic	PL-14633	—	1 Set: 1 Top, 1 Bottom

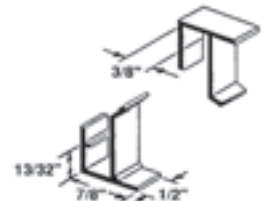

SCREEN FRAME FASTENERS

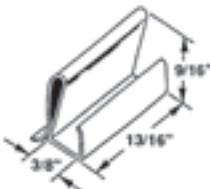
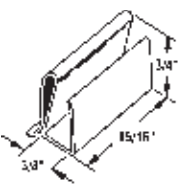
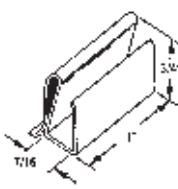
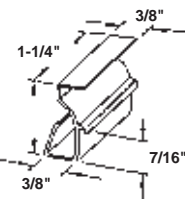
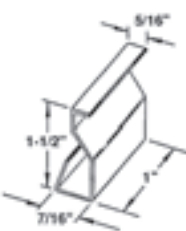
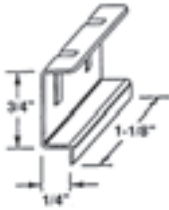
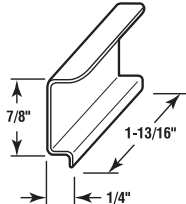
Pack Qty.	Min. Order Qty.	Material	Color (Part Number)			
			Metal	Black	White	
RETAINER CLIPS - For 3/8" Frame						
	6/Card	6	Spring Steel	PL-7750	—	—
	25/Tub	1	Spring Steel	PL-15540	—	—
	100/Box	1	Spring Steel	PL-15541	—	—
RETAINER CLIPS - (For 3/8" or 7/16" Frame)						
	6/Card	6	Plastic	—	PL-7752	—
	25/Tub	1	Plastic	—	PL-15544	—
	100/Box	1	Plastic	—	PL-15545	—
RETAINER CLIPS - For 7/16" Frame						
	6/Card	6	Spring Steel	PL-7751	—	—
	25/Tub	1	Spring Steel	PL-15542	—	—
	100/Box	1	Spring Steel	PL-15543	—	—
LIFT & RETAINER CLIPS - (For 3/8" Frame)						
	6/Card	6	Plastic	—	PL-7753	—
	25/Tub	1	Plastic	—	PL-15546	—
	100/Box	1	Plastic	—	PL-15547	—
LIFT CLIPS - (For 7/16" Frame)						
	6/Card	6	Plastic	—	PL-7754	—
	25/Tub	1	Plastic	—	PL-15548	—
	100/Box	1	Plastic	—	PL-15549	—
SPLINE CHANNEL PULL TABS						
	6/Card	6	Aluminum	PL-7755	—	—
	25/Tub	1	Aluminum	PL-15550	—	—
	100/Box	1	Aluminum	PL-15551	—	—
	2/Card	6	Aluminum	PL-8110	—	—
	25/Tub	1	Aluminum	PL-16008	—	PL-16010

SCREEN FRAME FASTENERS

Pack Qty.	Min. Order Qty.	Material	Color (Part Number)			
			Black	White	Gray	Clear

SPLINE CHANNEL PULL TABS

6/Card	6	Plastic	PL-8144	—	PL-8143	—
6/Card	6	Plastic	PL-8035	PL-8151	—	PL-8168
25/Tub	1	Plastic	PL-15753	PL-16450	—	PL-16453
100/Tub	1	Plastic	PL-15754	PL-16451	—	PL-16454
1000/Ctn	1	Plastic	PL-15755	PL-16452	—	PL-16455
6/Card	6	Plastic	PL-7921	PL-7756	PL-8142	—
25/Tub	1	Plastic	PL-14621	PL-14618	—	—
100/Tub	1	Plastic	PL-14622	PL-14619	—	—
1000/Ctn.	1	Plastic	PL-14623	PL-14620	—	—

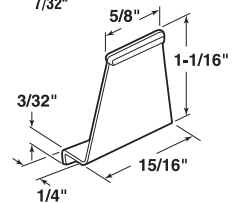
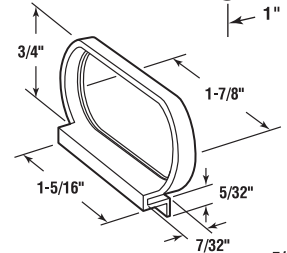
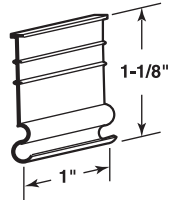

Pack Qty.	Min. Order Qty.	Part Number
-----------	-----------------	-------------

RETAINER CLIPS - Clear Plastic

4/Card	6	PL-8084
100/Box	1	PL-14905
4/Card	6	PL-8085
100/Box	1	PL-14906
4/Card	6	PL-8086
100/Box	1	PL-14907
4/Card	6	PL-8087
100/Box	1	PL-14908

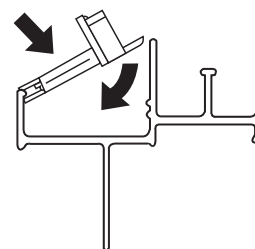
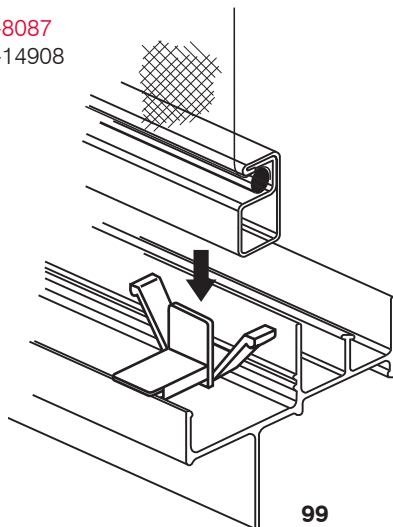
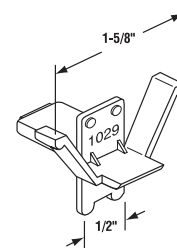
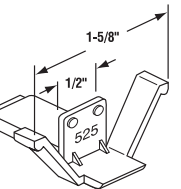
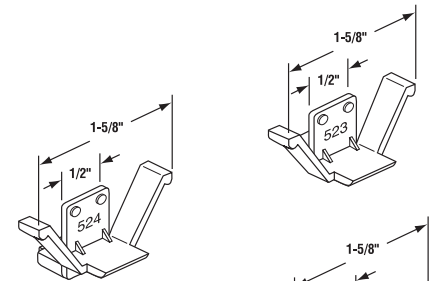

SCREEN FRAME FASTENERS

Pack Qty.	Min. Order Qty.	Material	Part Number
-----------	-----------------	----------	-------------

FLAT SPRINGS

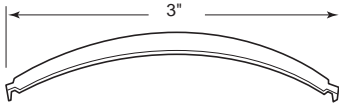

6/Card	6	Spring Steel	PL-7758
25/Tub	1	Spring Steel	PL-14624
100/Tub	1	Spring Steel	PL-14625
1000/Ctn.	1	Spring Steel	PL-15552

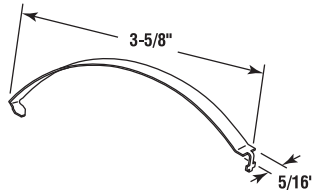

25/Tub	1	Spring Steel	PL-15961
100/Tub	1	Spring Steel	PL-15962
1000/Ctn.	1	Spring Steel	PL-15963

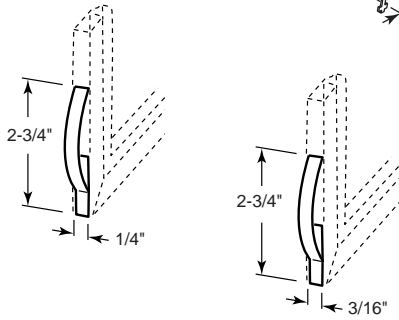

1/4"			
6/Card	6	Spring Steel	PL-7776
25/Tub	1	Spring Steel	PL-14630
100/Tub	1	Spring Steel	PL-14631
1000/Ctn.	1	Spring Steel	PL-15554

3/16"			
25/Tub	1	Spring Steel	PL-16440

WIRE SPRINGS

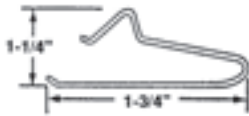

12/Card	6	Spring Steel	PL-7759
25/Tub	1	Spring Steel	PL-14626
100/Tub	1	Spring Steel	PL-14627
1000/Ctn.	1	Spring Steel	PL-15553

CONE SPRINGS



6/Card	6	Spring Steel	PL-7922
25/Tub	1	Spring Steel	PL-14628
100/Tub	1	Spring Steel	PL-14629

SPRING CLIP

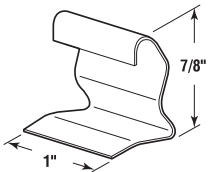

100/Tub	1	Spring Steel	PL-15729
---------	---	--------------	----------

Pack Qty.	Min. Order Qty.	Part Number
-----------	-----------------	-------------

BOTTOM LATCH SPRINGS - Stainless Steel

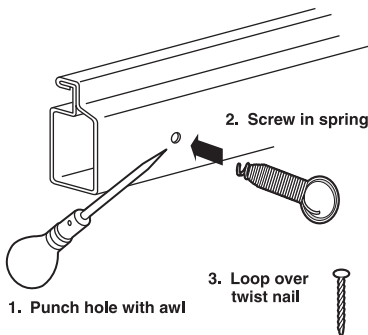

25/Tub	1	PL-14741
100/Tub	1	PL-14742
1000/Box	1	PL-14743
25/Tub	1	PL-14744
100/Tub	1	PL-14745
1000/Box	1	PL-14746
25/Tub	1	PL-14747
100/Tub	1	PL-14748
1000/Box	1	PL-14749

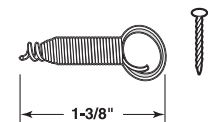
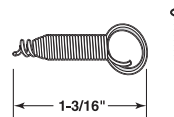
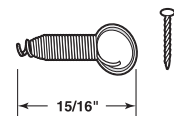

SCREEN FRAME FASTENERS

Pack Qty.	Min Order Qty.	With Fasteners?	Material	Finish	Part Number
(4) HANGERS & (2) LATCHES - For 7/16" Frame (2 Sets)					
Carded	6	Yes	Aluminum	Mill	PL-7760
Carded	6	Yes	Aluminum	Bronze	PL-7846
Carded	6	Yes	Aluminum	White	PL-7847
Carded	6	Yes	Aluminum	Gray	PL-7849

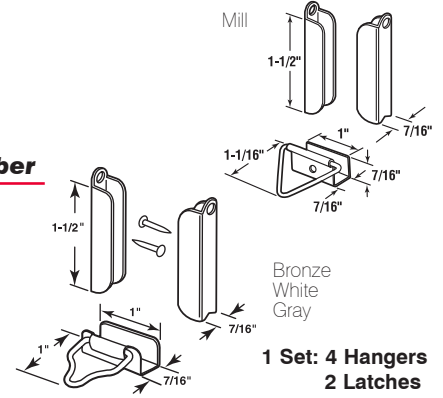

(2) HANGERS & (2) LATCHES - For 7/16" Frame Over 36" Wide

25 Sets/Box	1	Yes	Aluminum	Mill	PL-14640
100 Sets/Box	1	Yes	Aluminum	Mill	PL-14641
25 Sets/Box	1	Yes	Aluminum	Bronze	PL-14642
100 Sets/Box	1	Yes	Aluminum	Bronze	PL-14643
25 Sets/Box	1	Yes	Aluminum	White	PL-14644
100 Sets/Box	1	Yes	Aluminum	White	PL-14645
25 Sets/Box	1	Yes	Aluminum	Gray	PL-15559
100 Sets/Box	1	Yes	Aluminum	Gray	PL-15560

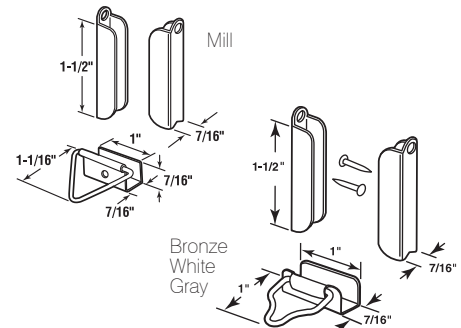

(2) HANGERS & (1) LATCH - For 7/16" Frame

25 Sets/Box	1	Yes	Aluminum	Mill	PL-14646
100 Sets/Box	1	Yes	Aluminum	Mill	PL-14647
25 Sets/Box	1	Yes	Aluminum	Bronze	PL-14648
100 Sets/Box	1	Yes	Aluminum	Bronze	PL-14649
25 Sets/Box	1	Yes	Aluminum	White	PL-14650
100 Sets/Box	1	Yes	Aluminum	White	PL-14651
25 Sets/Box	1	Yes	Aluminum	Gray	PL-15561
100 Sets/Box	1	Yes	Aluminum	Gray	PL-15562

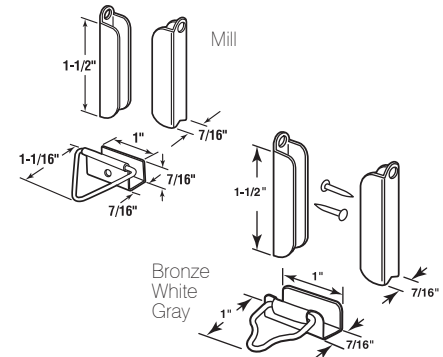

(2) HANGERS & (1) LATCH - For 3/8" Frame

Carded	6	Yes	Aluminum	Mill	PL-8101
Carded	6	Yes	Aluminum	Bronze	PL-8102
Carded	6	Yes	Aluminum	White	PL-8103

1 Set: 2 Hangers
1 Latch

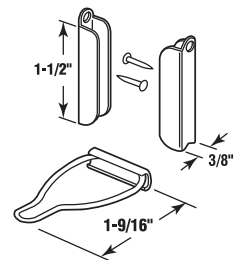

TOP HANGERS - For 3/8" Frame

6/Card	6	Yes	Aluminum	Mill	PL-8104
10 pr./Tub	10	Yes	Aluminum	Mill	PL-16011
100 pr./Box	10	No	Aluminum	Mill	PL-16013
6/Card	6	Yes	Aluminum	Bronze	PL-8105
10 pr./Tub	10	Yes	Aluminum	Bronze	PL-16012
100 pr./Box	10	No	Aluminum	Bronze	PL-16130
6/Card	6	Yes	Aluminum	White	PL-8106
10 pr./Tub	10	Yes	Aluminum	White	PL-14652
100 pr./Box	10	No	Aluminum	White	PL-14653

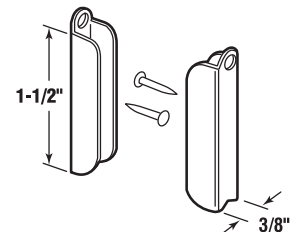

SCREEN FRAME FASTENERS

Pack Qty.	Min. Order Qty.	With Fasteners?	Material	Finish	Part Number
-----------	-----------------	-----------------	----------	--------	-------------

TOP HANGERS - For 7/16" Frame

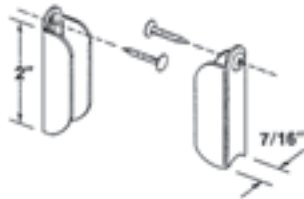

6/Card	6	Yes	Aluminum	Mill	PL-7761
10 pr./Tub	10	Yes	Aluminum	Mill	PL-14654
100 pr./Box	10	No	Aluminum	Mill	PL-14655
6/Card	6	Yes	Aluminum	Bronze	PL-8122
10 pr./Tub	10	Yes	Aluminum	Bronze	PL-15563
100 pr./Box	10	No	Aluminum	Bronze	PL-15564
6/Card	6	Yes	Aluminum	White	PL-7845
10 pr./Tub	10	Yes	Aluminum	White	PL-15565
100 pr./Box	10	No	Aluminum	White	PL-15566
10 pr./Tub	10	Yes	Aluminum	Gray	PL-15567
100 pr./Box	10	No	Aluminum	Gray	PL-15568

BOTTOM LATCHES - For 7/16" Frame

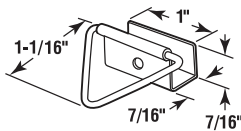

4/Card	6	Yes	Aluminum	Mill	PL-7762
25/Tub	1	Yes	Aluminum	Mill	PL-14656
100/Box	1	No	Aluminum	Mill	PL-14657

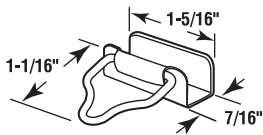

4/Card	6	Yes	Aluminum	Bronze	PL-8135
25/Tub	1	Yes	Aluminum	Bronze	PL-15569
100/Box	1	No	Aluminum	Bronze	PL-15570
4/Card	6	Yes	Aluminum	White	PL-8136
25/Tub	1	Yes	Aluminum	White	PL-15571
100/Box	1	No	Aluminum	White	PL-15572
25/Tub	1	Yes	Aluminum	Gray	PL-15573
100/Box	1	No	Aluminum	Gray	PL-15574

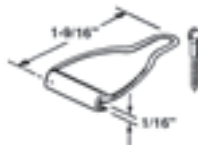

SPLINE CHANNEL BAIL LATCHES - Mill

4/Card	6	Yes	Aluminum	—	PL-7768
25/Tub	1	Yes	Aluminum	—	PL-14658
100/Tub	1	No	Aluminum	—	PL-14659

PLUNGER LATCHES - For 3/4" x 1/4" (or 5/16") Frame



6/Card	6	—	Nylon	—	PL-7924
25/Tub	1	—	Nylon	—	PL-14663
100/Tub	1	—	Nylon	—	PL-14664
1000/Ctn.	1	—	Nylon	—	PL-14665

PLUNGER LATCHES - For 3/4" x 3/8" (or 7/16") Frame (Nylon Cap)

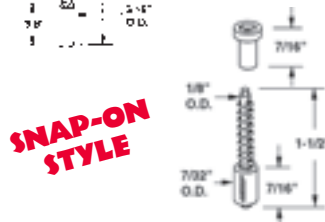

6/Card	6	—	Diecast	—	PL-7925
25/Tub	1	—	Diecast	—	PL-14660
100/Tub	1	—	Diecast	—	PL-14661
1000/Ctn.	1	—	Diecast	—	PL-14662

PLUNGER LATCHES - For 3/4" x 3/8" (or 7/16") Frame

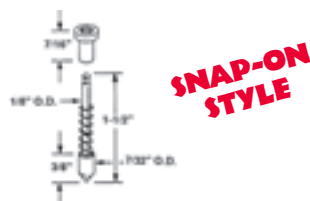

6/Card	6	—	Nylon	—	PL-7777
25/Tub	1	—	Nylon	—	PL-14666
100/Tub	1	—	Nylon	—	PL-14667
1000/Ctn.	1	—	Nylon	—	PL-14668

SCREEN FRAME FASTENERS

Pack Qty.	Min. Order Qty.	With Fasteners?	Material	Part Number	Handing
-----------	-----------------	-----------------	----------	-------------	---------

PLUNGER LATCHES - For 3/4" x 3/8" (or 7/16") Frame

6/Card	6	—	Aluminum	PL-7985	—
25/Tub	1	—	Aluminum	PL-14846	—
100/Tub	1	—	Aluminum	PL-14847	—
1000/Ctn.	1	—	Aluminum	PL-14848	—

NAIL SET STYLE

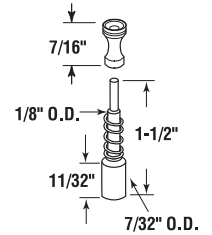

PLUNGER LATCHES - For 3/4" x 5/16" & 3/8" Frame

100/Tub	6	—	Aluminum	PL-16470	—
---------	---	---	----------	----------	---

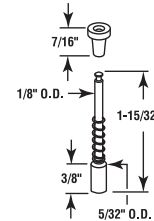

SNAP-ON STYLE

PLUNGER LATCHES - For 3/4" x 1/4" & 5/16" Frame

100/Tub	6	—	Nylon	PL-16478	—
---------	---	---	-------	----------	---

SNAP-ON STYLE

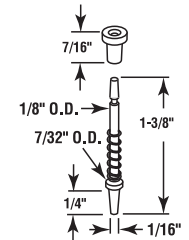

PLUNGER LATCHES - For 1" x 7/16" Frame (Nylon Cap)

6/Card	6	—	Diecast	PL-7926	—
25/Tub	1	—	Diecast	PL-14669	—
100/Tub	1	—	Diecast	PL-14670	—
1000/Ctn.	1	—	Diecast	PL-14671	—

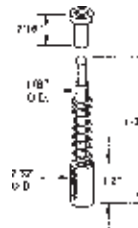

SNAP-ON STYLE

PLUNGER LATCHES - For 1" x 7/16" Frame

6/Card	6	—	Aluminum	PL-7986	—
25/Tub	1	—	Aluminum	PL-14849	—
100/Tub	1	—	Aluminum	PL-14850	—
1000/Ctn.	1	—	Aluminum	PL-14851	—

NAIL SET STYLE

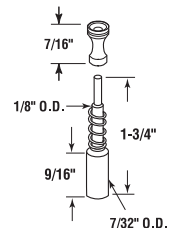

KNIFE LATCHES

3 Pairs/Card	6	—	Aluminum	PL-8153	Left/Right
25/Tub	1	—	Aluminum	PL-14672	Right
100/Tub	1	—	Aluminum	PL-14673	Right
25/Tub	1	—	Aluminum	PL-14674	Left
100/Tub	1	—	Aluminum	PL-14675	Left

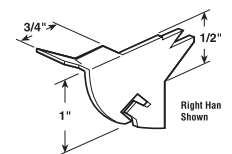
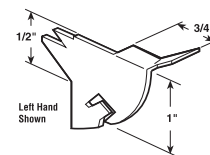

25 pr./Tub	1	—	Aluminum	PL-14881	Right/Left
100 pr./Tub	1	—	Aluminum	PL-14882	Right/Left



20/Tub	1	—	Aluminum	PL-16116	Right/Left
100/Tub	1	—	Aluminum	PL-16117	Right/Left

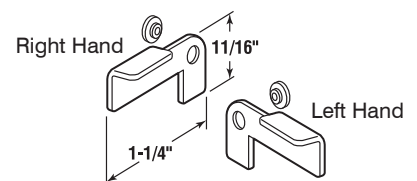

SCREEN FRAME FASTENERS

Pack Qty.	Min Order Qty.	Material	Part Number
-----------	----------------	----------	-------------

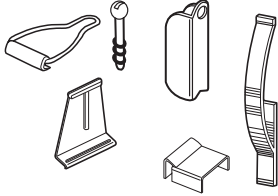

HANGER KIT

1 Set/Card	6	Steel	PL-8141
------------	---	-------	---------

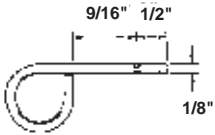

LOCK PINS - For All 3/4" Frames

6/Card	6	Steel	PL-7766
25/Tub	1	Steel	PL-14676
100/Tub	1	Steel	PL-14677

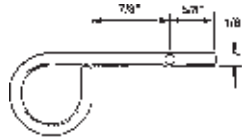

LOCK PINS - For All 1" Frames

6/Card	6	Steel	PL-7927
25/Tub	1	Steel	PL-14678
100/Tub	1	Steel	PL-14679



SLIDE LOCKS - For 3/4" Frames

6/Card	6	Aluminum	PL-7987
25/Tub	1	Aluminum	PL-14687
100/Tub	1	Aluminum	PL-14688

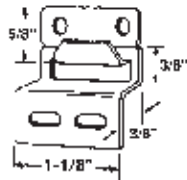

TOP HANGERS

4 Sets/Card	6	Aluminum	PL-8006
25 Sets/Tub	1	Aluminum	PL-14723
100 Sets/Tub	1	Aluminum	PL-14724

1 Set: 1 Hook
1 Keeper

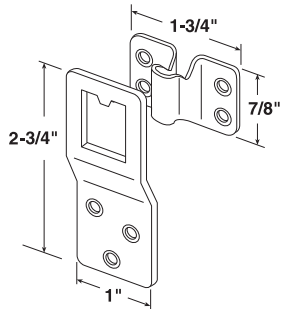

TOP HANGERS

2 Sets/Card	6	Steel	PL-8007
25 Sets/Tub	1	Steel	PL-14725
100 Sets/Box	1	Steel	PL-14726

1 Set: 1 Hook
1 Keeper

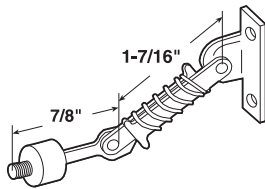

AWNING WINDOW LINK

2/Card	6	Aluminum	PL-7929
25/Box	1	Aluminum	PL-14683

Call For
Availability

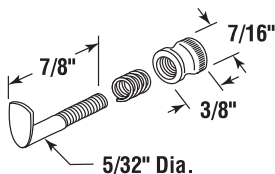

CASEMENT SCREEN LOCK

2/Card	6	Aluminum	PL-7928
25/Tub	1	Aluminum	PL-14681

SCREEN FRAME FASTENERS

Pack Qty.	Min Order Qty.	Length	Finish	Part Number
-----------	----------------	--------	--------	-------------

CASEMENT SCREEN LOCK

4/Card	6	9/16"	White	T-8742
4/Card	6	9/16"	Tan	T-8744
4/Card	6	11/16"	White	T-8743
4/Card	6	11/16"	Tan	T-8745

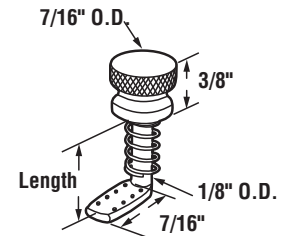

FASTENERS

Size	Pack Qty.	Min Order Qty.	Finish (Part Number)	
			Mill	Black

PHILLIPS PAN HEAD MACHINE SCREWS

10-24 x 5/8"	100/Tub	1	PL-14731 (Zinc)	PL-14735
10-24 x 3/4"	100/Tub	1	PL-14732 (Zinc)	PL-14736
10-24 x 1-1/4"	100/Tub	1	PL-14733 (Zinc)	PL-14737
10-24 x 1-5/8"	100/Tub	1	PL-14734 (Zinc)	PL-14738

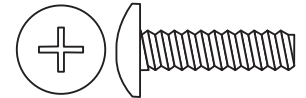

PHILLIPS PAN HEAD SHEET METAL SCREWS

8 X 1/2"	100/Tub	1	PL-14727	—
8 X 3/4"	100/Tub	1	PL-14728	—

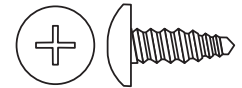

PHILLIPS PAN HEAD WINDOW FRAME CORNER SCREW

4 X 1/4"	25/Tub	1	PL-15266	—
	100/Tub	1	PL-15267	—

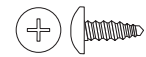

BALL HEAD SCREWS

1"	100/Tub	1	PL-14705	—
	1000/Ctn.	1	PL-14706	—



RING SHANK

3/4" X 14 GA.	1000/Ctn.	1	PL-14708	—
---------------	-----------	---	----------	---



BINDER POST - ALUMINUM

8-32	25/Tub	1	PL-16048	—
	100/Tub	1	PL-16049	—

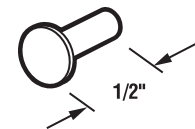

WINDOW GRID RETAINERS

Pack Qty.	Min. Order Qty.	Part Number	Material
6/Card	6	PL-7976	Clear plastic with steel pin
25/Tub	1	PL-15675	
100/Tub	1	PL-15676	

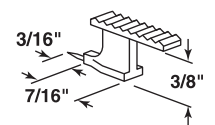

6/Card	6	PL-7977	Clear plastic with steel pin
25/Tub	1	PL-15677	
100/Tub	1	PL-15678	

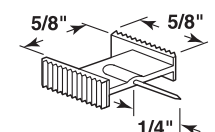

WINDOW GRID RETAINERS

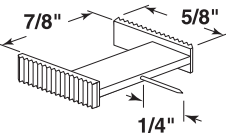
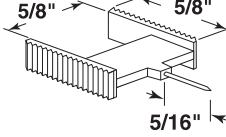
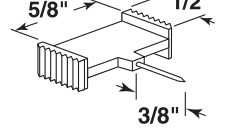
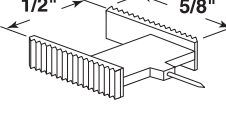
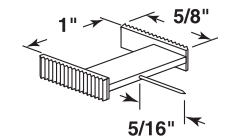
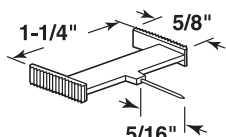
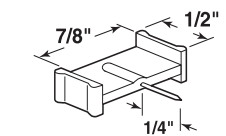
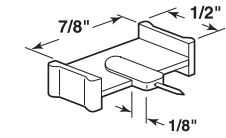
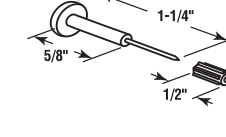
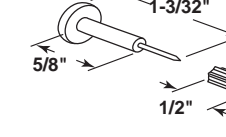
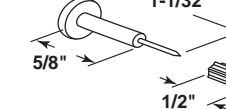
	Pack Qty.	Min. Order Qty.	Part Number	Material
	6/Card 25/Tub 100/Tub	6 1 1	PL-7981 PL-15679 PL-15680	Clear plastic with steel pin
	6/Card 25/Tub 100/Tub	6 1 1	PL-7978 PL-15681 PL-15682	Clear plastic with steel pin
	6/Card 25/Tub 100/Tub	6 1 1	PL-7979 PL-15683 PL-15684	Clear plastic with steel pin
	6/Card 25/Tub 100/Tub	6 1 1	PL-8167 PL-16435 PL-16436	Clear plastic with steel pin
	6/Card 25/Tub 100/Tub	6 1 1	PL-7982 PL-15691 PL-15692	Clear plastic with steel pin
	6/Card 25/Tub 100/Tub	6 1 1	PL-8140 PL-16174 PL-16175	Clear plastic with steel pin
	6/Card 25/Tub 100/Tub	6 1 1	PL-7980 PL-15697 PL-15698	Clear plastic with steel pin
	6/Card 25/Tub 100/Tub	6 1 1	PL-8149 PL-16393 PL-16394	Clear plastic with steel pin
	6/Card 25/Tub 100/Tub	6 1 1	PL-8461 PL-16479 PL-16480	Clear plastic with steel pin and retainer sleeve
	6/Card 25/Tub 100/Tub	6 1 1	PL-7983 PL-15685 PL-15686	Clear plastic with steel pin and retainer sleeve
	6/Card 25/Tub 100/Tub	6 1 1	PL-7988 PL-15687 PL-15688	Clear plastic with steel pin and retainer sleeve

WINDOW GRID RETAINERS

Pack Qty.	Min. Order Qty.	Part Number	Material
6/Card	6	PL-7989	Clear plastic with steel pin and retainer sleeve
25/Tub	1	PL-15689	
100/Tub	1	PL-15690	
6/Card	6	PL-7984	Clear plastic
25/Tub	1	PL-15695	
6/Card	6	PL-8113	Clear plastic
25/Tub	1	PL-16003	
100/Tub	1	PL-16004	

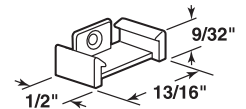
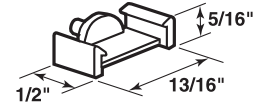
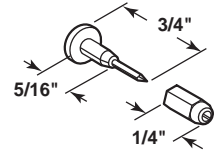

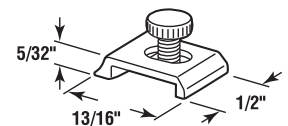
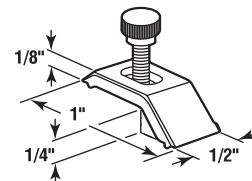
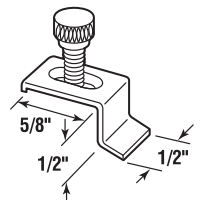
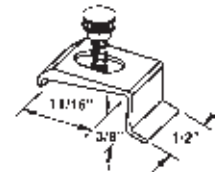
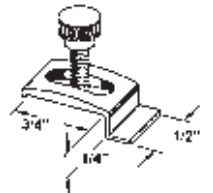
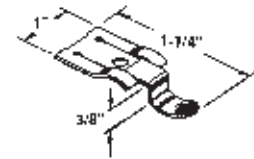

STORM DOOR PANEL CLIPS

Pack Qty.	Min. Order Qty.	With Screws?	Part Number		
			Mill	White	Zinc
4/Card	6	—	—	—	PL-7968
25/Tub	1	—	—	—	PL-15555
100/Tub	1	—	—	—	PL-15556
8/Card	6	Yes	PL-7939	PL-7940	—
25/Tub	1	No	PL-14750	PL-14753	—
100/Tub	1	No	PL-14751	PL-14754	—
1000/Ctn.	1	No	PL-14752	PL-14755	—
8/Card	6	Yes	PL-7941	PL-7942	—
25/Tub	1	No	PL-14756	PL-14759	—
100/Tub	1	No	PL-14757	PL-14760	—
1000/Ctn.	1	No	PL-14758	PL-14761	—
8/Card	6	Yes	PL-8111	—	—
25/Tub	1	No	PL-15986	—	—
100/Tub	1	No	PL-15987	—	—
1000/Ctn.	1	No	PL-15988	—	—
8/Card	6	Yes	PL-7961	—	—
25/Tub	1	No	PL-14816	—	—
100/Tub	1	No	PL-14817	—	—
1000/Ctn.	1	No	PL-14818	—	—
8/Card	6	Yes	PL-7962	—	—
25/Tub	1	No	PL-14819	—	—
100/Tub	1	No	PL-14820	—	—
1000/Ctn.	1	No	PL-14821	—	—

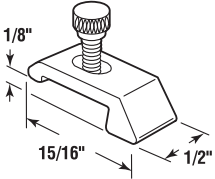
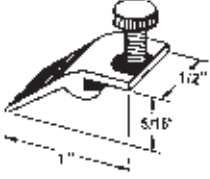
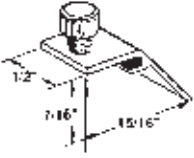
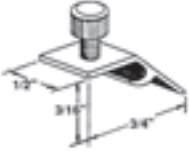
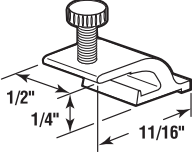
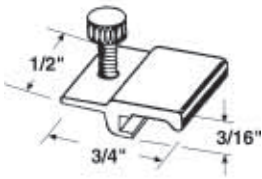

STORM DOOR PANEL CLIPS

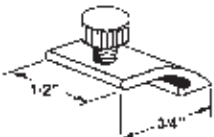
	Pack Qty.	Min. Order Qty.	With Screws?	Part Number		
				Mill	White	Zinc
	8/Card	6	Yes	PL-8150	—	—
	25/Tub	1	Yes	PL-16395	—	—
	100/Tub	1	No	PL-16396	—	—
	1000/Ctn.	1	No	PL-16397	—	—
	8/Card	6	Yes	PL-7947	PL-7948	—
	25/Tub	1	Yes	PL-14774	PL-14777	—
	100/Tub	1	No	PL-14775	PL-14778	—
	1000/Ctn.	1	No	PL-14776	PL-14779	—
	8/Card	6	Yes	PL-7949	PL-7950	—
	25/Tub	1	Yes	PL-14780	PL-14783	—
	100/Tub	1	No	PL-14781	PL-14784	—
	1000/Ctn.	1	No	PL-14782	PL-14785	—
	8/Card	6	Yes	PL-7951	PL-7952	—
	25/Tub	1	Yes	PL-14786	PL-14789	—
	100/Tub	1	No	PL-14787	PL-14790	—
	1000/Ctn.	1	No	PL-14788	PL-14791	—
	8/Card	6	Yes	PL-7953	PL-7954	—
	25/Tub	1	Yes	PL-14792	PL-14795	—
	100/Tub	1	No	PL-14793	PL-14796	—
	1000/Ctn.	1	No	PL-14794	PL-14797	—
	8/Card	6	Yes	PL-7959	PL-7960	—
	25/Tub	1	Yes	PL-14810	PL-14813	—
	100/Tub	1	No	PL-14811	PL-14814	—
	1000/Ctn.	1	No	PL-14812	PL-14815	—
	8/Card	6	Yes	PL-7957	PL-7958	—
	25/Tub	1	Yes	PL-14804	PL-14807	—
	100/Tub	1	No	PL-14805	PL-14808	—
	1000/Ctn.	1	No	PL-14806	PL-14809	—
	8/Card	6	Yes	PL-7955	PL-7956	—
	25/Tub	1	Yes	PL-14798	PL-14801	—
	100/Tub	1	No	PL-14799	PL-14802	—
	1000/Ctn.	1	No	PL-14800	PL-14803	—

STORM DOOR PANEL CLIPS

Pack Qty.	Min. Order Qty.	With Screws?	Part Number		
			Mill	White	
8/Card	6	—	PL-7945	PL-7946	—
25/Tub	1	—	PL-14768	PL-14771	—
100/Tub	1	—	PL-14769	PL-14772	—
1000/Ctn.	1	—	PL-14770	PL-14773	—

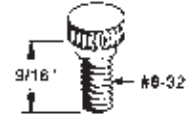

8/Card	6	—	PL-7943	PL-7944 (Nylon)	
25/Tub	1	—	PL-14762	PL-14765 (Nylon)	
100/Tub	1	—	PL-14763	PL-14766 (Nylon)	
1000/Ctn.	1	—	PL-14764	PL-14767 (Nylon)	

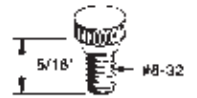

6/Card	6	Yes	PL-7967	—	
25/Tub	1	No	PL-14843	—	
100/Tub	1	No	PL-14844	—	
1000/Ctn.	1	No	PL-14845	—	



8/Card	6	Yes	PL-7966	—	
25/Tub	1	No	PL-14840	—	
100/Tub	1	No	PL-14841	—	
1000/Ctn.	1	No	PL-14842	—	

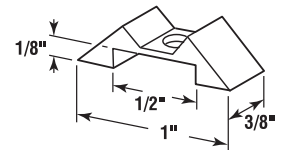

8/Card	6	Yes	PL-7965	—	
25/Tub	1	No	PL-14828	—	
100/Tub	1	No	PL-14829	—	
1000/Ctn.	1	No	PL-14830	—	



8/Card	6	No	—	PL-7964 (Nylon)	
25/Tub	1	No	—	PL-14825 (Nylon)	
100/Tub	1	No	—	PL-14826 (Nylon)	
1000/Ctn.	1	No	—	PL-14827 (Nylon)	

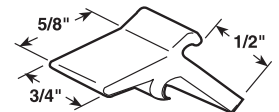

25/Tub	1	—	PL-14859	—	
100/Tub	1	—	PL-14860	—	

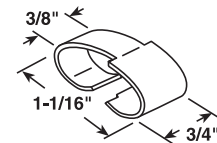

25/Tub	1	—	—	PL-16068	
100/Tub	1	—	—	PL-16069	

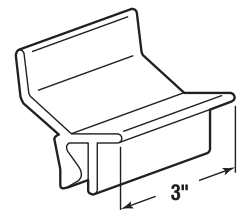

Sliding KD Screen Door Kits

Designed to "OPEN WITH ONE FINGER"

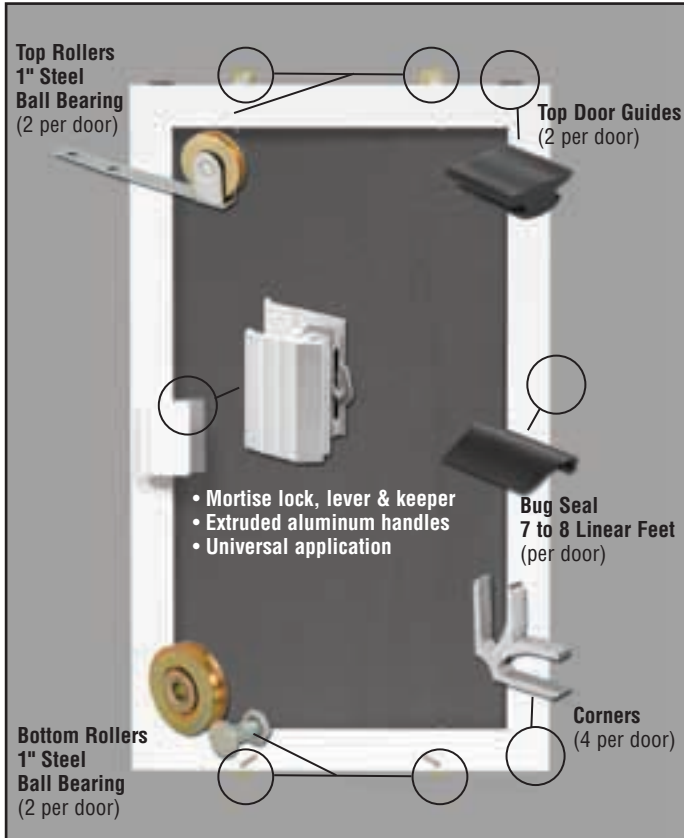

Ultimate I (1-3/4")

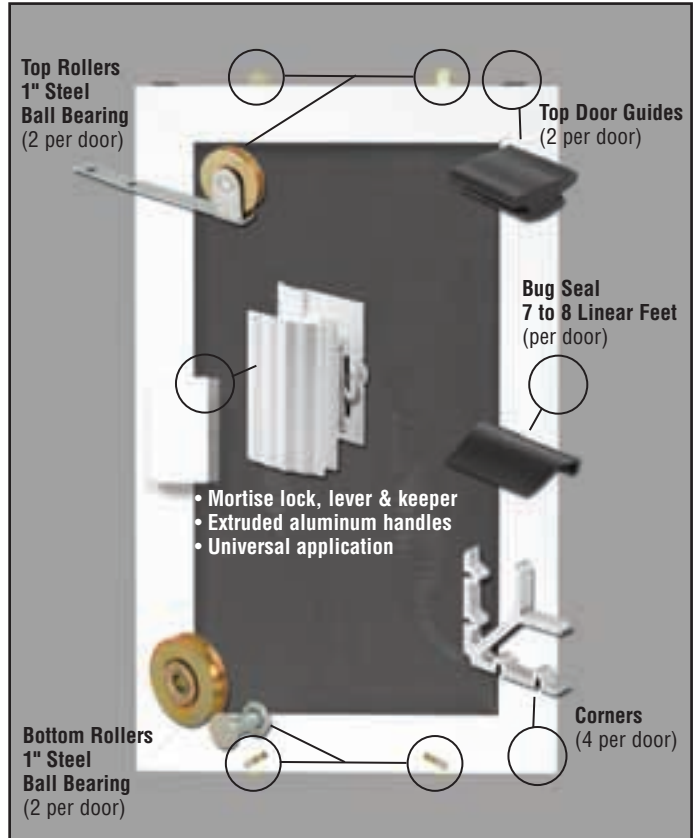

Ultimate II (2-1/2")

Ultimate I

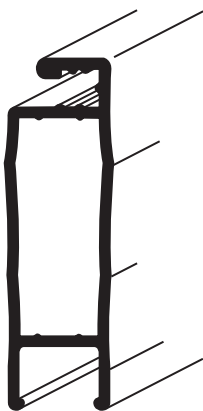

1-3/4"

Actual Size

Ultimate II

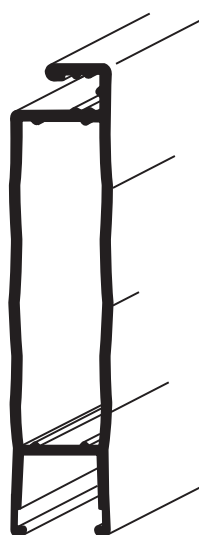

2-1/2"

ULTIMATE I & II SLIDING KD SCREEN DOOR KITS

Kits Available In:

- 2 Styles (1-3/4" & 2-1/2" wide frame)
- 3 Colors (anodized aluminum, white and bronze)
- 31", 37", 43", 49" and 61" max. widths
- 81" or 98" max. height kits

Features:

- Extruded aluminum
- Extruded frame is pre-punched for handle and rollers
- Decorative fluted side walls
- Extruded aluminum interlocking corners
- Uses bug seal B-716 (See page 43)
- Complete with all necessary rollers and hardware
- Individually packaged
- Screen cloth and spline are not included
- Kits are shipped un-assembled and square cut

SLIDING KD SCREEN DOOR KITS

Max. Width	Max. Height	Satin Anodized	Painted Finish (Part Number)			
			Bronze	White	Almond	Adobe

ULTIMATE I - EXTRUDED ALUMINUM (1-3/4")

31"	81"	PL-14364	PL-14370	PL-14376	—	—
37"	81"	PL-14365	PL-14371	PL-14377	—	—
43"	81"	PL-14343	PL-14344	PL-14345	—	—
49"	81"	PL-14366	PL-14372	PL-14378	—	—
61"	81"	PL-14367	PL-14373	PL-14379	—	—
<hr/>						
37"	98"	PL-14368	PL-14374	PL-14380	PL-16525	PL-16527
49"	98"	PL-14369	PL-14375	PL-14381	PL-16526	PL-16528
61"	98"	PL-15760	PL-15761	PL-15762	—	—

- Use spline size: .190 (Aluminum mesh) or .200 (Fiberglass mesh)

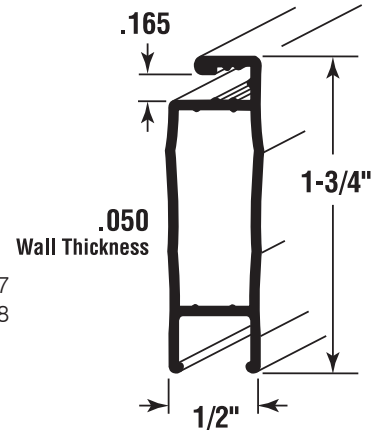

ULTIMATE II - EXTRUDED ALUMINUM (2-1/2")

31"	81"	PL-14382	PL-14388	PL-14394	—	—
37"	81"	PL-14383	PL-14389	PL-14395	—	—
43"	81"	PL-14346	PL-14347	PL-14348	—	—
49"	81"	PL-14384	PL-14390	PL-14396	—	—
61"	81"	PL-14385	PL-14391	PL-14397	—	—
<hr/>						
31"	98"	PL-15768	PL-15769	PL-15770	—	—
37"	98"	PL-14386	PL-14392	PL-14398	—	—
43"	98"	PL-15918	PL-15919	PL-15920	—	—
49"	98"	PL-14387	PL-14393	PL-14399	—	—
61"	98"	PL-15763	PL-15764	PL-15765	—	—

- Use spline size: .190 (Aluminum mesh) or .200 (Fiberglass mesh)

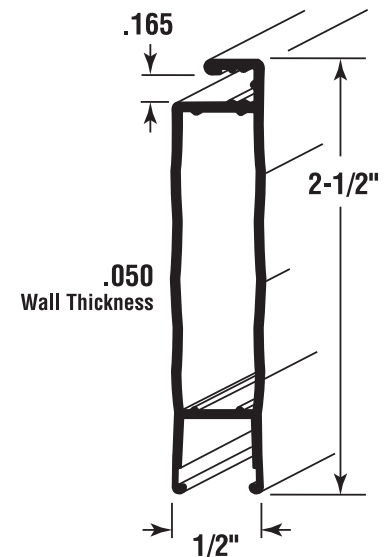

Ask About Our Custom Cut Program

Pack Qty.	Min. Order Qty.	Size	Gray	Bronze	White
-----------	-----------------	------	------	--------	-------

UNIVERSAL TOP SCREEN DOOR CHANNEL - EXTRUDED ALUMINUM

6/Ctn	6	72"	PL-16134	PL-16135	PL-16136
-------	---	-----	----------	----------	----------

- Used to establish a top sliding channel on doors that used top hung roller systems.

ORDER FULL CAR TDNS ONLY

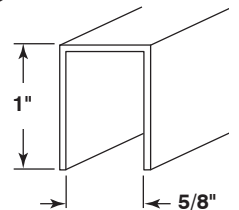

Pack Qty.	Min. Order Qty.	Satin Aluminum	Bronze	White
-----------	-----------------	----------------	--------	-------

OUTSIDE PULL

10/Ctn	1	PL-16425	PL-16426	PL-16427
--------	---	----------	----------	----------

ORDER FULL CAR TDNS ONLY

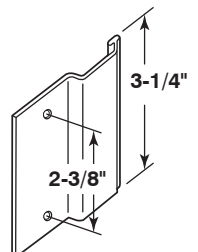

**ORDER
FULL CARBONS
ONLY**

PATIO DOOR REPAIR TRACK

Pack Qty. Length Material Part Number

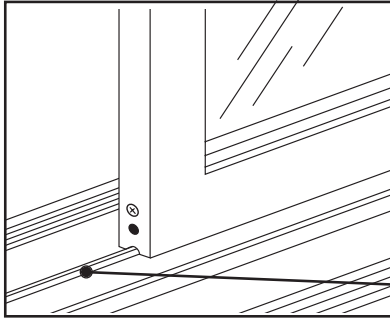

REPAIR TRACK - Allows patio door to roll smoothly and quietly

12 pcs./tube	6'	Stainless Steel	PL-15575
12 pcs./tube	8'	Stainless Steel	PL-15576
12 pcs./tube	12'	Stainless Steel	PL-16464

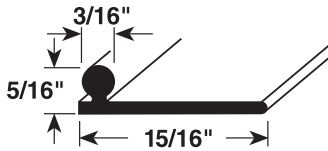
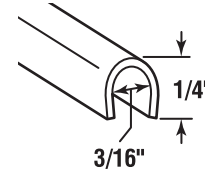

SLIDING PATIO DOOR TRACK

12 pcs./tube	6'	Aluminum	PL-15577
12 pcs./tube	6'	Bronze	PL-15578
12 pcs./tube	6'	White	PL-16215
12 pcs./tube	8'	Aluminum	PL-15579
12 pcs./tube	8'	Bronze	PL-15580
12 pcs./tube	8'	White	PL-16216

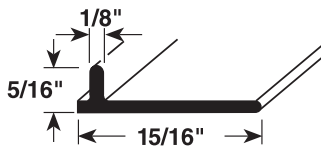

SLIDING SCREEN DOOR TRACK

12 pcs./tube	6'	Aluminum	PL-15581
12 pcs./tube	6'	Bronze	PL-15582
12 pcs./tube	6'	White	PL-16217
12 pcs./tube	8'	Aluminum	PL-15583
12 pcs./tube	8'	Bronze	PL-15584
12 pcs./tube	8'	White	PL-16218

Complete Threshold Replacement Kits Available; Ask Customer Service

Using simple installation instructions, you can replace the glass track or screen track economically and quickly without a complex sill replacement.

SLIDING SCREEN DOOR TRACK

SLIDING PATIO DOOR TRACK

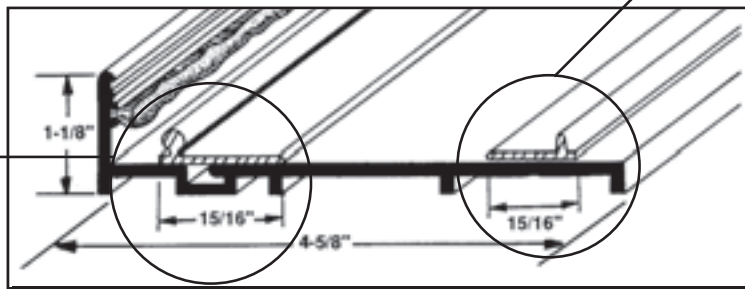

Inside Slider Installation

SPECIALITY TOOLS

ACCU-RULE MEASURING STICK (PATENT PENDING)

- Quickly and accurately measures vertical sliding screen door dimensions in the patio door opening.
- Two (2) piece (extruded aluminum) adjustable measuring tool.
- Locking knob holds firm while overall measurement is read.
- Multiple vertical dimensions are needed to determine ideal screen door height.

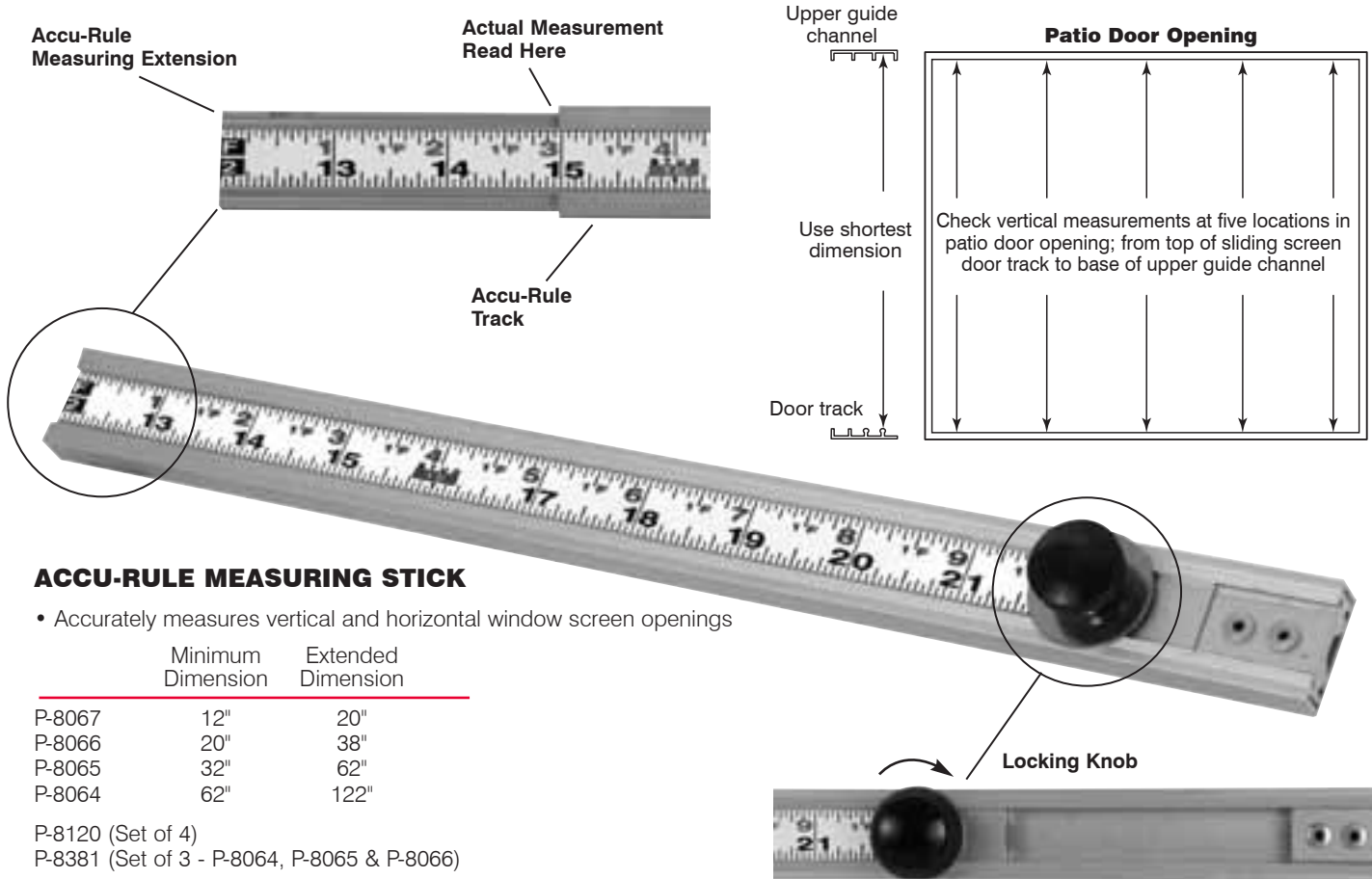

ACCU-RULE MEASURING STICK

- Accurately measures vertical and horizontal window screen openings

	Minimum Dimension	Extended Dimension
P-8067	12"	20"
P-8066	20"	38"
P-8065	32"	62"
P-8064	62"	122"
P-8120 (Set of 4)		
P-8381 (Set of 3 - P-8064, P-8065 & P-8066)		

HOW TO MAKE NEW SCREENS THE CORRECT SIZE THE FIRST TIME

- STEP 1:** Give customer our new "How-To Measure Your Screens" brochure.
- STEP 2:** Secure collateral from customer to take home the "Accu-Rule" measuring stick set and measuring guide brochure.
- STEP 3:** Make customer's new screens to their exact measured sizes.

ELIMINATE RETURNS AND WRONG SIZE PROBLEMS

ZZ-313



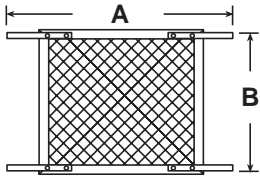

SWINGING SCREEN/STORM DOOR GRILLES

Fits Door Size	Actual Grille Size		Finish (Part Number)		
	"A"	"B"	Mill	Bronze	White

ORDER FULL CAR TONS ONLY

ALUMINUM SWINGING SCREEN DOOR GRILLES (Western Style)

30"	28"	27-1/2"	PL-15500	PL-15502	PL-15503
32"	31"	27-1/2"	PL-15505	PL-15507	PL-15508
36"	35"	27-1/2"	PL-15510	PL-15512	PL-15513

- Various widths allow for maximum screen coverage.
- Pack Quantity - 1
- 6 Per Carton

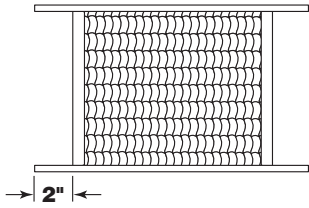

Color (Part Number)

Mill	Satin	Bronze	White	Black
------	-------	--------	-------	-------

ALUMINUM SWINGING SCREEN / STORM DOOR GRILLES (Eastern Style)

30", 32" & 36"	34-1/2"	16-3/4"	PL-15925	PL-15926	PL-15929	PL-15928	PL-15927
30", 32" & 36"	33-1/2"	24"	PL-15930	PL-15931	PL-15934	PL-15933	—
30", 32" & 36"	34-1/2"	24-5/8"	—	—	—	—	PL-15932

- Trim Brackets To Size
- Pack Quantity - 1
- 6 Per Carton

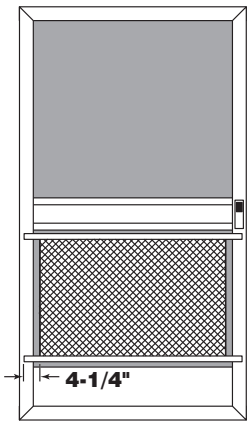

Color (Part Number)

Gray	Bronze	White
------	--------	-------

PLASTIC MOLDED SWINGING SCREEN / STORM DOOR GRILLES

—	34-1/2"	20"	PL-15515	PL-15516	PL-15517	—	PL-15518
---	---------	-----	----------	----------	----------	---	----------

- One size fits all.
- Pack Quantity - 1
- 6 Per Carton

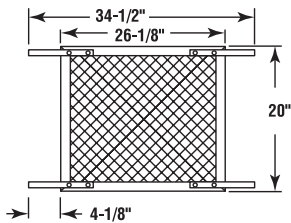

- Choice of 3 types of grilles
- Aluminum grilles available in 4 finishes
- Molded grilles available in 3 colors

- Easy installation - screws provided
- Helps prevent screen fabric damage or glass damage
- Adds strength to entire door

SCREEN AND STORM DOOR PUSH BAR

Pack Qty	Finish (Part Number)		
	Gray	White	Brown
6/Box	K-5166	K-5167	K-5186

- Fits up to a 36" wide door
- Can be cut to size
- Vinyl bars with aluminum re-inforcement and plastic ends

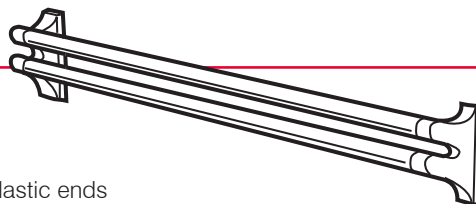

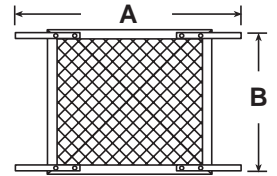

SLIDING SCREEN DOOR GRILLES

Fits Door Size	Actual Grille Size		Finish (Part Number)		
	"A"	"B"	Mill	Bronze	White

ORDER FULL CAR DOORS ONLY

ALUMINUM SLIDING SCREEN DOOR GRILLES (Western Style)

30"	30"	33"	PL-15519	PL-15521	PL-15522
36"	36"	33"	PL-15524	PL-15526	PL-15527
48"	48"	33"	PL-15529	PL-15531	PL-15532

- Pack Quantity - 1
- 3 Per Carton

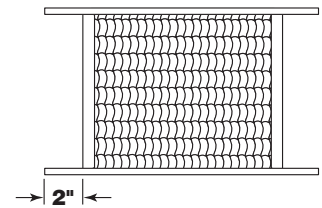

Mill	Color (Part Number)		
	Satin	White	Dark Brown

ALUMINUM SLIDING SCREEN DOOR GRILLES (Eastern Style)

36"	36"	25-3/4"	PL-15935	PL-15936	PL-15937	PL-15938
-----	-----	---------	----------	----------	----------	----------

- Pack Quantity - 1
- 3 Per Carton

48"	48"	30"	PL-15939	PL-15940	PL-15941	PL-15942
-----	-----	-----	----------	----------	----------	----------

- Pack Quantity - 1
- 3 Per Carton

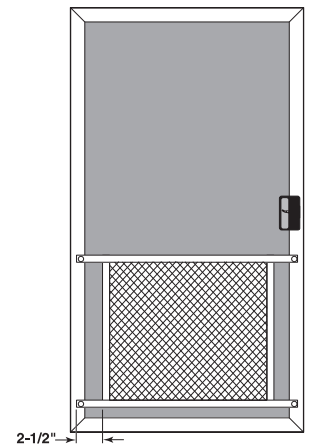

- Aluminum grilles available in 4 finishes
- Easy installation - screws provided
- Helps prevent screen fabric damage
- Adds strength to entire door

SLIDING SCREEN DOOR CLOSER

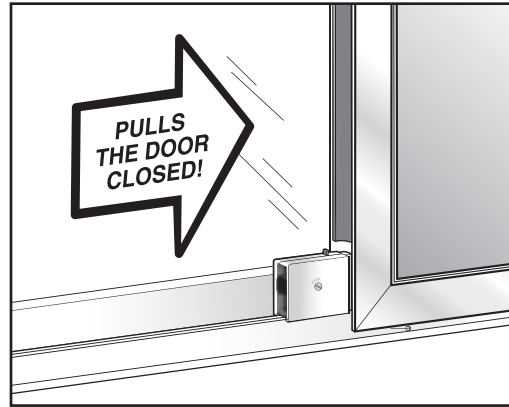
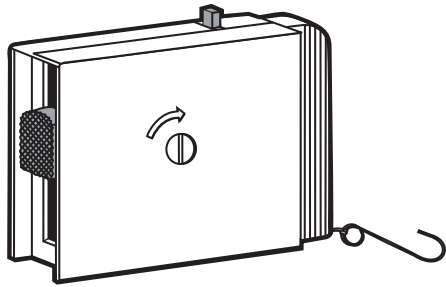

Pack Qty	Finish (Part Number)	
	Bronze	White
1/Card	B-784	B-757

- Easy to install
- Automaticall closes
- Adjustable tension
- Keeps bugs out

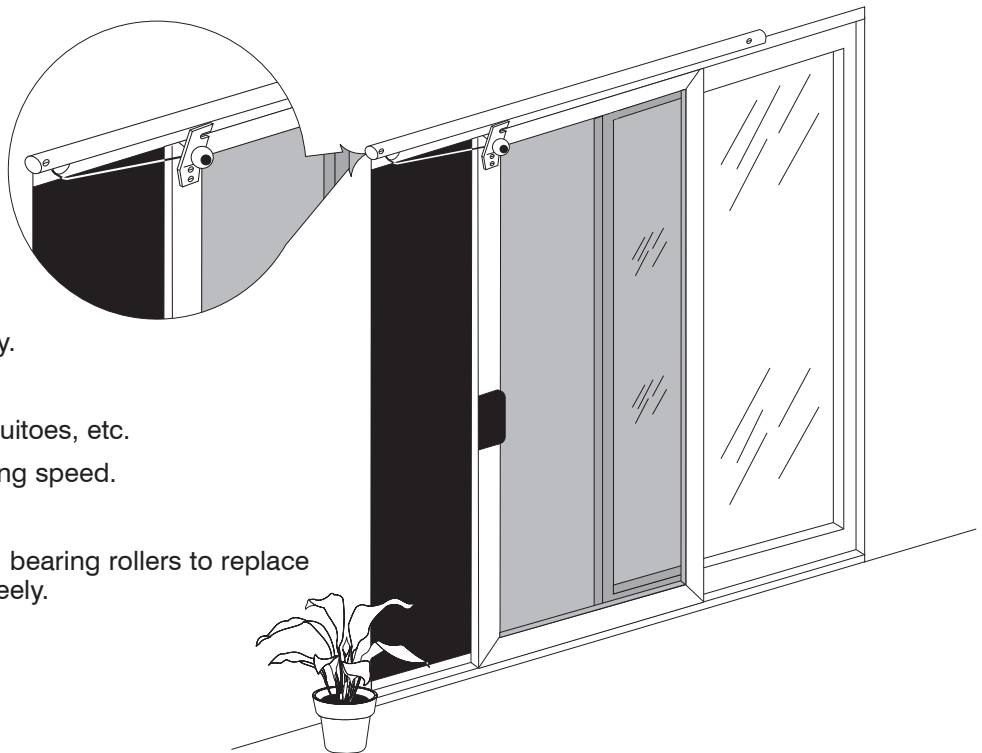

- Closes screen doors automatically.
- Reliable and durable.
- Helps keep out flies, moths mosquitoes, etc.
- Fully adjustable tension and closing speed.
- Paintable aluminum construction.
- Supplied with 2—1-1/4" nylon ball bearing rollers to replace rollers on doors that do not roll freely.

Strength	Tube		Finish (Part Number)		
	Length	Diameter	Satin Aluminum	Bronze	White
Standard duty	61"	1"	PL-15535	PL-15536	PL-15537
Light duty	61"	1"	PL-15723	PL-15724	PL-15725

SUPPORT MATERIALS

P.O.P. MINI SLIDING SCREEN DOOR DISPLAY ZZ-127

- Actual working display
- Sample doors include:
 - Ultimate **I** (1-7/8" frame)
 - Ultimate **II** (2-1/2" frame)
- Includes 50 measuring guides (**ZZ-125**) and rack
- Signage included
- Fully assembled

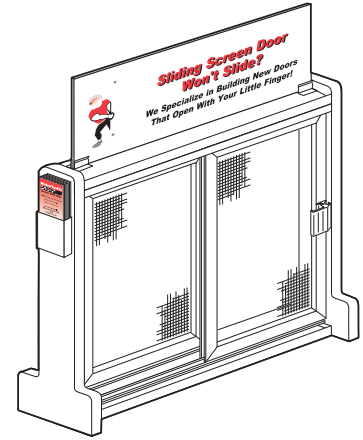

Counter Display
30-1/2" high x 31" wide x 8-1/2" deep

GRILLE RACK ZZ-306

- Wire racks are available for use with existing pegboard.
- Rack holds 9 grilles.

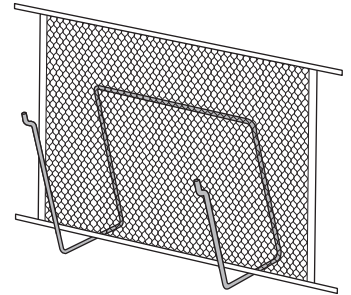

PEGBOARD GRILLE HOLDERS ZZ-286

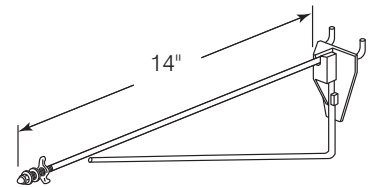

HOW-TO MEASURE YOUR SCREEN BROCHRE ZZ-313

- 30 Pack

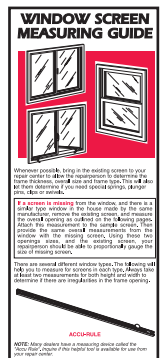

MAKE-TO-FIT INSTRUCTION BROCHURE P-7847



SUPPORT MATERIALS



**2' X 8' BANNER
P-8080**

- Yellow with black lettering
- Indoor / outdoor applications
- Grommeted holes



**BACKROOM WINDOW & SCREEN REPAIR SHOP MANUAL
ZZ-98**

- Detailed, step by step, instructions covering all aspects of window screen and glass repair
- Shop layouts for any size facility
- Pricing charts for screen and glass repair
- New screening techniques to improve profitability



**HOW-TO DVD VIDEO (MTF, screening, fasteners, kd doors)
ZZ-328**

- Excellent training videos
- Use in conjunction with shop manual
- New and improved screening techniques for both the novice or the professional

Screen Style	Glazing Channel	Glazing Spline	Right Hand
223A-18"	UW 223A-20272	SW 223A-20272	223A-20272
223A-20"	UW 223A-20272	SW 223A-20272	223A-20272
223A-22"	UW 223A-20272	SW 223A-20272	223A-20272
223A-24"	UW 223A-20272	SW 223A-20272	223A-20272
223A-26"	UW 223A-20272	SW 223A-20272	223A-20272
223A-28"	UW 223A-20272	SW 223A-20272	223A-20272
223A-30"	UW 223A-20272	SW 223A-20272	223A-20272
223A-32"	UW 223A-20272	SW 223A-20272	223A-20272
223A-34"	UW 223A-20272	SW 223A-20272	223A-20272
223A-36"	UW 223A-20272	SW 223A-20272	223A-20272
223A-38"	UW 223A-20272	SW 223A-20272	223A-20272
223A-40"	UW 223A-20272	SW 223A-20272	223A-20272
223A-42"	UW 223A-20272	SW 223A-20272	223A-20272
223A-44"	UW 223A-20272	SW 223A-20272	223A-20272
223A-46"	UW 223A-20272	SW 223A-20272	223A-20272
223A-48"	UW 223A-20272	SW 223A-20272	223A-20272
223A-50"	UW 223A-20272	SW 223A-20272	223A-20272
223A-52"	UW 223A-20272	SW 223A-20272	223A-20272
223A-54"	UW 223A-20272	SW 223A-20272	223A-20272
223A-56"	UW 223A-20272	SW 223A-20272	223A-20272
223A-58"	UW 223A-20272	SW 223A-20272	223A-20272
223A-60"	UW 223A-20272	SW 223A-20272	223A-20272
223A-62"	UW 223A-20272	SW 223A-20272	223A-20272
223A-64"	UW 223A-20272	SW 223A-20272	223A-20272
223A-66"	UW 223A-20272	SW 223A-20272	223A-20272
223A-68"	UW 223A-20272	SW 223A-20272	223A-20272
223A-70"	UW 223A-20272	SW 223A-20272	223A-20272
223A-72"	UW 223A-20272	SW 223A-20272	223A-20272
223A-74"	UW 223A-20272	SW 223A-20272	223A-20272
223A-76"	UW 223A-20272	SW 223A-20272	223A-20272
223A-78"	UW 223A-20272	SW 223A-20272	223A-20272
223A-80"	UW 223A-20272	SW 223A-20272	223A-20272
223A-82"	UW 223A-20272	SW 223A-20272	223A-20272
223A-84"	UW 223A-20272	SW 223A-20272	223A-20272
223A-86"	UW 223A-20272	SW 223A-20272	223A-20272
223A-88"	UW 223A-20272	SW 223A-20272	223A-20272
223A-90"	UW 223A-20272	SW 223A-20272	223A-20272
223A-92"	UW 223A-20272	SW 223A-20272	223A-20272
223A-94"	UW 223A-20272	SW 223A-20272	223A-20272
223A-96"	UW 223A-20272	SW 223A-20272	223A-20272
223A-98"	UW 223A-20272	SW 223A-20272	223A-20272
223A-100"	UW 223A-20272	SW 223A-20272	223A-20272

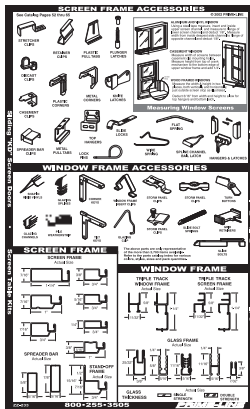

**BACK ROOM SELECTION GUIDE
ZZ-233**

Handy tool covers:

- Frame sizes
- Fasteners
- Spline sizes
- How to measure for window screens
- Great for discussing new or re-screen and glazing requirements with customer

**BACK ROOM SHOP APRON
ZZ-124**

- Red canvas with white lettering
- Pockets
- Back ties
- 30" overall length



**CAMPAIN BUTTON FOR SCREENS
ZZ-140**

- Highly visible button promotes screen repair.



**BUMPER STICKER
ZZ-305**

- 3" x 10-1/2"



MAKE - TO - FIT

Merchandising Tools (Signs and Wire Racks)

Merchandise Kit

PL-7798

- (4) Make-to-fit screen racks
- (1) Make-to-fit laminated card (ZZ-11)
- (4) Push pin sign holders (ZZ-62)
- (2) Top mount sign brackets (ZZ-46)
- (2) Laminated screen frame sign (ZZ-466)

Merchandise Kit

PL-7799

- (6) Make-to-fit screen racks
- (1) Make-to-fit laminated card (ZZ-11)
- (4) Push pin sign holders (ZZ-62)
- (2) Top mount sign brackets (ZZ-46)
- (3) Laminated screen frame sign (ZZ-466)

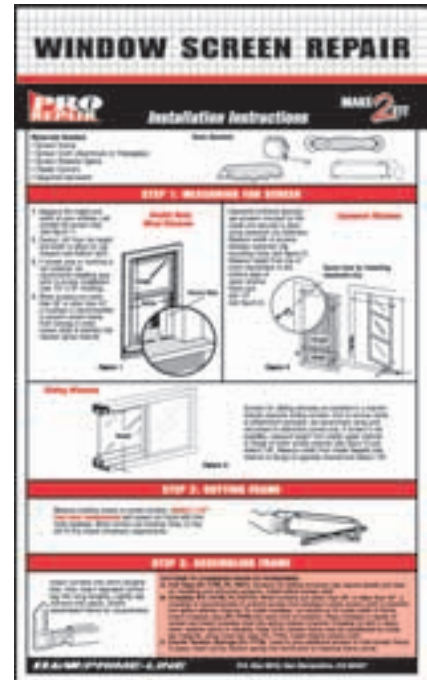
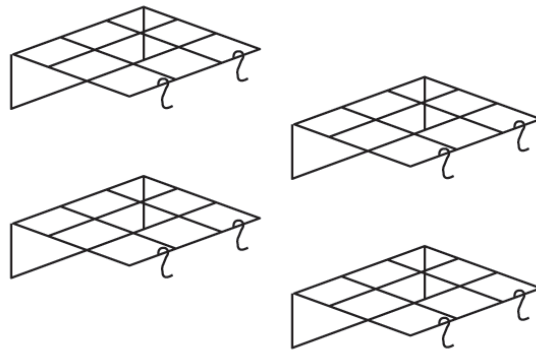

Part Number: ZZ-11
Laminated "How-To" Sign



Part Number: ZZ-466
Laminated Screen Frame Sign

SCREEN REPAIR PROGRAM
SOUTHERN CALIFORNIA, ARIZONA REGION
48" Wide X 63" High

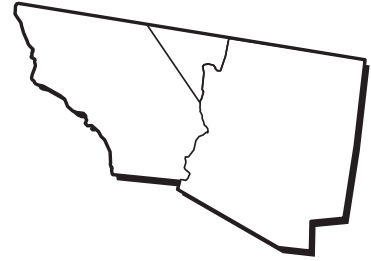

PLDB# MTF-SC2
PLANOGRAM# IPG05-122

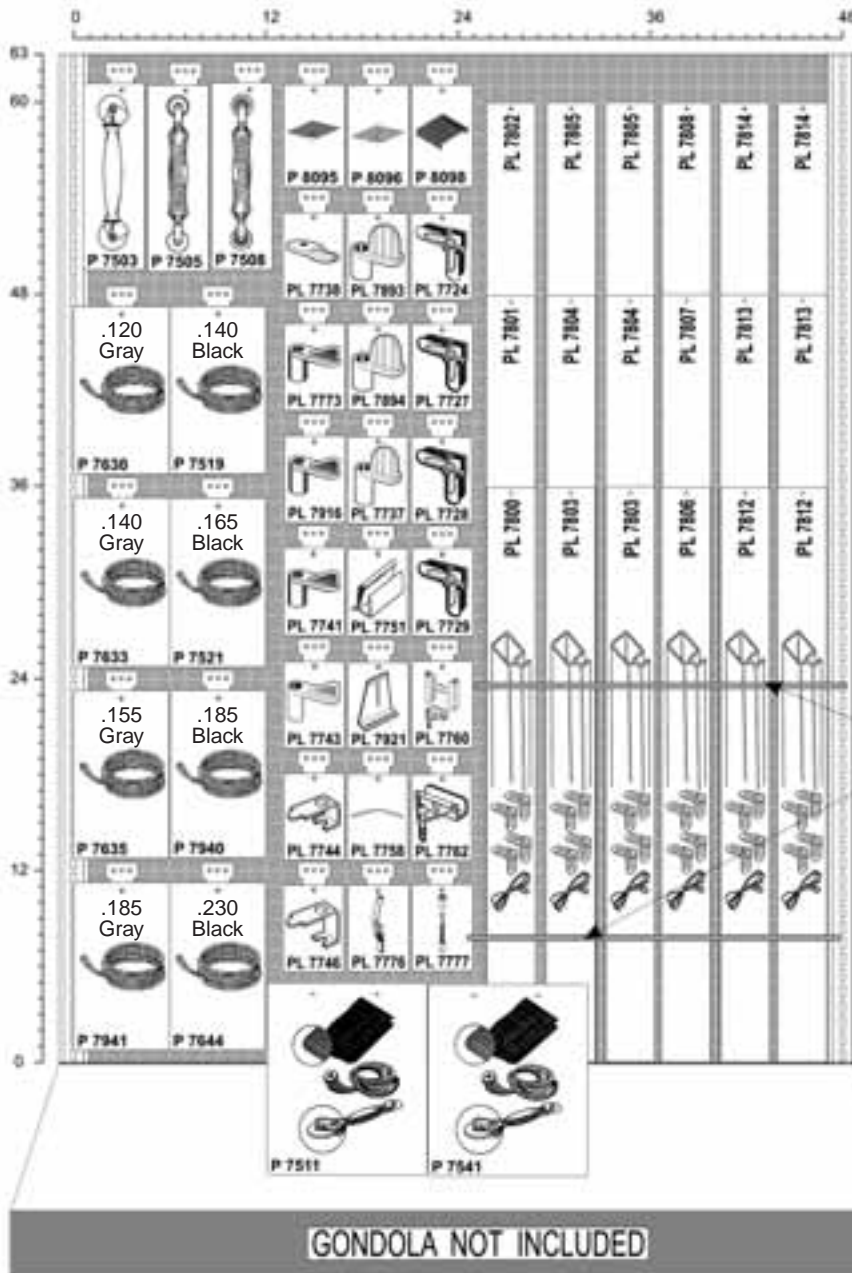

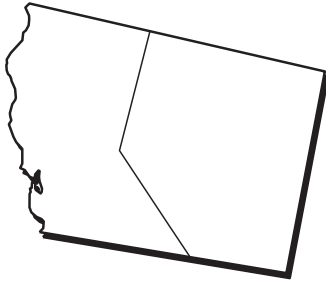

**SCREEN REPAIR PROGRAM
NORTHERN CALIFORNIA, NORTHERN NEVADA
48" Wide X 63" High**

**PLDB# MTF-CN2
PLANOGRAM# IPG05-123**

Window & Door Screening Center / Centro de mosquitera para ventanas y puertas

QUICK & EASY DO-IT-YOURSELF SCREEN REPAIR

- For Windows and Doors
- Assorted Finishes
- Tools, Kits & Patches

1. Measure & Cut **2. Assemble** **3. Roll & Trim**

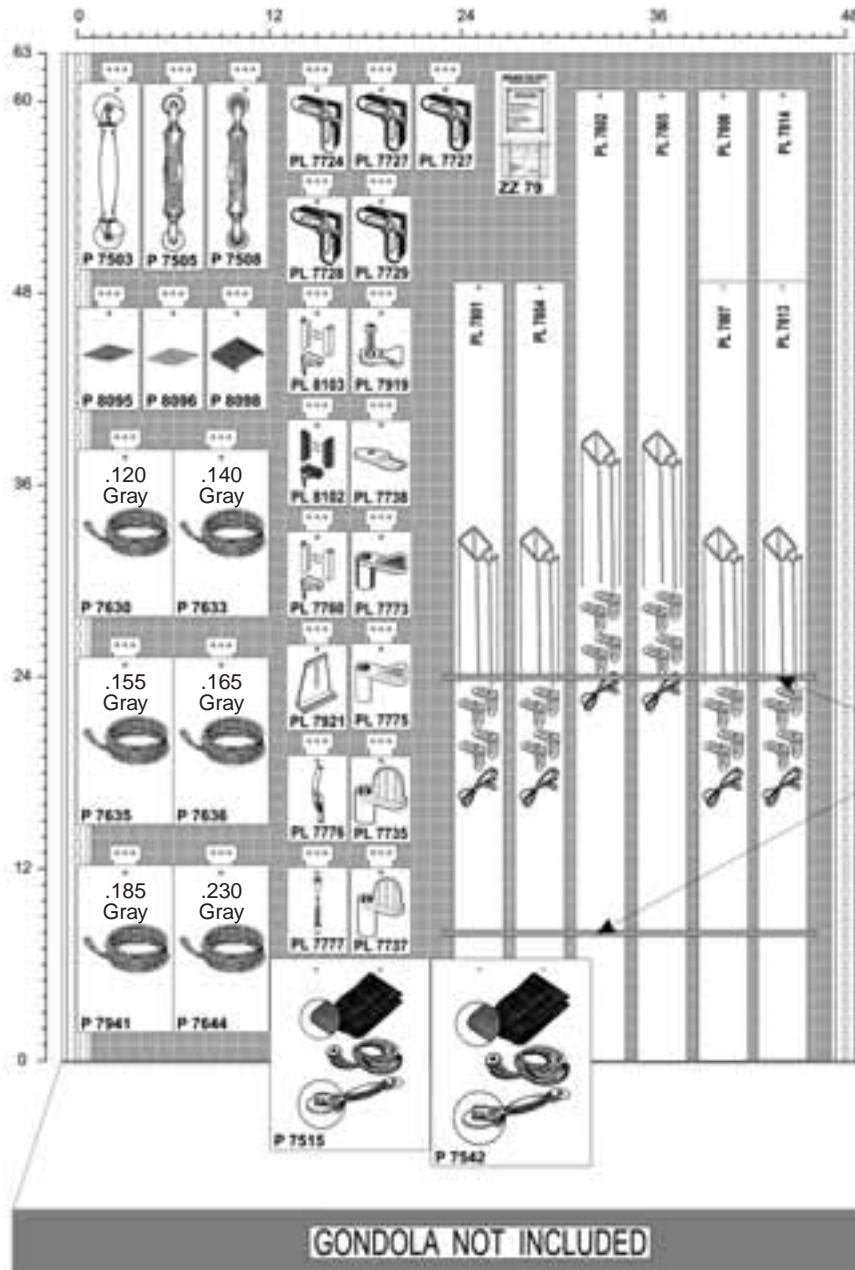

**SCREEN REPAIR PROGRAM
NORTHWEST REGION
48" Wide X 63" High**

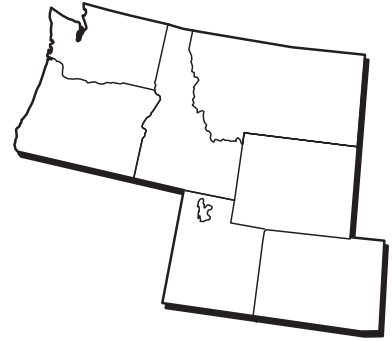

**PLDB# MTF-NW2
PLANOGRAM# IPG05-140**

CRIP Window & Door Screening Center / Centro de mosquitero para ventanas y puertas

QUICK & EASY DO-IT-YOURSELF SCREEN REPAIR

- For Windows and Doors
- Assorted Finishes
- Tools, Kits & Patches

1. Measure & Cut **2. Assemble** **3. Roll & Trim**

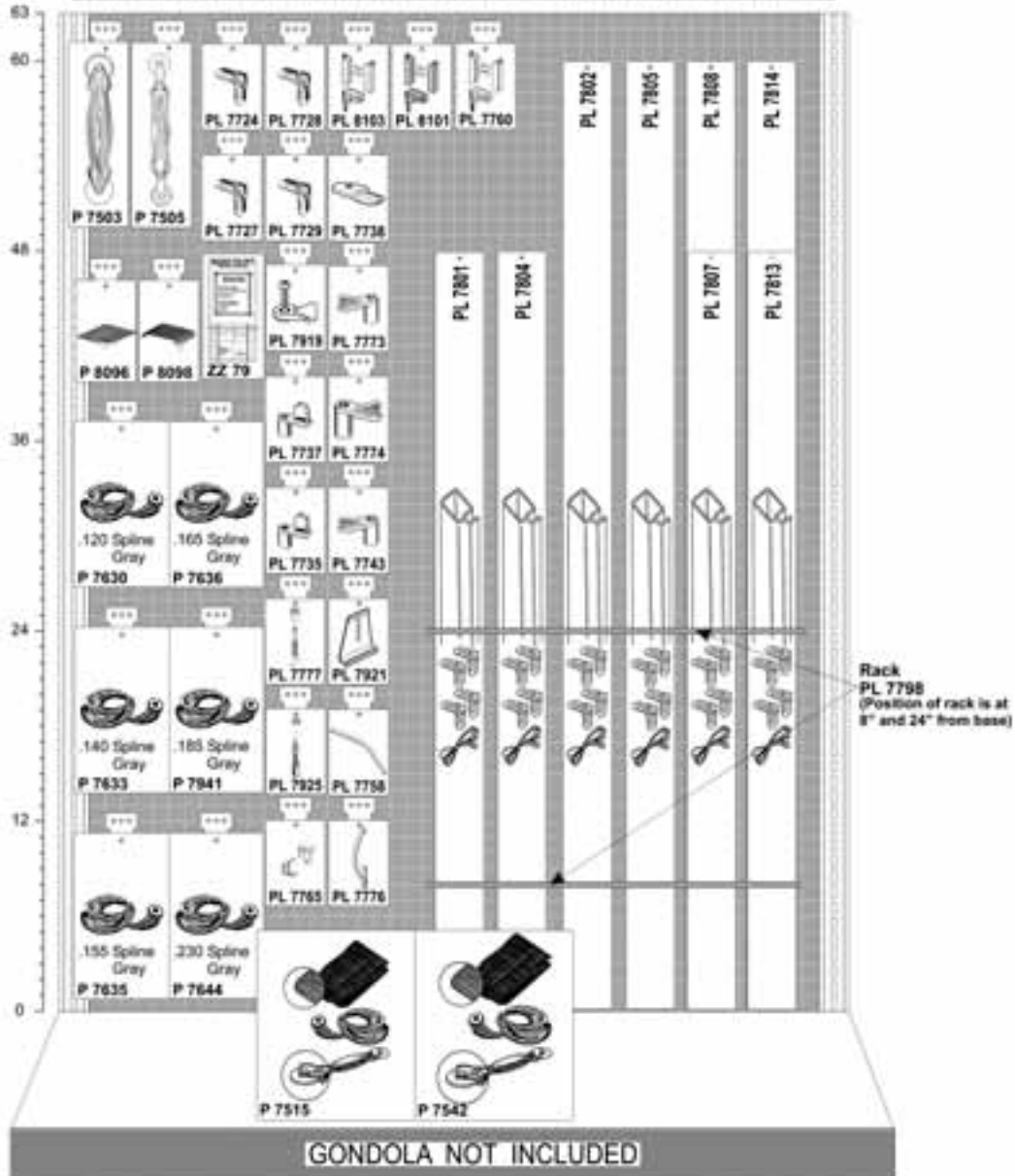



**SCREEN REPAIR PROGRAM
MIDWEST REGION
48" Wide X 63" High**

**PLDB# MTF-MW2
PLANOGRAM# IPG05-141**

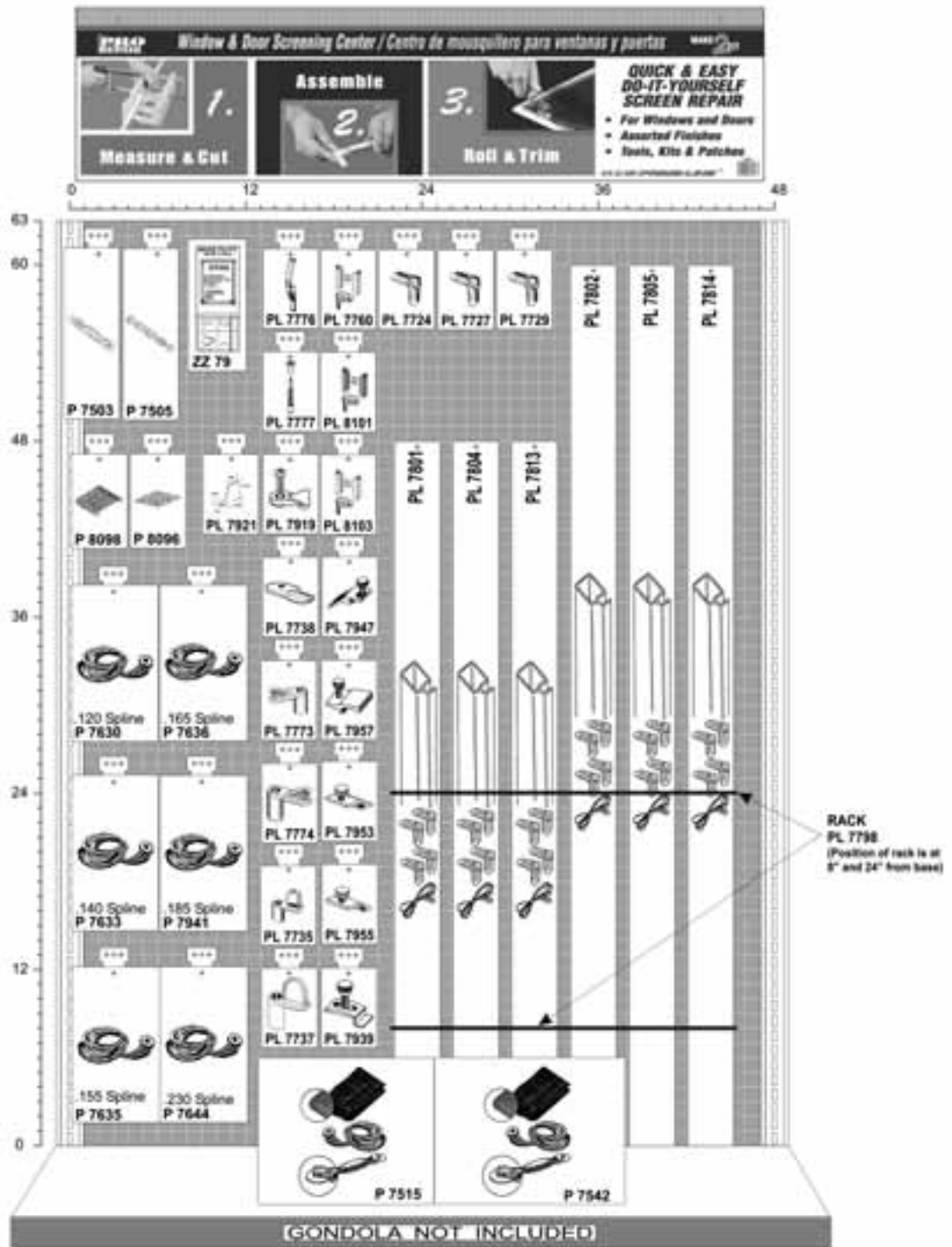

**SCREEN REPAIR PROGRAM
SOUTHWEST REGION
48" Wide X 63" High**



**PLDB# MTF-SW2
PLANOGRAM# IPG05-142**

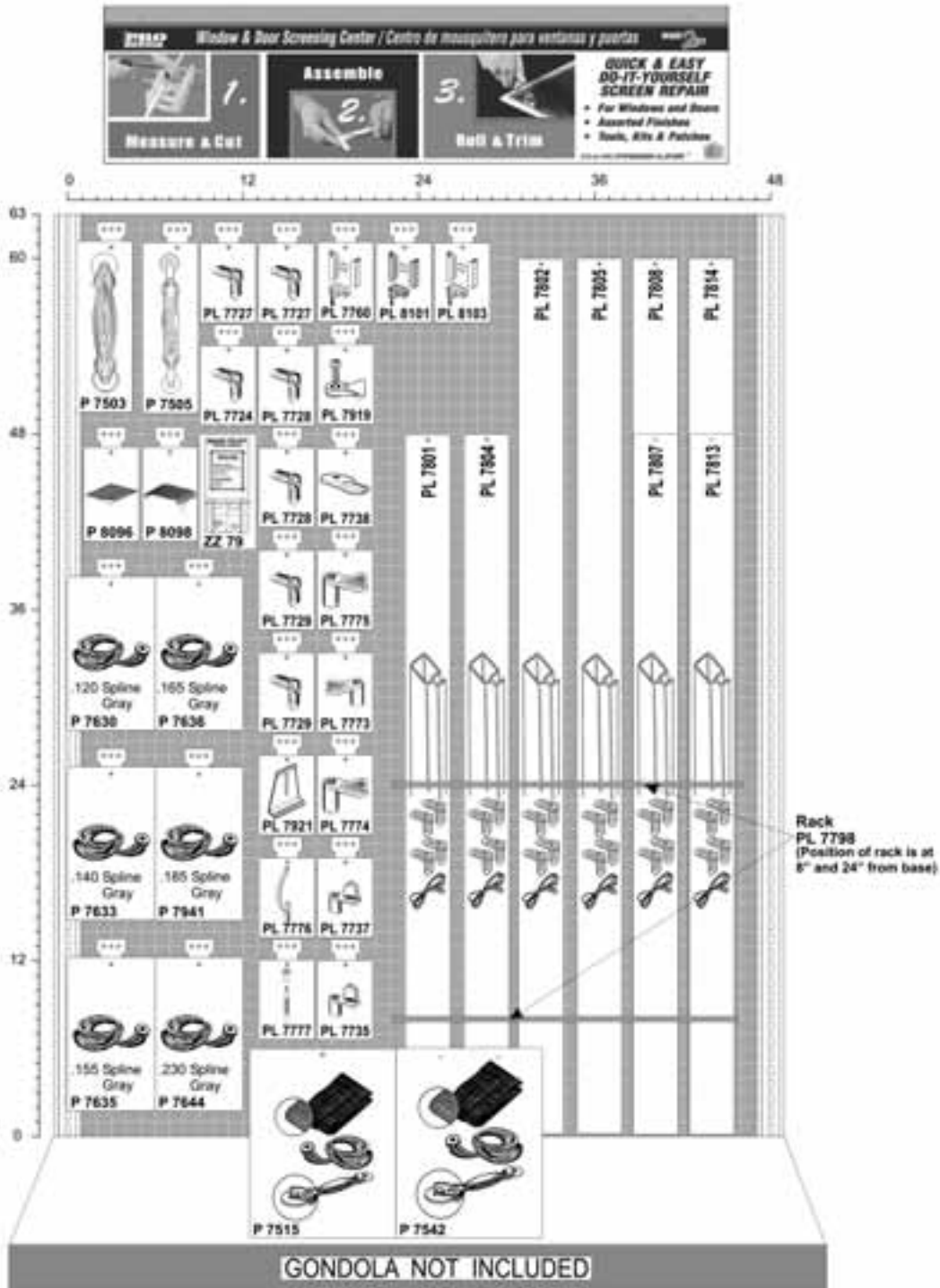



**SCREEN REPAIR PROGRAM
SOUTHEAST REGION
48" Wide X 63" High**

**PLDB# MTF-SE2
PLANOGRAM# IPG05-124**

EMSA Window & Door Screening Center / Centro de mosquitera para ventanas y puertas

1. Measure & Cut **2. Assemble** **3. Roll & Trim**

**QUICK & EASY
DO-IT-YOURSELF
SCREEN REPAIR**

- For Windows and Doors
- Assorted Finishes
- Tools, Kits & Patches

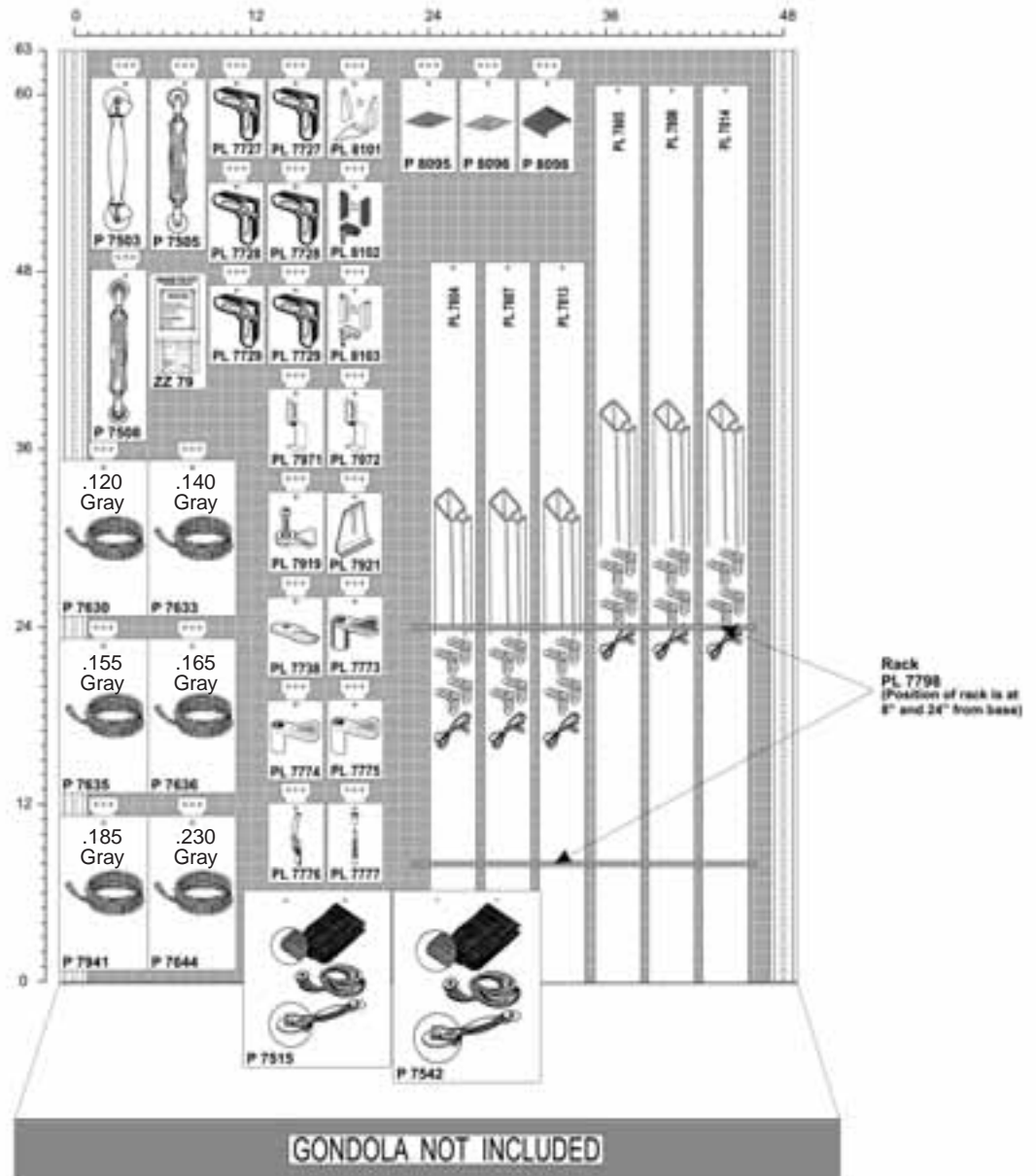

**SCREEN REPAIR PROGRAM
NORTHEAST REGION
48" Wide X 63" High**



**PLDB# MTF-NE2
PLANOGRAM# IPG05-143**

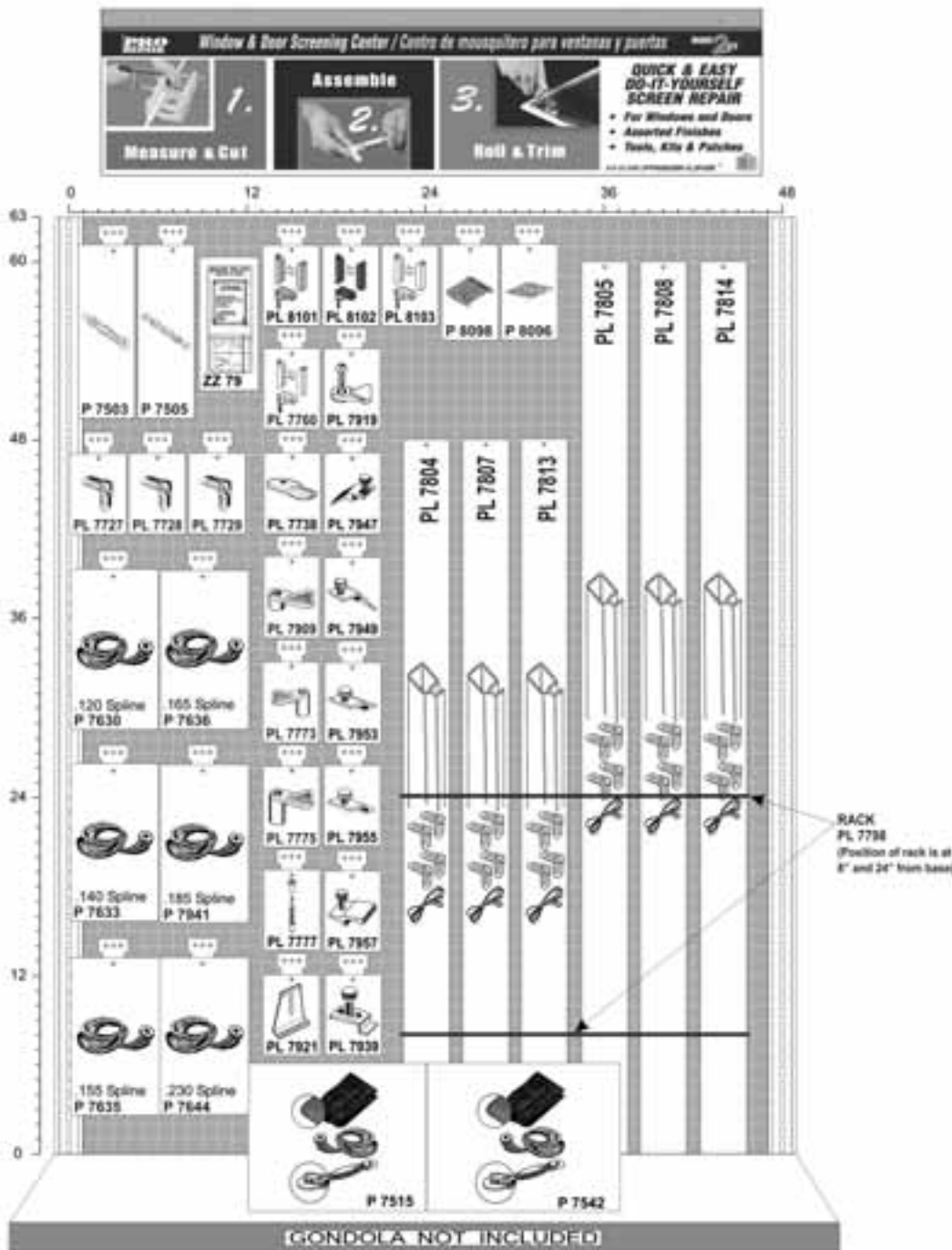

CHANNEL WINDOW BALANCES

Used On Single Or Double Hung Sash

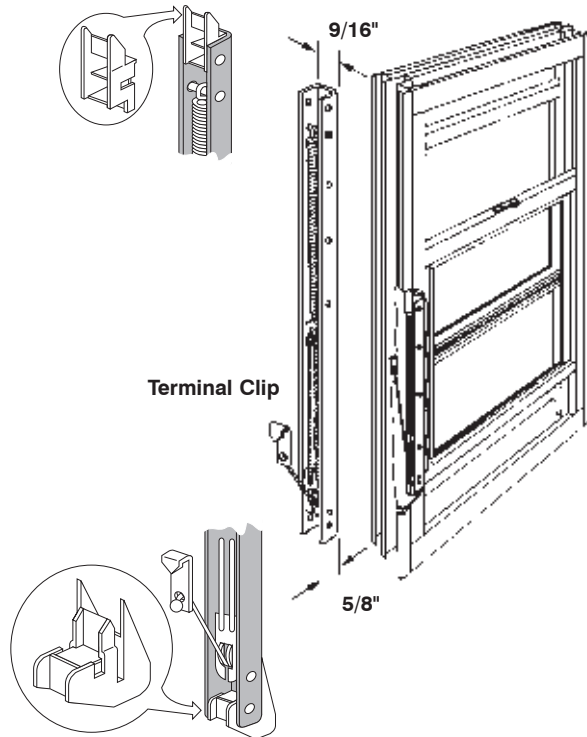

Balance Shown Installed In Jamb
With Vent Removed

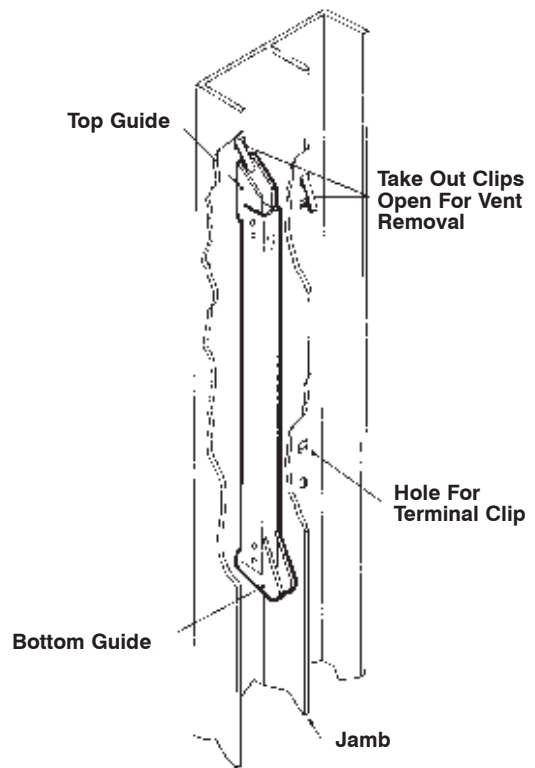

Ordering Tips:

1. Check the back side of channel for stamped numbers (i.e.; 1410, 28A, 3620, etc.).
 - a). The first two digits indicate the actual glass height.
 - b). The balance is **1" LONGER** than the part number indicates (i.e.; **#1410 is 15" long**).
 - c). The second two digits or letter designation (A, B, C, D) denote the weight series of the balance (i.e.; #1410 or 14A is for light weight sash, 1420 or 14B is medium, 1430 or 14C is medium to heavy and 1440 or 14D is heavy. Please see the enclosed **Selection Chart** for actual weight variations.
2. **The balance number, by itself, does not include top or bottom guides.**
 - a). Determine the correct guides required from the accessory page. You may use the existing guides from the defective balance, however, this will require drilling out the attaching rivets.
 - b). New guides may be ordered (installed) using the double asterisk (**) part number on page 83. They may also be ordered in bulk (50/bag with rivets or, in individual kits) and installed by the dealer. A "Universal Kit" (**EP-3719**) is available which includes a popular assortment (2 top guides, 3 bottom guides, 2 rivets and 1 take-out clip).
3. A rivet set tool (**EP-3740**) is available to expedite installation of guides to balance.

Installation Hints: Vents must be removed in order to replace the balance assemblies.

TO REMOVE VENT: Close vent to expose take-out clips. Open both clips for vent removal. Raise vent until top guide engages take-out clip. Continue to raise vent, 2 to 3 inches more. Move vent right or left as far as possible. Removal is then accomplished by swinging the opposite side of vent inward.

TO REPLACE BALANCE ASSEMBLY: Push down on balance until top guide is clear of take-out clip. Hold firmly and slowly lift up and away from jamb. Remove terminal clip and install new balance assembly using the reverse installation procedure. Be sure that top guide is secured under take-out clip. It is recommended that both balance assemblies be replaced in order to allow for efficient operation.

TO REPLACE VENT: Position right or left side of vent into jamb, 2 to 3 inches above take-out clip and swing opposite side into alignment with frame. Then lower vent to engage balances and on down to clear take-out clips. This will automatically center the vent. Snap take-out clips into jamb to facilitate normal operation.

SELECTION CHART (All balances sold individually in bulk)

Balance* Number	Alternate Number	Balance Height	Vent Weight	Balance* Number	Alternate Number	Balance Height	Vent Weight
FA-1210	12A	13"	3 - 6	FA-2520	25B	26"	9 - 15
FA-1220	12B	13"	6 - 9	FA-2530	25C	26"	15 - 19
FA-1230	12C	13"	9 - 11	FA-2540	25D	26"	19 - 25
FA-1240	12D	13"	11 - 12				
				FA-2610	26A	27"	5 - 9
FA-1310	13A	14"	3 - 6	FA-2620	26B	27"	9 - 13
FA-1320	13B	14"	6 - 9	FA-2630	26C	27"	13 - 19
FA-1330	13C	14"	9 - 11	FA-2640	26D	27"	19 - 26
FA-1340	13D	14"	11 - 12				
				FA-2710	27A	28"	5 - 9
FA-1410	14A	15"	4 - 6	FA-2720	27B	28"	9 - 13
FA-1420	14B	15"	6 - 10	FA-2730	27C	28"	13 - 19
FA-1430	14C	15"	10 - 12	FA-2740	27D	28"	19 - 26
FA-1440	14D	15"	12 - 13				
				FA-2810	28A	29"	7 - 12
FA-1510	15A	16"	4 - 6	FA-2820	28B	29"	12 - 16
FA-1520	15B	16"	6 - 10	FA-2830	28C	29"	16 - 23
FA-1530	15C	16"	10 - 12	FA-2840	28D	29"	23 - 28
FA-1540	15D	16"	12 - 13				
				FA-2910	29A	30"	7 - 12
FA-1610	16A	17"	5 - 8	FA-2920	29B	30"	12 - 16
FA-1620	16B	17"	8 - 12	FA-2930	29C	30"	16 - 23
FA-1630	16C	17"	12 - 14	FA-2940	29D	30"	23 - 28
FA-1640	16D	17"	14 - 19				
				FA-3010	30A	31"	7 - 12
FA-1710	17A	18"	5 - 8	FA-3020	30B	31"	12 - 16
FA-1720	17B	18"	8 - 12	FA-3030	30C	31"	16 - 23
FA-1730	17C	18"	12 - 14	FA-3040	30D	31"	23 - 28
FA-1740	17D	18"	14 - 17				
				FA-3110	31A	32"	7 - 12
FA-1810	18A	19"	5 - 8	FA-3120	31B	32"	12 - 16
FA-1820	18B	19"	8 - 12	FA-3130	31C	32"	16 - 23
FA-1830	18C	19"	12 - 14	FA-3140	31D	32"	23 - 28
FA-1840	18D	19"	14 - 17				
				FA-3210	32A	33"	8 - 13
FA-1910	19A	20"	5 - 8	FA-3220	32B	33"	13 - 18
FA-1920	19B	20"	8 - 12	FA-3230	32C	33"	18 - 23
FA-1930	19C	20"	12 - 14	FA-3240	32D	33"	23 - 28
FA-1940	19D	20"	14 - 17				
				FA-3310	33A	34"	8 - 13
FA-2010	20A	21"	5 - 8	FA-3320	33B	34"	13 - 18
FA-2020	20B	21"	8 - 12	FA-3330	33C	34"	18 - 23
FA-2030	20C	21"	12 - 15	FA-3340	33D	34"	23 - 28
FA-2040	20D	21"	15 - 23				
				FA-3410	34A	35"	8 - 13
FA-2110	21A	22"	5 - 8	FA-3420	34B	35"	13 - 18
FA-2120	21B	22"	8 - 12	FA-3430	34C	35"	18 - 23
FA-2130	21C	22"	12 - 15	FA-3440	34D	35"	23 - 30
FA-2140	21D	22"	15 - 23				
				FA-3510	35A	36"	8 - 13
FA-2210	22A	23"	5 - 8	FA-3520	35B	36"	13 - 18
FA-2220	22B	23"	8 - 12	FA-3530	35C	36"	18 - 23
FA-2230	22C	23"	12 - 19	FA-3540	35D	36"	23 - 30
FA-2240	22D	23"	19 - 23				
				FA-3610	36A	37"	8 - 13
FA-2310	23A	24"	5 - 9	FA-3620	36B	37"	13 - 18
FA-2320	23B	24"	9 - 15	FA-3630	36C	37"	18 - 23
FA-2330	23C	24"	15 - 18	FA-3640	36D	37"	23 - 30
FA-2340	23D	24"	18 - 23				
				FA-3710	37A	38"	8 - 13
FA-2410	24A	25"	5 - 9	FA-3720	37B	38"	13 - 18
FA-2420	24B	25"	9 - 15	FA-3730	37C	38"	18 - 23
FA-2430	24C	25"	15 - 19	FA-3740	37D	38"	23 - 30
FA-2440	24D	25"	19 - 24				
				FA-3810	38A	39"	9 - 14
FA-2510	25A	26"	5 - 9	FA-3820	38B	39"	14 - 19

*Top and bottom guides are not included.

Please see the following accessory page to determine what guides may be required.

CONTINUED

SELECTION CHART CONT.

Balance* Number	Alternate Number	Balance Height	Vent Weight
FA-3830	38C	39"	19 - 24
FA-3840	38D	39"	24 - 30
FA-3910	39A	40"	9 - 14
FA-3920	39B	40"	14 - 19
FA-3930	39C	40"	19 - 24
FA-3940	39D	40"	24 - 30
FA-4010	40A	41"	9 - 14
FA-4020	40B	41"	14 - 19
FA-4030	40C	41"	19 - 23
FA-4040	40D	41"	23 - 30
FA-4110	41A	42"	9 - 14
FA-4120	41B	42"	14 - 19
FA-4130	41C	42"	19 - 24
FA-4140	41D	42"	24 - 30
FA-4210	42A	43"	9 - 14
FA-4220	42B	43"	14 - 19
FA-4230	42C	43"	19 - 24
FA-4240	42D	43"	24 - 30

*Top and bottom guides are not included.
Please see the following accessory page to determine what guides may be required.

CHANNEL WINDOW BALANCES (OVERHEAD)

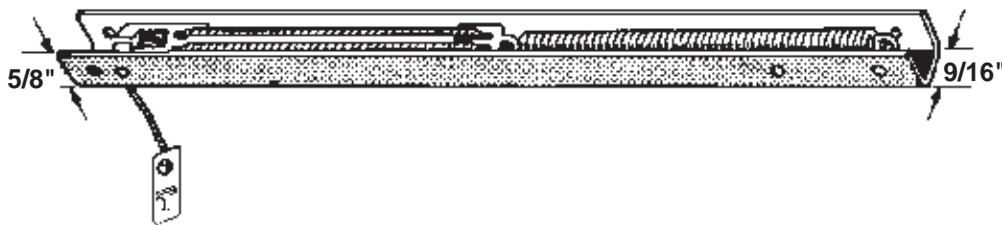

Balance Number	Balance Length	Vent Weight
FC-111	12-3/4"	4 - 7
FC-112	12-3/4"	7 - 11
FC-121	15-1/4"	4 - 8
FC-122	15-1/4"	8 - 12
FC-151	19-1/4"	5 - 9
FC-152	19-1/4"	9 - 13
FC-153	19-1/4"	13 - 16
FC-162	23-1/4"	9 - 14
FC-163	23-1/4"	14 - 20
FC-183	27-1/4"	17 - 22

CHANNEL BALANCE ACCESSORIES

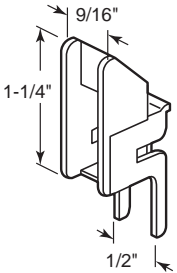
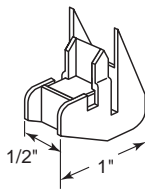
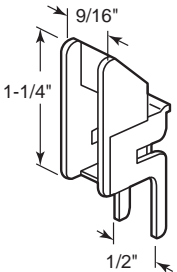
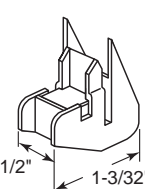
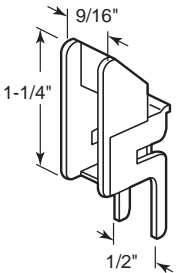
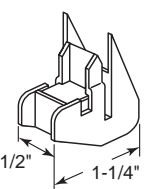
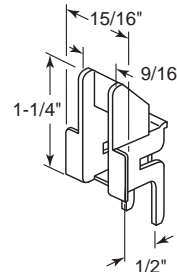
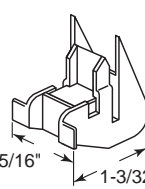
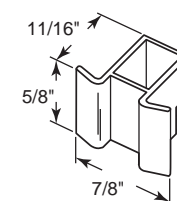
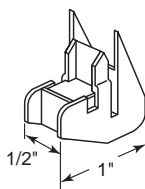
Typical Combinations		Pack Qty.	Part Number		
Top	Bottom		Top	Bottom	
NYLON GUIDES - Glass Filled					
		1 Each (Installed)	FS-100**	FS-150**	** = INSTALLED
		50 / Bulk	FS-100PB	FS-150PB	
		Kit (Bulk)	FS-290B (Top guide; bottom guide; take-out clip; 2 rivets)		
		1 Each (Installed)	FS-100**	FS-151**	** = INSTALLED
		50 / Bulk	FS-100PB	FS-151PB	
		Kit (Bulk)	FS-291B (Top guide; bottom guide; take-out clip; 2 rivets)		
		1 Each (Installed)	FS-100**	FS-152**	** = INSTALLED
		50 / Bulk	FS-100PB	FS-152PB	
		Kit (Bulk)	FS-292B (Top guide; bottom guide; take-out clip; 2 rivets)		
		1 Each (Installed)	FS-101**	FS-153**	** = INSTALLED
		50 / Bulk	FS-101PB	FS-153PB	
		Kit (Bulk)	FS-293B (Top guide; bottom guide; take-out clip; 2 rivets)		
		1 Each (Installed)	FS-102**	FS-150**	** = INSTALLED
		50 / Bulk	FS-102PB	FS-150PB	
		Kit (Bulk)	FS-294B (Top guide; bottom guide; take-out clip; 2 rivets)		

Match the guides above with the appropriate channel balance (see selection chart on pages 126 & 127).

CHANNEL BALANCE ACCESSORIES

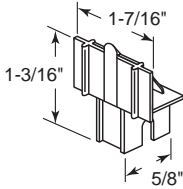
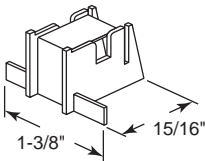
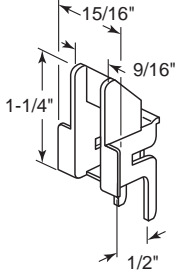
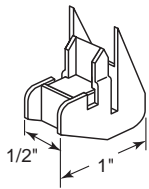
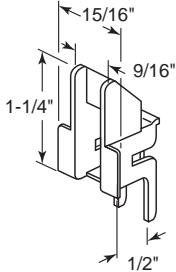
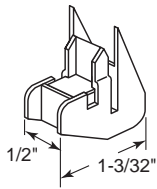
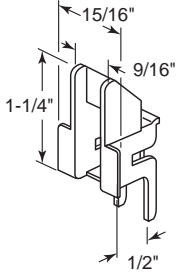
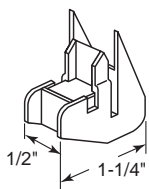
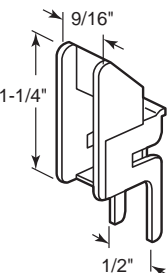
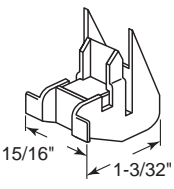
Pack Qty.	Part Number			Typical Combinations	
	Top	Bottom		Top	Bottom
1 Each (Installed) 50 / Bulk	FS-103** FS-103PB	FS-154** FS-154PB	** = INSTALLED		
Kit (Bulk)	FS-295B (Top guide; bottom guide; take-out clip; 2 rivets)				
<hr/>					
1 Each (Installed) 50 / Bulk	FS-101** FS-101PB	FS-150** FS-150PB	** = INSTALLED		
Kit (Bulk)	FS-296B (Top guide; bottom guide; take-out clip; 2 rivets)				
<hr/>					
1 Each (Installed) 50 / Bulk	FS-101** FS-101PB	FS-151** FS-151PB	** = INSTALLED		
Kit (Bulk)	FS-297B (Top guide; bottom guide; take-out clip; 2 rivets)				
<hr/>					
1 Each (Installed) 50 / Bulk	FS-101** FS-101PB	FS-152** FS-152PB	** = INSTALLED		
Kit (Bulk)	FS-298B (Top guide; bottom guide; take-out clip; 2 rivets)				
<hr/>					
1 Each (Installed) 50 / Bulk	FS-100** FS-100PB	FS-153** FS-153PB	** = INSTALLED		
Kit (Bulk)	FS-299B (Top guide; bottom guide; take-out clip; 2 rivets)				

Match the guides above with the appropriate channel balance (see selection chart on pages 126 & 127).

CHANNEL BALANCE ACCESSORIES

	Pack Qty.	Part Number
	BALANCE REPAIR KIT	
	6 Kits	EP-3719
	Kit contains: 2 top guides, 3 bottom guides, 2 rivets and 1 take-out clip.	

CHANNEL BALANCE ACCESSORIES

Easy Guide Replacement

1. Drill out existing rivet using 3/32" bit (drill thru crimped side of rivet).
2. Slide new self locating guide (top or bottom) on to appropriate end of balance. Align holes and insert rivet thru the drilled out hole in balance.
3. Place balance on solid surface with rivet head down. Locate pointed end of rivet installation tool in open end of rivet. Tap end of tool firmly with hammer to crimp rivet.

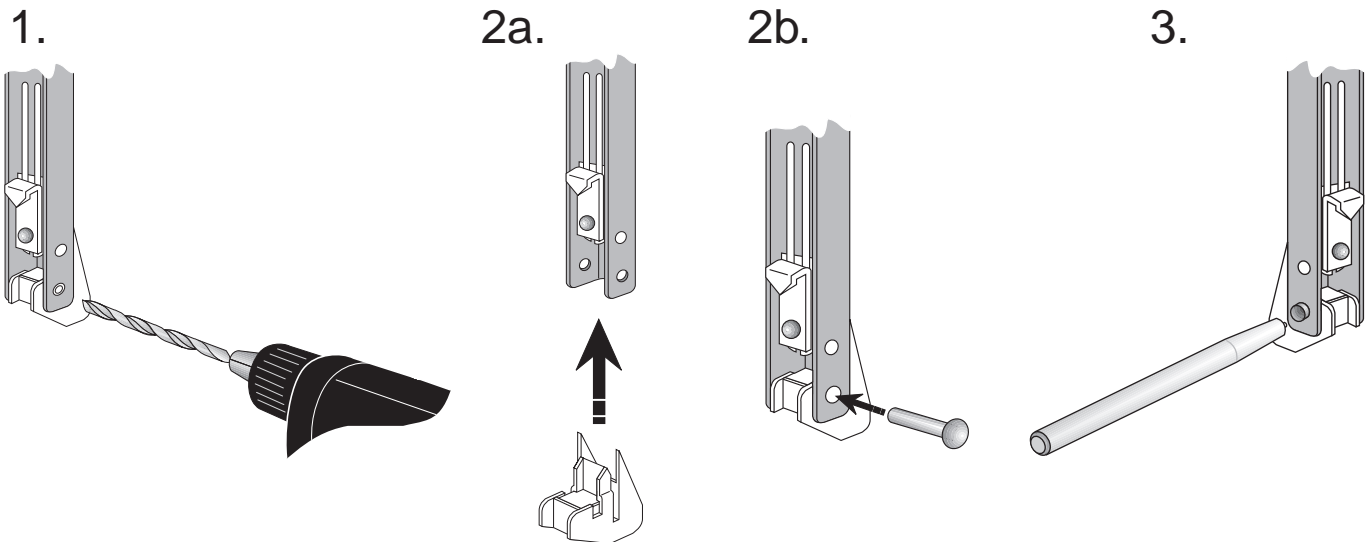

CHANNEL BALANCE ACCESSORIES

Pack Qty.

Part Number

SASH CAM - 5/8" Channel Balance

25/Bag

EP-3837

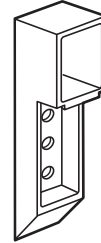

SASH CAM - 5/8" Channel Balance

25/Bag

EP-3838

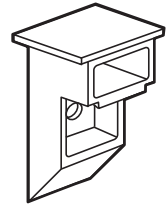

TERMINAL CLIPS - Stainless Steel

100/Bag

FS-250B

100/Bag

FS-251B



FS-250B

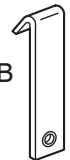

FS-251B

TAKE-OUT CLIP

100/Bag

FS-260B



.390

CHANNEL BALANCE ACCESSORIES

Pack Qty.

Part Number

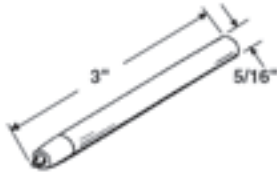

RIVET INSTALLATION TOOL

1

EP-3740



RIVETS

1000/Bag

FS-261B

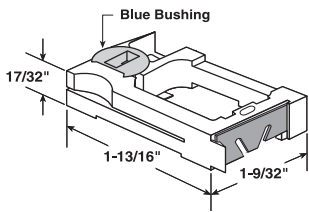

LOCK SHOE - 5/8" TILT WINDOW BALANCE

4/Bag

EP-3785

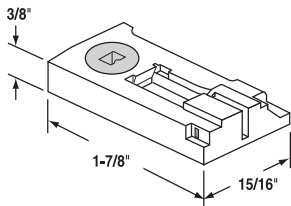

LOCK SHOE - 3/8" TILT WINDOW BALANCE

4/Bag

EP-3786

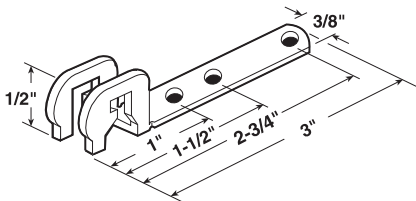

5/8" BALANCE FOOT - Non Tilt Windows

25/Bag

EP-3759

CHANNEL BALANCE ACCESSORIES

Pack Qty.

Part Number

5/8" SPIRAL BALANCE PIVOT BAR - Tilt Windows

25/Bag

EP-3758

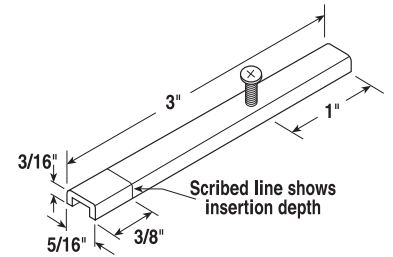

TILT BALANCE TENSION TOOL

1/Bag

EP-3787

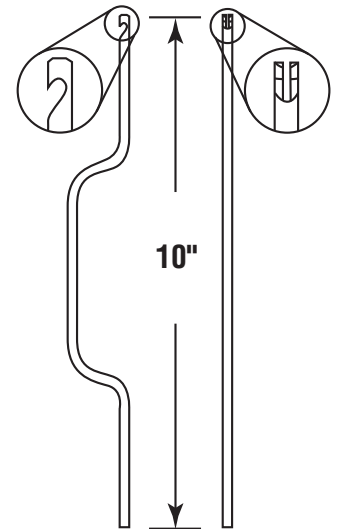

NON-TILT BALANCE TENSION TOOL

1/Bag

EP-3788

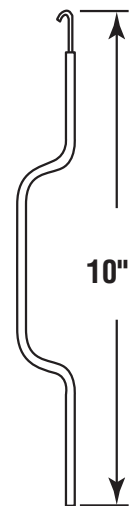

SPIRAL WINDOW BALANCES

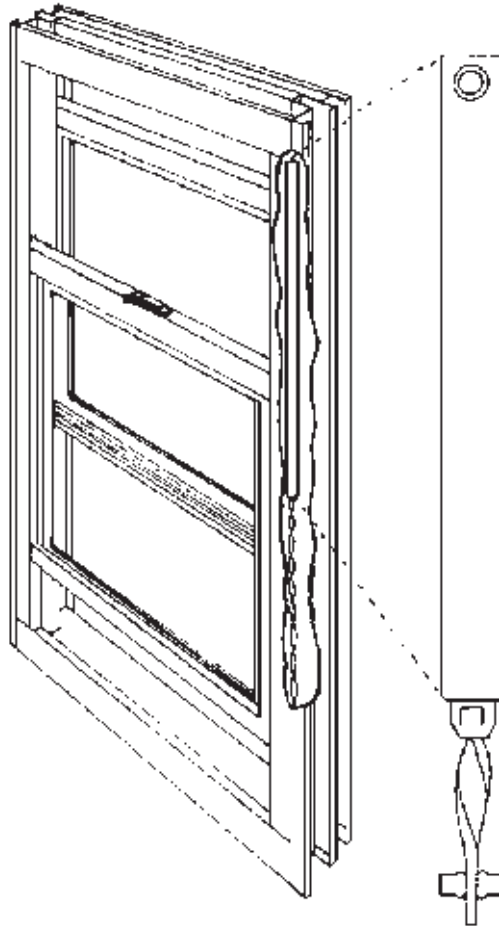

- Great **new category** of replacement items.
- Customer demand is growing steadily.
- **Special order** or **stock** your region's specific needs.

HOW TO ORDER:

1. Determine series designation.
2. Measure tube length.
3. Specify nylon bearing color to indicate spring weight (**white**-standard, **red**-medium, **blue** or **black**-heavy).
4. These balances are all metal tube. Plastic tube balances available on special request.
5. All balances are sold individually in bulk.

SPIRAL WINDOW BALANCES

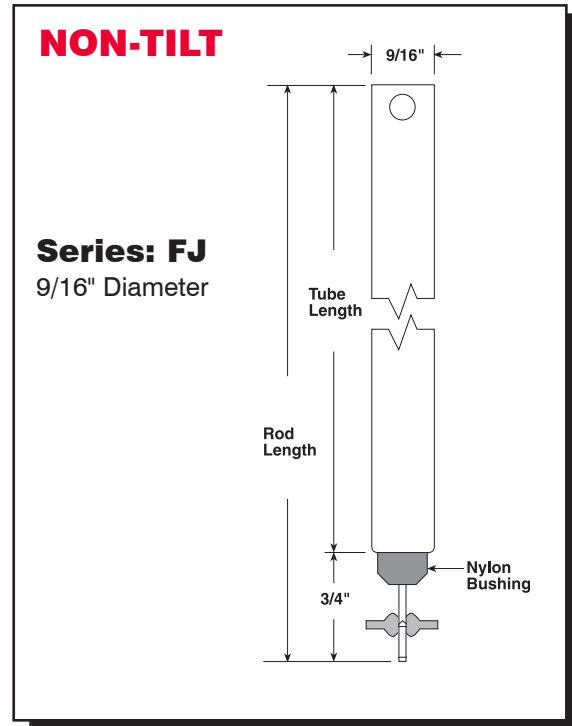
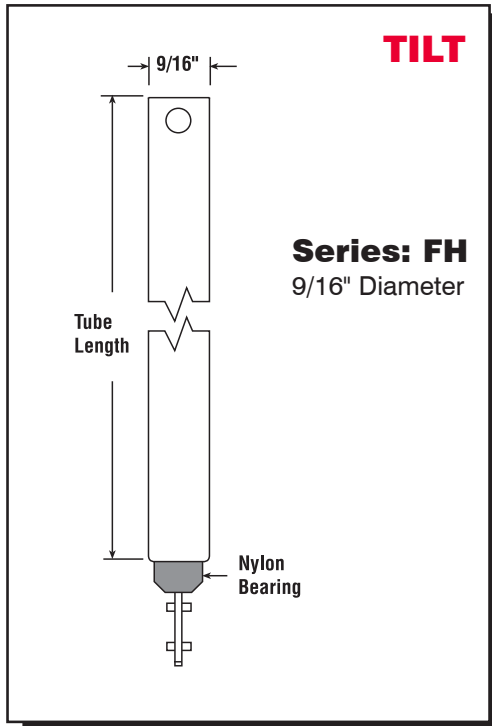

Tube Length	Bearing Color			Tube Length	Bearing Color	
	White	Red	Blue		Red	Blue
15	FH-1510	FH-1520	FH-1530	15	FJ-1520	FJ-1530
16	FH-1610	FH-1620	FH-1630	16	FJ-1620	FJ-1630
17	FH-1710	FH-1720	FH-1730	17	FJ-1720	FJ-1730
18	FH-1810	FH-1820	FH-1830	18	FJ-1820	FJ-1830
19	FH-1910	FH-1920	FH-1930	19	FJ-1920	FJ-1930
20	FH-2010	FH-2020	FH-2030	20	FJ-2020	FJ-2030
21	—	FH-2120	FH-2130	21	FJ-2120	FJ-2130
22	—	FH-2220	FH-2230	22	FJ-2220	FJ-2230
23	—	FH-2320	FH-2330	23	FJ-2320	FJ-2330
24	—	FH-2420	FH-2430	24	FJ-2420	FJ-2430
25	—	FH-2520	FH-2530	25	FJ-2520	FJ-2530
26	—	FH-2620	FH-2630	26	FJ-2620	FJ-2630
27	—	FH-2720	FH-2730	27	FJ-2720	FJ-2730
28	—	FH-2820	FH-2830	28	FJ-2820	FJ-2830
29	—	FH-2920	FH-2930	29	FJ-2920	FJ-2930
30	—	FH-3020	FH-3030	30	FJ-3020	FJ-3030
31	—	FH-3120	FH-3130	31	FJ-3120	FJ-3130
32	—	FH-3220	FH-3230	32	FJ-3220	FJ-3230
33	—	FH-3320	—	33	FJ-3320	—
34	—	FH-3420	—	34	FJ-3420	—
35	—	FH-3520	—	35	FJ-3520	—
36	—	FH-3620	—	36	FJ-3620	—
37	—	FH-3720	—	37	FJ-3720	—
38	—	FH-3820	—	38	FJ-3820	—
39	—	FH-3920	—	39	FJ-3920	—

SPIRAL WINDOW BALANCES

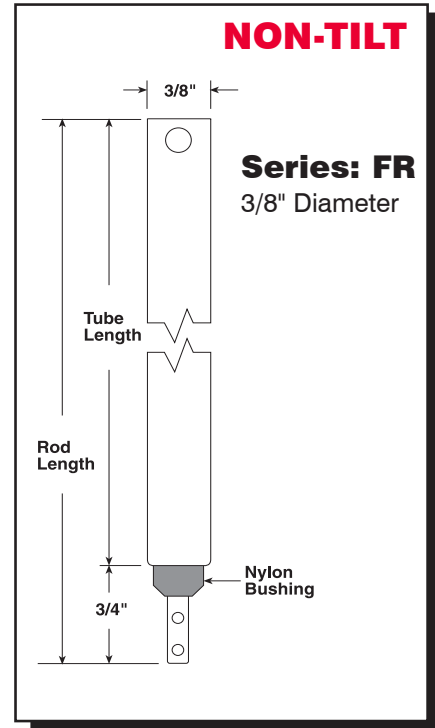
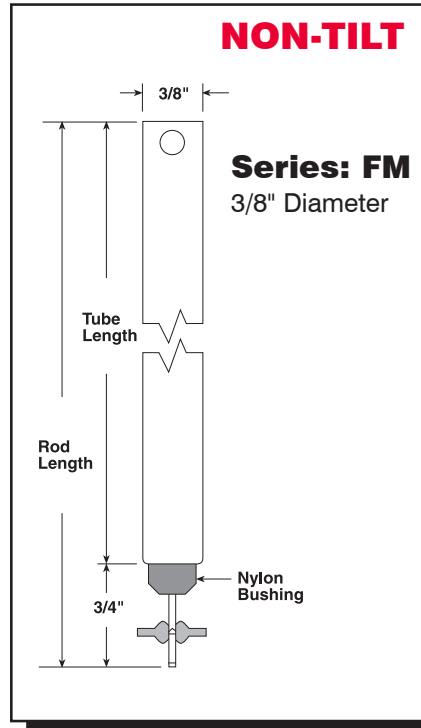
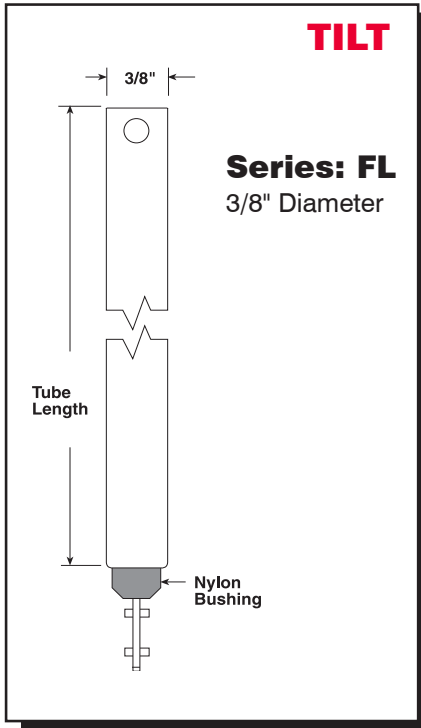

Tube Length	Bearing Color Red
18	FL-1820
19	FL-1920
20	FL-2020
21	FL-2120
22	FL-2220
23	FL-2320
24	FL-2420
25	FL-2520
26	FL-2620
27	FL-2720
28	FL-2820
29	FL-2920
30	FL-3020

Tube Length	Bearing Color Red
18	FM-1820
19	FM-1920
20	FM-2020
21	FM-2120
22	FM-2220
23	FM-2320
24	FM-2420
25	FM-2520
26	FM-2620
27	FM-2720
28	FM-2820
29	FM-2920
30	FM-3020

Tube Length	Bearing Color Red
18	FR-1820**
19	FR-1920**
20	FR-2020**
21	FR-2120**
22	FR-2220**
23	FR-2320**
24	FR-2420**
25	FR-2520**
26	FR-2620**
27	FR-2720**
28	FR-2820**
29	FR-2920**
30	FR-3020**

*** Order Clip FS-343**
And Balance Separately**

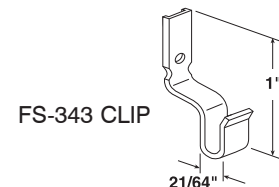

SPIRAL WINDOW BALANCE ACCESSORIES

Pack Qty. **Part No.** **Fits**

1 Each **(Installed)** FS-342** **Series FR**
 ** = Installed to balance of your choice (no minimum order)

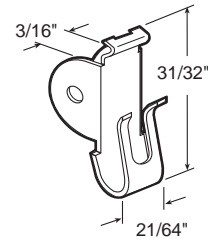

1 Each **(Installed)** FS-343** **Series FR**
 ** = Installed to balance of your choice (no minimum order)

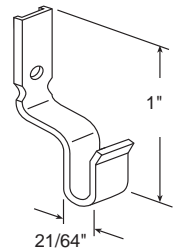

1 Each **(Installed)** FS-340** **Series FR**
 ** = Installed to balance of your choice (no minimum order)

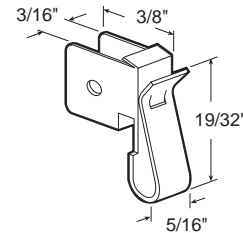

1 Each **(Installed)** FS-341** **Series FR**
 ** = Installed to balance of your choice (no minimum order)

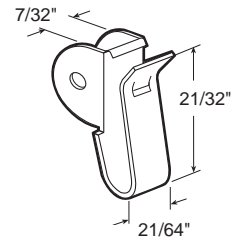

1 Each **(Installed)** FS-300** **Series FK**
 ** = Installed to balance of your choice (no minimum order)

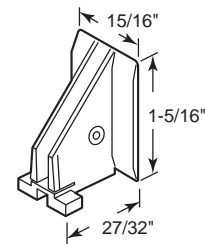

1 Each **(Installed)** FS-310** **Series FN**
 ** = Installed to balance of your choice (no minimum order)

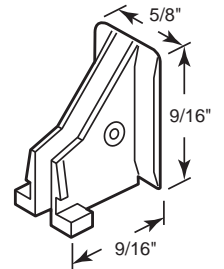

1 Each **(Installed)** FS-311** **Series FN**
 ** = Installed to balance of your choice (no minimum order)

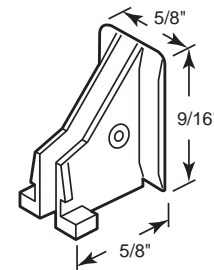

INDEX

Page Number

A

Adjustment Channel-Screen	18
Angle Stop	18
Awning Window Link	104

B

Bail Latches	100-102
Balances	
Channel	127-136
Spiral	137-139
Ball Head Screws	105
Blades, Saw	49
Bolt, Slide	76-90
Bug Seal	43

C

C-Sash	22
Casement Clips	96
Casement Screen Lock	104
Channel, Glass	21
Clips	
Casement	96
Glazing	96
Insert, Window	91
Lift	98
Rams Horn	96
Retainer	96
Screen	92-97
Screen Spreader Bar	17
Storm Panel	107-109
Stretcher	93
Wing	97
Closer, Sliding Screen Door	116
Cone Springs	100
Corners	
Kit Assortments	53-56
Screen Frame	6-19
Storm Window	57-65
Window Frame	21

D

Die Cast Screen Clips	94
Door, Patio	
Repair Track	112
Weatherstripping, Wood Pile	44
Door, Screen	
Bug Seal	43
Closer, Screen Door	116
Grills	114-115
K.D. Kits	110-111
Storm Door Panel Clips	107-109

F

Fiberglass Screening	51
Finger Seal	37-39
Flat Window Springs	100
Frame Fasteners, Screen	97-104
Frame	
Screen	7-18
Screen Kits	19
Storm Window	23-26
Triple Track	23-26

G

Glass Retainer Spine	
Push-In	30-36
Rigid Vinyl	37-39
Snap-In	37-39

Page Number

Glass Surround	21
Glazing Channel-Vinyl	30-36
Glazing Clips	96
Glazing Sealant	45
Grills, Screen Door	113-115

H

H-Channel	18
How To Assemble	
Cutting Table/Rack	4
Glue-Type Storm Windows	45
Miter Saw Table/Rack	4

I

Insert Clips, Window Frame	91
----------------------------------	----

J

Jiffy Hangers	101-102
Jig, Screen Table	48

K

K.D. Kits-Sliding Screen Door	110-111
Kits	
Re-Screen Fabric	51
Screen Frame	19
Storm Window Components	53-56
Knife Latch, Screen	102
Knurled Thumb Screws	108

L

Lift Clips	98
Lip Type Frame	13-15
Lock "P" Pins	104
Louver Vinyl	44

M

Miter Box	48
Measuring Devices	
Accu-Rule	113
Cut-Off Gauge	5
Merchandising Aids	117-119

N

Nail Set	48
Nails, Spiral	105

P

Panel Clips, Storm	107-109
Parts Kits	53-56
Pile Weatherstrip	44
Planograms, Regional	
Southern CA, Arizona	120
Northern CA, Northern NV	121
Northwest	122
Midwest	123
Southwest	124
Southeast	125
Northeast	126
Plastic Lift Clips	98
Plastic Screen Clips	96
Plunger Latches	101-103
Precision Cut-Off Gauge	5
Pull Tabs	98-99

CONTINUED...

	Page Number
R	
Rams Horn Clip	96
Repair Patch, Screen	51
Re-Screening Kits	51
Rolling Tools, Screen	45-47
S	
Sash Balances	127-129
Saw Blade, Screen	49
Screen Frame Accessories	
Clips	93-96
Corners	6-19
Doors, Sliding K.D. Kits	110-111
Frame	7-18
Frame Kits	19
Hangers	101-102
Jiffy Hangers	101-102
Jig Set	48
Knife Latch	103
Nail Set	48
Notching Jig	47
Notching tool	47
Plunger Latches	102-103
Retainer Clips	98
Rolling Tools	45-47
Screen patch	51
Spline	28-29
Springs, Flat & Cone Type	100
Wickets	50
Screen Frame	
Adjustment Channel	18
Angle Stop	18
"H" Section	18
Kits	19
Lip	13-15
Roll-Formed Aluminum	7-15
Spreader Bar	17
Stand-Off	15
Screen Tools	
Miter Box	48
Nail Set	48
Notching Jig	47
Notching Tool	47
Precision Cut-Off Gauge	5
Rolling	45-47
Saw Blades	49
Saw Wax	49
Screen Table Jig	48
Step Drill	48
Screening, Fiberglass	50
Screws	105
Shears	49
Spline, Vinyl Retainer	
Flat	30
Glazing	34-36
Screen	29
"T"	30
Slide Bolts	76-90
Sliding Screen Door	
Bug Seal	43
Closer	116
K.D. Kits	110-111
Grills	114-115
Spline	28-29
Spreader Bar	17
Spreader Bar Clips	17
Springs, Flat & Cone Type	100
Step Drill	48
Storm Door and Window	
Adhesive	45
C-Sash	23
Channel	21-22
Clips, Insert	91
Corner Keys	57-65
Panel Clips	107-109
Slide Bolts	76-90
Springs, Slide Bolt	92
Tilt Keys	66-74
Triple Track	23-26
Weatherstrip	44
Stretcher Clips	93
Support Materials	117-119
T	
Table Kits	
Cut-Off Saw	5
Portable Chop Saw	4
Screen Table	3
Table Kit Accessories	
Cut-Off Gauge	5
Screen Table Tower	4
Table Top Carpet	3
Tilt Keys	66-74
Thumb Screws	108
Tools, Screen	45-49
Saw Blade	49
Screen Table Jig	48
Triple Track Frame	23-26
Triple Track Accessories	24-26
Turn Buttons	97
U	
Uni-Fit Bug Seal	43
W	
Wax, Saw	49
Weatherstrip	
Air/Dust, Window	44
Bug Seal, Screen Door	43
Wool Pile, Patio Door	44
Wickets	50
Window Frame Accessories	
Corner Insert Clips	91
C-Sash Corners	22
Frame	20-21
Glazing Retainer Spline	34-36
Sash Balances	127-139
Screen Clips	93-96
Triple Track Frame	23-26
Window Frame (Alum.)	
3/8" Roll-Formed	20
5/16" Extruded	21
Glass Surround	20
Universal C-Sash	22
Window Grid Retainers	105-106
Wire Window Springs	100

INDEX Part Number To Page Number

B	FA-2140	128	FA-3810	128	FH-2930	137	FL-2620	138
B-621	FA-2210	128	FA-3820	128	FH-3020	137	FL-2720	138
B-660	FA-2220	128	FA-3830	129	FH-3030	137	FL-2820	138
B-705	FA-2230	128	FA-3840	129	FH-3120	137	FL-2920	138
B-708	FA-2240	128	FA-3910	129	FH-3130	137	FL-3020	138
B-716	FA-2310	128	FA-3920	129	FH-3220	137	FM-1820	138
B-757	FA-2320	128	FA-3930	129	FH-3230	137	FM-1920	138
B-771	FA-2330	128	FA-3940	129	FH-3320	137	FM-2020	138
B-784	FA-2340	128	FA-4010	129	FH-3420	137	FM-2120	138
B-791	FA-2410	128	FA-4020	129	FH-3520	137	FM-2220	138
B-801	FA-2420	128	FA-4030	129	FH-3620	137	FM-2320	138
B-802	FA-2430	128	FA-4040	129	FH-3720	137	FM-2420	138
	FA-2440	128	FA-4110	129	FH-3820	137	FM-2520	138
	FA-2510	128	FA-4120	129	FH-3920	137	FM-2620	138
E	FA-2520	128	FA-4130	129	FJ-1520	137	FM-2720	138
EP-3719	FA-2530	128	FA-4140	129	FJ-1530	137	FM-2820	138
EP-3740	FA-2540	128	FA-4210	129	FJ-1620	137	FM-2920	138
EP-3758	FA-2610	128	FA-4220	129	FJ-1630	137	FM-3020	138
EP-3759	FA-2620	128	FA-4230	129	FJ-1720	137	FR-1820**	138
EP-3785	FA-2630	128	FA-4240	129	FJ-1730	137	FR-1920**	138
EP-3786	FA-2640	128	FC-111	129	FJ-1820	137	FR-2020**	138
EP-3787	FA-2710	128	FC-112	129	FJ-1830	137	FR-2120**	138
EP-3788	FA-2720	128	FC-121	129	FJ-1920	137	FR-2220**	138
EP-3837	FA-2730	128	FC-122	129	FJ-1930	137	FR-2320**	138
EP-3838	FA-2740	128	FC-151	129	FJ-2020	137	FR-2420**	138
	FA-2810	128	FC-152	129	FJ-2030	137	FR-2520**	138
F	FA-2820	128	FC-153	129	FJ-2120	137	FR-2620**	138
FA-1210	FA-2830	128	FC-162	129	FJ-2130	137	FR-2720**	138
FA-1220	FA-2840	128	FC-163	129	FJ-2220	137	FR-2820**	138
FA-1230	FA-2910	128	FC-183	129	FJ-2230	137	FR-2920**	138
FA-1240	FA-2920	128	FH-1510	137	FJ-2320	137	FR-3020**	138
FA-1310	FA-2930	128	FH-1520	137	FJ-2330	137	FS-100**	130
FA-1320	FA-2940	128	FH-1530	137	FJ-2420	137	FS-100PB	130
FA-1330	FA-3010	128	FH-1610	137	FJ-2430	137	FS-101**	130
FA-1340	FA-3020	128	FH-1620	137	FJ-2520	137	FS-101PB	130
FA-1410	FA-3030	128	FH-1630	137	FJ-2530	137	FS-102**	130
FA-1420	FA-3040	128	FH-1710	137	FJ-2620	137	FS-102PB	130
FA-1430	FA-3110	128	FH-1720	137	FJ-2630	137	FS-103**	131
FA-1440	FA-3120	128	FH-1730	137	FJ-2720	137	FS-103PB	131
FA-1510	FA-3130	128	FH-1810	137	FJ-2730	137	FS-150**	130
FA-1520	FA-3140	128	FH-1820	137	FJ-2820	137	FS-150PB	130
FA-1530	FA-3210	128	FH-1830	137	FJ-2830	137	FS-151**	130
FA-1540	FA-3220	128	FH-1910	137	FJ-2920	137	FS-151PB	130
FA-1610	FA-3230	128	FH-1920	137	FJ-2930	137	FS-152**	130
FA-1620	FA-3240	128	FH-1930	137	FJ-3020	137	FS-152PB	130
FA-1630	FA-3310	128	FH-2010	137	FJ-3030	137	FS-153**	130
FA-1640	FA-3320	128	FH-2020	137	FJ-3120	137	FS-153PB	130
FA-1710	FA-3330	128	FH-2030	137	FJ-3130	137	FS-154**	131
FA-1720	FA-3340	128	FH-2120	137	FJ-3220	137	FS-154PB	131
FA-1730	FA-3410	128	FH-2130	137	FJ-3230	137	FS-250B	133
FA-1740	FA-3420	128	FH-2220	137	FJ-3320	137	FS-251B	133
FA-1810	FA-3430	128	FH-2230	137	FJ-3420	137	FS-260B	133
FA-1820	FA-3440	128	FH-2320	137	FJ-3520	137	FS-261B	134
FA-1830	FA-3510	128	FH-2330	137	FJ-3620	137	FS-290B	130
FA-1840	FA-3520	128	FH-2420	137	FJ-3720	137	FS-291B	130
FA-1910	FA-3530	128	FH-2430	137	FJ-3820	137	FS-292B	130
FA-1920	FA-3540	128	FH-2520	137	FJ-3920	137	FS-293B	130
FA-1930	FA-3610	128	FH-2530	137	FL-1820	138	FS-294B	130
FA-1940	FA-3620	128	FH-2620	137	FL-1920	138	FS-295B	131
FA-2010	FA-3630	128	FH-2630	137	FL-2020	138	FS-296B	131
FA-2020	FA-3640	128	FH-2720	137	FL-2120	138	FS-297B	131
FA-2030	FA-3710	128	FH-2730	137	FL-2220	138	FS-298B	131
FA-2040	FA-3720	128	FH-2820	137	FL-2320	138	FS-299B	131
FA-2110	FA-3730	128	FH-2830	137	FL-2420	138	FS-300**	139
FA-2120	FA-3740	128	FH-2920	137	FL-2520	138	FS-310**	139
FA-2130								

FS-311**	139	P-7573	28	P-7644	28	P-7715	28	P-7790	35
FS-340**	139	P-7574	28	P-7645	28	P-7716	28	P-7791	35
FS-341**	139	P-7575	28	P-7646	28	P-7717	28	P-7792	35
FS-342**	139	P-7576	28	P-7647	28	P-7719	28	P-7793	35
FS-343**	139	P-7577	28	P-7648	28	P-7720	46	P-7794	34
		P-7578	28	P-7649	28	P-7727	46	P-7795	34
K		P-7579	28	P-7650	28	P-7728	32	P-7796	34
K-5166	114	P-7580	28	P-7651	28	P-7729	32	P-7797	35
K-5167	114	P-7581	28	P-7652	28	P-7730	32	P-7798	35
K-5186	114	P-7582	28	P-7653	28	P-7731	21, 32	P-7799	35
		P-7583	28	P-7654	28	P-7732	21, 32	P-7800	35
P		P-7584	28	P-7655	28	P-7733	21, 32	P-7801	35
P-7503	45	P-7585	28	P-7656	28	P-7734	20, 21, 32	P-7802	35
P-7505	45	P-7586	28	P-7657	28	P-7735	20, 21, 32	P-7805	30
P-7506	45	P-7587	28	P-7658	28	P-7736	20, 21, 32	P-7806	30
P-7508	45	P-7588	28	P-7659	28	P-7737	32	P-7807	30
P-7510	51	P-7589	28	P-7660	26, 28	P-7738	32	P-7808	30
P-7511	51	P-7590	28	P-7661	26, 28	P-7739	32	P-7809	37
P-7515	51	P-7591	28	P-7662	26, 28	P-7740	24, 33	P-7810	37
P-7516	28	P-7593	28	P-7663	28	P-7741	24, 33	P-7811	37
P-7517	28	P-7594	28	P-7664	28	P-7742	24, 33	P-7812	37
P-7518	28	P-7595	28	P-7665	28	P-7743	20, 21, 33	P-7813	37
P-7519	28	P-7596	28	P-7666	28	P-7744	20, 21, 33	P-7814	37
P-7520	28	P-7597	28	P-7667	28	P-7745	20, 21, 33	P-7815	37
P-7521	28	P-7598	28	P-7668	28	P-7746	33	P-7816	37
P-7522	28	P-7599	28	P-7669	28	P-7747	33	P-7821	44
P-7523	28	P-7600	28	P-7670	28	P-7748	33	P-7822	44
P-7524	28	P-7601	28	P-7671	28	P-7749	32	P-7823	24, 26, 44
P-7525	28	P-7602	28	P-7672	28	P-7750	32	P-7824	24, 26, 44
P-7526	28	P-7603	28	P-7673	28	P-7751	32	P-7825	44
P-7527	28	P-7604	28	P-7674	28	P-7752	31	P-7826	44
P-7528	28	P-7605	28	P-7675	28	P-7753	31	P-7827	44
P-7529	28	P-7606	28	P-7676	28	P-7754	31	P-7828	44
P-7530	28	P-7607	28	P-7677	28	P-7755	21, 33	P-7829	44
P-7531	28	P-7608	28	P-7678	28	P-7756	21, 33	P-7830	44
P-7532	28	P-7609	28	P-7679	28	P-7757	21, 33	P-7831	31
P-7533	28	P-7610	28	P-7680	28	P-7758	34	P-7832	31
P-7540	51	P-7611	28	P-7681	28	P-7759	34	P-7833	31
P-7541	51	P-7612	28	P-7682	28	P-7760	34	P-7834	31
P-7542	51	P-7613	28	P-7683	28	P-7761	34	P-7835	31
P-7548	51	P-7614	28	P-7684	28	P-7762	34	P-7836	31
P-7549	51	P-7615	28	P-7685	28	P-7763	34	P-7837	31
P-7550	28	P-7616	31	P-7686	28	P-7767	35	P-7838	31
P-7551	28	P-7620	31	P-7687	28	P-7768	35	P-7839	30
P-7552	28	P-7621	31	P-7688	28	P-7769	35	P-7840	30
P-7553	28	P-7622	31	P-7689	28	P-7770	25, 34	P-7841	30
P-7554	28	P-7623	31	P-7690	28	P-7771	25, 34	P-7842	30
P-7555	28	P-7625	34	P-7691	28	P-7772	25, 34	P-7843	30
P-7556	28	P-7627	44	P-7692	28	P-7773	34	P-7844	30
P-7557	28	P-7628	44	P-7693	28	P-7774	34	P-7845	30
P-7558	28	P-7629	46	P-7695	28	P-7775	34	P-7846	30
P-7559	28	P-7630	28	P-7696	28	P-7776	35	P-7847	117
P-7560	28	P-7631	28	P-7697	28	P-7777	35	P-7848	45
P-7561	28	P-7632	28	P-7699	28	P-7778	35	P-7851	38
P-7562	28	P-7633	26, 28	P-7700	28	P-7779	35	P-7852	38
P-7563	28	P-7634	28	P-7701	28	P-7780	35	P-7853	38
P-7564	28	P-7635	28	P-7703	28	P-7781	35	P-7854	38
P-7565	28	P-7636	28	P-7704	28	P-7782	35	P-7855	38
P-7566	28	P-7637	28	P-7705	28	P-7783	35	P-7856	38
P-7567	28	P-7638	28	P-7707	28	P-7784	35	P-7857	38
P-7568	28	P-7639	28	P-7708	28	P-7785	35	P-7858	34
P-7569	28	P-7640	28	P-7709	28	P-7786	35	P-7859	34
P-7570	28	P-7641	28	P-7711	28	P-7787	35	P-7860	37
P-7571	28	P-7642	28	P-7712	28	P-7788	35	P-7861	37
P-7572	28	P-7643	28	P-7713	28	P-7789	35	P-7862	37

INDEX

Part Number To Page Number

P-7863.....37	P-7949.....28	P-8079.....4	P-8193.....36	P-8263.....28
P-7864.....37	P-7950.....28	P-8080.....118	P-8194.....36	P-8264.....28
P-7865.....37	P-7951.....28	P-8081.....49	P-8195.....36	P-8265.....28
P-7866.....37	P-7952.....28	P-8083.....3	P-8196.....36	P-8266.....28
P-7867.....37	P-7953.....28	P-8085.....30	P-8197.....36	P-8267.....28
P-7868.....45	P-7954.....28	P-8086.....30	P-8198.....30	P-8268.....28
P-7869.....45	P-7955.....28	P-8087.....30	P-8199.....30	P-8269.....28
P-7871.....45	P-7956.....28	P-8088.....30	P-8200.....30	P-8270.....28
P-7872.....37	P-7957.....28	P-8089.....30	P-8201.....38	P-8271.....28
P-7873.....37	P-7958.....28	P-8090.....30	P-8203.....38	P-8272.....28
P-7874.....37	P-7959.....28	P-8091.....30	P-8204.....37	P-8273.....28
P-7875.....37	P-7960.....28	P-8092.....30	P-8205.....37	P-8274.....28
P-7876.....37	P-7961.....28	P-8095.....51	P-8206.....38	P-8275.....28
P-7877.....37	P-7962.....28	P-8096.....51	P-8207.....38	P-8276.....28
P-7879.....46	P-7963.....28	P-8098.....51	P-8208.....38	P-8277.....28
P-7880.....46	P-7964.....28	P-8099.....3	P-8210.....38	P-8278.....28
P-7881.....46	P-7965.....28	P-8101-G.....3	P-8211.....38	P-8279.....28
P-7882.....46	P-7968.....28	P-8112.....32	P-8213.....30	P-8280.....28
P-7883.....46	P-7969.....28	P-8113.....32	P-8214.....30	P-8281.....28
P-7884.....46	P-7970.....28	P-8114.....32	P-8215.....30	P-8282.....28
P-7885.....46	P-7971.....28	P-8120.....113	P-8216.....30	P-8283.....7, 28
P-7886.....46	P-7972.....28	P-8121.....29	P-8217.....30	P-8284.....28
P-7887.....46	P-7973.....28	P-8122.....29	P-8218.....30	P-8285.....28
P-7888.....46	P-7974.....28	P-8123.....29	P-8219.....30	P-8286.....28
P-7889.....46	P-7975.....28	P-8124.....29	P-8220.....30	P-8287.....7, 28
P-7890.....46	P-7978.....28	P-8125.....29	P-8221.....44	P-8288.....28
P-7891.....46	P-7979.....28	P-8126.....29	P-8222.....44	P-8289.....28
P-7892.....46	P-7980.....28	P-8127.....29	P-8223.....44	P-8300.....28
P-7893.....46	P-7981.....28	P-8128.....29	P-8224.....44	P-8301.....28
P-7894.....46	P-7982.....28	P-8129.....29	P-8225.....44	P-8302.....28
P-7895.....46	P-7983.....28	P-8130.....29	P-8226.....44	P-8303.....28
P-7896.....46	P-7984.....28	P-8131.....29	P-8227.....38	P-8304.....28
P-7897.....46	P-7985.....28	P-8132.....29	P-8228.....46	P-8305.....28
P-7898.....46	P-7988.....28	P-8133.....29	P-8231.....28	P-8306.....28
P-7900.....46	P-7989.....28	P-8134.....29	P-8232.....28	P-8307.....28
P-7908.....47	P-7990.....46	P-8135.....29	P-8233.....28	P-8308.....28
P-7909.....47	P-7991.....46	P-8136.....29	P-8234.....28	P-8309.....28
P-7910.....47	P-7992.....46	P-8163.....29	P-8235.....28	P-8310.....28
P-7911.....47	P-7993.....46	P-8164.....29	P-8236.....28	P-8311.....28
P-7912.....47	P-7994.....46	P-8167.....29	P-8237.....28	P-8312.....28
P-7913.....47	P-7995.....46	P-8168.....33	P-8238.....28	P-8313.....28
P-7914.....47	P-8046.....37	P-8169.....33	P-8239.....28	P-8314.....28
P-7915.....47	P-8047.....37	P-8170.....33	P-8240.....28	P-8315.....28
P-7916.....47	P-8048.....37	P-8171.....33	P-8241.....28	P-8316.....28
P-7920.....47	P-8049.....37	P-8172.....33	P-8242.....28	P-8317.....28
P-7921.....48	P-8050.....37	P-8173.....33	P-8243.....28	P-8318.....28
P-7922.....48	P-8051.....37	P-8174.....33	P-8244.....28	P-8319.....28
P-7924.....48	P-8052.....37	P-8175.....33	P-8245.....28	P-8320.....28
P-7926.....5	P-8053.....37	P-8176.....33	P-8246.....28	P-8321.....28
P-7927.....5	P-8056.....5	P-8177.....34	P-8247.....28	P-8322.....28
P-7928.....5	P-8058.....46	P-8178.....34	P-8248.....28	P-8324.....30
P-7929.....49	P-8059.....46	P-8179.....34	P-8249.....28	P-8325.....30
P-7930.....49	P-8060-G.....3	P-8180.....36	P-8250.....28	P-8326.....30
P-7931.....49	P-8061.....4	P-8181.....36	P-8251.....28	P-8327.....30
P-7932.....48	P-8062.....49	P-8182.....36	P-8252.....28	P-8328.....29
P-7933.....48	P-8064.....113	P-8183.....36	P-8253.....28	P-8329.....29
P-7940.....28	P-8065.....113	P-8184.....36	P-8254.....28	P-8331.....30
P-7941.....28	P-8066.....113	P-8185.....36	P-8255.....28	P-8332.....30
P-7942.....28	P-8067.....113	P-8186.....36	P-8256.....28	P-8333.....30
P-7943.....28	P-8069.....51	P-8187.....36	P-8257.....28	P-8334.....30
P-7944.....28	P-8070.....51	P-8188.....36	P-8258.....28	P-8335.....30
P-7945.....28	P-8071.....51	P-8189.....36	P-8259.....28	P-8336.....30
P-7946.....28	P-8072.....51	P-8190.....36	P-8260.....28	P-8337.....30
P-7947.....28	P-8076-G.....3	P-8191.....36	P-8261.....28	P-8338.....30
P-7948.....28	P-8077.....4	P-8192.....36	P-8262.....28	P-8350.....7

P-8352.....7	P-8469.....29	PL-14046.....10	PL-14126.....15	PL-14217.....12
P-8353.....40	P-8470.....29	PL-14047.....11	PL-14127.....15	PL-14218.....11
P-8354.....40	P-8471.....29	PL-14048.....11	PL-14131.....15	PL-14219.....11
P-8355.....40	P-8472.....29	PL-14049.....11	PL-14132.....15	PL-14220.....11
P-8356.....40	P-8473.....29	PL-14050.....11	PL-14133.....15	PL-14221.....11
P-8357.....40	P-8474.....29	PL-14051.....11	PL-14134.....17	PL-14222.....11
P-8358.....40	P-8475.....29	PL-14052.....11	PL-14135.....17	PL-14223.....12
P-8359.....41	P-8476.....29	PL-14053.....11	PL-14136.....17	PL-14224.....12
P-8360.....40	P-8477.....29	PL-14054.....11	PL-14137.....17	PL-14225.....12
P-8361.....41	P-8478.....29	PL-14055.....11	PL-14138.....17	PL-14226.....12
P-8362.....41	P-8479.....29	PL-14056.....11	PL-14139.....17	PL-14227.....12
P-8363.....41	P-8481.....29	PL-14057.....11	PL-14140.....17	PL-14228.....13
P-8364.....42	P-8482.....29	PL-14059.....11	PL-14141.....17	PL-14229.....13
P-8365.....42	P-8483.....29	PL-14060.....11	PL-14142.....17	PL-14230.....13
P-8366.....41	P-8484.....29	PL-14061.....11	PL-14145.....18	PL-14231.....10
P-8367.....42	P-8485.....29	PL-14062.....11	PL-14146.....18	PL-14232.....10
P-8368.....42	P-8486.....29	PL-14063.....11	PL-14147.....18	PL-14233.....10
P-8369.....42	P-8487.....29	PL-14065.....11	PL-14148.....18	PL-14234.....10
P-8370.....42	P-8488.....29	PL-14066.....11	PL-14149.....18	PL-14235.....14
P-8371.....41	P-8698.....3	PL-14067.....11	PL-14151.....18	PL-14236.....14
P-8372.....41	P-8699.....3	PL-14068.....11	PL-14152.....20	PL-14237.....14
P-8374.....7	P-8700.....3	PL-14069.....11	PL-14153.....20	PL-14247.....20
P-8381.....113	P-8701.....3	PL-14071.....12	PL-14154.....20	PL-14248.....20
P-8383.....38		PL-14072.....12	PL-14155.....20	PL-14249.....20
P-8384.....38	PL	PL-14073.....12	PL-14156.....20	PL-14250.....8
P-8385.....34	PL-14000.....8	PL-14074.....12	PL-14157.....20	PL-14251.....8
P-8386.....34	PL-14001.....8	PL-14075.....12	PL-14158.....20	PL-14252.....8
P-8387.....34	PL-14002.....8	PL-14077.....12	PL-14159.....20	PL-14253.....8
P-8389.....44	PL-14003.....8	PL-14078.....12	PL-14160.....20	PL-14258.....10
P-8390.....44	PL-14005.....8	PL-14079.....12	PL-14161.....21	PL-14259.....10
P-8395.....29	PL-14006.....8	PL-14080.....12	PL-14162.....21	PL-14260.....10
P-8396.....29	PL-14007.....8	PL-14081.....12	PL-14163.....21	PL-14261.....10
P-8401.....36	PL-14009.....8	PL-14082.....12	PL-14164.....21	PL-14263.....10
P-8402.....36	PL-14010.....8	PL-14083.....12	PL-14165.....21	PL-14264.....10
P-8403.....36	PL-14011.....8	PL-14084.....12	PL-14166.....21	PL-14265.....10
P-8409.....32	PL-14012.....8	PL-14085.....12	PL-14167.....21	PL-14268.....10, 13, 15
P-8410.....31	PL-14013.....8	PL-14086.....12	PL-14168.....21	PL-14269.....10, 13, 15
P-8411.....36	PL-14014.....8	PL-14087.....12	PL-14169.....21	PL-14270.....10, 13, 15
P-8412.....36	PL-14015.....8	PL-14088.....12	PL-14170.....20	PL-14271.....10, 13, 15
P-8413.....31	PL-14016.....8	PL-14089.....13	PL-14171.....20	PL-14272.....11
P-8414.....32	PL-14018.....8	PL-14090.....13	PL-14172.....21	PL-14273.....11
P-8415.....36	PL-14019.....8	PL-14091.....13	PL-14174.....22	PL-14274.....11
P-8416.....31	PL-14020.....8	PL-14092.....13	PL-14175.....22	PL-14275.....11
P-8417.....27, 32	PL-14021.....8	PL-14093.....13	PL-14176.....22	PL-14277.....11
P-8418.....27, 32	PL-14022.....8	PL-14094.....13	PL-14177.....22	PL-14278.....11
P-8419.....27, 32	PL-14023.....8	PL-14095.....13	PL-14178.....22	PL-14279.....11
P-8420.....49	PL-14027.....10	PL-14096.....13	PL-14179.....22	PL-14280.....11
P-8425.....39	PL-14028.....10	PL-14097.....13	PL-14189.....24	PL-14282.....11
P-8426.....39	PL-14029.....10	PL-14098.....13	PL-14190.....24	PL-14283.....11
P-8427.....39	PL-14030.....10	PL-14099.....13	PL-14191.....24	PL-14284.....12
P-8428.....39	PL-14031.....10	PL-14100.....13	PL-14192.....24	PL-14285.....12
P-8429.....39	PL-14032.....10	PL-14101.....13	PL-14193.....24	PL-14286.....12
P-8430.....39	PL-14033.....10	PL-14106.....13	PL-14194.....24	PL-14287.....12
P-8431.....39	PL-14034.....10	PL-14107.....13	PL-14201.....26	PL-14289.....12
P-8432.....39	PL-14035.....10	PL-14108.....13	PL-14202.....26	PL-14290.....12
P-8433.....39	PL-14036.....10	PL-14109.....13	PL-14203.....26	PL-14291.....12
P-8434.....39	PL-14037.....10	PL-14110.....15	PL-14204.....26	PL-14292.....12
P-8435.....46	PL-14038.....10	PL-14111.....15	PL-14205.....26	PL-14294.....12
P-8462.....31	PL-14039.....10	PL-14112.....15	PL-14206.....26	PL-14295.....12
P-8463.....31	PL-14040.....10	PL-14113.....15	PL-14210.....10	PL-14296.....13
P-8464.....31	PL-14041.....10	PL-14120.....15	PL-14211.....10	PL-14297.....13
P-8465.....29	PL-14042.....10	PL-14121.....15	PL-14212.....10	PL-14298.....13
P-8466.....29	PL-14043.....10	PL-14122.....15	PL-14213.....10	PL-14301.....13
P-8467.....29	PL-14044.....10	PL-14123.....15	PL-14214.....12	PL-14302.....13
P-8468.....29	PL-14045.....10	PL-14125.....15	PL-14216.....12	PL-14303.....13

PL-14657.....102	PL-14750.....107	PL-14815.....108	PL-14897.....92	PL-14994.....95
PL-14658.....102	PL-14751.....107	PL-14816.....107	PL-14898.....92	PL-14995.....95
PL-14659.....102	PL-14752.....107	PL-14817.....107	PL-14899.....91	PL-14996.....95
PL-14660.....102	PL-14753.....107	PL-14818.....107	PL-14900.....91	PL-14997.....68
PL-14661.....102	PL-14754.....107	PL-14819.....107	PL-14901.....91	PL-14998.....68
PL-14662.....102	PL-14755.....107	PL-14820.....107	PL-14902.....91	PL-14999.....92
PL-14663.....102	PL-14756.....107	PL-14821.....107	PL-14903.....91	PL-15000.....92
PL-14664.....102	PL-14757.....107	PL-14825.....109	PL-14905.....99	PL-15001.....92
PL-14665.....102	PL-14758.....107	PL-14826.....109	PL-14906.....99	PL-15002.....92
PL-14669.....103	PL-14759.....107	PL-14827.....109	PL-14907.....99	PL-15003.....61
PL-14670.....103	PL-14760.....107	PL-14828.....109	PL-14908.....99	PL-15004.....61
PL-14671.....103	PL-14761.....107	PL-14829.....109	PL-14909.....92	PL-15030.....21, 61
PL-14672.....103	PL-14762.....109	PL-14830.....109	PL-14910.....92	PL-15031.....21, 61
PL-14673.....103	PL-14763.....109	PL-14840.....109	PL-14911.....92	PL-15032.....61
PL-14674.....103	PL-14764.....109	PL-14841.....109	PL-14912.....92	PL-15033.....61
PL-14675.....103	PL-14765.....109	PL-14842.....109	PL-14924.....91	PL-15034.....61
PL-14676.....104	PL-14766.....109	PL-14843.....109	PL-14925.....91	PL-15035.....61
PL-14677.....104	PL-14767.....109	PL-14844.....109	PL-14926.....91	PL-15036.....61
PL-14678.....104	PL-14768.....109	PL-14845.....109	PL-14939.....16	PL-15037.....61
PL-14679.....104	PL-14769.....109	PL-14846.....103	PL-14940.....16	PL-15038.....62
PL-14681.....104	PL-14770.....109	PL-14847.....103	PL-14941.....16	PL-15039.....62
PL-14683.....104	PL-14771.....109	PL-14848.....103	PL-14942.....16	PL-15040.....62
PL-14687.....104	PL-14772.....109	PL-14849.....103	PL-14943.....16	PL-15041.....62
PL-14688.....104	PL-14773.....109	PL-14850.....103	PL-14944.....16	PL-15042.....62
PL-14689.....93	PL-14774.....108	PL-14851.....103	PL-14945.....92	PL-15043.....62
PL-14690.....93	PL-14775.....108	PL-14853.....96	PL-14946.....92	PL-15044.....63
PL-14691.....93	PL-14776.....108	PL-14854.....96	PL-14950.....57	PL-15045.....63
PL-14692.....93	PL-14777.....108	PL-14855.....96	PL-14951.....57	PL-15046.....63
PL-14693.....93	PL-14778.....108	PL-14856.....96	PL-14952 ..24, 25, 26, 57	PL-15047.....63
PL-14694.....93	PL-14779.....108	PL-14857.....96	PL-14953 ..24, 25, 26, 57	PL-15048.....64
PL-14695.....50	PL-14780.....108	PL-14858.....96	PL-14954.....57	PL-15049.....64
PL-14697.....43	PL-14781.....108	PL-14859.....109	PL-14955.....57	PL-15050.....64
PL-14698.....50	PL-14782.....108	PL-14860.....109	PL-14956.....57	PL-15051.....64
PL-14699.....50	PL-14783.....108	PL-14861.....91	PL-14957.....57	PL-15052 ..21, 24-26, 63
PL-14700.....50	PL-14784.....108	PL-14862.....91	PL-14958.....57	PL-15053 ..21, 24-26, 63
PL-14701.....43	PL-14785.....108	PL-14863.....91	PL-14959.....57	PL-15054.....65
PL-14702.....43	PL-14786.....108	PL-14864.....91	PL-14960.....57	PL-15055.....65
PL-14703.....43	PL-14787.....108	PL-14865.....91	PL-14961.....57	PL-15056.....65
PL-14704.....43	PL-14788.....108	PL-14866.....91	PL-14962.....57	PL-15057.....65
PL-14705.....105	PL-14789.....108	PL-14867.....91	PL-14963.....57	PL-15058.....65
PL-14706.....105	PL-14790.....108	PL-14868.....91	PL-14964.....21, 57	PL-15059.....65
PL-14708.....18, 105	PL-14791.....108	PL-14869.....91	PL-14965.....21, 57	PL-15060.....65
PL-14723.....104	PL-14792.....108	PL-14870.....91	PL-14966.....58	PL-15061.....65
PL-14724.....104	PL-14793.....108	PL-14871.....91	PL-14967.....58	PL-15062.....63
PL-14725.....104	PL-14794.....108	PL-14872.....91	PL-14968.....57	PL-15063.....63
PL-14726.....104	PL-14795.....108	PL-14875.....91	PL-14969.....57	PL-15064.....62
PL-14727.....105	PL-14796.....108	PL-14876.....91	PL-14970.....57	PL-15065.....62
PL-14728.....105	PL-14797.....108	PL-14877.....91	PL-14971.....57	PL-15070.....64
PL-14731.....105	PL-14798.....108	PL-14878.....91	PL-14972.....58	PL-15071.....64
PL-14732.....105	PL-14799.....108	PL-14879.....91	PL-14973.....58	PL-15072.....64
PL-14733.....105	PL-14800.....108	PL-14880.....91	PL-14974.....58	PL-15073.....64
PL-14734.....105	PL-14801.....108	PL-14881.....103	PL-14975.....58	PL-15074.....64
PL-14735.....105	PL-14802.....108	PL-14882.....103	PL-14976.....58	PL-15075.....64
PL-14736.....105	PL-14803.....108	PL-14883.....96	PL-14977.....58	PL-15076.....64
PL-14737.....105	PL-14804.....108	PL-14884.....96	PL-14978.....58	PL-15077.....64
PL-14738.....105	PL-14805.....108	PL-14885.....96	PL-14979.....58	PL-15078.....62
PL-14741.....100	PL-14806.....108	PL-14886.....91	PL-14980.....61	PL-15079.....62
PL-14742.....100	PL-14807.....108	PL-14889.....92	PL-14981.....61	PL-15080.....62
PL-14743.....100	PL-14808.....108	PL-14890.....92	PL-14986.....61	PL-15081.....62
PL-14744.....100	PL-14809.....108	PL-14891.....92	PL-14987.....61	PL-15082.....62
PL-14745.....100	PL-14810.....108	PL-14892.....92	PL-14989.....60	PL-15083.....62
PL-14746.....100	PL-14811.....108	PL-14893.....92	PL-14990.....58	PL-15084.....62
PL-14747.....100	PL-14812.....108	PL-14894.....92	PL-14991.....58	PL-15085.....62
PL-14748.....100	PL-14813.....108	PL-14895 ..24, 25, 26, 92	PL-14992.....58	PL-15086.....64
PL-14749.....100	PL-14814.....108	PL-14896 ..24, 25, 26, 92	PL-14993.....58	PL-15087.....64

INDEX

Part Number To Page Number

PL-15088.....64	PL-15177.....66	PL-15263.....74	PL-15356.....54, 79	PL-15429.....84
PL-15089.....64	PL-15178.....71	PL-15266.....105	PL-15357.....79	PL-15430.....84
PL-15090.....65	PL-15179.....71	PL-15267.....105	PL-15358.....54, 79	PL-15431.....84
PL-15091.....65	PL-15180.....70	PL-15270.....73	PL-15359.....79	PL-15432.....84
PL-15092.....65	PL-15181.....70	PL-15271.....73	PL-15360.....24, 26, 79	PL-15433.....84
PL-15093.....65	PL-15182.....70	PL-15272.....73	PL-15361.....24, 26, 79	PL-15434.....84
PL-15094.....17	PL-15183.....70	PL-15273.....73	PL-15362.....24, 26, 79	PL-15435.....84
PL-15095.....17	PL-15188.....61	PL-15276.....62	PL-15363.....24, 26, 79	PL-15436.....84
PL-15096.....63	PL-15189.....61	PL-15277.....62	PL-15368.....80	PL-15437.....84
PL-15097.....63	PL-15190.....96	PL-15300.....76	PL-15369.....80	PL-15438.....84
PL-15098.....65	PL-15191.....96	PL-15301.....76	PL-15370.....80	PL-15439.....84
PL-15099.....65	PL-15192.....96	PL-15302.....76	PL-15371.....80	PL-15440.....84
PL-15100.....65	PL-15196.....70	PL-15303.....76	PL-15372.....80	PL-15441.....84
PL-15101.....65	PL-15197.....70	PL-15304.....25, 76	PL-15373.....80	PL-15442.....84
PL-15102.....63	PL-15212.....71	PL-15305.....25, 76	PL-15374.....80	PL-15443.....84
PL-15103.....63	PL-15213.....71	PL-15306.....25, 76	PL-15375.....80	PL-15444.....54, 85
PL-15104.....63	PL-15214.....71	PL-15307.....25, 76	PL-15376.....80	PL-15445.....85
PL-15105.....63	PL-15215.....71	PL-15308.....76	PL-15377.....80	PL-15446.....85
PL-15110.....62	PL-15216.....71	PL-15309.....76	PL-15378.....80	PL-15447.....85
PL-15111.....62	PL-15217.....71	PL-15310.....76	PL-15379.....80	PL-15448.....85
PL-15112.....63	PL-15218.....71	PL-15311.....76	PL-15380.....80	PL-15449.....85
PL-15113.....63	PL-15219.....71	PL-15312.....79	PL-15381.....80	PL-15450.....85
PL-15130.....66	PL-15220.....71	PL-15313.....79	PL-15382.....80	PL-15451.....85
PL-15131.....66	PL-15221.....71	PL-15314.....76	PL-15383.....80	PL-15452.....85
PL-15132.....24-26, 66	PL-15222.....72	PL-15315.....76	PL-15388.....88	PL-15453.....85
PL-15133.....24-26, 66	PL-15223.....72	PL-15316.....54, 76	PL-15389.....88	PL-15454.....85
PL-15134.....66	PL-15224.....72	PL-15317.....76	PL-15390.....88	PL-15455.....85
PL-15135.....66	PL-15225.....72	PL-15318.....77	PL-15391.....88	PL-15460.....85
PL-15136.....66	PL-15226.....72	PL-15319.....77	PL-15392.....89	PL-15461.....85
PL-15137.....66	PL-15227.....72	PL-15320.....77	PL-15393.....89	PL-15462.....85
PL-15138.....66	PL-15228.....24-26, 73	PL-15321.....77	PL-15394.....89	PL-15463.....85
PL-15139.....66	PL-15229.....24-26, 73	PL-15322.....77	PL-15395.....89	PL-15464.....86
PL-15140.....66	PL-15230.....74	PL-15323.....77	PL-15396.....86	PL-15465.....86
PL-15141.....66	PL-15231.....74	PL-15324.....77	PL-15397.....86	PL-15466.....86
PL-15142.....66	PL-15232.....74	PL-15325.....77	PL-15398.....86	PL-15467.....86
PL-15143.....66	PL-15233.....74	PL-15326.....77	PL-15399.....86	PL-15468.....86
PL-15144.....67	PL-15234.....74	PL-15327.....77	PL-15400.....82	PL-15469.....86
PL-15145.....67	PL-15235.....74	PL-15328.....77	PL-15401.....82	PL-15470.....86
PL-15146.....67	PL-15236.....74	PL-15329.....77	PL-15402.....82	PL-15471.....86
PL-15147.....67	PL-15237.....74	PL-15330.....77	PL-15403.....82	PL-15472.....90
PL-15148.....67	PL-15238.....72	PL-15331.....77	PL-15404.....83	PL-15473.....90
PL-15149.....67	PL-15239.....72	PL-15332.....77	PL-15405.....83	PL-15474.....90
PL-15150.....67	PL-15240.....72	PL-15333.....77	PL-15406.....83	PL-15475.....90
PL-15151.....67	PL-15241.....72	PL-15334.....78	PL-15407.....83	PL-15476.....86
PL-15152.....67	PL-15242.....72	PL-15335.....78	PL-15408.....83	PL-15477.....86
PL-15153.....67	PL-15243.....72	PL-15336.....78	PL-15409.....83	PL-15478.....86
PL-15154.....67	PL-15244.....73	PL-15337.....78	PL-15410.....83	PL-15479.....86
PL-15155.....67	PL-15245.....73	PL-15338.....78	PL-15411.....83	PL-15480.....87
PL-15156.....67	PL-15246.....74	PL-15339.....78	PL-15412.....83	PL-15481.....87
PL-15157.....67	PL-15247.....74	PL-15340.....78	PL-15413.....83	PL-15482.....87
PL-15158.....54, 68	PL-15248.....73	PL-15341.....78	PL-15414.....83	PL-15483.....87
PL-15159.....68	PL-15249.....73	PL-15342.....78	PL-15415.....83	PL-15484.....87
PL-15164.....67	PL-15250.....73	PL-15343.....78	PL-15416.....83	PL-15485.....87
PL-15165.....67	PL-15251.....73	PL-15344.....78	PL-15417.....83	PL-15486.....87
PL-15166.....71	PL-15252.....72	PL-15345.....78	PL-15418.....83	PL-15487.....87
PL-15167.....71	PL-15253.....72	PL-15346.....79	PL-15419.....83	PL-15488.....87
PL-15168.....68	PL-15254.....73	PL-15347.....79	PL-15420.....89	PL-15489.....87
PL-15169.....68	PL-15255.....73	PL-15348.....78	PL-15421.....89	PL-15490.....87
PL-15170.....68	PL-15256.....73	PL-15349.....78	PL-15422.....89	PL-15491.....87
PL-15171.....68	PL-15257.....73	PL-15350.....78	PL-15423.....89	PL-15492.....24-26, 87
PL-15172.....71	PL-15258.....74	PL-15351.....78	PL-15424.....89	PL-15493.....24-26, 87
PL-15173.....71	PL-15259.....74	PL-15352.....79	PL-15425.....89	PL-15494.....24-26, 87
PL-15174.....70	PL-15260.....74	PL-15353.....79	PL-15426.....89	PL-15495.....24-26, 87
PL-15175.....70	PL-15261.....74	PL-15354.....79	PL-15427.....89	PL-15496.....89
PL-15176.....66	PL-15262.....74	PL-15355.....79	PL-15428.....84	PL-15497.....89

PL-15498.....	89	PL-15580.....	112	PL-15680.....	106	PL-15764.....	111	PL-15945.....	17
PL-15499.....	89	PL-15581.....	112	PL-15681.....	106	PL-15765.....	111	PL-15946.....	17
PL-15500.....	114	PL-15582.....	112	PL-15682.....	106	PL-15766.....	6	PL-15947.....	17
PL-15502.....	114	PL-15583.....	112	PL-15683.....	106	PL-15767.....	6	PL-15948.....	17
PL-15503.....	114	PL-15584.....	112	PL-15684.....	106	PL-15768.....	111	PL-15955.....	75
PL-15505.....	114	PL-15600.....	8	PL-15685.....	106	PL-15769.....	111	PL-15956.....	75
PL-15507.....	114	PL-15601.....	8	PL-15686.....	106	PL-15770.....	111	PL-15957.....	75
PL-15508.....	114	PL-15603.....	8	PL-15687.....	106	PL-15800.....	50	PL-15958.....	75
PL-15510.....	114	PL-15604.....	8	PL-15688.....	106	PL-15801.....	50	PL-15959.....	75
PL-15512.....	114	PL-15605.....	8	PL-15689.....	107	PL-15802.....	50	PL-15960.....	75
PL-15513.....	114	PL-15606.....	8	PL-15690.....	107	PL-15803.....	50	PL-15961.....	100
PL-15515.....	114	PL-15607.....	8	PL-15691.....	106	PL-15804.....	50	PL-15962.....	100
PL-15516.....	114	PL-15608.....	8	PL-15692.....	106	PL-15805.....	50	PL-15963.....	100
PL-15517.....	114	PL-15609.....	8	PL-15695.....	107	PL-15806.....	50	PL-15964.....	50
PL-15518.....	114	PL-15610.....	8	PL-15697.....	106	PL-15807.....	50	PL-15965.....	50
PL-15519.....	115	PL-15613.....	10	PL-15698.....	106	PL-15808.....	50	PL-15966.....	20
PL-15521.....	115	PL-15614.....	10	PL-15699.....	95	PL-15809.....	50	PL-15967.....	20
PL-15522.....	115	PL-15615.....	10	PL-15700.....	95	PL-15810.....	50	PL-15968.....	25
PL-15524.....	115	PL-15616.....	10	PL-15701.....	95	PL-15811.....	50	PL-15969.....	25
PL-15526.....	115	PL-15617.....	10	PL-15702.....	95	PL-15812.....	50	PL-15970.....	25
PL-15527.....	115	PL-15618.....	10	PL-15703.....	95	PL-15813.....	50	PL-15971.....	25
PL-15529.....	115	PL-15619.....	10	PL-15704.....	95	PL-15814.....	50	PL-15972.....	25
PL-15531.....	115	PL-15620.....	10	PL-15705.....	95	PL-15815.....	50	PL-15973.....	25
PL-15532.....	115	PL-15621.....	11	PL-15706.....	95	PL-15816.....	50	PL-15974.....	9
PL-15535.....	116	PL-15622.....	11	PL-15707.....	95	PL-15820.....	50	PL-15975.....	9
PL-15536.....	116	PL-15623.....	11	PL-15708.....	95	PL-15821.....	50	PL-15976.....	9
PL-15537.....	116	PL-15624.....	11	PL-15709.....	95	PL-15822.....	50	PL-15977.....	9
PL-15540.....	98	PL-15625.....	11	PL-15710.....	95	PL-15823.....	50	PL-15978.....	9
PL-15541.....	98	PL-15626.....	11	PL-15711.....	95	PL-15824.....	50	PL-15979.....	15
PL-15542.....	98	PL-15627.....	11	PL-15715.....	95	PL-15825.....	50	PL-15980.....	15
PL-15543.....	98	PL-15628.....	11	PL-15719.....	95	PL-15826.....	50	PL-15981.....	15
PL-15544.....	98	PL-15629.....	12	PL-15723.....	116	PL-15827.....	50	PL-15982.....	15
PL-15545.....	98	PL-15630.....	12	PL-15724.....	116	PL-15828.....	50	PL-15983.....	15
PL-15546.....	98	PL-15631.....	12	PL-15725.....	116	PL-15829.....	50	PL-15984.....	75
PL-15547.....	98	PL-15632.....	12	PL-15726.....	97	PL-15830.....	50	PL-15985.....	75
PL-15548.....	98	PL-15633.....	12	PL-15727.....	97	PL-15831.....	50	PL-15986.....	107
PL-15549.....	98	PL-15634.....	13	PL-15728.....	97	PL-15832.....	50	PL-15987.....	107
PL-15550.....	98	PL-15635.....	13	PL-15729.....	100	PL-15833.....	50	PL-15988.....	107
PL-15551.....	98	PL-15636.....	13	PL-15730.....	14	PL-15834.....	50	PL-15989.....	14
PL-15552.....	100	PL-15637.....	13	PL-15731.....	14	PL-15835.....	50	PL-15991.....	14
PL-15553.....	100	PL-15638.....	13	PL-15732.....	14	PL-15836.....	50	PL-15992.....	14
PL-15554.....	100	PL-15639.....	13	PL-15735.....	93	PL-15918.....	111	PL-15998.....	10
PL-15555.....	107	PL-15640.....	13	PL-15736.....	93	PL-15919.....	111	PL-15999.....	10
PL-15556.....	107	PL-15641.....	15	PL-15738.....	93	PL-15920.....	111	PL-16000.....	10
PL-15559.....	101	PL-15642.....	15	PL-15739.....	93	PL-15924.....	8	PL-16003.....	107
PL-15560.....	101	PL-15643.....	15	PL-15741.....	93	PL-15925.....	114	PL-16004.....	107
PL-15561.....	101	PL-15644.....	15	PL-15742.....	93	PL-15926.....	114	PL-16008.....	98
PL-15562.....	101	PL-15645.....	15	PL-15744.....	93	PL-15927.....	114	PL-16010.....	98
PL-15563.....	102	PL-15646.....	15	PL-15745.....	93	PL-15928.....	114	PL-16011.....	101
PL-15564.....	102	PL-15647.....	15	PL-15747.....	93	PL-15929.....	114	PL-16012.....	101
PL-15565.....	102	PL-15648.....	14	PL-15748.....	93	PL-15930.....	114	PL-16013.....	101
PL-15566.....	102	PL-15649.....	14	PL-15750.....	97	PL-15931.....	114	PL-16014.....	10
PL-15567.....	102	PL-15650.....	14	PL-15751.....	97	PL-15932.....	114	PL-16015.....	10
PL-15568.....	102	PL-15651.....	14	PL-15752.....	97	PL-15933.....	114	PL-16016.....	10
PL-15569.....	102	PL-15652.....	14	PL-15753.....	99	PL-15934.....	114	PL-16017.....	11
PL-15570.....	102	PL-15653.....	14	PL-15754.....	99	PL-15935.....	115	PL-16018.....	11
PL-15571.....	102	PL-15664.....	16	PL-15755.....	99	PL-15936.....	115	PL-16019.....	11
PL-15572.....	102	PL-15665.....	16	PL-15756.....	6	PL-15937.....	115	PL-16020.....	11
PL-15573.....	102	PL-15666.....	16	PL-15757.....	6	PL-15938.....	115	PL-16021.....	12
PL-15574.....	102	PL-15667.....	16	PL-15758.....	6	PL-15939.....	115	PL-16022.....	12
PL-15575.....	112	PL-15675.....	105	PL-15759.....	6	PL-15940.....	115	PL-16023.....	12
PL-15576.....	112	PL-15676.....	105	PL-15760.....	111	PL-15941.....	115	PL-16024.....	12
PL-15577.....	112	PL-15677.....	105	PL-15761.....	111	PL-15942.....	115	PL-16025.....	13
PL-15578.....	112	PL-15678.....	105	PL-15762.....	111	PL-15943.....	17	PL-16026.....	13
PL-15579.....	112	PL-15679.....	106	PL-15763.....	111	PL-15944.....	17	PL-16027.....	13

INDEX

Part Number To Page Number

PL-16028.....10, 13, 15	PL-16135.....111	PL-16260.....81	PL-16328.....69	PL-16447.....27
PL-16029.....11	PL-16136.....111	PL-16261.....81	PL-16329.....69	PL-16448.....27
PL-16030.....12	PL-16138.....10	PL-16262.....81	PL-16330.....69	PL-16449.....27
PL-16031.....13	PL-16139.....10	PL-16263.....7	PL-16331.....69	PL-16450.....99
PL-16036.....50	PL-16156.....12	PL-16264.....7	PL-16350.....61	PL-16451.....99
PL-16037.....50	PL-16157.....12	PL-16265.....7	PL-16351.....61	PL-16452.....99
PL-16039.....17	PL-16158.....12	PL-16266.....70	PL-16352.....60	PL-16453.....99
PL-16040.....25, 88	PL-16159.....12	PL-16267.....70	PL-16353.....60	PL-16454.....99
PL-16041.....25, 88	PL-16160.....43	PL-16268.....61	PL-16354.....60	PL-16455.....99
PL-16042.....25, 88	PL-16172.....43	PL-16269.....61	PL-16355.....60	PL-16456.....97
PL-16043.....25, 88	PL-16173.....43	PL-16270.....59	PL-16356.....82	PL-16457.....97
PL-16044.....81	PL-16174.....106	PL-16271.....59	PL-16357.....82	PL-16458.....97
PL-16045.....81	PL-16175.....106	PL-16272.....60	PL-16358.....81	PL-16459.....97
PL-16046.....81	PL-16182.....94	PL-16273.....60	PL-16359.....81	PL-16460.....97
PL-16047.....81	PL-16183.....94	PL-16274.....59	PL-16360.....81	PL-16461.....97
PL-16048.....105	PL-16184.....94	PL-16275.....59	PL-16361.....81	PL-16463.....39
PL-16049.....105	PL-16185.....94	PL-16276.....21	PL-16362.....14	PL-16464.....112
PL-16050.....88	PL-16186.....94	PL-16276.....59	PL-16363.....14	PL-16470.....103
PL-16051.....88	PL-16187.....94	PL-16277.....21, 59	PL-16364.....14	PL-16472.....11
PL-16052.....88	PL-16188.....94	PL-16278.....58	PL-16365.....14	PL-16473.....11
PL-16053.....88	PL-16189.....94	PL-16279.....58	PL-16367.....14	PL-16474.....8
PL-16062.....43	PL-16190.....94	PL-16280.....69	PL-16368.....14	PL-16476.....12
PL-16063.....43	PL-16191.....94	PL-16281.....69	PL-16369.....14	PL-16477.....8
PL-16066.....43	PL-16192.....94	PL-16282.....70	PL-16370.....14	PL-16478.....103
PL-16068.....109	PL-16193.....94	PL-16283.....70	PL-16371.....13	PL-16479.....106
PL-16069.....109	PL-16194.....94	PL-16284.....60	PL-16372.....13	PL-16480.....106
PL-16070.....8	PL-16195.....94	PL-16285.....60	PL-16373.....13	PL-16495.....11
PL-16071.....8	PL-16196.....94	PL-16286.....60	PL-16374.....13	PL-16496.....11
PL-16074.....88	PL-16197.....94	PL-16287.....60	PL-16383.....14	PL-16498.....94
PL-16075.....88	PL-16198.....94	PL-16288.....60	PL-16384.....14	PL-16499.....94
PL-16076.....88	PL-16199.....94	PL-16289.....60	PL-16385.....14	PL-16500.....94
PL-16077.....88	PL-16200.....94	PL-16290.....59	PL-16387.....14	PL-16501.....94
PL-16078.....12	PL-16201.....94	PL-16291.....59	PL-16388.....14	PL-16502.....94
PL-16079.....12	PL-16202.....94	PL-16292.....70	PL-16389.....14	PL-16503.....94
PL-16080.....16	PL-16203.....94	PL-16293.....70	PL-16390.....14	PL-16504.....94
PL-16081.....16	PL-16204.....94	PL-16294.....69	PL-16391.....14	PL-16505.....94
PL-16082.....16	PL-16205.....94	PL-16295.....69	PL-16392.....14	PL-16506.....94
PL-16083.....90	PL-16206.....94	PL-16296.....70	PL-16393.....106	PL-16507.....94
PL-16084.....90	PL-16207.....94	PL-16297.....70	PL-16394.....106	PL-16508.....94
PL-16085.....68	PL-16208.....94	PL-16298.....60	PL-16395.....108	PL-16509.....94
PL-16086.....68	PL-16215.....112	PL-16299.....60	PL-16396.....108	PL-16510.....94
PL-16087.....68	PL-16216.....112	PL-16300.....60	PL-16397.....108	PL-16511.....94
PL-16088.....68	PL-16217.....112	PL-16301.....60	PL-16404.....12	PL-16512.....94
PL-16105.....24	PL-16218.....112	PL-16302.....60	PL-16405.....12	PL-16513.....94
PL-16106.....24	PL-16229.....10	PL-16303.....60	PL-16411.....25	PL-16514.....94
PL-16107.....24	PL-16230.....10	PL-16304.....68	PL-16412.....25	PL-16515.....94
PL-16108.....24	PL-16241.....22	PL-16305.....68	PL-16413.....25	PL-16516.....94
PL-16109.....26	PL-16242.....22	PL-16306.....68	PL-16414.....25	PL-16517.....94
PL-16110.....26	PL-16243.....22	PL-16307.....68	PL-16419.....16	PL-16518.....94
PL-16111.....26	PL-16244.....22	PL-16312.....69	PL-16420.....16	PL-16519.....94
PL-16112.....26	PL-16245.....22	PL-16313.....69	PL-16424.....16	PL-16520.....94
PL-16113.....21	PL-16246.....22	PL-16314.....69	PL-16425.....111	PL-16521.....94
PL-16114.....21	PL-16247.....82	PL-16315.....69	PL-16426.....111	PL-16522.....94
PL-16115.....21	PL-16248.....82	PL-16316.....69	PL-16427.....111	PL-16523.....94
PL-16116.....103	PL-16249.....82	PL-16317.....69	PL-16435.....106	PL-16524.....94
PL-16117.....103	PL-16250.....82	PL-16318.....69	PL-16436.....106	PL-16525.....111
PL-16124.....17	PL-16251.....82	PL-16319.....69	PL-16438.....7	PL-16526.....111
PL-16127.....7	PL-16252.....82	PL-16320.....59	PL-16439.....7	PL-16527.....111
PL-16128.....7	PL-16253.....82	PL-16321.....59	PL-16440.....100	PL-16528.....111
PL-16129.....7	PL-16254.....82	PL-16322.....59	PL-16441.....16	PL-16558.....21
PL-16130.....101	PL-16255.....81	PL-16323.....59	PL-16442.....16	PL-16559.....21
PL-16131.....7	PL-16256.....81	PL-16324.....59	PL-16443.....27	PL-16529.....95
PL-16132.....7	PL-16257.....81	PL-16325.....59	PL-16444.....27	PL-16530.....95
PL-16133.....7	PL-16258.....81	PL-16326.....59	PL-16445.....27	PL-16531.....95
PL-16134.....111	PL-16259.....81	PL-16327.....59	PL-16446.....27	PL-16532.....95

PL-16533.....	95	PL-7749.....	97	PL-7846.....	101	PL-7938.....	94	PL-8032.....	92
PL-16534.....	95	PL-7750.....	98	PL-7847.....	101	PL-7939.....	107	PL-8033.....	92
PL-16535.....	95	PL-7751.....	98	PL-7849.....	101	PL-7940.....	107	PL-8034.....	97
PL-16536.....	95	PL-7752.....	98	PL-7856.....	19	PL-7941.....	107	PL-8035.....	99
PL-16537.....	95	PL-7753.....	98	PL-7857.....	19	PL-7942.....	107	PL-8036.....	19
PL-16538.....	95	PL-7754.....	98	PL-7858.....	19	PL-7943.....	109	PL-8037.....	19
PL-16539.....	95	PL-7755.....	98	PL-7871.....	12	PL-7944.....	109	PL-8038.....	19
PL-16540.....	95	PL-7756.....	99	PL-7873.....	11	PL-7945.....	109	PL-8039.....	19
PL-16541.....	95	PL-7758.....	100	PL-7877.....	94	PL-7946.....	109	PL-8040.....	19
PL-16542.....	95	PL-7759.....	100	PL-7878.....	94	PL-7947.....	108	PL-8041.....	19
PL-16543.....	95	PL-7760.....	101	PL-7879.....	94	PL-7948.....	108	PL-8042.....	19
PL-16544.....	95	PL-7761.....	102	PL-7880.....	94	PL-7949.....	108	PL-8043.....	19
PL-16545.....	95	PL-7762.....	102	PL-7881.....	94	PL-7950.....	108	PL-8044.....	19
PL-16546.....	95	PL-7765.....	97	PL-7882.....	94	PL-7951.....	108	PL-8045.....	7
PL-16547.....	95	PL-7766.....	104	PL-7883.....	94	PL-7952.....	108	PL-8047.....	7
PL-16548.....	95	PL-7768.....	102	PL-7884.....	94	PL-7953.....	108	PL-8048.....	6
PL-16549.....	95	PL-7770.....	95	PL-7885.....	94	PL-7954.....	108	PL-8049.....	95
PL-16550.....	95	PL-7771.....	95	PL-7886.....	94	PL-7955.....	108	PL-8050.....	95
PL-16551.....	95	PL-7772.....	95	PL-7887.....	94	PL-7956.....	108	PL-8051.....	95
PL-16552.....	95	PL-7773.....	95	PL-7888.....	94	PL-7957.....	108	PL-8052.....	95
PL-16553.....	95	PL-7774.....	95	PL-7889.....	94	PL-7958.....	108	PL-8084.....	99
PL-16554.....	95	PL-7775.....	95	PL-7890.....	94	PL-7959.....	108	PL-8085.....	99
PL-16555.....	95	PL-7776.....	100	PL-7891.....	94	PL-7960.....	108	PL-8086.....	99
PL-16558.....	21	PL-7788.....	95	PL-7893.....	94	PL-7961.....	107	PL-8087.....	99
PL-16559.....	21	PL-7790.....	95	PL-7894.....	94	PL-7962.....	107	PL-8096.....	12
PL-16588.....	96	PL-7794.....	17	PL-7896.....	94	PL-7964.....	109	PL-8099.....	6
PL-16589.....	96	PL-7795.....	19	PL-7897.....	94	PL-7965.....	109	PL-8100.....	6
PL-16590.....	96	PL-7796.....	19	PL-7899.....	94	PL-7966.....	109	PL-8101.....	101
PL-16591.....	96	PL-7797.....	19	PL-7900.....	94	PL-7967.....	109	PL-8102.....	101
PL-16592.....	96	PL-7798.....	119	PL-7901.....	94	PL-7968.....	107	PL-8103.....	101
PL-16593.....	96	PL-7799.....	119	PL-7902.....	94	PL-7970.....	93	PL-8104.....	101
PL-16594.....	14	PL-7800.....	19	PL-7903.....	94	PL-7971.....	93	PL-8105.....	101
PL-16595.....	14	PL-7801.....	19	PL-7904.....	94	PL-7972.....	93	PL-8106.....	101
PL-15596.....	14	PL-7802.....	19	PL-7905.....	95	PL-7975.....	97	PL-8110.....	98
PL-7718.....	13	PL-7803.....	19	PL-7906.....	95	PL-7976.....	105	PL-8111.....	107
PL-7719.....	13	PL-7804.....	19	PL-7907.....	95	PL-7977.....	105	PL-8113.....	107
PL-7720.....	13	PL-7805.....	19	PL-7908.....	95	PL-7978.....	106	PL-8121.....	95
PL-7721.....	11	PL-7806.....	19	PL-7909.....	95	PL-7979.....	106	PL-8122.....	102
PL-7722.....	11	PL-7807.....	19	PL-7910.....	95	PL-7980.....	106	PL-8123.....	54
PL-7723.....	11	PL-7808.....	19	PL-7911.....	95	PL-7981.....	106	PL-8124.....	56
PL-7724.....	10	PL-7809.....	19	PL-7912.....	95	PL-7982.....	106	PL-8125.....	56
PL-7725.....	10	PL-7810.....	19	PL-7913.....	95	PL-7983.....	106	PL-8126.....	55
PL-7726.....	10	PL-7811.....	19	PL-7914.....	95	PL-7984.....	107	PL-8127.....	55
PL-7727.....	12	PL-7812.....	19	PL-7915.....	95	PL-7985.....	103	PL-8128.....	55
PL-7728.....	12	PL-7813.....	19	PL-7916.....	95	PL-7986.....	103	PL-8129.....	56
PL-7729.....	12	PL-7814.....	19	PL-7917.....	95	PL-7987.....	104	PL-8130.....	56
PL-7730.....	94	PL-7815.....	19	PL-7918.....	95	PL-7988.....	106	PL-8135.....	102
PL-7731.....	94	PL-7816.....	19	PL-7919.....	97	PL-7989.....	107	PL-8136.....	102
PL-7732.....	94	PL-7817.....	19	PL-7920.....	97	PL-7991.....	53	PL-8139.....	92
PL-7733.....	94	PL-7818.....	19	PL-7921.....	99	PL-7992.....	53	PL-8140.....	106
PL-7734.....	94	PL-7819.....	19	PL-7922.....	100	PL-7993.....	53	PL-8141.....	104
PL-7735.....	94	PL-7820.....	19	PL-7924.....	102	PL-7994.....	53	PL-8142.....	99
PL-7736.....	94	PL-7821.....	19	PL-7925.....	102	PL-7995.....	54	PL-8143.....	99
PL-7737.....	94	PL-7822.....	19	PL-7926.....	103	PL-7996.....	54	PL-8144.....	99
PL-7738.....	95	PL-7823.....	19	PL-7927.....	104	PL-8000.....	22	PL-8145.....	10
PL-7739.....	95	PL-7836.....	19	PL-7928.....	104	PL-8001.....	22	PL-8146.....	18
PL-7740.....	95	PL-7837.....	19	PL-7929.....	104	PL-8002.....	22	PL-8147.....	18
PL-7741.....	95	PL-7838.....	19	PL-7930.....	94	PL-8003.....	22	PL-8148.....	18
PL-7742.....	95	PL-7839.....	19	PL-7931.....	94	PL-8006.....	104	PL-8149.....	106
PL-7743.....	95	PL-7840.....	19	PL-7932.....	94	PL-8007.....	104	PL-8150.....	108
PL-7744.....	96	PL-7841.....	19	PL-7933.....	94	PL-8009.....	93	PL-8151.....	99
PL-7745.....	96	PL-7842.....	94	PL-7934.....	94	PL-8028.....	93	PL-8152.....	12
PL-7746.....	96	PL-7843.....	94	PL-7935.....	94	PL-8029.....	93	PL-8153.....	103
PL-7747.....	96	PL-7844.....	94	PL-7936.....	94	PL-8030.....	93	PL-8163.....	16
PL-7748.....	96	PL-7845.....	102	PL-7937.....	94	PL-8031.....	93	PL-8164.....	6

INDEX

Part Number To Page Number

PL-8165.....	6	ZZ-466	119
PL-8166.....	6	ZZ-98	118
PL-8167.....	106	ZZ-99	118
PL-8168.....	99		
PL-8169.....	97		
PL-8170.....	97		
PL-8461.....	106		

S

SCP-7503.....	51
SCP-7505.....	51
SCP-7549.....	51
SCP-8095.....	51
SCP-8096.....	51
SCP-8098.....	51

T

T-8658.....	24, 26, 44
T-8659.....	44
T-8680.....	41
T-8681.....	41
T-8695.....	44
T-8696.....	44
T-8697.....	44
T-8698.....	44
T-8699.....	44
T-8700.....	40
T-8701.....	40
T-8702.....	40
T-8703.....	40
T-8704.....	40
T-8705.....	40
T-8706.....	41
T-8707.....	40
T-8708.....	41
T-8709.....	41
T-8710.....	41
T-8711.....	42
T-8712.....	42
T-8713.....	41
T-8714.....	42
T-8715.....	42
T-8716.....	42
T-8717.....	42
T-8722.....	44
T-8741.....	44
T-8742.....	105
T-8743.....	105
T-8744.....	105
T-8745.....	105
T-8749.....	44

ZZ

ZZ-101.....	118
ZZ-103.....	118
ZZ-11.....	119
ZZ-124.....	118
ZZ-127.....	117
zz-140.....	118
ZZ-233.....	118
ZZ-286.....	117
ZZ-305.....	118
ZZ-306.....	117
ZZ-313.....	117
ZZ-328.....	118

DECIMAL & MILLIMETER EQUIVALENT CHART

FRACTION	DECIMAL	MM
	1/64	.0156 0.396
	1/32	.0312 0.793
	3/64	.0468 1.190
1/16		.0625 1.587
	5/64	.0781 1.984
	3/32	.0937 2.381
	7/64	.1093 2.778
1/8		.125 3.175
	9/64	.1406 3.571
	5/32	.1562 3.968
	11/64	.1718 4.365
3/16		.1875 4.762
	13/64	.2031 5.159
	7/32	.2187 5.556
	15/64	.2343 5.953
1/4		.250 6.350
	17/64	.2656 6.746
	9/32	.2812 7.143
	19/64	.2968 7.540
5/16		.3125 7.937
	21/64	.3281 8.334
	11/32	.3437 8.731
	23/64	.3593 9.128
3/8		.375 9.525
	25/64	.3906 9.921
	13/32	.4062 10.318
	27/64	.4218 10.715
7/16		.4375 11.112
	29/64	.4531 11.509
	15/32	.4687 11.906
	31/64	.4843 12.303
1/2		.500 12.700

FRACTION	DECIMAL	MM
	33/64	.5156 13.096
	17/32	.5312 13.493
	35/64	.5468 13.890
9/16		.5625 14.287
	37/64	.5781 14.684
	19/32	.5937 15.081
	39/64	.6093 15.478
5/8		.625 15.875
	41/64	.6406 16.271
	21/32	.6562 16.668
	43/64	.6718 17.065
11/16		.6875 17.462
	45/64	.7031 17.859
	23/32	.7187 18.256
	47/64	.7343 18.653
3/4		.750 19.050
	49/64	.7656 19.446
	25/32	.7812 19.843
	51/64	.7968 20.240
13/16		.8125 20.637
	53/64	.8281 21.034
	27/32	.8437 21.431
	55/64	.8593 21.828
7/8		.875 22.225
	57/64	.8906 22.621
	29/32	.9062 23.018
	59/64	.9218 23.415
15/16		.9375 23.812
	61/64	.9531 24.209
	31/32	.9687 24.606
	63/64	.9843 25.003
1		1.000 25.400





primeline.net



Facebook



Twitter



Google+



YouTube



CONNECT With Prime-Line

26950 San Bernardino Ave., Redlands, CA 92374
(800) 255-3505 • FAX (909) 880-2906