

High Pressure

# Global G2 2-Wire Braid Hose – SAE 100R2 Type AT



(Meets Flame Resistance Acceptance Designation "U.S. MSHA 2G")

**Recommended For:** High pressure hydraulic oil lines. Meets or exceeds the requirements of SAE 100R2AT and SAE 100R2 Type S and performance requirements of EN 853 2SN.

**Tube:** Black, oil-resistant synthetic rubber (Nitrile – Type C)\*.

**Reinforcement:** Two braids of high-tensile steel wire.

**Cover:** Black, oil and abrasion resistant thin synthetic rubber (Modified Nitrile – Type C<sub>2</sub>)\*.

**Temperature Range:** -40°F to +212°F (-40°C to +100°C). For water emulsions, etc., see page C8.

**Couplings (see crimp manual for specifics):**

MegaCrimp® Couplings (except -24 and -32), pages E11-46.  
Permanent PC Couplings (-24 and -32), pages E48-65.  
Field Attachable "Type T" Couplings, pages E66-72.



## SPECIFICATIONS

Description	Part No. (50' Length)	Part No. (100' Length Reel) ③	Part No. (Bulk Carton)	Part No. (Bulk Reel)	Product No. (Bulk Carton)	Hose I.D. (In.)	Hose O.D. (In.)	Working Pressure (psi)	Min. Burst Pressure (psi)	Min. Bend Radius (In.)	Approx. Bulk Carton Length (Ft.)	Bulk Reel Length (Ft.)
3G2	86620	—	70233	—	4657-0020	3/16	0.52	6,000	24,000	3.5	425	—
4G2	86621	—	70234	70605	4657-0625	1/4	0.58	5,800	23,200	4.0	335	550
6G2	86622	86632	70235	70606	4657-0626	3/8	0.73	4,800	19,200	5.0	300	400
8G2	86623	86634	70236	70607	4657-0627	1/2	0.86	4,000	16,000	7.0	275	330
10G2	86626	—	70237	70610	4657-0019	5/8	0.98	3,625	14,500	8.0	200	220
12G2	86624	86635 ③	70238	70608	4657-0620	3/4	1.14	3,100	12,400	9.5	175	220
16G2	86625	—	70239	70609	4657-0621	1	1.48	2,400	9,600	12.0	100	165
20G2	—	86627 ②	70240	—	4657-0644	1-1/4	1.87	1,825	7,300	16.5	100	—
24G2	86648	86628 ②	70319	—	4657-2491	1-1/2	2.15	1,300	5,000	20.0	100	—
32G2	86649	86629 ②	70320	—	4657-2492	2	2.65	1,175	4,500	25.0	100	—

② = 25 ft. length    ③ = 50 ft. Reel    ④ = Not necessarily one continuous length

High Pressure

# MegaTech™ II ACP Hot Oil/Air Pressure Line – SAE 100R2 Type AT

**Recommended For:** Multipurpose high-pressure, high-temperature, air compressor lines, petroleum-base or phosphate ester hydraulic fluid supplies. Meets or exceeds the requirements of SAE 100R2AT and SAE 100R2 Type S.

**Tube:** Black, oil-resistant synthetic rubber. (CPE—Type J)\*.

**Reinforcement:** Two braids of high-tensile steel wire.

**Cover:** Black, oil and abrasion-resistant polyester braid.

**Temperature Range:** -40°F. to +300°F (-40°C to 149°C). For water emulsions, see page C8.

**Couplings (see crimp manual for specifics):**

Permanent, Power Crimp® PC Couplings, pages E48-65.

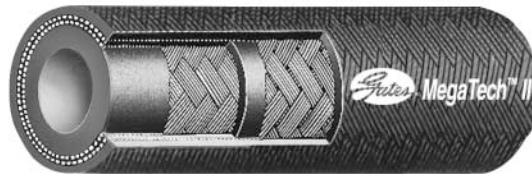

## SPECIFICATIONS

Description	Part No.	Product No.	Hose I.D. (In.)	Hose O.D. (In.)	Working Pressure (psi)	Min. Burst Pressure (psi)	Min. Bend Radius (In.)	Approx. Bulk Carton Length (Ft.)
24ACP	70858	4657-2484	1-1/2	2.13	1,500	6,000	20.0	100
32ACP	70859	4657-2485	2	2.61	1,300	5,200	25.0	100

EQUIPMENT

HOSE/CPLG. SELECTION

TECH. DATA

EXT. & VERY HIGH PRESS. HOSE

GS CPLGS.

PCM CPLGS.

PCS CPLGS.

HIGH & MED. PRESS. HOSE

MEGACRIMP® CPLGS.

PC CPLGS.

FIELD ATTACHABLE CPLGS.

AIR BRAKE HOSE & CPLGS.

MEGATECH™/C5 HOSE & CPLGS.

LOW PRESS. HOSE & CPLGS.

C14 HOSE & CPLGS.

POLARSEAL® HOSE & CPLGS.

PWR. STG. HOSE & CPLGS.

THERMO-PLASTIC HOSE & CPLGS.

ADAPTERS

QUICK DISCONNECT CPLGS.

ACCESSORIES & ASSORTMENTS

PART NUMBER INDEXES

\* Hose stock specifications on page C7.



# Global G2L PolarFlex™ Hose – SAE 100R2 Type AT

High Pressure

EQUIPMENT
HOSE/CPLG. SELECTION
TECH. DATA
EXT. & VERY HIGH PRESS. HOSE
GS CPLGS.
PCM CPLGS.
PCS CPLGS.
HIGH & MED. PRESS. HOSE
MEGACRIMP® CPLGS.
PC CPLGS.
FIELD ATTACHABLE CPLGS.

(Meets Flame Resistance Acceptance Designation "U.S. MSHA 2G")

**Recommended For:** High pressure hydraulic oil lines. Meets or exceeds the requirements of SAE 100R2AT and SAE 100R2 Type S and performance requirements of EN 853 2SN.

**Tube:** Black, oil-resistant synthetic rubber (Nitrile – Type C)\*.

**Reinforcement:** Two braids of high-tensile steel wire.

**Cover:** Black, oil and abrasion resistant thin synthetic rubber (Neoprene – Type A)\*.

**Temperature Range:** -70°F to +212°F (-57°C to +100°C). For water emulsions, etc., see page C8.

**Couplings (see crimp manual for specifics):**

MegaCrimp® Couplings (except -24), pages E11-46.

Permanent PC Couplings (-24), pages E48-65.

Field Attachable "Type T" Couplings, pages E66-72.



SPECIFICATIONS									
Description	Part No. (50' Length)	Part No. (Bulk Reel)	Product No. (Bulk Reel)	Hose I.D. (In.)	Hose O.D. (In.)	Working Pressure (psi)	Min. Burst Pressure (psi)	Min. Bend Radius (In.)	Bulk Reel Length (Ft.)
4G2L	85732	70286	4657-2202	1/4	0.58	5,800	23,200	4.0	440
6G2L	85733	70287	4657-2203	3/8	0.73	4,800	19,200	5.0	385
8G2L	85734	70290	4657-2204	1/2	0.86	4,000	16,000	7.0	330
10G2L	85735	70291	4657-2205	5/8	0.98	3,625	14,500	8.0	220
12G2L	85736	70292	4657-2206	3/4	1.14	3,100	12,400	9.5	220
16G2L	85737	70293	4657-2207	1	1.48	2,400	9,600	12.0	165
20G2L	—	70294	4657-2208	1-1/4	1.87	1,825	7,300	16.5	110
24G2L	—	70314	4657-2315	1-1/2	2.20	1,300	5,200	20.0	120

AIR BRAKE HOSE & CPLGS.
MEGATECH™ C5 HOSE & CPLGS.
LOW PRESS. HOSE & CPLGS.
C14 HOSE & CPLGS.

# M2T® Megaflex® 2-Wire Braid Hose – SAE 100R16

High Pressure

(Meets Flame Resistance Acceptance Designation "U.S. MSHA 2G")

**Recommended For:** High pressure hydraulic oil lines. Meets SAE 100R16. M2T hose has smaller exterior dimensions and significantly tighter bend radius.

**Tube:** Black, oil resistant, synthetic rubber (Nitrile – Type C)\*.

**Reinforcement:** Two braids of high tensile steel wire.

**Cover:** Black, oil, abrasion and weather resistant, synthetic rubber (Modified Nitrile – Type C)\*. Dual green stripe layline. Available with unique abrasion-resistant MegaTuff® cover.

**Temperature Range:** -40°F to +212°F (-40°C to +100°C). For water emulsions, etc., see page C8.

**Couplings (see crimp manual for specifics):**

MegaCrimp® Couplings, pages E11-46.

Permanent Stainless Steel PC Couplings, pages E48-49.



SPECIFICATIONS									
Description	Part No. (50' Length)	Part No. (Bulk Reel)	Product No. (Bulk Reel)	Hose I.D. (In.)	Hose O.D. (In.)	Working Pressure (psi)	Min. Burst Pressure (psi)	Min. Bend Radius (In.)	Bulk Reel Length (Ft.)
4M2T	85600	70390	4657-1552	1/4	0.54	5,000	20,000	2.0	550
6M2T	85601	70391	4657-1555	3/8	0.69	4,000	16,000	2.5	385
8M2T	85602	70392	4657-1559	1/2	0.81	3,500	14,000	3.5	330
10M2T	85603	70393	4657-1563	5/8	0.95	3,000	12,000	4.0	220
12M2T	85604	70394	4657-1567	3/4	1.10	2,250	9,000	4.8	220
16M2T	85605	70395	4657-1571	1	1.38	2,000	8,000	6.0	165

POLARSEAL® HOSE & CPLGS.
PWR. STG. HOSE & CPLGS.
THERMO-PLASTIC HOSE & CPLGS.
ADAPTERS
QUICK DISCONNECT CPLGS.
ACCESSORIES & ASSORTMENTS
PART NUMBER INDEXES

### MEGATUFF® COVER SPECIFICATIONS

MegaTuff® hose lasts up to 300 times longer than standard hose during hose-to-hose and hose-to-metal abrasion tests per ISO 6945.

4M2T-MTF	85534	70387	4657-0222	1/4	0.54	5,000	20,000	2.0	350
6M2T-MTF	85535	70388	4657-0223	3/8	0.69	4,000	16,000	2.5	330
8M2T-MTF	85536	70389	4657-0224	1/2	0.81	3,500	14,000	3.5	330
10M2T-MTF	85537	70407	4657-0225	5/8	0.95	3,000	12,000	4.0	220
12M2T-MTF	85538	70408	4657-0226	3/4	1.10	2,250	9,000	4.8	220
16M2T-MTF	85539	70409	4657-0227	1	1.38	2,000	8,000	6.0	165

\* Hose stock specifications on page C7.

High Pressure

# GM2T Megaflex® Connected Twin-line 2-Wire Braid 3Hose – SAE 100R16



(Meets Flame Resistance Acceptance Designation “U.S. MSHA 2G”)

**Recommended For:** High pressure hydraulic oil lines. Meets SAE 100R16 requirements. CM2T hose has smaller exterior dimensions and significantly tighter bend radius. Exceeds performance standards of EN 857 2SC and ISO/DIS 1426.

**Tube:** Black, oil resistant, synthetic rubber (Nitrile – Type C)\*.

**Reinforcement:** Two braids of high tensile steel wire.

**Cover:** Black, oil, abrasion and weather resistant, synthetic rubber (Modified Nitrile – Type C)\*.

**Temperature Range** -40°F to +212°F (-40°C to +100°C). For water emulsions, etc., see page C8.

**Couplings (see crimp manual for specifics):**

MegaCrimp® Couplings, pages E11-46.



### SPECIFICATIONS

Description	Part No. (50' Length)	Part No. (Bulk Reel)	Product No. (Bulk Reel)	Hose I.D. (In.)	Hose O.D. (In.)	Working Pressure (psi)	Min. Burst Pressure (psi)	Min. Bend Radius (In.)	Bulk Reel Length (Ft.)
6CM2T	85544	70350	4657-99002	3/8	0.70	4,800	19,200	3.5	215
8CM2T	85545	70351	4657-99665	1/2	0.82	4,000	16,000	5.0	180

High Pressure

# Global M6K Mega6000™ Hose

(Meets Flame Resistance Acceptance Designation “U.S. MSHA 2G”)

**Recommended For:** High pressure hydraulic applications. Provides tighter than standard minimum bend radius and greater flexibility for easier plumbing.

**Tube:** Black, oil resistant, synthetic rubber (Nitrile - Type C)\*.

**Reinforcement:** Two braids of high tensile steel wire.

**Cover:** Black, oil, abrasion and weather resistant, synthetic rubber. (Modified Nitrile – Type C)\*.

**Temperature Range** -40°F to +212°F (-40°C to +100°C). For water emulsions, etc., see page C8.

**Couplings (see crimp manual for specifics):**

MegaCrimp® Couplings, pages E11-46.



### SPECIFICATIONS

Description	Part No. (Bulk Reel)	Product No. (Bulk Reel)	Hose I.D. (In.)	Hose O.D. (In.)	Working Pressure (psi)	Min. Burst Pressure (psi)	Min. Bend Radius (In.)	Bulk Reel Length (Ft.)
4M6K	70599	4657-2697	1/4	0.58	6,000	24,000	2.0	440

EQUIPMENT

HOSE/CPLG. SELECTION

TECH. DATA

EXT. & VERY HIGH PRESS. HOSE

GS CPLGS.

PCM CPLGS.

PCS CPLGS.

HIGH & MED. PRESS. HOSE

MEGACRIMP® CPLGS.

PC CPLGS.

FIELD ATTACHABLE CPLGS.

AIR BRAKE HOSE & CPLGS.

MEGATECH™/C5 HOSE & CPLGS.

LOW PRESS. HOSE & CPLGS.

C14 HOSE & CPLGS.

POLARSEAL® HOSE & CPLGS.

PWR. STG. HOSE & CPLGS.

THERMO-PLASTIC HOSE & CPLGS.

ADAPTERS

QUICK DISCONNECT CPLGS.

ACCESSORIES & ASSORTMENTS

PART NUMBER INDEXES

\* Hose stock specifications on page C7



# Global M5K Mega5000® Hose

High Pressure

EQUIPMENT

(Meets Flame Resistance Acceptance Designation "U.S. MSHA 2G")

HOSE/CPLG. SELECTION

**Recommended For:** High pressure hydraulic applications. Provides tighter than standard minimum bend radius and greater flexibility for easier plumbing.

**Couplings (see crimp manual for specifics):**

MegaCrimp® Couplings, pages E11-46.

TECH. DATA

**Tube:** Black, oil resistant, synthetic rubber (Nitrile - Type C)\*.

**Reinforcement:** Two braids of high tensile steel wire.



EXT. & VERY HIGH PRESS. HOSE

**Cover:** Black, oil, abrasion and weather resistant, synthetic rubber (Modified Nitrile - Type C)\*.

**Temperature Range:** -40°F to +212°F (-40°C to +100°C). For water emulsions, etc., see page C8.

GS CPLGS.

PCM CPLGS.

### SPECIFICATIONS

Description	Part No. (50' Length)	Part No. (Bulk Reel)	Product No. (Bulk Reel)	Hose I.D. (In.)	Hose O.D. (In.)	Working Pressure (psi)	Min. Burst Pressure (psi)	Min. Bend Radius (In.)	Bulk Reel Length (Ft.)
4M5K	85607	70596	4657-1100	1/4	0.54	5,000	20,000	2.0	440
6M5K	85606	70597	4657-2695	3/8	0.69	5,000	20,000	2.5	330
8M5K	85608	70598	4657-2650	1/2	0.86	5,000	20,000	3.5	220

PCS CPLGS.

HIGH & MED. PRESS. HOSE

MEGACRIMP® CPLGS.

PC CPLGS.

FIELD ATTACHABLE CPLGS.

# Global M4K+ Mega4000® Hose

High Pressure

(Meets Flame Resistance Acceptance Designation "U.S. MSHA 2G")

AIR BRAKE HOSE & CPLGS.

**Recommended For:** High pressure hydraulic applications. Provides tighter than standard minimum bend radius and greater flexibility for easier plumbing. The plus symbol indicates development testing at 150% of maximum working pressure up to 600,000 impulse cycles.

**Couplings (see crimp manuals for specifics):**

MegaCrimp® Couplings, pages E11-46.

MEGATECH™ C5 HOSE & CPLGS.

**Tube:** Black, oil resistant, synthetic rubber (Nitrile - Type C)\*.

**Reinforcement:** Two braids of high tensile steel wire.



**Cover:** Black, oil, abrasion and weather resistant, synthetic rubber (Modified Nitrile - Type C)\*. Available with unique abrasion-resistant MegaTuff® or XtraTuff™ cover.

**Temperature Range:** -40°F to +212°F (-40°C to +100°C). For water emulsions, etc., see page C8.

LOW PRESS. HOSE & CPLGS.

C14 HOSE & CPLGS.

### SPECIFICATIONS

Description	Part No. (50' Length)	Part No. (Bulk Reel)	Product No. (Bulk Reel)	Hose I.D. (In.)	Hose O.D. (In.)	Working Pressure (psi)	Min. Burst Pressure (psi)	Min. Bend Radius (In.)	Bulk Reel Length (Ft.)
4M4K+	85616	70829	4657-1467	1/4	0.54	4,000	16,000	2.0	440
6M4K+	85617	70821	4657-1458	3/8	0.69	4,000	16,000	2.5	330
8M4K+	85618	70822	4657-1459	1/2	0.86	4,000	16,000	3.5	220
10M4K+	85619	70823	4657-1460	5/8	0.98	4,000	16,000	4.0	220
12M4K+	85620	70824	4657-1461	3/4	1.14	4,000	16,000	4.8	220

POLARSEAL® HOSE & CPLGS.

PWR. STG. HOSE & CPLGS.

THERMO-PLASTIC HOSE & CPLGS.

### XTRATUFF™ COVER SPECIFICATIONS

*XtraTuff™ hose lasts up to 25 times longer than standard hose during hose-to-hose and hose-to-metal abrasion tests per ISO 6945.*

4M4K+-XTF	—	70693	4657-2281	1/4	0.54	4,000	16,000	2.0	440
6M4K+-XTF	85542	70694	4657-2283	3/8	0.69	4,000	16,000	2.5	330
8M4K+-XTF	85543	70695	4657-2284	1/2	0.86	4,000	16,000	3.5	220
10M4K+-XTF	—	70696	4657-2285	5/8	0.98	4,000	16,000	4.0	220
12M4K+-XTF	—	70697	4657-2286	3/4	1.14	4,000	16,000	4.8	220

ADAPTERS

QUICK DISCONNECT CPLGS.

### MEGATUFF® COVER SPECIFICATIONS

*MegaTuff® hose lasts up to 300 times longer than standard hose during hose-to-hose and hose-to-metal abrasion tests per ISO 6945.*

4M4K+-MTF	85519	70693	4657-1477	1/4	0.54	4,000	16,000	2.0	350
6M4K+-MTF	85520	70825	4657-1479	3/8	0.69	4,000	16,000	2.5	330
8M4K+-MTF	85521	70826	4657-1480	1/2	0.86	4,000	16,000	3.5	220
10M4K+-MTF	85522	70827	4657-1481	5/8	0.98	4,000	16,000	4.0	220
12M4K+-MTF	85524	70828	4657-1482	3/4	1.14	4,000	16,000	4.8	190

ACCESSORIES & ASSORTMENTS

PART NUMBER INDEXES

\* Hose stock specifications on page C7.



(Meets Flame Resistance Acceptance Designation “U.S. MSHA 2G”)

**Recommended For:** High pressure hydraulic oil lines. Meets SAE 100R17 requirements and performance requirements of EN 857 1SC. M3K hose has smaller exterior dimensions and significantly tighter bend radius than other SAE 100R1 and 100R2 hose.

**Tube:** Black, oil resistant, synthetic rubber (Nitrile – Type C)\*.

**Reinforcement:** Braided high tensile steel wire. -4, -5, -6 and -8 sizes are one braid; -10, -12 and -16 sizes are two braid.

**Cover:** Black, oil, abrasion and weather resistant, synthetic rubber (Modified Nitrile – Type C)\*. Available with unique abrasion-resistant MegaTuff® or XtraTuff™ cover.

**Temperature Range:** -40°F to +212°F (-40°C to +100°C). For water emulsions, etc., see page C8.

**Couplings (see crimp manual for specifics):**

MegaCrimp® Couplings, pages E11-46.



SPECIFICATIONS

Description	Part No. (50' Length)	Part No. (Bulk Reel)	Product No. (Bulk Reel)	Hose I.D. (In.)	Hose O.D. (In.)	Working Pressure (psi)	Min. Burst Pressure (psi)	Min. Bend Radius (In.)	Bulk Reel Length (Ft.)
4M3K	85624	70485	4657-1157	1/4	0.47	3,000	12,000	2.0	440
5M3K	85609	70575	4657-2216	5/16	0.59	3,000	12,000	2.2	385
6M3K	85625	70486	4657-1158	3/8	0.62	3,000	12,000	2.5	330
8M3K	85626	70487	4657-1159	1/2	0.78	3,000	12,000	3.5	220
10M3K	85627	70488	4657-1173	5/8	0.98	3,000	12,000	4.0	220
12M3K	85628	70489	4657-0679	3/4	1.14	3,000	12,000	4.8	220
16M3K	85629	70490	4657-1163	1	1.48	3,000	12,000	6.0	165

XTRATUFF™ COVER SPECIFICATIONS

XtraTuff™ hose lasts up to 25 times longer than standard hose during hose-to-hose and hose-to-metal abrasion tests per ISO 6945.

4M3K-XTF	85541	70569	4657-2302	1/4	0.47	3,000	12,000	2.0	440
5M3K-XTF	—	70568	4657-2300	5/16	0.59	3,000	12,000	2.2	385
6M3K-XTF	—	70570	4657-1098	3/8	0.62	3,000	12,000	2.5	330
8M3K-XTF	—	70571	4657-2248	1/2	0.78	3,000	12,000	3.5	220
10M3K-XTF	—	70572	4657-2249	5/8	0.98	3,000	12,000	4.0	220
12M3K-XTF	—	70573	4657-2250	3/4	1.14	3,000	12,000	4.8	220
16M3K-XTF	—	70574	4657-2307	1	1.56	3,000	12,000	6.0	165

MEGATUFF® COVER SPECIFICATIONS

MegaTuff® hose lasts up to 300 times longer than standard hose during hose-to-hose and hose-to-metal abrasion tests per ISO 6945.

4M3K-MTF	85525	70565	4657-1181	1/4	0.47	3,000	12,000	2.0	440
6M3K-MTF	85526	70566	4657-1182	3/8	0.62	3,000	12,000	2.5	330
8M3K-MTF	85527	70567	4657-1183	1/2	0.78	3,000	12,000	3.5	330
10M3K-MTF	85528	70559	4657-1184	5/8	0.98	3,000	12,000	4.0	220
12M3K-MTF	85529	70560	4657-1185	3/4	1.14	3,000	12,000	4.8	220
16M3K-MTF	85530	70562	4657-1186	1	1.56	3,000	12,000	6.0	165

**Recommended For:** High pressure hydraulic oil lines. Meets SAE 100R17 requirements and performance requirements of EN 857 1SC. M3KH hose has smaller exterior dimensions and significantly tighter bend radius than other SAE 100R1 and 100R2 hose.

**Tube:** Black, oil resistant, synthetic rubber (Nitrile – Type C)\*.

**Reinforcement:** One braid of high tensile steel wire.

**Cover:** Black, oil, abrasion and weather resistant, synthetic rubber (Modified Nitrile – Type C)\*.

**Temperature Range:** -40°F to +250°F (-40°C to +121°C). For water emulsions, etc., see page C8.

**Couplings (see crimp manual for specifics):**

MegaCrimp® Couplings, pages E11-46.



SPECIFICATIONS

Description	Part No. (Bulk Reel)	Product No. (Bulk Reel)	Hose I.D. (In.)	Hose O.D. (In.)	Working Pressure (psi)	Min. Burst Pressure (psi)	Min. Bend Radius (In.)	Bulk Reel Length (Ft.)
4M3KH	70898	4657-2664	1/4	0.47	3,000	12,000	2.0	440
6M3KH	70899	4657-2696	3/8	0.62	3,000	12,000	2.5	330

\* Hose stock specifications on page C7.

EQUIPMENT
HOSE/CPLG. SELECTION
TECH. DATA
EXT. & VERY HIGH PRESS. HOSE
GS CPLGS.
PCM CPLGS.
PCS CPLGS.
HIGH & MED. PRESS. HOSE
MEGACRIMP® CPLGS.
PC CPLGS.
FIELD ATTACHABLE CPLGS.
AIR BRAKE HOSE & CPLGS.
MEGATECH™/C5 HOSE & CPLGS.
LOW PRESS. HOSE & CPLGS.
C14 HOSE & CPLGS.
POLARSEAL® HOSE & CPLGS.
PWR. STG. HOSE & CPLGS.
THERMO-PLASTIC HOSE & CPLGS.
ADAPTERS
QUICK DISCONNECT CPLGS.
ACCESSORIES & ASSORTMENTS
PART NUMBER INDEXES



# Global G2H High-Temp 2-Wire Braid Hose – SAE 100R2 Type AT

High Pressure

EQUIPMENT

(Meets Flame Resistance Acceptance Designation "U.S. MSHA 2G")

HOSE/CPLG. SELECTION

**Recommended For:** High pressure hydraulic oil lines. Meets or exceeds the requirements of SAE 100R2AT and performance requirements of EN 853.

**Couplings (see crimp manual for specifics):**

- MegaCrimp® Couplings (-20), pages E11-46.
- Permanent PC Couplings (-24 and -32), pages E48-65.
- Field Attachable "Type T" Couplings, pages E66-72.

TECH. DATA

**Tube:** Black, oil-resistant synthetic rubber (Nitrile – Type C)\*.

**Reinforcement:** Two braids of high-tensile steel wire.

EXT. & VERY HIGH PRESS. HOSE

**Cover:** Black, oil-resistant synthetic rubber (Hypalon† – Type M)\*. Available with unique abrasion-resistant MegaTuff® cover.

**Temperature Range:** -40°F to +275°F (-40°C to +135°C) constant and +300°F (+149°C) intermittent (up to 10% of operating time). For water emulsions, etc., see page C8.



GS CPLGS.

PCM CPLGS.

PCS CPLGS.

## SPECIFICATIONS

Description	Part No. (Bulk Carton)	Product No. (Bulk Carton)	Hose I.D. (In.)	Hose O.D. (In.)	Working Pressure (psi)	Min. Burst Pressure (psi)	Min. Bend Radius (In.)	Approx. Bulk Carton Length (Ft.)
20G2H	70230	4657-0930	1-1/4	1.87	1,650	6,600	16.5	100
24G2H	70241	4657-0931	1-1/2	2.15	1,300	5,000	20.0	100
32G2H	70242	4657-0932	2	2.65	1,175	4,500	25.0	100

HIGH & MED. PRESS. HOSE

MEGACRIMP® CPLGS.

PC CPLGS.

## MEGATUFF® COVER SPECIFICATIONS

MegaTuff® hose lasts up to 300 times longer than standard hose during hose-to-hose and hose-to-metal abrasion tests per ISO 6945.

Description	Part No. (Bulk Carton)	Product No. (Bulk Carton)	Hose I.D. (In.)	Hose O.D. (In.)	Working Pressure (psi)	Min. Burst Pressure (psi)	Min. Bend Radius (In.)	Approx. Bulk Carton Length (Ft.)
20G2H-MTF	70897	4657-2573	1-1/4	1.87	1,650	6,600	16.5	100
24G2H-MTF	70188	4657-2151	1-1/2	2.15	1,300	5,000	20.0	100
32G2H-MTF	70189	4657-2152	2	2.65	1,175	4,500	25.0	100

† Hypalon is a registered trademark of DuPont.

AIR BRAKE HOSE & CPLGS.

MEGATECH™ C5 HOSE & CPLGS.

# Power Plus® G2AT-HMP High-Temp Multifluid 2-Wire Braid Hose

High Pressure

LOW PRESS. HOSE & CPLGS.

(Meets Flame Resistance Acceptance Designation "U.S. MSHA 2G")

**Recommended For:** High-pressure hydraulic applications where pressure or temperature requirements exceed SAE 100R2, or where resistance to either petroleum-base or phosphate ester fluids is required. Meets or exceeds requirements of SAE 100R2 Type AT.

**Couplings (see crimp manual for specifics):**

- MegaCrimp® Couplings, pages E11-46.

**Tube:** Black. Specifically compounded for temperature and chemical resistance (CPE – Type J)\*.

**Reinforcement:** Two braids of high tensile steel wire.

**Cover:** Black, oil and abrasion resistant, synthetic rubber (Neoprene – Type A)\*.

**Caution:** Special O-Rings are required for phosphate ester fluid applications. Many male swivel couplings have internal O-Rings that are not recommended for phosphate ester fluids.

**Temperature Range:** Petroleum-base fluids -40°F to +300°F (-40°C to +149°C). Phosphate ester fluids as recommended by the fluid manufacturer, but within a range of -40°F to +212°F (-40°C to +100°C). For water emulsions, etc., see page C8.



C14 HOSE & CPLGS.

POLARSEAL® HOSE & CPLGS.

PWR. STG. HOSE & CPLGS.

## SPECIFICATIONS

Description	Part No. (50' Length)	Part No. (Bulk Carton)	Product No. (Bulk Carton)	Hose I.D. (In.)	Hose O.D. (In.)	Working Pressure (psi)	Min. Burst Pressure (psi)	Min. Bend Radius (In.)	Approx. Bulk Carton Length (Ft.)
8G2AT-HMP	85586	70519	4657-1502	1/2	0.86	4,250	16,000	7.0	275
10G2AT-HMP	—	70525	4657-1503	5/8	0.98	3,500	14,000	8.0	220
12G2AT-HMP	85588	70526	4657-1504	3/4	1.14	3,000	12,000	9.5	175

THERMO-PLASTIC HOSE & CPLGS.

ADAPTERS

QUICK DISCONNECT CPLGS.

ACCESSORIES & ASSORTMENTS

PART NUMBER INDEXES

\* Hose stock specifications on page C7.



(Meets Flame Resistance Acceptance Designation “U.S. MSHA 2G”)

**Recommended For:** High-pressure hydraulic applications where pressure or temperature requirements exceed SAE 100R2/EN 853.

**Tube:** Black. Specifically compounded for temperature and chemical resistance (CPE – Type J)\*.

**Reinforcement:** Two braids of high tensile steel wire.

**Cover:** Black. Specifically compounded for temperature and chemical resistance (CPE – Type J)\*.

**Temperature Range:** Petroleum-base fluids -40°F to +300°F (-40°C to +149°C). Phosphate ester fluids as recommended by the fluid manufacturer, but within a range of -40°F to +212°F (-40°C to +100°C). For water emulsions, etc., see page C8.

**Couplings (see crimp manual for specifics):**

MegaCrimp® Couplings, pages E11-46.



SPECIFICATIONS								
Description	Part No. (Bulk Reel)	Product No. (Bulk Reel)	Hose I.D. (In.)	Hose O.D. (In.)	Working Pressure (psi)	Min. Burst Pressure (psi)	Min. Bend Radius (In.)	Approx. Bulk Reel Length (Ft.)
16G2XH	70878	4657-2546	1	1.37	2,500	10,000	12.0	165

EQUIPMENT

HOSE/CPLG. SELECTION

TECH. DATA

EXT. & VERY HIGH PRESS. HOSE

GS CPLGS.

PCM CPLGS.

PCS CPLGS.

HIGH & MED. PRESS. HOSE

MEGACRIMP® CPLGS.

PC CPLGS.

FIELD ATTACHABLE CPLGS.

(Meets Flame Resistance Acceptance Designation “U.S. MSHA 2G”)

**Recommended For:** Hydraulic jack applications. Meets Material Handling Institute specification IJ 100 for hydraulic hose and assemblies used with jacking systems.

**Tube:** Black, oil resistant, synthetic rubber (Nitrile – Type C)\*.

**Reinforcement:** Two braids of high tensile steel wire.

**Cover:** Black, oil and abrasion resistant synthetic rubber (Modified Nitrile – Type C)\*. Available with unique abrasion-resistant MegaTuff® cover.

**Temperature Range:** -40°F to +120°F (-40°C to +49°C).

**Couplings (see crimp manual for specifics):**

Use MegaCrimp® Male Pipe Long Nose Couplings on jack end of assembly for engagement, page E11.



SPECIFICATIONS									
Description	Part No. (50' Length)	Part No. (Bulk Reel)	Product No. (Bulk Reel)	Hose I.D. (In.)	Hose O.D. (In.)	Working Pressure (psi) (static only)®	Min. Burst Pressure (psi)	Min. Bend Radius (In.)	Bulk Reel Length (Ft.)
4J2AT	85650	70800	4657-1400	1/4	0.58	10,000	20,000	4.0	350
6J2AT	85651	70801	4657-1404	3/8	0.74	10,000	20,000	5.0	330

MEGATUFF® COVER SPECIFICATIONS

MegaTuff® hose lasts up to 300 times longer than standard hose during hose-to-hose and hose-to-metal abrasion tests per ISO 6945.

4J2AT-MTF	—	70469	4657-1188	1/4	0.58	10,000	20,000	4.0	350
6J2AT-MTF	—	70471	4657-1189	3/8	0.74	10,000	20,000	5.0	330

®Static (non-impulse) pressure rating for hydraulic jack applications only.

AIR BRAKE HOSE & CPLGS.

MEGATECH™/C5 HOSE & CPLGS.

LOW PRESS. HOSE & CPLGS.

C14 HOSE & CPLGS.

POLARSEAL® HOSE & CPLGS.

PWR. STG. HOSE & CPLGS.

THERMO-PLASTIC HOSE & CPLGS.

ADAPTERS

QUICK DISCONNECT CPLGS.

ACCESSORIES & ASSORTMENTS

PART NUMBER INDEXES

\* Hose stock specifications on page C7.



# G1 1-Wire Braid Hose- SAE 100R1 Type AT

Medium Pressure

EQUIPMENT

(Meets Flame Resistance Acceptance Designation "U.S. MSHA 2G")

HOSE/CPLG. SELECTION

**Recommended For:** Medium pressure hydraulic lines. Meets or exceeds the requirements of SAE 100R1 Type AT and SAE 100R1 Type S and performance requirements of EN 853 1SN.

**Couplings (see crimp manual for specifics):**

MegaCrimp® Couplings (except -3, -24 and -32), pages E11-46.  
Permanent PC Coupling (-3, -24 and -32), pages E48-65.  
Field Attachable "Type T" Couplings, pages E66-72.

TECH. DATA

**Tube:** Black, oil-resistant synthetic rubber (Nitrile – Type C)\*.

**Reinforcement:** One braid of high-tensile steel wire.

EXT. & VERY HIGH PRESS. HOSE

**Cover:** Black, oil and abrasion-resistant synthetic rubber (Modified Nitrile – Type C<sub>2</sub>)\*.

**Temperature Range:** -40°F to +212°F (-40°C to +100°C). For water emulsions, etc., see page C8.



GS CPLGS.

PCM CPLGS.

PCS CPLGS.

HIGH & MED. PRESS. HOSE

## SPECIFICATIONS

Description	Part No. (50' Length)	Part No. (100' Length Reel)④	Part No. (Bulk Carton)	Part No. (Bulk Reel)	Product No. (Bulk Carton)	Hose I.D. (In.)	Hose O.D. (In.)	Working Pressure (psi)	Min. Burst Pressure (psi)	Min. Bend Radius (In.)	Approx. Bulk Carton Length (Ft.)	Bulk Reel Length (Ft.)
3G1	—	—	70200	70611	4657-0618	3/16	0.47	3,625	14,500	3.5	800	440
4G1	86611	—	70201	70600	4657-0619	1/4	0.53	3,275	13,100	4.0	700	440
5G1	—	—	70199	—	4657-0031	5/16	0.59	3,125	12,500	4.5	550	—
6G1	86612	86631	70202	70601	4657-0622	3/8	0.69	2,600	10,400	5.0	475	385
8G1	86613	86633	70203	70602	4657-0623	1/2	0.82	2,325	9,300	7.0	400	330
10G1	—	—	70275	70612	4657-0633	5/8	0.94	1,900	7,600	8.0	300	220
12G1	86614	—	70204	70603	4657-0624	3/4	1.10	1,525	6,100	9.5	200	220
16G1	86615	—	70205	70604	4657-0628	1	1.41	1,275	5,100	12.0	100	165
20G1	—	—	70271	—	4657-0646	1-1/4	1.71	925	3,700	16.0	100	—
24G1	—	—	70278	—	4657-2489	1-1/2	1.96	725	2,900	20.0	100	—
32G1	—	—	70279	—	4657-2490	2	2.52	600	2,700	25.0	100	—

④Not necessarily one continuous length.

AIR BRAKE HOSE & CPLGS.

MEGATECH™ C5 HOSE & CPLGS.

# G1H High-Temp 1-Wire Braid Hose

Medium Pressure

LOW PRESS. HOSE & CPLGS.

(Meets Flame Resistance Acceptance Designation "U.S. MSHA 2G")

**Recommended For:** Medium pressure hydraulic oil lines. Meets or exceeds requirements of SAE 100R1 Type AT.

**Couplings (see crimp manual for specifics):**

MegaCrimp® Couplings (except -24 and -32), pages E11-46.  
Permanent PC Couplings (-24 and -32), pages E48-65.

**Tube:** Black, oil resistant, synthetic rubber (Nitrile – Type C)\*.

**Reinforcement:** One braid of high tensile steel wire.

**Cover:** Black, oil and abrasion resistant synthetic rubber (Hypalon† – Type M).

**Temperature Range:** -40°F to +275°F (-40°C to +135°C) constant and +300°F (+149°C) intermittent (up to 10% of operating time). For water emulsions, etc., see page C8.



C14 HOSE & CPLGS.

POLARSEAL® HOSE & CPLGS.

PWR. STG. HOSE & CPLGS.

## SPECIFICATIONS

Description	Part No. (50' Length)	Part No. (Bulk Carton)	Product No. (Bulk Carton)	Hose I.D. (In.)	Hose O.D. (In.)	Working Pressure (psi)	Min. Burst Pressure (psi)	Min. Bend Radius (In.)	Approx. Bulk Carton Length (Ft.)
4G1H	—	70206	4657-0900	1/4	0.53	2,750	11,000	4.0	700
6G1H	—	70207	4657-0901	3/8	0.69	2,250	9,000	5.0	475
8G1H	—	70208	4657-0902	1/2	0.82	2,000	8,000	7.0	350
10G1H	—	70214	4657-0910	5/8	0.94	1,500	6,000	8.0	225
12G1H	85938	70209	4657-0903	3/4	1.10	1,250	5,000	9.5	200
16G1H	—	70210	4657-0904	1	1.41	1,000	4,000	12.0	100
20G1H	—	70211	4657-0940	1-1/4	1.72	625	2,500	16.0	100
24G1H	—	70212	4657-0934	1-1/2	1.96	725	2,900	20.0	100
32G1H	—	70213	4657-0935	2	2.52	600	2,400	25.0	100

† Hypalon is a registered trademark of DuPont.

THERMO-PLASTIC HOSE & CPLGS.

ADAPTERS

QUICK DISCONNECT CPLGS.

ACCESSORIES & ASSORT-MENTS

PART NUMBER INDEXES

\* Hose stock specifications on page C7.





(Meets Flame Resistance Acceptance Designation "U.S. MSHA 2G")

**Recommended For:** Low-pressure powder fire suppressant applications on mining, forestry and fire fighting equipment. The red cover is for easy visual identification in these applications.

**Tube:** Black, oil-resistant synthetic rubber (Nitrile – Type C)\*.

**Reinforcement:** One braid of high-tensile steel wire.

**Cover:** Red, oil and abrasion resistant (Modified Nitrile – Type C<sub>2</sub>)\*.

**Temperature Range:** -40°F to +212°F (-40°C to +100°C). For water emulsions, etc., see page C8.

**Couplings (see crimp manual for specifics):**

MegaCrimp® Couplings, pages E11-46.



SPECIFICATIONS								
Description	Part No. (Bulk Reel)	Product No. (Carton)	Hose I.D. (In.)	Hose O.D. (In.)	Working Pressure (psi)	Min. Burst Pressure (psi)	Min. Bend Radius (In.)	Bulk Reel Length Ft.
4RFS	H24100-04F	4657-3314	1/4	0.53	2,750	11,000	4.0	440
6RFS	H24100-06F	4657-3313	3/8	0.68	2,250	9,000	5.0	300
8RFS	H24100-08F	4657-3315	1/2	0.80	2,000	8,000	7.0	330
12RFS	H24100-12F	4657-3316	3/4	1.09	1,250	5,000	9.5	300

**Recommended For:** Hydraulic oil lines, anti-freeze solutions or water. Meets or exceeds requirements of SAE 100R3.

**Tube:** Black, synthetic rubber (Nitrile – Type C)\*.

**Reinforcement:** Two fiber braids.

**Cover:** Black, oil and abrasion resistant, synthetic rubber (Neoprene – Type A)\*.

**Temperature Range:** For hydraulic oil lines -40°F to +275°F (-40°C to +135°C) constant and +300°F (+149°C) intermittent (up to 10% of operating time). For water emulsions, etc., see page C8.

**Couplings (see crimp manual for specifics):**

Permanent PC Couplings, pages E48-65.



SPECIFICATIONS										
Description	Part No. (25' Length)	Part No. (Bulk Carton)	Product No. (Bulk Carton)	Hose I.D. (In.)	Hose O.D. (In.)	Working Pressure (psi)	Min. Burst Pressure (psi)	Min. Bend Radius (In.)	Vacuum (In. Hg)	Approx. Bulk Carton Length (Ft.)
4G3H(C3H)	85951	70127	3319-0088	1/4	0.56	1,250	5,000	3.0	28	455
6G3H(C3H)	85952	70128	3319-0087	3/8	0.75	1,125	4,500	4.0	28	300
8G3H(C3H)	85953	70126	3319-0090	1/2	0.94	1,000	4,000	5.0	28	225
12G3H(C3H)	85954	70119	3319-0091	3/4	1.25	750	3,000	6.0	28	160
16G3H(C3H)	85955	70120	3319-0092	1	1.50	565	2,250	8.0	20	100
20G3H(C3H)	—	70121	3319-0071	1-1/4	1.75	375	1,500	10.0	15	80

\* Hose stock specifications on page C7.

- EQUIPMENT
- HOSE/CPLG. SELECTION
- TECH. DATA
- EXT. & VERY HIGH PRESS. HOSE
- GS CPLGS.
- PCM CPLGS.
- PCS CPLGS.
- HIGH & MED. PRESS. HOSE
- MEGACRIMP® CPLGS.
- PC CPLGS.
- FIELD ATTACHABLE CPLGS.
- AIR BRAKE HOSE & CPLGS.
- MEGATECH™/C5 HOSE & CPLGS.
- LOW PRESS. HOSE & CPLGS.
- C14 HOSE & CPLGS.
- POLARSEAL® HOSE & CPLGS.
- PWR. STG. HOSE & CPLGS.
- THERMO-PLASTIC HOSE & CPLGS.
- ADAPTERS
- QUICK DISCONNECT CPLGS.
- ACCESSORIES & ASSORTMENTS
- PART NUMBER INDEXES



# GTH(C6H) High-Temp 1-Fiber Braid Hose—SAE 100R6

Medium Pressure

EQUIPMENT

**Recommended For:** Hydraulic oil lines, heavy-duty transmission oil cooler lines and glycol anti-freeze solutions. Meets or exceeds requirements of SAE 100R6.

**Couplings (see crimp manual for specifics):**

MegaCrimp® Couplings (except -3), pages E11-46.

Permanent PC Couplings (-3), pages E48-65.

HOSE/CPLG. SELECTION

**Tube:** Black, specially compounded, synthetic rubber (Nitrile – Type C)\*.

**Reinforcement:** One fiber braid.

TECH. DATA

**Cover:** Black, oil and abrasion resistant, synthetic rubber (Neoprene – Type A)\*.

**Temperature Range:** For hydraulic oil lines -40°F to +275°F (-40°C to +135°C) constant and +300°F (+149°C) intermittent (up to 10% of operating time). For water emulsions, etc., see page C8.

EXT. & VERY HIGH PRESS. HOSE



GS CPLGS.

## SPECIFICATIONS

PCM CPLGS.

Description	Part No. (50' Length)	Part No. (Bulk Carton)	Product No. (Bulk Carton)	Hose I.D. (In.)	Hose O.D. (In.)	Working Pressure (psi)	Min. Burst Pressure (psi)	Min. Bend Radius (In.)	Vacuum (In. Hg)	Approx. Bulk Carton Length
3GTH	—	70106	3319-3301	3/16	0.44	500	2,000	2.0	28	715
4GTH	—	70107	3319-3305	1/4	0.50	400	1,600	2.5	28	550
5GTH	86687	70105⊙	3319-3310	5/16	0.56	400	1,600	3.0	28	500
6GTH	86688	70129⊙	3319-3315	3/8	0.63	400	1,600	3.0	28	550
8GTH	86618	70131⊙	3319-3320	1/2	0.78	400	1,600	4.0	18	280
10GTH	86695⊙	70111	3319-3325	5/8	0.91	350	1,400	5.0	15	250
12GTH	—	70130	3319-3335	3/4	1.06	300	1,200	5.5	15	250

⊙25' Length

⊙250' Bulk Reel Lengths

PCS CPLGS.

HIGH & MED. PRESS. HOSE

MEGACRIMP® CPLGS.

PC CPLGS.

FIELD ATTACHABLE CPLGS.

AIR BRAKE HOSE & CPLGS.

## PowerClean™ Hose

**Recommended For:** Use on hot or cold water, high-pressure cleaning equipment. In 300' reels and 50' boxes.

**Couplings (see crimp manual for specifics):**

MegaCrimp® Couplings, pages E11-46.

**Tube:** Synthetic rubber specially compounded to handle high-pressure water service.

**Reinforcement:** High tensile steel one- or two-wire braid.

**Cover:** Specially compounded to handle pressure washer environment.

**Temperature Range:** -40° to +250°F (-40°C to +121°C).



MEGATECH™ C5 HOSE & CPLGS.

LOW PRESS. HOSE & CPLGS.

C14 HOSE & CPLGS.

## SPECIFICATIONS

Description	Part No. (50' Length)	Part No. (Bulk Reel)	Product No. (Bulk Reel)	Hose I.D. (In.)	Hose O.D. (In.)	Working Pressure (psi)	Min. Bend Radius (In.)	Bulk Reel Length (Ft.)
4PC3500	85720	70840	4657-2400	1/4	0.53	3,500	4.0	300
4PC6000	85721	70841	4657-2410	1/4	0.59	6,000	4.0	300
6PC3000	85722	70842	4657-2402	3/8	0.68	3,000	5.0	300
6PC3000 Blue	85723	70843	4657-2404	3/8	0.68	3,000	5.0	300
6PC3000 Yellow	85698	70848	4657-2417	3/8	0.68	3,000	5.0	300
6PC4000	85724	70844	4657-2225	3/8	0.68	4,000	5.0	300
6PC5000	85725	70845	4657-2407	3/8	0.74	5,000	5.0	300
8PC2500	85726	70846	4657-2408	1/2	0.80	2,500	7.0	300
8PC4000	85727	70847	4657-2426	1/2	0.86	4,000	7.0	300

POLARSEAL® HOSE & CPLGS.

PWR. STG. HOSE & CPLGS.

THERMO-PLASTIC HOSE & CPLGS.

ADAPTERS

**NOTE:** Not recommended for Steam Hose.

QUICK DISCONNECT CPLGS.

ACCESSORIES & ASSORT-MENTS

PART NUMBER INDEXES

\* Hose stock specifications on page C7.

## Male Pipe (NPTF – 30° Cone Seat)

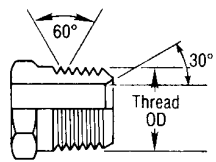

NPTF Solid Male (MP)

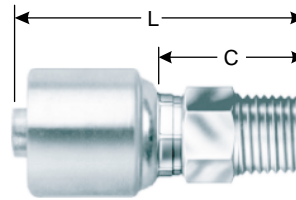

H1

Descr	#		⌀		🌀	H1	L		C	
			"	mm		"	"	mm	"	mm
4G-2MP	G25100-0402	7100-10025	1/4	6.4	1/8-27	1/2	1.97	50.0	0.94	24.0
4G-4MP	G25100-0404	7100-10035	1/4	6.4	1/4-18	9/16	2.17	55.0	1.14	29.0
4G-6MP	G25100-0406	7100-10045	1/4	6.4	3/8-18	11/16	2.17	55.0	1.14	29.0
4G-8MP	G25100-0408	7100-10055	1/4	6.4	1/2-14	7/8	2.44	62.0	1.42	36.0
5G-4MP	G25100-0504	7100-00065	5/16	7.9	1/4-18	5/8	2.28	58.0	1.18	30.0
6G-4MP	G25100-0604	7100-10075	3/8	9.5	1/4-18	5/8	2.32	59.0	1.22	31.1
6G-6MP	G25100-0606	7100-10085	3/8	9.5	3/8-18	11/16	2.32	59.0	1.22	31.1
6G-8MP	G25100-0608	7100-10095	3/8	9.5	1/2-14	7/8	2.52	64.0	1.42	36.1
8G-6MP	G25100-0806	7100-00105	1/2	12.7	3/8-18	13/16	2.72	69.0	1.24	31.5
8G-8MP	G25100-0808	7100-00112	1/2	12.7	1/2-14	7/8	2.78	73.0	1.40	35.5
8G-12MP	G25100-0812	7100-00125	1/2	12.7	3/4-14	1 1/16	2.95	75.0	1.48	37.5
10G-8MP	G25100-1008	7100-00135	5/8	15.8	1/2-14	15/16	2.95	75.0	1.48	37.5
10G-12MP	G25100-1012	7100-00145	5/8	15.8	3/4-14	1 1/16	2.89	73.5	1.42	36.0
12G-8MP	G25100-1208	7100-00155	3/4	19.0	1/2-14	1 1/16	3.46	88.0	1.46	37.0
12G-12MP	G25100-1212	7100-00162	3/4	19.0	3/4-14	1 1/16	3.46	88.0	1.46	37.0
12G-16MP	G25100-1216	7100-00175	3/4	19.0	1-11 1/2	1 3/8	3.78	96.0	1.77	45.0
16G-12MP	G25100-1612	7100-00195	1	25.4	3/4-14	1 3/8	3.94	100.0	1.70	43.2
16G-16MP	G25100-1616	7100-00205	1	25.4	1-11 1/2	1 3/8	4.11	104.5	1.88	47.7
20G-20MP	G25100-2020	7100-00215	1 1/4	31.7	1 1/4-11 1/2	1 3/4	4.45	113.0	2.13	54.0

## Male Pipe Long Nose

For use with J2AT Jack Hose and special high-pressure applications.

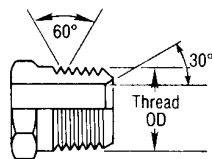

NPTF Solid Male (MP)

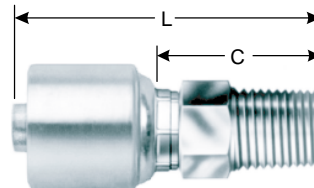

H1

Descr	#		⌀		🌀	H1	L		C	
			"	mm		"	"	mm	"	mm
4G-4MPLN	G25101-0404	7100-16615	1/4	6.4	1/4-18	9/16	2.56	65.0	1.54	39.0
4G-6MPLN	G25101-0406	7100-16625	1/4	6.4	3/8-18	11/16	2.56	65.0	1.54	39.0
6G-4MPLN	G25101-0604	7100-16645	3/8	9.5	1/4-18	5/8	2.72	69.0	1.62	41.1
6G-6MPLN	G25101-0606	7100-16635	3/8	9.5	3/8-18	11/16	2.72	69.0	1.62	41.1

EQUIPMENT
HOSE/CPLG. SELECTION
TECH. DATA
EXT. & VERY HIGH PRESS. HOSE
GS CPLGS.
PCM CPLGS.
PCS CPLGS.
HIGH & MED. PRESS. HOSE
MEGACRIMP® CPLGS.
PC CPLGS.
FIELD ATTACHABLE CPLGS.
AIR BRAKE HOSE & CPLGS.
MEGATECH™/C5 HOSE & CPLGS.
LOW PRESS. HOSE & CPLGS.
C14 HOSE & CPLGS.
POLARSEAL® HOSE & CPLGS.
PWR. STG. HOSE & CPLGS.
THERMO-PLASTIC HOSE & CPLGS.
ADAPTERS
QUICK DISCONNECT CPLGS.
ACCESSORIES & ASSORTMENTS
PART NUMBER INDEXES



# MegaCrimp® Couplings - G25 Series

## Male Pipe Swivel (NPTF – Without 30° Cone Seat)

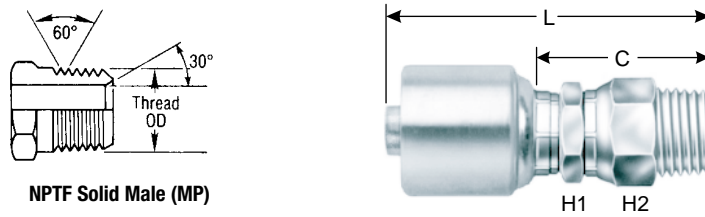

NOT TO BE USED AS A LIVE SWIVEL

Descr	#		↻		🌀	H1	H2	L		C	
			"	mm		"	"	"	mm	"	mm
4G-4MPX	G25105-0404	7100-10255	1/4	6.4	1/4-18	1/2	11/16	2.61	66.3	1.58	40.2
4G-6MPX	G25105-0406	7100-10265	1/4	6.4	3/8-18	5/8	7/8	2.74	69.5	1.71	43.5
4G-8MPX	G25105-0408	7100-10275	1/4	6.4	1/2-14	3/4	1	2.97	75.4	1.94	49.4
6G-4MPX	G25105-0604	7100-10285	3/8	9.5	1/4-18	5/8	7/8	2.87	72.8	1.77	44.9
6G-6MPX	G25105-0606	7100-10295	3/8	9.5	3/8-18	5/8	7/8	2.81	71.5	1.72	43.6
6G-8MPX	G25105-0608	7100-10305	3/8	9.5	1/2-14	3/4	1	3.05	77.5	1.95	49.5
8G-6MPX	G25105-0806	7100-00315	1/2	12.7	3/8-18	13/16	7/8	3.23	82.0	1.76	44.6
8G-8MPX	G25105-0808	7100-00325	1/2	12.7	1/2-14	13/16	1	3.42	86.9	1.94	49.4
10G-12MPX	G25105-1012	7100-00335	5/8	15.9	3/4-14	1 1/16	1 5/16	3.48	88.5	2.01	51.1
12G-8MPX	G25105-1208	7100-00345	3/4	19.1	1/2-14	1 1/16	1	3.97	100.9	1.96	49.9
12G-12MPX	G25105-1212	7100-00355	3/4	19.1	3/4-14	1 1/16	1 5/16	4.02	102.0	2.01	51.0
16G-16MPX	G25105-1616	7100-00365	1	25.4	1-11 1/2	1 3/8	1 5/8	4.73	120.2	2.50	63.4

## Male Pipe Swivel – 90° Block (NPTF – Without 30° Cone)

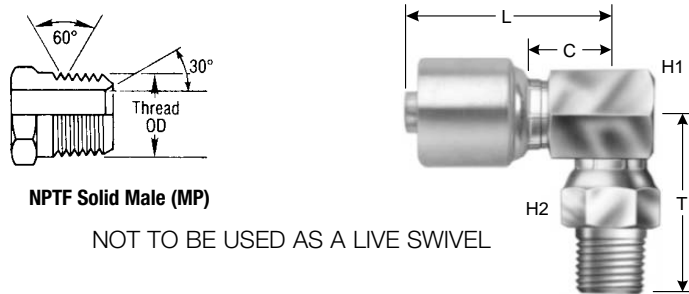

NOT TO BE USED AS A LIVE SWIVEL

Descr	#		↻		🌀	H1	H2	T	L		C		
			"	mm		"	"	"	mm	"	mm	"	mm
4G-4MPX90	G25106-0404	7100-10375	1/4	6.4	1/4-18	11/16	11/16	1.63	41.3	1.75	44.5	0.72	18.4
4G-6MPX90	G25106-0406	7100-10385	1/4	6.4	3/8-18	11/16	7/8	1.73	43.9	1.82	46.3	0.80	20.2
6G-4MPX90	G25106-0604	7100-10395	3/8	9.5	1/4-18	3/4	11/16	1.66	42.1	1.95	49.6	0.85	21.7
6G-6MPX90	G25106-0606	7100-10405	3/8	9.5	3/8-18	3/4	7/8	1.76	44.8	1.95	49.6	0.85	21.7
6G-8MPX90	G25106-0608	7100-10415	3/8	9.5	1/2-14	3/4	1	1.93	49.1	1.96	49.7	0.85	21.7
6G-8MPX90L <sup>†</sup>	G25107-0608	7100-00445	3/8	9.5	1/2-14	3/4	1	1.93	49.1	3.04	77.3	1.94	49.3
8G-6MPX90	G25106-0806	7100-07135	1/2	12.7	3/8-18	1	7/8	1.89	48.0	2.55	64.7	1.07	27.2
8G-8MPX90	G25106-0808	7100-00425	1/2	12.7	1/2-14	1	1	2.06	52.3	2.55	64.7	1.07	27.2
8G-8MPX90L <sup>†</sup>	G25107-0808	7100-00455	1/2	12.7	1/2-14	1	1	2.06	52.3	3.76	95.5	1.80	45.6
12G-12MPX90	G25106-1212	7100-00435	3/4	19.1	3/4-14	1 3/8	1 5/16	2.30	58.4	3.18	80.7	1.17	29.7
12G-12MPX90L <sup>†</sup>	G25107-1212	7100-00475	3/4	19.1	3/4-14	1 3/8	1 5/16	2.30	58.4	3.93	99.7	1.92	48.7

<sup>†</sup> These couplings have a longer reach (L dimension) to accommodate the OmniCrimp® 21 crimper.

## Female Pipe (NPTF – Without 30° Cone Seat)

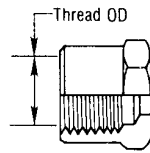

NPTF or NPSF  
Solid Female (FP)

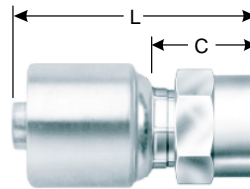

H1

Descr	#		⊕		🌀	H1		L		C	
			"	mm		"	"	mm	"	mm	
4G-2FP	G25110-0402	7100-10485	1/4	6.4	1/8-27	9/16	1.74	44.3	0.72	18.3	
4G-4FP	G25110-0404	7100-10495	1/4	6.4	1/4-18	11/16	1.99	50.5	0.96	24.5	
4G-6FP	G25110-0406	7100-10505	1/4	6.4	3/8-18	13/16	1.99	50.5	0.96	24.5	
6G-4FP	G25110-0604	7100-10515	3/8	9.5	1/4-18	11/16	2.01	51.0	0.91	23.1	
6G-6FP	G25110-0606	7100-10525	3/8	9.5	3/8-18	13/16	2.07	52.5	0.97	24.6	
6G-8FP	G25110-0608	7100-10535	3/8	9.5	1/2-14	1	2.25	57.1	1.15	29.2	
8G-6FP	G25110-0806	7100-00545	1/2	12.7	3/8-18	13/16	2.46	62.5	0.98	25.0	
8G-8FP	G25110-0808	7100-00555	1/2	12.7	1/2-14	1	2.64	67.0	1.16	29.5	
12G-12FP	G25110-1212	7100-00565	3/4	19.0	3/4-14	1 1/4	3.23	82.0	1.22	31.0	

## Female Pipe Swivel (NPSM – 30° Cone Seat)

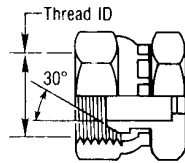

NPSM Swivel  
Female (FPX)

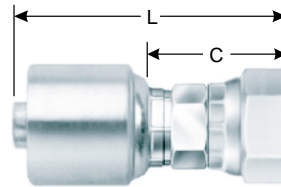

H1

H2

Descr	#		⊕		🌀	H1		H2		L		C	
			"	mm		"	"	"	mm	"	mm		
4G-4FPX	G25111-0404	7100-10575	1/4	6.4	1/4-18	1/2	11/16	2.24	57.0	1.22	30.9		
6G-6FPX	G25111-0606	7100-10585	3/8	9.5	3/8-18	5/8	7/8	2.37	60.2	1.27	32.3		
8G-8FPX	G25111-0808	7100-00595	1/2	12.7	1/2-14	13/16	1	2.81	71.4	1.33	33.9		
12G-12FPX	G25111-1212	7100-00605	3/4	19.0	3/4-14	1 1/16	1 1/4	3.72	94.4	1.71	43.4		
16G-16FPX	G25111-1616	7100-00615	1	25.4	1-11 1/2	1 3/8	1 1/2	4.11	104.3	1.87	47.5		

EQUIPMENT
HOSE/CPLG. SELECTION
TECH. DATA
EXT. & VERY HIGH PRESS. HOSE
GS CPLGS.
PCM CPLGS.
PCS CPLGS.
HIGH & MED. PRESS. HOSE
MEGACRIMP® CPLGS.
PC CPLGS.
FIELD ATTACHABLE CPLGS.
AIR BRAKE HOSE & CPLGS.
MEGATECH™/C5 HOSE & CPLGS.
LOW PRESS. HOSE & CPLGS.
C14 HOSE & CPLGS.
POLARSEAL® HOSE & CPLGS.
PWR. STG. HOSE & CPLGS.
THERMO-PLASTIC HOSE & CPLGS.
ADAPTERS
QUICK DISCONNECT CPLGS.
ACCESSORIES & ASSORTMENTS
PART NUMBER INDEXES



# MegaCrimp® Couplings - G25 Series

## Male O-Ring Boss

SAE J1926/3 ISO 11926-3 Light-Duty (L Series) Stud End.

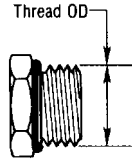

O-Ring Boss Male (MB)

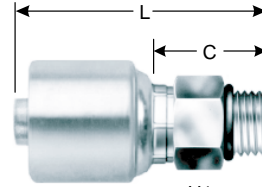

H1

Descr	#		⊕		🌀	H1			C	
			"	mm		"	"	mm	"	mm
4G-4MB	G25120-0404	7100-12205	1/4	6.4	7/16-20	9/16	1.99	50.5	0.96	24.5
4G-5MB	G25120-0405	7100-12215	1/4	6.4	1/2-20	5/8	1.99	50.5	0.96	24.5
4G-6MB	G25120-0406	7100-12225	1/4	6.4	9/16-18	11/16	2.05	52.0	1.02	26.0
6G-6MB	G25120-0606	7100-13235	3/8	9.5	9/16-18	11/16	2.07	52.5	0.96	24.5
6G-8MB	G25120-0608	7100-13245	3/8	9.5	3/4-16	7/8	2.17	55.0	1.07	27.1
6G-10MB	G25120-0610	7100-12255	3/8	9.5	7/8-14	1	2.22	56.5	1.13	28.6
6G-12MB	G25120-0612	7100-12265	3/8	9.5	1 1/16-12	1 1/4	2.42	61.5	1.32	33.6
8G-8MB	G25120-0808	7100-13275	1/2	12.7	3/4-16	7/8	2.54	64.5	1.06	27.0
8G-10MB	G25120-0810	7100-13285	1/2	12.7	7/8-14	1	2.58	65.5	1.10	28.0
8G-12MB	G25120-0812	7100-13295	1/2	12.7	1 1/16-12	1 1/4	2.78	70.5	1.30	33.0
10G-8MB	G25120-1008	7100-02305	5/8	15.8	3/4-16	1 1/4	2.83	72.0	1.36	34.5
10G-10MB	G25120-1010	7100-13315	5/8	15.8	7/8-14	1	2.64	67.0	1.16	29.5
10G-12MB	G25120-1012	7100-13325	5/8	15.8	1 1/16-12	1 1/4	2.78	70.5	1.30	33.0
12G-12MB	G25120-1212	7100-02335	3/4	19.0	1 1/16-12	1 1/4	3.33	84.5	1.32	33.5
12G-14MB	G25120-1214	7100-02345	3/4	19.0	1 3/16-12	1 3/8	3.31	84.0	1.30	33.0
12G-16MB	G25120-1216	7100-02355	3/4	19.0	1 5/16-12	1 1/2	3.44	87.5	1.44	36.5
16G-14MB	G25120-1614	7100-02365	1	25.4	1 3/16-12	1 3/8	3.78	96.0	1.54	39.2
16G-16MB	G25120-1616	7100-02375	1	25.4	1 5/16-12	1 1/2	3.72	94.5	1.48	37.7
20G-20MB	G25120-2020	7100-02385	1 1/4	31.7	1 5/8-12	1 7/8	3.82	97.0	1.50	38.0

EQUIPMENT
HOSE/CPLG. SELECTION
TECH. DATA
EXT. & VERY HIGH PRESS. HOSE
GS CPLGS.
PCM CPLGS.
PCS CPLGS.
HIGH & MED. PRESS. HOSE
MEGACRIMP® CPLGS.
PC CPLGS.
FIELD ATTACHABLE CPLGS.
AIR BRAKE HOSE & CPLGS.
MEGATECH™ C5 HOSE & CPLGS.
LOW PRESS. HOSE & CPLGS.
C14 HOSE & CPLGS.
POLARSEAL® HOSE & CPLGS.
PWR. STG. HOSE & CPLGS.
THERMO-PLASTIC HOSE & CPLGS.
ADAPTERS
QUICK DISCONNECT CPLGS.
ACCESSORIES & ASSORTMENTS
PART NUMBER INDEXES

## Male O-Ring Boss Swivel

SAE J1926/3 ISO 11926-3 Light-Duty (L Series) Stud End.

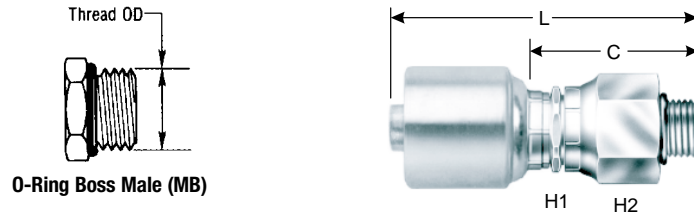

NOT TO BE USED AS A LIVE SWIVEL

Descr	#		⊕			H1	H2	L		C	
			"	mm		"	"	"	mm	"	mm
4G-4MBX	G25121-0404	7100-12385	1/4	6.4	7/16-20	1/2	23/32	2.69	68.4	1.67	42.4
4G-6MBX	G25121-0406	7100-12395	1/4	6.4	9/16-18	5/8	7/8	2.65	67.3	1.62	41.2
6G-6MBX	G25121-0606	7100-12405	3/8	9.5	9/16-18	5/8	7/8	2.73	69.3	1.63	41.3
6G-8MBX	G25121-0608	7100-12415	3/8	9.5	3/4-16	3/4	1	2.74	69.6	1.64	41.6
6G-10MBX	G25121-0610	7100-12425	3/8	9.5	7/8-14	3/4	1	2.80	71.1	1.70	43.1
8G-8MBX	G25121-0808	7100-02435	1/2	12.7	3/4-16	13/16	1	3.11	79.1	1.64	41.6
8G-10MBX	G25121-0810	7100-02445	1/2	12.7	7/8-14	13/16	1	3.17	80.6	1.70	43.1
12G-12MBX	G25121-1212	7100-02455	3/4	19.0	1 1/16-12	1 1/16	1 5/16	4.00	101.5	1.99	50.5

NOTE: Internal O-Rings rated at 250°F (121°C)

## Male O-Ring Boss Swivel – 45° Block

SAE J1926/3 ISO 11926-3 Light-Duty (L Series) Stud End.

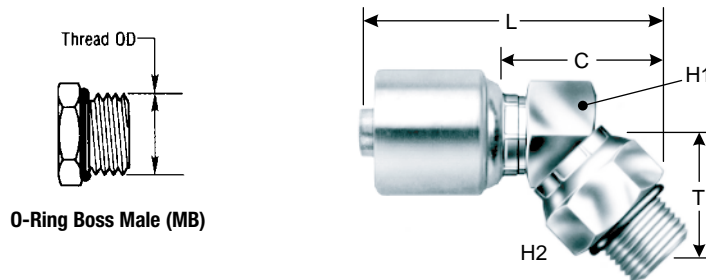

NOT TO BE USED AS A LIVE SWIVEL

Descr	#		⊕			H1	H2	T	L		C		
			"	mm		"	"	"	mm	"	mm	"	mm
6G-6MBX45	G25122-0606	7100-12475	3/8	9.5	3/4-14	3/4	7/8	1.09	27.8	3.11	79.0	2.01	51.0
6G-8MBX45	G25122-0608	7100-12485	3/8	9.5	3/4-16	3/4	1	1.06	26.9	3.07	78.1	1.98	50.2
8G-8MBX45	G25122-0808	7100-02495	1/2	12.7	3/4-16	1	1	1.12	28.4	3.04	77.2	1.56	39.7
8G-10MBX45	G25122-0810	7100-02505	1/2	12.7	7/8-14	1	1	1.16	29.5	3.08	78.3	1.61	40.8

NOTE: Internal O-Rings rated at 250°F (121°C)

EQUIPMENT
HOSE/CPLG. SELECTION
TECH. DATA
EXT. & VERY HIGH PRESS. HOSE
GS CPLGS.
PCM CPLGS.
PCS CPLGS.
HIGH & MED. PRESS. HOSE
MEGACRIMP® CPLGS.
PC CPLGS.
FIELD ATTACHABLE CPLGS.
AIR BRAKE HOSE & CPLGS.
MEGATECH™/C5 HOSE & CPLGS.
LOW PRESS. HOSE & CPLGS.
C14 HOSE & CPLGS.
POLARSEAL® HOSE & CPLGS.
PWR. STG. HOSE & CPLGS.
THERMO-PLASTIC HOSE & CPLGS.
ADAPTERS
QUICK DISCONNECT CPLGS.
ACCESSORIES & ASSORTMENTS
PART NUMBER INDEXES



# MegaCrimp® Couplings - G25 Series

## Male O-Ring Boss Swivel – 90° Block

SAE J1926/3 ISO 11926-3 Light-Duty (L Series) Stud End.

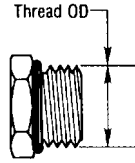

O-Ring Boss Male (MB)

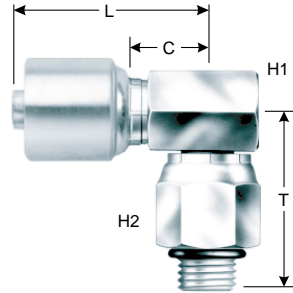

NOT TO BE USED AS A LIVE SWIVEL

DESCR	#		⊖		🌀	H1	H2	T		L		C	
			"	mm		"	"	"	mm	"	mm	"	mm
4G-5MBX90	G25123-0405	7100-12555	1/4	6.4	1/2-20	11/16	11/16	1.57	40.0	1.82	46.3	0.80	20.2
4G-6MBX90	G25123-0406	7100-12515	1/4	6.4	9/16-18	11/16	7/8	1.65	41.8	1.82	46.3	0.80	20.2
6G-6MBX90	G25123-0606	7100-12525	3/8	9.5	9/16-18	3/4	7/8	1.67	42.5	1.96	49.7	0.85	21.7
6G-8MBX90	G25123-0608	7100-12535	3/8	9.5	3/4-16	3/4	1	1.63	41.3	1.93	49.0	0.83	21.1
6G-10MBX90	G25123-0610	7100-12545	3/8	9.5	7/8-14	3/4	1	1.69	42.8	1.95	49.6	0.85	21.7
8G-8MBX90	G25123-0808	7100-02555	1/2	12.7	3/4-16	1	1	1.75	44.5	2.55	64.7	1.07	27.2
8G-8MBX90L <sup>†</sup>	G25124-0808	7100-02705	1/2	12.7	3/4-16	1	1	1.75	44.4	3.27	83.1	1.80	45.6
8G-10MBX90	G25123-0810	7100-02565	1/2	12.7	7/8-14	1	1	1.81	46.0	2.55	64.7	1.07	27.2
8G-10MBX90L <sup>†</sup>	G25124-0810	7100-02715	1/2	12.7	7/8-14	1	1	1.81	46.0	3.27	83.1	1.80	45.6
8G-12MBX90	G25123-0812	7100-02575	1/2	12.7	1 1/16-12	1	1 5/16	2.09	53.1	2.52	64.1	1.05	26.6
8G-12MBX90L <sup>†</sup>	G25124-0812	7100-02725	1/2	12.7	1 1/16-12	1	1 5/16	2.09	53.1	3.76	95.5	2.28	58.0
10G-10MBX90	G25123-1010	7100-02585	5/8	15.8	7/8-14	1	1	1.81	46.0	2.40	60.9	0.93	23.5
12G-12MBX90	G25123-1212	7100-02595	3/4	19.0	1 1/16-12	1 3/8	1 5/16	2.39	60.6	3.18	80.7	1.17	29.7
12G-12MBX90L <sup>†</sup>	G25124-1212	7100-02755	3/4	19.0	1 1/16-12	1 3/8	1 5/16	2.28	57.9	3.94	100.0	1.93	49.0

Note: Internal O-Rings Rated at 250°F (121°C)

<sup>†</sup> These couplings have a longer reach (L dimension) to accommodate the OmniCrimp® 21 crimper.

EQUIPMENT
HOSE/CPLG. SELECTION
TECH. DATA
EXT. & VERY HIGH PRESS. HOSE
GS CPLGS.
PCM CPLGS.
PCS CPLGS.
HIGH & MED. PRESS. HOSE
MEGACRIMP® CPLGS.
PC CPLGS.
FIELD ATTACHABLE CPLGS.
AIR BRAKE HOSE & CPLGS.
MEGATECH™ C5 HOSE & CPLGS.
LOW PRESS. HOSE & CPLGS.
C14 HOSE & CPLGS.
POLARSEAL® HOSE & CPLGS.
PWR. STG. HOSE & CPLGS.
THERMO-PLASTIC HOSE & CPLGS.
ADAPTERS
QUICK DISCONNECT CPLGS.
ACCESSORIES & ASSORTMENTS
PART NUMBER INDEXES



## Male O-Ring Boss Adapterless Swivel

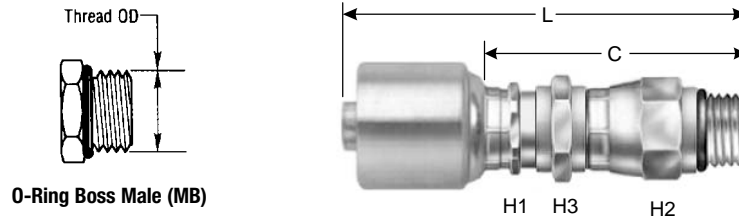

O-Ring Boss Male (MB)

Descr	#		⊕		🌀	H1	H2	H3	L		C	
			"	mm		mm	mm	mm	mm	"	mm	"
4G-4MBAX	G25130-0404	7100-17115	1/4	6.4	7/16-20	14	17	17	3.19	81.0	2.17	55.0
4G-6MBAX	G25130-0406	7100-17135	1/4	6.4	9/16-18	14	17	17	3.19	81.0	2.17	55.0
6G-6MBAX	G25130-0606	7100-17215	3/8	9.5	9/16-18	17	22	22	3.44	87.5	2.35	59.6
6G-8MBAX	G25130-0608	7100-17225	3/8	9.5	3/4-16	17	22	22	3.43	87.0	2.33	59.1
8G-8MBAX	G25130-0808	7100-17265	1/2	12.7	3/4-16	22	24	24	4.02	102.0	2.54	64.5
10G-10MBAX	G25130-1010	7100-17315	5/8	15.8	7/8-14	24	30	30	4.25	108.0	2.78	70.5
12G-12MBAX	G25130-1212	7100-17365	3/4	19.0	1 1/16-12	27	36	36	5.16	131.0	3.15	80.0

NOTE: Internal O-Rings rated at 250°F (121°C)

## Male O-Ring Boss Adapterless Swivel – 45° Bent Tube

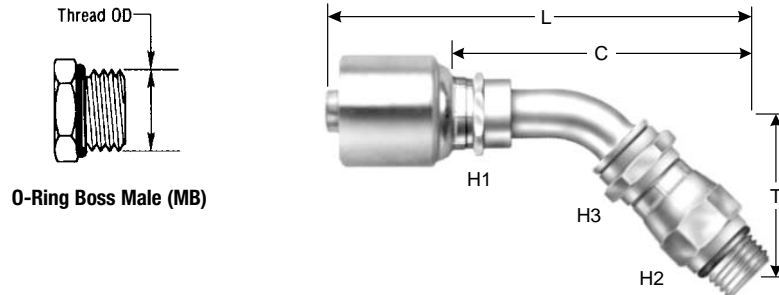

O-Ring Boss Male (MB)

Descr	#		⊕		🌀	H1	H2	H3	T		L		C	
			"	mm		"	mm	mm	mm	mm	mm	"	mm	"
4G-4MBAX45-036	G25133-0404	7100-17615	1/4	6.4	7/16-20	1/2	17	17	1.42	36.0	3.54	90.0	2.52	64.0
6G-6MBAX45-040	G25133-0606	7100-17715	3/8	9.5	9/16-18	5/8	22	22	1.57	40.0	3.98	101.0	2.88	73.1
6G-8MBAX45-040	G25133-0608	7100-17725	3/8	9.5	3/4-16	5/8	22	22	1.57	40.0	3.98	101.0	2.88	73.1
8G-8MBAX45-046	G25133-0808	7100-17765	1/2	12.7	3/4-16	13/16	24	24	1.81	46.0	4.80	122.0	3.33	84.5
10G-10MBAX45-050	G25133-1010	7100-17815	5/8	15.8	7/8-14	15/16	30	30	1.97	50.0	5.08	129.0	3.62	92.0
12G-12MBAX45-506	G25133-1212	7100-17865	3/4	19.0	1 1/16-12	1 1/16	36	36	2.20	56.0	5.98	152.0	3.98	101.0

NOTE: Internal O-Rings rated at 250°F (121°C)

EQUIPMENT
HOSE/CPLG. SELECTION
TECH. DATA
EXT. & VERY HIGH PRESS. HOSE
GS CPLGS.
PCM CPLGS.
PCS CPLGS.
HIGH & MED. PRESS. HOSE
MEGACRIMP® CPLGS.
PC CPLGS.
FIELD ATTACHABLE CPLGS.
AIR BRAKE HOSE & CPLGS.
MEGATECH™/C5 HOSE & CPLGS.
LOW PRESS. HOSE & CPLGS.
C14 HOSE & CPLGS.
POLARSEAL® HOSE & CPLGS.
PWR. STG. HOSE & CPLGS.
THERMO-PLASTIC HOSE & CPLGS.
ADAPTERS
QUICK DISCONNECT CPLGS.
ACCESSORIES & ASSORTMENTS
PART NUMBER INDEXES



# MegaCrimp® Couplings - G25 Series

## Male O-Ring Boss Adapterless Swivel – 90° Bent Tube

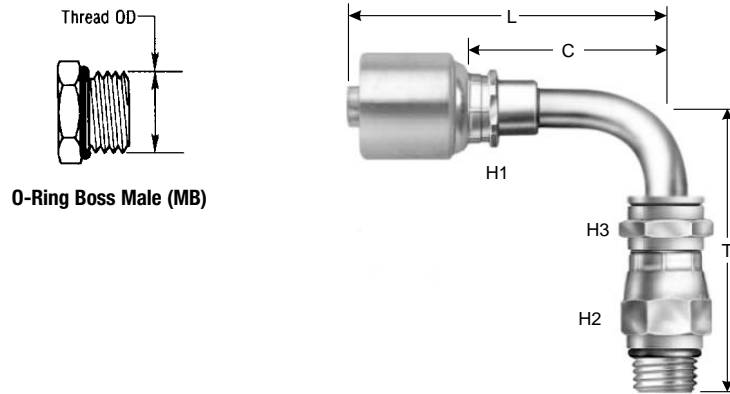

O-Ring Boss Male (MB)

Descr	#		↔		🌀	H1	H2	H3	T		L		C	
			"	mm		"	mm	mm	"	mm	"	mm	"	mm
4G-4MBAX90S	G25135-0404	7100-18115	1/4	6.4	7/16-20	1/2	17	17	2.32	59.0	2.68	68.0	1.65	42.0
4G-4MBAX90L	G25136-0404	7100-19115	1/4	6.4	7/16-20	1/2	17	17	3.35	85.0	2.40	61.0	1.38	35.0
6G-6MBAX90S	G25135-0606	7100-18215	3/8	9.5	9/16-18	5/8	22	22	2.60	66.0	3.07	78.0	1.97	50.1
6G-8MBAX90S	G25135-0608	7100-18225	3/8	9.5	3/4-16	5/8	22	22	2.60	66.0	3.07	78.0	1.97	50.1
6G-6MBAX90L	G25136-0606	7100-19215	3/8	9.5	9/16-18	5/8	22	22	3.78	96.0	2.76	70.0	1.66	42.1
8G-8MBAX90S	G25135-0808	7100-18265	1/2	12.7	3/4-16	13/16	24	24	3.03	77.0	3.80	96.5	2.32	59.0
8G-8MBAX90L	G25136-0808	7100-19265	1/2	12.7	3/4-16	13/16	24	24	4.41	112.0	3.44	87.5	1.97	50.0
10G-10MBAX90S	G25135-1010	7100-18315	5/8	15.8	7/8-14	15/16	30	30	3.39	86.0	4.19	106.5	2.72	69.0
10G-10MBAX90L	G25136-1010	7100-19315	5/8	15.8	7/8-14	15/16	30	30	4.96	126.0	3.76	95.5	2.28	58.0
10G-12MBAX90S	G25135-1012	7100-18325	5/8	15.8	1 1/16-12	15/16	36	36	3.82	97.0	4.49	114.0	3.03	77.0
12G-12MBAX90S	G25135-1212	7100-18365	3/4	19.0	1 1/16-12	1 1/16	36	36	3.82	97.0	5.00	127.0	2.99	76.0
12G-12MBAX90L	G25136-1212	7100-19365	3/4	19.0	1 1/16-12	1 1/16	36	36	5.63	143.0	4.49	114.0	2.48	63.0

NOTE: Internal O-Rings rated at 250°F (121°C)

EQUIPMENT
HOSE/CPLG. SELECTION
TECH. DATA
EXT. & VERY HIGH PRESS. HOSE
GS CPLGS.
PCM CPLGS.
PCS CPLGS.
HIGH & MED. PRESS. HOSE
MEGACRIMP® CPLGS.
PC CPLGS.
FIELD ATTACHABLE CPLGS.
AIR BRAKE HOSE & CPLGS.
MEGATECH™ C5 HOSE & CPLGS.
LOW PRESS. HOSE & CPLGS.
C14 HOSE & CPLGS.
POLARSEAL® HOSE & CPLGS.
PWR. STG. HOSE & CPLGS.
THERMO-PLASTIC HOSE & CPLGS.
ADAPTERS
QUICK DISCONNECT CPLGS.
ACCESSORIES & ASSORTMENTS
PART NUMBER INDEXES

## Male JIC 37° Flare

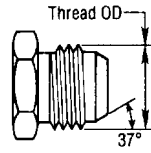

Male (MJ)

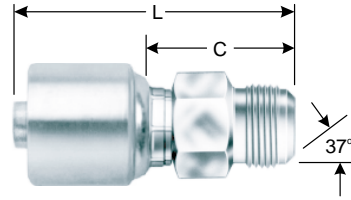

H1

Descr	#		⊕		🌀	H1	L		C	
			"	mm		"	"	mm	"	mm
4G-4MJ	G25165-0404	7100-10635	1/4	6.4	7/16-20	5/8	2.19	55.5	1.16	29.5
4G-5MJ	G25165-0405	7100-10645	1/4	6.4	1/2-20	1/2	2.19	55.5	1.16	29.5
4G-6MJ	G25165-0406	7100-10825	1/4	6.4	9/16-18	9/16	2.20	56.0	1.18	30.0
5G-6MJ	G25165-0506	7100-00665	5/16	7.9	9/16-18	5/8	2.26	57.5	1.16	29.5
6G-6MJ	G25165-0606	7100-10675	3/8	9.5	9/16-18	5/8	2.26	57.5	1.17	29.6
6G-8MJ	G25165-0608	7100-10835	3/8	9.5	3/4-16	3/4	2.40	61.0	1.30	33.1
6G-10MJ	G25165-0610	7100-10845	3/8	9.5	7/8-14	7/8	2.52	64.0	1.42	36.1
8G-8MJ	G25165-0808	7100-10705	1/2	12.7	3/4-16	13/16	2.68	68.0	1.20	30.5
8G-10MJ	G25165-0810	7100-00715	1/2	12.7	7/8-14	7/8	2.78	70.5	1.30	33.0
8G-12MJ	G25165-0812	7100-00725	1/2	12.7	1 1/16-12	1 1/16	2.97	75.5	1.50	38.0
10G-8MJ	G25165-1008	7100-00735	5/8	15.8	3/4-16	15/16	2.83	72.0	1.36	34.5
10G-10MJ	G25165-1010	7100-00745	5/8	15.8	7/8-14	15/16	2.99	76.0	1.52	38.5
10G-12MJ	G25165-1012	7100-00755	5/8	15.8	1 1/16-12	1 1/16	2.97	75.5	1.50	38.0
12G-12MJ	G25165-1212	7100-00765	3/4	19.0	1 1/16-12	1 1/16	3.68	93.5	1.67	42.5
12G-14MJ	G25165-1214	7100-00775	3/4	19.0	1 3/16-12	1 3/16	3.58	91.0	1.57	40.0
12G-16MJ	G25165-1216	7100-10785	3/4	19.0	1 5/16-12	1 5/16	3.62	92.0	1.61	41.0
16G-16MJ	G25165-1616	7100-00795	1	25.4	1 5/16-12	1 3/8	4.11	104.5	1.88	47.7
16G-20MJ	G25165-1620	7100-00805	1	25.4	1 5/8-12	1 3/4	4.29	109.0	2.06	52.2
20G-20MJ	G25165-2020	7100-00815	1 1/4	31.7	1 5/8-12	1 3/4	4.43	112.5	2.07	53.5

EQUIPMENT

HOSE/CPLG. SELECTION

TECH. DATA

EXT. & VERY HIGH PRESS. HOSE

GS CPLGS.

PCM CPLGS.

PCS CPLGS.

HIGH & MED. PRESS. HOSE

MEGACRIMP® CPLGS.

PC CPLGS.

FIELD ATTACHABLE CPLGS.

AIR BRAKE HOSE & CPLGS.

MEGATECH™/C5 HOSE & CPLGS.

LOW PRESS. HOSE & CPLGS.

C14 HOSE & CPLGS.

POLARSEAL® HOSE & CPLGS.

PWR. STG. HOSE & CPLGS.

THERMO-PLASTIC HOSE & CPLGS.

ADAPTERS

QUICK DISCONNECT CPLGS.

ACCESSORIES & ASSORTMENTS

PART NUMBER INDEXES



# MegaCrimp® Couplings - G25 Series

## Female JIC 37° Flare Swivel

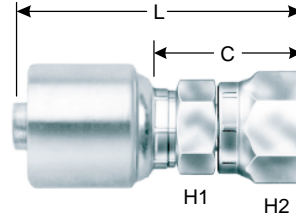
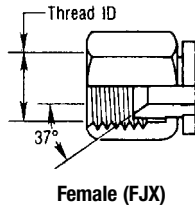

DESCR	#		⊕		🌀	H1	H2	L		C	
			"	mm		"	"	"	mm	"	mm
4G-4FJX	G25170-0404	7100-00875	1/4	6.4	7/16-20	1/2	9/16	2.10	53.4	1.08	27.4
4G-5FJX	G25170-0405	7100-10895	1/4	6.4	1/2-20	1/2	11/16	2.21	56.2	1.19	30.2
4G-6FJX	G25170-0406	7100-10905	1/4	6.4	9/16-18	9/16	3/4	2.22	56.3	1.19	30.2
MEGACRIMP® CPLGS.	5G-5FJX	G25170-0505	5/16	7.9	1/2-20	5/8	11/16	2.23	56.7	1.13	28.7
	5G-6FJX	G25170-0506	5/16	7.9	9/16-18	5/8	3/4	2.31	58.8	1.21	30.8
PC CPLGS.	6G-4FJX	G25170-0604	3/8	9.5	7/16-20	5/8	9/16	2.30	58.4	1.20	30.5
	6G-5FJX	G25170-0605	3/8	9.5	1/2-20	5/8	11/16	2.23	56.7	1.13	28.8
FIELD ATTACHABLE CPLGS.	6G-6FJX	G25170-0606	3/8	9.5	9/16-18	5/8	3/4	2.31	58.8	1.19	30.2
	6G-8FJX	G25170-0608	3/8	9.5	3/4-16	11/16	7/8	2.48	63.1	1.38	35.1
	6G-10FJX	G25170-0610	3/8	9.5	7/8-14	13/16	1 1/16	2.61	66.2	1.50	38.2
AIR BRAKE HOSE & CPLGS.	8G-6FJX	G25170-0806	1/2	12.7	9/16-18	13/16	3/4	2.63	66.8	1.15	29.3
	8G-8FJX	G25170-0808	1/2	12.7	3/4-16	13/16	7/8	2.82	71.6	1.34	34.1
MEGATECH™ C5 HOSE & CPLGS.	8G-10FJX	G25170-0810	1/2	12.7	7/8-14	13/16	1 1/16	2.96	75.1	1.48	37.7
	8G-12FJX	G25170-0812	1/2	12.7	1 1/16-12	1	1 1/4	3.15	80.1	1.68	42.6
	10G-8FJX	G25170-1008	5/8	15.8	3/4-16	15/16	7/8	2.90	73.6	1.42	36.1
	10G-10FJX	G25170-1010	5/8	15.8	7/8-14	15/16	1 1/16	3.04	77.1	1.56	39.7
LOW PRESS. HOSE & CPLGS.	10G-12FJX	G25170-1012	5/8	15.8	1 1/16-12	1	1 1/4	3.09	78.5	1.61	41.0
	10G-14FJX	G25170-1014	5/8	15.8	1 3/16-12	1 1/8	1 3/8	3.14	79.7	1.66	42.2
	12G-8FJX	G25170-1208	3/4	19.0	3/4-16	1 1/16	7/8	3.51	89.1	1.50	38.1
C14 HOSE & CPLGS.	12G-10FJX	G25170-1210	3/4	19.0	7/8-14	1 1/16	1 1/16	3.51	89.1	1.50	38.1
	12G-12FJX	G25170-1212	3/4	19.0	1 1/16-12	1 1/16	1 1/4	3.68	93.5	1.67	42.5
POLARSEAL® HOSE & CPLGS.	12G-14FJX	G25170-1214	3/4	19.0	1 3/16-12	1 1/8	1 3/8	3.65	92.7	1.64	41.6
	12G-16FJX	G25170-1216	3/4	19.0	1 5/16-12	1 1/4	1 1/2	3.78	96.0	1.77	45.0
	16G-12FJX	G25170-1612	1	25.4	1 1/16-12	1 3/8	1 1/4	3.98	101.0	1.74	44.2
PWR. STG. HOSE & CPLGS.	16G-14FJX	G25170-1614	1	25.4	1 3/16-12	1 3/8	1 3/8	4.00	101.6	1.77	44.9
	16G-16FJX	G25170-1616	1	25.4	1 5/16-12	1 3/8	1 1/2	4.17	106.0	1.94	49.2
	16G-20FJX	G25170-1620	1	25.4	1 5/8-12	1 9/16	2	4.33	109.9	2.09	53.1
THERMO- PLASTIC HOSE & CPLGS.	20G-20FJX	G25170-2020	1 1/4	31.7	1 5/8-12	1 3/4	2	4.60	116.9	2.28	57.9
	20G-24FJX	G25170-2024	1 1/4	31.7	1 7/8-12	1 7/8	2 1/4	4.85	123.2	2.53	64.2

## Female JIC 37° Flare Swivel – 30° Bent Tube

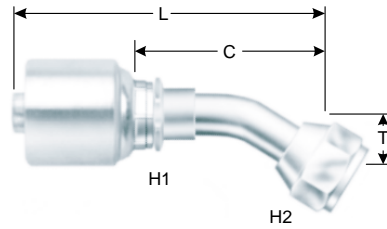
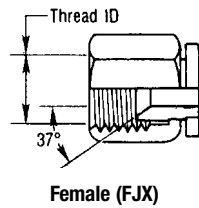

Descr	#		⊕		🌀	H1	H2	T		L		C	
			"	mm		"	"	"	mm	"	mm	"	mm
10G-12FJX30-018	G25172-1012	7100-01185	5/8	15.8	1 1/16	7/8	1 1/4	0.70	17.8	4.45	112.4	2.95	74.9
12G-10FJX30	G25172-1210	7100-07125	3/4	19.0	7/8-14	1	1 1/16	0.70	17.8	4.45	113.0	2.44	62.0

## Female JIC 37° Flare Swivel – 45° Bent Tube

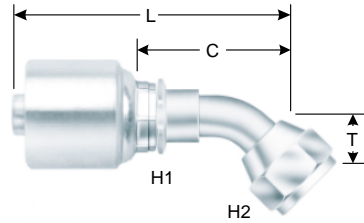
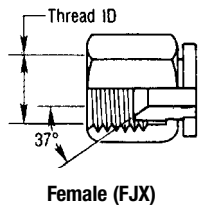

Descr	#		⊕		🌀	H1	H2	T		L		C	
			"	mm		"	"	"	mm	"	mm	"	mm
4G-4FJX45	G25175-0404	7100-11215	1/4	6.4	7/16-20	1/2	9/16	0.47	11.9	2.28	58.0	1.26	32.0
4G-5FJX45	G25175-0405	7100-11235	1/4	6.4	1/2-20	1/2	5/8	0.56	14.2	2.56	65.0	1.54	39.0
4G-6FJX45	G25175-0406	7100-11255	1/4	6.4	9/16-18	1/2	11/16	0.56	14.2	2.73	69.4	1.71	43.4
5G-5FJX45	G25175-0505	7100-01265	5/16	7.9	1/2-20	5/8	5/8	0.56	14.2	2.60	66.0	1.50	38.0
5G-6FJX45	G25175-0506	7100-01275	5/16	7.9	9/16-18	5/8	11/16	0.56	14.2	2.87	73.0	1.77	45.0
6G-6FJX45	G25175-0606	7100-11305	3/8	9.5	9/16-18	5/8	11/16	0.56	14.2	2.91	73.9	1.81	46.0
6G-8FJX45	G25175-0608	7100-11325	3/8	9.5	3/4-16	5/8	7/8	0.69	17.5	2.88	73.1	1.78	45.2
8G-8FJX45	G25175-0808	7100-20005	1/2	12.7	3/4-16	13/16	7/8	0.59	15.0	3.31	84.1	1.83	46.6
8G-10FJX45	G25175-0810	7100-01365	1/2	12.7	7/8-14	13/16	1	0.75	19.1	3.62	91.9	2.14	54.4
10G-10FJX45	G25175-1010	7100-01375	5/8	15.8	7/8-14	15/16	1	0.75	19.1	3.60	91.5	2.13	54.0
10G-12FJX45	G25175-1012	7100-01385	5/8	15.8	1 1/16-12	15/16	1 1/4	1.06	26.9	4.13	105.0	2.66	67.5
12G-10FJX45	G25175-1210	7100-01395	3/4	19.0	7/8-14	1 1/16	1	0.75	19.1	4.57	116.0	2.56	65.0
12G-12FJX45	G25175-1212	7100-01415	3/4	19.0	1 1/16-12	1 1/16	1 1/4	1.06	26.9	4.89	124.2	2.88	73.2
12G-16FJX45	G25175-1216	7100-01425	3/4	19.0	1 5/16-12	1 3/16	1 1/2	1.16	29.5	5.75	146.0	3.74	95.0
16G-12FJX45S	G25174-1612	7100-01435	1	25.4	1 1/16-12	1 3/8	1 1/4	0.83	21.0	5.16	131.0	2.92	74.2
16G-16FJX45	G25175-1616	7100-01455	1	25.4	1 5/16-12	1 3/8	1 1/2	1.16	29.5	5.30	134.6	3.06	77.8
20G-20FJX45	G25175-2020	7100-01465	1 1/4	31.7	1 5/8-12	1 3/4	2	1.38	35.0	6.65	169.0	4.33	110.0

EQUIPMENT
HOSE/CPLG. SELECTION
TECH. DATA
EXT. & VERY HIGH PRESS. HOSE
GS CPLGS.
PCM CPLGS.
PCS CPLGS.
HIGH & MED. PRESS. HOSE
MEGACRIMP® CPLGS.
PC CPLGS.
FIELD ATTACHABLE CPLGS.
AIR BRAKE HOSE & CPLGS.
MEGATECH™/C5 HOSE & CPLGS.
LOW PRESS. HOSE & CPLGS.
C14 HOSE & CPLGS.
POLARSEAL® HOSE & CPLGS.
PWR. STG. HOSE & CPLGS.
THERMO-PLASTIC HOSE & CPLGS.
ADAPTERS
QUICK DISCONNECT CPLGS.
ACCESSORIES & ASSORTMENTS
PART NUMBER INDEXES



# MegaCrimp® Couplings - G25 Series

## Female JIC 37° Flare Swivel – 90° Bent Tube

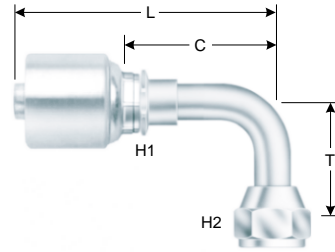
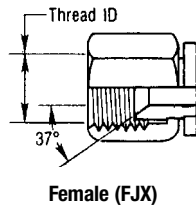

DESCR	#		⊖		🌀	H1	H2	T		L		C	
			"	mm		"	"	"	mm	"	mm	"	mm
4G-4FJX90S	G25179-0404	7100-11475	1/4	6.4	7/16-20	1/2	9/16	0.68	17.3	2.26	57.3	1.23	31.3
4G-4FJX90M	G25180-0404	7100-11485	1/4	6.4	7/16-20	1/2	9/16	0.88	22.4	2.06	52.2	1.03	26.2
4G-4FJX90L	G25181-0404	7100-11495	1/4	6.4	7/16-20	1/2	9/16	1.80	45.7	2.06	52.2	1.03	26.2
4G-5FJX90S	G25179-0405	7100-11505	1/4	6.4	1/2-20	1/2	5/8	0.77	19.6	2.32	59.0	1.30	33.0
4G-5FJX90M	G25180-0405	7100-11515	1/4	6.4	1/2-20	1/2	5/8	1.13	28.7	2.17	55.2	1.15	29.2
4G-6FJX90S	G25179-0406	7100-11535	1/4	6.4	9/16-18	1/2	11/16	0.85	21.6	2.52	63.9	1.49	37.9
4G-6FJX90M	G25180-0406	7100-07165	1/4	6.4	9/16-18	1/2	11/16	1.13	28.7	2.52	64.0	1.50	38.0
4G-6FJX90L	G25181-0406	7100-11555	1/4	6.4	9/16-18	1/2	11/16	2.13	54.0	2.80	71.0	1.77	45.0
5G-6FJX90S	G25179-0506	7100-07235	5/16	7.9	9/16-18	5/8	11/16	0.85	21.6	2.67	67.9	1.57	39.9
5G-6FJX90M	G25180-0506	7100-01555	5/16	7.9	9/16-18	5/8	11/16	1.13	28.7	2.52	64.0	1.42	36.0
6G-4FJX90S	G25179-0604	7100-07305	3/8	9.5	7/16-20	5/8	9/16	0.83	21.0	2.37	60.3	1.28	32.4
6G-4FJX90L	G25181-0604	7100-07325	3/8	9.5	7/16-20	5/8	9/16	1.81	46.0	2.21	56.2	1.11	28.3
6G-6FJX90S	G25179-0606	7100-11565	3/8	9.5	9/16-18	5/8	11/16	0.85	21.6	2.36	60.0	1.22	31.0
6G-6FJX90M	G25180-0606	7100-11575	3/8	9.5	9/16-18	5/8	11/16	1.13	28.7	2.32	58.9	1.22	31.0
6G-6FJX90L	G25181-0606	7100-11585	3/8	9.5	9/16-18	5/8	11/16	2.18	55.4	2.60	66.0	1.50	38.1
6G-8FJX90S	G25179-0608	7100-11595	3/8	9.5	3/4-16	5/8	7/8	1.09	27.7	2.74	69.7	1.65	41.8
6G-8FJX90M	G25180-0608	7100-11605	3/8	9.5	3/4-16	5/8	7/8	1.38	35.1	2.54	64.4	1.44	36.5
6G-8FJX90L	G25181-0608	7100-11615	3/8	9.5	3/4-16	5/8	7/8	2.43	61.7	2.54	64.4	1.44	36.5
6G-10FJX90M	G25180-0610	7100-07215	3/8	9.5	7/8-14	5/8	1	1.75	44.5	2.78	70.5	1.67	42.5
8G-8FJX90S	G25179-0808	7100-20015	1/2	12.7	3/4-16	N/A	7/8	1.14	29.0	3.16	80.3	1.69	42.8
8G-8FJX90M	G25180-0808	7100-20025	1/2	12.7	3/4-16	N/A	7/8	1.38	41.0	2.93	74.3	1.45	36.8
8G-8FJX90L	G25181-0808	7100-20035	1/2	12.7	3/4-16	N/A	7/8	2.52	64.0	2.91	74.0	1.44	36.6
8G-10FJX90S	G25179-0810	7100-01655	1/2	12.7	7/8-14	N/A	1	1.23	31.2	3.72	94.5	2.24	57.0
8G-10FJX90M	G25180-0810	7100-01665	1/2	12.7	7/8-14	N/A	1	1.75	44.5	3.20	81.3	1.73	43.9
8G-10FJX90L	G25181-0810	7100-01675	1/2	12.7	7/8-14	N/A	1	2.57	65.3	3.15	80.1	1.68	42.7
8G-12FJX90S	G25179-0812	7100-11645	1/2	12.7	1 1/16-12	N/A	1 1/4	1.89	48.0	4.13	105.0	2.66	67.5
10G-10FJX90S	G25179-1010	7100-01685	5/8	15.8	7/8-14	15/16	1	1.23	31.2	3.37	85.5	1.89	48.0
10G-10FJX90M	G25180-1010	7100-01705	5/8	15.8	7/8-14	15/16	1	1.75	44.5	3.19	81.0	1.71	43.5
10G-10FJX90L	G25181-1010	7100-07175	5/8	15.8	7/8-14	15/16	1	2.57	65.3	3.19	81.0	1.71	43.5
10G-12FJX90S	G25179-1012	7100-01695	5/8	15.8	1 1/16-12	15/16	1 1/4	1.82	46.2	3.77	95.8	2.30	58.3
10G-12FJX90L	G25181-1012	7100-07245	5/8	15.8	1 1/16-12	15/16	1 1/4	3.78	96.0	3.35	85.0	1.87	47.5
12G-10FJX90M	G25180-1210	7100-07195	3/4	19.0	7/8-14	1 1/16	1	1.75	44.5	3.78	96.0	1.77	45.0
12G-12FJX90S	G25179-1212	7100-01715	3/4	19.0	1 1/16-12	1 1/16	1 1/4	1.82	46.2	4.26	108.2	2.25	57.2
12G-12FJX90M	G25180-1212	7100-01725	3/4	19.0	1 1/16-12	1 1/16	1 1/4	2.06	52.3	3.83	97.2	1.82	46.2
12G-12FJX90L	G25181-1212	7100-01735	3/4	19.0	1 1/16-12	1 1/16	1 1/4	3.73	94.7	3.83	97.2	1.82	46.2
12G-14FJX90S	G25179-1214	7100-01745	3/4	19.0	1 3/16-12	1 1/16	1 3/8	2.00	50.8	4.88	124.0	2.87	73.0
12G-14FJX90L	G25181-1214	7100-01755	3/4	19.0	1 3/16-12	1 1/16	1 3/8	3.93	99.8	4.13	105.0	2.13	54.0
16G-16FJX90S	G25179-1616	7100-01765	1	25.4	1 5/16-12	1 3/8	1 1/2	2.23	56.6	5.11	129.9	2.88	73.1
16G-16FJX90M	G25180-1616	7100-01785	1	25.4	1 5/16-12	1 3/8	1 1/2	2.62	66.5	4.52	114.9	2.29	58.1
16G-16FJX90L	G25181-1616	7100-01775	1	25.4	1 5/16-12	1 3/8	1 1/2	4.33	110.0	4.52	114.9	2.29	58.1
16G-20FJX90S	G25179-1620	7100-07205	1	25.4	1 5/8-12	1 3/8	2	2.95	75.0	6.57	167.0	4.34	110.2
20G-20FJX90M	G25180-2020	7100-01795	1 1/4	31.7	1 5/8-12	1 3/4	2	3.50	88.9	5.43	138.0	3.11	79.0

## Female JIC 37° Flare Swivel – 90° Block

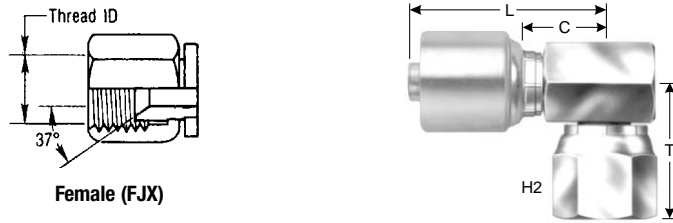

Descr	#		⌀		🌀	H1	H2	T		L		C	
			"	mm		"	"	"	mm	"	mm	"	mm
12G-16FJX90BL	G25187-1216	7101-50545	3/4	19.0	1 5/16-12	1 3/8	1 1/2	2.09	53.2	3.74	95.0	1.76	44.0

## Male SAE 45° Flare

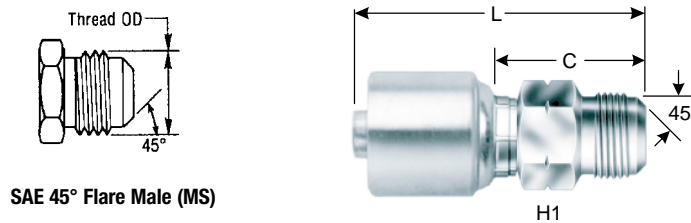

Descr	#		⌀		🌀	H1	L		C	
			"	mm		"	"	mm	"	mm
4G-4MS	G25195-0404	7100-11815	1/4	6.4	7/16-20	1/2	2.11	53.5	1.08	27.5
4G-5MS	G25195-0405	7100-11825	1/4	6.4	1/2-20	1/2	2.16	54.8	1.13	28.8
6G-6MS	G25195-0606	7100-11835	3/8	9.5	5/8-18	5/8	2.28	58.0	1.19	30.1
6G-8MS	G25195-0608	7100-11845	3/8	9.5	3/4-16	11/16	2.42	61.4	1.32	33.4
8G-8MS	G25195-0808	7100-01855	1/2	12.7	3/4-16	13/16	2.78	70.5	1.30	33.0
8G-10MS	G25195-0810	7100-01865	1/2	12.7	7/8-14	7/8	2.89	73.5	1.42	36.0
12G-12MS	G25195-1212	7100-01875	3/4	19.0	1 1/16-14	1 1/16	3.78	96.0	1.77	45.0

## Female SAE 45° Flare Swivel

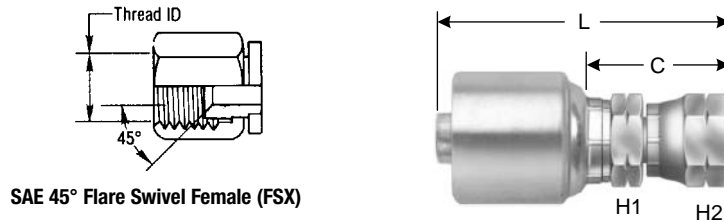

Descr	#		⌀		🌀	H1	H2	L		C	
			"	mm		"	"	"	mm	"	mm
4G-4FSX	G25200-0404	7100-11885	1/4	6.4	7/16-20	1/2	9/16	2.24	57.0	1.22	31.0
4G-5FSX	G25200-0405	7100-11895	1/4	6.4	1/2-20	1/2	11/16	2.21	56.2	1.19	30.2
4G-6FSX	G25200-0406	7100-11905	1/4	6.4	5/8-18	5/8	3/4	2.31	58.7	1.28	32.6
5G-6FSX	G25200-0506	7100-11935	5/16	7.9	5/8-18	5/8	3/4	2.44	62.1	1.34	34.1
6G-6FSX	G25200-0606	7100-11915	3/8	9.5	5/8-18	5/8	3/4	2.45	62.1	1.35	34.2
6G-8FSX	G25200-0608	7100-11925	3/8	9.5	3/4-16	11/16	7/8	2.48	63.1	1.38	35.1
8G-8FSX	G25200-0808	7100-01935	1/2	12.7	3/4-16	13/16	7/8	2.82	71.6	1.34	34.1
8G-10FSX	G25200-0810	7100-01945	1/2	12.7	7/8-14	13/16	1 1/16	2.99	75.9	1.51	38.4
12G-12FSX	G25200-1212	7100-01955	3/4	19.0	1 1/16-14	1 1/16	1 1/4	3.68	93.5	1.67	42.5

EQUIPMENT  
HOSE/CPLG. SELECTION  
TECH. DATA  
EXT. & VERY HIGH PRESS. HOSE  
GS CPLGS.  
PCM CPLGS.  
PCS CPLGS.  
HIGH & MED. PRESS. HOSE  
MEGACRIMP® CPLGS.  
PC CPLGS.  
FIELD ATTACHABLE CPLGS.  
AIR BRAKE HOSE & CPLGS.  
MEGATECH™/C5 HOSE & CPLGS.  
LOW PRESS. HOSE & CPLGS.  
C14 HOSE & CPLGS.  
POLARSEAL® HOSE & CPLGS.  
PWR. STG. HOSE & CPLGS.  
THERMO-PLASTIC HOSE & CPLGS.  
ADAPTERS  
QUICK DISCONNECT CPLGS.  
ACCESSORIES & ASSORTMENTS  
PART NUMBER INDEXES



# MegaCrimp® Couplings - G25 Series

## Female SAE 45° Flare Swivel – 45° Bent Tube

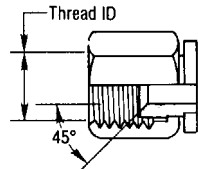

SAE 45° Flare Swivel Female (FSX)

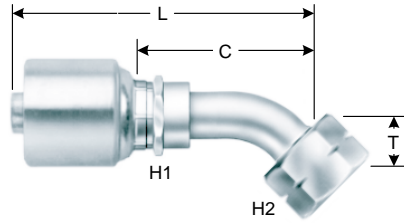

Descr	#		⌀		🌀	H1	H2	T		L		C	
			"	mm		"	"	"	mm	"	mm	"	mm
4G-5FSX45-009	G25202-0405	7100-01965	1/4	6.4	1/2-20	5/8	1 1/6	0.36	9.1	2.63	66.9	1.61	40.9
6G-6FSX45	G25202-0606	7100-11995	3/8	9.5	5/8-18	5/8	3/4	0.39	9.9	2.74	69.5	1.64	41.6
6G-8FSX45-014	G25202-0608	7100-02035	3/8	9.5	3/4-16	5/8	7/8	0.55	14.0	3.46	87.8	2.36	59.9
8G-8FSX45	G25202-0808	7100-02015	1/2	12.7	3/4-16	13/16	7/8	0.55	14.0	3.31	84.0	1.83	46.5
8G-10FSX45-016	G25202-0810	7100-02055	1/2	12.7	7/8-14	13/16	1	0.63	16.0	3.66	93.1	2.19	55.6
12G-12FSX45	G25202-1212	7100-02045	3/4	19.1	1 1/16-14	1 1/16	1 1/4	0.78	19.8	4.37	111.0	2.36	60.0

## Female SAE 45° Flare Swivel – 90° Bent Tube

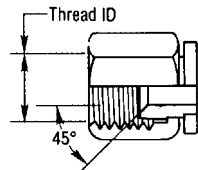

SAE 45° Flare Swivel Female (FSX)

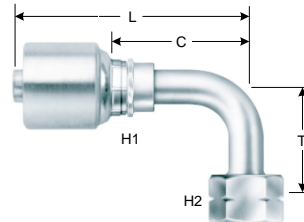

Descr	#		⌀		🌀	H1	H2	T		L		C	
			"	mm		"	"	"	mm	"	mm	"	mm
4G-4FSX90	G25205-0404	7100-12055	1/4	6.4	7/16-20	1/2	9/16	1.24	31.5	2.05	52.0	1.02	26.0
4G-5FSX90-046	G25205-0405	7100-01985	1/4	6.4	1/2-20	1/2	5/8	1.80	45.7	2.47	62.8	1.45	36.8
5G-6FSX90-022	G25204-0506	7100-02005	5/16	7.9	5/8-18	5/8	3/4	0.85	21.6	2.77	70.4	1.67	42.4
6G-6FSX90	G25205-0606	7100-12105	3/8	9.5	5/8-18	5/8	3/4	1.52	38.5	2.36	60.0	1.26	32.1
6G-6FSX90-055	G25206-0606	7100-01995	3/8	9.5	5/8-18	5/8	3/4	2.18	55.4	2.83	71.8	1.73	43.9
6G-8FSX90	G25205-0608	7100-02125	3/8	9.5	3/4-16	5/8	7/8	1.75	44.5	2.93	74.5	1.46	37.0
8G-8FSX90	G25205-0808	7100-02135	1/2	12.7	3/4-16	13/16	7/8	1.75	44.5	2.93	74.5	1.46	37.0
8G-10FSX90-031	G25204-0810	7100-02065	1/2	12.7	7/8-14	13/16	1	1.23	31.2	3.29	83.5	1.81	46.0
12G-12FSX90	G25205-1212	7100-02185	3/4	19.0	1 1/16-14	1 1/16	1 1/4	2.78	70.5	3.94	100.0	1.93	49.0



## Male Flat-Face O-Ring

SAE J1453 Captive O-Ring Groove for Improved O-Ring Retention.

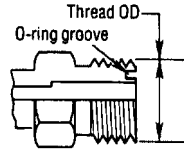

Male Flat-Face O-Ring (MFFOR)

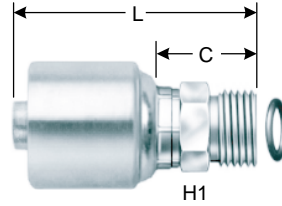

NOT TO BE USED AS A LIVE SWIVEL

Descr	#		⊖		🌀	H1	L		C	
			"	mm			mm	"	mm	"
4G-4MFFOR	G25225-0404	7102-12765	1/4	6.4	9/16-18	17	2.07	52.5	1.04	26.5
4G-6MFFOR	G25225-0406	7102-12835	1/4	6.4	11/16-16	19	2.13	54.0	1.10	28.0
6G-6MFFOR	G25225-0606	7102-12775	3/8	9.5	11/16-16	19	2.20	56.0	1.11	28.1
6G-8MFFOR	G25225-0608	7102-12845	3/8	9.5	13/16-16	22	2.32	59.0	1.22	31.1
6G-10MFFOR	G25225-0610	7102-12875	3/8	9.5	1-14	27	2.52	64.0	1.42	36.1
8G-8MFFOR	G25225-0808	7102-12785	1/2	12.7	13/16-16	22	2.69	68.2	1.21	30.7
8G-10MFFOR	G25225-0810	7102-12855	1/2	12.7	1-14	27	2.87	73.0	1.40	35.5
10G-10MFFOR	G25225-1010	7102-02795	5/8	15.8	1-14	27	2.70	68.5	1.22	31.0
10G-12MFFOR	G25225-1012	7102-02885	5/8	15.8	1 3/16-12	32	2.83	72.0	1.36	34.5
12G-12MFFOR	G25225-1212	7102-12805	3/4	19.0	1 3/16-12	32	3.54	90.0	1.54	39.0
12G-16MFFOR	G25225-1216	7102-12865	3/4	19.0	1 7/16-12	41	3.74	95.0	1.73	44.0
16G-16MFFOR	G25225-1616	7102-12815	1	25.4	1 7/16-12	41	4.02	102.0	1.78	45.2
16G-20MFFOR	G25225-1620	7102-12895	1	25.4	1 11/16-12	46	4.13	105.0	1.90	48.2
20G-20MFFOR	G25225-2020	7102-12825	1 1/4	31.7	1 11/16-12	46	4.29	109.0	1.97	50.0

EQUIPMENT

HOSE/CPLG. SELECTION

TECH. DATA

EXT. & VERY HIGH PRESS. HOSE

GS CPLGS.

PCM CPLGS.

PCS CPLGS.

HIGH & MED. PRESS. HOSE

MEGACRIMP® CPLGS.

PC CPLGS.

FIELD ATTACHABLE CPLGS.

AIR BRAKE HOSE & CPLGS.

MEGATECH™/C5 HOSE & CPLGS.

LOW PRESS. HOSE & CPLGS.

C14 HOSE & CPLGS.

POLARSEAL® HOSE & CPLGS.

PWR. STG. HOSE & CPLGS.

THERMO-PLASTIC HOSE & CPLGS.

ADAPTERS

QUICK DISCONNECT CPLGS.

ACCESSORIES & ASSORTMENTS

PART NUMBER INDEXES



# MegaCrimp® Couplings - G25 Series

## Female Flat-Face O-Ring Swivel

SAE J1453 O-Ring Face Seal.

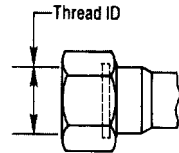

Female Flat-Face O-Ring Swivel (FFORX)

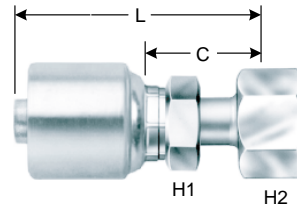

Descr	#		⊕		🌀	H1	H2	L		C	
			"	mm		"	"	"	mm	"	mm
4G-4FFORX	G25230-0404	7102-13125	1/4	6.4	9/16-18	9/16	11/16	2.15	54.5	1.12	28.5
4G-6FFORX	G25230-0406	7102-13135	1/4	6.4	11/16-16	5/8	13/16	2.24	57.0	1.22	31.0
5G-6FFORX	G25230-0506	7102-04015	5/16	7.9	11/16-16	5/8	13/16	2.70	68.5	1.22	31.0
6G-4FFORX	G25230-0604	7102-13195	3/8	9.5	9/16-18	21/32	11/16	2.24	57.0	1.15	29.1
6G-6FFORX	G25230-0606	7102-13145	3/8	9.5	11/16-16	5/8	13/16	2.32	59.0	1.22	31.0
6G-8FFORX	G25230-0608	7102-13155	3/8	9.5	13/16-16	3/4	15/16	2.52	64.0	1.42	36.1
8G-6FFORX	G25230-0806	7102-04045	1/2	12.7	11/16-16	13/16	13/16	2.74	69.5	1.26	32.0
8G-8FFORX	G25230-0808	7102-03165	1/2	12.7	13/16-16	13/16	15/16	2.89	73.5	1.42	36.0
8G-10FFORX	G25230-0810	7102-03175	1/2	12.7	1-14	15/16	1 1/8	3.19	81.0	1.71	43.5
8G-12FFORX	G25230-0812	7102-04005	1/2	12.7	1 3/16-12	15/16	1 3/8	3.32	84.3	1.84	46.8
10G-10FFORX	G25230-1010	7102-03185	5/8	15.8	1-14	1	1 1/8	3.21	81.5	1.73	44.0
10G-12FFORX	G25230-1012	7102-03195	5/8	15.8	1 3/16-12	15/16	1 3/8	3.31	84.0	1.83	46.5
12G-10FFORX	G25230-1210	7102-03205	3/4	19.0	1-14	1 1/16	1 1/8	3.76	95.5	1.75	44.5
12G-12FFORX	G25230-1212	7102-03905	3/4	19.0	1 3/16-12	1 1/16	1 3/8	3.78	96.0	1.77	45.0
12G-16FFORX	G25230-1216	7102-04205	3/4	19.0	1 7/16-12	1 1/8	1 5/8	3.99	101.4	1.98	50.4
16G-12FFORX	G25230-1612	7102-13185	1	25.4	1 3/16-12	1 3/8	1 3/8	4.17	106.0	1.94	49.2
16G-16FFORX	G25230-1616	7102-04185	1	25.4	1 7/16-12	1 3/8	1 5/8	4.46	113.4	2.23	56.6
16G-20FFORX	G25230-1620	7102-04215	1	25.4	1 11/16-12	1 3/8	1 7/8	4.46	113.4	2.23	56.6
20G-20FFORX	G25230-2020	7102-04195	1 1/4	31.7	1 11/16-12	1 3/4	1 7/8	4.50	114.4	2.18	55.4

EQUIPMENT
HOSE/CPLG. SELECTION
TECH. DATA
EXT. & VERY HIGH PRESS. HOSE
GS CPLGS.
PCM CPLGS.
PCS CPLGS.
HIGH & MED. PRESS. HOSE
MEGACRIMP® CPLGS.
PC CPLGS.
FIELD ATTACHABLE CPLGS.
AIR BRAKE HOSE & CPLGS.
MEGATECH™ C5 HOSE & CPLGS.
LOW PRESS. HOSE & CPLGS.
C14 HOSE & CPLGS.
POLARSEAL® HOSE & CPLGS.
PWR. STG. HOSE & CPLGS.
THERMO-PLASTIC HOSE & CPLGS.
ADAPTERS
QUICK DISCONNECT CPLGS.
ACCESSORIES & ASSORTMENTS
PART NUMBER INDEXES

## Female Flat-Face O-Ring Swivel – 45° Bent Tube

SAE J1453 O-Ring Face Seal.

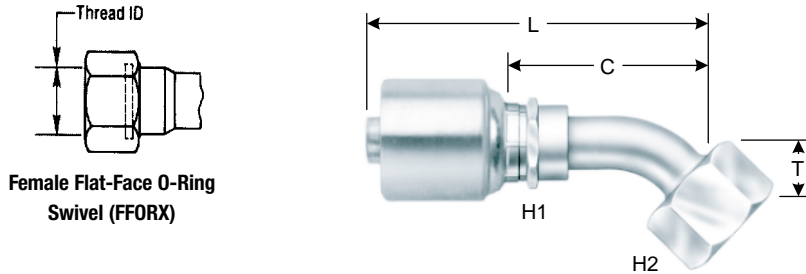

Female Flat-Face O-Ring Swivel (FFORX)

Descr	#		⊕		🌀	H1	H2	T		L		C	
			"	mm		"	"	"	mm	"	mm	"	mm
4G-4FFORX45	G25235-0404	7102-13265	1/4	6.4	9/16-18	1/2	11/16	0.41	10.4	2.56	65.0	1.54	39.0
4G-6FFORX45	G25235-0406	7102-13275	1/4	6.4	11/16-16	1/2	13/16	0.43	10.9	2.70	68.5	1.67	42.5
5G-6FFORX45	G25235-0506	7102-04025	5/16	7.9	11/16-16	5/8	13/16	0.43	10.9	2.73	69.3	1.63	41.3
6G-4FFORX45S	G25234-0604	7102-03985	3/8	9.5	9/16-18	5/8	11/16	0.39	10.0	2.60	66.1	1.50	38.1
6G-6FFORX45	G25235-0606	7102-13285	3/8	9.5	11/16-16	5/8	13/16	0.43	10.9	2.75	69.8	1.65	41.9
6G-8FFORX45	G25235-0608	7102-13295	3/8	9.5	13/16-16	5/8	15/16	0.59	15.0	3.07	78.0	1.97	50.1
8G-8FFORX45	G25235-0808	7102-20205	1/2	12.7	13/16-16	N/A	15/16	0.59	15.0	3.50	89.0	2.03	51.5
8G-10FFORX45	G25235-0810	7102-03315	1/2	12.7	1-14	13/16	1 1/8	0.65	16.5	3.52	89.5	2.05	52.1
8G-12FFORX45	G25235-0812	7102-03765	1/2	12.7	1 3/16-12	15/16	1 3/8	0.83	21.0	4.34	110.3	2.87	72.9
10G-10FFORX45	G25235-1010	7102-03325	5/8	15.8	1-14	15/16	1 1/8	0.65	16.5	3.50	89.0	2.03	51.6
10G-12FFORX45	G25235-1012	7102-03335	5/8	15.8	1 3/16-12	15/16	1 3/8	0.83	21.1	3.90	99.1	2.42	61.5
12G-10FFORX45	G25235-1210	7102-04165	3/4	19.0	1-14	1 1/16	1 1/8	0.65	16.5	4.00	101.6	1.99	50.6
12G-12FFORX45	G25235-1212	7102-03345	3/4	19.0	1 3/16-12	1 1/16	1 3/8	0.83	21.1	4.67	118.5	2.66	67.5
12G-16FFORX45	G25235-1216	7102-03355	3/4	19.0	1 7/16-12	1 3/16	1 5/8	0.94	23.9	5.24	133.0	3.23	82.0
16G-16FFORX45	G25235-1616	7102-03365	1	25.4	1 7/16-12	1 3/8	1 5/8	0.94	23.9	5.08	129.1	2.85	72.3
20G-20FFORX45	G25235-2020	7102-03375	1 1/4	31.7	1 11/16-12	1 3/4	1 7/8	1.00	25.4	5.83	148.0	3.50	89.0

EQUIPMENT

HOSE/CPLG. SELECTION

TECH. DATA

EXT. & VERY HIGH PRESS. HOSE

GS CPLGS.

PCM CPLGS.

PCS CPLGS.

HIGH & MED. PRESS. HOSE

MEGACRIMP® CPLGS.

PC CPLGS.

FIELD ATTACHABLE CPLGS.

AIR BRAKE HOSE & CPLGS.

MEGATECH™/C5 HOSE & CPLGS.

LOW PRESS. HOSE & CPLGS.

C14 HOSE & CPLGS.

POLARSEAL® HOSE & CPLGS.

PWR. STG. HOSE & CPLGS.

THERMO-PLASTIC HOSE & CPLGS.

ADAPTERS

QUICK DISCONNECT CPLGS.

ACCESSORIES & ASSORTMENTS

PART NUMBER INDEXES



# MegaCrimp® Couplings - G25 Series

## Female Flat-Face O-Ring Swivel – 90° Bent Tube

SAE J1453 O-Ring Face Seal.

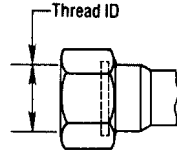

Female Flat-Face O-Ring Swivel (FFORX)

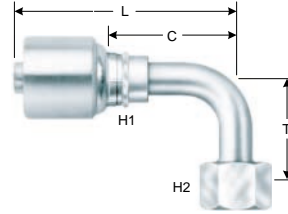

DESCR	#		⊕		🌀	H1	H2	T		L		C	
			"	mm		"	"	"	mm	"	mm	"	mm
4G-4FFORX90S	G25239-0404	7102-13385	1/4	6.4	9/16-18	1/2	11/16	0.82	20.8	2.38	60.4	1.35	34.4
4G-4FFORX90M	G25240-0404	7102-13395	1/4	6.4	9/16-18	1/2	11/16	1.26	32.0	2.17	55.2	1.15	29.2
4G-4FFORX90L	G25241-0404	7102-13405	1/4	6.4	9/16-18	1/2	11/16	1.80	45.7	2.17	55.2	1.15	29.2
4G-6FFORX90S	G25239-0406	7102-13415	1/4	6.4	11/16-16	1/2	13/16	0.90	22.9	2.50	63.4	1.47	37.3
4G-6FFORX90M	G25240-0406	7102-13375	1/4	6.4	11/16-16	1/2	13/16	1.51	38.4	2.49	63.2	1.46	37.2
4G-6FFORX90L	G25241-0406	7102-13435	1/4	6.4	11/16-16	1/2	13/16	2.13	54.1	2.30	58.5	1.28	32.5
4G-8FFORX90M	G25240-0408	7102-13445	1/4	6.4	13/16-16	5/8	15/16	2.51	63.8	2.60	66.0	1.57	40.0
5G-6FFORX90S	G25239-0506	7102-04035	5/16	7.9	11/16-16	5/8	13/16	0.90	22.9	2.84	72.1	1.74	44.1
6G-4FFORX90S	G25239-0604	7102-04105	3/8	9.5	9/16-18	5/8	11/16	0.82	20.8	2.42	61.4	1.32	33.5
6G-6FFORX90S	G25239-0606	7102-13455	3/8	9.5	11/16-16	5/8	13/16	0.90	22.9	2.55	64.7	1.44	36.7
6G-6FFORX90M	G25240-0606	7102-13465	3/8	9.5	11/16-16	5/8	13/16	1.51	38.4	2.55	64.7	1.45	36.8
6G-6FFORX90L	G25241-0606	7102-13475	3/8	9.5	11/16-16	5/8	13/16	2.13	54.1	2.48	62.9	1.38	35.0
6G-8FFORX90S	G25239-0608	7102-13485	3/8	9.5	13/16-16	5/8	15/16	1.15	29.2	2.87	73.0	1.77	45.0
6G-8FFORX90M	G25240-0608	7102-13495	3/8	9.5	13/16-16	5/8	15/16	1.62	41.2	2.70	68.5	1.59	40.5
6G-8FFORX90L	G25241-0608	7102-13505	3/8	9.5	13/16-16	5/8	15/16	2.51	63.8	2.72	69.0	1.61	41.0
8G-6FFORX90S	G25239-0806	7102-04125	1/2	12.7	11/16-16	13/16	13/16	0.90	22.9	2.98	75.7	1.50	38.2
8G-8FFORX90S	G25239-0808	7102-20215	1/2	12.7	13/16-16	N/A	15/16	1.14	29.0	3.30	83.9	1.83	46.5
8G-8FFORX90M	G25240-0808	7102-20225	1/2	12.7	13/16-16	N/A	15/16	1.61	41.0	3.30	83.9	1.83	46.5
8G-8FFORX90L	G25241-0808	7102-20235	1/2	12.7	13/16-16	N/A	15/16	2.52	64.0	3.30	83.9	1.83	46.5
8G-10FFORX90S	G25239-0810	7102-03545	1/2	12.7	1-14	13/16	1 1/8	1.27	32.3	3.30	84.0	1.83	46.5
8G-10FFORX90M	G25240-0810	7102-03555	1/2	12.7	1-14	13/16	1 1/8	1.85	47.0	3.06	77.7	1.59	40.4
8G-10FFORX90L	G25241-0810	7102-03565	1/2	12.7	1-14	13/16	1 1/8	2.76	70.1	3.07	77.9	1.59	40.4
8G-12FFORX90S	G25239-0812	7102-04135	1/2	12.7	1 3/16-12	15/16	1 3/8	1.88	46.6	4.06	103.1	2.58	65.6
10G-10FFORX90S	G25239-1010	7102-03575	5/8	15.8	1-14	15/16	1 1/8	1.27	32.3	3.28	83.4	1.81	45.9
10G-10FFORX90M	G25240-1010	7102-03585	5/8	15.8	1-14	15/16	1 1/8	1.85	47.0	3.06	77.6	1.58	40.2
10G-10FFORX90L	G25241-1010	7102-03595	5/8	15.8	1-14	15/16	1 1/8	2.76	70.1	3.05	77.5	1.57	40.0
10G-12FFORX90S	G25239-1012	7102-03605	5/8	15.8	1 3/16-12	15/16	1 3/8	1.88	47.8	3.80	96.6	2.33	59.1
12G-10FFORX90S	G25239-1210	7102-03745	3/4	19.0	1-14	1 1/16	1 1/8	1.26	32.0	4.13	105.0	2.13	54.0
12G-12FFORX90S	G25239-1212	7102-03615	3/4	19.0	1 3/16-12	1 1/16	1 3/8	1.88	47.8	4.29	109.0	2.28	58.0
12G-12FFORX90M	G25240-1212	7102-03625	3/4	19.0	1 3/16-12	1 1/16	1 3/8	2.28	57.9	4.20	106.8	2.20	55.8
12G-12FFORX90L	G25241-1212	7102-03635	3/4	19.0	1 3/16-12	1 1/16	1 3/8	3.78	96.0	4.02	102.0	2.01	51.0
12G-16FFORX90S	G25239-1216	7102-03645	3/4	19.0	1 7/16-12	1 3/16	1 5/8	2.21	56.1	4.67	118.5	2.66	67.5
16G-12FFORX90S	G25239-1612	7102-03755	1	25.4	1 3/16-12	1 3/8	1 3/8	1.89	48.0	4.83	122.8	2.61	66.2
16G-16FFORX90S	G25239-1616	7102-03655	1	25.4	1 7/16-12	1 3/8	1 5/8	2.21	56.1	5.11	129.9	2.88	73.1
16G-16FFORX90M	G25240-1616	7102-03665	1	25.4	1 7/16-12	1 3/8	1 5/8	2.78	70.6	4.53	115.0	2.29	58.2
16G-16FFORX90L	G25241-1616	7102-03675	1	25.4	1 7/16-12	1 3/8	1 5/8	4.50	114.3	4.53	115.0	2.29	58.2
20G-20FFORX90S	G25239-2020	7102-03685	1 1/4	31.7	1 11/16-12	1 3/4	1 7/8	2.51	63.8	5.51	140.0	3.19	81.0
20G-20FFORX90M	G25240-2020	7102-03695	1 1/4	31.7	1 11/16-12	1 3/4	1 7/8	3.09	78.5	5.31	135.0	2.99	76.0
20G-20FFORX90L	G25241-2020	7102-03705	1 1/4	31.7	1 11/16-12	1 3/4	1 7/8	5.09	129.3	5.31	135.0	2.99	76.0

## Code 61 O-Ring Flange

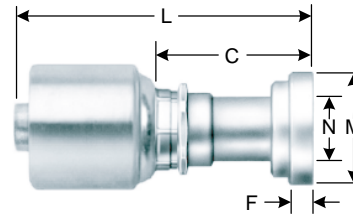

Descr	#		⊕		N	M		L		G		F	
			"	mm		"	"	mm	"	mm	"	mm	"
8G-8FL	G25300-0808	7100-03795	1/2	12.7	1/2	1.19	30.2	3.15	80.0	1.67	42.5	0.27	6.7
8G-10FLK <sup>†</sup>	G25300-0810	7100-03805	1/2	12.7	5/8	1.35	34.2	3.15	80.0	1.67	42.5	0.27	6.7
8G-12FL	G25300-0812	7100-03815	1/2	12.7	3/4	1.50	38.1	3.15	80.0	1.67	42.5	0.27	6.7
10G-10FLK <sup>†</sup>	G25300-1010	7100-03825	5/8	15.9	5/8	1.35	34.2	4.69	119.0	3.21	81.5	0.27	6.7
12G-12FL	G25300-1212	7100-03835	3/4	19.0	3/4	1.50	38.1	3.86	98.0	1.85	47.0	0.27	6.7
12G-16FL	G25300-1216	7100-03845	3/4	19.0	1	1.75	44.5	3.50	88.8	1.49	37.8	0.32	8.0
16G-16FL	G25300-1616	7100-03925	1	25.4	1	1.75	44.5	4.13	105.0	1.90	48.2	0.32	8.0
16G-20FL	G25300-1620	7100-03865	1	25.4	1 1/4	2.00	50.8	4.13	105.0	1.90	48.2	0.32	8.0
20G-20FL	G25300-2020	7100-03885	1 1/4	31.7	1 1/4	2.00	50.8	4.43	112.5	2.11	53.5	0.32	8.0
20G-24FL	G25300-2024	7100-03895	1 1/4	31.7	1 1/2	2.38	60.5	4.63	117.5	2.30	58.5	0.32	8.0

<sup>†</sup> Komatsu-style flange.

## Code 61 O-Ring Flange – 22½° Bent Tube

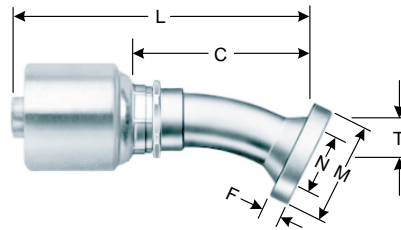

Descr	#		⊕		N	M		T		L		G		F	
			"	mm		"	"	mm	"	mm	"	mm	"	mm	"
12G-12FL22	G25302-1212	7100-03945	3/4	19.0	3/4	1.50	38.1	0.44	11.2	4.47	113.5	2.46	62.5	0.27	6.9
12G-16FL22	G25302-1216	7100-03955	3/4	19.0	1	1.75	44.5	0.55	14.0	4.76	121.0	2.76	70.0	0.32	8.0
16G-16FL22	G25302-1616	7100-03965	1	25.4	1	1.75	44.5	0.44	11.2	4.84	123.0	2.61	66.2	0.32	8.0
20G-20FL22	G25302-2020	7100-03985	1 1/4	31.7	1 1/4	2.00	50.8	0.50	12.7	5.18	131.5	2.85	72.5	0.32	8.0

## Code 61 O-Ring Flange – 30° Bent Tube

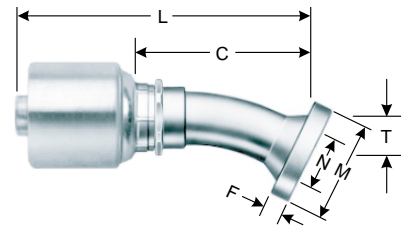

Descr	#		⊕		N	M		T		L		G		F	
			"	mm		"	"	mm	"	mm	"	mm	"	mm	"
12G-16FL30M	G25304-1216	7100-04045	3/4	19.0	1	1.75	44.5	0.75	19.0	4.88	124.0	2.87	73.0	0.32	8.0
16G-16FL30	G25304-1616	7100-04055	1	25.4	1	1.75	44.5	0.62	15.7	4.92	125.0	2.69	68.2	0.32	8.0

EQUIPMENT
HOSE/CPLG. SELECTION
TECH. DATA
EXT. & VERY HIGH PRESS. HOSE
GS CPLGS.
PCM CPLGS.
PCS CPLGS.
HIGH & MED. PRESS. HOSE
MEGACRIMP® CPLGS.
PC CPLGS.
FIELD ATTACHABLE CPLGS.
AIR BRAKE HOSE & CPLGS.
MEGATECH™/C5 HOSE & CPLGS.
LOW PRESS. HOSE & CPLGS.
C14 HOSE & CPLGS.
POLARSEAL® HOSE & CPLGS.
PWR. STG. HOSE & CPLGS.
THERMO-PLASTIC HOSE & CPLGS.
ADAPTERS
QUICK DISCONNECT CPLGS.
ACCESSORIES & ASSORTMENTS
PART NUMBER INDEXES



# MegaCrimp® Couplings - G25 Series

## Code 61 O-Ring Flange – 45° Bent Tube

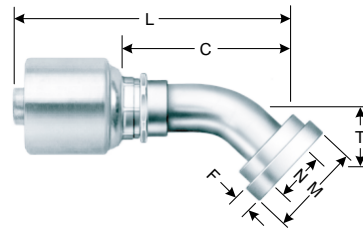

Descr	#		⊕		N	M		T		L		C		F	
			"	mm		"	"	mm	"	mm	"	mm	"	mm	"
8G-8FL45	G25307-0808	7100-04125	1/2	12.7	1/2	1.19	30.2	0.78	19.8	3.70	94.0	2.22	56.5	0.26	6.7
8G-12FL45	G25307-1012	7100-04145	1/2	12.7	3/4	1.50	38.1	0.78	19.8	3.70	94.0	2.22	56.5	0.27	6.9
MEGACRIMP® CPLGS.	10G-10FLK45 <sup>1</sup>	G25307-1010	5/8	15.9	5/8	1.35	34.1	1.02	26.0	4.19	106.5	2.72	69.0	0.27	6.9
12G-12FL45	G25307-1212	7100-04165	3/4	19.0	3/4	1.50	38.1	1.00	25.4	4.67	118.5	2.66	67.5	0.27	6.9
PC CPLGS.	12G-16FL45	G25307-1216	3/4	19.0	1	1.75	44.4	1.00	25.4	4.67	118.5	2.66	67.5	0.32	8.0
16G-16FL45	G25307-1616	7100-04185	1	25.4	1	1.75	44.4	1.06	26.9	5.11	129.7	2.87	72.9	0.32	8.0
FIELD ATTACHABLE CPLGS.	16G-20FL45	G25307-1620	1	25.4	1 1/4	2.00	50.8	1.06	26.9	5.10	129.5	2.86	72.7	0.32	8.0
20G-20FL45	G25307-2020	7100-04205	1 1/4	31.7	1 1/4	2.00	50.8	1.15	29.2	5.59	142.0	3.27	83.0	0.32	8.0

<sup>1</sup> Komatsu-style flange.

## Code 61 O-Ring Flange – 60° Bent Tube

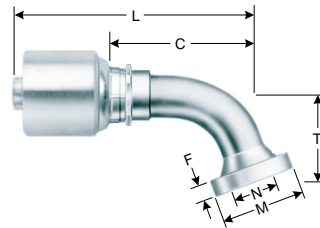

Descr	#		⊕		N	M		T		L		C		F	
			"	mm		"	"	mm	"	mm	"	mm	"	mm	"
POLARSEAL® HOSE & CPLGS.	12G-12FL60	G25309-1212	3/4	19.0	3/4	1.50	38.1	1.41	35.8	4.61	117.0	2.60	66.0	0.27	6.9
12G-16FL60	G25309-1216	7100-04275	3/4	19.0	1	1.75	44.5	1.73	44.0	4.80	122.0	2.80	71.0	0.32	8.0

## Code 61 O-Ring Flange – 67½° Bent Tube

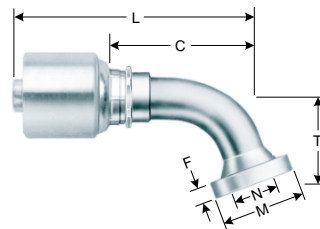

Descr	#		⊕		N	M		T		L		C		F	
			"	mm		"	"	mm	"	mm	"	mm	"	mm	"
12G-12FL67M	G25311-1212	7100-04355	3/4	19.0	3/4	1.50	38.1	1.65	42.0	4.65	118.0	2.64	67.0	0.27	6.9
20G-20FL67S	G25311-2020	7100-04335	1 1/4	31.7	1 1/4	2.00	50.8	2.01	51.0	5.92	150.4	3.60	91.4	0.32	8.0

EQUIPMENT  
HOSE/CPLG. SELECTION  
TECH. DATA  
EXT. & VERY HIGH PRESS. HOSE  
GS CPLGS.  
PCM CPLGS.  
PCS CPLGS.  
HIGH & MED. PRESS. HOSE  
MEGACRIMP® CPLGS.  
PC CPLGS.  
FIELD ATTACHABLE CPLGS.  
AIR BRAKE HOSE & CPLGS.  
MEGATECH™ C5 HOSE & CPLGS.  
LOW PRESS. HOSE & CPLGS.  
C14 HOSE & CPLGS.  
POLARSEAL® HOSE & CPLGS.  
PWR. STG. HOSE & CPLGS.  
THERMO-PLASTIC HOSE & CPLGS.  
ADAPTERS  
QUICK DISCONNECT CPLGS.  
ACCESSORIES & ASSORT-MENTS  
PART NUMBER INDEXES

## Code 61 O-Ring Flange – 90° Bent Tube

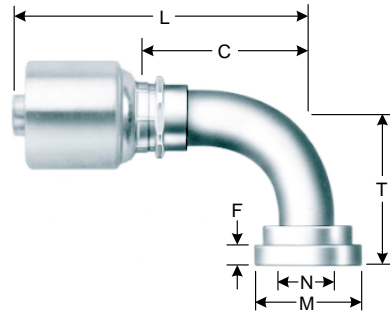

Descr	#		⊕		N	M		T		L		C		F	
			"	mm		"	"	mm	"	mm	"	mm	"	mm	"
8G-8FL90	G25315-0808	7100-04445	1/2	12.7	1/2	1.19	30.1	1.63	41.4	3.59	91.2	2.11	53.7	0.27	6.9
8G-12FL90	G25315-0812	7100-04465	1/2	12.7	3/4	1.50	38.1	1.63	41.4	3.60	91.5	2.13	54.0	0.27	6.9
10G-10FLK90	G25315-1010	7100-04475	5/8	15.9	5/8	1.35	34.1	2.17	55.0	3.90	99.0	2.42	61.5	0.27	6.9
10G-12FL90	G25315-1012	7100-04485	5/8	15.9	3/4	1.50	38.1	2.28	58.0	3.94	100.0	2.46	62.5	0.27	6.7
12G-12FL90	G25315-1212	7100-04495	3/4	19.0	3/4	1.50	38.1	2.13	54.1	4.40	111.7	2.39	60.7	0.27	6.7
12G-16FL90	G25315-1216	7100-04505	3/4	19.0	1	1.75	44.4	2.13	54.1	4.40	111.7	2.39	60.7	0.32	8.0
16G-16FL90	G25315-1616	7100-04515	1	25.4	1	1.75	44.4	2.38	60.5	5.04	128.1	2.81	71.3	0.32	8.0
16G-20FL90	G25315-1620	7100-04525	1	25.4	1 1/4	2.00	50.8	2.38	60.5	5.04	128.1	2.81	71.3	0.32	8.0
20G-20FL90	G25315-2020	7100-04535	1 1/4	31.7	1 1/4	2.00	50.8	2.62	66.5	5.41	137.5	3.09	78.5	0.32	8.0
20G-20FL90-102	G25316-2020	7100-04565	1 1/4	31.7	1 1/4	2.00	50.8	3.98	101.0	5.43	138.0	3.11	79.0	0.32	8.0
20G-24FL90	G25315-2024	7100-04545	1 1/4	31.7	1 1/2	2.38	60.5	2.62	66.5	5.67	144.0	3.35	85.0	0.32	8.0

## SAE Male Inverted Swivel

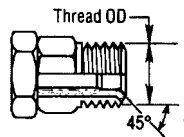

Male (MIX)

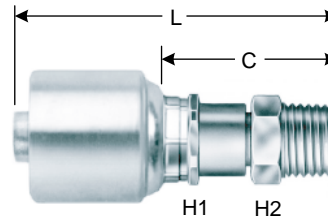

Descr	#		⊕		🌀	H1		H2		L		C	
			"	mm		"	"	"	mm	"	mm		
4G-4MIX	G25500-0404	7100-16225	1/4	6.4	7/16-24	1/2	7/16	2.52	63.9	1.49	37.9		
4G-5MIX	G25500-0405	7100-16235	1/4	6.4	1/2-20	1/2	1/2	2.52	63.9	1.49	37.9		
6G-5MIX	G25500-0605	7100-16245	3/8	9.5	1/2-20	5/8	1/2	2.56	64.9	1.46	37.0		
6G-6MIX	G25500-0606	7100-16255	3/8	9.5	5/8-18	5/8	5/8	2.75	69.9	1.65	42.0		
6G-7MIX	G25500-0607	7100-16265	3/8	9.5	11/16-18	5/8	11/16	2.76	70.0	1.66	42.1		
8G-6MIX	G25500-0806	7100-06275	1/2	12.7	5/8-18	13/16	5/8	3.13	79.5	1.65	42.0		
8G-8MIX	G25500-0808	7100-06285	1/2	12.7	3/4-18	13/16	3/4	3.30	83.8	1.82	46.3		

EQUIPMENT

HOSE/CPLG. SELECTION

TECH. DATA

EXT. & VERY HIGH PRESS. HOSE

GS CPLGS.

PCM CPLGS.

PCS CPLGS.

HIGH & MED. PRESS. HOSE

MEGACRIMP® CPLGS.

PC CPLGS.

FIELD ATTACHABLE CPLGS.

AIR BRAKE HOSE & CPLGS.

MEGATECH™/C5 HOSE & CPLGS.

LOW PRESS. HOSE & CPLGS.

C14 HOSE & CPLGS.

POLARSEAL® HOSE & CPLGS.

PWR. STG. HOSE & CPLGS.

THERMO-PLASTIC HOSE & CPLGS.

ADAPTERS

QUICK DISCONNECT CPLGS.

ACCESSORIES & ASSORTMENTS

PART NUMBER INDEXES



# MegaCrimp® Couplings - G25 Series

## SAE Male Inverted Swivel – 45° Bent Tube

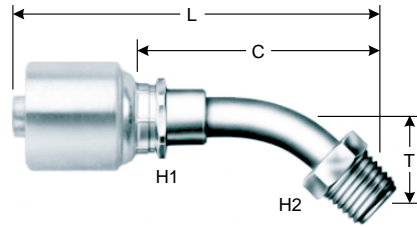
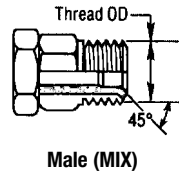

Descr	#		⊕		🌀	H1	H2	T		L		C	
			"	mm		"	"	"	mm	"	mm	"	mm
6G-4MIX45	G25502-0604	7100-16305	3/8	9.5	7/16-24	5/8	7/16	1.00	25.4	3.17	80.5	2.07	52.6
6G-5MIX45	G25502-0605	7100-16315	3/8	9.5	1/2-20	5/8	1/2	1.00	25.4	3.13	79.5	2.03	51.6
6G-6MIX45	G25502-0606	7100-16325	3/8	9.5	5/8-18	5/8	5/8	1.00	25.4	3.32	84.3	2.22	56.4
6G-7MIX45	G25502-0607	7100-16335	3/8	9.5	11/16-18	5/8	11/16	1.00	25.4	3.39	86.0	2.29	58.1
8G-8MIX45	G25502-0808	7100-16345	1/2	12.7	3/4-18	13/16	3/4	1.14	29.0	4.17	106.0	2.70	68.5

## SAE Male Inverted Swivel – 90° Bent Tube

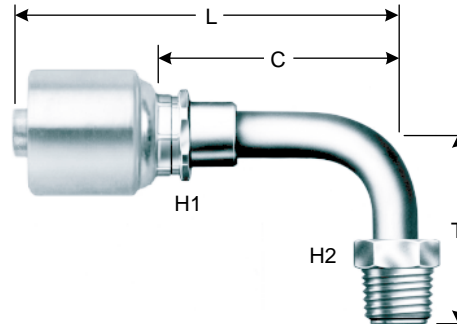
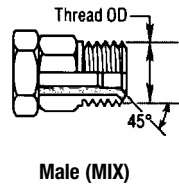

Descr	#		⊕		🌀	H1	H2	T		L		C	
			"	mm		"	"	"	mm	"	mm	"	mm
4G-4MIX90	G25504-0404	7100-16355	1/4	6.4	7/16-24	1/2	7/16	1.38	35.1	2.33	59.2	1.31	33.2
4G-5MIX90	G25504-0405	7100-16365	1/4	6.4	1/2-20	1/2	1/2	1.38	35.1	2.46	62.5	1.44	36.5
5G-6MIX90-035	G25504-0506	7100-16385	5/16	7.9	5/8-18	5/8	5/8	1.38	35.1	2.78	70.5	1.67	42.5
6G-4MIX90	G25504-0604	7100-16395	3/8	9.5	7/16-24	5/8	7/16	1.38	35.1	2.44	62.0	1.34	34.1
6G-5MIX90	G25504-0605	7100-16405	3/8	9.5	1/2-20	5/8	1/2	1.38	35.1	2.50	63.5	1.40	35.6
6G-6MIX90	G25504-0606	7100-16415	3/8	9.5	5/8-18	5/8	5/8	1.38	35.1	2.80	71.0	1.70	43.1
6G-7MIX90	G25504-0607	7100-16425	3/8	9.5	11/16-18	5/8	11/16	1.38	35.1	2.80	71.0	1.70	43.1
8G-8MIX90	G25504-0808	7100-06435	1/2	12.7	3/4-18	13/16	3/4	1.64	41.7	3.29	83.5	1.81	46.0



## SAE Male Flareless Assembly

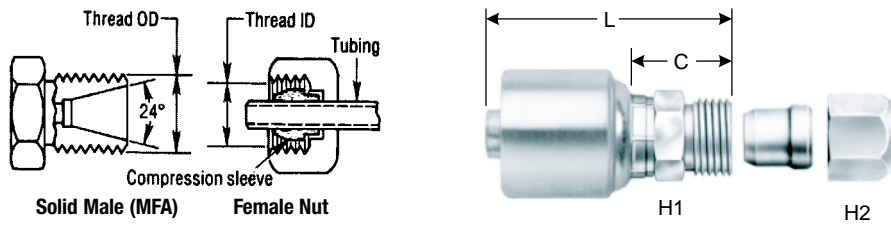

Descr	#		⊕		🌀	A1	H1	H2	L		C	
			"	mm					"	mm	"	mm
4G-4MFA	G25510-0404	7100-16445	1/4	6.4	7/16-20	1/4	9/16	1/2	1.95	49.5	0.93	23.5
4G-5MFA	G25510-0405	7100-16455	1/4	6.4	1/2-20	5/16	5/8	1/2	1.97	50.0	0.94	24.0
6G-4MFA	G25510-0604	7100-16465	3/8	9.5	7/16-20	1/4	7/8	5/8	2.05	52.0	0.95	24.1
6G-5MFA	G25510-0605	7100-16475	3/8	9.5	1/2-20	5/16	5/8	5/8	2.16	55.0	1.07	27.1
6G-6MFA	G25510-0606	7100-16485	3/8	9.5	5/8-18	3/8	11/16	5/8	2.07	52.5	0.97	24.6
6G-8MFA	G25510-0608	7100-16495	3/8	9.5	3/4-16	1/2	7/8	3/4	2.20	56.0	1.11	28.1
8G-8MFA	G25510-0808	7100-06505	1/2	12.7	3/4-16	1/2	7/8	13/16	2.58	65.5	1.10	28.0
8G-10MFA	G25510-0810	7100-06515	1/2	12.7	7/8-14	5/8	1	7/8	2.64	67.0	1.16	29.5
12G-12MFA	G25510-1212	7100-06525	3/4	19.0	1 1/16-12	3/4	1 1/4	1 1/16	3.41	86.5	1.40	35.5
16G-16MFA	G25510-1616	7100-06535	1	25.4	1 5/16-12	1	1 1/2	1 3/8	3.94	100.0	1.70	43.2

## North American Stand Pipe

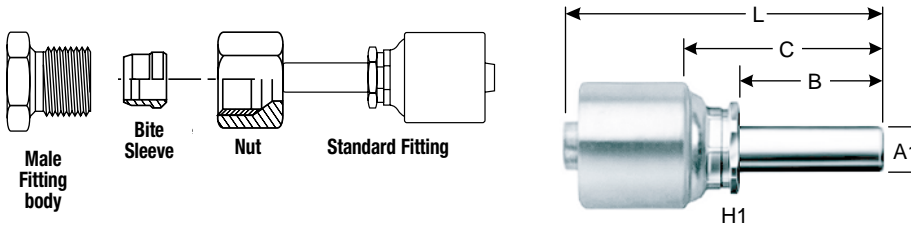

Descr	#		⊕		A1	H1	L	C		B		
			"	mm				"	mm	"	mm	
4G-4NASP	G25520-0404	7100-08305	1/4	6.4	1/4	1/2	2.26	57.5	1.24	31.5	0.88	22.4
6G-6NASP	G25520-0606	7100-08335	3/8	9.5	3/8	5/8	2.34	59.5	1.24	31.6	0.88	22.4
8G-8NASP	G25520-0808	7100-08365	1/2	12.7	1/2	13/16	2.87	73.0	1.40	35.5	1.00	25.4
12G-12NASP	G25520-1212	7100-08435	3/4	19.0	3/4	1 1/16	3.58	91.0	1.57	40.0	1.16	29.5
16G-16NASP	G25520-1616	7100-08465	1	25.4	1	1 7/16	3.86	98.0	1.62	41.2	1.12	28.4

EQUIPMENT
HOSE/CPLG. SELECTION
TECH. DATA
EXT. & VERY HIGH PRESS. HOSE
GS CPLGS.
PCM CPLGS.
PCS CPLGS.
HIGH & MED. PRESS. HOSE
MEGACRIMP® CPLGS.
PC CPLGS.
FIELD ATTACHABLE CPLGS.
AIR BRAKE HOSE & CPLGS.
MEGATECH™/C5 HOSE & CPLGS.
LOW PRESS. HOSE & CPLGS.
C14 HOSE & CPLGS.
POLARSEAL® HOSE & CPLGS.
PWR. STG. HOSE & CPLGS.
THERMO-PLASTIC HOSE & CPLGS.
ADAPTERS
QUICK DISCONNECT CPLGS.
ACCESSORIES & ASSORTMENTS
PART NUMBER INDEXES



# MegaCrimp® Couplings - G25 Series

## Female Flareless Sleeve

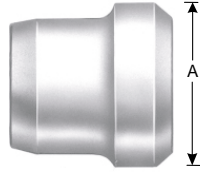

## Female Flareless Nut



Descr	#			A
				"
4FFS	87380	G60051-0004	7334-40555	1/4
5FFS	87381	G60051-0005	7334-40565	5/16
6FFS	87382	G60051-0006	7334-40575	3/8
8FFS	87383	G60051-0008	7334-40435	1/2
10FFS	87384	G60051-0010	7334-40585	5/8
12FFS	87385	G60051-0012	7334-40595	3/4
16FFS	87386	G60051-0016	7334-40605	1

Descr	#			I/O	Spring	H1
				"		"
4FFN	87370	G60050-0004	7334-40495	1/4	7/16-20	9/16
5FFN	87371	G60050-0005	7334-40505	5/16	1/2-20	5/8
6FFN	87372	G60050-0006	7334-40515	3/8	5/8-18	11/16
8FFN	87373	G60050-0008	7334-40425	1/2	3/4-16	7/8
10FFN	87374	G60050-0010	7334-40525	5/8	7/8-14	1
12FFN	87375	G60050-0012	7334-40535	3/4	1 1/16-12	1 1/4
16FFN	87376	G60050-0016	7334-40545	1	1 5/16-12	1 1/2

## Female Air Brake Swivel

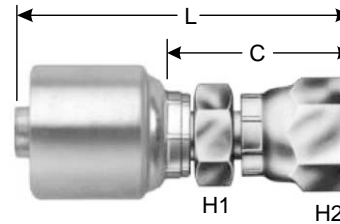

Descr	#		I/O		Spring	H1	H2	L		C	
			"	mm		"	"	"	mm	"	mm
6G-6FABX	G25540-0606	7100-13095	3/8	9.5	3/4-20	3/4	7/8	2.41	61.2	1.31	33.3
8G-6FABX	G25540-0806	7100-13105	1/2	12.7	3/4-20	13/16	7/8	2.48	63.0	1.00	25.5

## Female Grease

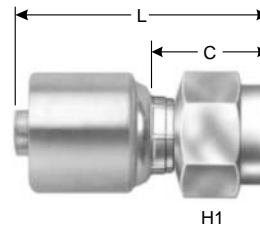

Descr	#		I/O		Spring	H1	L		C	
			"	mm		"	"	mm	"	mm
4G-8FG	G25561-0408	7100-09605	1/4	6.4	1/2-27	11/16	1.87	47.5	0.85	21.5
6G-8FG	G25561-0608	7100-09615	3/8	9.5	1/2-27	11/16	1.93	49.1	0.83	21.2

## Female Parker Triple Thread Flare

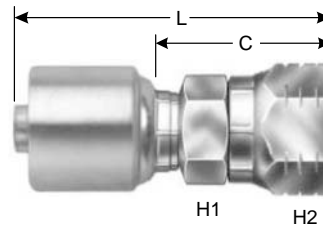

Descr	#		⊕		🌀	H1	H2	L		C	
			"	mm		"	"	"	mm	"	mm
16G-16FZX	G25562-1616	7100-00015	1	25.4	1 5/16-14	1 3/8	1 1/2	3.98	101.0	1.74	44.3

## Pressure Wash Swivel (Karcher)

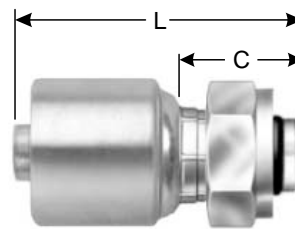

Descr	#		⊕		🌀	L		C	
			"	mm		"	mm	"	mm
4G-6PWX	G25563-0406	7100-02905	1/4	6.4	M22X1.5	2.52	64.0	1.50	38.0
6G-6PWX	G25563-0606	7100-02915	3/8	9.5	M22X1.5	2.60	66.0	1.50	38.1

## Banjo

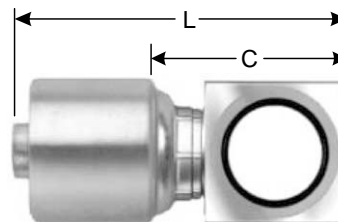

Descr	#		⊕		L		C	
			"	mm	"	mm	"	mm
6G-6BJ	G25564-0606	7100-02945	3/8	9.5	2.28	57.8	0.74	18.8

EQUIPMENT

HOSE/CPLG. SELECTION

TECH. DATA

EXT. &amp; VERY HIGH PRESS. HOSE

GS CPLGS.

PCM CPLGS.

PCS CPLGS.

HIGH &amp; MED. PRESS. HOSE

MEGACRIMP® CPLGS.

PC CPLGS.

FIELD ATTACHABLE CPLGS.

AIR BRAKE HOSE &amp; CPLGS.

MEGATECH™/C5 HOSE &amp; CPLGS.

LOW PRESS. HOSE &amp; CPLGS.

C14 HOSE &amp; CPLGS.

POLARSEAL® HOSE &amp; CPLGS.

PWR. STG. HOSE &amp; CPLGS.

THERMO-PLASTIC HOSE &amp; CPLGS.

ADAPTERS

QUICK DISCONNECT CPLGS.

ACCESSORIES &amp; ASSORTMENTS

PART NUMBER INDEXES



# MegaCrimp® Couplings - G25 Series

## Male DIN 24° Cone – Light Series

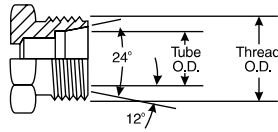

Male 24° Cone, DIN 2353

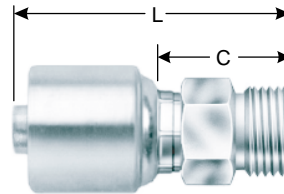

H1

Descr	#		⊕		🌀	H1	L		C	
			"	mm		mm	"	mm	"	mm
4G-6MDL	G25615-0406	7100-92685	1/4	6.4	M12X1.5	14	0.78	19.8	1.69	42.9
4G-8MDL	G25615-0408	7100-14835	1/4	6.4	M14X1.5	17	0.94	24.0	1.97	50.0
4G-10MDL	G25615-0410	7100-14845	1/4	6.4	M16X1.5	17	0.98	25.0	2.01	51.0
6G-10MDL	G25615-0610	7100-14865	3/8	9.5	M16X1.5	17	0.97	24.6	2.07	52.5
6G-12MDL	G25615-0612	7100-14875	3/8	9.5	M18X1.5	19	0.97	24.6	2.07	52.5
8G-15MDL	G25615-0815	7100-04885	1/2	12.7	M22X1.5	24	1.08	27.5	2.56	65.0
10G-18MDL	G25615-1018	7100-04895	5/8	15.8	M26X1.5	27	1.08	27.5	2.56	65.0
12G-22MDL	G25615-1222	7100-04905	3/4	19.0	M30X2.0	32	1.26	32.0	3.27	83.0

## Female DIN 24° Cone Swivel – Light Series with O-Ring

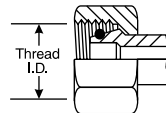

Female 24° Cone with O-Ring

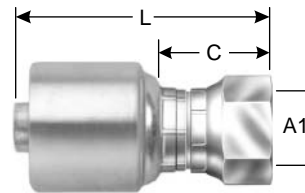

H2

Descr	#		⊕		🌀	H2	L		C		A1
			"	mm		mm	"	mm	"	mm	mm
4G-6FDLORX	G25645-0406	7100-92135	1/4	6.4	M12X1.5	14	1.92	48.7	1.01	25.8	6
4G-8FDLORX	G25645-0408	7100-91995	1/4	6.4	M14X1.5	17	2.02	51.3	1.12	28.4	8
4G-10FDLORX	G25645-0410	7100-92145	1/4	6.4	M16X1.5	19	2.17	55.2	1.15	29.3	10
4G-12FDLORX	G25645-0412	7100-92865	1/4	6.4	M18X1.5	22	2.07	52.6	1.17	29.7	12
5G-10FDLORX	G25645-0510	7100-92015	5/16	7.9	M16X1.5	19	2.12	53.9	1.17	29.7	10
5G-12FDLORX	G25645-0512	7100-92035	5/16	7.9	M18X1.5	22	2.13	54.1	1.18	29.9	12
6G-10FDLORX	G25645-0610	7100-92175	3/8	9.5	M16X1.5	19	2.06	52.3	1.15	29.2	10
6G-12FDLORX	G25645-0612	7100-92055	3/8	9.5	M18X1.5	22	2.09	53.0	1.18	29.9	12
8G-15FDLORX	G25645-0815	7100-92075	1/2	12.7	M22X1.5	27	2.43	61.8	1.16	29.3	15
10G-18FDLORX	G25645-1018	7100-92095	5/8	15.8	M26X1.5	32	2.36	60.0	1.19	30.3	18
12G-18FDLORX	G25645-1218	7100-92825	3/4	19.0	M30X2.0	32	2.70	68.5	1.18	30.0	18
12G-22FDLORX	G25645-1222	7100-92115	3/4	19.0	M30X2.0	36	2.79	70.8	1.27	32.3	22
16G-28FDLORX	G25645-1628	7100-92205	1	25.4	M36X2.0	41	3.21	81.6	1.45	36.7	28
20G-35FDLORX	G25645-2035	7100-92215	1 1/4	31.7	M45X2.0	36	3.56	90.4	1.74	44.1	35

## Female DIN 24° Cone Swivel Light Series with O-Ring – 45° Bent Tube

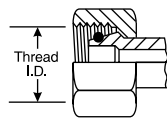

Female 24° Cone  
with O-Ring

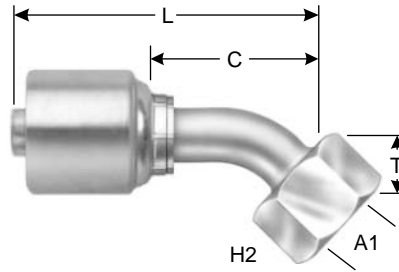

Descr	#		⌀		M	H2	T		L		C		A1
			"	mm			mm	"	mm	"	mm	"	
4G-8FDLORX45	G25650-0408	7100-91855	1/4	6.4	M14X1.5	17	0.64	16.2	2.34	59.5	1.44	36.5	8
4G-10FDLORX45	G25650-0410	7100-92265	1/4	6.4	M16X1.5	19	0.70	17.9	2.41	61.3	1.51	38.3	10
6G-10FDLORX45	G25650-0610	7100-92295	3/8	9.5	M16X1.5	19	0.73	18.6	2.50	63.6	1.59	40.5	10
6G-12FDLORX45	G25650-0612	7100-91875	3/8	9.5	M18X1.5	22	0.74	18.9	2.52	64.0	1.61	40.9	12
6G-15FDLORX45	G25650-0615	7100-92315	3/8	9.5	M22X1.5	27	0.89	22.5	2.66	67.5	1.75	44.4	15
8G-15FDLORX45	G25650-0815	7100-91935	1/2	12.7	M22X1.5	27	0.79	20.2	3.13	79.6	1.85	47.1	15
10G-18FDLORX45	G25650-1018	7100-91955	5/8	15.8	M26X1.5	32	0.98	24.8	3.37	85.7	2.21	56.0	18
12G-22FDLORX45	G25650-1222	7100-91975	3/4	19.0	M30X2.0	36	1.17	29.8	4.12	104.6	2.60	66.1	22
16G-28FDLORX45	G25650-1628	7100-92325	1	25.4	M36X2.0	41	1.21	30.9	4.87	123.7	3.10	78.8	28

## Female DIN 24° Cone Swivel Light Series with O-Ring – 90° Bent Tube

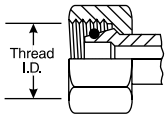

Female 24° Cone  
with O-Ring

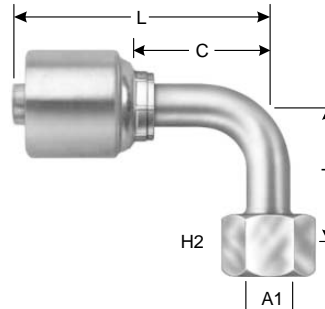

Descr	#		⌀		M	H2	T		L		C		A1
			"	mm			mm	"	mm	"	mm	"	
4G-6FDLORX90	G25655-0406	7100-92375	1/4	6.4	M12X1.5	14	1.38	35.0	2.14	54.5	1.24	31.5	6
4G-8FDLORX90	G25655-0408	7100-91685	1/4	6.4	M14X1.5	17	1.38	35.0	2.14	54.5	1.24	31.5	8
4G-10FDLORX90	G25655-0410	7100-92385	1/4	6.4	M16X1.5	19	1.44	36.5	2.14	54.4	1.24	31.5	10
5G-10FDLORX90	G25655-0510	7100-91725	5/16	9.5	M16X1.5	19	1.44	36.5	2.31	58.6	1.35	34.4	10
6G-10FDLORX90	G25655-0610	7100-92415	3/8	9.5	M16X1.5	19	1.44	36.5	2.18	55.3	1.27	32.2	10
6G-12FDLORX90	G25655-0612	7100-91705	3/8	9.5	M18X1.5	22	1.46	37.0	2.18	55.3	1.27	32.2	12
8G-15FDLORX90	G25655-0815	7100-91765	1/2	12.7	M22X1.5	27	1.65	42.0	2.87	72.9	1.59	40.4	15
10G-18FDLORX90	G25655-1018	7100-91785	5/8	15.8	M26X1.5	32	2.03	51.5	3.04	77.3	1.87	47.6	18
12G-22FDLORX90	G25655-1222	7100-91805	3/4	19.0	M30X2.0	36	2.44	62.0	3.73	94.8	2.22	56.3	22
16G-28FDLORX90	G25655-1628	7100-92445	1	25.4	M36X2.0	41	2.76	70.0	4.69	119.2	2.93	74.3	28
20G-35FDLORX90	G25655-2035	7100-92455	1 1/4	31.7	M45X2.0	36	3.15	80.0	5.07	128.8	3.26	82.8	35

EQUIPMENT
HOSE/CPLG. SELECTION
TECH. DATA
EXT. & VERY HIGH PRESS. HOSE
GS CPLGS.
PCM CPLGS.
PCS CPLGS.
HIGH & MED. PRESS. HOSE
MEGACRIMP® CPLGS.
PC CPLGS.
FIELD ATTACHABLE CPLGS.
AIR BRAKE HOSE & CPLGS.
MEGATECH™/C5 HOSE & CPLGS.
LOW PRESS. HOSE & CPLGS.
C14 HOSE & CPLGS.
POLARSEAL® HOSE & CPLGS.
PWR. STG. HOSE & CPLGS.
THERMO-PLASTIC HOSE & CPLGS.
ADAPTERS
QUICK DISCONNECT CPLGS.
ACCESSORIES & ASSORTMENTS
PART NUMBER INDEXES



# MegaCrimp® Couplings - G25 Series

## Female French GAZ Swivel

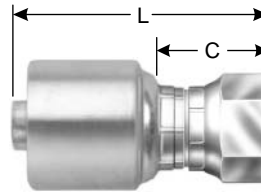

H2

Descr	#		⌀		M	L		C	
			"	mm		"	mm	"	mm
8G-17FFGX	G25690-0817	7100-93555	1/2	12.7	M24X1.5	2.50	63.4	1.02	25.9

## Male DIN 24° Cone - Heavy Series

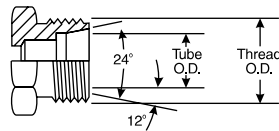

Male 24° Cone, DIN 2353

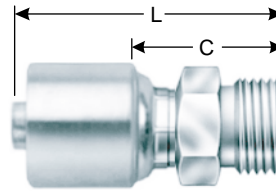

H1

Descr	#		⌀		M	H1	L		C	
			mm	"		mm	"	mm	"	
4G-8MDH	G25715-0408	7100-15315	1/4	6.4	M16X1.5	17	2.09	53.0	1.06	27.0
4G-10MDH	G25715-0410	7100-15325	1/4	6.4	M18X1.5	19	2.07	52.5	1.04	26.5
6G-10MDH	G25715-0610	7100-15345	3/8	9.5	M18X1.5	19	2.07	52.5	0.97	24.6
6G-12MDH	G25715-0612	7100-15355	3/8	9.5	M20X1.5	24	2.26	57.5	1.17	29.6
6G-14MDH	G25715-0614	7100-15365	3/8	9.5	M22X1.5	24	2.34	59.5	1.24	31.6
8G-12MDH	G25715-0812	7100-94815	1/2	12.7	M18X1.5	24	2.42	61.5	1.14	29.0
8G-16MDH	G25715-0816	7100-05375	1/2	12.7	M24X1.5	27	2.72	69.0	1.24	31.5
10G-20MDH	G25715-1020	7100-05385	5/8	15.8	M30X2.0	32	2.89	73.5	1.42	36.0

- EQUIPMENT
- HOSE/CPLG. SELECTION
- TECH. DATA
- EXT. & VERY HIGH PRESS. HOSE
- GS CPLGS.
- PCM CPLGS.
- PCS CPLGS.
- HIGH & MED. PRESS. HOSE
- MEGACRIMP® CPLGS.
- PC CPLGS.
- FIELD ATTACHABLE CPLGS.
- AIR BRAKE HOSE & CPLGS.
- MEGATECH™ C5 HOSE & CPLGS.
- LOW PRESS. HOSE & CPLGS.
- C14 HOSE & CPLGS.
- POLARSEAL® HOSE & CPLGS.
- PWR. STG. HOSE & CPLGS.
- THERMO-PLASTIC HOSE & CPLGS.
- ADAPTERS
- QUICK DISCONNECT CPLGS.
- ACCESSORIES & ASSORTMENTS
- PART NUMBER INDEXES

## Female DIN 24° Cone Swivel – Heavy Series with O-Ring

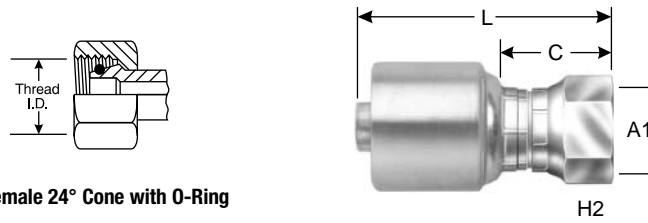

Female 24° Cone with O-Ring

Descr	#		⊖		🌀	H2	L		C		A1
			"	Mm		mm	"	mm	"	mm	mm
4G-8FDHORX	G25720-0408	7100-92005	1/4	6.4	M16X1.5	19	2.02	51.3	1.12	28.4	8
4G-10FDHORX	G25720-0410	7100-92155	1/4	6.4	M18X1.5	22	2.06	52.2	1.15	29.3	10
5G-12FDHORX	G25720-0512	7100-92045	5/16	7.9	M20X1.5	24	2.28	58.0	1.18	30.0	12
5G-14FDHORX	G25720-0514	7100-94835	5/16	7.9	M22X1.5	27	2.11	53.6	1.18	30.0	14
6G-10FDHORX	G25720-0610	7100-92185	3/8	9.5	M18X1.5	22	2.06	52.3	1.15	29.2	10
6G-12FDHORX	G25720-0612	7100-92065	3/8	9.5	M20X1.5	24	2.09	53.0	1.18	29.9	12
6G-14FDHORX	G25720-0614	7100-93305	3/8	9.5	M22X1.5	27	2.19	55.6	1.28	32.5	14
8G-12FDHORX	G25720-0812	7100-93335	1/2	12.7	M20X1.5	24	2.76	70.2	1.29	32.7	12
8G-14FDHORX	G25720-0814	7100-94795	1/2	12.7	M22X1.5	27	2.56	65.0	1.28	32.5	14
8G-16FDHORX	G25720-0816	7100-92085	1/2	12.7	M24X1.5	30	2.60	66.1	1.32	33.6	16
10G-20FDHORX	G25720-1020	7100-92105	5/8	15.8	M30X2.0	36	2.67	67.9	1.51	38.2	20
12G-20FDHORX	G25720-1220	7100-92855	3/4	19.0	M30X2.0	36	2.99	76.0	1.48	37.5	20
12G-25FDHORX	G25720-1225	7100-92125	3/4	19.0	M36X2.0	46	3.19	81.1	1.68	42.6	25
16G-25FDHORX	G25720-1625	7100-93215	1	25.4	M42X2.0	46	4.04	102.5	1.80	45.7	25
16G-30FDHORX	G25720-1630	7100-92235	1	25.4	M42X2.0	50	3.70	94.1	1.94	49.2	30

## Female DIN 24° Cone Swivel Heavy Series with O-Ring – 45° Bent Tube

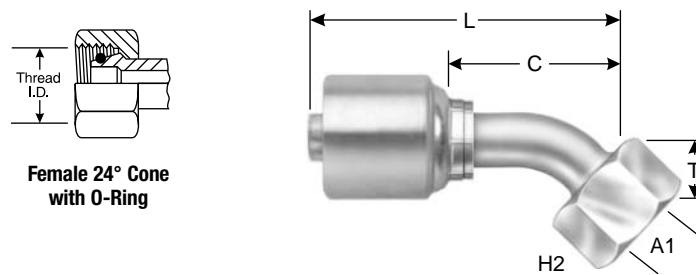

Female 24° Cone with O-Ring

Descr	#		⊖		🌀	H2	T		L		C		A1
			"	mm		mm	"	mm	"	mm	"	mm	mm
4G-8FDHORX45	G25725-0408	7100-91865	1/4	10.4	M16X1.5	19	0.64	16.2	2.34	59.5	1.44	36.5	8
6G-12FDHORX45	G25725-0612	7100-91885	3/8	9.5	M20X1.5	24	0.74	18.9	2.52	64.0	1.61	40.9	12
8G-14FDHORX45	G25725-0814	7100-94855	1/2	12.7	M22X1.5	27	1.11	28.3	3.40	86.4	2.13	54.0	14
8G-16FDHORX45	G25725-0816	7100-91945	1/2	12.7	M24X1.5	30	0.85	21.6	3.19	81.0	1.91	48.5	16
10G-20FDHORX45	G25725-1020	7100-91965	5/8	15.8	M30X2.0	36	0.98	24.9	3.36	85.4	2.19	55.7	20
12G-25FDHORX45	G25725-1225	7100-91985	3/4	19.0	M36X2.0	46	1.23	31.2	4.17	106.0	2.66	67.6	25

EQUIPMENT
HOSE/CPLG. SELECTION
TECH. DATA
EXT. & VERY HIGH PRESS. HOSE
GS CPLGS.
PCM CPLGS.
PCS CPLGS.
HIGH & MED. PRESS. HOSE
MEGACRIMP® CPLGS.
PC CPLGS.
FIELD ATTACHABLE CPLGS.
AIR BRAKE HOSE & CPLGS.
MEGATECH™/C5 HOSE & CPLGS.
LOW PRESS. HOSE & CPLGS.
C14 HOSE & CPLGS.
POLARSEAL® HOSE & CPLGS.
PWR. STG. HOSE & CPLGS.
THERMO-PLASTIC HOSE & CPLGS.
ADAPTERS
QUICK DISCONNECT CPLGS.
ACCESSORIES & ASSORTMENTS
PART NUMBER INDEXES



# MegaCrimp® Couplings - G25 Series

## Female DIN 24° Cone Swivel Heavy Series with O-Ring – 90° Bent Tube

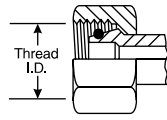

Female 24° Cone with O-Ring

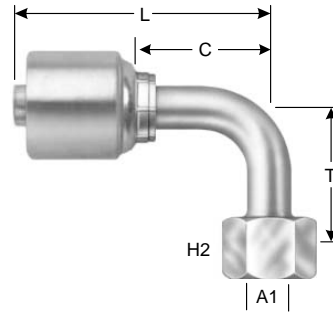

Descr	#		⊖		Spring	H2	T		L		C		A1
			"	mm			"	mm	"	mm	"	mm	
4G-8FDHORX90	G25730-0408	7100-91695	1/4	6.4	M16X1.5	19	1.38	35.0	2.14	54.5	1.24	31.5	8
4G-10FDHORX90	G25730-0410	7100-92395	1/4	6.4	M18X1.5	22	1.44	36.5	2.15	54.5	1.24	31.5	10
5G-12FDHORX90	G25730-0512	7100-91755	5/16	7.9	M20X1.5	24	1.46	37.0	2.32	59.0	1.22	31.0	12
5G-14FDHORX90	G25730-0514	7100-94845	5/16	7.9	M22X1.5	24	1.57	40.0	2.15	54.6	1.22	31.0	14
6G-10FDHORX90	G25730-0610	7100-92425	3/8	9.5	M18X1.5	22	1.44	36.5	2.18	55.3	1.27	32.2	10
6G-12FDHORX90	G25730-0612	7100-91715	3/8	9.5	M20X1.5	24	1.46	37.0	2.18	55.3	1.27	32.2	12
6G-14FDHORX90	G25730-0614	7100-92465	3/8	9.5	M22X1.5	27	1.57	40.0	2.18	55.3	1.27	32.2	14
8G-16FDHORX90	G25730-0816	7100-91775	1/2	12.7	M24X1.5	30	1.73	44.0	2.87	72.9	1.59	40.4	16
10G-20FDHORX90	G25730-1020	7100-91795	5/8	15.8	M30X2.0	36	2.01	51.0	3.00	76.3	1.83	46.6	20
10G-25FDHORX90	G25730-1025	7100-94825	5/8	15.8	M36X2.0	46	2.52	64.0	3.00	76.3	1.83	46.6	25
12G-20FDHORX90	G25730-1220	7100-93035	3/4	19.0	M30X2.0	36	2.01	51.0	3.46	87.8	1.94	49.3	20
12G-25FDHORX90	G25730-1225	7100-91815	3/4	19.0	M36X2.0	46	2.52	64.0	3.73	94.8	2.22	56.3	25

## Metric Light Stand Pipe

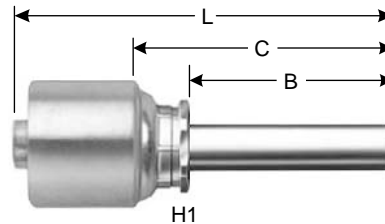
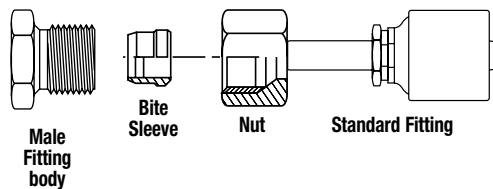

Descr	#		⊖		A1	H1	L		C		B	
			"	mm			mm	"	"	mm	"	mm
4G-6MLSP	G25750-0406	7100-08505	1/4	6.4	6	1/2	2.24	57.0	1.22	31.0	0.87	22.0
4G-8MLSP	G25750-0408	7100-08515	1/4	6.4	8	1/2	2.24	57.0	1.22	31.0	0.87	22.0
6G-10MLSP	G25750-0610	7100-08565	3/8	9.5	10	5/8	2.34	59.5	1.24	31.6	0.91	23.0
6G-12MLSP	G25750-0612	7100-08575	3/8	9.5	12	5/8	2.34	59.5	1.24	31.6	0.91	23.0
8G-15MLSP	G25750-0815	7100-08605	1/2	12.7	15	13/16	2.81	71.5	1.34	34.0	0.98	25.0
12G-18MLSP	G25750-1218	7100-08655	3/4	19.0	18	1 1/16	3.44	87.5	1.44	36.5	1.02	26.0
12G-22MLSP	G25750-1222	7100-08665	3/4	19.0	22	1 1/16	3.50	89.0	1.50	38.0	1.10	28.0
16G-28MLSP	G25750-1628	7100-08695	1	25.4	28	1 7/16	3.90	99.0	1.66	42.2	1.18	30.0



## Metric Bite Sleeve



Descr	#			∅
				mm
6BS	83185	G64787-0006	7253-26815	6
8BS	83186	G64787-0008	7253-26815	6
10BS	83187	G64787-0010	7253-26815	6
12BS	83188	G64787-0012	7253-26815	6
14BS	83199	G64787-0014	7253-26815	6
15BS	83189	G64787-0015	7253-26815	6
16BS	83200	G64787-0016	7253-26815	6
18BS	83190	G64787-0018	7253-26815	6
20BS	83201	G64787-0020	7253-26815	6
22BS	83191	G64787-0022	7253-26815	6
25BS	83202	G64787-0025	7253-26815	6
28BS	83192	G64787-0028	7253-26815	6
30BS	83203	G64787-0030	7253-26815	6
35BS	83193	G64787-0035	7253-26815	6
38BS	83204	G64787-0038	7253-26815	6
42BS	83194	G64787-0042	7253-26815	6

## Metric Bite Nut



Descr	#				∅
					mm
6MNL	83215	G64788-0006	7253-27105	M12X1.5	6
6MNH	83240	G64789-0006	7253-27115	M14X1.5	6
8MNL	83216	G64788-0008	7253-27125	M14X1.5	8
8MNH	83241	G64789-0008	7253-27135	M16X1.5	8
10MNL	83217	G64788-0010	7253-27145	M16X1.5	10
10MNH	83242	G64789-0010	7253-27155	M18X1.5	10
12MNL	83218	G64788-0012	7253-27165	M18X1.5	12
12MNH	83243	G64789-0012	7253-27175	M20X1.5	12
14MNL	83244	G64789-0014	7253-27195	M22X1.5	14
15MNL	83219	G64788-0015	7253-27185	M22X1.5	15
16MNL	83245	G64789-0016	7253-27205	M24X1.5	16
18MNL	83220	G64788-0018	7253-27215	M26X1.5	18
20MNL	83246	G64789-0020	7253-27225	M30X1.5	20
22MNL	83221	G64788-0022	7253-27235	M30X2.0	22
25MNL	83247	G64789-0025	7253-27245	M36X2.0	25
28MNL	83222	G64788-0028	7253-27255	M36X2.0	28
30MNL	83248	G64789-0030	7253-27265	M42X2.0	30
35MNL	83223	G64788-0035	7253-27275	M45X2.0	35
38MNL	83249	G64789-0038	7253-27285	M52X2.0	38
42MNL	83224	G64788-0042	7253-27295	M52X2.0	42

## Male British Standard Pipe Tapered/ Japanese Tapered Thread

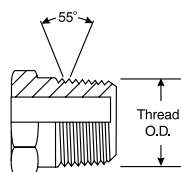

BSPT Male (MBSPT)

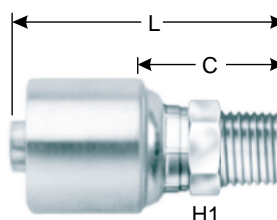

H1

Descr	#		∅			H1	L		C	
	"	mm	"	mm		mm	"	mm	"	mm
4G-4MBSPT	G25795-0404	7100-91075	1/4	6.4	1/4-19	14	1.89	47.9	0.97	24.8
6G-6MBSPT	G25795-0606	7100-91105	3/8	9.5	3/8-19	19	1.95	49.5	1.03	26.1
8G-8MBSPT	G25795-0808	7100-91125	1/2	12.7	1/2-14	22	2.49	63.4	1.22	30.9
12G-12MBSPT	G25795-1212	7100-91145	3/4	19.0	3/4-14	32	2.92	74.1	1.41	35.7
16G-16MBSPT	G25795-1616	7100-91155	1	25.4	1-11	36	3.44	87.5	1.64	41.6

EQUIPMENT

HOSE/CPLG. SELECTION

TECH. DATA

EXT. & VERY HIGH PRESS. HOSE

GS CPLGS.

PCM CPLGS.

PCS CPLGS.

HIGH & MED. PRESS. HOSE

MEGACRIMP® CPLGS.

PC CPLGS.

FIELD ATTACHABLE CPLGS.

AIR BRAKE HOSE & CPLGS.

MEGATECH™/C5 HOSE & CPLGS.

LOW PRESS. HOSE & CPLGS.

C14 HOSE & CPLGS.

POLARSEAL® HOSE & CPLGS.

PWR. STG. HOSE & CPLGS.

THERMO-PLASTIC HOSE & CPLGS.

ADAPTERS

QUICK DISCONNECT CPLGS.

ACCESSORIES & ASSORTMENTS

PART NUMBER INDEXES



# MegaCrimp® Couplings - G25 Series

## Male British Standard Pipe Parallel

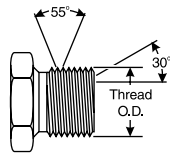

BSPP Male

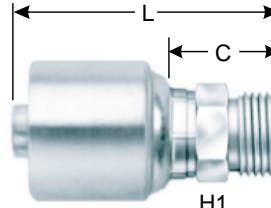

H1

Descr	#		⌀		🌀	H1		L		C	
			"	mm		"	"	mm	"	mm	
4G-4MBSPP	G25810-0404	7100-15515	1/4	6.4	1/4-19	19	2.11	53.5	1.08	27.5	
6G-6MBSPP	G25810-0606	7100-15525	3/8	9.5	3/8-19	22	2.17	55.0	1.07	27.1	
6G-8MBSPP	G25810-0608	7100-15535	3/8	9.5	1/2-14	27	2.36	60.0	1.26	32.1	
8G-8MBSPP	G25810-0808	7100-05545	1/2	12.7	1/2-14	27	2.72	69.0	1.24	31.5	
10G-10MBSPP	G25810-1010	7100-05555	5/8	15.8	5/8-14	30	2.89	73.5	1.41	36.0	
12G-12MBSPP	G25810-1212	7100-05565	3/4	19.0	3/4-14	32	3.35	85.0	1.34	34.0	
16G-16MBSPP	G25810-1616	7100-05575	1	25.4	1-11	41	3.98	101.0	1.74	44.2	

## Female British Standard Pipe Parallel O-Ring Swivel

Includes O-Ring sealing in flare.

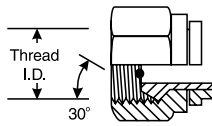

FBSPORX

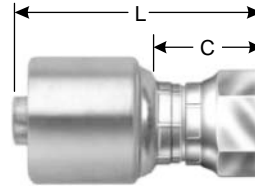

H2

Descr	#		⌀		🌀	H2		L		C	
			"	mm		mm	"	mm	"	mm	
4G-4FBSPORX	G25830-0404	7100-94175	1/4	6.4	1/4-19	19	1.57	39.9	0.67	17.0	
4G-6FBSPORX	G25830-0406	7100-94185	1/4	6.4	3/8-19	22	1.57	39.9	0.67	17.0	
5G-6FBSPORX	G25830-0506	7100-94195	5/16	7.9	3/8-19	22	1.66	42.2	0.71	18.1	
5G-8FBSPORX	G25830-0508	7100-94205	5/16	7.9	1/2-14	27	2.16	54.8	1.06	26.8	
6G-6FBSPORX	G25830-0606	7100-94215	3/8	9.5	3/8-19	22	1.61	41.0	0.70	17.9	
6G-8FBSPORX	G25830-0608	7100-94225	3/8	9.5	1/2-14	27	1.58	40.2	0.67	17.1	
8G-6FBSPORX	G25830-0806	7100-94235	1/2	12.7	3/8-19	22	2.62	66.5	1.14	29.0	
8G-8FBSPORX	G25830-0808	7100-94245	1/2	12.7	1/2-14	27	2.53	64.2	1.05	26.7	
8G-10FBSPORX	G25830-0810	7100-94255	1/2	12.7	5/8-14	27	2.68	68.0	1.20	30.5	
10G-10FBSPORX	G25830-1010	7100-94265	5/8	15.8	5/8-14	30	1.92	48.8	0.75	19.1	
10G-12FBSPORX	G25830-1012	7100-94275	5/8	15.8	3/4-14	32	1.99	50.54	0.82	20.4	
12G-12FBSPORX	G25830-1212	7100-94285	3/4	19.0	3/4-14	32	2.34	59.5	0.83	21.0	
12G-16FBSPORX	G25830-1216	7100-94295	3/4	19.0	1-11	41	3.43	87.0	1.42	36.0	
16G-16FBSPORX	G25830-1616	7100-94305	1	25.4	1-11	41	2.76	70.1	0.99	25.2	
20G-20FBSPORX	G25830-2020	7100-94315	1 1/4	31.7	1 1/4-11	50	2.97	75.5	1.16	29.5	

## Female British Standard Pipe Parallel O-Ring Swivel – 45° Bent Tube

Includes O-Ring sealing in flare.

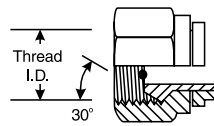

FBSPORX

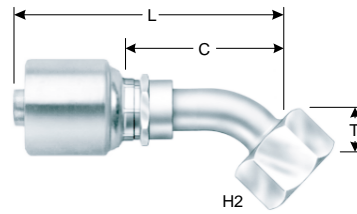

H2

Descr	#		⊕		🌀	H2	T		L		C	
			"	mm			mm	"	mm	"	mm	"
4G-4FBSPORX45	G25831-0404	7100-91445	1/4	6.4	1/4-19	19	0.46	11.6	2.13	54.0	1.22	31.1
6G-6FBSPORX45	G25831-0606	7100-91475	3/8	9.5	3/8-19	22	0.61	15.4	2.44	62.1	1.54	39.1
8G-8FBSPORX45	G25831-0808	7100-91495	1/2	12.7	1/2-14	27	0.67	17.0	3.01	76.5	1.73	44.0
10G-10FBSPORX45	G25831-1010	7100-91505	5/8	15.8	3/4-14	30.0	0.84	21.3	3.22	81.8	2.05	52.1
12G-12FBSPORX45	G25831-1212	7100-91525	3/4	19.0	3/4-14	32	1.11	28.3	4.05	102.9	2.54	64.4
16G-16FBSPORX45	G25831-1616	7100-91535	1	25.4	1-11	41	1.22	30.9	4.87	123.6	3.10	78.8
20G-20FBSPORX45	G25831-2020	7100-92715	1 1/4	31.7	1 1/4-11	50	1.48	37.5	5.50	139.6	3.68	93.4

## Female British Standard Pipe Parallel O-Ring Swivel – 90° Bent Tube

Includes O-Ring sealing in flare.

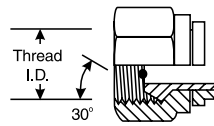

FBSPORX

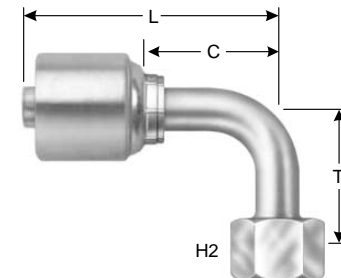

H2

Descr	#		⊕		🌀	H2	T		L		C	
			"	mm			mm	"	mm	"	mm	"
4G-4FBSPORX90	G25832-0404	7100-91545	1/4	6.4	1/4-19	19	0.93	23.5	1.94	49.4	1.04	26.5
6G-6FBSPORX90	G25832-0606	7100-91575	3/8	9.5	3/8-19	22	1.26	32.0	2.24	57.0	1.34	34.0
6G-8FBSPORX90	G25832-0608	7100-91585	3/8	9.5	1/2-14	27	1.26	32.0	2.24	57.0	1.34	34.0
8G-8FBSPORX90	G25832-0808	7100-91595	1/2	12.7	1/2-14	27	1.48	37.5	2.87	73.0	1.59	40.5
10G-10FBSPORX90	G25832-1010	7100-91605	5/8	15.8	5/8-14	30	1.81	46.0	3.00	76.3	1.83	46.6
12G-12FBSPORX90	G25832-1212	7100-91625	3/4	19.0	3/4-14	32	2.36	60.0	3.72	94.5	2.20	56.0
16G-16FBSPORX90	G25832-1616	7100-91635	1	25.4	1-11	41	2.76	70.0	4.69	119.2	2.93	74.3

EQUIPMENT
HOSE/CPLG. SELECTION
TECH. DATA
EXT. & VERY HIGH PRESS. HOSE
GS CPLGS.
PCM CPLGS.
PCS CPLGS.
HIGH & MED. PRESS. HOSE
MEGACRIMP® CPLGS.
PC CPLGS.
FIELD ATTACHABLE CPLGS.
AIR BRAKE HOSE & CPLGS.
MEGATECH™/C5 HOSE & CPLGS.
LOW PRESS. HOSE & CPLGS.
C14 HOSE & CPLGS.
POLARSEAL® HOSE & CPLGS.
PWR. STG. HOSE & CPLGS.
THERMO-PLASTIC HOSE & CPLGS.
ADAPTERS
QUICK DISCONNECT CPLGS.
ACCESSORIES & ASSORTMENTS
PART NUMBER INDEXES



# MegaCrimp® Couplings - G25 Series

## Female British Standard Pipe Parallel O-Ring Swivel – 90° Block

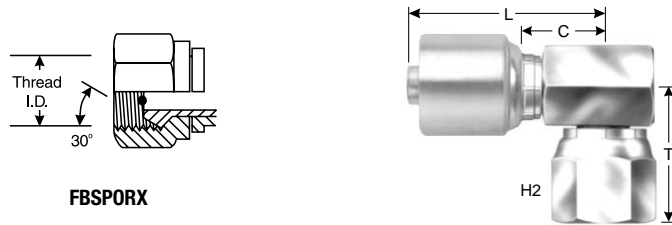

FBSPORX

Descr	#		⌀		🌀	H2		T		L		C	
			"	mm		"	mm	"	mm	"	mm		
4G-4FBSPORX90BL	G25845-0404	7100-91825	1/4	6.4	1/4-19	3/4	0.71	18.0	1.63	41.4	0.72	18.2	
6G-6FBSPORX90BL	G25845-0606	7100-91835	3/8	9.5	3/8-19	7/8	0.83	21.0	1.71	43.5	0.79	20.0	
8G-8FBSPORX90BL	G25845-0808	7100-91845	1/2	12.7	1/2-14	1 1/16	0.94	24.0	2.20	55.9	0.93	23.5	

## Female British Flat-Face Swivel

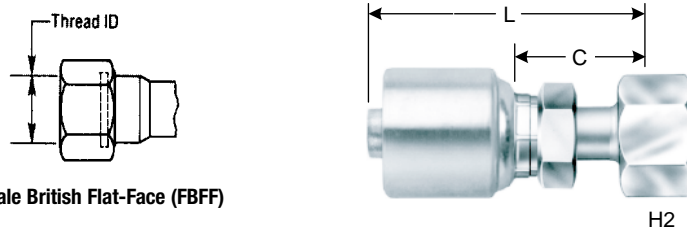

Female British Flat-Face (FBFF)

Descr	#		⌀		🌀	H2		L		C	
			"	mm		mm	"	mm	"	mm	
6G-8FBFFX	G25855-0608	7100-93725	3/8	9.5	1/2-14	27	1.79	45.5	0.69	17.6	
8G-8FBFFX	G25855-0808	7100-93735	1/2	12.7	1/2-14	27	2.19	55.5	0.71	18.0	
8G-12FBFFX	G25855-0812	7100-93745	1/2	12.7	3/4-14	32	2.07	52.5	0.59	15.0	

## Female Komatsu-Style Japanese Metric Swivel

These female swivels have been marked with two small notches on the hex to identify them as the Komatsu-style.

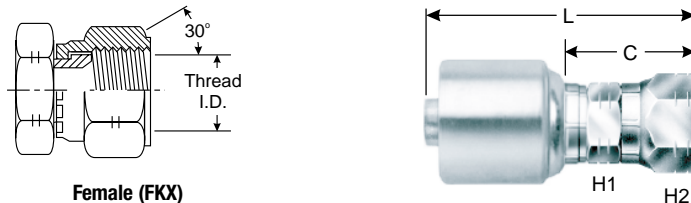

Female (FKX)

Descr	#		⌀		🌀	H1		H2		L		C	
			"	mm		"	"	"	mm	"	mm		
4G-4FKX	G25910-0404	7100-13715	1/4	6.4	M14X1.5	9/16	3/4	2.22	56.3	1.19	30.2		
4G-6FKX	G25910-0406	7100-13735	1/4	6.4	M18X1.5	11/16	7/8	2.41	61.3	1.39	35.3		
6G-6FKX	G25910-0606	7100-13725	3/8	9.5	M18X1.5	11/16	7/8	2.47	62.8	1.37	34.9		
8G-8FKX	G25910-0808	7100-03735	1/2	12.7	M22X1.5	7/8	1 1/16	2.93	74.5	1.46	37.0		
10G-10FKX	G25910-1010	7100-03745	5/8	15.8	M24X1.5	1	1 1/4	3.09	78.5	1.62	41.1		
12G-12FKX	G25910-1212	7100-03755	3/4	19.0	M30X1.5	1 1/8	1 7/8	3.82	97.1	1.81	46.1		
16G-16FKX	G25910-1616	7100-03765	1	25.4	M33X1.5	1 3/8	1 5/8	4.51	114.6	2.28	57.8		

## Female Komatsu-Style Japanese Metric Swivel – 45° Bent Tube

These female swivels have been marked with two small notches on the hex to identify them as the Komatsu-style.

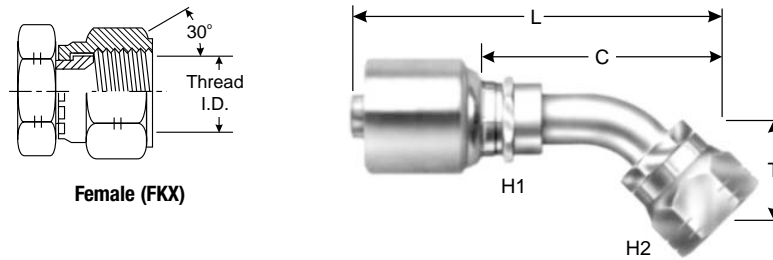

Descr	#		⊕		🌀	H1	H2	T		L		C	
			"	mm		"	"	"	mm	"	mm	"	mm
4G-4FKX45	G25911-0404	7100-06555	1/4	6.4	M14X1.5	1/2	3/4	0.75	19.0	3.07	78.0	2.05	52.0
6-6FKX90M	G25911-0606	7100-06575	3/8	9.5	M18X1.5	5/8	7/8	1.10	28.0	3.39	86.0	2.29	58.1
8G-8FKX45	G25911-0808	7100-06595	1/2	12.7	M22X1.5	13/16	1 1/16	0.71	18.0	3.74	95.0	2.26	57.5
10G-10FKX45	G25911-1010	7100-06625	5/8	15.8	M24X1.5	15/16	1 1/4	1.10	28.0	4.43	112.5	2.95	75.0
12G-12FKX45	G25911-1212	7100-06645	3/4	19.0	M30X1.5	1 1/16	1 7/8	1.18	30.0	5.24	133.0	3.23	82.0

## Female Komatsu-Style Japanese Metric Swivel – 90° Bent Tube

These female swivels have been marked with two small notches on the hex to identify them as the Komatsu-style.

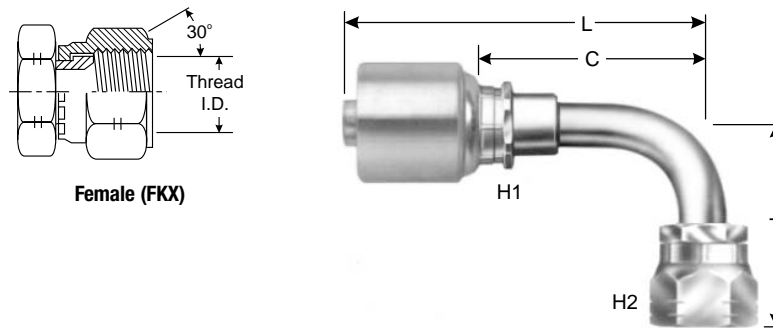

Descr	#		⊕		🌀	H1	H2	T		L		C	
			"	mm		"	"	"	mm	"	mm	"	mm
4G-4FKX90M	G25913-0404	7100-06705	1/4	6.4	M14X1.5	1/2	3/4	1.50	38.0	2.72	69.0	1.69	43.0
6G-6FKX90-028	G25913-0606	7100-06955	3/8	9.5	M18X1.5	5/8	7/8	1.09	27.7	2.92	74.2	1.82	46.3
8G-8FKX90M	G25913-0808	7100-06765	1/2	12.7	M22X1.5	13/16	1 1/16	1.38	35.0	3.46	88.0	1.99	50.5
12G-12FKX90M	G25913-1212	7100-06825	3/4	19.0	M30X1.5	1 1/16	1 7/16	2.48	63.0	4.65	188.0	2.64	67.0

EQUIPMENT
HOSE/CPLG. SELECTION
TECH. DATA
EXT. & VERY HIGH PRESS. HOSE
GS CPLGS.
PCM CPLGS.
PCS CPLGS.
HIGH & MED. PRESS. HOSE
MEGACRIMP® CPLGS.
PC CPLGS.
FIELD ATTACHABLE CPLGS.
AIR BRAKE HOSE & CPLGS.
MEGATECH™/C5 HOSE & CPLGS.
LOW PRESS. HOSE & CPLGS.
C14 HOSE & CPLGS.
POLARSEAL® HOSE & CPLGS.
PWR. STG. HOSE & CPLGS.
THERMO-PLASTIC HOSE & CPLGS.
ADAPTERS
QUICK DISCONNECT CPLGS.
ACCESSORIES & ASSORTMENTS
PART NUMBER INDEXES



# MegaCrimp® Couplings - G25 Series

## Female Japanese Industrial Standard Swivel

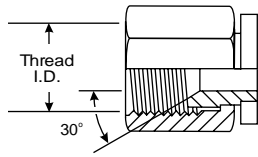

Japanese 30° Flare Female

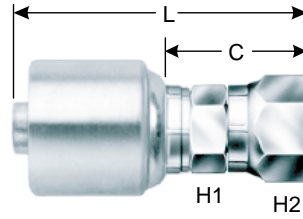

Descr	#		⊕		🌀	H1	H2	L		C	
			"	mm		mm	mm	"	mm	"	mm
4G-4FJISX	G25930-0404	7100-15405	1/4	6.4	1/4-19	19.0	19.0	2.20	56.0	1.18	30.0
6G-6FJISX	G25930-0606	7100-15415	3/8	9.5	3/8-19	16.0	22.0	2.38	60.5	1.28	32.5
8G-8FJISX	G25930-0808	7100-05425	1/2	12.7	1/2-14	20.0	27.0	2.93	74.5	1.46	37.0
MEGACRIMP® CPLGS.	12G-12FJISX	G25930-1212	3/4	19.0	3/4-14	27.0	32.0	3.67	93.3	1.67	42.3
	16G-16FJISX	G25930-1616	1	25.4	1-11	35.0	38.0	4.08	103.6	1.84	46.8
	20G-20FJISX	G25930-2020	1 1/4	31.7	1 1/4-11	44.5	50.8	4.59	116.5	2.26	57.5

EQUIPMENT
HOSE/CPLG. SELECTION
TECH. DATA
EXT. & VERY HIGH PRESS. HOSE
GS CPLGS.
PCM CPLGS.
PCS CPLGS.
HIGH & MED. PRESS. HOSE
MEGACRIMP® CPLGS.
PC CPLGS.
FIELD ATTACHABLE CPLGS.
AIR BRAKE HOSE & CPLGS.
MEGATECH™/C5 HOSE & CPLGS.
LOW PRESS. HOSE & CPLGS.
C14 HOSE & CPLGS.
POLARSEAL® HOSE & CPLGS.
PWR. STG. HOSE & CPLGS.
THERMO-PLASTIC HOSE & CPLGS.
ADAPTERS
QUICK DISCONNECT CPLGS.
ACCESSORIES & ASSORTMENTS
PART NUMBER INDEXES

**Recommended For:** Liquid or gaseous propane, butane or any combination of these two mixtures up to 350 psi rated working pressure. Can be used for natural gas under certain conditions such as: open/outside areas and well-ventilated factory buildings (if local building codes permit). Not recommended for residential or office buildings. (Contact Denver Product Application, 303-744-5070, for inspection and assembly testing information.) Meets Underwriters Laboratory Standard #21, CAN/CGA-8.1-M86, NFPA 58, Section 2-4.6.

**Tube:** Nitrile – Type C\*.

**Reinforcement:** Braided, high tensile synthetic textile cord.

**Cover:** Black perforated Neoprene - Type A.\*

**Couplings (see crimp manual for specifics):**

Permanent PC Couplings, pages E48-65.

APPLICATION NOTE: No LP350 hose assemblies 60" or longer allowed per UL requirement.



### SPECIFICATIONS

Description	Part No. (50' Length)	Hose I.D. (In.)	Hose O.D. (In.)	Working Pressure (psi)	Min. Burst Pressure (psi)	Min. Bend Radius (In.)	Vacuum (In. Hg)
4LP350	85717	1/4	0.56	350	1,750	3.0	30
6LP350	85718	3/8	0.70	350	1,750	3.0	30
8LP350	85719	1/2	0.84	350	1,750	5.0	25
12LP350	85738	3/4	1.23	350	1,750	6.0	20
16LP350	85739	1	1.51	350	1,750	8.0	15
20LP350	85742	1-1/4	1.85	350	1,750	10.0	10
24LP350	85743	1-1/2	2.25	350	1,750	12.0	10
32LP350	85744	2	2.86	350	1,750	14.0	10

\* Hose stock specifications on page C7.



# Power Crimp® PC Couplings

## Stainless Steel Couplings for use with M2T® Hose

### Male Pipe (NPTF –30° Cone Seat) –Stainless Steel

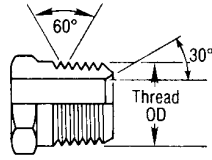

NPTF Solid Male (MP)

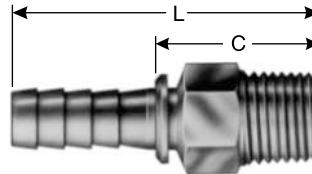

H1

Descr	#		⊕		🌀	H1	L		C	
			"	mm		"	"	mm	"	mm
4-4MP-SS	85200	7362-00045	1/4	6.4	1/4-18	9/16	2.22	56.4	1.18	30.0
6-6MP-SS	85201	7362-00065	3/8	9.7	3/8-18	11/16	2.22	56.4	1.20	30.5
8-8MP-SS	85202	7362-00085	1/2	12.7	1/2-14	7/8	2.89	73.4	1.45	36.8
12-12MP-SS	85203	7362-00125	3/4	19.1	3/4-14	1-1/16	3.21	81.5	1.50	38.1
16-16MP-SS	85204	7362-00165	1	25.4	1-11-1/4	1-3/8	3.69	93.7	1.91	48.5

### Female JIC 37° Flare Swivel – Stainless Steel

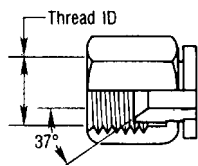

JIC 37° Flare Female (FJX)

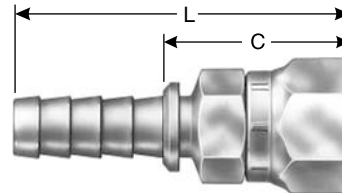

H1

H2

Descr	#		⊕		🌀	H1	H2	L		C	
			"	mm		"	"	"	mm	"	mm
6-6FJX-SS	85208	7362-01075	3/8	9.7	9/16-18	5/8	3/4	2.23	56.6	1.22	31.0
12-12FJX-SS	85212	7362-01135	3/4	19.1	1-1/16-12	1-1/16	1-1/4	3.41	86.6	1.71	43.4
16-16FJX-SS	85213	7362-01165	1	25.4	1-5/16-12	1-3/8	1-1/2	3.66	93.0	1.95	49.5

### Female SAE 45° Flare Swivel –Stainless Steel

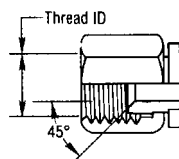

SAE 45° Flare Swivel Female (FSX)

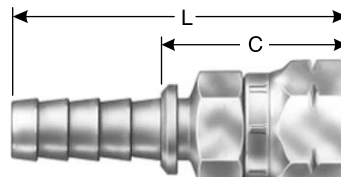

H1

H2

Descr	#		⊕		🌀	H1	H2	L		C	
			"	mm		"	"	"	mm	"	mm
6-6FSX-SS	85207	7362-01065	3/8	9.7	5/8-18	5/8	3/4	2.23	56.6	1.22	31.0
12-12FSX-SS	85211	7362-01125	3/4	19.1	1-1/16-14	1-1/16	1-1/4	3.41	86.6	1.71	43.4



## Stainless Steel Couplings for use with M2T® Hose

### Dual Seat Female JIC 37°/SAE 45° Flare Swivel – Stainless Steel

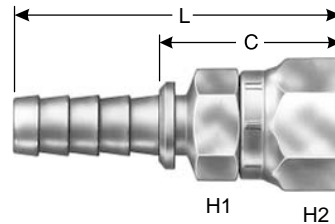

Descr	#		⊕		🌀	L		C	
			"	mm		"	mm	"	mm
4-4FJSX-SS	85206	7362-01045	1/4	6.4	7/16-20	2.15	54.6	1.07	27.2
8-8FJSX-SS	85209	7362-01085	1/2	12.7	3/4-16	2.82	71.6	1.38	35.1
10-10FJSX-SS	85210	7362-01105	5/8	15.8	7/8-14	3.06	77.7	1.62	41.2

### Power Crimp One Non-Skive Ferrules – Stainless Steel



Descr	#		L		⊕	
			"	mm	"	mm
4PC1F-M2SS	85027	7362-51045	1.20	30.5	0.73	18.5
6PC1F-M2SS	85028	7362-51065	1.20	30.5	1.06	26.9
8PC1F-M2SS	85029	7362-51085	1.47	37.3	1.06	26.9
10PC1F-M2SS	85030	7362-51105	1.47	37.3	1.21	30.7
12PC1F-M2SS	85031	7362-51125	1.69	42.9	1.35	34.3
16PC1F-M2SS	85032	7362-51165	1.69	42.9	1.94	49.4

- EQUIPMENT
- HOSE/CPLG. SELECTION
- TECH. DATA
- EXT. & VERY HIGH PRESS. HOSE
- GS CPLGS.
- PCM CPLGS.
- PCS CPLGS.
- HIGH & MED. PRESS. HOSE
- MEGACRIMP® CPLGS.
- PC CPLGS.**
- FIELD ATTACHABLE CPLGS.
- AIR BRAKE HOSE & CPLGS.
- MEGATECH™/C5 HOSE & CPLGS.
- LOW PRESS. HOSE & CPLGS.
- C14 HOSE & CPLGS.
- POLARSEAL® HOSE & CPLGS.
- PWR. STG. HOSE & CPLGS.
- THERMO-PLASTIC HOSE & CPLGS.
- ADAPTERS
- QUICK DISCONNECT CPLGS.
- ACCESSORIES & ASSORTMENTS
- PART NUMBER INDEXES



# Power Crimp® PC Couplings

## Male Pipe (NPTF – 30° Cone Seat)

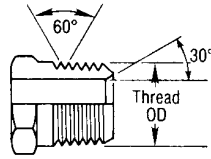

NPTF Solid Male (MP)

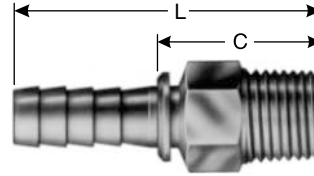

H1

Descr	#		⊖		🌀	H1	L		C	
			"	mm		"	"	mm	"	mm
3-2MP	80001	7334-36215	3/16	4.8	1/8-27	1/2	2.03	51.6	0.94	23.9
3-4MP	80002	7334-36245	3/16	4.8	1/4-18	9/16	2.22	56.4	1.13	28.7
4-2MP	80003	7301-09125	1/4	6.4	1/8-17	1/2	2.03	51.6	0.94	23.9
4-4MP	80004	7301-09145	1/4	6.4	1/4-18	9/16	2.22	56.4	1.13	28.7
4-6MP	80005	7301-09165	1/4	6.4	3/8-18	11/16	2.22	56.4	1.13	28.7
4-8MP	80006	7301-09185	1/4	6.4	1/2-14	7/8	2.48	63.0	1.39	35.3
5-4MP	80007	7301-19145	5/16	7.9	1/4-18	5/8	2.19	55.6	1.18	30.0
6-4MP	80008	7306-29125	3/8	9.5	1/4-18	5/8	2.22	56.4	1.20	30.5
6-6MP	80009	7306-29145	3/8	9.5	3/8-18	11/16	2.22	56.4	1.20	30.5
6-8MP	80011	7306-29165	3/8	9.5	1/2-14	7/8	2.41	61.2	1.39	35.3
8-6MP	80012	7301-39125	1/2	12.7	3/8-18	13/16	2.70	68.6	1.26	32.0
8-8MP	80013	7301-39145	1/2	12.7	1/2-14	7/8	2.89	73.4	1.45	36.8
8-12MP	80014	7301-39165	1/2	12.7	3/4-14	1 1/16	2.94	74.7	1.50	38.1
10-8MP	80015	7301-49125	5/8	15.8	1/2-14	7/8	2.92	74.2	1.49	37.8
10-12MP	80016	7301-49145	5/8	15.8	3/4-14	1 1/16	2.94	74.7	1.51	38.4
12-8MP	80017	7301-59125	3/4	19.1	1/2-14	1 1/16	3.21	81.5	1.50	38.1
12-12MP	80018	7301-59145	3/4	19.1	3/4-14	1 1/16	3.21	81.5	1.50	38.1
12-16MP	80019	7301-59165	3/4	19.1	1-11 1/2	1 3/8	2.52	64.0	1.81	46.0
14-16MP	80020	7334-30455	7/8	22.2	1-11 1/2	1 3/8	3.06	77.7	1.81	46.0
16-12MP	80021	7301-69125	1	25.4	3/4-14	1 3/8	3.43	87.1	1.72	43.7
16-16MP	80023	7301-69145	1	25.4	1-11 1/2	1 3/8	3.62	91.9	1.91	48.5
20-20MP	80024	7301-79145	1 1/4	31.7	1 1/4-11 1/2	1 3/4	4.45	113.0	2.15	54.6
24-24MP	80025	7301-89145	1 1/2	38.1	1 1/2-11 1/2	2	4.83	122.7	2.19	55.6
32-32MP	80026	7301-99145	2	50.8	2-11 1/2	2 1/2	5.86	148.8	2.33	59.2

## Male Pipe (NPTF – 30° Cone Seat) – Brass

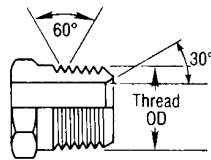

NPTF Solid Male (MP)

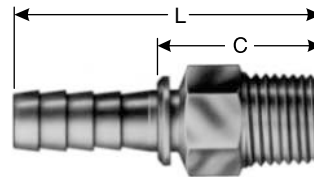

H1

Descr	#		⊖		🌀	H1	L		C	
			"	mm		"	"	mm	"	mm
16-16MPB	80160	7301-00425	1	25.4	1-11-1/2	1-3/8	4.05	102.9	2.34	59.4
32-32MPB	80165	7301-00435	2	50.8	2-11-1/2	2-1/2	6.22	158.0	2.69	68.3

## Male Pipe Long Nose

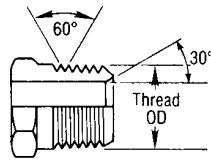

NPTF Solid Male (MP)

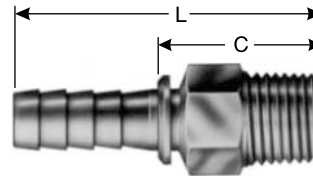

H1

Descr	#		⊖		🌀	H1	L		C	
			"	mm		"	"	mm	"	mm
4-4MPLN	80029	7301-09155	1/4	6.4	1/4-18	9/16	2.61	66.3	1.52	38.6
4-6MPLN	80027	7301-09175	1/4	6.4	3/8-18	11/16	2.61	66.3	1.52	38.6
6-4MPLN	80030	7301-09195	3/8	9.5	1/4-18	5/8	2.54	64.5	1.52	38.6
6-6MPLN	80028	7301-09205	3/8	9.5	3/8-18	11/16	2.54	64.5	1.52	38.6

## Male Pipe Swivel (NPTF – Without 30° Cone Seat)

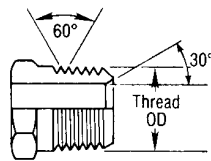

NPTF Solid Male (MP)

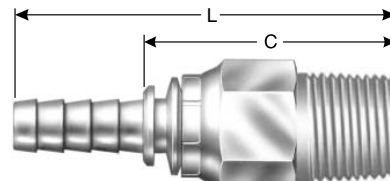

H1

NOT TO BE USED AS A LIVE SWIVEL

Descr	#		⊖		🌀	H1	L		C	
			"	mm		"	"	mm	"	mm
3-2MPX	80031	7334-36335	3/16	4.8	1/8-27	1/2	2.40	61.0	1.31	33.3
4-4MPX	80032	7302-09145	1/4	6.4	1/4-18	1/2	2.63	66.8	1.54	39.1
4-6MPX	80033	7302-09165	1/4	6.4	3/8-18	5/8	2.78	70.6	1.69	42.9
4-8MPX	80034	7302-09185	1/4	6.4	1/2-14	3/4	3.06	77.7	1.96	49.8
6-4MPX	80035	7307-29125	3/8	9.5	1/4-18	5/8	2.75	69.9	1.74	44.2
6-6MPX	80036	7307-29145	3/8	9.5	3/8-18	5/8	2.73	69.3	1.72	43.7
6-8MPX	80037	7307-29165	3/8	9.5	1/2-14	3/4	1.93	49.0	1.93	49.0
8-6MPX	80038	7302-39125	1/2	12.7	3/8-18	13/16	3.19	81.0	1.76	44.7
8-8MPX	80039	7302-39145	1/2	12.7	1/2-14	13/16	3.38	85.9	1.94	49.3
10-12MPX	80041	7302-49145	5/8	15.8	3/4-14	1 1/16	3.44	87.4	2.00	50.8
12-8MPX	80042	7302-59125	3/4	19.1	1/2-14	1 1/16	3.66	93.0	1.95	49.5
12-12MPX	80043	7302-59145	3/4	19.1	3/4-14	1 1/16	3.71	94.2	2.00	50.8
16-16MPX	80044	7302-69145	1	15.4	1-11 1/2	1 1/2	4.18	106.2	2.47	62.7

- EQUIPMENT
- HOSE/CPLG. SELECTION
- TECH. DATA
- EXT. & VERY HIGH PRESS. HOSE
- GS CPLGS.
- PCM CPLGS.
- PCS CPLGS.
- HIGH & MED. PRESS. HOSE
- MEGACRIMP® CPLGS.
- PC CPLGS.
- FIELD ATTACHABLE CPLGS.
- AIR BRAKE HOSE & CPLGS.
- MEGATECH™/C5 HOSE & CPLGS.
- LOW PRESS. HOSE & CPLGS.
- C14 HOSE & CPLGS.
- POLARSEAL® HOSE & CPLGS.
- PWR. STG. HOSE & CPLGS.
- THERMO-PLASTIC HOSE & CPLGS.
- ADAPTERS
- QUICK DISCONNECT CPLGS.
- ACCESSORIES & ASSORTMENTS
- PART NUMBER INDEXES



# Power Crimp® PC Couplings

## Male Special Grease Fitting

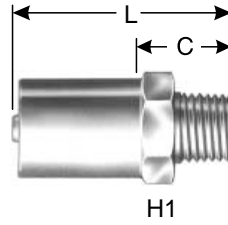

Descr	#		⌀		🌀	H1	L		C	
			"	mm		"	"	mm	"	mm
3-2MPG	80120	7334-32445	3/16	4.8	1/8-27	9/16	1.34	34.0	0.56	14.2
3-2MPGB	80140	7334-37925	3/16	4.8	1/8-27	9/16	1.34	34.0	0.78	19.8

## Female Pipe (NPTF – Without 30° Cone Seat)

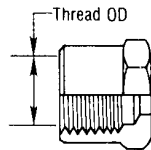

NPTF or NPSF Solid Female (FP)

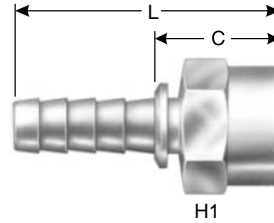

Descr	#		⌀		🌀	H1	L		C	
			"	mm		"	"	mm	"	mm
3-2FP	80061	7334-36225	3/16	4.8	1/8-27	9/16	1.85	47.0	0.76	19.3
4-2FP	80062	7302-05125	1/4	6.4	1/8-27	9/16	1.80	45.7	0.71	18.0
4-4FP	80063	7302-05145	1/4	6.4	1/4-18	11/16	2.03	51.6	0.94	23.9
4-6FP	80064	7302-05165	1/4	6.4	3/8-18	13/16	2.04	51.8	0.95	24.1
6-4FP	80065	7307-25125	3/8	9.5	1/4-18	3/4	1.97	50.0	0.95	24.1
6-6FP	80067	7307-25145	3/8	9.5	3/8-18	13/16	1.97	50.0	0.95	24.1
6-8FP	80068	7307-25165	3/8	9.5	1/2-14	1	2.15	54.6	1.13	28.7
8-6FP	80069	7302-35125	1/2	12.7	3/8-18	7/8	2.45	62.2	1.01	25.7
8-8FP	80071	7302-35145	1/2	12.7	1/2-14	1	2.63	66.8	1.19	30.2
12-12FP	80072	7302-55145	3/4	19.1	3/4-14	1 1/4	2.96	74.2	1.25	31.8

- EQUIPMENT
- HOSE/CPLG. SELECTION
- TECH. DATA
- EXT. & VERY HIGH PRESS. HOSE
- GS CPLGS.
- PCM CPLGS.
- PCS CPLGS.
- HIGH & MED. PRESS. HOSE
- MEGACRIMP® CPLGS.
- PC CPLGS.
- FIELD ATTACHABLE CPLGS.
- AIR BRAKE HOSE & CPLGS.
- MEGATECH™ C5 HOSE & CPLGS.
- LOW PRESS. HOSE & CPLGS.
- C14 HOSE & CPLGS.
- POLARSEAL® HOSE & CPLGS.
- PWR. STG. HOSE & CPLGS.
- THERMO-PLASTIC HOSE & CPLGS.
- ADAPTERS
- QUICK DISCONNECT CPLGS.
- ACCESSORIES & ASSORTMENTS
- PART NUMBER INDEXES

## Female Pipe Swivel (NPSM – 30° Cone Seat)

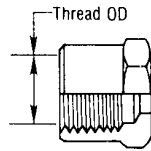

NPTF or NPSF Solid Female (FP)

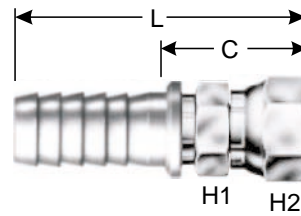

Descr	#		⌀			H1	H2	L		C	
			"	mm		"	"	"	mm	"	mm
4-4FPX	80391	7303-03745	1/4	6.4	1/4-18	1/2	11/16	2.33	59.2	1.24	31.5
6-6FPX	80392	7303-03765	3/8	9.5	3/8-18	5/8	7/8	2.30	58.4	1.28	32.5
8-8FPX	80393	7303-03785	1/2	12.7	1/2-14	13/16	1	2.88	73.2	1.44	36.6
12-12FPX	80394	7303-03825	3/4	19.1	3/4-14	1 1/16	1 1/4	3.46	87.9	1.75	44.5
16-16FPX	80395	7303-03865	1	25.4	1-11 1/2	1 3/8	1 1/2	3.61	91.7	1.90	48.3

## Male JIC 37° Flare

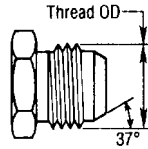

JIC 37° Male (MJ)

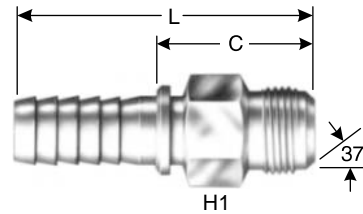

Descr	#		⌀			H1	L		C	
			"	mm		"	"	mm	"	mm
3-4MJ	80181	7334-36235	3/16	4.8	7/16-20	1/2	2.09	53.1	1.00	25.4
4-4MJ	80182	7301-09245	1/4	6.4	7/16-20	1/2	2.22	56.4	1.13	28.7
4-5MJ	80183	7301-09265	1/4	6.4	1/2-20	1/2	2.22	56.4	1.13	28.7
4-6MJ	80184	7301-09285	1/4	6.4	9/16-18	9/16	2.22	56.4	1.13	28.7
5-6MJ	80185	7301-19265	5/16	7.9	9/16-18	5/8	2.17	55.1	1.14	29.0
6-6MJ	80186	7306-29245	3/8	9.5	9/16-18	5/8	2.16	54.9	1.14	29.0
6-8MJ	80187	7306-29265	3/8	9.5	3/4-16	3/4	2.32	58.9	1.30	33.0
6-10MJ	80188	7306-29285	3/8	9.5	7/8-14	7/8	2.41	61.2	1.39	35.3
8-8MJ	80189	7301-39245	1/2	12.7	3/4-16	13/16	2.80	71.1	1.36	34.5
8-10MJ	80191	7301-39265	1/2	12.7	7/8-14	7/8	2.91	73.9	1.47	37.3
8-12MJ	80192	7301-39285	1/2	12.7	1 1/16-12	1 1/16	3.18	80.8	1.74	44.2
10-8MJ	80190	7301-49225	5/8	15.8	3/4-16	7/8	2.92	74.2	1.49	37.8
10-10MJ	80193	7301-49245	5/8	15.8	7/8-14	7/8	3.02	76.7	1.59	40.4
10-12MJ	80194	7301-49265	5/8	15.8	1 1/16-12	1 1/16	3.19	81.0	1.75	44.5
12-12MJ	80195	7301-59245	3/4	19.1	1 1/16-12	1 1/16	3.41	86.6	1.70	43.2
12-14MJ	80196	7301-59265	3/4	19.1	1 3/16-12	1 1/4	3.48	88.4	1.77	45.0
12-16MJ	80197	7301-59285	3/4	19.1	1 5/16-12	1 5/16	3.50	88.9	1.79	45.5
16-16MJ	80199	7301-69245	1	25.4	1 5/16-12	1 3/8	3.60	91.4	1.89	48.0
16-20MJ	80201	7301-69265	1	25.4	1 5/8-12	1 5/8	3.71	94.2	2.00	50.8
20-20MJ	80202	7301-79245	1 1/4	31.7	1 5/8-12	1 3/4	4.43	112.5	2.13	54.1
24-24MJ	80204	7301-89245	1 1/2	38.1	1 7/8-12	2	4.91	124.7	2.27	57.7
32-32MJ	80205	7301-99245	2	50.8	2 1/2-12	2 5/8	6.16	156.5	2.63	66.8

- EQUIPMENT
- HOSE/CPLG. SELECTION
- TECH. DATA
- EXT. & VERY HIGH PRESS. HOSE
- GS CPLGS.
- PCM CPLGS.
- PCS CPLGS.
- HIGH & MED. PRESS. HOSE
- MEGACRIMP® CPLGS.
- PC CPLGS.
- FIELD ATTACHABLE CPLGS.
- AIR BRAKE HOSE & CPLGS.
- MEGATECH™/C5 HOSE & CPLGS.
- LOW PRESS. HOSE & CPLGS.
- C14 HOSE & CPLGS.
- POLARSEAL® HOSE & CPLGS.
- PWR. STG. HOSE & CPLGS.
- THERMO-PLASTIC HOSE & CPLGS.
- ADAPTERS
- QUICK DISCONNECT CPLGS.
- ACCESSORIES & ASSORTMENTS
- PART NUMBER INDEXES



# Power Crimp® PC Couplings

## Female JIC 37° Flare Swivel

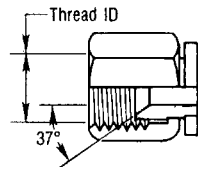

JIC 37° Flare Female (FJX)

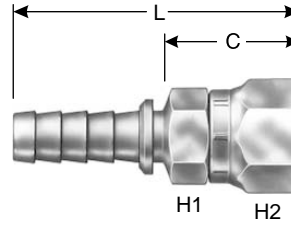

H1 H2

DESCR	#		⊖		🌀	H1	H2	L		C	
			"	mm		"	"	"	Mm	"	mm
3-3FJX	80131	7334-36315	3/16	4.8	3/8-24	1/2	9/16	2.20	55.9	1.11	28.2
3-4FJX	80132	7334-36325	3/16	4.8	7/16-20	1/2	9/16	2.21	56.1	1.12	28.4
3-5FJX	80133	7334-36305	3/16	4.8	1/2-20	1/2	11/16	2.26	57.4	1.18	30.0
4-4FJX	80134	7303-09245	1/4	6.4	7/16-20	1/2	9/16	2.13	54.1	1.04	26.4
4-5FJX	80135	7303-09265	1/4	6.4	1/2-20	1/2	11/16	2.28	57.9	1.18	30.0
4-6FJX	80136	7303-09285	1/4	6.4	9/16-18	9/16	3/4	2.28	57.9	1.18	30.0
5-5FJX	80137	7303-19245	5/16	7.9	1/2-20	5/8	11/16	2.25	57.2	1.23	31.2
5-6FJX	80138	7303-19265	5/16	7.9	9/16-18	5/8	3/4	2.24	56.9	1.22	31.0
6-5FJX	80178	7334-07545	3/8	9.5	1/2-20	5/8	11/16	2.14	54.4	1.12	28.5
6-6FJX	80139	7308-29245	3/8	9.5	9/16-18	5/8	3/4	2.24	56.9	1.22	31.0
6-8FJX	80141	7308-29265	3/8	9.5	3/4-16	11/16	7/8	2.35	59.7	1.33	33.8
6-10FJX	80142	7308-29285	3/8	9.5	7/8-14	13/16	1 1/16	2.51	63.8	1.49	37.8
8-6FJX	80128	7303-39225	1/2	12.7	9/16-18	13/16	3/4	2.62	66.5	1.18	30.0
8-8FJX	80143	7303-39245	1/2	12.7	3/4-16	13/16	7/8	2.76	70.1	1.32	33.5
8-10FJX	80144	7303-39265	1/2	12.7	7/8-14	13/16	1 1/16	2.98	75.7	1.54	39.1
8-12FJX	80145	7303-39285	1/2	12.7	1 1/16-12	1	1 1/4	3.10	78.7	1.66	42.2
10-8FJX	80146	7303-49225	5/8	15.8	3/4-16	7/8	7/8	2.85	72.4	1.41	35.8
10-10FJX	80147	7303-49245	5/8	15.8	7/8-14	7/8	1 1/16	3.04	77.2	1.60	40.6
10-12FJX	80148	7303-49265	5/8	15.8	1 1/16-12	1	1 1/4	3.12	79.2	1.68	42.7
10-14FJX	80149	7303-49285	5/8	15.8	1 3/16-12	1 1/8	1 3/8	3.25	82.6	1.81	46.0
12-10FJX	80151	7303-59225	3/4	19.1	3/4-16	1 1/16	1 1/16	3.20	81.3	1.49	37.9
12-12FJX	80152	7303-59245	3/4	19.1	1 1/16-12	1 1/16	1 1/4	3.39	86.1	1.68	42.7
12-14FJX	80153	7303-59265	3/4	19.1	1 3/16-12	1 1/8	1 3/8	3.56	90.4	1.85	47.0
12-16FJX	80154	7303-59285	3/4	19.1	1 5/16-12	1 1/4	1 1/2	3.51	89.2	1.80	45.7
16-12FJX	80156	7303-69205	1	25.4	1 1/16-12	1 3/8	1 1/4	3.44	87.4	1.73	43.9
16-14FJX	80157	7303-69225	1	25.4	1 3/16-12	1 3/8	1 3/8	3.47	88.1	1.76	44.7
16-16FJX	80158	7303-69245	1	25.4	1 5/16-12	1 3/8	1 1/2	3.63	92.2	1.92	48.8
16-20FJX	80159	7303-69265	1	25.4	1 5/8-12	1 9/16	2	3.79	96.3	2.08	52.8
20-20FJX	80161	7303-79245	1 1/4	31.7	1 5/8-12	1 3/4	2	4.58	116.3	2.28	57.9
20-24FJX	80164	7303-00725	1 1/4	31.7	1 7/8-12	1 7/8	2 1/4	4.85	123.2	2.55	64.8
24-24FJX	80162	7303-89245	1 1/2	38.1	1 7/8-12	2	2 1/4	5.10	129.5	2.46	62.5
32-32FJX	80163	7303-99245	2	50.8	2 1/2-12	2 1/2	2 7/8	6.45	163.8	2.92	74.2

## Female JIC 37° Flare Swivel –45° Bent Tube

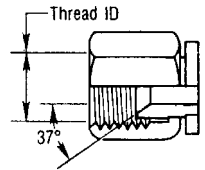

JIC 37° Flare Female (FJX)

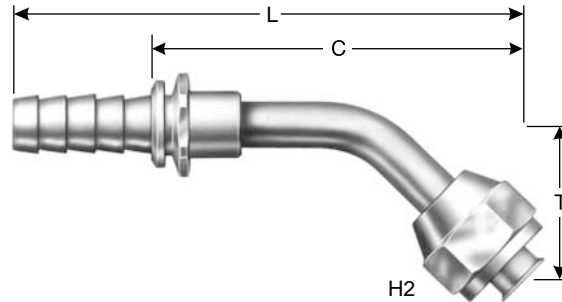

H2

DESCR	#		⊖		🌀	H2	T	L		C		
			"	mm		"	"	mm	"	mm	"	mm
3C2-4FJX45S	83105	7303-01005	3/16	4.8	7/16-20	9/16	0.33	8.4	2.80	71.1	1.71	43.4

## Female JIC 37° Flare Swivel – 90° Bent Tube

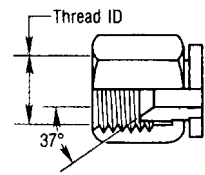

JIC 37° Flare Female (FJX)

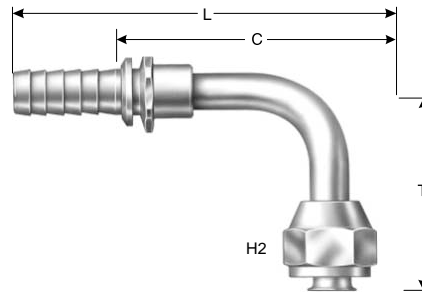

Descr	#		⊕		🌀	H2		T		L		C	
			"	mm		"	"	mm	"	mm	"	mm	
3C2-4FJX90S	83125	7303-01505	3/16	4.8	7/16-20	9/16	0.68	17.3	2.54	64.5	1.45	36.8	
24C2-24FJX90S	83149	7334-41255	1-1/2	38.1	1 7/8-12	2 1/4	4.00	101.6	7.11	180.6	4.47	113.5	

## Male SAE 45° Flare

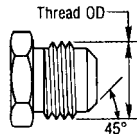

SAE 45° Flare Male (MS)

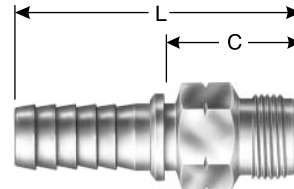

H1

Descr	#		⊕		🌀	H1		L		C	
			"	mm		"	"	mm	"	mm	
4-4MS	80211	7301-09345	1/4	6.4	7/16-20	1/2	2.17	55.1	1.08	27.4	
4-5MS	80212	7301-09365	1/4	6.4	1/2-20	1/2	2.22	56.4	1.13	28.7	
6-6MS	80213	7306-29345	3/8	9.5	5/8-18	5/8	2.21	56.1	1.19	30.2	
6-8MS	80214	7306-29365	3/8	9.5	3/4-16	3/4	2.40	61.0	1.38	35.1	
8-8MS	80215	7301-39345	1/2	12.7	3/4-16	13/16	2.88	73.2	1.44	36.6	
8-10MS	80216	7301-39365	1/2	12.7	7/8-14	7/8	3.02	76.7	1.58	40.1	
12-12MS	80217	7301-59345	3/4	19.1	1 1/16-14	1 1/16	3.53	89.7	1.82	46.2	

## Female SAE 45° Flare Swivel

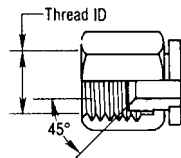

SAE 45° Flare Swivel Female (FSX)

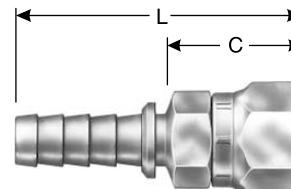

H1

H2

Descr	#		⊕		🌀	H1		H2		L		C	
			"	mm		"	"	"	mm	"	mm		
4-4FSX	80166	7303-09345	1/4	6.4	7/16-20	1/2	9/16	2.13	54.1	1.04	26.4		
4-5FSX	80167	7303-09365	1/4	6.4	1/2-20	1/2	11/16	2.26	57.4	1.18	30.0		
4-6FSX	80168	7303-09385	1/4	6.4	5/8-18	5/8	3/4	2.35	59.7	1.26	32.0		
5-6FSX	80240	7303-19365	5/16	7.9	5/8-18	5/8	3/4	2.34	59.4	1.32	33.5		
6-6FSX	80169	7308-29345	3/8	9.5	5/8-18	5/8	3/4	2.32	58.9	1.31	33.3		
6-8FSX	80171	7308-29365	3/8	9.5	3/4-16	11/16	7/8	2.35	59.7	1.33	33.8		
8-8FSX	80172	7303-39345	1/2	12.7	3/4-16	13/16	7/8	2.79	70.9	1.35	34.3		
8-10FSX	80173	7303-39365	1/2	12.7	7/8-14	13/16	1 1/16	2.99	75.9	1.55	39.4		
12-12FSX	80174	7303-59345	3/4	19.1	1 1/16-14	1 1/16	1 1/4	3.39	86.1	1.68	42.7		

- EQUIPMENT
- HOSE/CPLG. SELECTION
- TECH. DATA
- EXT. & VERY HIGH PRESS. HOSE
- GS CPLGS.
- PCM CPLGS.
- PCS CPLGS.
- HIGH & MED. PRESS. HOSE
- MEGACRIMP® CPLGS.
- PC CPLGS.
- FIELD ATTACHABLE CPLGS.
- AIR BRAKE HOSE & CPLGS.
- MEGATECH™/C5 HOSE & CPLGS.
- LOW PRESS. HOSE & CPLGS.
- C14 HOSE & CPLGS.
- POLARSEAL® HOSE & CPLGS.
- PWR. STG. HOSE & CPLGS.
- THERMO-PLASTIC HOSE & CPLGS.
- ADAPTERS
- QUICK DISCONNECT CPLGS.
- ACCESSORIES & ASSORTMENTS
- PART NUMBER INDEXES



# Power Crimp® PC Couplings

EQUIPMENT
HOSE/CPLG. SELECTION
TECH. DATA
EXT. & VERY HIGH PRESS. HOSE
GS CPLGS.
PCM CPLGS.
PCS CPLGS.
HIGH & MED. PRESS. HOSE
MEGACRIMP® CPLGS.
<b>PC CPLGS.</b>
FIELD ATTACHABLE CPLGS.
AIR BRAKE HOSE & CPLGS.
MEGATECH™ C5 HOSE & CPLGS.
LOW PRESS. HOSE & CPLGS.
C14 HOSE & CPLGS.
POLARSEAL® HOSE & CPLGS.
PWR. STG. HOSE & CPLGS.
THERMO-PLASTIC HOSE & CPLGS.
ADAPTERS
QUICK DISCONNECT CPLGS.
ACCESSORIES & ASSORTMENTS
PART NUMBER INDEXES

## Male Flat-Face O-Ring

SAE J1453 Captive O-Ring Groove for Improved O-Ring Retention

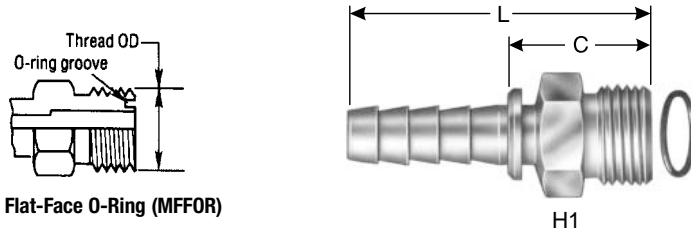

Male Flat-Face O-Ring (MFFOR)

Descr	#		⌀		🌀	H1	L		C	
			"	mm		"	"	mm	"	mm
24-24MFFOR	83661	7301-02575	1-1/2	38.1	2-12	2-1/8	4.18	106.2	1.54	39.1

## Female Flat-Face Swivel

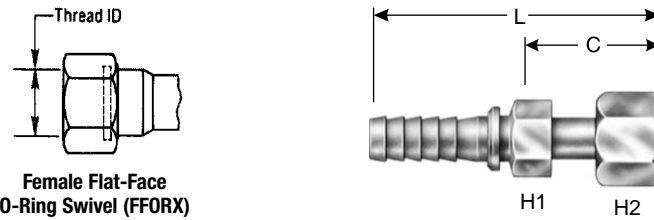

Female Flat-Face O-Ring Swivel (FFORX)

Descr	#		⌀		🌀	H1	H2	L		C	
			"	mm		"	"	"	mm	"	mm
3C2-6FFORX	83603	7303-05945	3/16	4.8	11/16-16	5/8	13/16	2.63	66.8	1.54	39.1

## SAE Male Inverted Swivel

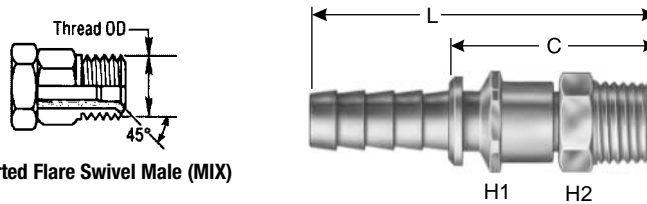

SAE Inverted Flare Swivel Male (MIX)

Descr	#		⌀		🌀	H1	H2	L		C	
			"	mm		"	"	"	mm	"	mm
3C2-3MIX	83301	7303-02995	3/16	4.8	3/8-24	1/2	3/8	2.67	67.8	1.58	40.1



## SAE Male Inverted Swivel –45° Bent Tube

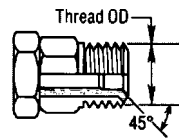

SAE Inverted Flare Swivel Male (MIX)

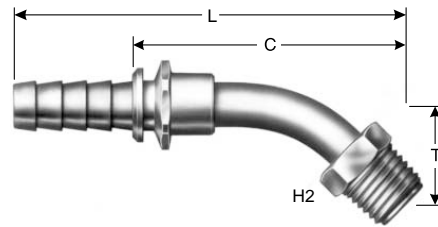

Descr	#		⊕		🌀	H2		T		L		C	
			"	mm		"	"	mm	"	mm	"	mm	
3C2-3MIX45S	83302	7303-03205	3/16	4.8	3/8-24	3/8	0.58	14.7	2.78	70.6	1.69	42.9	

## SAE Male Inverted Swivel –90° Bent Tube

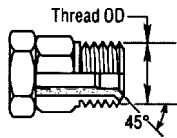

SAE Inverted Flare Swivel Male (MIX)

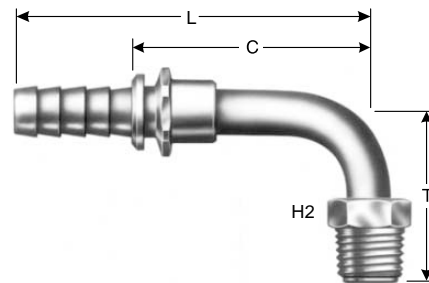

Descr	#		⊕		🌀	H2		T		L		C	
			"	mm		"	"	mm	"	mm	"	mm	
3C2-3MIX90S	83303	7303-03495	3/16	4.8	3/8-24	3/8	1.05	26.7	2.42	61.5	1.33	33.8	

EQUIPMENT

HOSE/CPLG. SELECTION

TECH. DATA

EXT. & VERY HIGH PRESS. HOSE

GS CPLGS.

PCM CPLGS.

PCS CPLGS.

HIGH & MED. PRESS. HOSE

MEGACRIMP® CPLGS.

**PC CPLGS.**

FIELD ATTACHABLE CPLGS.

AIR BRAKE HOSE & CPLGS.

MEGATECH™/C5 HOSE & CPLGS.

LOW PRESS. HOSE & CPLGS.

C14 HOSE & CPLGS.

POLARSEAL® HOSE & CPLGS.

PWR. STG. HOSE & CPLGS.

THERMO-PLASTIC HOSE & CPLGS.

ADAPTERS

QUICK DISCONNECT CPLGS.

ACCESSORIES & ASSORTMENTS

PART NUMBER INDEXES



# Power Crimp® PC Couplings

## Code 61 O-Ring Flange

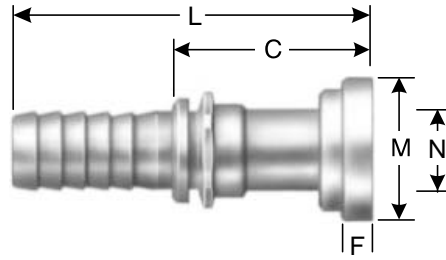

Descr	#		⊕		N	M		L		C		F	
			"	mm		"	"	mm	"	mm	"	mm	"
24-24FL	80323	7305-80055	1-1/2	38.1	1-1/2	2.38	60.5	4.94	125.5	2.30	58.4	0.32	8.1
24-32FL	80324	7305-80065	1-1/2	38.1	2	2.81	71.4	4.94	125.5	2.30	58.4	0.38	9.7
32-32FL	80325	7305-90055	2	50.8	2	2.81	71.4	6.07	154.2	2.54	64.5	0.38	9.7
32C2-40FL	80300	7305-90065	2	50.8	2-1/2	3.31	84.1	6.07	154.2	2.54	64.5	0.38	9.7

## Code 61 O-Ring Flange — 22½° Bent Tube

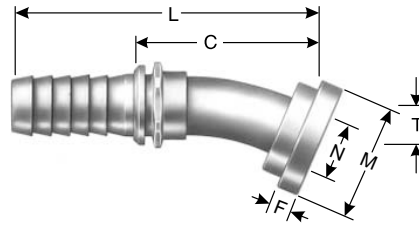

Descr	#		⊕		N	M		T		L		C		F	
			"	mm		"	"	mm	"	mm	"	mm	"	mm	"
24-24FL22	80333	7305-80245	1-1/2	38.1	1-1/2	2.38	60.5	0.63	16.0	6.12	155.5	3.48	88.4	0.32	8.1
24-32FL22	80334	7305-80265	1-1/2	38.1	2	2.81	71.4	0.63	16.0	6.12	155.5	3.48	88.4	0.38	9.7
32-32FL22	80335	7305-90245	2	50.8	2	2.81	71.4	0.88	22.4	7.98	202.7	4.45	113.0	0.38	9.7

- EQUIPMENT
- HOSE/CPLG. SELECTION
- TECH. DATA
- EXT. & VERY HIGH PRESS. HOSE
- GS CPLGS.
- PCM CPLGS.
- PCS CPLGS.
- HIGH & MED. PRESS. HOSE
- MEGACRIMP® CPLGS.
- PC CPLGS.
- FIELD ATTACHABLE CPLGS.
- AIR BRAKE HOSE & CPLGS.
- MEGATECH™ C5 HOSE & CPLGS.
- LOW PRESS. HOSE & CPLGS.
- C14 HOSE & CPLGS.
- POLARSEAL® HOSE & CPLGS.
- PWR. STG. HOSE & CPLGS.
- THERMO-PLASTIC HOSE & CPLGS.
- ADAPTERS
- QUICK DISCONNECT CPLGS.
- ACCESSORIES & ASSORTMENTS
- PART NUMBER INDEXES

## Code 61 O-Ring Flange –30° Bent Tube

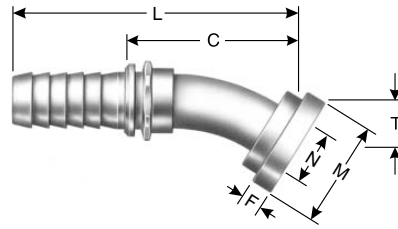

Descr	#		⊕		N	M		T		L		C		F	
			"	mm		"	mm	"	mm	"	mm	"	mm	"	mm
24-24FL30	80343	7305-80345	1-1/2	38.1	1-1/2	2.38	60.5	0.88	22.4	6.34	161.0	3.70	94.0	0.32	8.1
24-32FL30	80344	7305-80365	1-1/2	38.1	2	2.81	71.4	0.88	22.4	6.34	161.0	3.70	94.0	0.38	9.7
32-32FL30	80345	7305-90345	2	50.8	2	2.81	71.4	1.25	31.8	8.23	209.0	4.70	119.4	0.38	9.7

## Code 61 O-Ring Flange –45° Bent Tube

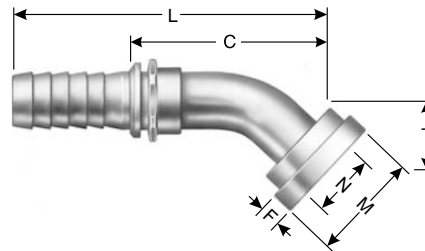

Descr	#		⊕		N	M		T		L		C		F	
			"	mm		"	mm	"	mm	"	mm	"	mm	"	mm
24-24FL45	80353	7305-80445	1-1/2	38.1	1-1/2	2.38	60.5	1.41	35.8	6.53	165.9	3.89	98.8	0.32	8.1
24-32FL45	80354	7305-80465	1-1/2	38.1	2	2.81	71.4	1.14	29.0	6.53	165.9	3.89	98.8	0.38	9.7
32-32FL45	80355	7305-90445	2	50.8	2	2.81	71.4	2.00	50.8	8.51	216.2	4.98	126.5	0.38	9.7

## Code 61 O-Ring Flange –60° Bent Tube

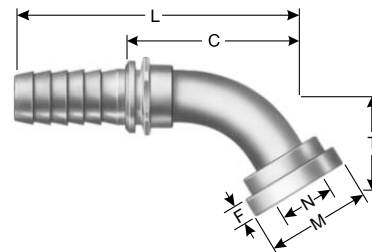

Descr	#		⊕		N	M		T		L		C		F	
			"	mm		"	mm	"	mm	"	mm	"	mm	"	mm
24-24FL60	80363	7305-80645	1-1/2	38.1	1-1/2	2.38	60.5	2.00	50.8	6.57	166.9	3.93	99.8	0.32	8.1
24-32FL60	80364	7305-80665	1-1/2	38.1	2	2.81	71.4	2.00	50.8	6.57	166.9	3.93	99.8	0.38	9.7
32-32FL60	80365	7305-90645	2	50.8	2	2.81	71.4	2.88	73.2	9.01	229.0	5.48	139.2	0.38	9.7

EQUIPMENT
HOSE/CPLG. SELECTION
TECH. DATA
EXT. & VERY HIGH PRESS. HOSE
GS CPLGS.
PCM CPLGS.
PCS CPLGS.
HIGH & MED. PRESS. HOSE
MEGACRIMP® CPLGS.
PC CPLGS.
FIELD ATTACHABLE CPLGS.
AIR BRAKE HOSE & CPLGS.
MEGATECH™/C5 HOSE & CPLGS.
LOW PRESS. HOSE & CPLGS.
C14 HOSE & CPLGS.
POLARSEAL® HOSE & CPLGS.
PWR. STG. HOSE & CPLGS.
THERMO-PLASTIC HOSE & CPLGS.
ADAPTERS
QUICK DISCONNECT CPLGS.
ACCESSORIES & ASSORTMENTS
PART NUMBER INDEXES



# Power Crimp® PC Couplings

## Code 61 O-Ring Flange — 67½° Bent Tube

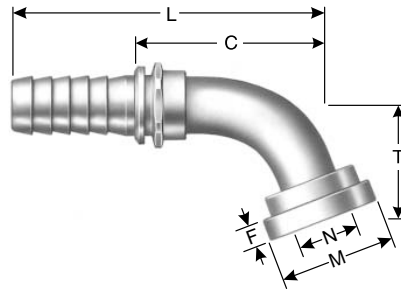

Descr	#		⊕		N		M		T		L		C		F	
			"	mm	"	mm	"	mm	"	mm	"	mm	"	mm	"	mm
MEGACRIMP® CPLGS.	24-24FL67	80373	7305-80745	1-1/2	38.1	1-1/2	2.38	60.5	2.00	50.8	6.53	165.9	3.89	98.8	0.32	8.1
	24-32FL67	80374	7305-80765	1-1/2	38.1	2	2.81	71.4	2.00	50.8	6.53	165.9	3.89	98.8	0.38	9.7
PC CPLGS.	32-32FL67	80375	7305-90745	2	50.8	2	2.81	71.4	3.25	82.6	8.98	228.1	5.45	138.4	0.38	9.7

## Code 61 O-Ring Flange — 90° Bent Tube

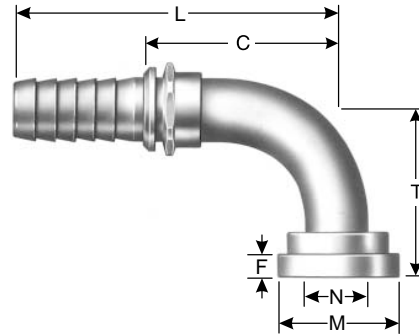

Descr	#		⊕		N		M		T		L		C		F	
			"	mm	"	mm	"	mm	"	mm	"	mm	"	mm	"	mm
PWR. STG. HOSE & CPLGS.	24-24FL90	80383	7305-80945	1-1/2	38.1	1-1/2	2.38	60.5	3.12	79.3	6.19	157.2	3.55	90.2	0.32	8.1
	24C2-24FL90L	80387	7305-80955	1-1/2	38.1	1-1/2	2.38	60.5	4.00	101.6	6.19	157.2	3.55	90.2	0.32	8.1
THERMO-PLASTIC HOSE & CPLGS.	24-32FL90	80384	7305-80965	1-1/2	38.1	2	2.81	71.4	3.12	79.3	6.19	157.2	3.55	90.2	0.38	9.7
	32-32FL90	80385	7305-90945	2	50.8	2	2.81	71.4	4.50	114.3	8.51	216.2	4.98	126.5	0.38	9.7
	32C2-40FL90	80310	7334-08255	2	50.8	2-1/2	3.31	84.1	4.50	114.3	8.51	216.2	4.98	126.5	0.38	9.7

- EQUIPMENT
- HOSE/CPLG. SELECTION
- TECH. DATA
- EXT. & VERY HIGH PRESS. HOSE
- GS CPLGS.
- PCM CPLGS.
- PCS CPLGS.
- HIGH & MED. PRESS. HOSE
- MEGACRIMP® CPLGS.
- PC CPLGS.
- FIELD ATTACHABLE CPLGS.
- AIR BRAKE HOSE & CPLGS.
- MEGATECH™/C5 HOSE & CPLGS.
- LOW PRESS. HOSE & CPLGS.
- C14 HOSE & CPLGS.
- POLARSEAL® HOSE & CPLGS.
- PWR. STG. HOSE & CPLGS.
- THERMO-PLASTIC HOSE & CPLGS.
- ADAPTERS
- QUICK DISCONNECT CPLGS.
- ACCESSORIES & ASSORTMENTS
- PART NUMBER INDEXES

## Hose Length Extender

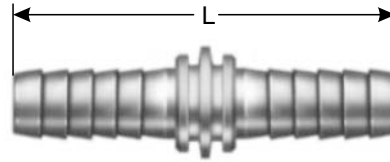

Descr	#		⊕		L	
			"	mm	"	mm
32-32HLE	80179	7334-42435	2	50.8	5.17	131.3

## Female DIN 24° Cone Swivel – Light Series

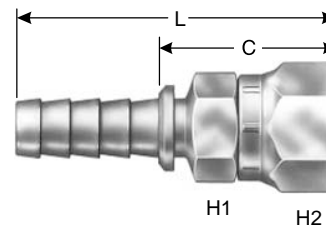
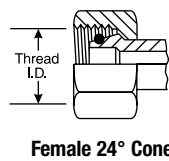

Descr	#		⊕		🌀	⊕	H1	H2	L		C	
			"	mm					"	mm	"	mm
3C2-6FDLX	83709	7303-08195	3/16	4.8	M12X1.5	6.0	14.0	14.0	2.20	55.9	1.11	28.2
24C2-42FDLX	83788	7303-08285	1-1/2	38.1	M52X2.0	42.0	50.0	65.0	5.04	128.0	2.40	61.0

## Female DIN 24° Cone Swivel – Light Series – 90° Bent Tube

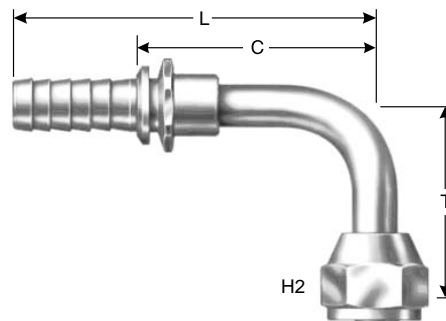
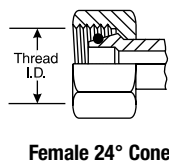

Descr	#		⊕		🌀	⊕	H2	T	L		C		
			"	mm					"	mm	"	mm	
3C2-6FDLX90	83740	7303-08205	3/16	4.8	M12X1.5	6.0	14.0	1.26	32.0	2.52	64.0	1.43	36.3

EQUIPMENT

HOSE/CPLG. SELECTION

TECH. DATA

EXT. &amp; VERY HIGH PRESS. HOSE

GS CPLGS.

PCM CPLGS.

PCS CPLGS.

HIGH &amp; MED. PRESS. HOSE

MEGACRIMP® CPLGS.

PC CPLGS.

FIELD ATTACHABLE CPLGS.

AIR BRAKE HOSE &amp; CPLGS.

MEGATECH™/C5 HOSE &amp; CPLGS.

LOW PRESS. HOSE &amp; CPLGS.

C14 HOSE &amp; CPLGS.

POLARSEAL® HOSE &amp; CPLGS.

PWR. STG. HOSE &amp; CPLGS.

THERMO-PLASTIC HOSE &amp; CPLGS.

ADAPTERS

QUICK DISCONNECT CPLGS.

ACCESSORIES &amp; ASSORTMENTS

PART NUMBER INDEXES



# Power Crimp® PC Couplings

EQUIPMENT
HOSE/CPLG. SELECTION
TECH. DATA
EXT. & VERY HIGH PRESS. HOSE
GS CPLGS.
PCM CPLGS.
PCS CPLGS.
HIGH & MED. PRESS. HOSE
MEGACRIMP® CPLGS.
<b>PC CPLGS.</b>
FIELD ATTACHABLE CPLGS.
AIR BRAKE HOSE & CPLGS.
MEGATECH™ C5 HOSE & CPLGS.
LOW PRESS. HOSE & CPLGS.
C14 HOSE & CPLGS.
POLARSEAL® HOSE & CPLGS.
PWR. STG. HOSE & CPLGS.
THERMO-PLASTIC HOSE & CPLGS.
ADAPTERS
QUICK DISCONNECT CPLGS.
ACCESSORIES & ASSORTMENTS
PART NUMBER INDEXES

## Metric Stand Pipe

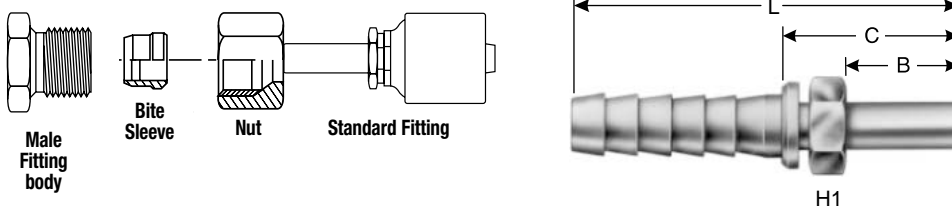

Descr	#		⌀		H1	L		C		B		
			"	mm		mm	mm	"	mm	"	mm	"
24-42MSP	83171	7301-01345	1-1/2	38.1	42.0	50.8	5.03	127.8	2.40	61.0	1.42	36.1

## Metric Bite Nut & Sleeve



Descr	#		⌀	⌀
42MNL	83224	7253-27295	M52X2.0	42.0

Descr	#		⌀
42BS	83194	7253-27005	42.0

## Female Braze-On Stems

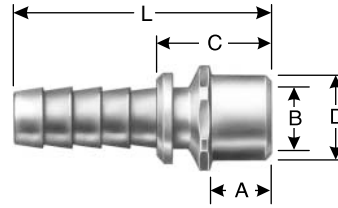

Descr	#		⌀		B	A	D		L		C	
			"	mm			"	mm	"	mm	"	mm
3-4FBO	80410	7305-09135	3/16	4.8	0.25	1/4	0.56	14.2	1.76	44.7	0.68	17.3
4-4FBO	80401	7305-09145	1/4	6.4	0.25	1/4	0.56	14.2	1.67	42.4	0.58	14.7
4-5FBO	80402	7305-09165	1/4	6.4	0.32	3/8	0.56	14.2	1.67	42.4	0.58	14.7
6-6FBO	80403	7334-36755	3/8	9.5	0.38	3/8	0.75	19.1	1.72	43.7	0.70	17.8
6-8FBO	80400	7305-29165	3/8	9.5	0.50	3/8	0.88	22.4	1.72	43.7	0.70	17.8
8-8FBO	80404	7305-39145	1/2	12.7	0.50	3/8	0.88	22.4	2.20	55.9	0.76	19.3
8-10FBO	80405	7305-39165	1/2	12.7	0.63	3/8	0.88	22.4	2.20	55.9	0.76	19.3
12-12FBO	80406	7305-59145	3/4	19.1	0.75	3/8	1.12	28.5	2.47	62.7	0.76	19.3
12-16FBO	80407	7305-59165	3/4	19.1	1.01	15/32	1.38	35.1	2.75	69.9	1.04	26.4
16-16FBO	80408	7305-69145	1	25.4	1.01	15/32	1.38	35.1	2.75	69.9	1.04	26.4
20-20FBO	80409	7305-79145	1-1/4	31.7	1.26	3/8	1.81	46.0	3.29	85.6	1.11	28.2
24-24FBO	80411	7305-89145	1-1/2	38.1	1.51	3/8	2.00	50.8	3.75	95.3	1.11	28.2

## Female Komatsu Style Japanese Metric Swivel

These female swivels have been marked with two small notches on the hex to identify them as the Komatsu style.

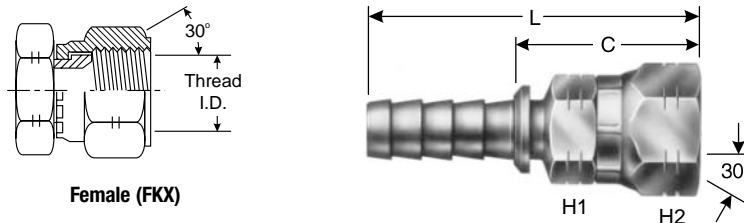

Descr	#		⌀		M	H1	H2	L		C	
			"	mm				"	mm	"	mm
24-24FKX	80239	7303-00705	1-1/2	38.1	M42X1.5	2	2-3/8	5.49	139.5	2.86	72.6

- EQUIPMENT
- HOSE/CPLG. SELECTION
- TECH. DATA
- EXT. & VERY HIGH PRESS. HOSE
- GS CPLGS.
- PCM CPLGS.
- PCS CPLGS.
- HIGH & MED. PRESS. HOSE
- MEGACRIMP® CPLGS.
- PC CPLGS.**
- FIELD ATTACHABLE CPLGS.
- AIR BRAKE HOSE & CPLGS.
- MEGATECH™/C5 HOSE & CPLGS.
- LOW PRESS. HOSE & CPLGS.
- C14 HOSE & CPLGS.
- POLARSEAL® HOSE & CPLGS.
- PWR. STG. HOSE & CPLGS.
- THERMO-PLASTIC HOSE & CPLGS.
- ADAPTERS
- QUICK DISCONNECT CPLGS.
- ACCESSORIES & ASSORTMENTS
- PART NUMBER INDEXES



# Power Crimp® PC Couplings

## Power Crimp One Non-Skive Ferrules (Steel) – PC1FS Series

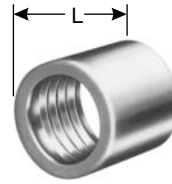

Descr	#		L		O	
			"	mm	"	mm
3PC1FS	80481	7266-07035	1.20	30.5	0.83	21.1
4PC1FS	80482	7266-07045	1.28	32.5	0.87	22.1
5PC1FS	80483	7266-07055	1.20	30.5	0.97	24.6
6PC1FS	80484	7266-07065	1.20	30.5	1.06	26.9
8PC1FS	80485	7266-07085	1.47	37.3	1.15	29.2
16PC1FS	80488	7266-07165	1.69	42.9	1.32	33.5
20PC1FS	80489	7266-07205	2.41	61.2	2.38	60.5
24PC1FS	80491	7266-07245	2.69	68.3	2.69	68.3
32PC1FS	80492	7266-07325	3.56	90.4	3.25	82.6

## Power Crimp One Non-Skive Ferrules (Steel) – PC1F-M2S Series

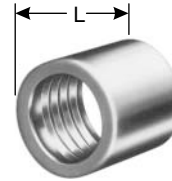

Descr	#		L		O	
			"	mm	"	mm
4PC1F-M2S	80468	7266-07635	1.20	30.5	0.83	21.1
6PC1F-M2S	81512	7266-07375	1.20	30.5	1.06	26.9
8PC1F-M2S	80474	7266-07395	1.47	37.3	1.20	30.5
10PC1F-M2S	80477	7266-07415	1.47	37.3	1.31	33.3
12PC1F-M2S	80475	7266-07435	1.69	42.9	1.57	39.9
16PC1F-M2S	80480	7266-07475	1.69	42.9	1.94	49.3

EQUIPMENT

HOSE/CPLG. SELECTION

TECH. DATA

EXT. & VERY HIGH PRESS. HOSE

GS CPLGS.

PCM CPLGS.

PCS CPLGS.

HIGH & MED. PRESS. HOSE

MEGACRIMP® CPLGS.

PC CPLGS.

FIELD ATTACHABLE CPLGS.

AIR BRAKE HOSE & CPLGS.

MEGATECH™ C5 HOSE & CPLGS.

LOW PRESS. HOSE & CPLGS.

C14 HOSE & CPLGS.

POLARSEAL® HOSE & CPLGS.

PWR. STG. HOSE & CPLGS.

THERMO-PLASTIC HOSE & CPLGS.

ADAPTERS

QUICK DISCONNECT CPLGS.

ACCESSORIES & ASSORTMENTS

PART NUMBER INDEXES



## Power Crimp Two Ferrules (Steel) – PC2F Series

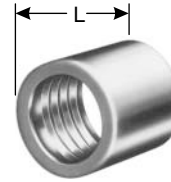

Descr	#		L		Ø	
			"	mm	"	mm
3PC2F-4	80415	7266-00075	1.00	25.4	0.76	19.3
4PC2F-2	80416	7266-00345	1.00	25.4	0.84	21.3
4PC2F-4	80461	7266-00395	1.20	30.5	0.89	22.6
5PC2F-2	80417	7266-00385	1.00	25.4	0.87	22.1
6PC2F-2	80418	7266-00335	1.00	25.4	0.94	23.9
6PC2F-4	80462	7266-00405	1.20	30.5	1.06	26.9
8PC2F-2	80419	7266-00025	1.25	31.8	1.13	28.7
8PC2F-2C	80473	7266-08085	1.47	37.3	1.19	30.2
8PC2F-4	80463	7266-00415	1.47	37.3	1.28	32.5
10PC2F-2B	80476	7266-00465	1.47	37.3	1.32	33.5
10PC2F-2C	80447	7266-08105	1.25	31.8	1.23	31.2
12PC2F-2	80423	7266-00185	1.47	37.3	1.50	38.1
12PC2F-4	80422	7266-00145	1.97	50.0	1.38	35.1
16PC2F-2	80424	7266-00135	1.97	50.0	1.75	44.5
16PC2F-4	80425	7266-00175	2.07	52.6	1.87	47.5
20PC2F-2	80427	7266-00225	2.35	59.7	2.25	57.2
20PC2F-4	80426	7266-00215	2.77	70.4	2.19	55.6
24PC2F-4	80428	7266-00355	2.88	73.2	2.55	64.8
32PC2F-4	80429	7266-00375	3.43	87.1	3.16	80.3

## Power Crimp One Non-Skive Ferrules (Steel) For use with MegaFlex M2T® Hose

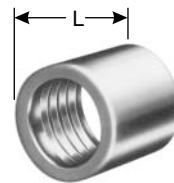

Descr	#		L		Ø	
			"	mm	"	mm
4M3KPC	80584	7266-07805	1.20	30.5	0.89	22.6
6M3KPC	80585	7266-07815	1.20	30.5	0.97	24.6
8M3KPC	80586	7266-07825	1.50	38.1	1.15	29.2
10PC1FS-M3K	80486	7266-07105	1.49	37.8	1.21	30.7
12PC1FS-M3K	80487	7266-07125	1.69	42.9	1.38	35.1

- EQUIPMENT
- HOSE/CPLG. SELECTION
- TECH. DATA
- EXT. & VERY HIGH PRESS. HOSE
- GS CPLGS.
- PCM CPLGS.
- PCS CPLGS.
- HIGH & MED. PRESS. HOSE
- MEGACRIMP® CPLGS.
- PC CPLGS.**
- FIELD ATTACHABLE CPLGS.
- AIR BRAKE HOSE & CPLGS.
- MEGATECH™/C5 HOSE & CPLGS.
- LOW PRESS. HOSE & CPLGS.
- C14 HOSE & CPLGS.
- POLARSEAL® HOSE & CPLGS.
- PWR. STG. HOSE & CPLGS.
- THERMO-PLASTIC HOSE & CPLGS.
- ADAPTERS
- QUICK DISCONNECT CPLGS.
- ACCESSORIES & ASSORTMENTS
- PART NUMBER INDEXES



# Field Attachable "Type T" Couplings - G27 Series

## For G1 Hose (1-Wire)

### Male Pipe (NPTF – 30° Cone Seat)

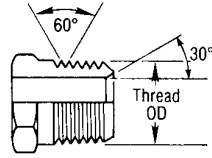

NPTF Solid Male (MP)

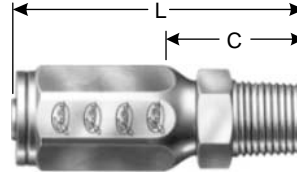

H1

Descr	#			⊖		🌀	H1		L		C	
				"	mm		"	"	"	mm	"	mm
MEGACRIMP® CPLGS.	4C1T-2RMP	81241	G27100-0402	7231-81241	1/4	4.8	1/8-27	1/2	2.30	58.4	1.29	32.8
	4C1T-4RMP	81210	G27100-0404	7231-81210	1/4	4.6	1/4-18	9/16	2.52	64.0	1.51	38.4
PC CPLGS.	6C1T-4RMP	81242	G27100-0604	7231-81242	3/8	9.5	1/4-18	9/16	2.68	68.1	1.54	39.1
	6C1T-6RMP	81211	G27100-0606	7231-81211	3/8	9.5	3/8-18	11/16	2.53	64.3	1.39	35.3
FIELD ATTACHABLE CPLGS.	8C1T-6RMP	81243	G27100-0806	7231-81243	1/2	12.7	3/8-18	11/16	3.05	77.5	1.70	43.2
	8C1T-8RMP	81212	G27100-0808	7231-81212	1/2	12.7	1/2-14	7/8	3.06	77.7	1.71	43.4
	8C1T-12RMP	81244	G27100-0812	7231-81244	1/2	12.7	3/4-14	1 1/16	3.13	79.5	1.87	47.5
AIR BRAKE HOSE & CPLGS.	12C1T-12RMP	81213	G27100-1212	7231-81213	3/4	19.1	3/4-14	1 1/16	3.19	81.0	1.73	43.9
	16C1T-16RMP	81214	G27100-1616	7231-81214	1	25.4	1-11 1/2	1 3/8	3.78	96.0	2.10	53.3

### Male Pipe Swivel (NPTF – Without 30° Cone Seat)

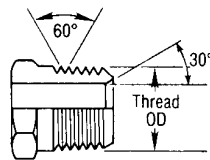

NPTF Solid Male (MP)

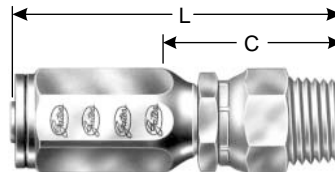

H1 H2

Descr	#			⊖		🌀	H1	H2	L		C		
				"	mm		"	"	"	mm	"	mm	
PWR. STG. HOSE & CPLGS.	4C1T-4RMPX	81185	G27105-0404	7231-22445	1/4	4.6	1/4-18	7/16	11/16	3.18	80.8	2.17	55.1
	6C1T-6RMPX	81186	G27105-0606	7231-22455	3/8	9.5	3/8-18	5/8	7/8	3.51	89.2	2.23	56.6
THERMO- PLASTIC HOSE & CPLGS.	8C1T-8RMPX	81187	G27105-0808	7231-22465	1/2	12.7	1/2-14	3/4	1	3.99	101.3	2.63	66.8
	12C1T-12RMPX	81188	G27105-1212	7231-22475	3/4	19.1	3/4-14	1 1/16	1 5/16	4.27	108.5	2.73	69.3

## For G1 Hose (1-Wire)

### Male O-Ring Boss

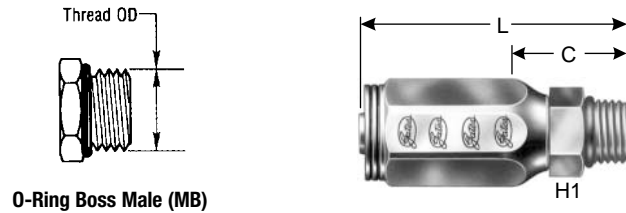

O-Ring Boss Male (MB)

Descr	#			⌀		🌀	H1		L		C	
				"	mm		"	"	"	mm	"	mm
6C1T-6RMB	81181	G27120-0606	7231-22255	3/8	9.5	9/16-18	11/16	2.52	64.0	1.24	31.5	
6C1T-8RMB	81182	G27120-0608	7231-22265	3/8	9.5	3/4-16	7/8	2.59	65.8	1.32	33.5	
8C1T-8RMB	81183	G27120-0808	7231-22275	1/2	12.7	3/4-16	7/8	2.87	72.9	1.52	38.6	
8C1T-10RMB	81184	G27120-0810	7231-22285	1/2	12.7	7/8-14	1	3.11	79.0	1.76	44.7	

### Male JIC 37° Flare

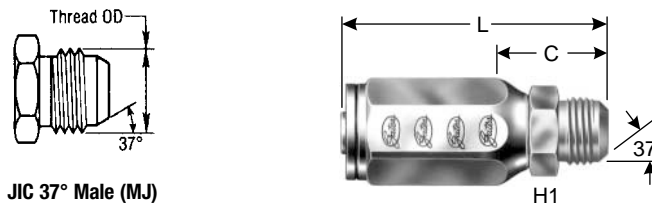

JIC 37° Male (MJ)

Descr	#			⌀		🌀	H1		L		C	
				"	mm		"	"	"	mm	"	mm
6C1T-6RMJ	81177	G27165-0606	7231-22185	3/8	9.5	9/16-18	9/16	2.68	68.1	1.40	35.6	
8C1T-8RMJ	81178	G27165-0808	7231-22195	1/2	12.7	3/4-16	3/4	3.05	77.5	1.70	43.2	
8C1T-10RMJ	81179	G27165-0810	7231-22205	1/2	12.7	7/8-14	7/8	3.31	84.1	1.96	49.8	
12C1T-12RMJ	81180	G27165-1212	7231-22215	3/4	19.1	1 1/16-12	1 1/16	3.52	89.4	1.98	50.3	

### Female JIC 37° Flare Swivel

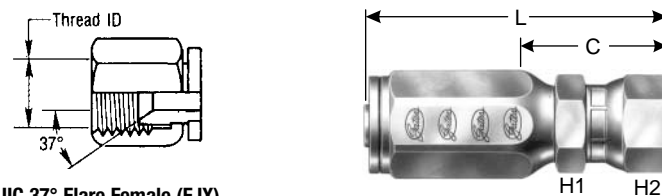

JIC 37° Flare Female (FJX)

Descr	#			⌀		🌀	H1		H2		L		C	
				"	mm		"	"	"	mm	"	mm		
4C1T-4RFJX	81215	G27170-0404	7231-81215	1/4	6.4	7/16-20	9/16	9/16	2.47	62.7	1.46	37.1		
4C1T-5RFJX	81216	G27170-0405	7231-81216	1/4	6.4	1/2-20	11/16	11/16	2.58	65.5	1.57	39.9		
6C1T-6RFJX	81217	G27170-0606	7231-81217	3/8	9.5	9/16-18	3/4	3/4	2.80	71.1	1.65	41.9		
6C1T-8RFJX	81218	G27170-0608	7231-81218	3/8	9.5	3/4-16	3/4	7/8	2.91	73.9	1.76	44.7		
8C1T-8RFJX	81219	G27170-0808	7231-81219	1/2	12.7	3/4-16	13/16	7/8	3.24	82.3	1.89	48.0		
8C1T-10RFJX	81220	G27170-0810	7231-81220	1/2	12.7	7/8-14	13/16	1 1/16	3.34	84.8	1.99	50.5		
12C1T-12RFJX	81221	G27170-1212	7231-81221	3/4	19.1	1 1/16-12	1 1/8	1 1/4	3.45	87.6	1.91	48.5		
16C1T-16RFJX	81222	G27170-1616	7231-81222	1	25.4	1 5/16-12	1 3/8	1 1/2	3.90	99.1	2.22	56.4		

EQUIPMENT
HOSE/CPLG. SELECTION
TECH. DATA
EXT. & VERY HIGH PRESS. HOSE
GS CPLGS.
PCM CPLGS.
PCS CPLGS.
HIGH & MED. PRESS. HOSE
MEGACRIMP® CPLGS.
PC CPLGS.
FIELD ATTACHABLE CPLGS.
AIR BRAKE HOSE & CPLGS.
MEGATECH™/C5 HOSE & CPLGS.
LOW PRESS. HOSE & CPLGS.
C14 HOSE & CPLGS.
POLARSEAL® HOSE & CPLGS.
PWR. STG. HOSE & CPLGS.
THERMO-PLASTIC HOSE & CPLGS.
ADAPTERS
QUICK DISCONNECT CPLGS.
ACCESSORIES & ASSORTMENTS
PART NUMBER INDEXES



# Field Attachable "Type T" Couplings - G27 Series

## For G1 Hose (1-Wire)

### Female JIC 37° Flare Swivel – 45° Bent Tube

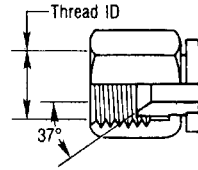

JIC 37° Flare Female (FJX)

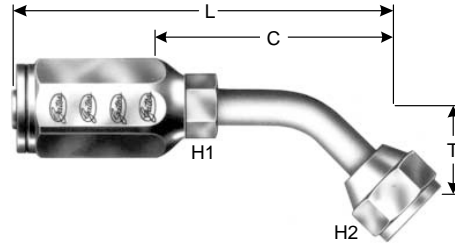

Descr	#			⊖		🌀	H1	H2	T		L		C	
				"	mm		"	"	"	mm	"	mm	"	mm
4C1T-4RFJX45	81189	G27175-0404	7231-22545	1/4	6.4	7/16-20	3/8	9/16	0.33	8.4	2.80	71.1	1.79	45.5
6C1T-6RFJX45	81190	G27175-0606	7231-22555	3/8	9.5	9/16-18	1/2	11/16	0.39	9.9	3.37	85.6	1.79	45.5
8C1T-8RFJX45	81191	G27175-0808	7231-22565	1/2	12.7	3/4-16	5/8	7/8	0.55	14.0	4.11	104.4	2.10	53.3
12C1T-12RFJX45	81192	G27175-1212	7231-22575	3/4	19.1	1 1/16-12	7/8	1 1/4	0.78	19.8	4.70	119.4	3.16	80.3

### Female JIC 37° Flare Swivel – 90° Bent Tube

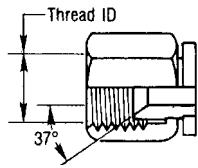

JIC 37° Flare Female (FJX)

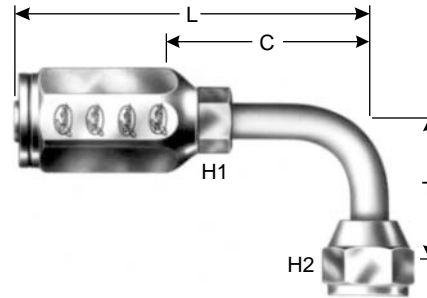

Descr	#			⊖		🌀	H1	H2	T		L		C	
				"	mm		"	"	"	mm	"	mm	"	mm
4C1T-4RFJX90	81193	G27180-0404	7231-22655	1/4	6.4	7/16-20	9/16	9/16	0.68	17.3	2.69	68.3	1.68	42.7
6C1T-6RFJX90	81194	G27180-0606	7231-22665	3/8	9.5	9/16-18	11/16	11/16	0.85	21.6	3.28	83.3	2.00	50.8
6C1T-8RFJX90	81195	G27180-0608	7231-22675	3/8	9.5	3/4-16	5/8	7/8	1.09	27.7	3.58	90.9	2.31	58.7
8C1T-8RFJX90	81196	G27180-0808	7231-22685	1/2	12.7	3/4-16	7/8	7/8	1.09	27.7	3.86	98.0	2.51	63.8
8C1T-10RFJX90	81197	G27180-0810	7231-22695	1/2	12.7	7/8-14	3/4	1	1.23	31.2	3.92	99.6	2.59	65.8
12C1T-12RFJX90	81198	G27180-1212	7231-22705	3/4	19.1	1 1/16-12	1 1/4	1 1/4	1.82	46.2	4.59	116.6	3.05	77.5

EQUIPMENT  
HOSE/CPLG. SELECTION  
TECH. DATA  
EXT. & VERY HIGH PRESS. HOSE  
GS CPLGS.  
PCM CPLGS.  
PCS CPLGS.  
HIGH & MED. PRESS. HOSE  
FIELD ATTACHABLE CPLGS.  
AIR BRAKE HOSE & CPLGS.  
MEGATECH™ C5 HOSE & CPLGS.  
LOW PRESS. HOSE & CPLGS.  
C14 HOSE & CPLGS.  
POLARSEAL® HOSE & CPLGS.  
PWR. STG. HOSE & CPLGS.  
THERMO-PLASTIC HOSE & CPLGS.  
ADAPTERS  
QUICK DISCONNECT CPLGS.  
ACCESSORIES & ASSORTMENTS  
PART NUMBER INDEXES

## For G2 Hose (2-Wire)

### Male Pipe (NPTF – 30° Cone Seat)

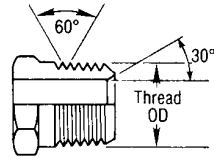

NPTF Solid Male (MP)

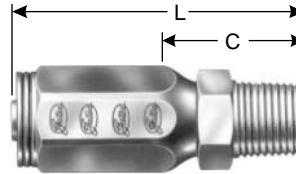

H1

Descr	#			⊖		🌀	H1			L		C	
				"	mm		"	"	mm	"	mm		
4C2AT-2RMP	81247	G28100-0402	7231-81247	1/4	6.4	1/8-27	1/2	2.30	58.4	1.23	31.2		
4C2AT-4RMP	81223	G28100-0404	7231-81223	1/4	6.4	1/4-18	9/16	2.52	64.0	1.45	36.8		
6C2AT-4RMP	81248	G28100-0604	7231-81248	3/8	9.5	1/4-18	9/16	2.68	68.1	1.45	36.8		
6C2AT-6RMP	81224	G28100-0606	7231-81224	3/8	9.5	3/8-18	11/16	2.53	64.3	1.30	33.0		
8C2AT-6RMP	81249	G28100-0806	7231-81249	1/2	12.7	3/8-18	11/16	3.05	77.5	1.63	41.4		
8C2AT-8RMP	81225	G28100-0808	7231-81225	1/2	12.7	1/2-14	7/8	3.06	77.7	1.64	41.7		
8C2AT-12RMP	81251	G28100-0812	7231-81251	1/2	12.7	3/4-14	1 1/16	3.13	79.5	1.71	43.4		
12C2AT-12RMP	81226	G28100-1212	7231-81226	3/4	19.1	3/4-14	1 1/16	3.19	81.0	1.65	41.9		
16C2AT-16RMP	81227	G28100-1616	7231-81227	1	25.4	1-11 1/2	1 3/8	3.78	96.0	2.04	51.8		
20C2AT-20RMP	81228	G28100-2020	7231-81228	1 1/4	31.7	1 1/4-11 1/2	1 3/4	4.59	116.6	2.49	63.2		
24C2AT-24RMP	81252	G28100-2424	7231-81252	1 1/2	38.1	1 1/2-11 1/2	2	5.18	131.6	2.68	68.1		

### Male Pipe Swivel (NPTF – Without 30° Cone Seat)

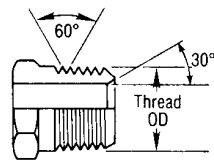

NPTF Solid Male (MP)

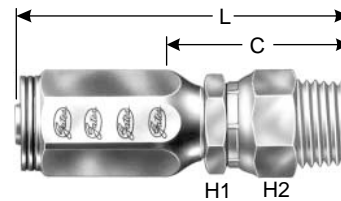

H1 H2

Descr	#			⊖		🌀	H1 H2		L		C	
				"	mm		"	"	"	mm	"	mm
4C2AT-4RMPX	81350	G28105-0404	7231-22495	1/4	6.4	1/4-18	7/16	11/16	3.18	80.8	2.11	53.6
6C2AT-6RMPX	81351	G28105-0606	7231-22505	3/8	9.5	3/8-18	5/8	7/8	3.51	89.2	2.27	57.7
8C2AT-8RMPX	81352	G28105-0808	7231-22515	1/2	12.7	1/2-14	3/4	1	3.99	101.3	2.56	65.0
12C2AT-12RMPX	81353	G28105-1212	7231-22525	3/4	19.1	3/4-14	1 1/16	1 5/16	4.27	108.5	2.73	69.3

EQUIPMENT

HOSE/CPLG. SELECTION

TECH. DATA

EXT. & VERY HIGH PRESS. HOSE

GS CPLGS.

PCM CPLGS.

PCS CPLGS.

HIGH & MED. PRESS. HOSE

MEGACRIMP® CPLGS.

PC CPLGS.

FIELD ATTACHABLE CPLGS.

AIR BRAKE HOSE & CPLGS.

MEGATECH™/C5 HOSE & CPLGS.

LOW PRESS. HOSE & CPLGS.

C14 HOSE & CPLGS.

POLARSEAL® HOSE & CPLGS.

PWR. STG. HOSE & CPLGS.

THERMO-PLASTIC HOSE & CPLGS.

ADAPTERS

QUICK DISCONNECT CPLGS.

ACCESSORIES & ASSORTMENTS

PART NUMBER INDEXES



# Field Attachable "Type T" Couplings - G28 Series

## For G2 Hose (2-Wire)

### Male O-Ring Boss

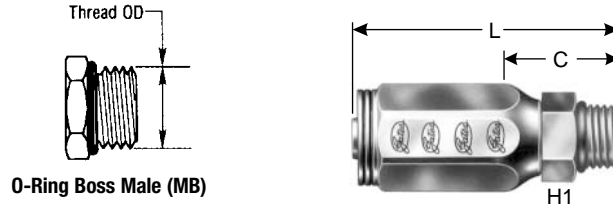

O-Ring Boss Male (MB)

Descr	#			⊕		🌀	H1	L		C	
				"	mm		"	"	mm	"	mm
6C2AT-6RMB	81346	G28120-0606	7231-22355	3/8	9.5	9/16-18	11/16	2.52	64.0	1.28	32.5
6C2AT-8RMB	81347	G28120-0608	7231-22365	3/8	9.5	3/4-16	7/8	2.59	65.8	1.36	34.5
8C2AT-8RMB	81348	G28120-0808	7231-22375	1/2	12.7	3/4-16	7/8	2.87	72.9	1.45	36.8
8C2AT-10RMB	81349	G28120-0810	7231-22385	1/2	12.7	7/8-14	1	3.11	79.0	1.59	40.4

### Male JIC 37° Flare

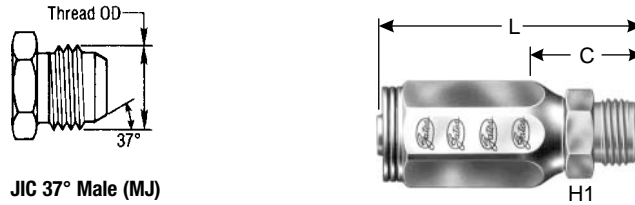

JIC 37° Male (MJ)

Descr	#			⊕		🌀	H1	L		C	
				"	mm		"	"	mm	"	mm
6C2AT-6RMJ	81342	G28165-0606	7231-22025	3/8	9.5	9/16-18	9/16	2.68	68.1	1.45	36.8
8C2AT-8RMJ	81343	G28165-0808	7231-22045	1/2	12.7	3/4-16	3/4	3.05	77.5	1.63	41.4
8C2AT-10RMJ	81344	G28165-0810	7231-22055	1/2	12.7	7/8-14	7/8	3.31	84.1	1.89	48.0
12C2AT-12RMJ	81345	G28165-1212	7231-22065	3/4	19.1	1 1/16-12	1 1/16	3.52	89.4	1.98	50.3

EQUIPMENT
HOSE/CPLG. SELECTION
TECH. DATA
EXT. & VERY HIGH PRESS. HOSE
GS CPLGS.
PCM CPLGS.
PCS CPLGS.
HIGH & MED. PRESS. HOSE
MEGACRIMP® CPLGS.
PC CPLGS.
FIELD ATTACHABLE CPLGS.
AIR BRAKE HOSE & CPLGS.
MEGATECH™ C5 HOSE & CPLGS.
LOW PRESS. HOSE & CPLGS.
C14 HOSE & CPLGS.
POLARSEAL® HOSE & CPLGS.
PWR. STG. HOSE & CPLGS.
THERMO-PLASTIC HOSE & CPLGS.
ADAPTERS
QUICK DISCONNECT CPLGS.
ACCESSORIES & ASSORTMENTS
PART NUMBER INDEXES

## For G2 Hose (2-Wire)

### Female JIC 37° Flare Swivel

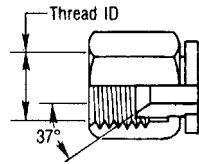

JIC 37° Flare Female (FJX)

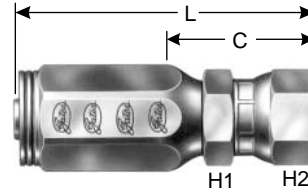

Descr	#			⊖		🌀	H1	H2	L		C	
				"	mm		"	"	"	mm	"	mm
4C2AT-4RFJX	81229	G28170-0404	7231-81229	1/4	6.4	7/16-20	9/16	9/16	2.47	62.7	1.40	35.6
4C2AT-5RFJX	81230	G28170-0405	7231-81230	1/4	6.4	1/2-20	11/16	11/16	2.58	65.5	1.57	39.9
6C2AT-6RFJX	81231	G28170-0606	7231-81231	3/8	9.5	9/16-18	3/4	3/4	2.80	71.1	1.56	39.6
6C2AT-8RFJX	81232	G28170-0608	7231-81232	3/8	9.5	3/4-16	3/4	3/4	2.91	73.9	1.67	42.4
8C2AT-8RFJX	81233	G28170-0808	7231-81233	1/2	12.7	3/4-16	13/16	7/8	3.24	82.3	1.82	46.2
8C2AT-10RFJX	81234	G28170-0810	7231-81234	1/2	12.7	7/8-14	13/16	1 1/16	3.34	84.8	1.92	48.8
12C2AT-12RFJX	81235	G28170-1212	7231-81235	3/4	19.1	1 1/16-12	1 1/8	1 _	3.45	87.6	1.91	48.5
16C2AT-16RFJX	81236	G28170-1616	7231-81236	1	25.4	1 5/16-12	1 3/8	1 1/2	3.90	99.1	2.16	54.9
20C2AT-20RFJX	81237	G28170-2020	7231-81237	1 1/4	31.7	1 5/16-12	1 7/8	2	4.85	123.2	2.74	69.6
24C2AT-24RFJX	81254	G28170-2424	7231-81254	1 1/2	38.1	1 7/8-12	2 1/8	2 1/4	5.26	133.6	2.76	70.1

### Female JIC 37° Flare Swivel – 45° Bent Tube

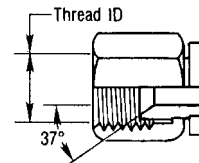

JIC 37° Flare Female (FJX)

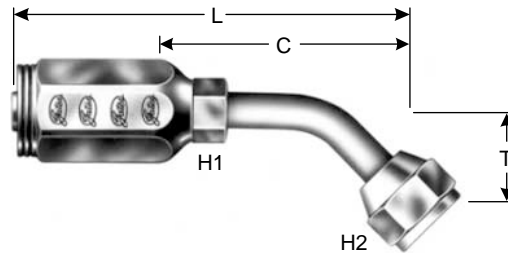

Descr	#			⊖		🌀	H1	H2	T		L		C	
				"	mm		"	"	"	mm	"	mm	"	mm
4C2AT-4RFJX45	81354	G28175-0404	7231-22595	1/4	6.4	7/16-20	3/8	9/16	0.33	8.4	2.80	71.1	1.73	43.9
6C2AT-6RFJX45	81355	G28175-0606	7231-22605	3/8	9.5	9/16-18	1/2	11/16	0.39	9.9	3.37	85.6	2.14	54.4
8C2AT-8RFJX45	81356	G28175-0808	7231-22615	1/2	12.7	3/4-16	5/8	7/8	0.55	14.0	4.11	104.4	2.68	68.1
12C2AT-12RFJX45	81357	G28175-1212	7231-22625	3/4	19.1	1 1/16-12	7/8	1 1/4	0.78	19.8	4.70	119.4	3.16	80.3

EQUIPMENT

HOSE/CPLG. SELECTION

TECH. DATA

EXT. & VERY HIGH PRESS. HOSE

GS CPLGS.

PCM CPLGS.

PCS CPLGS.

HIGH & MED. PRESS. HOSE

MEGACRIMP® CPLGS.

PC CPLGS.

FIELD ATTACHABLE CPLGS.

AIR BRAKE HOSE & CPLGS.

MEGATECH™/C5 HOSE & CPLGS.

LOW PRESS. HOSE & CPLGS.

C14 HOSE & CPLGS.

POLARSEAL® HOSE & CPLGS.

PWR. STG. HOSE & CPLGS.

THERMO-PLASTIC HOSE & CPLGS.

ADAPTERS

QUICK DISCONNECT CPLGS.

ACCESSORIES & ASSORTMENTS

PART NUMBER INDEXES



# Field Attachable "Type T" Couplings - G28 Series

## For G2 Hose (2-Wire)

### Female JIC 37° Flare Swivel – 90° Bent Tube

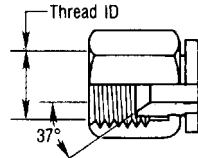

JIC 37° Flare Female (FJX)

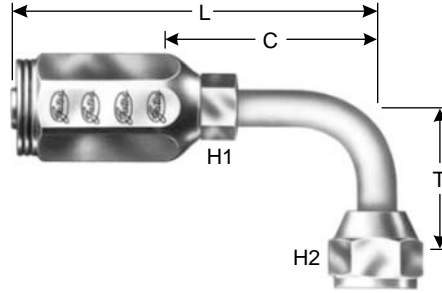

Descr	#			⊕		🌀	H1	H2	T		L		C	
				"	mm		"	"	"	mm	"	mm	"	mm
4C2AT-4RFJX90	81358	G28180-0404	7231-22755	1/4	6.4	7/16-20	3/8	9/16	0.68	17.3	2.69	68.3	1.62	41.1
6C2AT-6RFJX90	81359	G28180-0606	7231-22765	3/8	9.5	9/16-18	1/2	11/16	0.85	21.6	3.28	83.3	2.04	51.8
6C2AT-8RFJX90	81360	G28180-0608	7231-22775	3/8	9.5	3/4-16	5/8	7/8	1.09	27.7	3.58	90.9	2.35	59.7
8C2AT-8RFJX90	81361	G28180-0808	7231-22785	1/2	12.7	3/4-16	5/8	7/8	1.09	27.7	3.86	98.0	2.42	61.5
8C2AT-10RFJX90	81362	G28180-0810	7231-22795	1/2	12.7	7/8-14	3/4	1	1.23	31.2	3.92	99.6	2.50	63.5
12C2AT-12RFJX90	81363	G28180-1212	7231-22805	3/4	19.1	1 1/16-12	7/8	1 1/4	1.82	46.2	4.59	116.6	3.05	77.5

EQUIPMENT
HOSE/CPLG. SELECTION
TECH. DATA
EXT. & VERY HIGH PRESS. HOSE
GS CPLGS.
PCM CPLGS.
PCS CPLGS.
HIGH & MED. PRESS. HOSE
MEGACRIMP® CPLGS.
PC CPLGS.
FIELD ATTACHABLE CPLGS.
AIR BRAKE HOSE & CPLGS.
MEGATECH™ C5 HOSE & CPLGS.
LOW PRESS. HOSE & CPLGS.
C14 HOSE & CPLGS.
POLARSEAL® HOSE & CPLGS.
PWR. STG. HOSE & CPLGS.
THERMO-PLASTIC HOSE & CPLGS.
ADAPTERS
QUICK DISCONNECT CPLGS.
ACCESSORIES & ASSORTMENTS
PART NUMBER INDEXES