



Drain Cleaning & Plumbing Tools

INNOVATIVE DRAIN CLEANING SOLUTIONS



Innovation in Action

Cobra Products, Inc. has been a leading manufacturer of innovative drain cleaning tools and power machines for over 30 years. Unique, innovative designs are the hallmark of our Plumbing & Drain Cleaning Tool product lines with important advantages for you and your customer.

- Durable, high quality construction
- Environmentally conscientious
- Operational safety
- Ease of use

To learn more about Cobra Products Inc., please visit www.cobraus.com.



Table of Contents

Drain Cleaning Power Machines	2
<hr/>	
10 Series, 20 Series, 40 Series, 4500 Series & 650 Series	
Drain Cleaning Hand Tools	6
<hr/>	
Flat Tapes, Power Snakes, Drain Pipe Augers, Toilet Augers, Flat Sewer Rods, Encased Sewer Rods, Sink Cleaners, Drum Augers, Zip-It® Tool & Bladders	
Plungers	11
<hr/>	
Plungers, Universal Plunger Caddy, Air Drain Blaster & Plunge-It™	
Home Maintenance	14
<hr/>	
Dryer Lint Trap Brush, Appliance Brush & Dryer Vent Brush	
Tubing Tools	15
<hr/>	
Tubing & Pipe Cutters, Flaring Tools, Tube Benders & Bending Springs, Swaging & Tube Finishing Tools	
Drainage Tools	18
<hr/>	
Garbage Disposal, Slip Nut, Lock Nut, Adjustable & P.O. Plug Wrenches, Tub & Basket Strainer Wrenches	
Faucet & Sink Tools	20
<hr/>	
Basin Wrenches, Faucet Seat Wrenches, Handle Pullers, Reseating Tools & Shower Valve Socket Wrenches	
Hand Saws	22
<hr/>	
Cable, PVC & Hacksaws	
Specialty Plumbing Tools	23
<hr/>	
Nipple Extractors, Internal Pipe & Strap Wrenches & Sillcock Keys	



DRAIN CLEANING POWER MACHINES

10 SERIES • Cleans 3/4" - 3" lines up to 50' For Most Sinks, Showers & Tub Drains

- FEATURES:**
- High-torque, double insulated, variable speed drill motor
 - Heavy-gauge steel inner drum prevents cable tangling
 - One piece corrosion-resistant molded rest shield
 - Music wire cable

Item # 90010 Includes: 1/4" x 25' Open Hook Cable

Item # 90011 Includes: 1/4" x 50' Open Hook Cable



Item #	Description	Case Pack / Wt.		Item UPC#	Case Pack Dimensions
90010	1/4" x 25' Cable Drum Machine	1	14	088712900108	20" x 10" x 10"
90011	1/4" x 50' Cable Drum Machine	1	18	088712900115	20" x 10" x 10"
Replacement Cables					
90110	1/4" x 25' Replacement Cable	1	4	088712901105	11" x 11" x 2"
90111	1/4" x 50' Replacement Cable	1	7	088712901112	11" x 11" x 2"
Replacement Drill Motor					
99323	Replacement Drill Motor	1	5	088712993230	11" x 11" x 3"

110ES SERIES • Cleans 3/4" - 3" lines For Most Sinks, Showers & Tub Drains

- FEATURES:**
- Double insulated, variable speed drill motor
 - Music wire w/high impact, rust proof plastic drum

Item # ST-110ES Includes: 1/4" x 25' Open Hook Cable

Item # ST-120ES Includes: 1/4" x 35' Open Hook Cable

Item # ST-130ES Includes: 3/8" x 25' Slotted End Cable



Item #	Description	Case Pack / Wt.		Item UPC#	Case Pack Dimensions
ST-110ES	1/4" x 25' Electric Spinner	1	14	088712110002	20" x 13" x 16"
ST-120ES	1/4" x 35' Electric Spinner	1	18	088712120001	20" x 13" x 16"
ST-130ES	3/8" x 25' Electric Spinner	1	14	088712130000	20" x 13" x 16"
Replacement Cables					
90110	1/4" x 25' Replacement Cable	1	4	088712901105	11" x 11" x 2"
ST-96102	1/4" x 35' Replacement Cable	1	8	088712961024	11" x 11" x 2"
ST-96109	3/8" x 25' Replacement Cable	1	7	088712961093	11" x 11" x 2"
Parts & Accessories					
99323	Replacement Drill Motor	1	5	088712993230	11" x 11" x 3"



DRAIN CLEANING POWER MACHINES

20 SERIES • 1/4" Cleans 3/4" - 3" lines up to 50' 5/16" Cleans 1" - 3" lines up to 50'

For Most Sinks, Showers & Tub Drains

- FEATURES:**
- High-torque, double insulated, variable speed drill motor
 - Industrial grade pneumatic foot switch
 - Rugged 9" rotational molded drum with quick drum release
 - Contour welded steel tubular frame construction
 - Music wire cable

Item # 90020 Includes: 1/4" x 50' Open Hook Cable

Item # ST-260 Includes: 5/16" x 50' Open Hook Cable



Item #	Description	Case Pack / Wt.		Item UPC#	Case Pack Dimensions
90020	1/4" x 50' Cable Drum Machine	1	25	088712900207	20" x 13" x 16"
ST-260	5/16" x 50' Cable Drum Machine	1	27	088712960263	20" x 13" x 16"
Replacement Cables					
90111	1/4" x 50' Replacement Cable	1	7	088712901112	11" x 11" x 2"
ST-96106	5/16" x 50' Replacement Cable	1	9	088712961062	11" x 11" x 2"
Parts & Accessories					
99300	Air Actuated Foot Switch	1	1	088712993001	6" x 4" x 4"
99301	Air Actuated Press Box	1	1	088712993018	6" x 4" x 4"
99318	9" Drum Assembly	1	4	088712993186	10" x 10" x 15"
99323	Replacement Drill Motor	1	5	088712993230	11" x 11" x 3"

Replacement Cable with Open Hook



Item # 90111 1/4" x 50'
For 10 & 20 - Series



DELUXE 20 SERIES • Cleans 3/4" - 3" lines up to 50' For Most Sinks, Showers & Tub Drains

- FEATURES:**
- Vertical or horizontal operation capabilities
 - Double insulated, variable speed drill motor
 - All contour welded tubular fitted frame for added strength
 - Rugged 9" rotational molded drum with quick drum release
 - Foot switch operation
 - Elephant trunk guide hose
 - Grease fitting on drive shaft
 - Music wire cable

Item # 90265 Includes: 1/4" x 50' Open Hook Cable



Item #	Description	Case Pack / Wt.		Item UPC#	Case Pack Dimensions
90265	1/4" x 50' Cable Drum Machine	1	25	088712902652	20" x 13" x 16"
Replacement Cables					
90111	1/4" x 50' Replacement Cable	1	2	088712901112	11" x 11" x 2"
Parts & Accessories					
99300	Air Actuated Foot Switch	1	1	088712993001	6" x 4" x 4"
99301	Air Actuated Press Box	1	1	088712993018	6" x 4" x 4"
99318	9" Drum Assembly	1	4	088712993186	10" x 10" x 15"
99323	Replacement Drill Motor	1	5	088712993230	11" x 11" x 3"



Operates Vertically or Horizontally



DRAIN CLEANING POWER MACHINES

40 SERIES • Cleans 2" - 4" lines up to 100' For Most Sinks, Floor Drains & Roof Stacks

- FEATURES:**
- 1/3 HP motor with forward-off-reverse switch
 - Manual overload reset protector and in-line GFI
 - Industrial grade pneumatic foot switch
 - Rugged 13" corrosion-resistant molded cable drum
 - Music wire cable with inner core

Item # 90040 Includes: 3/8" x 75' Slotted End Cable & 4 Piece Cutter Set
Item # ST-440 Includes: 3/8" x 100' Slotted End Cable & 4 Piece Cutter Set



Item #	Description	Case Pack / Wt.		Item UPC#	Case Pack Dimensions
90040	3/8" x 75' Cable Drum Machine	1	51	088712900405	24" x 13" x 21"
ST-440	3/8" x 100' Cable Drum Machine	1	63	088712960447	24" x 13" x 21"
Replacement Cables					
90440	3/8" x 75' Replacement Cable	1	17	088712904403	14" x 14" x 2"
ST-96112	3/8" x 100' Replacement Cable	1	31	088712961123	14" x 14" x 2"
ST-96122	1/2" x 75' Replacement Cable	1	37	088712961222	16" x 16" x 3"
Cutter Set					
90099	4 Piece Cutter Set for 5/16" - 1/2" Cable	1	1	088712900993	6" x 4" x 4"
Parts & Accessories					
99202	Straight Boring Head - 3/8", 1/2"	1	1	088712992028	6" x 4" x 4"
99204	Spear Head - 3/8", 1/2", 5/8"	1	1	088712992042	6" x 4" x 4"
99205	Grease Cutter - 3/8", 1/2"	1	1	088712992059	6" x 4" x 4"
99206	Side Cutter - 3/8", 1/2"	1	1	088712992066	6" x 4" x 4"
99300	Air Actuated Foot Switch	1	1	088712993001	6" x 4" x 4"
99319	13" Drum Assembly	1	7	088712993193	17" x 12" x 7"
99320	Motor 1/3 HP - Capacitor Start W/GFI	1	15	088712993209	11" x 10" x 9"
99330	Belt Guard Cover	1	1	088712993308	6" x 4" x 4"
ST-96600	Heavy-Duty Dolly	1	15	088712966005	29" x 25" x 27"



Item # ST-99600
For 40 Series

Replacement Slotted End Inner Core Cable

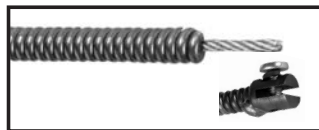

Item # 90440 3/8" x 75'
For 40 Series



DRAIN CLEANING POWER MACHINES

4500 SERIES • Cleans 2" - 4" lines up to 100' For Most Floor Drains & Main Drains

- FEATURES:**
- 1/2 HP motor with forward-off-reverse switch with V-belt pulley drive system
 - Manual overload reset protector and in-line GFI
 - 15" reinforced molded cable drum with telescopic handle
 - Oversized 14" wheels for easy transport
 - Three position power feed
 - Music wire cable with inner core

Item # 4540 Includes: 1/2" x 100' Slotted End Cable & 4 Piece Cutter Set

Item #	Description	Case Pack / Wt.		Item UPC#	Case Pack Dimensions
ST-4540	1/2" x 100' Cable Drum Machine	1	87	088712964544	28" x 24" x 30"
Replacement Cables					
ST-96114	1/2" x 100' Replacement Cable	1	49	088712961147	16" x 16" x 3"
ST-96122	1/2" x 75' Replacement Cable	1	37	088712961222	16" x 16" x 3"
Cutter Set					
90099	4 Piece Cutter Set for 5/16" - 1/2" Cable	1	1	088712900993	6" x 4" x 4"
Parts & Accessories					
99202	Straight Boring Head - 3/8", 1/2"	1	1	088712992028	6" x 4" x 4"
99204	Spear Head - 3/8", 1/2", 5/8"	1	1	088712992042	6" x 4" x 4"
99205	Grease Cutter - 3/8", 1/2"	1	1	088712992059	6" x 4" x 4"
99206	Side Cutter - 3/8", 1/2"	1	1	088712992066	6" x 4" x 4"
99300	Air Actuated Foot Switch	1	1	088712993001	6" x 4" x 4"
99321	Motor 1/2 HP - Capacitor Start W/GFI	1	15	088712993216	6" x 4" x 4"
99330	Belt Guard Cover	1	1	088712993308	6" x 4" x 4"
ST-96512	15" Drum Assembly	1	7	088712965121	24" x 13" x 22"



Replacement Slotted End Inner Core Cable

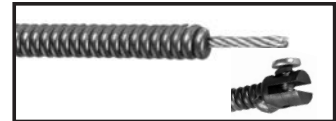

Item # 90442 1/2" x 100'
For 4540 Series

650 SERIES • Cleans 4" - 10" lines up to 100' For Most Main Drains, Sewer Lines & Root Blockages

- FEATURES:**
- 3/4 HP motor with thermal overload protector and manual reset switch
 - Extra large stair climber skids and extendible handles with two loading wheels
 - In-line ground fault interrupter
 - Exclusive "tilt-a-way" three position power feed with grease fitting for quick drum change
 - Heavy-duty 19" rotational molded drum
 - 5 Piece cutter set
 - Music wire cable with inner core

Item # ST-650 Includes: 3/4" x 100' Slotted End Cable & 6 Piece Cutter Set

Item #	Description	Case Pack / Wt.		Item UPC#	Case Pack Dimensions
ST-650	3/4" x 100' Cable Drum Machine	1	215	088712960652	31" x 24" x 36"
Replacement Cables					
ST-96119	3/4" x 100' Replacement Cable	1	110	088712961192	26" x 9" x 27"
Cutter Set					
ST-96296	6-Piece Cutter Set for 5/8" - 3/4" Cable	1	1	088712962960	6" x 4" x 4"
ST-96298	10-Piece Cutter Set 5/8" - 3/4" Cable	1	1	088712962984	6" x 4" x 4"
Parts & Accessories					
ST-96144	3/4" x 5' Slotted End - Anchor Cable	1	5	088712961147	14" x 14" x 3"
ST-96319	19" Replacement Drum Assembly	1	1	088712963196	19" x 18" x 19"
ST-96322	3/4 HP Replacement Motor	1	1	088712963226	11" x 10" x 9"
99330	Belt Guard Cover	1	1	088712993308	6" x 4" x 4"





FLAT TAPE • Series 02000 For Most Small Household Drains

Our 1/4" wide x 1/32" thick highly flexible flat steel wire is supplied with a steel rod frame holder for easy use and storage.

- FEATURES:**
- High-grade 1/4" flat wire
 - Closed wound spring boring head and steel rod frame holder
 - High carbon, oil tempered, non-kink, flat steel wire

Item #	Description	Case Pack / Wt.		Item UPC#	Case Pack Dimensions
02150	1/4" x 1/32" x 15'	12	6	088712021506	10" x 6" x 8"
02250	1/4" x 1/32" x 25'	12	9	088712022503	10" x 6" x 8"
02500	1/4" x 1/32" x 50'	12	16	088712025009	10" x 6" x 8"



POWER SNAKE • Series 81000 For Most Medium Household Drains

"Let your power drill do the work"

- FEATURES:**
- Attaches to your power drill
 - Rust proof protective vinyl tubing

Item #	Description	Case Pack / Wt.		Item UPC#	Case Pack Dimensions
81150	1/4" x 15'	5	12	088712811503	12" x 8" x 11"
81200	1/4" x 20'	5	15	088712812005	12" x 8" x 11"
81250	1/4" x 25'	5	18	088712812500	12" x 8" x 11"



DRAIN PIPE AUGERS • Series 10000 - 30000 For Most Small & Medium Household Drains

High quality spring wire offers maximum flexibility for the tightest bends.

- FEATURES:**
- High grade, high carbon round diameter spring steel wire
 - Galvanized "torque-twist" steel handle with easy spin speed grip
 - Integrated corkscrew open-wound boring head

Item #	Description	Case Pack / Wt.		Item UPC#	Case Pack Dimensions
10080	1/4" x 8' (With Storage Tote)	5	5	088712100805	10" x 6" x 8"
10100	1/4" x 10' (With Storage Tote)	5	6	088712101000	10" x 6" x 8"
10150	1/4" x 15' (With Storage Tote)	5	9	088712101505	10" x 8" x 8"
10250	1/4" x 25' (With Storage Tote)	5	14	088712102502	10" x 8" x 8"
20150	3/8" x 15'	6	18	088712201502	12" x 8" x 11"
CBR20250	3/8" x 25'	6	27	088712202509	13" x 8" x 14"
20500	3/8" x 50'	3	32	088712205005	13" x 8" x 14"
30500	1/2" x 50'	3	43	088712305002	13" x 8" x 14"
31000	1/2" x 100'	2	56	088712310006	17" x 6" x 17"



Storage Tote for
1/4" Spring Steel Wire



TOILET AUGERS • Series 40000 - 44000

For Most Household Toilets

Your choice of "poly" safety tube or welded steel tube.

- FEATURES:**
- Non-slip grip handles
 - Safety guide tube

Item #	Description	Case Pack / Wt.	Item UPC#	Case Pack Dimensions
40030	Homeowner (3/8" x 3')	5 6	088712400301	31" x 4" x 7"
41030	Economy (3/8" x 3')	12 22	088712410300	40" x 10" x 6"
42030	Standard (3/8" x 3')	12 24	088712420309	40" x 10" x 6"
42060	Standard (3/8" x 6')	12 30	088712420606	40" x 10" x 11"
43030	Deluxe (3/8" x 3')	12 25	088712430308	40" x 10" x 6"
44030	Heavy Duty (1/2" x 3')	12 32	088712440307	40" x 10" x 6"

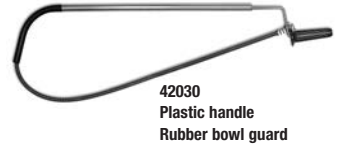
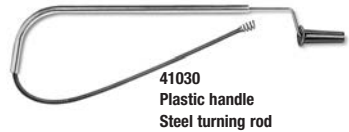
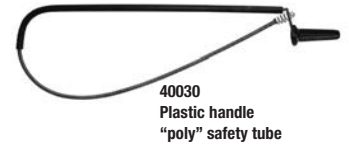

TOILET AUGERS • Series 45000 - 47000

For Most Household Toilets

The Professional, Tradesman & the Industrial Pro toilet augers are all built with quality and durability in mind.

- FEATURES:**
- Non-slip grip handles
 - Safety guide tube
 - Professional quality

Item #	Description	Case Pack / Wt.	Item UPC#	Case Pack Dimensions
45030	Professional (1/2" x 3')	12 36	088712450306	6" x 10" x 40"
46030	Tradesman (9/16" x 3')	1 3	088712460305	6" x 3" x 45"
47030	Industrial (1/2" x 3')	1 3	088712470304	6" x 3" x 45"

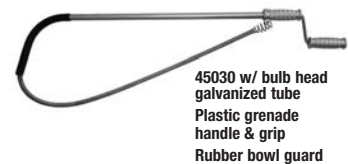

PRO/DH-TOILET AUGERS • Series 49000

For Most Household Toilets

This Professional group includes a 2' - 4' extendible urinal auger, 3' - 6' extendible toilet auger and a heavy-duty 3' toilet auger.

- FEATURES:**
- Non-slip grip handles
 - Safety guide tube
 - Professional quality

Item #	Description	Case Pack / Wt.	Item UPC#	Case Pack Dimensions
49240	Urinal (5/16" x 4' Total)	1 3	088712492405	40" x 10" x 6"
49360	Toilet (1/2" x 6' Total)	1 3	088712493600	6" x 3" x 45"
49360DH	Heavy-Duty w/Drop-Head (1/2" x 6')	1 3	088712493617	6" x 3" x 45"
49370	3' Toilet Auger w/Open Hook	1 3	088712493709	6" x 3" x 45"
49370DH	3' Toilet Auger w/Drop Head	1 3	088712493716	6" x 3" x 45"





FLAT SEWER ROD • Series 50000 - 71000

For Most All Size Sewer Drain Pipes

The 2 piece adjustable grip handle helps force flat rod with roller head back and forth quickly and easily.

- FEATURES:**
- Oil tempered, spring steel sewer tapes
 - Spear point roller ball head

Item #	Description	Case Pack / Wt.		Item UPC#	Case Pack Dimensions
50250	1/2" x 1/16" x 25'	3	11	088712502500	17" x 17" x 4"
50500	1/2" x 1/16" x 50'	3	17	088712505006	17" x 17" x 4"
50750	1/2" x 1/16" x 75'	3	23	088712507505	17" x 17" x 4"
51000	1/2" x 1/16" x 100'	3	29	088712510000	17" x 17" x 4"
60250	3/4" x 1/16" x 25'	3	14	088712602507	17" x 17" x 4"
60500	3/4" x 1/16" x 50'	3	23	088712605003	17" x 17" x 4"
60750	3/4" x 1/16" x 75'	3	33	088712607502	17" x 17" x 4"
61000	3/4" x 1/16" x 100'	3	42	088712610007	17" x 17" x 4"
70500	3/4" x 1/8" x 50'	1	17	088712705000	35" x 35" x 1"
71000	3/4" x 1/8" x 100'	1	27	088712710004	35" x 35" x 1"



ENCASED SEWER ROD • Series 95000

For Most Sewer Outlets, Stack Vents and Storm Gutters

Self-storing, wind-up and wind-out, rust resistant poly handle assures your hands minimal contact with wire. New sturdy spear shaped boring head penetrates the most stubborn clogs.

- FEATURES:**
- Self-storing poly case with easy wind-up, wind-out handle
 - Sturdy "poly-tuff" spear head
 - Oil tempered flat spring steel

Item #	Description	Case Pack / Wt.		Item UPC#	Case Pack Dimensions
95040	1/2" x 1/16" x 40'	3	13	088712950400	17" x 6" x 17"
95050	1/2" x 1/16" x 50'	3	17	088712950509	17" x 6" x 17"



SINK CLEANER • Series 90200

For Most Small Household Drains

Cleans 1" to 2" lines up to 20' long.

- FEATURES:**
- Self-storing poly case with easy wind-up handle.
 - Won't scratch sinks or pipes
 - Eliminates the need for chemicals

Item #	Description	Case Pack / Wt.		Item UPC#	Case Pack Dimensions
90220	1/4" x 1/32" x 20'	8	6	088712902201	10" x 6" x 8"





DRUM AUGER • Series 84000

For Most Sink, Shower and Tub Drains

This auger has a grip handle and a thumbscrew cable lock.

- FEATURES:**
- High impact polymer housing - long lasting durability
 - Screw construction



Item #	Description	Case Pack / Wt.		Item UPC#	Case Pack Dimensions
84150	1/4" x 15' Cable	4	9	088712841500	14" x 13" x 7"
84200	1/4" x 20' Cable	4	12	088712842002	14" x 13" x 7"
84250	1/4" x 25' Cable	4	14	088712842507	14" x 13" x 7"

PISTOL GRIP DRUM AUGER • Series 85000

For Most Sink, Shower and Tub Drains

- FEATURES:**
- High impact polymer housing - long lasting durability
 - Quick-lever cable lock- faster cable adjustment
 - Pistol grip - better control
 - Screw construction

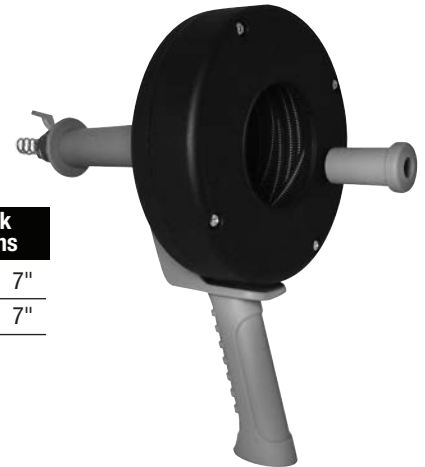

Item #	Description	Case Pack / Wt.		Item UPC#	Case Pack Dimensions
85150	1/4" x 15' Cable	4	12	088712851509	20" x 16" x 7"
85250	1/4" x 25' Cable	4	15	088712852506	20" x 16" x 7"

POWER PISTOL GRIP DRUM AUGER • Series 86000

For Most Sink, Shower and Tub Drains

Our Power Drum Auger can be used manually, or attach it to any power drill, and it becomes a drain cleaning machine.

- FEATURES:**
- High impact polymer housing - long lasting durability
 - Quick-lever cable lock- faster cable adjustment
 - Pistol grip - better control
 - Ergonomic soft rubber grip - maximum comfort, less fatigue
 - Drill attachment with safety clutch- connects to your drill - for faster cleaning
 - Screw construction



Item #	Description	Case Pack / Wt.		Item UPC#	Case Pack Dimensions
86150	1/4" x 15' Cable	4	12	088712861508	20" x 16" x 7"
86250	1/4" x 25' Cable	4	16	088712862505	20" x 16" x 7"



PRO HAND SPINNER • 110HS

For Most Small and Medium Household Drains

Cleans 3/4" to 3" lines up to 25' long.

- FEATURES:**
- Attaches to your power drill, includes easy to operate keyless chuck
 - Music wire w/high impact, rust proof plastic drum

Item #	Description	Case Pack / Wt.		Item UPC#	Case Pack Dimensions
ST-110HS	1/4" x 25' Cable	1	7	088712110118	10" x 6" x 8"



Drill NOT Included

SNAKE-IT™ • Series 87000

For Most Small and Medium Household Drains

The only free standing power drum auger...outside drum remains stationary with our drum within a drum design (cable is permanently attached). "Let your power drill do the work".

- FEATURES:**
- Attach to your power drill
 - Free standing patented design
 - High carbon spring steel wire

Item #	Description	Case Pack / Wt.		Item UPC#	Case Pack Dimensions
87200	1/4" x 20' Cable	4	18	088712872009	14" x 14" x 9"

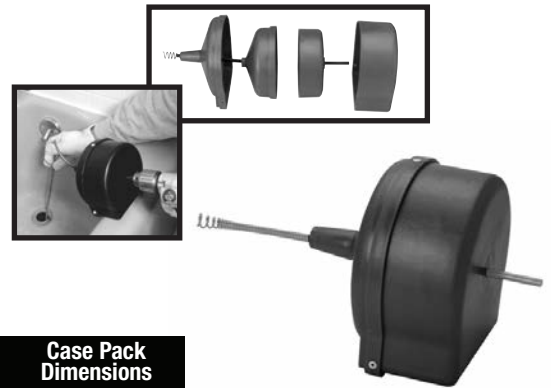

Drill NOT Included

5' SINK CLEANER • Series 00900

For Most Household Drains

- FEATURES:**
- Opens clogged sinks, showers and tub drains

Item #	Description	Case Pack / Wt.		Item UPC#	Case Pack Dimensions
00900	5' Sink Cleaner	5	3	088712009009	10" x 6" x 8"



ZIP-IT® TOOL • Series 00400

For Most Household Drains

The amazing, fast & easy way to clear clogged and slow running drains.

- FEATURES:**
- Strong "poly" construction
 - Various packaging options available

Item #	Description	Case Pack / Wt.		Item UPC#	Case Pack Dimensions
00402 BL	ZIP-IT® Tool Blister Pack	100	3	088712004004	31" x 4" x 7"
00412BL	ZIP-IT® Tool Blister Pack	12	1	088712004004	24" x 2" x 4"
00424 BL	ZIP-IT® Tool Blister Pack	24	1	088712004004	24" x 2" x 9"

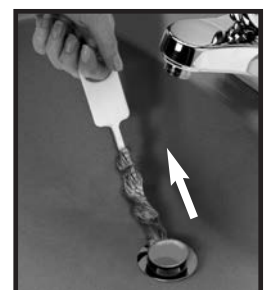



DRAIN CLEANING BLADDERS • Series 00331-00333

For Most Small to Large Household Drains

The Drain Bladders Series clears from 1" up to 6" drains as it expands in the drain, forcing water pressure through the clog.

Attaches to a garden hose.

- FEATURES:**
- Quality rubber construction
 - Environmentally safe

Item #	Description	Case Pack / Wt.		Item UPC#	Case Pack Dimensions
00331	Small Bladder Clears 1" to 2" Drains	6	14	088712033103	7" x 5" x 6"
00332	Medium Bladder Clears 1 1/2" to 3" Drains	6	19	088712033202	8" x 5" x 9"
00333	Large Bladder Clears 4" to 6" Drains	3	30	088712033301	13" x 7" x 9"



PLUNGERS

E-Z PLUNGER • Series 00320

For Most Household Toilets

The E-Z Plunger offers more pressure per square inch with its durable bellows design.

- FEATURES:**
- Strong 2 piece "poly" construction
 - Various packaging options available

Item #	Description	Case Pack / Wt.		Item UPC#	Case Pack Dimensions
00320	Plastic Bellows Plunger	12	11	088712003205	13" x 23" x 24"
00321	Plastic Bellows Plunger	48	44	088712003205	47" x 24" x 25"



SINK PLUNGER

For Most Kitchen Sinks, Showers and Bath Tubs

Item #	Description	Case Pack / Wt.		Item UPC#	Case Pack Dimensions
00310	5" Cup Bellows Plunger	6	2	088712003106	13" x 6" x 16"



AERO PLUNGER • Series 00590

For Most Household Toilets and Drains

- FEATURES:**
- Strong 2 piece "poly" construction
 - Various packaging options available

Item #	Description	Case Pack / Wt.		Item UPC#	Case Pack Dimensions
00590	Aero Plunger	12	11	088712005902	13" x 12" x 12"
00591	Aero Plunger	48	44	088712005902	47" x 24" x 25"





2 PK DISPOSABLE PLUNGERS • Series 00200

For Most Household Sinks, Tubs & Toilets

These twin plungers are designed to eliminate messy plunger storage. Use once and discard.

- FEATURES:**
- Package of 2
 - Dispose soiled plunger after each use
 - Keep a new, clean plunger ready in each bathroom
 - All plastic construction



Item #	Description	Case Pack / Wt.		Item UPC#	Case Pack Dimensions
00200	Disposable Plungers	4	4	088712002000	18" x 6" x 21"

FORCE CUP PLUNGERS • Series 00300

For Most Household Toilets and Drains

- FEATURES:**
- Force cup plunger with wooden handle

Item #	Description	Case Pack / Wt.		Item UPC#	Case Pack Dimensions
00301	Force Cup Plunger	12	11	088712003014	8" x 10" x 36"
00302	Heavy Duty Force Cup Plunger	5	5	088712003021	8" x 7" x 35"
00304	Force Cup Plunger	12	11	088712003045	8" x 10" x 36"
00305	Force Cup Plunger	12	11	088712003052	8" x 10" x 36"
00306	Heavy Duty Force Cup Plunger	6	5	088712003069	6" x 9" x 33"



UNIVERSAL PLUNGER CADDY • Series 00205

- FEATURES:**
- Helps keep bathroom clean and organized
 - Fits most household plungers
 - Helps protect floors and cabinets from cleaning chemicals

Item #	Description	Case Pack / Wt.		Item UPC#	Case Pack Dimensions
00205	Universal Plunger Caddy	6	3	088712002055	7" x 8" x 13"





PLUNGE-N-STORE® • Series 00207

For Most Household Toilets

Designed with a unique and attractive handle. Will fit any decor.

- FEATURES:**
- Opens clogged toilets
 - Unique carrying caddy
 - One hand operation

Item #	Description	Case Pack / Wt.		Item UPC#	Case Pack Dimensions
00207	Plunge-N-Store®	4	14	088712002079	22" x 15" x 23"

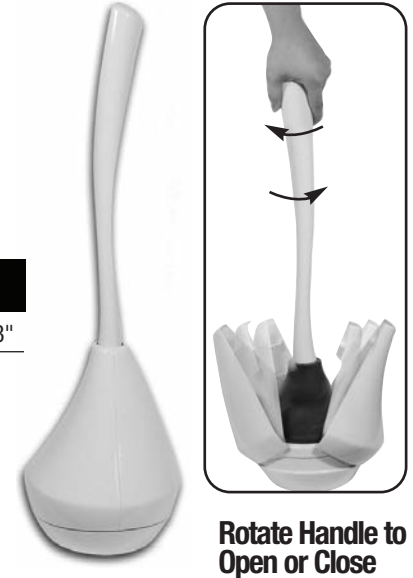

DRAIN BLASTER® • Series 00650

For Most Household Drains

Clears clogs with a gentle burst of air . . . Simply pump it and release the trigger.

- FEATURES:**
- 4 drain size attachments
 - Clears with a safe burst of air
 - Strong "poly" construction

Item #	Description	Case Pack / Wt.		Item UPC#	Case Pack Dimensions
00650	Drain Blaster®	3	12	088712006503	24" x 2" x 4"



PLUNGE-IT™ • Series 00300

For Most Household Toilets and Drains

Unclogs toilets and household drains with the push of a handle, forcing air & water through the line.

- FEATURES:**
- Strong "poly" construction
 - 2 drain & toilet attachments

Item #	Description	Case Pack / Wt.		Item UPC#	Case Pack Dimensions
00300	Plunge-It™	2	9	088712003007	31" x 4" x 7"





DRYER LINT TRAP BRUSH
For Most Household Dryer & Dryer Ducts

- FEATURES:**
- For cleaning dryer lint traps, heating vents and under refrigerators
 - Flexible, protective cover
 - Increases appliance efficiency



Item #	Description	Case Pack / Wt.		Item UPC#	Case Pack Dimensions
00051	Dryer Lint Trap Brush	3	14	088712000518	24" x 2" x 9"



APPLIANCE BRUSH
For Most Household Dryers

- FEATURES:**
- 40" Telescopic multi-use handle
 - Removable brush cleaner
 - Helps prevent fires due to dryer lint build up
 - Increases appliance efficiency
 - Saves energy
 - Ideal for cleaning dryer lint traps, radiators, refrigerator coils



Item #	Description	Case Pack / Wt.		Item UPC#	Case Pack Dimensions
00053	Appliance Brush	3	14	088712000532	24" x 2" x 9"

10' DRYER VENT BRUSH
For Most Household Dryer & Dryer Ducts

- FEATURES:**
- Helps remove lint build up
 - Increases appliance efficiency



Item #	Description	Case Pack / Wt.		Item UPC#	Case Pack Dimensions
00054	10' Dryer Vent Brush	3	14	088712000549	24" x 2" x 9"

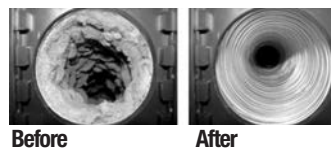



Before After









	Item #	Description	Shelf Pack	Case Pack	UPC#	Item Dimensions L x W x D
	PST001	ENCLOSED FEED TUBE CUTTER <ul style="list-style-type: none"> Cuts 1/8" to 1-1/8" OD copper and PVC tubing Reamer included One replacement wheel included 	5	25	039166046294	6" x 4" x 1"
	PST026	REPLACEMENT CUTTER WHEELS	5	25	039166046362	4" x 2" x 1"
	PST002	RATCHETING PVC CUTTER <ul style="list-style-type: none"> Cuts plastic, vinyl and rubber tubing up to 1-5/8" OD 	5	25	039166046300	10" x 5" x 1"
	PST024	REPLACEMENT BLADE	5	25	039166051793	9" x 4" x 0.2"
	PST003	JR. TUBE CUTTER <ul style="list-style-type: none"> Cuts 1/8" - 5/8" OD copper and PVC tubing 	5	25	039166046317	6" x 4" x 1"
	PST027	REPLACEMENT CUTTER WHEELS	5	25	039166046379	4" x 2" x 1"
	PST004	SCREW FEED TUBE CUTTER <ul style="list-style-type: none"> Cuts 1/8" - 1-1/8" OD copper and PVC tubing Reamer included 	5	25	039166046324	8" x 5" x 1"
	PST025	REPLACEMENT CUTTER WHEELS	5	25	039166046355	4" x 2" x 1"
	PST005	LARGE DIAMETER TUBE CUTTER <ul style="list-style-type: none"> Cuts 5/8" to 2-1/8" OD copper and PVC tubing Reamer included 	-	5	039166046331	10" x 6" x 1"
	PST028	REPLACEMENT CUTTER WHEELS	5	25	039166046386	4" x 2" x 1"
	PST006	LARGE DIAMETER MINI TUBE CUTTER <ul style="list-style-type: none"> Cuts 1/8" to 1-1/8" OD copper and PVC tubing 	5	25	039166046881	6" x 4" x 1"
	PST026	REPLACEMENT CUTTER WHEELS	5	25	039166046362	4" x 2" x 1"









	Item #	Description	Shelf Pack	Case Pack	UPC#	Item Dimensions L x W x D
	PST007	MINI TUBE CUTTER <ul style="list-style-type: none">Cuts 1/8" to 7/8" OD copper and PVC tubing	5	25	039166046348	3" x 4" x 1"
	PST029	REPLACEMENT CUTTER WHEELS	5	25	039166046393	4" x 2" x 1"
	PST011	2-IN-1 CUTTER WITH RATCHET HANDLE <ul style="list-style-type: none">Cuts 1/4" to 1-1/8" OD copper, aluminum and brass tubing	5	25	088712000112	11" x 5" x 2"
	PST030	REPLACEMENT CUTTER WHEELS	-	5	088712000303	4" x 2" x 1"
	PST109	INSIDE PIPE CUTTER <ul style="list-style-type: none">Use with hand drillFor 1-1/4" and larger PVC and ABS Pipe	5	25	039166090969	4" x 9" x 2"
	PST050	HEAVY DUTY FLARING TOOL <ul style="list-style-type: none">Flares 3/16" to 5/8" OD tubing	-	5	039166046409	10" x 6" x 1"
	PST052	ALL-IN-1 FLARING TOOL <ul style="list-style-type: none">Flares copper, aluminum, annealed brass and stainless steel tubingFor 3/16", 1/4", 5/16", 3/8", 1/2" and 5/8" OD tubing	-	5	039166046416	12" x 6" x 3"
	PST053	6-IN-1 SWAGING TOOL <ul style="list-style-type: none">Joins similar size copper tubing without couplings	5	25	039166046423	9" x 4" x 1"
	PST085	INNER/OUTER REAMER <ul style="list-style-type: none">Reams and bevels 1/8" to 1-5/8" copper tubing in addition to plastic, iron, steel, and brass pipe	5	25	039166091164	4" x 6" x 2"







Item #	Description	Shelf Pack	Case Pack	UPC#	Item Dimensions L x W x D
PST088	4-IN-1 FITTING BRUSH <ul style="list-style-type: none">Removes burrs from 1/2" and 3/4" copper tubing and fittings	-	25	039166090976	10" x 4" x 2"
					
PST090	DEBURRING TOOL <ul style="list-style-type: none">Removes burrs from iron pipe, copper, brass and PVCIncludes replacement blade in handle	5	25	039166046492	8" x 4" x 1"
					
PST095	REPLACEMENT BLADES	5	25	039166046508	4" x 2" x 1"
					
PST132	1/2" FITTING BRUSH <ul style="list-style-type: none">Carbon steel bristles.Wire handle	5	25	039166090983	6" x 1" x 1"
					
PST133	3/4" FITTING BRUSH <ul style="list-style-type: none">Carbon steel bristles.Wire handle	5	25	039166090990	6" x 1" x 1"
PST232	1/2" FITTING BRUSH <ul style="list-style-type: none">Stainless steel bristles.Comfort-fit handle	5	25	0395166091188	9" x 4" x 1"
					
PST233	3/4" FITTING BRUSH <ul style="list-style-type: none">Stainless steel bristles.Comfort-fit handle	5	25	039166091195	5" x 6" x 1"
PST073	TUBE BENDING SPRING SET <ul style="list-style-type: none">Bends 1/4", 3/8", 1/2" and 5/8" OD copper tubing	5	25	039166046454	14" x 4" x 2"
					
PST070	1/4" TUBE BENDING SPRING	5	25	039166046430	14" x 2" x 1"
PST071	1/2" TUBE BENDING SPRING	5	25	039166046447	14" x 2" x 1"
PST075	3/8" TUBE BENDING SPRING	5	25	039166046478	14" x 2" x 1"
PST076	5/8" TUBE BENDING SPRING	5	25	039166046485	14" x 2" x 1"
PST074	LEVER STYLE TUBE BENDER <ul style="list-style-type: none">Bends 1/4", 5/16" and 3/8" OD tubing	-	5	039166046461	10" x 8" x 2"
					









	Item #	Description	Shelf Pack	Case Pack	UPC#	Item Dimensions L x W x D
	PST147	BASKET STRAINER WRENCH <ul style="list-style-type: none">• Holds the strainer in place while tightening	-	5	039166046638	9" x 4" x 1"
	PST148	P.O. PLUG WRENCH <ul style="list-style-type: none">• Holds pop-up plugs and drain strainers during installation	-	5	039166046645	8" x 5" x 1"
	PST149	LOCK NUT WRENCH <ul style="list-style-type: none">• Removes or installs sink basket strainers• Hinged jaw fits most strainer lock nuts• Comfort grip handle	-	5	039166046652	8" x 5" x 1"
	PST152	ADJUSTABLE SLIP NUT WRENCH <ul style="list-style-type: none">• Tightens and removes 1" - 3" nuts• Adjusts up to 3"	-	5	039166046683	12" x 5" x 1"
	PST162	PLUMBER'S WRENCH <ul style="list-style-type: none">• Tightens and removes 1-3/4", 2" and 2-1/2" drainage pipe nuts	-	5	039166046775	8" x 5" x 0.4"
	PST164	GARBAGE DISPOSAL WRENCH <ul style="list-style-type: none">• Dislodges jammed shredder plates	-	5	039166046799	8" x 5" x 0.4"



DRAINAGE TOOLS

Item #	Description	Shelf Pack	Case Pack	UPC#	Item Dimensions L x W x D	
 PST170	TUB DRAIN REMOVER <ul style="list-style-type: none">• Installs and removes tub drains and spuds• Use width adjustable wrench or screwdriver	5	25	039166046843	8" x 5" x 2"	
 PST211	10" SMOOTH JAW PLIERS <ul style="list-style-type: none">• Smooth jaw helps protect finishes• Comfort grip handle• Tongue & groove adjustment• Angled nose• Chrome plated finish	-	5	088712002116	10" x 5" x 1"	
	PST185	10" CAST IRON WRENCH	-	5	039166090914	12" x 3" x 1"
	PST187	14" CAST IRON WRENCH	-	5	039166090921	15" x 3" x 1"
	PST188	18" CAST IRON WRENCH	-	5	039166090938	16" x 4" x 2"
	PST390	14" ALUMINUM PIPE WRENCH	-	4	088712003908	14" x 3" x 1"
	PST391	18" ALUMINUM PIPE WRENCH	-	4	088712003915	18" x 4" x 2"
	PST392	24" ALUMINUM PIPE WRENCH	-	2	088712003922	24" x 4" x 2"









Item #	Description	Shelf Pack	Case Pack	UPC#	Item Dimensions L x W x D
PST140	TELESCOPING BASIN WRENCH <ul style="list-style-type: none">• Tightens or removes faucet mounting and shank nuts• 16" adjustable arm	5	20	039166046584	15" x 4" x 1"
					
PST166	RATCHET JAW BASIN WRENCH ATTACHMENT <ul style="list-style-type: none">• Removes faucet mounting and shank nuts• Use with 3/8" ratchet• Knurled for steady grip	5	25	039166046812	5" x 4" x 1"
					
PST151	BASIN WRENCH <ul style="list-style-type: none">• Removes or tightens faucet mounting and shank nuts• Reversible, spring-loaded head ideal for working in tight spaces	5	25	039166046676	14" x 5" x 1"
					
PST153	FAUCET RESEATING TOOL <ul style="list-style-type: none">• Resurfaces 1/4" and 3/8" faucet seats	5	25	039166046690	6" x 4" x 1"
					
PST165	LONG STEM FAUCET RESEATING TOOL <ul style="list-style-type: none">• Resurfaces 1/4", 3/8" and 1/2" faucet seats	-	5	039166046805	9" x 4" x 2"
					
PST141	SHOWER VALVE SOCKET WRENCH SET <ul style="list-style-type: none">• For 21/32", 27/32", 29/32", 21/32", 1-1/32", 1-3/32", 1-5/32", 1-9/32", 1-11/32" and 1-7/16" shower faucet stems	-	5	039166046591	11" x 7" x 2"
					





Item #	Description	Shelf Pack	Case Pack	UPC#	Item Dimensions L x W x D	
PST158	SHOWER VALVE SOCKET WRENCH <ul style="list-style-type: none">• For 1-1/32" and 1-3/32" hex	-	5	039166046737	6" x 4" x 1"	
	PST159	SHOWER VALVE SOCKET WRENCH <ul style="list-style-type: none">• For 29/32" and 31/32" hex	-	5	039166046744	6" x 4" x 2"
PST160	VALVE SOCKET WRENCH <ul style="list-style-type: none">• For 21/32" and 27/32" hex	-	5	039166046751	6" x 4" x 1"	
PSB3424	HEAVY DUTY TAPERED FAUCET SEAT WRENCH <ul style="list-style-type: none">• Resurfaces 1/4", 3/8" and 1/2" faucet seats	-	10	039166094806	8" x 3" x 1"	
	PST156	TAPERED FAUCET SEAT WRENCH <ul style="list-style-type: none">• Removes & tightens removable faucet seats	5	25	039166046713	5" x 8" x 1"
	PST157	6-STEP FAUCET SEAT WRENCH <ul style="list-style-type: none">• Removes & tightens removable faucet seats	5	25	039166046720	5" x 9" x 1"
	PST161	STEM & CARTRIDGE WRENCH FOR MOEN® FAUCETS <ul style="list-style-type: none">• Removes frozen faucet stems & cartridges for Moen® brand faucets	-	5	039166046768	6" x 4" x 1"
	PST168	FAUCET HANDLE AND COMPRESSION SLEEVE PULLER KIT <ul style="list-style-type: none">• Removes frozen faucet handles and compression sleeves	-	5	039166046836	10" x 6" x 1"
						



Item #	Description	Shelf Pack	Case Pack	UPC#	Item Dimensions L x W x D
PST110	PVC CABLE SAW • Cuts PVC pipe - ideal for tight spots	5	25	039166046515	9" x 4" x 1"
					
PST111	13" PVC SAW • Cuts PVC tubing • 5-Angle adjustment handle	5	25	039166046522	19" x 5" x 1"
PST112	18" PVC SAW • Cuts PVC tubing • 5-Angle adjustment handle	5	25	039166046539	19" x 3" x 1"
					
PST126	13" REPLACEMENT BLADE • Cuts PVC tubing	10	50	039166046560	16" x 3" x 1"
PST127	18" REPLACEMENT BLADE • Cuts PVC tubing	10	50	039166046577	21" x 3" x 0.1"
					
PST113	MINI HACKSAW • Cuts brass, copper, iron, steel, wood and plastic • Ergonomic handle • Quick & easy blade tension adjustment & replacement	5	50	039166046546	12" x 5" x 1"
PST125	REPLACEMENT BLADES	5	25	039166046553	8" x 4" x 1"
					
					
PST114	CLOSE QUARTERS HACKSAW • Cuts brass, copper, iron, steel, wood and plastic • Great for use in tight places where access is limited • Textured grip handle	5	25	039166090907	8" x 5" x 1"
PST125	REPLACEMENT BLADES	5	25	039166046553	8" x 4" x 1"
					
					



Item #	Description	Shelf Pack	Case Pack	UPC#	Item Dimensions L x W x D
	PST142 3/8" INTERNAL PIPE WRENCH <ul style="list-style-type: none">Removes broken or frozen pipe nipples	5	25	039166046607	6" x 4" x 1"
	PST143 1/2" INTERNAL PIPE WRENCH <ul style="list-style-type: none">Removes broken or frozen pipe nipples	5	25	039166046614	6" x 4" x 1"
	PST144 3/4" INTERNAL PIPE WRENCH <ul style="list-style-type: none">Removes broken or frozen pipe nipples	5	25	039166046621	6" x 4" x 1"
	PST150 INTERNAL PIPE WRENCH SET <ul style="list-style-type: none">Removes broken or frozen pipe nipplesFor 3/8", 1/2" and 3/4" pipe nipples	-	5	039166046669	6" x 4" x 1"
	PST154 4 WAY SILLCOCK KEY <ul style="list-style-type: none">For 1/4", 9/32", 5/16" and 1-1/32" stems	5	25	039166046706	6" x 5" x 1"
	PST163 MINI STRAP WRENCH <ul style="list-style-type: none">Adjusts to 2" pipe capacity	5	25	039166046782	9" x 5" x 1"
	PST173 11" STRAP WRENCH	5	25	088712001737	6" x 4" x 1"
	PST167 PIPE NIPPLE EXTRACTORS SET <ul style="list-style-type: none">Removes broken or frozen pipe nipplesFor 1/8", 1/4", 3/8", 1/2" and 3/4" pipe nipples	5	25	039166046829	14" x 4" x 2"
	PSB3415 SLOT HEAD STREET KEY WRENCH <ul style="list-style-type: none">5/8" slot head x 28-3/4" lengthTurns off water supply line to house from exterior of house	-	5	039166094752	30" x 10" x 1"
					



SPECIALTY PLUMBING TOOLS

Item #	Description	Shelf Pack	Case Pack	UPC#	Item Dimensions L x W x D
PS2445	STOVE PIPE CRIMPERS <ul style="list-style-type: none"> • Crimps heavy pipe, wall stacks or air ducts 	-	5	039166029570	10 x 5" x 1"
					
PSB3444	AIR VENT WITH KEY <ul style="list-style-type: none"> • Use with radiator vents and water heaters 	-	1000	039166094813	1" x 1" x 0.25"
					
PST171	NO-HUB COUPLING WRENCH <ul style="list-style-type: none"> • Automatic release at 60" pound • Features ratcheting action and reversing lever • Tightens and removes band screws on hub clamps 	5	25	039166090945	8" x 5" x 1"
					
PS2405	ECONO PLUG 1-1/2" <ul style="list-style-type: none"> • For 1-1/2" cast iron and PVC pipe 	-	5	039166019588	5" x 4" x 2"
PS2406	ECONO PLUG 2" <ul style="list-style-type: none"> • For 2" cast iron and PVC pipe 	-	5	039166029297	5" x 4" x 2"
PS2407	ECONO PLUG 3" <ul style="list-style-type: none"> • For 3" cast iron and PVC pipe 	-	5	039166029303	7" x 5" x 3"
PS2408	ECONO PLUG 4" <ul style="list-style-type: none"> • For 4" cast iron and PVC pipe 	-	5	039166029310	8" x 7" x 3"
					



Item #	UPC	Page #	Item #	UPC	Page #	Item #	UPC	Page #	Item #	UPC	Page #
00051	08871200051814	51000	0887125100008	PST005	03916604633115	PST162	03916604677518
00053	08871200053214	60250	0887126025078	PST006	03916604688115	PST163	03916604678223
00054	08871200054914	60500	0887126050038	PST007	03916604634816	PST164	03916604679918
00200	08871200200012	60750	0887126075028	PST011	08871200011216	PST165	03916604680520
00205	08871200205512	61000	0887126100078	PST024	03916605179315	PST166	03916604681220
00207	08871200207913	70500	0887127050008	PST025	03916604635515	PST167	03916604682923
00300	08871200300713	71000	0887127100048	PST026	03916604636215	PST168	03916604683621
00301	08871200301412	81150	0887128115036	PST027	03916604637915	PST170	03916604684319
00302	08871200302112	81200	0887128120056	PST028	03916604638615	PST171	03916609094524
00304	08871200304512	81250	0887128125006	PST029	03916604639316	PST173	08871200173723
00305	08871200305212	84150	0887128415009	PST030	08871200030316	PST185	03916609091419
00306	08871200306912	84200	0887128420029	PST050	03916604640916	PST187	03916609092119
00310	08871200310611	84250	0887128425079	PST052	03916604641616	PST188	03916609093819
00320	08871200320511	85150	0887128515099	PST053	03916604642316	PST211	08871200211619
00321	08871200320511	85250	0887128525069	PST070	03916604643017	PST232	03916609118817
00331	08871203310311	86150	0887128615089	PST071	03916604644717	PST233	03916609119517
00332	08871203320211	86250	0887128625059	PST073	03916604645417	PST390	08871200390819
00333	08871203330111	87200	08871287200910	PST074	03916604646117	PST391	08871200391519
00402 BL	08871200400410	90010	0887129001082	PST075	03916604647817	PST392	08871200392219
00412BL	08871200400410	90011	0887129001152	PST076	03916604648517	ST-110ES	0887121100022
00424 BL	08871200400410	90020	0887129002073	PST085	03916609116416	ST-110HS	08871211011810
00590	08871200590211	90040	0887129004054	PST088	03916609097617	ST-120ES	0887121200012
00591	08871200590211	90099	0887129009934	PST090	03916604649217	ST-130ES	0887121300002
00650	08871200650313	90110	0887129011052	PST095	03916604650817	ST-260	0887129602633
00900	08871200900910	90111	0887129011123	PST109	03916609096916	ST-440	0887129604474
02150	0887120215066	90220	0887129022018	PST110	03916604651522	ST-4540	0887129645445
02250	0887120225036	90265	0887129026523	PST111	03916604652222	ST-650	0887129606525
02500	0887120250096	90440	0887129044034	PST112	03916604653922	ST-96102	0887129610242
10080	0887121008056	95040	0887129504008	PST113	03916604654622	ST-96106	0887129610623
10100	0887121010006	95050	0887129505098	PST114	03916609090722	ST-96109	0887129610932
10150	0887121015056	99202	0887129920284,5	PST125	03916604655322	ST-96112	0887129611234
10250	0887121025026	99204	0887129920424,5	PST126	03916604656022	ST-96114	0887129611475
20150	0887122015026	99205	0887129920594,5	PST127	03916604657722	ST-96119	0887129611925
CBR20250	0887122025096	99206	0887129920664,5	PST132	03916609098317	ST-96122	0887129612224,5
20500	0887122050056	99300	0887129930014,5	PST133	03916609099017	ST-96144	0887129611475
30500	0887123050026	99301	0887129930183	PST140	03916604658420	ST-96296	0887129629605
31000	0887123100066	99318	0887129931863	PST141	03916604659120	ST-96298	0887129629845
40030	0887124003017	99319	0887129931934	PST142	03916604660723	ST-96319	0887129631965
41030	0887124103007	99320	0887129932094	PST143	03916604661423	ST-96322	0887129632265
42030	0887124203097	99321	0887129932165	PST144	03916604662123	ST-96512	0887129651215
42060	0887124206067	99323	0887129932302,3	PST147	03916604663818	ST-96600	0887129660054
43030	0887124303087	99330	0887129933084,5	PST148	03916604664518			
44030	0887124403077	PS2405	03916601958824	PST149	03916604665218			
45030	0887124503067	PS2406	03916602929724	PST150	03916604666923			
46030	0887124603057	PS2407	03916602930324	PST151	03916604667620			
47030	0887124703047	PS2408	03916602931024	PST152	03916604668318			
49240	0887124924057	PS2445	03916602957024	PST153	03916604669020			
49360	0887124936007	PSB3415	03916609475223	PST154	03916604670623			
49360 DH	0887124936177	PSB3424	03916609480621	PST156	03916604671321			
49370	0887124937097	PSB3444	03916609481324	PST157	03916604672021			
49370 DH	0887124937167	PST001	03916604629415	PST158	03916604673721			
50250	0887125025008	PST002	03916604630015	PST159	03916604674421			
50500	0887125050068	PST003	03916604631715	PST160	03916604675121			
50750	0887125075058	PST004	03916604632415	PST161	03916604676821			

Sold and Serviced by:



Product availability
is subject to change.



Scan for direct access to the Cobra
Products List Price Schedule.

Cobra Products, Inc.

1 Warner Court
Swedesboro, NJ 08085
TOLL-FREE: 800-835-2200
PHONE: 856-241-7700
FAX: 856-241-1699

www.cobraus.com