

**Kwikset**  
*The Beauty of Strength.*



**PRICE GUIDE**

*Prepared by Albany Hardware, Inc.*

**ah Albany Hardware**

# Kwikset SMARTKEY™

Superior Security In A Completely New Design

**BUMPGUARD™**

Patented side locking bar technology replaces a traditional pin & tumbler design to protect against lock bumping\*.

**NEW TECHNOLOGY**

Locking bar, racks and pins are made out of stainless steel for increased strength and durability.

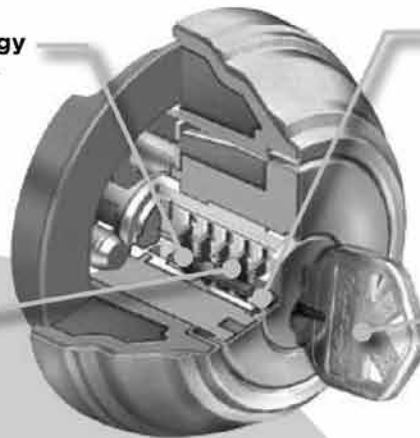

**DRILL RESISTANCE**

Cylinder uses two steel balls inserted into the front of the key face to resist attack from drilling.

**KEY IT YOURSELF**

Lock is rekeyable by using the included learn tool in less than 30 seconds without removing the lock from the door.

**Available in Kwikset® Signature Series™ Keyed Functions**



Deadbolts



Handlesets



Levers



Knobs

\* Lock bumping - an attack technique using specially cut keys that can defeat conventional pin & tumbler locks.

• INCREASE JOBSITE SECURITY

• CONTROL JOBSITE KEYS

• REDUCE CALLBACKS / SIMPLE ON SITE RE-KEYING

• DRIVE UPGRADES

• HOMEOWNER PEACE OF MIND



## How to Re-key with SMARTKEY...



Customized Security.

### BEFORE YOU START...

These steps show you how to re-key a lock to match a customer's current key, or that of another lock being purchased. For new purchases, the current key is the one that is supplied with the lockset.

These illustrations show a deadbolt for demonstration purposes, but these SmartKey™ rekeying instructions also apply to Kwikset® keyed knobs, levers, and handlesets.

#### DEFINITIONS

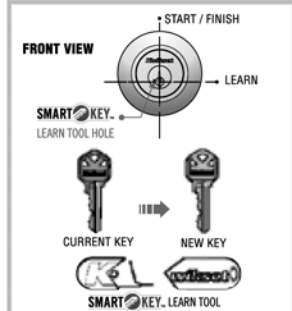

[www.kwikset.com/smartkey](http://www.kwikset.com/smartkey)

**WHERE TO GET A LEARN TOOL**  
Comes in every Kwikset Signature Series™ package.

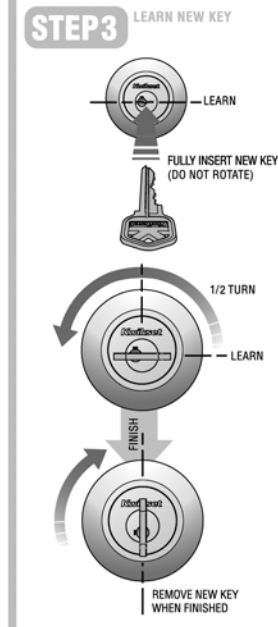
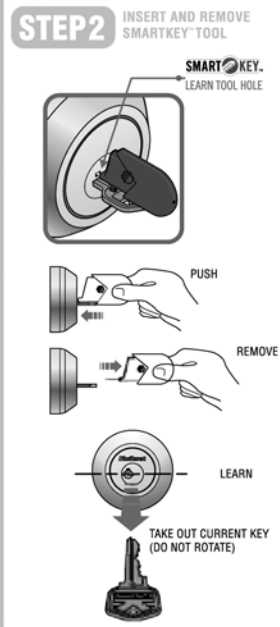
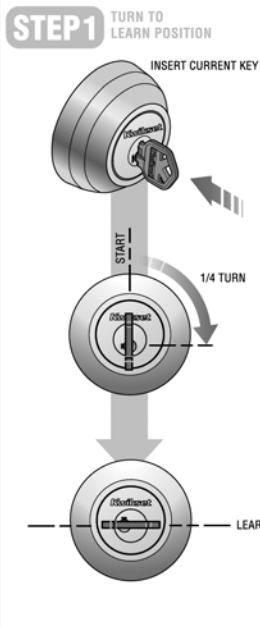

\*For deadbolts, make sure you grasp the torque blade from behind to prevent the cylinder from spinning freely.



## Standard with Kwikset Signature Series:

- Handlesets
- Knobs
- Levers
- SmartScan Biometric Deadbolt
- SmartCode Keypad Deadbolt

## Kwikset Product Lines

### Introduction

NEW! SMARTKEY Technology .....1-2  
 How to Order Locksets ..... 4  
 How to Order Handlesets ..... 5  
 Terms & Conditions ..... 6

### Signature Series

#### Handlesets

Amherst, Arlington, Ashfield, Avalon, Chelsea, Gibson, Hawthorne, Shelburne, Tavaris, Wellington.....7-15

#### Knobs

Abbey, Cameron, Circa, Copa, Hancock, Laurel, Phoenix .....16-17

#### Levers

Ashfield, Avalon, Brooklane, Commonwealth, Lido, Pembroke, Tustin .....18-20

#### Designer Roses

Signature Series Lever Style Designer Roses ..... 21

#### Deadbolts

980 Series, 780 Series, NEW 993 Contemporary .....22-23  
 909 SmartCode Touchpad Deadbolt..... 24  
 911 Smartcode Touchpad Lever ..... 25  
 909 SmartCode CNT Touchpad Deadbolt..... 26  
 907 PowerBolt Touchpad Deadbolt ..... 27

#### Round Pocket Door Locks

Models 334 & 335 ..... 28

### Kwikset Series

#### Handlesets

Bellevue, Dakota .....29-35

#### Knobs

Cove, Polo, Tylo .....36-37

#### Levers

Balboa, Delta, Dorian .....38-39

#### Deadbolts

660 Series, 663 & 667 Series .....40-41

### Parts & Accessories

Colonial Handle ..... 42  
 Round & Square Pocket Door Locks ..... 42  
 Latches ..... 43  
 Strikes.....44-45

### Weights & Measures

Signature Series ..... 46  
 Kwikset Series ..... 47

## General Information

### Kwikset Finishes

Kwikset offers a full spectrum of colors and textures to suit all types of decor.

Description	Kwikset	US/ANSI	BHMA
Lifetime Polished Brass		L03	505
Polished Brass		3	605
Antique Brass		5	609
Venetian Bronze		11P	-
Satin Nickel		15	619
Antique Nickel / Pewter		15A	620
Polished Chrome		26	625
Satin chrome		26D	626
Rustic Bronze	501	-	-
Rustic Pewter	502	-	-
Iron Black	514	-	-

### Door Handing

To determine proper door handing, view door frame from exterior side and identify the hinge side.

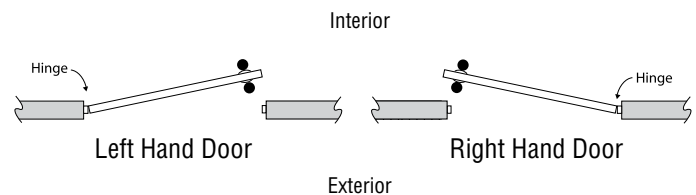

### Backset

Backset is the distance from the center edge of door to the center of the lockset hole. 2-3/8" or 2-3/4" in most cases.

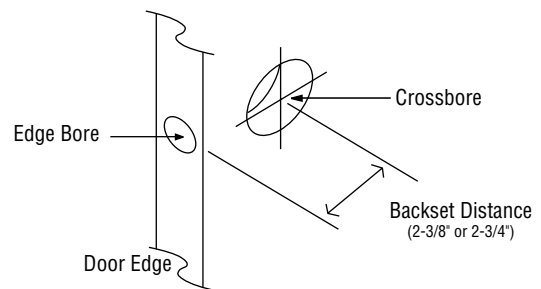

**Order Number Example**

Quantity (1)	Product/Function (2)	Design (3)	Finish Code (4)	Handing (5)	Backset (6)
6	720	ADL	26	-	-

**1) Order Quantity**

**2) Product Number or Function Code**

Each series has a set of function codes and includes a function chart that indicates what lockset functions are available in that series.

*Sample Function Codes*

Function	Name	Description
720	Passage	Both Lever/Knobs unlocked
730	Privacy	Push-Button locking from inside. Emergency pin release from outside
740	Entry	Both Lever/Knobs locked or unlocked by key outside or turnbutton inside
740-SMT	Entry w/SmartKey™	Both Lever/Knobs locked or unlocked by key outside or turnbutton inside
788	Half Dummy	Surface mounted; for doors where only a pull is required

Sample Series/Function Illustration

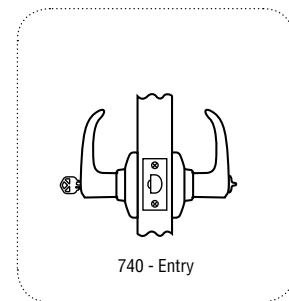

**3) Design**

Each design has a code assigned to designate the design style in the Order Number

*Sample Design Codes*

Design	Name	Description
ADL	Ashfield	Ashfield style lever
DL	Delta	Delta style lever
L	Laurel	Laurel style knob

**4) Finishes**

Kwikset offers a variety of finishes, designated by a US/ANSI Finish Code. Not all finishes are available for all models and/or functions.

*Sample Finish Codes*

US/ANSI	BHMA Code	Description
3	605	Bright Brass
15	619	Satin Nickel
11P	-	Venetian Bronze

**5) Handing**

Most items are non-handed or field reversible. If the handing is required for a model and/or functions designate with LH for left hand door or RH for right hand door. See diagram on page 1 to determine proper door handing.

**6) Backset**

Backset is the distance from the door edge to the center of cross-bore on door stile. Most Kwikset residential lockset models ship with an adjustable latch for 2-3/8" and 2-3/4" backsets. See each model's specifications for additional information.

**Notes for Ordering Handlesets**

Kwikset Handlesets are comprised on an Exterior Function/Design and an Interior Function/Design. Handlesets are made to order by combining two separate components and therefore require two part numbers when placing an order. The separate parts will be assembled and packaged together for shipping.

Examples for ordering each type of handleset are shown on Page 5.

## How to Order a Complete Single Cylinder Entrance Handleset:

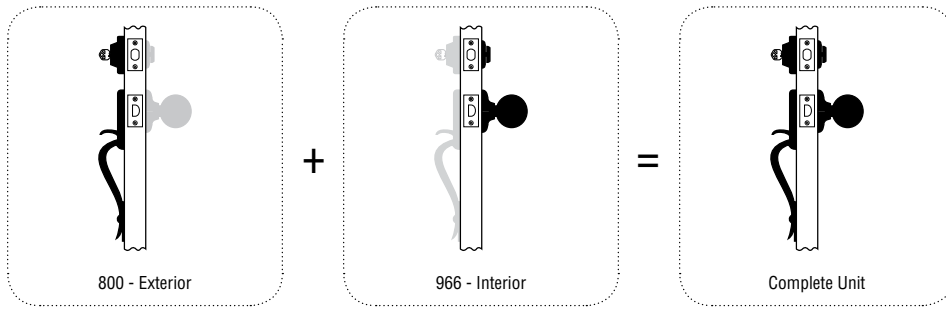

**Single Cylinder Handleset -**  
Latchbolt operated by thumb piece outside and knob/lever inside. Deadbolt operated by key outside and turn unit inside. (Combine 800 + 966)

Order Number Example (Two Part Numbers = Complete Unit)

Quantity	Product/Function	Design	Finish Code	Handing	Backset
1	800	AT	11P	-	-
1	966	CHL	11P	RH	

## How to Order a Complete Double Cylinder Entrance Handleset:

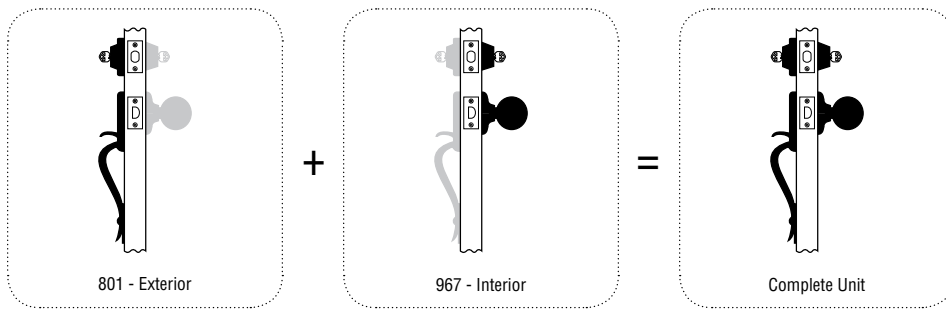

**Double Cylinder Handleset -**  
Latchbolt operated by thumb piece outside and grip inside. Deadbolt operated by key both sides. (Combine 801 + 967)

Order Number Example (Two Part Numbers = Complete Unit)

Quantity	Product/Function	Design	Finish Code	Handing	Backset
1	801	AT	11P	-	-
1	967	CHL	11P	LH	

§ **Caution:** Double-cylinder locks on residences or any door in a structure which is used for egress are a safety hazard in times of emergency and their use is not recommended. Installation should be in accordance with local building codes only.

## How to Order a Complete Dummy Entrance Handleset:

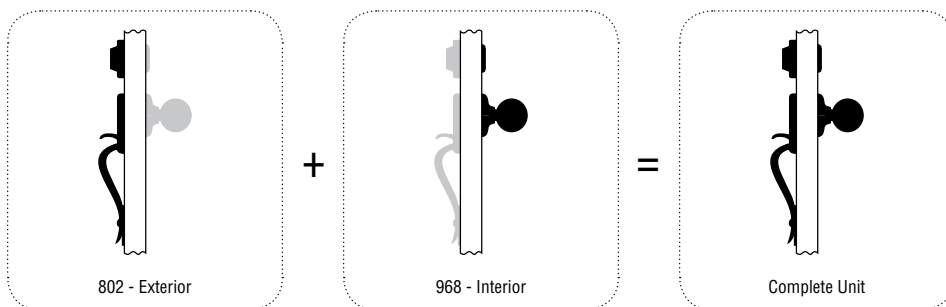

**Outside & Inside Dummy Trim -**  
For use as door pull or as dummy trim on inactive leaf of pair of doors. Fixed thumbpiece and inside knob/lever. Dummy cylinder with inside plate. (Combine 802 + 968)

Order Number Example (Two Part Numbers = Complete Unit)

Quantity	Product/Function	Design	Finish Code	Handing	Backset
1	802	AT	11P	-	-
1	968	L	11P	-	

## Albany Hardware Terms and Conditions

### Returns

All returns must be authorized by Albany Hardware, Inc. and accompanied by an RGA# which will be issued by Albany Hardware, Inc. within 45-Days of original invoice date. All items that are current, unused and in the original manufacturers packaging can be returned upon authorization for the sale prices less a 30% restocking fee. Installed hardware cannot be returned unless defective (see warranty information below).

All RGA's issued will expire 45-Days from the date of issue. Any shipment received on an expired RGA# will not be accepted for replacement or credit. Returns must be shipped prepaid via United Parcel Service (UPS), United States Postal Service (USPS) or Federal Express (FedEx).

Discontinued, special order, or open items with missing parts/packaging cannot be returned. **Non-Stock/Factory Order** items are non-cancelable and non-returnable once order has been placed with the respective manufacturer. This includes, but is not limited to all U.L. listed locksets and deadbolts.

### Shortages/Damaged/Defective Shipments

Albany Hardware, Inc. will not accept any claims of shortage or damage past 15-Days of signed receipt. All shipments should be inspected upon arrival and refused if damaged. All claims to defective product will be verified upon receipt of returned product and are subject to approval by Albany Hardware, Inc. All defective products will be repaired or replaced with the exact merchandise originally purchased. If the product is no longer available, a comparable product will be offered.

### Warranty

Albany Hardware, Inc. follows individual manufacturer's guidelines for any warranty issues. All warranty claims beyond 90-Days of original purchase date will be forwarded directly to the manufacturer. This includes, but is not limited to all finish and function issues covered by the manufacturer's warranty as written and published by each manufacturer. Contact Kwikset's warranty service for additional information at **1-800-327-LOCK**.

### Hardware Finishes

Kwikset lock finishes are durable, top quality finishes obtained by the careful processing of solid brass, bronze, stainless steel or other materials. Where required, a protective clear coating is applied and cured under high temperature. It is important that climatic conditions and usage be taken under consideration when selecting finishes. This is especially true in areas subjected to strong corrosive vapors, humid climate or sea air which, in a short time, may have a damaging effect on metal finishes. The longevity and preservation of the finish appearance is determined by base metal and finishing process. Clear protective coating or other organic finishing applications may require different methods of cleaning and care.

As an example, non-clear coated finishes should not be cleaned with soaps or any solvents; organically coated surfaces should periodically be cleaned with a mild, nonabrasive soap and buffed lightly with a clean cloth. The type of base metal and finishing techniques must be considered when applying any cleaning or preservative method. Contact the Kwikset Technical Services Department for further information on the care of finished hardware. Finishes of latches, strikes, cylinder/cores, and visible mounting screws, though similar in appearance, may differ from the finish of the trim.

In some instances, for customer convenience, the most appropriate BHMA finish symbols are used to indicate similarity of appearance, regardless of base metal of finishing process. Finishes of latches, strikes, cylinders/cores, and visible mounting screws, though similar in appearance, may differ from the finish of the trim.

### Standard Finishes

Refer to each lock series section for standard finish availability. Standard finish availability varies depending on the function, design and options ordered.

### Published Prices

Pricing published in this catalog are Kwikset's Suggested Retail Prices effective on April 4th, 2011 as shown in the Kwikset Residential *Box Pack* Price Book. Product Specifications and Pricing are subject to change at any time. In the event a product price is listed incorrectly due to typographical error or error in pricing information received from our vendors, Albany Hardware shall have the right to refuse or cancel any orders placed for product listed at the incorrect price.



**The Signature Series from Kwikset is the best style and security you can buy.**

The new elegantly designed solid forged brass handlesets and the Laurel egg knob are available in designer finishes such as Venetian Bronze and Satin Nickel.

Designer styled ANSI Grade 1 deadbolts provide superior resistance against forcible entry.

Kwik-Install, featured on all knobs, includes a twist-fit mount plate and pre-installed screws for flawless installation and reduced callbacks due to lost screws, screw stripping, and on-the-job dings and scratches.

### Features

- ANSI/BHMA Grade 1 Security Deadbolt
- 1" Titanium Alloy Throwbolt Core
- Ultra-Strike Jamb Brace™
- SMARTKEY™ Cylinder
- Concealed Screws
- Solid Forged-Brass
- Lifetime Mechanical Warranty
- 10-Year Finish Warranty





**Features & Specification**

**Door Prep**

*Deadbolt:*

- Cross Bore 2-1/8" or 1-1/2". Edge Bore 1" Latch Face 1" x 2-1/4"

*Handle:*

- Cross Bore 2-1/8". Edge Bore 1" Latch Face 1" x 2-1/4"

**Backset**

- Deadbolt: Adjustable to 2-3/8" or 2-3/4"
- Handle: Adjustable to 2-3/8" or 2-3/4"

**Door Thickness**

- 1-3/4" doors standard, 2-1/4" doors optional. (Not designed for use on 1-3/8" doors)

**Cylinder**

- SmartKey™ cylinder standard

**Latch Faceplate**

- 1" x 2-1/4"  
Interchangeable: Round corner, square corner or drive-in

**Strikes**

- Deadbolt: 1-1/4" x 3-5/8"
- Handle: 2-1/4" full lip

**Bolt**

- Deadbolt: 1" throw
- Handle: 1/2" throw







**Door Handing**

- Reversible for right- or left-hand doors. (Specify handing when ordering all levers as interior trim for exterior doors)

**ANSI/BHMA**

- A156.5 Grade 1 (Deadbolt)

**Kwikset Signature Series Handleset Exterior & Interior Lock Functions**



Model/Function	Description
Single Cylinder Handleset	
 <p><b>800</b> (553 - Gibson)</p>	<b>Exterior Entrance Lock Portion</b> - Latchbolt operated by thumb-piece outside and grip inside. Deadbolt operated by key outside and thumbturn inside.
 <p><b>966</b> (974 - Contemporary &amp; 986 - Gibson)</p>	<b>Interior Entrance Lock Portion</b> - Inside trim, deadbolt, latch, screws and strikes of 800.
Double Cylinder Handleset	
 <p><b>801</b> (554 - Gibson)</p>	<b>Exterior Entrance Lock Portion</b> - Latchbolt operated by thumbpiece outside and grip inside Deadbolt operated by key both sides.
 <p><b>967</b> (976 - Contemporary &amp; 987 - Gibson)</p>	<b>Interior Entrance Lock Portion</b> - inside trim, deadbolt, latch, screws and strikes of 801.
Dummy Handleset	
 <p><b>802</b> (555 - Gibson)</p>	<b>Exterior Entrance Dummy Portion</b> - Handle and grip act as a pull only. For inactive leaf or double doors. No operation.
 <p><b>968</b> (977 - Contemporary &amp; 989 - Gibson)</p>	<b>Interior Entrance Dummy Portion</b> - Inside trim of 802.

# Signature Series

## Handlesets

Kwikset

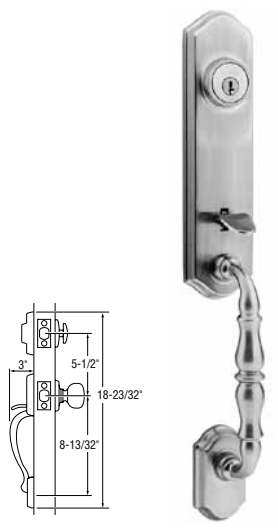
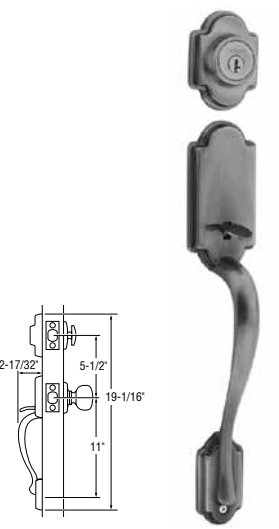
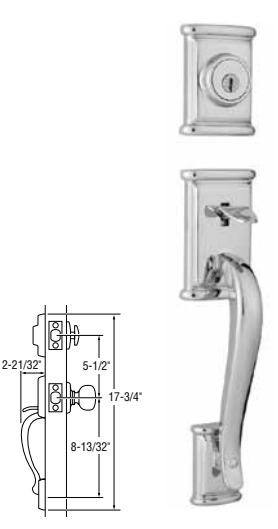
### Kwikset Signature Series Handleset Exterior Design Styles

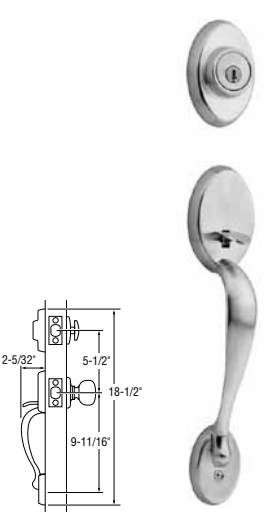
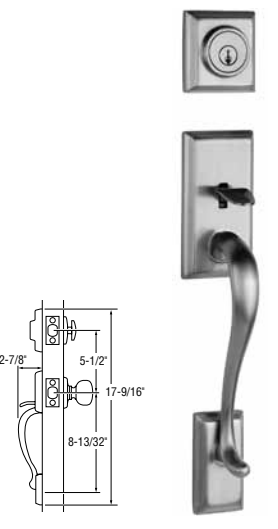
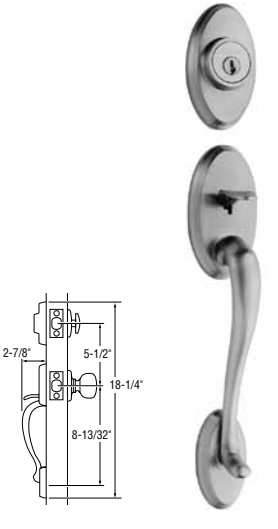
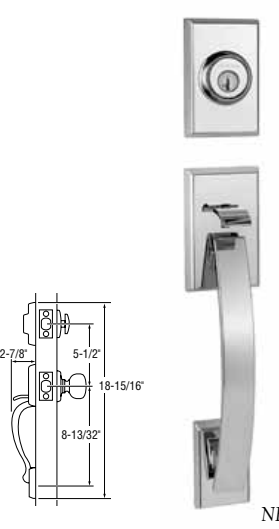
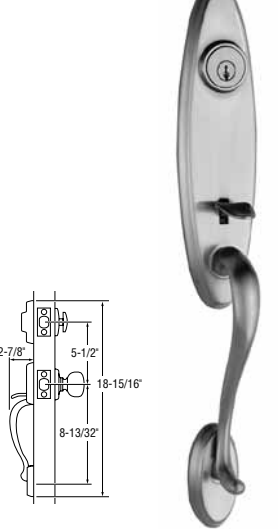
 <p><i>Amherst® (AT)</i></p>	 <p><i>Arlington® (AN)</i></p>	 <p><i>Ashfield™ (ADH)</i></p>
 <p><i>Avalon™ (AVH)</i></p>	 <p><i>Chelsea® (CE)</i></p>	 <p><i>Hawthorne® (HE)</i></p>
 <p><i>Shelburne® (SE)</i></p>	 <p><i>NEW-Tavaris® (TVH)</i></p>	 <p><i>Wellington® (WN)</i></p>

Kwikset Residential Architectural Hardware Catalog | ©2011 Albany Hardware, Inc.

**Signature Series Handleset Interior Design Options**

**Signature Series Knob & Lever Interior Options**



*Abbey® Knob (A)*



*Ashfield Lever™ (ADL)*



*Avalon Lever™ (AVL)*



*Brooklane® Lever (BRL)*



*Cameron Knob™ (CN)*



*Circa Knob™ (CA)*



*Commonwealth® Lever (CHL)*



*Copa™ Knob (C)*



*Hancock™ Knob (H)*



*Laurel™ Knob (L)*



*Lido™ Lever (LL)*



*Pembroke™ Lever (PML)*

**NEW - Contemporary Series Interior Options**



*Phoenix® Knob (PE)*



*Tustin™ Lever (TNL)*



*NEW Katara® Lever (KTL)*



*NEW Vedani® Lever (VDL)*

**Kwikset Series Knob & Lever Interior Options**



*NEW Balboa® Lever (BL)*



*Cove® Knob (CV)*



*Delta™ Lever (DL)*



*Dorian® Lever (DNL)*

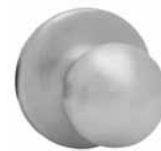

*Polo® Knob (P)*



*Tylo® Knob (T)*

# Signature Series

## Handlesets

### Signature Series Single Cylinder Handlesets - Keyed Exterior with Thumbturn Interior



Function	Design	Finish Options										
		L03	3	5	11P	15	15A	26	26D	501	502	514
Single Cylinder Handleset - For Pricing, add Outside Design (800) + Inside Design (966 or 974)												
Single Cylinder, Exterior (800)	<b>Signature Series Exterior Design</b>											
	Amherst (800AT-SMT)	-	-	-	\$265.00	\$265.00	-	-	-	-	-	-
	Arlington (800AN-SMT)	\$187.50	\$167.00	\$187.50	\$187.50	\$187.50	\$187.50	-	-	-	-	-
	Ashfield (800ADH-SMT)	\$241.50	-	\$241.50	\$241.50	\$241.50	-	\$241.50	-	\$251.50	\$251.50	\$251.50
	Avalon (800AVH-SMT)	\$241.50	-	\$241.50	\$241.50	\$241.50	-	\$241.50	-	\$251.50	\$251.50	\$251.50
	Chelsea (800CE-SMT)	\$187.50	\$167.00	\$187.50	\$187.50	\$187.50	\$187.50	\$187.50	\$187.50	-	-	-
	Hawthorne (800HE-SMT)	-	-	-	\$223.50	\$223.50	\$223.50	-	-	-	-	\$233.00
	Shelburne (800SE-SMT)	\$223.50	-	-	\$223.50	\$223.50	-	-	-	-	-	-
	Tavaris (800TVH-SMT)	-	-	-	\$241.50	\$241.50	-	\$241.50	\$241.50	-	-	-
	Wellington (800WN-SMT)	-	-	-	\$265.00	\$265.00	-	-	-	-	-	-
Single Cylinder, Interior Pack (966/974)	<b>Signature Series Interior Packs</b>											
	Abbey Knob(966A)	\$49.50	\$49.50	-	-	-	-	\$49.50	-	-	-	
	Ashfield Lever (966ADL)^	\$59.50	\$59.50	\$59.50	\$59.50	-	\$59.50	-	\$59.50	\$59.50	\$59.50	
	Avalon Lever (966AVL)^	\$59.50	\$59.50	\$59.50	\$59.50	-	\$59.50	-	\$59.50	\$59.50	\$59.50	
	Brooklane Lever (966BRL)^	-	\$59.50	\$59.50	\$59.50	\$59.50	-	-	-	-	-	
	Cameron Knob (966CN)	\$49.50	-	\$49.50	\$49.50	-	-	-	-	-	-	
	Circa Knob (966CA)	\$49.50	-	\$49.50	\$49.50	\$49.50	\$49.50	\$49.50	-	-	-	
	Commonwealth Lever (966CHL)^	\$59.50	\$59.50	\$59.50	\$59.50	\$59.50	\$59.50	\$59.50	\$59.50	\$59.50	\$59.50	
	Copa Knob (966C)	\$49.50	\$49.50	-	-	\$49.50	\$49.50	\$49.50	-	-	-	
	Hancock Knob (966H)	\$49.50	\$49.50	\$49.50	\$49.50	\$49.50	\$49.50	\$49.50	\$49.50	\$49.50	\$49.50	
	Laurel Lever (966L)^	-	-	\$59.50	\$59.50	\$59.50	\$59.50	-	-	-	\$59.50	
	Lido Lever (966LL)^	\$59.50	\$59.50	\$59.50	\$59.50	\$59.50	-	\$59.50	-	-	-	
	Pembroke Lever (966PML)^	\$59.50	\$59.50	\$59.50	\$59.50	\$59.50	\$59.50	-	\$59.50	\$59.50	\$59.50	
	Phoenix Knob (966PE)	\$49.50	\$49.50	\$49.50	\$49.50	-	-	\$49.50	-	-	-	
	Tustin Lever (966TNL)^	\$59.50	\$59.50	\$59.50	\$59.50	\$59.50	\$59.50	\$59.50	-	-	-	
	<b>Kwikset Series Interior Packs</b>											
	Balboa Lever (966BL)^	\$54.00	\$54.00	\$54.00	\$54.00	-	-	\$54.00	-	-	-	
	Cove Knob (966CV)	\$43.00	\$43.00	\$43.00	\$43.00	-	-	\$43.00	-	-	-	
	Delta Lever (966DL)^	\$54.00	\$54.00	-	-	\$54.00	\$54.00	\$54.00	-	-	-	
	Dorian Lever (966DNL)^	\$54.00	\$54.00	-	-	\$54.00	\$54.00	\$54.00	-	-	-	
Polo Knob (966P)	\$43.00	\$43.00	\$43.00	\$43.00	\$43.00	\$43.00	\$43.00	-	-	-		
Tylo Knob (966T)	\$43.00	\$43.00	-	-	-	\$43.00	\$43.00	-	-	-		
<b>Contemporary Series Interior Packs</b>												
NEW - Katara Lever (974KTL)^	-	-	\$59.50	\$59.50	-	\$59.50	\$59.50	-	-	-		
NEW - Vedani Lever (974VDL)^	-	-	\$59.50	\$59.50	-	\$59.50	\$59.50	-	-	-		

TIP: See Page 3 for "How to Order Handlesets"

**Notes:**

- ^ Specify door handing for Lever Design Interior Packs
- See page 12 for Gibson Design

**Signature Series Double Cylinder Handlesets - Keyed Exterior & Keyed Interior**

Function	Design	Finish Options										
		L03	3	5	11P	15	15A	26	26D	501	502	514
Double Cylinder Handleset - For Pricing, add Outside Design (801) + Inside Design (967 or 976)												
Double Cylinder, Exterior (801) 	<b>Signature Series Exterior Design</b>											
	Amherst (801AT-SMT)	-	-	-	\$271.00	\$271.00	-	-	-	-	-	-
	Arlington (801AN-SMT)	\$191.00	\$170.00	\$191.00	\$191.00	\$191.00	\$191.00	-	-	-	-	-
	Ashfield (801ADH-SMT)	\$246.00	-	\$246.00	\$246.00	\$246.00	-	\$246.00	-	\$256.00	\$256.00	\$256.00
	Avalon (801AVH-SMT)	\$246.00	-	\$246.00	\$246.00	\$246.00	-	\$246.00	-	\$256.00	\$256.00	\$256.00
	Chelsea (801CE-SMT)	\$191.00	\$170.00	\$191.00	\$191.00	\$191.00	\$191.00	\$191.00	\$191.00	-	-	-
	Hawthorne (801HE-SMT)	-	-	-	\$228.00	\$228.00	\$228.00	-	-	-	-	\$237.00
	Shelburne (801SE-SMT)	\$228.00	-	-	\$228.00	\$228.00	-	-	-	-	-	-
	Tavaris (801TVH-SMT)	-	-	-	\$246.00	\$246.00	-	\$246.00	\$246.00	-	-	-
Wellington (801WN-SMT)	-	-	-	\$271.00	\$271.00	-	-	-	-	-	-	
Double Cylinder, Interior Pack (967/976) 	<b>Signature Series Interior Packs</b>											
	Abbey Knob(967A)		\$71.50	\$71.50	-	-	-	-	\$71.50	-	-	-
	Ashfield Lever (967ADL)^		\$81.00	\$81.00	\$81.00	\$81.00	-	\$81.00	-	\$81.00	\$81.00	\$81.00
	Avalon Lever (967AVL)^		\$81.00	\$81.00	\$81.00	\$81.00	-	\$81.00	-	\$81.00	\$81.00	\$81.00
	Brooklane Lever (967BRL)^		-	\$81.00	\$81.00	\$81.00	\$81.00	-	-	-	-	-
	Cameron Knob (967CN)		\$71.50	-	\$71.50	\$71.50	-	-	-	-	-	-
	Circa Knob (967CA)		\$71.50	-	\$71.50	\$71.50	\$71.50	\$71.50	\$71.50	-	-	-
	Commonwealth Lever (967CHL)^		\$81.00	\$81.00	\$81.00	\$81.00	\$81.00	\$81.00	\$81.00	\$81.00	\$81.00	\$81.00
	Copa Knob (967C)		\$71.50	\$71.50	-	-	\$71.50	\$71.50	\$71.50	-	-	-
	Hancock Knob (967H)		\$71.50	\$71.50	\$71.50	\$71.50	\$71.50	\$71.50	\$71.50	\$71.50	\$71.50	\$71.50
	Laurel Lever (967L)^		-	-	\$81.00	\$81.00	\$81.00	\$81.00	-	-	-	\$81.00
	Lido Lever (967LL)^		\$81.00	\$81.00	\$81.00	\$81.00	\$81.00	-	\$81.00	-	-	-
	Pembroke Lever (967PML)^		\$81.00	\$81.00	\$81.00	\$81.00	\$81.00	\$81.00	-	\$81.00	\$81.00	\$81.00
	Phoenix Knob (967PE)		\$71.50	\$71.50	\$71.50	\$71.50	-	-	\$71.50	-	-	-
	Tustin Lever (967TNL)^		\$81.00	\$81.00	\$81.00	\$81.00	\$81.00	\$81.00	\$81.00	-	-	-
	<b>Kwikset Series Interior Packs</b>											
	Balboa Lever (967BL)^		\$69.00	\$69.00	\$69.00	\$69.00	-	-	\$69.00	-	-	-
	Cove Knob (967CV)		\$61.50	\$61.50	\$61.50	\$61.50	-	-	\$61.50	-	-	-
	Delta Lever (967DL)^		\$69.00	\$69.00	-	-	\$69.00	\$69.00	\$69.00	-	-	-
Dorian Lever (967DNL)^		\$69.00	\$69.00	-	-	\$69.00	\$69.00	\$69.00	-	-	-	
Polo Knob (967P)		\$61.50	\$61.50	\$61.50	\$61.50	\$61.50	\$61.50	\$61.50	-	-	-	
Tylo Knob (967T)		\$61.50	\$61.50	-	-	-	\$61.50	\$61.50	-	-	-	
<b>Contemporary Series Interior Packs</b>												
NEW - Katara Lever (976KTL)^		-	-	\$81.00	\$81.00	-	\$81.00	\$81.00	-	-	-	
NEW - Vedani Lever (976VDL)^		-	-	\$81.00	\$81.00	-	\$81.00	\$81.00	-	-	-	



*TIP: See Page 3 for "How to Order Handlesets"*

**Notes:**

- ^ Specify door handing for Lever Design Interior Packs
- See page 12 for Gibson Design

# Signature Series Handlesets

## Signature Series Dummy Handlesets - Non Keyed for Inactive Doors

Function	Design	Finish Options										
		L03	3	5	11P	15	15A	26	26D	501	502	514
Dummy Handleset - For Pricing, add Outside Design (802) + Inside Design (968 or 977)												
Dummy, Exterior (802) 	<b>Signature Series Exterior Design</b>											
	Amherst (802AT)	-	-	-	\$233.00	\$233.00	-	-	-	-	-	-
	Arlington (802A)	\$165.00	\$147.00	\$165.00	\$165.00	\$165.00	\$165.00	-	-	-	-	-
	Ashfield (802ADH)	\$212.00	-	\$212.00	\$212.00	\$212.00	-	\$212.00	-	\$220.50	\$220.50	\$220.50
	Avalon (802AVH)	\$212.00	-	\$212.00	\$212.00	\$212.00	-	\$212.00	-	\$220.50	\$220.50	\$220.50
	Chelsea (802CE)	\$165.00	\$147.00	\$165.00	\$165.00	\$165.00	\$165.00	\$165.00	\$165.00	-	-	-
	Hawthorne (802HE)	-	-	-	\$196.50	\$196.50	\$196.50	-	-	-	-	\$204.00
	Shelburne (802SE)	\$196.50	-	-	\$196.50	\$196.50	-	-	-	-	-	-
	Tavaris (802TVH)	-	-	-	\$212.00	\$212.00	-	\$212.00	\$212.00	-	-	-
Wellington (802WN)	-	-	-	\$233.00	\$233.00	-	-	-	-	-	-	
Dummy, Interior Pack (968/977) 	<b>Signature Series Interior Packs</b>											
	Abbey Knob(968A)		\$39.00	\$39.00	-	-	-	-	\$39.00	-	-	-
	Ashfield Lever (968ADL)^	\$48.50	\$48.50	\$48.50	\$48.50	-	\$48.50	-	\$48.50	\$48.50	\$48.50	
	Avalon Lever (968AVL)^	\$48.50	\$48.50	\$48.50	\$48.50	-	\$48.50	-	\$48.50	\$48.50	\$48.50	
	Brooklane Lever (968BRL)^	-	\$48.50	\$48.50	\$48.50	\$48.50	-	-	-	-	-	
	Cameron Knob (968CN)	\$39.00	-	\$39.00	\$39.00	-	-	-	-	-	-	
	Circa Knob (968CA)	\$39.00	-	\$39.00	\$39.00	\$39.00	\$39.00	\$39.00	\$39.00	-	-	
	Commonwealth Lever (968CHL)^	\$48.50	\$48.50	\$48.50	\$48.50	\$48.50	\$48.50	\$48.50	\$48.50	\$48.50	\$48.50	
	Copa Knob (968C)	\$39.00	\$39.00	-	-	\$39.00	\$39.00	\$39.00	\$39.00	-	-	
	Hancock Knob (968H)	\$39.00	\$39.00	\$39.00	\$39.00	\$39.00	\$39.00	\$39.00	\$39.00	\$39.00	\$39.00	
	Laurel Lever (968L)^	-	-	\$48.50	\$48.50	\$48.50	\$48.50	-	-	-	\$48.50	
	Lido Lever (968LL)^	\$48.50	\$48.50	\$48.50	\$48.50	\$48.50	-	\$48.50	-	-	-	
	Pembroke Lever (968PML)^	\$48.50	\$48.50	\$48.50	\$48.50	\$48.50	\$48.50	-	\$48.50	\$48.50	\$48.50	
	Phoenix Knob (968PE)	\$39.00	\$39.00	\$39.00	\$39.00	-	-	\$39.00	-	-	-	
	Tustin Lever (968TNL)^	\$48.50	\$48.50	\$48.50	\$48.50	\$48.50	\$48.50	\$48.50	\$48.50	-	-	
	<b>Kwikset Series Interior Packs</b>											
	Balboa Lever (968BL)^	\$45.50	\$45.50	\$45.50	\$45.50	-	-	\$45.50	-	-	-	
	Cove Knob (968CV)	\$32.50	\$32.50	\$32.50	\$32.50	-	-	\$32.50	-	-	-	
	Delta Lever (968DL)^	\$45.50	\$45.50	-	-	\$45.50	\$45.50	\$45.50	-	-	-	
	Dorian Lever (968DNL)^	\$45.50	\$45.50	-	-	\$45.50	\$45.50	\$45.50	-	-	-	
Polo Knob (968P)	\$32.50	\$32.50	\$32.50	\$32.50	\$32.50	\$32.50	\$32.50	-	-	-		
Tylo Knob (968T)	\$32.50	\$32.50	-	-	-	\$32.50	\$32.50	-	-	-		
<b>Contemporary Series Interior Packs</b>												
NEW - Katara Lever (977KTL)^	-	-	\$48.50	\$48.50	-	\$48.50	\$48.50	-	-	-		
NEW - Vedani Lever (977VDL)^	-	-	\$48.50	\$48.50	-	\$48.50	\$48.50	-	-	-		

**TIP: See Page 3 for "How to Order Handlesets"**

**Notes:**

- ^ Specify door handing for all Lever Design Interior Packs
- See page 12 for Gibson Design

**Gibson Handleset Design**

**Features**

- **Two Point Locking System**
- ANSI/BHMA A156.5 Grade 2 Deadbolt
- Solid Forged Brass
- SmartKey™



Gibson® (GN)



*TIP: See Page 3 for "How to Order Handlesets"*

**Notes:**

- ^ Specify door handing for all Lever Design Interior Packs
- 1 Gibson Handlesets include SmartKey™ cylinder standard

**Signature Series Single Cylinder Handleset - Gibson Design Keyed Exterior with Thumbturn Interior**

Function	Design	Finish Options										
		L03	3	5	11P	15	15A	26	26D	501	502	514
Single Cylinder Handleset - For Pricing, add 553 Outside Design + 986 Inside Design												
Single Cylinder, Exterior (553)	Gibson (553GN-SMT)	\$248.50	\$210.00	\$248.50	-	\$248.50	-	-	-	-	-	-
	Abbey (986A)	\$49.50	\$49.50	-	-	-	\$49.50	\$49.50	-	-	-	
Single Cylinder, Interior Pack (986)	Brooklane (986BRL)	-	-	\$59.50	-	-	-	-	-	-	-	
	Cameron (986CN)	\$49.50	\$49.50	\$49.50	\$49.50	\$49.50	\$49.50	-	-	-		
	Circa (986CA)	\$49.50	\$49.50	\$49.50	\$49.50	\$49.50	\$49.50	\$49.50	-	-		
	Commonwealth (986CHL)	-	-	\$59.50	-	-	-	-	-	-		
	Copa (986C)	\$49.50	\$49.50	-	-	\$49.50	\$49.50	\$49.50	-	-		
	Hancock (986H)	\$49.50	\$49.50	\$49.50	\$49.50	\$49.50	\$49.50	\$49.50	-	-		
	Laurel (986L)	\$59.50	\$59.50	\$59.50	\$59.50	\$59.50	\$59.50	-	-	-		
	Lido (986LL)	\$59.50	\$59.50	-	\$59.50	\$59.50	\$59.50	\$59.50	-	-		
	Tustin (986TNL)^	\$59.50	\$59.50	\$59.50	\$59.50	\$59.50	\$59.50	\$59.50	-	-		
	Delta (986DL)^	\$54.00	\$54.00	-	-	\$54.00	\$54.00	\$54.00	-	-		
	Dorian (986DNL)^	\$54.00	\$54.00	-	\$54.00	\$54.00	\$54.00	\$54.00	-	-		
	Polo (986P)	\$43.00	\$43.00	-	\$43.00	\$43.00	\$43.00	\$43.00	-	-		
	Tylo (986T)	\$43.00	\$43.00	-	-	-	\$43.00	\$43.00	-	-		

### Signature Series Double Cylinder Handleset - Gibson Design Keyed Exterior & Keyed Interior

Function	Design	Finish Options										
		L03	3	5	11P	15	15A	26	26D	501	502	514
Double Cylinder Handleset - For Pricing, add 554 Outside Design + 987 Inside Design												
 Double Cylinder, Exterior (554)	Gibson (554GN-SMT)	\$255.50	\$216.00	\$255.50	-	\$255.50	-	-	-	-	-	-
	Abbey (987A)	\$71.50	\$71.50	-	-	-	\$71.50	\$71.50	-	-	-	
	Brooklane (987BRL)	-	-	\$81.00	-	-	-	-	-	-	-	
	Cameron (987CN)	\$71.50	\$71.50	\$71.50	\$71.50	\$71.50	\$71.50	-	-	-	-	
	Circa (987CA)	\$71.50	\$71.50	\$71.50	\$71.50	\$71.50	\$71.50	\$71.50	-	-	-	
	Commonwealth (987CHL)	-	-	\$81.00	-	-	-	-	-	-	-	
	Copa (987C)	\$71.50	\$71.50	-	-	\$71.50	\$71.50	\$71.50	-	-	-	
	Hancock (987H)	\$71.50	\$71.50	\$71.50	\$71.50	\$71.50	\$71.50	\$71.50	-	-	-	
	Laurel (987L)	\$81.00	\$81.00	\$81.00	\$81.00	\$81.00	\$81.00	-	-	-	-	
	Lido (987LL)	\$81.00	\$81.00	-	\$81.00	\$81.00	\$81.00	\$81.00	-	-	-	
	Tustin (987TNL)^	\$81.00	\$81.00	\$81.00	\$81.00	\$81.00	\$81.00	\$81.00	-	-	-	
	Delta (987DL)^	\$69.00	\$69.00	-	-	\$69.00	\$69.00	\$69.00	-	-	-	
	Dorian (987DNL)^	\$69.00	\$69.00	-	\$69.00	\$69.00	\$69.00	\$69.00	-	-	-	
Polo (987P)	\$61.50	\$61.50	-	\$61.50	\$61.50	\$61.50	\$61.50	-	-	-		
Tylo (987T)	\$61.50	\$61.50	-	-	-	\$61.50	\$61.50	-	-	-		

### Signature Series Dummy Handleset - Gibson Design Non Keyed for Inactive Doors

Function	Design	Finish Options										
		L03	3	5	11P	15	15A	26	26D	501	502	514
Dummy Handleset - For Pricing, add 555 Outside Design + 989 Inside Design												
 Dummy, Exterior (555)	Gibson (555GN)	\$205.00	\$173.50	\$205.00	-	\$205.00	-	-	-	-	-	-
	Abbey (989A)	\$39.00	\$39.00	-	-	-	\$39.00	\$39.00	-	-	-	
	Brooklane (989BRL)	-	-	\$48.50	-	-	-	-	-	-	-	
	Cameron (989CN)	\$39.00	\$39.00	\$39.00	\$39.00	\$39.00	\$39.00	-	-	-	-	
	Circa (989CA)	\$39.00	\$39.00	\$39.00	\$39.00	\$39.00	\$39.00	\$39.00	-	-	-	
	Commonwealth (989CHL)	-	-	\$48.50	-	-	-	-	-	-	-	
	Copa (989C)	\$39.00	\$39.00	-	-	\$39.00	\$39.00	\$39.00	-	-	-	
	Hancock (989H)	\$39.00	\$39.00	\$39.00	\$39.00	\$39.00	\$39.00	\$39.00	-	-	-	
	Laurel (989L)	\$48.50	\$48.50	\$48.50	\$48.50	\$48.50	\$48.50	-	-	-	-	
	Lido (989LL)	\$48.50	\$48.50	-	\$48.50	\$48.50	\$48.50	\$48.50	-	-	-	
	Tustin (989TNL)^	\$48.50	\$48.50	\$48.50	\$48.50	\$48.50	\$48.50	\$48.50	-	-	-	
	Delta (989DL)^	\$45.50	\$45.50	-	-	\$45.50	\$45.50	\$45.50	-	-	-	
	Dorian (989DNL)^	\$45.50	\$45.50	-	\$45.50	\$45.50	\$45.50	\$45.50	-	-	-	
Polo (989P)	\$32.50	\$32.50	-	\$32.50	\$32.50	\$32.50	\$32.50	-	-	-		
Tylo (989T)	\$32.50	\$32.50	-	-	-	\$32.50	\$32.50	-	-	-		



**Features & Specifications**

**Door Prep**

- Crossbore 2-1/8" or 1-1/2". Edge Bore 1" Latch Face 1" x 2-1/4"

**Backset**

- Adjustable to 2-3/8" or 2-3/4"

**Door Thickness**

- 1-3/4" doors standard

**Cylinder**

- SmartKey™ standard

**Latch Faceplate**

- 1" x 2-1/4" Interchangeable: Round corner, square corner or drive-in

**Strikes**

- 2-1/4" full lip

**Bolt**

- 1/2" throw

**Door Handing**

- Reversible for right- or left-hand doors

**ANSI/BHMA**

- A156.2 Grade 2

**Signature Series Knob Functions**

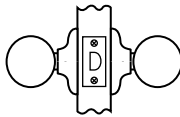
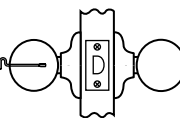
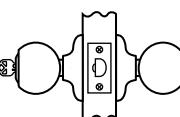
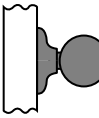
Model/Function	Description
 <p>720</p>	<b>Passage/Hall/Closet</b> Both knobs always free.
 <p>730</p>	<b>Privacy/Bed/Bath</b> Both knobs locked or unlocked by turnbutton inside. Outside knob unlocked by emergency key.
 <p>740</p>	<b>Entry</b> Both knobs locked or unlocked by key outside or turnbutton inside.
 <p>788</p>	<b>Half Dummy Trim</b> Surface mounted; for doors where only a pull is required. No operations.

**Signature Series Knob Dimensions**

Design	A	B	C
Abbey (A)	2-5/8"	2-3/4"	2-1/32"
Cameron (CN)	2-5/8"	3"	2-1/8"
Circa (CA)	2-5/8"	2-3/4"	2-1/8"
Copa (C)	2-5/8"	2-3/8"	2-1/8"
Hancock (H)	2-5/8"	2-3/4"	2-3/8"
Laurel (L)	2-5/8"	2-5/8"	2-7/16"
Phoenix (PE)	2-5/8"	2-1/4"	2-3/16"

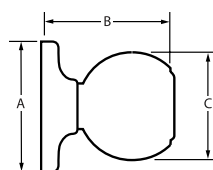

**Abbey® Knob (A)**



Abbey (A)

Model	Function	Finish										
		L03	3	5	11P	15	15A	26	26D	501	502	514
720A	Passage/Hall/Closet	-	\$25.00	\$29.00	-	-	-	-	\$29.00	-	-	-
730A	Privacy/Bed/Bath	-	\$27.50	\$31.00	-	-	-	\$31.00	-	-	-	-
740A-SMT	Entry w/SmartKey™	-	\$49.50	\$55.50	-	-	-	\$55.50	-	-	-	-
788A	Half Dummy Trim	-	\$11.50	\$13.00	-	-	-	\$13.00	-	-	-	-

**Cameron™ Knob (CN)**



Cameron (CN)

Model	Function	Finish										
		L03	3	5	11P	15	15A	26	26D	501	502	514
720CN	Passage/Hall/Closet	-	\$22.50	-	\$27.00	\$27.00	-	-	-	-	-	-
730CN	Privacy/Bed/Bath	-	\$24.50	-	\$28.50	\$28.50	-	-	-	-	-	-
740CN-SMT	Entry w/SmartKey™	-	\$46.50	-	\$48.50	\$48.50	-	-	-	-	-	-
788CN	Half Dummy Trim	-	\$11.50	-	\$12.50	\$12.50	-	-	-	-	-	-

# Signature Series

## Knobs

Kwikset

### Circa™ Knob (CA)

Model	Function	Finish										
		L03	3	5	11P	15	15A	26	26D	501	502	514
720CA	Passage/Hall/Closet	-	\$32.00	-	\$38.50	\$38.50	\$38.50	\$38.50	\$38.50	-	-	-
730CA	Privacy/Bed/Bath	-	\$36.00	-	\$42.00	\$42.00	\$42.00	\$42.00	\$42.00	-	-	-
740CA-SMT	Entry w/SmartKey™	-	\$60.50	-	\$69.00	\$69.00	\$69.00	\$69.00	\$69.00	-	-	-
788CA	Half Dummy Trim	-	\$14.50	-	\$17.00	\$17.00	\$17.00	\$17.00	\$17.00	-	-	-



Circa (CA)

### Copa™ Knob (C)

Model	Function	Finish										
		L03	3	5	11P	15	15A	26	26D	501	502	514
720C	Passage/Hall/Closet	-	\$22.50	\$27.00	-	\$27.00	\$27.00	\$27.00	\$27.00	-	-	-
730C	Privacy/Bed/Bath	-	\$24.50	\$28.50	-	\$28.50	\$28.50	\$28.50	\$28.50	-	-	-
740C-SMT	Entry w/SmartKey™	-	\$46.50	\$48.50	-	\$48.50	\$48.50	\$48.50	\$48.50	-	-	-
788C	Half Dummy Trim	-	\$10.50	\$12.50	-	\$12.50	\$12.50	\$12.50	\$12.50	-	-	-



Copa (C)

### Hancock™ Knob (H)

Model	Function	Finish										
		L03	3	5	11P	15	15A	26	26D	501	502	514
720H	Passage/Hall/Closet	\$30.00	\$25.00	\$30.00	\$30.00	\$30.00	\$30.00	\$30.00	\$30.00	\$31.00	\$31.00	\$31.00
730H	Privacy/Bed/Bath	-	\$26.50	\$32.00	\$32.00	\$32.00	\$32.00	\$32.00	\$32.00	\$34.00	\$34.00	\$34.00
740H-SMT	Entry w/SmartKey™	\$54.50	\$48.00	\$54.50	\$54.50	\$54.50	\$54.50	\$54.50	\$54.50	\$56.50	\$56.50	\$56.50
788H	Half Dummy Trim	\$13.50	\$11.50	\$13.50	\$13.50	\$13.50	\$13.50	\$13.50	\$13.50	\$14.00	\$14.00	\$14.00



Hancock (H)

### Laurel™ Knob (L)

Model	Function	Finish										
		L03	3	5	11P	15	15A	26	26D	501	502	514
720L	Passage/Hall/Closet	-	-	-	\$50.50	\$50.50	\$50.50	\$50.50	-	-	-	\$52.50
730L	Privacy/Bed/Bath	-	-	-	\$53.50	\$53.50	\$53.50	\$53.50	-	-	-	\$56.00
740L-SMT	Entry w/SmartKey™	-	-	-	\$88.00	\$88.00	\$88.00	\$88.00	-	-	-	\$91.50
788L	Half Dummy Trim	-	-	-	\$23.00	\$23.00	\$23.00	\$23.00	-	-	-	\$24.00



Laurel (L)

### Phoenix® Knob (PE)

Model	Function	Finish										
		L03	3	5	11P	15	15A	26	26D	501	502	514
720PE	Passage/Hall/Closet	-	\$27.00	\$30.00	\$37.00	\$30.00	-	-	-	-	-	-
730PE	Privacy/Bed/Bath	-	\$31.50	\$34.00	\$41.00	\$34.00	-	-	-	-	-	-
740PE-SMT	Entry w/SmartKey™	-	\$55.00	\$55.00	\$61.50	\$55.00	-	-	-	-	-	-
788PE	Half Dummy Trim	-	\$11.00	\$12.50	\$19.50	\$12.50	-	-	-	-	-	-



Phoenix (PE)

Features & Specifications

Door Prep

- Crossbore 2-1/8" or 1-1/2". Edge Bore 1" Latch Face 1" x 2-1/4"

Backset

- Adjustable to 2-3/8" or 2-3/4"

Door Thickness

- 1-3/8" to 1-3/4" doors standard

Cylinder

- SmartKey™

Latch Faceplate

- 1" x 2-1/4" Interchangeable: Round corner, square corner or drive-in

Strikes

- 2-1/4" full lip

Bolt

- 1/2" throw

Door Handing

- Reversible  
*NOTE: Specify LH/RH for 788 Function*

ANSI/BHMA

- A156.2 Grade 2

Signature Series Lever Functions

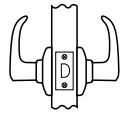
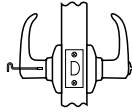
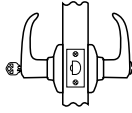
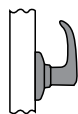
Model/Function	Description
 720	<b>Passage/Hall/Closet</b> Both levers always free.
 730	<b>Privacy/Bed/Bath</b> Both levers locked or unlocked by turnbutton inside. Outside lever unlocked by emergency key.
 740	<b>Entry</b> Both levers locked or unlocked by key outside or turnbutton inside.
 788	<b>Half Dummy Trim</b> Surface mounted; for doors where only a pull is required.

Signature Series Lever Dimensions

Design	A	B	C
Ashfield (ADL)	2-5/8"	4-3/16"	2-9/16"
Avalon (AVL)	2-5/8"	4-1/4"	2-1/2"
Brooklane (BRL)	2-5/8"	4-3/16"	2-3/16"
Commonwealth (CHL)	2-5/8"	3-5/8"	1-15/16"
Lido (LL)	2-5/8"	3-3/4"	1-15/16"
Pembroke (PML)	2-5/8"	4-7/32"	2-7/16"
Tustin (TNL)	2-5/8"	3-3/4"	1-15/16"
NEW - Katara (KTL)	2-5/8"		
NEW - Vedani (VDL)	2-5/8"		

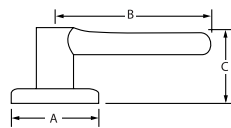

Ashfield™ Lever (ADL)



Ashfield (ADL)

Model	Function	Finish										
		L03	3	5	11P	15	15A	26	26D	501	502	514
720ADL	Passage/Hall/Closet	-	-	-	\$58.00	\$58.00	-	\$58.00	-	\$60.50	\$60.50	\$60.50
730ADL	Privacy/Bed/Bath	-	-	-	\$62.00	\$62.00	-	\$62.00	-	\$65.00	\$65.00	\$65.00
740ADL-SMT	Entry w/SmartKey™	-	-	-	\$106.00	\$106.00	-	\$106.00	-	\$110.00	\$110.00	\$110.00
788ADL	Half Dummy Trim	-	-	-	\$26.50	\$26.50	-	\$26.50	-	\$27.50	\$27.50	\$27.50

Avalon™ Lever (AVL)



Avalon (AVL)

Model	Function	Finish										
		L03	3	5	11P	15	15A	26	26D	501	502	514
720AVL	Passage/Hall/Closet	-	-	-	\$58.00	\$58.00	-	\$58.00	-	\$60.50	\$60.50	\$60.50
730AVL	Privacy/Bed/Bath	-	-	-	\$62.00	\$62.00	-	\$62.00	-	\$65.00	\$65.00	\$65.00
740AVL-SMT	Entry w/SmartKey™	-	-	-	\$106.00	\$106.00	-	\$106.00	-	\$110.00	\$110.00	\$110.00
788AVL	Half Dummy Trim	-	-	-	\$26.50	\$26.50	-	\$26.50	-	\$27.50	\$27.50	\$27.50

\*Specify door handing for Avalon dummy trim levers.

# Signature Series Levers

## Brooklane® Lever (BRL)

Model	Function	Finish										
		L03	3	5	11P	15	15A	26	26D	501	502	514
720BRL	Passage/Hall/Closet	-	-	-	\$58.00	\$58.00	\$58.00	-	-	-	-	-
730BRL	Privacy/Bed/Bath	-	-	-	\$62.00	\$62.00	\$62.00	-	-	-	-	-
740BRL-SMT	Entry w/SmartKey™	-	-	-	\$106.00	\$106.00	\$106.00	-	-	-	-	-
788BRL	Half Dummy Trim*	-	-	-	\$26.50	\$26.50	\$26.50	-	-	-	-	-

\*Specify door handing for Brooklane dummy trim levers.



Brooklane (BRL)

## Commonwealth® Lever (CHL)

Model	Function	Finish										
		L03	3	5	11P	15	15A	26	26D	501	502	514
720CHL	Passage/Hall/Closet	\$54.00	\$46.00	\$54.00	\$54.00	\$54.00	\$54.00	\$54.00	\$54.00	\$56.50	\$56.50	\$56.50
730CHL	Privacy/Bed/Bath	-	\$48.50	\$57.00	\$57.00	\$57.00	\$57.00	\$57.00	\$57.00	\$60.00	\$60.00	\$60.00
740CHL-SMT	Entry w/SmartKey™	\$100.00	\$85.00	\$100.00	\$100.00	\$100.00	\$100.00	\$100.00	\$100.00	\$103.50	\$103.50	\$103.50
788CHL	Half Dummy Trim*	-	\$21.00	\$24.50	\$24.50	\$24.50	\$24.50	\$24.50	\$24.50	\$26.50	\$26.50	\$26.50

\*Specify door handing for Commonwealth dummy trim levers.



Commonwealth (CHL)

## Lido® Lever (LL)

Model	Function	Finish										
		L03	3	5	11P	15	15A	26	26D	501	502	514
720LL	Passage/Hall/Closet	-	\$37.50	\$42.00	\$42.00	\$42.00	\$42.00	-	\$42.00	-	-	-
730LL	Privacy/Bed/Bath	-	\$40.00	\$44.00	\$44.00	\$44.00	\$44.00	-	\$44.00	-	-	-
740LL-SMT	Entry w/SmartKey™	-	\$61.00	\$67.00	\$67.00	\$67.00	\$67.00	-	\$67.00	-	-	-
788LL	Half Dummy Trim*	-	\$17.00	\$19.00	\$19.00	\$19.00	\$19.00	-	\$19.00	-	-	-

\*Specify door handing for Lido dummy trim levers.



Lido (LL)

## Pembroke™ Lever (PML)

Model	Function	Finish										
		L03	3	5	11P	15	15A	26	26D	501	502	514
720PML	Passage/Hall/Closet	\$58.00	\$49.00	\$58.00	\$58.00	\$58.00	\$58.00	\$58.00	-	\$60.50	\$60.50	\$60.50
730PML	Privacy/Bed/Bath	\$62.00	\$52.50	\$62.00	\$62.00	\$62.00	\$62.00	\$62.00	-	\$66.00	\$66.00	\$66.00
740PML-SMT	Entry w/SmartKey™	\$106.00	\$90.00	\$106.00	\$106.00	\$106.00	\$106.00	\$106.00	-	\$110.00	\$110.00	\$110.00
788PML	Half Dummy Trim*	\$26.50	\$22.50	\$26.50	\$26.50	\$26.50	\$26.50	\$26.50	-	\$27.50	\$27.50	\$27.50

\*Specify door handing for Pembroke dummy trim levers.



Pembroke (PML)

## Tustin™ Lever (TNL)

Model	Function	Finish										
		L03	3	5	11P	15	15A	26	26D	501	502	514
720TNL	Passage/Hall/Closet	-	\$37.50	\$42.00	\$42.00	\$42.00	\$42.00	\$42.00	\$42.00	-	-	-
730TNL	Privacy/Bed/Bath	-	\$40.00	\$44.00	\$44.00	\$44.00	\$44.00	\$44.00	\$44.00	-	-	-
740TNL-SMT	Entry w/SmartKey™	\$67.00	\$61.00	\$67.00	\$67.00	\$67.00	\$67.00	\$67.00	\$67.00	-	-	-
788TNL	Half Dummy Trim*	-	\$17.00	\$19.00	\$19.00	\$19.00	\$19.00	\$19.00	\$19.00	-	-	-

\*Specify door handing for Tustin dummy trim levers.



Tustin (TNL)



**NEW - Katara® Lever (KTL)**

Model	Function	Finish										
		L03	3	5	11P	15	15A	26	26D	501	502	514
720KTL	Passage/Hall/Closet	-	-	-	\$54.00	\$54.00	-	\$54.00	\$54.00	-	-	-
730KTL	Privacy/Bed/Bath	-	-	-	\$57.00	\$57.00	-	\$57.00	\$57.00	-	-	-
740KTL-SMT	Entry w/SmartKey™	-	-	-	\$100.00	\$100.00	-	\$100.00	\$100.00	-	-	-
788KTL	Half Dummy Trim*	-	-	-	\$24.50	\$24.50	-	\$24.50	\$24.50	-	-	-

Katara (KTL)

\* Specify door handing for Katara dummy trim levers.



**NEW - Vedani® Lever (VDL)**

Model	Function	Finish										
		L03	3	5	11P	15	15A	26	26D	501	502	514
720VDL	Passage/Hall/Closet	-	-	-	\$54.00	\$54.00	-	\$54.00	\$54.00	-	-	-
730VDL	Privacy/Bed/Bath	-	-	-	\$57.00	\$57.00	-	\$57.00	\$57.00	-	-	-
740VDL-SMT	Entry w/SmartKey™	-	-	-	\$100.00	\$100.00	-	\$100.00	\$100.00	-	-	-
788VDL	Half Dummy Trim	-	-	-	\$24.50	\$24.50	-	\$24.50	\$24.50	-	-	-

Vedani (VDL)

*Signature Series*

# New Contemporary Designs

We are proud to announce the launch of the new contemporary style as part of our Kwikset Signature Series line. With five additional products, the contemporary family provides a modern approach to security door hardware.

## Features & Benefits

- Features SmartKey® Re-key Technology with BumpGuard™ protection
- Available in a variety of finishes - Satin Nickel, Polished Chrome, Satin Chrome, Venetian Bronze
- Lifetime Finish & Mechanical Warranty

Upgrade your lever to give your home a designer touch



- Two decorative rose styles - Arched and Oval
- Easily installs on any Kwikset Signature Series reversible lever chassis\*
- Sold as an accessory item

**Designer Roses** (Sold in Pairs, 1 Pair required for each Lever Lockset)

Model	Style	Finish										
		L03	3	5	11P	15	15A	26	26D	501	502	514
ART-83319	Arched Rose / Pair	-	-	-	\$20.00	\$20.00	-	-	-	-	-	\$21.50
OVT-83318	Oval Rose / Pair	-	-	-	\$20.00	\$20.00	-	-	-	-	-	\$21.50

**Features & Specifications**

**Door Prep**

- Crossbore 2-1/8" or 1-1/2". Edge Bore 1" Latch Face 1" x 2-1/4"

**Backset**

- Adjustable to 2-3/8" or 2-3/4"

**Door Thickness**

- **980/985:** 1-3/4" only
- **780/785:** 1-3/8" – 1-3/4" doors standard (1-7/8" – 2-1/4" optional)

**Cylinder**

- SmartKey™ cylinder standard

**Faceplate**

- 1" x 2-1/4"

**Strikes**

- 1-1/4" x 3-5/8"

**Bolt**

- **980/985:** 1" throw
- **780/785:** 1" throw

**Door Handing**

- Reversible for right- or left-hand doors

**ANSI/BHMA**

- **980/985:** A156.5 Grade 1
- **780/785:** A156.5 Grade 2

**Signature Series Deadbolt Functions**

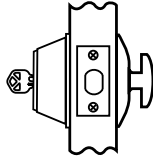
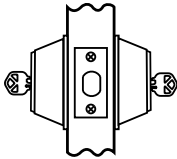
Model/Function	Description
 <p>980 993 780</p>	<b>Single Cylinder</b> - Deadbolt operated by key outside and thumbturn inside.
 <p>985 994 785</p>	<b>Double Cylinder</b> - Deadbolt operated by key both sides.

**Signature Series Deadbolt Dimensions**

Design	A	B	C
980 Interior	2-9/16"	1-5/32"	1-13/16"
980 Exterior	2-5/8"	1-1/16"	
985 Interior	2-5/8"	1-1/16"	
985 Exterior	2-5/8"	1-1/16"	
993 Interior	2-9/16"	1-5/32"	1-13/16"
993 Exterior	2-5/8"	1-1/16"	
994 Interior	2-5/8"	1-1/16"	
994 Exterior	2-5/8"	1-1/16"	
780 Interior	2-5/8"	1-1/16"	1-15/16"
780 Exterior	2-5/8"	1-5/32"	
785 Interior	2-5/8"	1-5/32"	
785 Exterior	2-5/8"	1-5/32"	

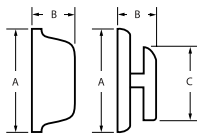

# Signature Series

## Deadbolts

### 980/985 Deadbolt

The Signature Series deadbolts features SmartKey™, an Ultra-strike door jamb brace, and a 1" brass throw deadbolt with a Titanium alloy core.

Model	Function	Finish									
		L03	5	11P	15	15A	26	26D	501	502	514
980-SMT	Single w/SmartKey™	\$62.50	-	\$62.50	\$62.50	-	-	-	\$65.00	\$65.00	\$65.00
985-SMT	Double w/SmartKey™	\$89.00	-	\$89.00	\$89.00	-	-	-	\$92.50	\$92.50	\$92.50



980/985

### NEW - Contemporary Square 993/994 Deadbolt

The Signature Series deadbolts features SmartKey™, an Ultra-strike door jamb brace, and a 1" brass throw deadbolt with a Titanium alloy core.

Model	Function	Finish									
		L03	5	11P	15	15A	26	26D	501	502	514
993SQT-SMT	Single w/SmartKey™	-	-	\$62.50	\$62.50	-	\$62.50	\$62.50	-	-	-
994SQT-SMT	Double w/SmartKey™	-	-	\$89.00	\$89.00	-	\$89.00	\$89.00	-	-	-



993SQT/994SQT

### NEW - Contemporary Round 993/994 Deadbolt

The Signature Series deadbolts features SmartKey™, an Ultra-strike door jamb brace, and a 1" brass throw deadbolt with a Titanium alloy core.

Model	Function	Finish									
		L03	5	11P	15	15A	26	26D	501	502	514
993RDT-SMT	Single w/SmartKey™	-	-	\$62.50	\$62.50	-	\$62.50	\$62.50	-	-	-
994RDT-SMT	Double w/SmartKey™	-	-	\$89.00	\$89.00	-	\$89.00	\$89.00	-	-	-



993RDT/994RDT

### 780/785 Deadbolts

Premium security features including SmartKey™ cylinder.

Model	Function	Finish										
		L03	3	5	11P	15	15A	26	26D	501	502	514
780-SMT	Single w/SmartKey™	\$55.00	\$46.50	\$55.00	\$55.00	\$55.00	\$55.00	\$55.00	\$55.00	-	-	-
785-SMT	Double w/SmartKey™	\$76.00	\$71.00	\$76.00	\$76.00	\$76.00	\$76.00	\$76.00	\$76.00	-	-	-



780/785



**Features & Specifications**

**Door Prep**

- Crossbore 2-1/8". Edge Bore 1" Latch Face 1" x 2-1/4"

**Backset**

- Adjustable to 2-3/8" or 2-3/4"

**Door Thickness**

- 1-3/8" to 2" doors standard

**Cylinder**

- SmartKey™ cylinder standard

**Faceplate**

- 1" x 2-1/4"

**Strikes**

- 2-3/4" x 2-1/8"

**Bolt**

- 1" throw

**Door Handing**

- Reversible for right- or left-hand doors

**SmartCode 909 Deadbolt Function**

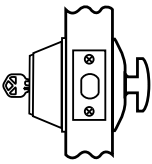
Model/Function	Description
	<p>909</p> <p><b>Single Cylinder</b> - Deadbolt operated by Electronic touchpad or key outside and thumbturn inside.</p>

**SmartCode Dimensions**

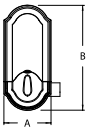
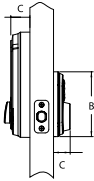
Design	A	B	C
	3-1/4"	7-3/16"	1-5/32"
		4-7/16"	1-5/32"



**SmartCode™ 909 Touchpad Deadbolt**

SmartCode provides the convenience of keyless access for today's active lifestyle. The latest in electronic technology operates on just 4 AA batteries and permits access with your personalized code or a key. It is easy to install, easy to program and easy to use. SmartCode requires no wiring and easily replaces existing door hardware.

- One Touch Locking, Full 1" Projection Deadbolt
- Four to Eight Digit Personal Entry Code, Two Code Capacity
- Easy to Install, Easy to Program, Easy to Use
- SmartKey Cylinder

Model	Function	Finish							
		L03	3	5	11P	15	15A	26	26D
909-SMT	Single Cylinder	\$227.25	-	-	\$233.50	\$233.50	-	-	-

# Signature Series

## SmartCode 911 Lever

### SmartCode 911 Lever Function

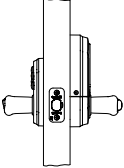
Model/Function	Description
 911	<b>Keyed Entry</b> - Lock operated by electronic touchpad or key outside and thumbturn inside.

### SmartCode Lever Dimensions

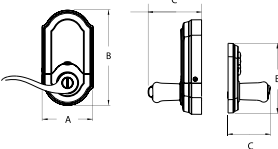
Design	A	B	C
 911 Interior	3-9/32"	6-5/32"	3-13/32"
911 Exterior	2-13/16"	4-7/16"	1-3/16"

#### Finish & Lever Options:

Tustin Lever in  
11P Venetian Bronze

Lido Lever in  
L03 Bright Brass

Tustin Lever in  
US15 Satin Nickel



### Features & Specifications

#### Door Prep

- Crossbore 2-1/8". Edge Bore 1"

#### Backset

- Adjustable to 2-3/8" or 2-3/4"

#### Door Thickness

- 1-3/8" to 1-3/4" doors standard

#### Cylinder

- SmartKey™ cylinder standard

#### Faceplate

- 1" x 2-1/4" round corner

#### Strikes

- 2-1/4" full lip round corner

#### Door Handing

- Reversible for right- or left-hand doors

### SmartCode™ 911 Touchpad Electronic Lever

SmartCode provides the convenience of keyless access for today's active lifestyle. The latest in electronic technology operates on just 4 AA batteries and permits access with your personalized code or a key. It is easy to install, easy to program and easy to use. SmartCode requires no wiring and easily replaces existing door hardware.

- One Touch Locking
- Four to Eight Digit Personal Entry Code, Four Code Capacity
- Easy to Install, Easy to Program, Easy to Use
- SmartKey Cylinder
- Tustin Lever Design in 11P/15 Finishes. Lido Lever Design in L03 Finish.

Model	Function	Finish							
		L03	3	5	11P	15	15A	26	26D
911-SMT	Entry Lever	\$250.00	-	-	\$263.75	\$263.75	-	-	-

**Features & Specifications**

**Door Prep**

- Crossbore 2-1/8". Edge Bore 1" Latch Face 1" x 2-1/4"

**Backset**

- Adjustable to 2-3/8" or 2-3/4"

**Door Thickness**

- 1-3/8" to 2" doors standard

**Cylinder**

- SmartKey™ cylinder standard

**Faceplate**

- 1" x 2-1/4"

**Strikes**

- 2-3/4" x 2-1/8"

**Bolt**

- 1" throw

**Door Handing**

- Reversible for right- or left-hand doors

**SmartCode 909CNT Deadbolt Function**

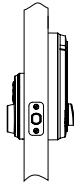
Model/Function	Description
 909CNT	<b>Single Cylinder</b> - Deadbolt operated by Electronic touchpad or key outside and thumbturn inside.

**Dimensions**

Design	A	B	C
909CNT Interior	3-9/32"	6-13/32"	1-3/4"
909CNT Exterior	2-23/32"	4-1/4"	1-3/16"

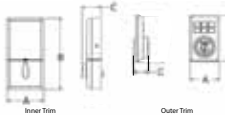

**SmartCode™ 909CNT Touchpad Deadbolt**

SmartCode provides the convenience of keyless access for today's active lifestyle. The latest in electronic technology operates on just 4 AA batteries and permits access with your personalized code or a key. It is easy to install, easy to program and easy to use. SmartCode requires no wiring and easily replaces existing door hardware.

- One Touch Locking, Full 1" Projection Deadbolt
- Four to Eight Digit Personal Entry Code, Two Code Capacity
- Easy to Install, Easy to Program, Easy to Use
- SmartKey Cylinder

Model	Function	Finish							
		L03	3	5	11P	15	15A	26	26D
909CNT-SMT	Single Cylinder	-	-	-	\$233.50	\$233.50	-	\$233.50	\$233.50

# Signature Series

## PowerBolt 907 Deadbolt

### PowerBolt 907 Deadbolt Function

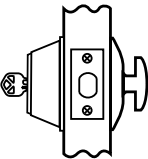
Model/Function	Description
 907	<b>Single Cylinder</b> - Deadbolt operated by electronic touchpad or key outside and thumbturn inside.

### Dimensions

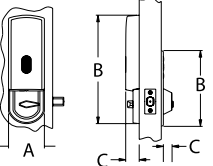
Design	A	B	C
 907 Interior	3-1/4"	9-13/16"	1-3/16"
907 Exterior		6-7/8"	1-5/32"

Interior View



Exterior View



### Features & Specifications

#### Door Prep

- Crossbore 2-1/8". Edge Bore 1" Latch Face 1" x 2-1/4"

#### Backset

- Adjustable to 2-3/8" or 2-3/4"

#### Door Thickness

- 1-3/8" – 2" doors standard

#### Cylinder

- SmartKey™ cylinder standard

#### Faceplate

- 1" x 2-1/4"

#### Strikes

- Round corner strike

#### Bolt

- 1" Throw

#### Door Handing

- Reversible for right- or left-hand doors

### PowerBolt Touchpad Deadbolt

SmartCode provides the convenience of keyless access for today's active lifestyle. The latest in electronic technology operates on just 4 AA batteries and permits access with your personalized code or a key. It is easy to install, easy to program and easy to use. SmartCode requires no wiring and easily replaces existing door hardware.

- One Touch Locking, Full 1" Projection Deadbolt
- Four to Eight Digit Personal Entry Code, Two Code Capacity
- Easy to Install, Easy to Program, Easy to Use

Model	Function	Finish							
		L03	3	5	11P	15	15A	26	26D
907-SMT	Single Cylinder	\$139.75	-	-	\$143.00	\$143.00	-	-	-



SmartCode 907

**Features & Specifications**

**Door Prep**

- Face Bore 2-1/8". Edge Bore 1"

**Backset**

- 2-3/8"

**Door Thickness**

- Adjustable for 1-3/8" or 1-3/4"

**Faceplate**

- 1" x 2-1/4"

**Strikes (Privacy Function)**

- 1-1/8" x 2-3/4" square corner with strike box and wood frame reinforcement, steel

**Fasteners**

- Standard flat or Phillips screws. #8 x 1/2" for latch, #8 x 1/2" for strike

**Door Handing**

- Non-handed

**Round Pocket Door Lock Functions**

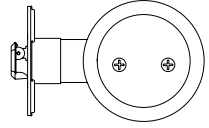
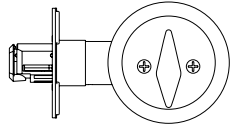
Model/Function	Description
 <p>334</p>	<b>Passage</b> - Deep cups for easy access on passage doors.
 <p>335</p>	<b>Privacy</b> - Locked and unlocked by emergency tool outside and thumbturn inside.

**Round Pocket Door Dimensions**

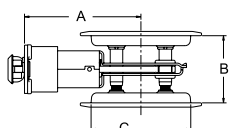
Design	A	B	C
 <p>Passage (334)</p>	2-3/8"	1-3/8" or 1-3/4"	2-1/8"
Privacy (335)	2-3/8"	1-3/8" or 1-3/4"	2-1/8"

**Round Pocket Door Locks**

Kwikset's innovative round design fits a standard 2-1/8" drilled door, allowing for easy installation.



334 Passage



335 Privacy

Model	Function	Finish							
		L03	3	5	10B	15	15A	26D	32
334	Passage	-	\$29.90	\$29.90	\$29.90	\$29.90	\$29.90	\$29.90	\$29.90
335	Privacy	-	\$33.20	\$33.20	\$33.20	\$33.20	\$33.20	\$33.20	\$33.20



## America's Number One Selling Lockset.™

The features you want in a brand you trust. This value product line provides security and peace of mind at an affordable cost.

It includes ANSI grade 3 deadbolts, solid-forged brass Dakota handleset and Kwik-Install installation features on all knobs.

### Features

- ANSI/BHMA Grade 3 Security Features
- Full 1" Solid Core Throwbolt
- Traditional and Timeless Designs
- Lifetime Mechanical Warranty
- 5 Year Finish Warranty\*



**Features & Specifications**

**Door Prep**

- Deadbolt: Cross Bore 2-1/8" or 1-1/2"  
Edge Bore 1". Latch Face 1" x 2-1/4"
- Handle: Cross Bore 2-1/8", Edge Bore 1"  
Latch Face 1" x 2-1/4"

**Backset**

- Deadbolt: Adjustable to 2-3/8" or 2-3/4"
- Handle: Adjustable to 2-3/8" or 2-3/4"

**Door Thickness**

- 1-3/4" doors standard, 2-1/4" doors optional

**Cylinder**

- 5-pin cylinder standard

**Faceplate**

- 1" x 2-1/4"

**Strikes**

- Deadbolt: 1" x 2-1/4".
- Handle: 2-1/4" full lip

**Bolt**

- Deadbolt: 1" throw
- Handle: 1/2" throw







**Door Handing**

- Reversible for right- or left-hand doors. (Specify handing when ordering all levers as interior trim for exterior doors)

**ANSI/BHMA**

- A156.5 Grade 3 (Deadbolt)

**Kwikset Series Handleset Exterior & Interior Lock Functions**

Model/Function	Description
Single Cylinder Handleset	
 <p>687</p>	<b>Exterior Entrance Lock Portion</b> - Latchbolt operated by thumb-piece outside and grip inside. Deadbolt operated by key outside and thumbturn inside.
 <p>604</p>	<b>Interior Entrance Lock Portion</b> - Inside trim, deadbolt, latch, screws and strikes of 800.
Double Cylinder Handleset	
 <p>689</p>	<b>Exterior Entrance Lock Portion</b> - Latchbolt operated by thumbpiece outside and grip inside Deadbolt operated by key both sides.
 <p>605</p>	<b>Interior Entrance Lock Portion</b> - inside trim, deadbolt, latch, screws and strikes of 801.
Dummy Handleset	
 <p>699</p>	<b>Exterior Entrance Dummy Portion</b> - Handle and grip act as a pull only. For inactive leaf or double doors. No operation.
 <p>606</p>	<b>Interior Entrance Dummy Portion</b> - Inside trim of 802.

# Kwikset Series

## Handlesets

Kwikset

### Kwikset Series Exterior Designs



*Belleview (BW)*

*Dakota (DA)*



**Kwikset Series Handleset Interior Design Options**

**Signature Series Knob & Lever Interior Options**



*Abbey® Knob (A)*



*Cameron Knob™ (CN)*



*Circa Knob™ (CA)*



*Copa™ Knob (C)*



*Hancock™ Knob (H)*



*Laurel™ Knob (L)*



*Lido™ Lever (LL)*



*Tustin™ Lever (TNL)*

**Kwikset Series Knob & Lever Interior Options**



*NEW Balboa® Lever (BL)*



*Cove® Knob (CV)*



*Delta™ Lever (DL)*



*Dorian® Lever (DNL)*



*Polo® Knob (P)*



*Tylo® Knob (T)*

### Kwikset Series Single Cylinder Handlesets - Keyed Exterior with Thumbturn Interior

Function	Design	Finish Options							
		L03	3	5	11P	15	15A	26	26D
Single Cylinder Handleset - For Pricing, add Outside Design (687) + Inside Design (604)									
Single Cylinder, Exterior (687)	<b>Signature Series Exterior Design</b>								
	Dakota (687DA-SMT)	-	\$98.20	\$110.10	\$115.30	\$110.10	\$110.10	-	\$104.20
	Belleview (687BW-SMT)	-	\$98.20	\$110.10	\$115.30	\$110.10	-	-	\$104.20
Single Cylinder, Interior Pack (604)	<b>Signature Series Interior Packs</b>								
	Abbey Knob (604A)		\$41.60	\$41.60	-	-	-	\$41.60	\$41.60
	Cameron Knob (604CN)		\$41.60	\$41.60	\$41.60	\$41.60	\$41.60	\$41.60	-
	Circa Knob (604CA)		\$41.60	\$41.60	\$41.60	\$41.60	\$41.60	\$41.60	\$41.60
	Copa Knob (604C)		\$41.60	\$41.60	-	-	\$41.60	\$41.60	\$41.60
	Hancock Knob (604H)		\$41.60	\$41.60	\$41.60	\$41.60	\$41.60	\$41.60	\$41.60
	Laurel Knob (604L)^		\$50.50	\$50.50	\$50.50	\$50.50	\$50.50	\$50.50	-
	Lido Lever (604LL)^		\$50.50	\$50.50	-	\$50.50	\$50.50	\$50.50	\$50.50
	Tustin Lever (604TNL)^		\$50.50	\$50.50	\$50.50	\$50.50	\$50.50	\$50.50	\$50.50
	<b>Kwikset Series Interior Packs</b>								
	Balboa Lever (604BL)^		\$47.40	\$47.40	\$47.40	\$47.40	-	-	\$47.40
	Cove Knob (604CV)		\$36.60	\$36.60	\$36.60	\$36.60	-	-	\$36.60
	Delta Lever (604DL)^		\$47.40	\$47.40	-	-	\$47.40	\$47.40	\$47.40
	Dorian Lever (604DNL)^		\$47.40	\$47.40	\$47.40	\$47.40	\$47.40	\$47.40	\$47.40
Polo Knob (604P)		\$36.60	\$36.60	\$36.60	\$36.60	\$36.60	\$36.60	\$36.60	
Tylo Knob (604T)		\$36.60	\$36.60	-	-	-	\$36.60	\$36.60	

**TIP: See Page 3 for "How to Order Handlesets"**

**Notes:**

^ Specify door handing for all Lever Design Interior Packs

**Kwikset Series Double Cylinder Handlesets - Keyed Exterior & Keyed Interior**

Function	Design	Finish Options							
		L03	3	5	11P	15	15A	26	26D
Double Cylinder Handleset - For Pricing, add Outside Design (689) + Inside Design (605)									
Double Cylinder, Exterior (689)	<b>Signature Series Exterior Design</b>								
	Dakota (689DA-SMT)	-	\$99.40	\$113.50	\$118.90	\$113.50	\$113.50	-	\$106.50
	Belleview (689BW-SMT)	-	\$99.40	\$113.50	\$118.90	\$113.50	-	-	\$106.50
Double Cylinder, Interior Pack (605)	<b>Signature Series Interior Packs</b>								
	Abbey Knob (605A)		\$64.30	\$64.30	-	-	-	-	\$64.30
	Cameron Knob (605CN)		\$64.30	\$64.30	\$64.30	\$64.30	\$64.30	\$64.30	-
	Circa Knob (605CA)		\$64.30	\$64.30	\$64.30	\$64.30	\$64.30	\$64.30	\$64.30
	Copa Knob (605C)		\$64.30	\$64.30	-	-	\$64.30	\$64.30	\$64.30
	Hancock Knob (605H)		\$64.30	\$64.30	\$64.30	\$64.30	\$64.30	\$64.30	\$64.30
	Laurel Knob (605L)^		\$73.90	\$73.90	\$73.90	\$73.90	\$73.90	\$73.90	-
	Lido Lever (605LL)^		\$73.90	\$73.90	-	\$73.90	\$73.90	-	\$73.90
	Tustin Lever (605TNL)^		\$73.90	\$73.90	\$73.90	\$73.90	\$73.90	\$73.90	\$73.90
	<b>Kwikset Series Interior Packs</b>								
	Balboa Lever (605BL)^		\$64.70	\$64.70	\$64.70	\$64.70	-	-	\$64.70
	Cove Knob (605CV)		\$54.50	\$54.50	\$54.50	\$54.50	-	-	\$54.50
	Delta Lever (605DL)^		\$64.70	\$64.70	-	-	\$64.70	\$64.70	\$64.70
	Dorian Lever (605DNL)^		\$64.70	\$64.70	\$64.70	\$64.70	\$64.70	\$64.70	\$64.70
Polo Knob (605P)		\$54.50	\$54.50	\$54.50	\$54.50	\$54.50	\$54.50	\$54.50	
Tylo Knob (605T)		\$54.50	\$54.50	-	-	-	\$54.50	\$54.50	

*TIP: See Page 3 for "How to Order Handlesets"*

**Notes:**

^ Specify door handing for all Lever Design Interior Packs  
Includes SMT Option on Exterior & Interior Deadbolt

### Kwikset Series Dummy Handlesets - Non Keyed for Inactive Doors

Function	Design	Finish Options							
		L03	3	5	11P	15	15A	26	26D
Dummy Handleset - For Pricing, add Outside Design (699) + Inside Design (606)									
Single Cylinder, Exterior (699)	<b>Signature Series Exterior Design</b>								
	Dakota (699DA)	-	\$82.60	\$89.60	\$94.10	\$89.60	\$89.60	-	\$86.10
	Belleview (699BW)	-	\$82.60	\$89.60	\$94.10	\$89.60	-	-	\$86.10
Single Cylinder, Interior Pack (606)	<b>Signature Series Interior Packs</b>								
	Abbey Knob (606A)		\$33.80	\$33.80	-	-	-	\$33.80	\$33.80
	Cameron Knob (606CN)		\$33.80	\$33.80	\$33.80	\$33.80	\$33.80	\$33.80	-
	Circa Knob (606CA)		\$33.80	\$33.80	\$33.80	\$33.80	\$33.80	\$33.80	\$33.80
	Copa Knob (606C)		\$33.80	\$33.80	-	-	\$33.80	\$33.80	\$33.80
	Hancock Knob (606H)		\$33.80	\$33.80	\$33.80	\$33.80	\$33.80	\$33.80	\$33.80
	Laurel Knob (606L)^		\$42.10	\$42.10	\$42.10	\$42.10	\$42.10	\$42.10	-
	Lido Lever (606LL)^		\$42.10	\$42.10	-	\$42.10	\$42.10	-	\$42.10
	Tustin Lever (606TNL)^		\$42.10	\$42.10	\$42.10	\$42.10	\$42.10	\$42.10	\$42.10
	<b>Kwikset Series Interior Packs</b>								
	Balboa Lever (606BL)^		\$39.10	\$39.10	\$39.10	\$39.10	-	-	\$39.10
	Cove Knob (606CV)		\$28.30	\$28.30	\$28.30	\$28.30	-	-	\$28.30
	Delta Lever (606DL)^		\$39.10	\$39.10	-	-	\$39.10	\$39.10	\$39.10
	Dorian Lever (606DNL)^		\$39.10	\$39.10	\$39.10	\$39.10	\$39.10	\$39.10	\$39.10
Polo Knob (606P)		\$28.30	\$28.30	\$28.30	\$28.30	\$28.30	\$28.30	\$28.30	
Tylo Knob (606T)		\$28.30	\$28.30	-	-	-	\$28.30	\$28.30	

**TIP: See Page 3 for "How to Order Handlesets"**

**Notes:**

^ Specify door handing for all Lever Design Interior Packs

**Features & Specifications**

**Door Prep**

- Cross Bore: 2-1/8" . Edge Bore: 1" Latch Face: 1" x 2-1/4"

**Backset**

- Adjustable to 2-3/8" or 2-3/4"

**Door Thickness**

- 1-3/8" to 1-3/4" doors standard

**Cylinder**

- SmartKey™ cylinder standard (Cove)
- 5-pin available standard (all others)

**Faceplate**

- 1" x 2-1/4"

**Strikes**

- 2-1/4" full lip

**Bolt**

- 1/2" throw

**Door Handing**

- Reversible for right- or left-hand doors

**ANSI/BHMA**

- A156.2 Grade 3

**Kwikset Series Knob Functions**

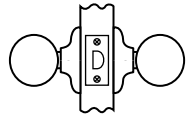
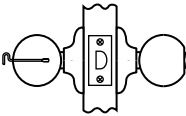
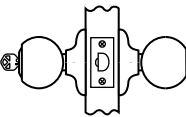
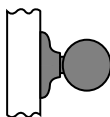
Model/Function	Description
 <p>200</p>	<b>Passage/Hall/Closet</b> - Both knobs always free.
 <p>300</p>	<b>Privacy/Bed/Bath</b> - Both knobs locked or unlocked by turnbutton inside. Outside knob unlocked by emergency key.
 <p>400</p>	<b>Entry</b> - Both knobs locked or unlocked by key outside or turnbutton inside.
 <p>488</p>	<b>Half Dummy Trim</b> - Surface mounted; for doors where only a pull is required. No operations.

**Kwikset Series Knob Dimensions**

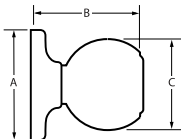
Design	A	B	C
 <p>Cove (CV)</p>	2-5/8"	2-1/2"	2-1/4"
Polo (P)	2-5/8"	2-3/4"	1-7/8"
Tylo (T)	2-5/8"	2-3/8"	1-7/8"

# Kwikset Series

## Knobs

Kwikset

### Cove™ Knob (CV)

Model	Function	Finish							
		L03	3	5	11P	15	15A	26	26D
200CV	Passage/Hall/Closet	-	\$20.70	\$20.70	\$23.10	\$23.10	-	-	\$20.70
300CV	Privacy/Bed/Bath	-	\$23.50	\$23.50	\$25.20	\$25.20	-	-	\$23.50
400CV	Entry	-	\$33.30	\$33.30	\$34.50	\$34.50	-	-	\$33.30
400CV-SMT	Entry w/SmartKey	-	\$38.30	\$38.30	\$39.50	\$39.50	-	-	\$38.30
488CV	Half Dummy Trim	-	\$8.20	\$8.20	\$8.20	\$8.20	-	-	\$8.20



Cove (CV)

### Polo® Knob (P)

Model	Function	Finish							
		L03	3	5	11P	15	15A	26	26D
200P	Passage/Hall/Closet	-	\$18.80	\$21.00	\$22.00	\$21.00	\$21.00	\$21.00	\$19.20
300P	Privacy/Bed/Bath	-	\$20.80	\$23.00	\$24.10	\$23.00	\$23.00	\$23.00	\$21.10
400P	Entry	-	\$27.10	\$29.00	\$30.50	\$29.00	\$29.00	\$29.00	\$27.60
400P-SMT	Entry w/SmartKey	-	\$32.10	\$34.00	\$35.50	\$34.00	\$34.00	\$34.00	\$32.60
488P	Half Dummy Trim	-	\$7.30	\$8.10	\$8.60	\$8.10	\$8.10	\$8.10	\$7.50



Polo (P)

### Tylo® Knob (T)

Model	Function	Finish							
		L03	3	5	11P	15	15A	26	26D
200T	Passage/Hall/Closet	-	\$16.60	\$18.40	-	-	-	\$18.40	\$17.00
300T	Privacy/Bed/Bath	-	\$18.30	\$20.00	-	-	-	\$20.00	\$18.40
400T	Entry	-	\$24.50	\$26.40	-	-	-	\$26.40	\$25.30
400T-SMT	Entry w/SmartKey	-	\$29.50	\$31.40	-	-	-	\$31.40	\$30.30
488T	Half Dummy Trim	-	\$6.50	\$7.50	-	-	-	\$7.50	\$6.60



Tylo (T)

**Features & Specifications**

**Door Prep**

- Cross Bore: 2-1/8" . Edge Bore: 1"  
Latch Face: 1" x 2-1/4"

**Backset**

- Adjustable to 2-3/8" or 2-3/4"

**Door Thickness**

- 1-3/8" to 1-3/4" doors standard

**Cylinder**

- 5-pin cylinder standard

**Faceplate**

- 1" x 2-1/4"

**Strikes**

- 2-1/4" full lip

**Bolt**

- 1/2" throw

**Door Handing**

- Non-handed

**ANSI/BHMA**

- A156.2 Grade 3

**Security Lever Functions**

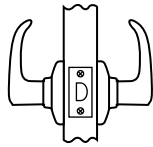
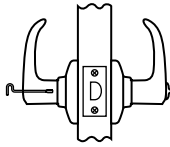
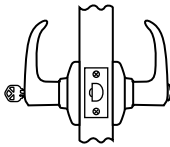
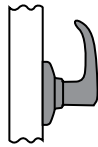
Model/Functions	Description
 <p>200</p>	<b>Passage/Hall/Closet</b> - Both levers always free.
 <p>300</p>	<b>Privacy/Bed/Bath</b> - Both levers locked or unlocked by turnbutton inside. Outside lever unlocked by emergency key.
 <p>405</p>	<b>Entry</b> - Both levers locked or unlocked by key outside or turnbutton inside.
 <p>488</p>	<b>Half Dummy Trim</b> - Surface mounted; for doors where only a pull is required. No operations.

**Security Lever Dimensions**

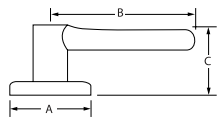
Design	A	B	C
 <p>Balboa (BL)</p>	2-5/8"	4-7/32"	1-15/16"
Delta (DL)	2-5/8"	3-5/8"	1-7/8"
Dorian (DNL)	2-5/8"	3-3/4"	2-1/8"

## Levers

### NEW - Balboa™ Lever (BL)

Model	Function	Finish							
		L03	3	5	11P	15	15A	26	26D
200BL	Passage/Hall/Closet	-	\$31.90	\$34.00	\$35.50	\$34.00	-	-	\$34.00
300BL	Privacy/Bed/Bath	-	\$34.50	\$36.50	\$38.10	\$36.50	-	-	\$36.50
405BL	Entry	-	\$53.00	\$55.10	\$56.70	\$55.10	-	-	\$55.10
405BL-SMT	Entry w/SmartKey	-	\$58.00	\$60.10	\$61.70	\$60.10	-	-	\$60.10
488BL	Half Dummy Trim	-	\$12.90	\$14.90	\$16.50	\$14.90	-	-	\$14.90



Balboa (BL)

### Delta™ Lever (DL)

Model	Function	Finish							
		L03	3	5	11P	15	15A	26	26D
200DL	Passage/Hall/Closet	-	\$31.90	\$33.00	-	-	\$34.00	\$34.00	\$34.00
300DL	Privacy/Bed/Bath	-	\$33.90	\$35.10	-	-	\$36.00	\$36.00	\$36.00
405DL	Entry	-	\$52.80	\$54.10	-	-	\$55.20	\$55.20	\$55.20
405DL-SMT	Entry w/SmartKey	-	\$57.80	\$59.10	-	-	\$60.20	\$60.20	\$60.20
488DL	Half Dummy Trim	-	\$13.00	\$14.10	-	-	\$14.80	\$14.80	\$14.80



Delta (DL)

### Dorian® Lever (DNL)

Model	Function	Finish							
		L03	3	5	11P	15	15A	26	26D
200DNL	Passage/Hall/Closet	-	\$31.90	\$33.00	\$35.60	\$34.00	\$34.00	\$34.00	\$34.00
300DNL	Privacy/Bed/Bath	-	\$33.90	\$35.10	\$37.80	\$36.00	\$36.00	\$36.00	\$36.00
405DNL	Entry	-	\$52.80	\$54.10	\$58.00	\$55.20	\$55.20	\$55.20	\$55.20
405DNL-SMT	Entry w/SmartKey	-	\$57.80	\$59.10	\$63.00	\$60.20	\$60.20	\$60.20	\$60.20
488DNL	Half Dummy Trim	-	\$13.00	\$14.10	\$15.60	\$14.80	\$14.80	\$14.80	\$14.80



Dorian (DNL)



**Features & Specifications**

**Door Prep**

- Crossbore: 2-1/8" Edge Bore: 1"  
Latch Face: 1" x 2-1/4"

**Backset**

- Adjustable 2-3/8" or 2-3/4" latch standard

**Door Thickness**

- 1-3/8" to 1-3/4" thick doors standard

**Cylinder**

- 5-pin cylinder standard

**Faceplate**

- 1" x 2-1/4"

**Strikes**

- 1" x 2-1/4" full lip

**Bolt**

- 1" throw

**Door Handing**

- Non-handed

**ANSI/BHMA**

- A156.5 Grade 3

**Kwikset Series Deadbolt Functions**

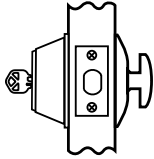
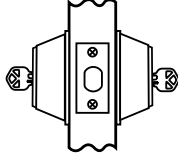
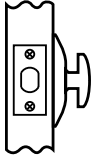
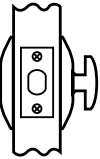
Model/Function	Description
 <p>660</p>	<b>Single Cylinder</b> - Deadbolt operated by key outside and thumbturn inside.
 <p>665</p>	<b>Double Cylinder</b> - Deadbolt operated by key both sides.
 <p>663</p>	<b>Thumbturn Only</b> - Deadbolt operated by thumbturn one side. No trim on other side.
 <p>667</p>	<b>Thumbturn x Plate</b> - Deadbolt operated by thumbturn on interior. Blank plate on exterior.

**Kwikset Series Deadbolt Dimensions**

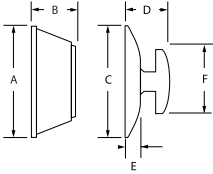
Design	A	B	C	D	E	F
 <p>660 Exterior/Interior</p>	2-1/2"	1-1/8"	2-1/2"	1"	3/8"	1-3/4"
665 Exterior/Interior	2-1/2"	1-1/8"	2-1/2"	1-1/8"		
663 Exterior/Interior			2-1/2"	1"	3/8"	1-3/4"
667 Exterior/Interior	2-1/2"	3/8"	2-1/2"	1"	3/8"	1-3/4"

## Deadbolts

### 660/665 Deadbolts

Model	Function	Finish							
		L03	3	5	11P	15	15A	26	26D
660	Single Cylinder	-	\$26.00	\$28.30	\$29.80	\$28.30	\$28.30	\$28.30	\$26.70
660-SMT	Single Cylinder w/SMT	-	\$31.00	\$33.30	\$34.80	\$33.30	\$33.30	\$33.30	\$31.70
665	Double Cylinder	-	\$33.70	\$36.00	\$37.80	\$36.00	\$36.00	\$36.00	\$34.40
665-SMT	Double Cylinder w/SMT	-	\$43.70	\$46.00	\$47.80	\$46.00	\$46.00	\$46.00	\$44.40



660/665

### 663/667 Single Sided Thumbturn

Single sided thumbturn deadbolt available with or without exterior plate.

Model	Function	Finish							
		L03	3	5	11P	15	15A	26	26D
663	Thumbturn One Side	-	\$12.80	\$13.60	\$14.30	\$13.60	\$13.60	\$13.60	\$13.00
667	Thumbturn x Ext Plate	-	\$22.50	\$23.70	\$25.00	\$23.70	\$23.70	\$23.70	\$22.90



663/667



332 Passage

**Notch Pocket Door Locks**

Easy installation for pocket interior doors. Equipped with edge pull. Requires 2-1/4" x 1-3/4" cutout in edge of door.

Model	Function	Finish							
		L03	3	5	11P	15	15A	26D	32
332	Passage	-	\$27.40	\$29.30	-	-	-	-	\$28.70
333	Privacy	-	\$30.80	\$32.90	-	-	-	-	\$32.25

**Round Pocket Door Locks** *(detail specifications found on page 26)*

Kwikset's innovative round design fits a standard 2-1/8" drilled door, allowing for easy installation.



334 Passage

Model	Function	Finish							
		L03	3	5	11P	15	15A	26D	32
334	Passage	-	\$29.90	\$29.90	\$29.90	\$29.90	\$29.90	\$29.90	\$29.90
335	Privacy	-	\$33.20	\$33.20	\$33.20	\$33.20	\$33.20	\$33.20	\$33.20

**Colonial Handle**

12" long curved handle.



239 Colonial

Model	Function	Finish							
		L03	3	5	11P	15	15A	26D	32
239	Colonial Handle	-	\$55.35	\$58.65	-	\$56.10	-	\$56.10	-

## Latches

### 6-Way Deadlatch Service Kit

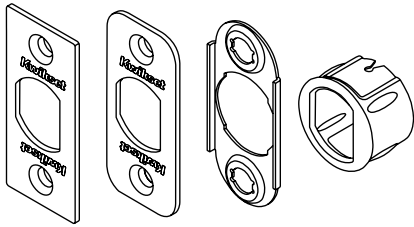

81844

### 6-Way Plain Latch Service Kit

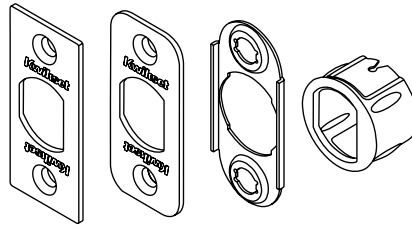

81845

### 6-Way Core Deadlatch

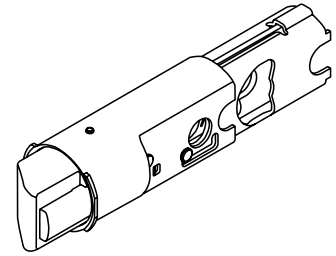

81846

### 6-Way Core Plain Latch

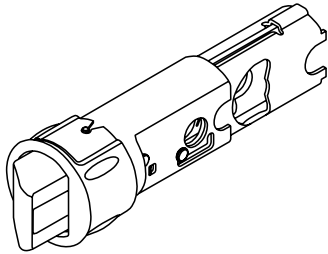

81847

### 5" Deadbolt Latch

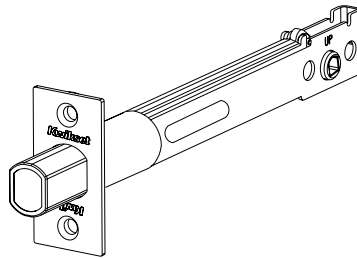

82730

### 5" Deadlatch

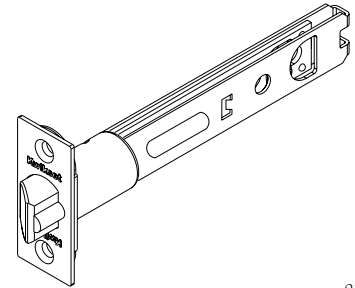

83014

### Drive In Adjustable Deadbolt Latch

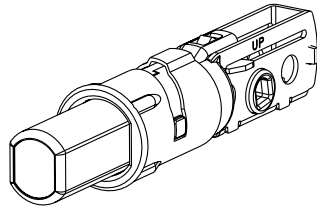

81306 / 83371

### SC Adjustable Deadbolt Latch

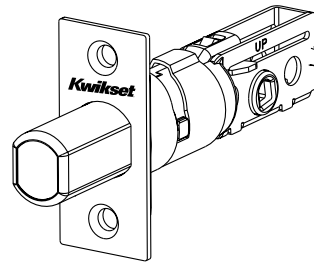

81308 / 88370

### RC Adjustable Deadbolt Latch

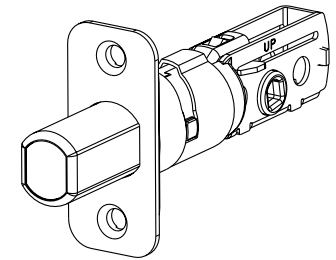

81305 / 83347

Model	Description	Available Finishes								
		List Price	3/L03	5	15/502	15A	26/26D	690/11P/501	514	
81844	Deadlatch Service Kit	\$3.95	•	•	•	•	•	•	•	
81845	Plain Latch Service Kit	\$3.10	•	•	•	•	•	•	•	
81846	6-Way Core Deadlatch	\$7.90	(Finish Not Applicable)							
81847	6-Way Core Plain Latch	\$5.60	(Finish Not Applicable)							
82730	5" Deadbolt Latch	\$12.55	•	•			•			
83014	5" Deadlatch	\$14.95	•	•			•			
81306	Drive In Adjustable Deadbolt Latch - 660 Series	\$9.15	(Finish Not Applicable)							
83371	Drive In Adjustable Deadbolt Latch	\$14.30	(Finish Not Applicable)							
81308	Square Adjustable Deadbolt Latch - 660 Series	\$9.15	•	•	•	•	•	•	•	
83370	Square Adjustable Deadbolt Latch	\$14.30	•	•	•	•	•	•	•	
81305	Round Adjustable Deadbolt Latch - 660 Series	\$9.15	•	•	•	•	•	•	•	
83347	Round Adjustable Deadbolt Latch	\$14.30	•	•	•	•	•	•	•	

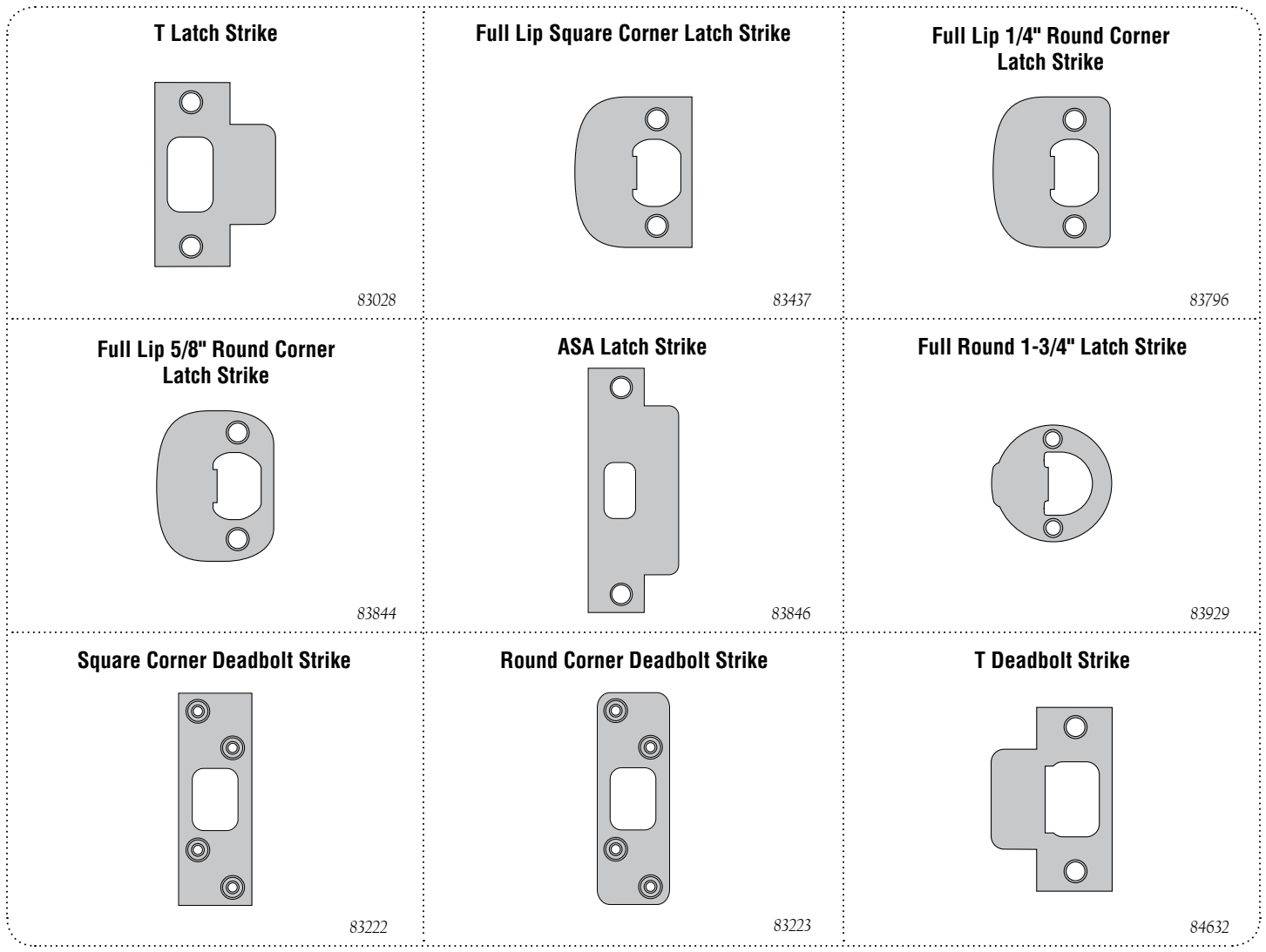

Model	Description	Available Finishes							
		List Price	3/L03	5	15/502	15A	26/26D	690/11P/501	514
83028	T Latch Strike	\$2.75	•	•	•	•	•	•	•
83437	Full Lip Square Corner Latch Strike	\$2.75	•	•	•	•	•	•	•
83796	Full Lip 1/4" Round Corner Latch Strike	\$2.75	•	•	•	•	•	•	•
83844	Full Lip 5/8" Round Corner Latch Strike	\$2.75	•	•	•	•	•	•	•
83846	ASA Latch Strike	\$8.80	•	•	•	•	•	•	•
83929	Full Round 1-3/4" Latch Strike	\$2.75	•	•	•	•	•	•	•
83222	Square Corner Deadbolt Strike	\$3.70	•	•	•	•	•	•	•
83223	Round Corner Deadbolt Strike	\$3.70	•	•	•	•	•	•	•
84632	T Deadbolt Strike	\$2.75	•	•	•	•	•	•	•

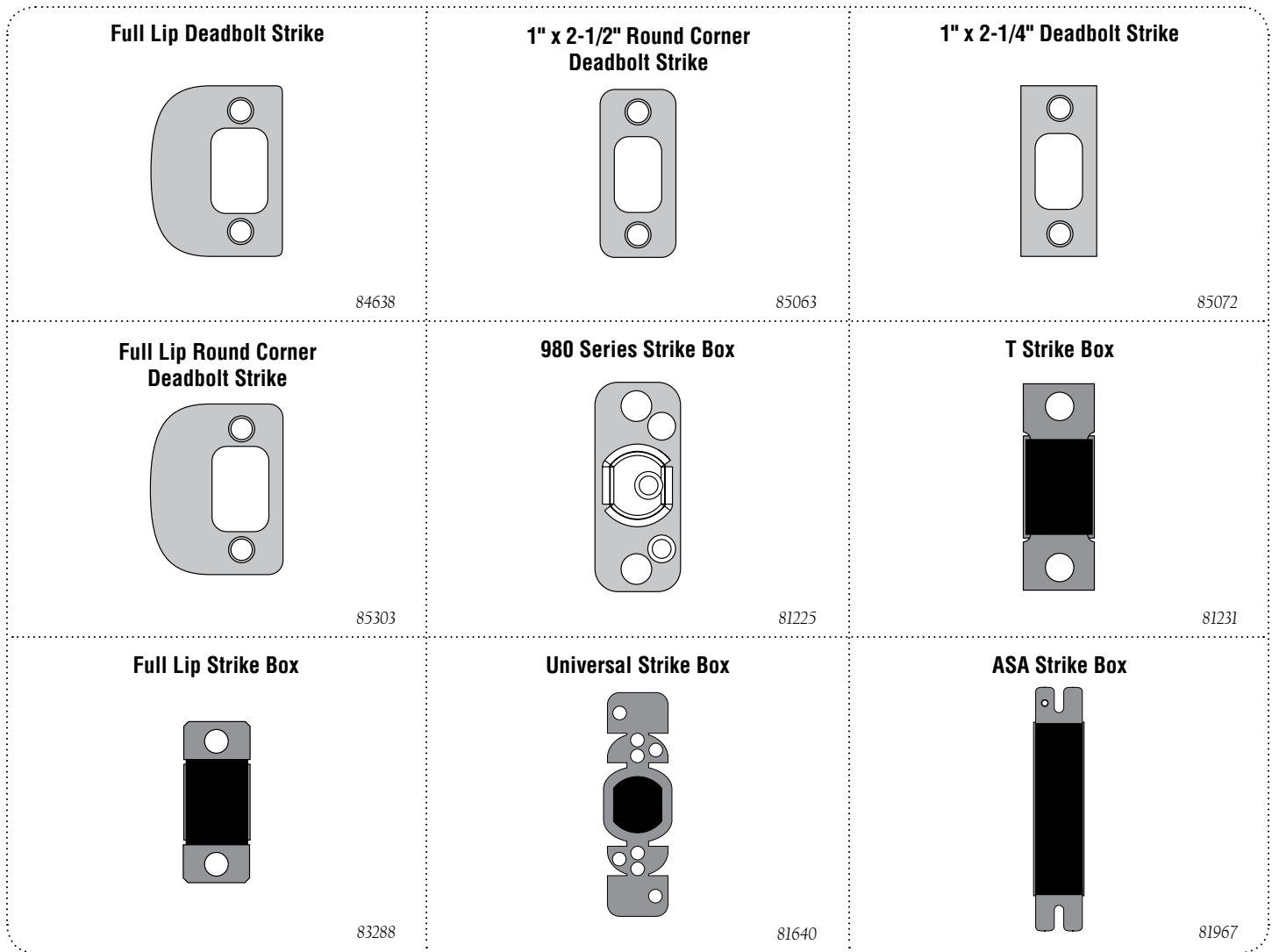

Model	Description	Available Finishes								
		List Price	3	5	15/502	15A	26/26D	690/11P/501	514	
84638	Full Lip Deadbolt Strike	\$2.75	•	•	•	•	•	•	•	
85063	1" x 2-1/2" Round Corner Deadbolt Strike	\$2.75	•	•	•	•	•	•	•	
85072	1" x 2-1/4" Square Corner Deadbolt Strike	\$2.75	•	•	•	•	•	•	•	
85303	Full Lip Round Corner Deadbolt Strike	\$2.75	•	•	•	•	•	•	•	
81225	Strike Box for 980 Series	\$3.00	(Finish Not Applicable)							
81231	Strike Box for T Strike	\$0.80	(Finish Not Applicable)							
83288	Strike Box for Full Lip	\$1.20	(Finish Not Applicable)							
81640	Strike Box with Break-Off Tabs	\$0.80	(Finish Not Applicable)							
81967	Strike Box ASA Strike	\$3.95	(Finish Not Applicable)							

Kwikset Residential Architectural Hardware Catalog | ©2011 Albany Hardware, Inc.

BOX PACK	Unit					Master Case			
	Quantity	Length (in.)	Width (in.)	Height (in.)	Weight (lbs.)	Quantity	Length (in.)	Width (in.)	Height (in.)
<b>Signature Series</b>									
<b>Deadbolts</b>									
780 Single Cylinder	1	4.673	3.923	3.072	2.25	12	12.875	12.5	5.3125
785 Double Cylinder	1	4.673	3.923	3.072	2.75	12	12.875	12.5	5.3125
980 Single Cylinder	1	4.673	3.923	3.072	2.25	12	12.875	12.5	5.3125
985 Double Cylinder	1	4.673	3.923	3.072	2.75	12	12.875	12.5	5.3125
<b>Electronic Deadbolts</b>									
907 Powerbolt	1	5.5	3.8	11.5	3.35	2	5.5	8	11.5
909 SmartCode	1	5.5	3.5	10	2.88	2	7.6	6	10.5
911 SmartCode Lever	1	3.5	6	10	61	2	7	12.5	10.4
<b>Handlesets</b>									
553 Single Cylinder	1	15.938	7.125	4	6.25	6	15	12.125	16.6255
554 Double Cylinder	1	15.938	7.125	4	6.75	6	15	12.125	16.6255
555 Dummy	1	15.938	7.125	4	6.25	6	15	12.125	16.6255
800ADH Ashfield, 800AVH Avalon	1	15.938	7.125	4	7	6	15	12.125	16.6255
801ADH Ashfield, 801AVH Avalon	1	15.938	7.125	4	7.5	6	15	12.125	16.6255
802ADH Ashfield, 802AVH Avalon	1	15.938	7.125	4	6.5	6	15	12.125	16.6255
800AN Arlington	1	15.938	7.125	4	7	6	15	12.125	16.6255
801AN Arlington	1	15.938	7.125	4	7.5	6	15	12.125	16.6255
802AN Arlington	1	15.938	7.125	4	6.5	6	15	12.125	16.6255
800AT Amherst	1	19.938	7.625	4	8.9	4	20.5	16	8.3875
801AT Amherst	1	19.938	7.625	4	9.9	4	20.5	16	8.3875
802AT Amherst	1	19.938	7.625	4	6.9	4	20.5	16	8.3875
800CE Chelsea	1	15.938	7.125	4	6	6	15	12.125	16.6255
801CE Chelsea	1	15.938	7.125	4	6.5	6	15	12.125	16.6255
802CE Chelsea	1	15.938	7.125	4	5.5	6	15	12.125	16.6255
800HE Hawthorne	1	15.938	7.125	4	7	4	16.438	15.938	7.8125
801HE Hawthorne	1	15.938	7.125	4	8	4	16.438	15.938	7.8125
802HE Hawthorne	1	15.938	7.125	4	5	4	16.438	15.938	7.8125
800SE Shelburne	1	15.938	7.125	4	7.9	4	16.438	15.938	7.8125
801SE Shelburne	1	15.938	7.125	4	8.9	4	16.438	15.938	7.8125
802SE Shelburne	1	15.938	7.125	4	5.9	4	16.438	15.938	7.8125
800SN Sheridan	1	15.938	7.125	4	7	6	15	12.125	16.6255
801SN Sheridan	1	15.938	7.125	4	7.5	6	15	12.125	16.6255
802SN Sheridan	1	15.938	7.125	4	6.5	6	15	12.125	16.6255
800 Tavaris	1	15.938	7.125	4	8	4	16.438	16.62	8.38
801 Tavaris	1	15.938	7.125	4	8.25	4	16.438	16.62	8.38
802 Tavaris	1	15.938	7.125	4	8	4	16.438	16.62	8.38
800WN Wellington	1	19.938	7.625	4	7.2	4	20.5	16	8.3875
801WN Wellington	1	19.938	7.625	4	8.2	4	20.5	16	8.3875
802WN Wellington	1	19.938	7.625	4	5.2	4	20.5	16	8.3875
966 Single Cylinder	1	2.7	3.7	4.3	2.25	12	15.2	12.5	7
967 Double Cylinder	1	2.7	3.7	4.3	2.25	12	15.2	12.5	7
968 Dummy	1	2.7	3.7	4.3	2.25	12	15.2	12.5	7
986 Single Cylinder	1	2.7	3.7	4.3	2.25	12	15.2	12.5	7
987 Double Cylinder	1	2.7	3.7	4.3	2.25	12	15.2	12.5	7
983 Without Deadbolt	1	2.7	3.7	4.3	2.25	12	15.2	12.5	7
989 Dummy	1	2.7	3.7	4.3	2.25	12	15.2	12.5	7

BOX PACK	Unit					Master Case			
	Quantity	Length (in.)	Width (in.)	Height (in.)	Weight (lbs.)	Quantity	Length (in.)	Width (in.)	Height (in.)

## Signature Series (continued)

<b>Knobs</b>									
720 Passage	1	8.173	3.923	2.784	2	12/30	12.375	11.5	8.8125
730 Privacy	1	8.173	3.923	2.784	2	12/30	12.375	11.5	8.8125
740 Entry	1	8.173	3.923	2.784	2.33	12/30	12.375	11.5	8.8125
788 Dummy	1	3.236	2.798	3.01	0.35	20	14.875	12.5	3.9375
<b>Levers</b>									
720 Passage	1	7.875	6.125	3.1875	2.42	12/20	19.75	12.875	8.5625
730 Privacy	1	7.875	6.125	3.1875	2.42	12/20	19.75	12.875	8.5625
740 Entry	1	7.875	6.125	3.1875	2.42	12/20	19.75	12.875	8.5625
788 Dummy	1	5.861	3.11	2.822	0.45	20	15.875	12.125	6.6245
<b>Pocket Door Hardware</b>									
334 Passage	1	4.375	3	2	0.65	12	12.5	14.375	2.25
335 Privacy	1	4.375	3	2	0.8	12	12.5	14.375	2.25

## Kwikset Series

<b>Deadbolts</b>									
660 Single Cylinder	1	3.948	3.423	2.572	0.5	12	11.125	11	4.5625
665 Double Cylinder	1	3.948	3.423	2.572	0.9	12	11.125	11	4.5625
663 One-Sided	1	3.948	3.423	2.572	0.55	12	11.125	11	4.5625
667 One-Sided x Plate	1	3.948	3.423	2.572	0.9	12	11.125	11	4.5625
<b>Handlesets</b>									
604 Single Cylinder Interior	1	5.8	3.9	3.7	2.25	12	15.2	12.5	7
605 Double Cylinder Interior	1	5.8	3.9	3.7	2.25	12	15.2	12.5	7
606 Dummy Interior	1	5.8	3.9	3.7	2.25	12	15.2	12.5	7
687 Single Cylinder Exterior	1	15.938	7.125	4	3.6	6	15	12.125	16.6255
688 Double Cylinder Exterior	1	15.938	7.125	4	4	6	15	12.125	16.6255
689 Dummy Exterior	1	15.938	7.125	4	3.6	6	15	12.125	16.6255
<b>Knobs</b>									
200 Cove	1	7.361	3.298	2.784	1.15	30	17.125	17	8.187
300 Cove	1	7.361	3.298	2.784	1.15	30	17.125	17	8.187
400 Cove	1	7.361	3.298	2.784	1.15	30	17.125	17	8.187
200 Polo	1	8.173	3.298	2.784	1.3	30	17.125	17	8.8125
300 Polo	1	8.173	3.298	2.784	1.3	30	17.125	17	8.8125
400 Polo	1	8.173	3.298	2.784	1.3	30	17.125	17	8.8125
200 Tylo	1	7.361	3.298	2.784	1.15	30	17.125	17	8.187
300 Tylo	1	7.361	3.298	2.784	1.15	30	17.125	17	8.187
400 Tylo	1	7.361	3.298	2.784	1.15	30	17.125	17	8.187
488 Dummy	1	3.236	2.798	3.01	0.35	20	14.875	12.5	3.9375
<b>Levers</b>									
200 Passage	1	6.798	5.766	2.972	1.35	20	23.625	15.375	7.4995
300 Privacy	1	6.798	5.766	2.972	1.35	20	23.625	15.375	7.4995
405 Keyed Lever	1	6.798	5.766	2.972	1.58	20	23.625	15.375	7.4995
488 Dummy	1	5.861	3.11	2.822	0.45	20	15.875	12.125	6.6245







Bright Brass 3/L03



Antique Brass 5



Venetian Bronze 11P



Satin Nickel 15



Antique Nickel 15A



Bright Chrome 26



Satin Chrome 26D



Rustic Bronze 501



Rustic Pewter 502



Iron Black 514

# **Kwikset**

Product and MSRP information compiled from the most current *Kwikset Box Pack Price Guide*.  
Prices and product specifications subject to change without notice.

Kwikset is America's #1 selling lockset. Kwikset manufactures and markets a complete line of door locks and door hardware including door knobs, door levers, deadbolts, handlesets, pocket door hardware and electronic keyless entry locks for residential and light commercial applications.