

IRWIN®



IRWIN TOOLS

Customer Service: 1800 331 491



IRWIN Tools manufactures and distributes professional grade hand tools and power tool accessories worldwide for trade professionals who demand superior performance and durability on the job. IRWIN Tools' brand portfolio features user-preferred category leaders such as IRWIN®, VISE-GRIP®, MARATHON®, QUICK-GRIP®, SPEEDBOR®, STRAIT-LINE®, Marples®, and Unibit®.

For over a century, innovation has been the hallmark of IRWIN Tools. Beginning in 1885, with the development of the first IRWIN Auger Bit, and progressing with the introduction of VISE-GRIP Locking Tools, SPEEDBOR Flat Bits, MARATHON Saw Blades, and QUICK-GRIP Bar Clamps, IRWIN has been at the forefront of the industry, creating superior tools for the professional tradesman.

INNOVATION MILESTONES OF RECENT



VISE-GRIP®
GROVELOCK PLIERS

2010



JACK® EVO HANDSAWS

2011



UTILITY KNIFE HANDLES



4-POINT UTILITY BLADES

QUICK-GRIP® BAR CLAMPS



MARATHON® WELDETEC™
CIRCULAR SAW BLADES



WORKSITE RANGE
FEATURING BALLISTIC



2012



MARPLES® CHISELS

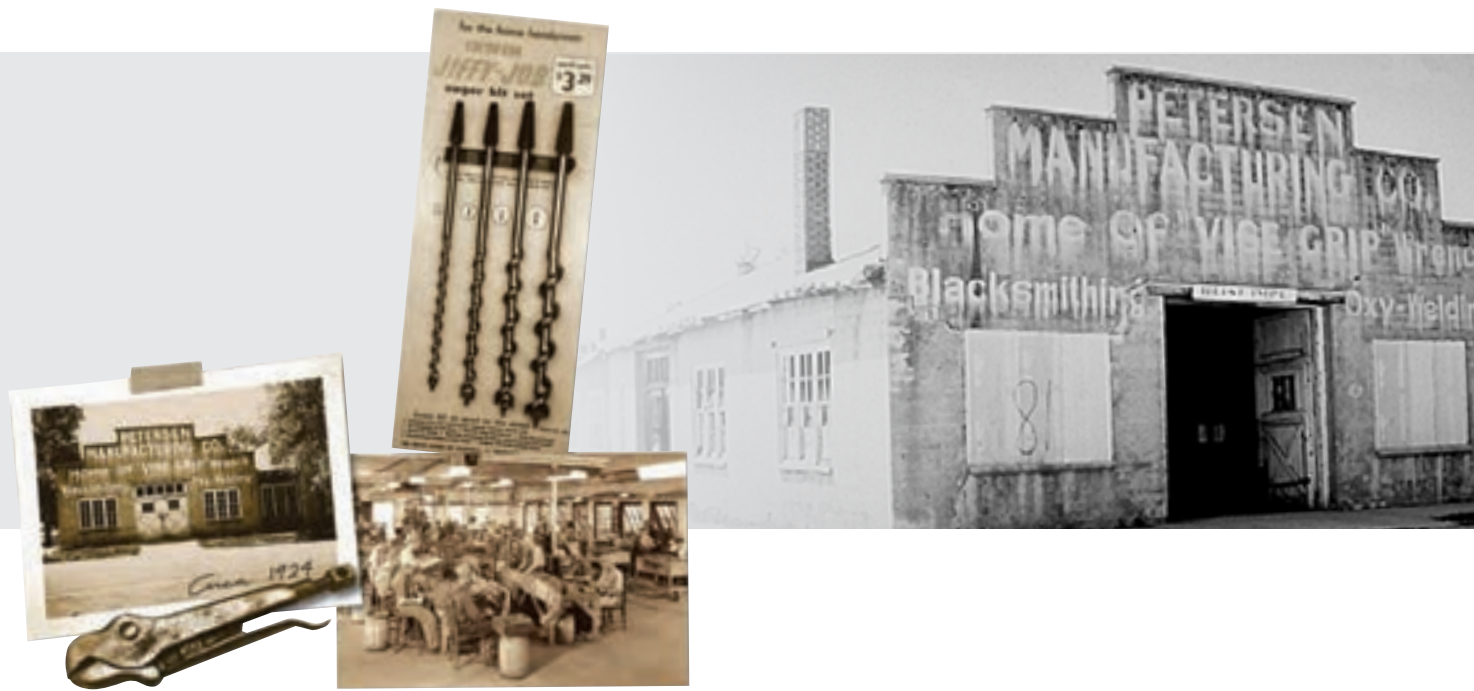

From the beginning of our product development process to the performance of these products in your hands, IRWIN is where you train, work, play and buy. This commitment is apparent in everything we do.

Our impressive track record of new product development is born from our passion for understanding the needs of our primary user - the professional tradesman. This dedication to improving products begins in the field, where IRWIN'S IMPACT End-User Teams visit job sites. There, the team learns first-hand, how to improve our products to help the pros increase their productivity.



IMPACT™ PHASE I

IMPACT™ PHASE II & SPEEDBOR®
MAX RANGE EXTENSION

STRAIT-LINE® CHALK AND REEL,
QUICK-GRIP® DECK TOOL &
VISE-GRIP® MULTI-PLIERS

QUICK ADJUSTING VICE

2013

2014

2015

2016



QUICK-GRIP®



INNOVATION TIMELINE

IRWIN QUICK-GRIP
DECK TOOL KIT

2015



IRWIN XP 600
& SL300 OHBC

2009



IRWIN QUICK-GRIP XP

2006



IRWIN Clamping
& New Pipe Clamps

2003



Handi-Clamp

2000

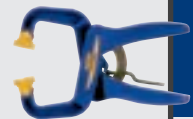

Micro QUICK-GRIP

1997



Mini QUICK-GRIP

1994



QUICK-GRIP
OHBC Clamp

1989



CLAMPING

IRWIN
QUICK-GRIP

Bar Clamps

1. Removable non-marring soft, pliable full face pads to protect workpiece
2. Heat-treated, black-oxide I-Beam bar adds strength, rigidity and resistance to gouging, and prevents rust
3. Patented Power Lock™ system for sustained pressure. Features two-stage non-explosive release
4. Pistol Grip and Quick Release trigger for fast and easy positioning
5. Clamp converts to spreader with no additional tools needed
6. Adjustable foot allows clamp to sit upright for gluing



QUICK-GRIP® Bar Clamps - XP600

- Superior clamping force of up to 272kg
- Quick Change screw allows for easy conversion to spreader and affixed screw won't get lost
- Suitable for heavy duty and commercial applications
- Throat depth 95mm

QUICK-GRIP
XP600

UP TO
272kg
SUSTAINED CLAMPING FORCE

Product Code	Description	Jaw Opening	Shelf Pack	Barcode
2021406N	XP600 QUICK-GRIP Bar Clamps	150mm (6")	1	0038548105758
2021412N	XP600 QUICK-GRIP Bar Clamps	300mm (12")	1	0038548105765
2021418N	XP600 QUICK-GRIP Bar Clamps	460mm (18")	1	0038548105772
2021424N	XP600 QUICK-GRIP Bar Clamps	610mm (24")	1	0038548105789
2021436N	XP600 QUICK-GRIP Bar Clamps	910mm (36")	1	0038548105796
2021450N	XP600 QUICK-GRIP Bar Clamps	1270mm (50")	1	0038548105802
1826576	XP600 Replacement Pads 2pk	-	5	0038548998640

QUICK-GRIP® Bar Clamps - SL300

- Clamping force of up to 140kg
- Patented locking swivel jaw suitable for clamping to uneven work surfaces
- Quick-Change screw allows for easy conversion to spreader and affixed screw won't get lost
- Removable resin pads protect work surface
- I-Beam Bar supports added pressure with less bend and flex
- Suitable for medium duty applications
- Throat depth 80mm

QUICK-GRIP
SL300



UP TO
140kg
SUSTAINED CLAMPING FORCE

Product Code	Description	Jaw Opening	Shelf Pack	Barcode
506QCN	SL300 QUICK-GRIP Bar Clamps	150mm (6")	1	0038548103693
512QCN	SL300 QUICK-GRIP Bar Clamps	300mm (12")	1	0038548103709
518QCN	SL300 QUICK-GRIP Bar Clamps	460mm (18")	1	0038548103723
524QCN	SL300 QUICK-GRIP Bar Clamps	610mm (24")	1	0038548103730
536QCN	SL300 QUICK-GRIP Bar Clamps	910mm (36")	1	0038548103747
1826577	SL300 Replacement Pads 2pk	-	5	0038548998657



Bar Clamps (continued)

QUICK-GRIP® Deck Tool Kit

- Turn a one-handed bar clamp into a deck clamp for easy accurate deck building
- A solution provider for bowed decking boards when building a deck
- Frees your hands to install the fasteners quicker and easier
- A very efficient method of clamping without damaging the decking board and joist
- Designed for quick changing of pads between standard and decking types
- Compatible with all SL300 Medium-Duty Clamps (Clamp not included)
- Fits gaps of 3mm plus
- Steel reinforced

Product Code	Description	Compatibility	Shelf Pack	Barcode
1927870	QUICK-GRIP Deck Tool Kit	SL300 Medium-Duty Clamps	5	042526936241

Mini Bar Clamps

- Strong, light and fast
- One-handed operation – a simple hand squeeze applies pressure, trigger releases pressure
- Soft, pliable pads protect work surfaces
- Throat depth 62mm
- Sustained force 45kg - 70kg (peak force)

Product Code	Description	Jaw Opening	Shelf Pack	Barcode
00546	Mini Bar Clamps	150mm (6")	1	0038548005461
5412	Mini Bar Clamps	300mm (12")	1	0038548054124
5462	Mini Bar Clamps	150mm (6")	1 x 2 pack	0038548054629
54122	Mini Bar Clamps	300mm (12")	1 x 2 pack	0038548541228
1826578	Mini Replacement Pads 4pk	-	5	0038548998664

Micro Bar Clamps

- Soft, durable pads protect delicate work surfaces
- Easily converts to a spreader
- Made from strong, lightweight resin material
- Perfect for hobby and craft use
- Throat depth 30mm
- Clamping force up to 31kg

Product Code	Jaw Opening	Shelf Pack	Barcode
53006	100mm (4 1/4")	1	0038548530062

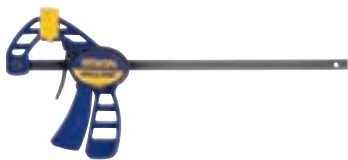

Hand Clamps

Spring Clamps

- Made from strong, lightweight resin material
- Jaw contoured to hold round and odd-shaped objects

Product Code	Jaw Opening	Shelf Pack	Barcode
58100	25mm (1")	10	0038548581002
58200	50mm (2")	10	0038548582009
58300	75mm (3")	5	0038548583006



Handi Clamps

- Quick Release trigger allows for fast, easy positioning and release
- Jaws designed to reach around odd shapes
- Non-marking swivel pads
- Made from strong, lightweight resin material
- Non-slip handles

Product Code	Jaw Opening	Shelf Pack	Barcode
59100	38mm (1½")	1	0038548591001
59200	50mm (2")	1	0038548592008
59400	100mm (4")	1	0038548594002



F Clamps

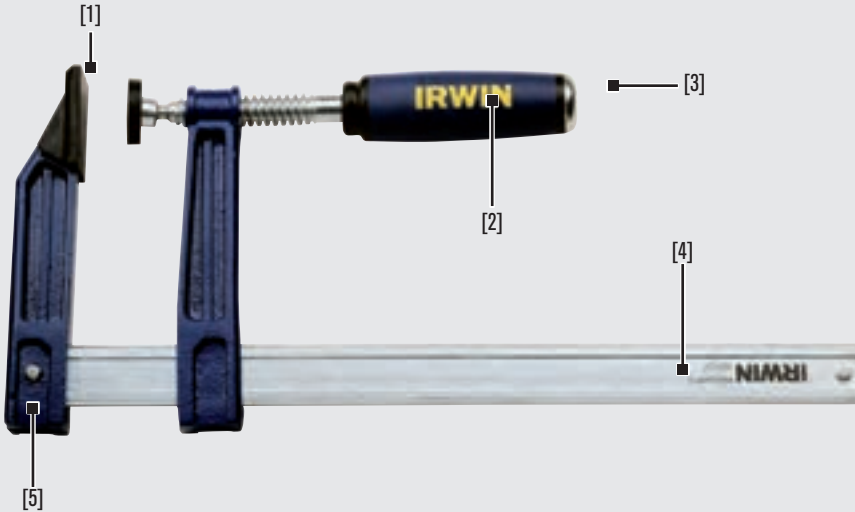

1. TPE pads snap fit to prevent loss and give excellent friction to work surface while reducing marking
2. Three-component handle for higher torque transfer than wood, plus added comfort (large range has tommy bar)
3. Ergonomic soft hexed handle
4. Zinc plated I-Beam for strength and rust prevention
5. Heads have flat feet allowing clamp to stand horizontally and vertically

Pro Clamp Small

- Clamping throat depth 80mm

Product Code	Description	Clamping Capacity	Frame Load	Barcode
10503564	Pro Clamp S200	200mm (8")	305kg	5706915035643
10503565	Pro Clamp S300	300mm (12")	305kg	5706915035650
10503566	Pro Clamp S400	400mm (16")	305kg	5706915035667
10503567	Pro Clamp S600	600mm (24")	305kg	5706915035674

Pro Clamp Medium

- Clamping throat depth 120mm



Product Code	Description	Clamping Capacity	Frame Load	Barcode
10503569	Pro Clamp M300	300mm (12")	510kg	5706915035698
10503570	Pro Clamp M400	400mm (16")	510kg	5706915035704
10503571	Pro Clamp M600	600mm (24")	510kg	5706915035711
10503572	Pro Clamp M800	800mm (32")	510kg	5706915035728
10503573	Pro Clamp M1000	1000mm (40")	510kg	5706915035735

Pro Clamp Large with Tommy Bar

- Clamping throat depth 140mm



Product Code	Description	Clamping Capacity	Frame Load	Barcode
10503574	Pro Clamp L400	400mm (16")	713kg	5706915035742
10503575	Pro Clamp L600	600mm (24")	713kg	5706915035759
10503576	Pro Clamp L800	800mm (32")	713kg	5706915035766
10503577	Pro Clamp L1000	1000mm (40")	713kg	5706915035773

Note: All Pro-Clamps come in pack quantities of 1

Sash & T-Bar Clamps

Flat Bar Sash Clamps

- Heavy duty clamps with 32mm x 6mm bar section
- Fixed head fitted square to bar with 1.5°-2° taper for a true parallel clamping action
- Durable steel handle and mainscrew
- Fast action rolled twin start acme thread for strength and wear resistance
- Flat bottomed – can stand without support

Product Code	Capacity	Shelf Pack	Barcode
135/2	610mm	1	0734442033363
135/3	750mm	1	0734442033486
135/4	915mm	1	0734442033608
135/5	1070mm	1	0734442033721
135/6	1220mm	1	0734442033844
135/9	1680mm	1	0734442033875

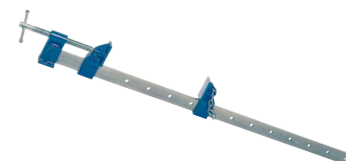

T-Bar Clamps

- Resists twisting under pressures up to 1900kg
- Fixed head fitted square to bar with 1.5°-2° taper for a true parallel clamping action
- Durable steel handle and mainscrew
- Fast action rolled twin start acme thread for strength and wear resistance
- Drilled feet for bench mounting

Product Code	Capacity	Shelf Pack	Barcode
136/6	1220mm	1	0734442034209
136/7	1370mm	1	0734442034322
136/9	1680mm	1	0734442034445
136/11	1980mm	1	0734442034568



G Clamps

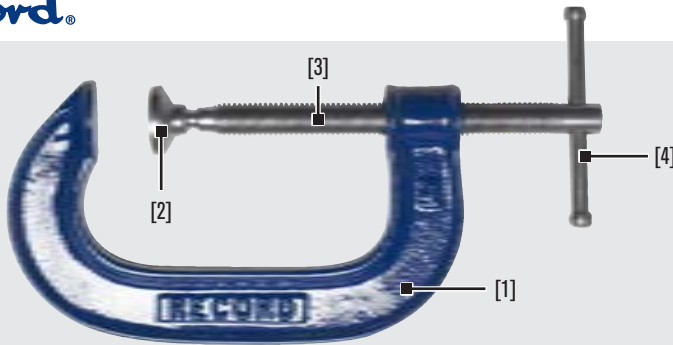

1. I-Braced design, cast from strong SG ductile iron
2. Adjustable steel swivel shoe to help clamp uneven surfaces
3. Fast and smooth action twin start acme cold rolled thread
4. Fused handle designed to bend if overloaded

Medium Duty G-Clamps – Cast Iron

- Recommended for general purpose work

Product Code	Capacity	Throat Depth	Frame Load	Shelf Pack	Barcode
120/3	75mm	55mm	455kg	4	0734442031086
120/4	100mm	60mm	545kg	4	0734442031208
120/6	150mm	75mm	635kg	4	0734442031321
120/8	200mm	85mm	775kg	1	0734442031444
120/10	250mm	105mm	1000kg	1	0734442031567
120/12	300mm	115mm	1135kg	1	0734442031680

Extra Heavy Duty G-Clamps – Forged

- Strongest G-Clamp available
- Drop forged steel for strength and durability
- Adjustable steel swivel shoe to help clamp uneven surfaces
- Fast action rolled twin start acme thread for strength and wear resistance
- Fused handle designed to bend if overloaded
- Recommended for metalworking and fabrication



Product Code	Capacity	Throat Depth	Frame Load	Shelf Pack	Barcode
121/3	75mm	55mm	2720kg	4	0734442031802
121/4	100mm	70mm	3170kg	4	0734442031925
121/6	150mm	90mm	4080kg	1	0734442032045
121/8	200mm	90mm	5670kg	1	0734442032168
121/10	250mm	100mm	6240kg	1	0734442032281
121/12	300mm	115mm	6800kg	1	0734442032403

Deep Throat G-Clamp

- Made from SG ductile iron
- For use when clamping well in from the edge



Product Code	Capacity	Throat Depth	Frame Load	Shelf Pack	Barcode
122/4	100mm	115mm	500kg	4	0734442030843

Specialty Clamps

Pipe Clamp

- Patented clutch system eliminates need for threaded pipe
- Larger feet offer more stability and clearance between handle and worktop
- Larger, more ergonomic handle for easier clamping
- Larger clutch plates allow for easier release
- Suits pipe 20mm (ID) 26mm (OD)

Product Code	Description	Shelf Pack	Outer Pack	Barcode
224134	20mm (3/4") Pipe Clamp	1	1	0038548014791

IRWIN
Record.



Flooring Clamp

- For clamping floor boards ready for nailing — fits up to 75mm joists
- Body made from cast iron, shoe and cams made from SG ductile iron
- Bevel gears completely enclosed for protection from dirt or damage
- Spring loaded cams for quick release
- Strong location shoe for applying even force to floor boards

Product Code	Description	Capacity	Shelf Pack	Barcode
MFC153	Flooring Clamp	Fits 75mm joists	1	0734442034926



Clamp Head Set

- Cast grey iron head and slide
- Fix to wooden battens 25mm x 38mm
- 11.1mm (7/16") holes required for fixing to timber
- Acts as a light duty bar clamp
- Please note the clamp is as strong as the battens used

Product Code	Description	Capacity	Shelf Pack	Barcode
M130	Clamp Head Set	-	6	0734442348078

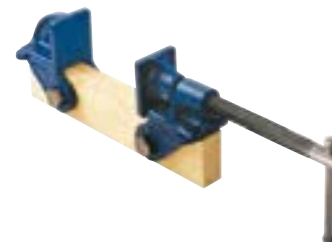



IRWIN®

Record®

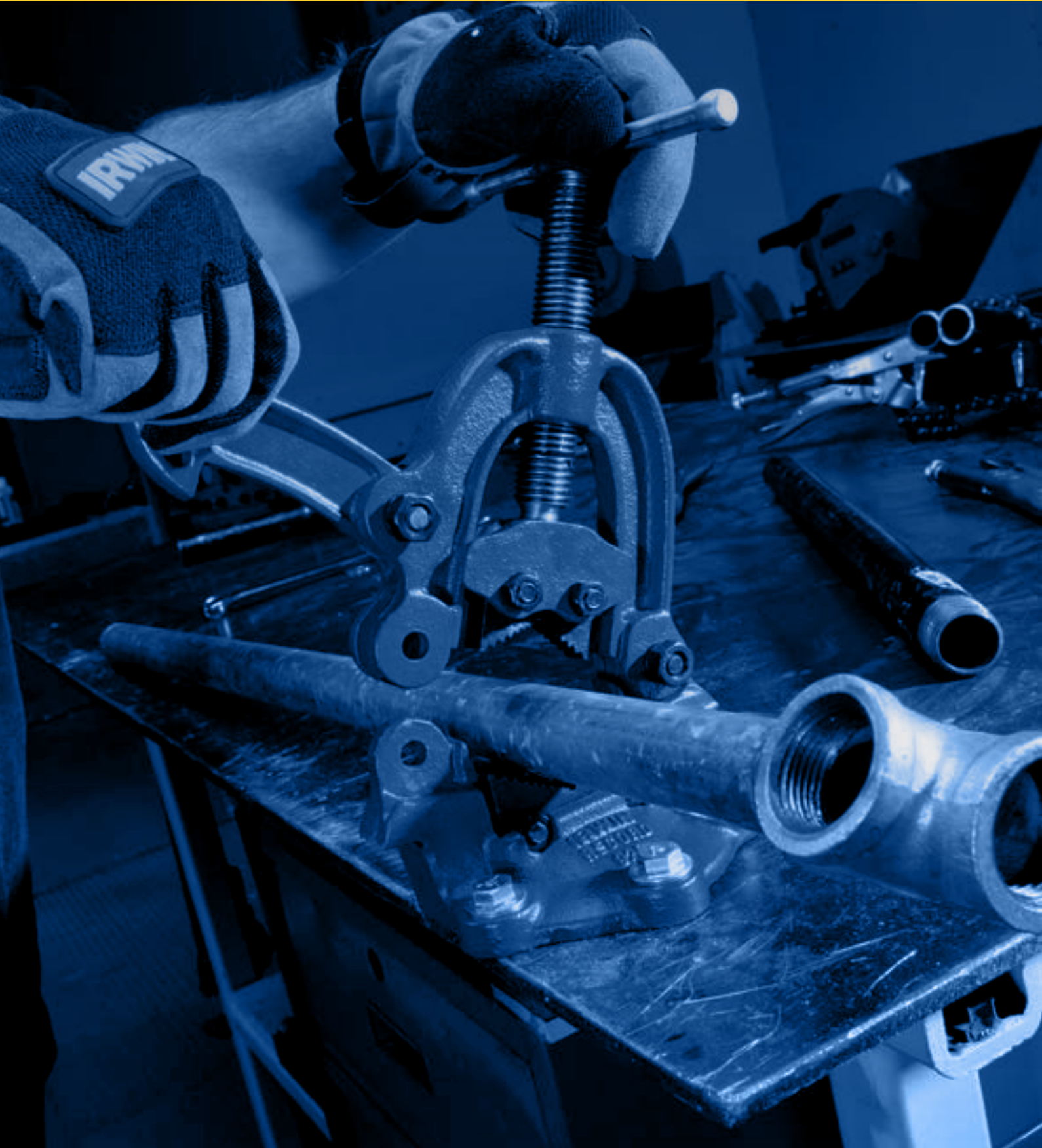

VICES



Mechanics Vices

1. Hardened steel jaws
2. Cast from close grained grey iron guaranteeing strength and long life
3. Fully machined on all load-bearing surfaces for smooth and trouble free operation
4. Fused steel handle will bend before the vice is overstressed
5. Fast action rolled twin start acme thread for strength and wear resistance

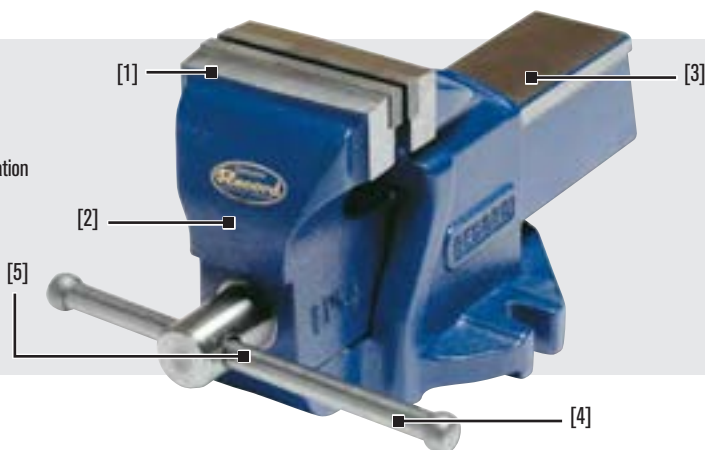

Mechanics Vices

Product Code	Jaw Width	Jaw Opening	Jaw Depth	Shelf Pack	Barcode
3	100mm	120mm	70mm	1	0734442000488
5	125mm	165mm	85mm	1	0734442000723
6	150mm	205mm	90mm	1	0734442000846
8	205mm	235mm	100mm	1	0734442000969

Workshop Vices

Pro Entry Vice

- Hardened steel jaws
- Fully machined on all load bearing surfaces for smooth and trouble free operation
- Unbreakable SG iron nut is dovetailed into the body
- Fused steel handle will bend before the vice can be overstressed
- Fast action rolled twin start acme thread for strength and wear resistance
- Integrated hardened steel anvil

Product Code	Jaw Width	Jaw Opening	Jaw Depth	Shelf Pack	Barcode
10507771	100mm	80mm	50mm	1	5706915077711



125mm Multi-Purpose Vice

- Hardened steel jaws
- Rotating head for flexibility in jaw usage and placement
- Integrated hardened steel anvil
- Swivel base - four mounting points and 360° rotation
- Integrated pipe jaws for holding round stock
- Fused steel handle will bend before the vice can be overstressed

Product Code	Jaw Width	Jaw Opening	Jaw Depth	Shelf Pack	Barcode
4935505	125mm	124mm	76mm	1	0038548989990



Workshop Vices (continued)



Quick-Adjusting Vice

- Quick release functionality
- Fused steel handle will bend before the Vice can be overstressed
- Built in safety stop
- Integrated hardened steel anvil
- Hardened steel jaws
- Swivel base 270° rotation
- Close grained grey cast iron body

Product Code	Jaw Width	Jaw Opening	Jaw Depth	Shelf Pack	Barcode
1959552	125mm	185mm	76mm	1	0042526942839

IRWIN
Record



Workshop Vice

- Cast from close grained grey iron
- 1TON-E-VSB includes swivel base

Product Code	Jaw Width	Jaw Opening	Jaw Depth	Shelf Pack	Barcode
1TON-E-B	100mm	100mm	60mm	1	0734442000204
1TON-E-VSB	100mm	100mm	60mm	1	0734442000235

Engineers Vices

Offset Engineers Steel Vice

- Durable all steel construction
- Offset jaws provide superior perpendicular clamping
- For heavy duty applications

Product Code	Jaw Width	Jaw Opening	Offset Jaws	Shelf Pack	Barcode
OS150	150mm	185mm	Unrestricted	1	6001991000158

Drill Press

- Unique swivel jaw for any shaped workpiece (414 only)
- Precision-machined base and face for stable horizontal or vertical mounting (414 only)
- Horizontal and vertical (414 only) V-Grooved jaws provide excellent grip when clamping pipes
- Cross-drilled handle with tommy bar for extra leverage (414 only)
- High quality cast iron body and sliding jaw

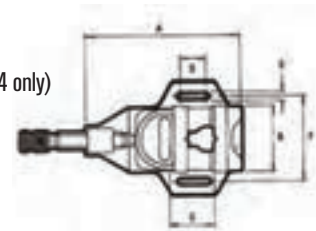

Product Code	A	B	C	D	E	F	Jaw Depth	Barcode
414	229mm	100mm	75mm	47mm	14mm	125mm	32mm	0734442001560
PV3B	213mm	106mm	75mm	68mm	-	141mm	35mm	0734442050513

Note: Pack quantity = 1



Woodworking Vices

Woodcraft Vices

- Body and slide made from grey iron
- Fast action rolled twin start acme thread for strength and wear resistance
- Two parallel slide rods for smooth operation
- Mounts under bench tops
- Suitable for young woodworker or handyman

Product Code	Jaw Width	Jaw Opening	Shelf Pack	Barcode
V175B	175mm	165mm	1	0734442029885

Woodworking Vices – Plain Screw

- Cast from grey iron
- CNC machined for consistent reliability
- Two steel guide rods reduce wear and ensure smooth, parallel action
- Mounts under bench tops

Product Code	Jaw Width	Jaw Opening	Shelf Pack	Barcode
52PD	175mm	205mm	1	0734442047889
52-1/2PD	230mm	330mm	1	0734442047896

Woodworking Vices – Quick Release

- Cast from grey iron
- CNC machined for consistent functioning
- Time saving quick release mechanism
- Mounts under bench tops
- Unbreakable SG ductile iron half-nut takes the load and can be replaced when worn

Product Code	Jaw Width	Jaw Opening	Shelf Pack	Barcode
52ED	175mm	205mm	1	0734442030249

IRWIN
Record.





Pipe Vices

Chain Pipe Vices

- Cast from SG ductile iron
- Drop forged heat treated steel jaws
- Ideal for use in confined spaces

Product Code	Pipe Capacity	Shelf Pack	Barcode
181C	1mm-60mm	1	0734442143161
182C	10mm-115mm	1	0734442143284
183C	15mm-220mm	1	0734442143406



Hinged Pipe Vices

- Frame and base cast from strong SG ductile iron
- Hardened and tempered steel jaws
- Ideal for fast, repetitive work

Product Code	Pipe Capacity	Shelf Pack	Barcode
92-12C	3mm-63mm	1	0734442143642



Tripod Stand

- For use with 182C, 92C and 921/2C Pipe Vices
- Hinged tool tray
- Fold-down platform
- Complete unit folds flat for easy transporting

Product Code	Description	Shelf Pack	Barcode
TS10	Tripod Stand (Vice Optional Extra)	1	0734442142560

Accessories

Fibre Grips for Vices

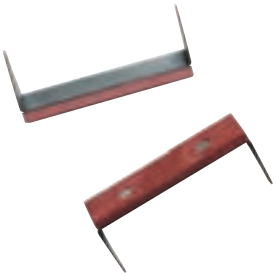

Product Code	Description	Compatible Vice	Shelf Pack	Barcode
FG5	125mm per pair	5	6	0734442002529
FG6	150mm per pair	6	6	0734442002765



INNOVATION TIMELINE

4-Point Blades

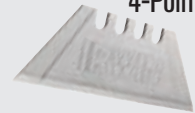

Carpet Knife



Drywall Knife



Re-Designed ProTouch Knife



General Contractors Knife



2011

Folding Knife



Bi-Metal Snap & Safety Blades



2008

Safety Knife



Snap Knives & Blades



2006

IRWIN enters the Knives & Blades Market

ProTouch Knife & Bi-Metal Blue Blade



Standard Retractable & Fixed Utility Knives



2005

UTILITY KNIVES & BLADES

Utility Knives

1. Easy blade change with safe lock system to prevent blade from slipping during use
2. Finger notch to gain leverage when cutting on a pull action
3. Tool free access to spare blades, storing up to ten blades
4. Made from lightweight and hard-wearing aluminium
5. ProTouch™ soft grip for added comfort and to reduce hand fatigue

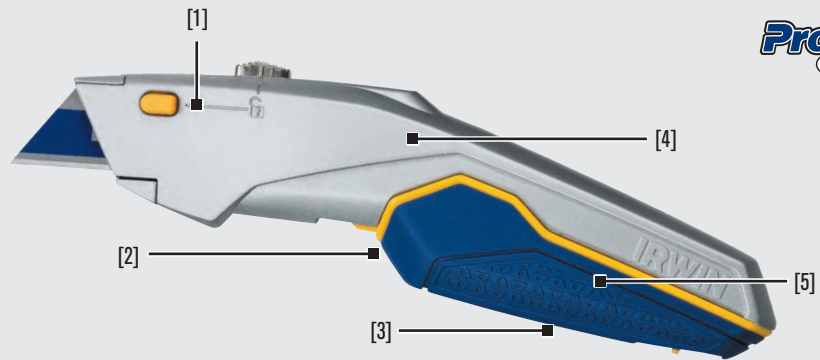

ProTouch
GRIPS

ProTouch™ Retractable Knife

- Includes three Bi-Metal Utility Blades

Product Code	Description	Shelf Pack	Barcode
1774106	ProTouch™ Retractable Utility Knife	5	0038548992877

ProTouch™ Original Retractable Utility Knife

- Quick Change mechanism for easy blade changes
- Smooth three-position slide for variable blade lengths
- Easy tool-free push button entry
- ProTouch™ ergonomic grip
- Internal storage for up to five blades
- Includes three Bi-Metal Utility Blades

Product Code	Description	Shelf Pack	Barcode
2082200	ProTouch™ Original Retractable Utility Knife	5	0038548018218



General Contractor Retractable Utility Knife

- Finger notch to gain leverage when cutting on a pull action
- Tool free access to spare blades and easy blade change – push button opens knife casing. Stores three blades
- Made from lightweight and hard-wearing aluminium
- Ergonomic textured handle design for added comfort and greater grip
- Includes three Bi-Metal Utility Blades

Product Code	Description	Shelf Pack	Barcode
1774105	General Contractor Retractable Utility Knife	5	0038548992860



Utility Knives (continued)

Drywall Fixed Utility Knife



- Slim profile nose for greater comfort and control on nose
- Finger notch to gain leverage when cutting on a pull action
- Tool free access to spare blades and easy blade change – captive bail screw opens knife casing. Stores three blades
- Magnetised blade plate prevents blade from falling out when casing is open
- Made from lightweight and hard-wearing aluminium
- Ergonomic textured handle design for added comfort and greater grip
- Includes three 4-Point Carbon Utility Blades

Product Code	Description	Shelf Pack	Barcode
1774104	Drywall Fixed Utility Knife	5	0038548992853

Standard & Hi-Vis Retractable Utility Knife



- Strong die cast aluminium body with 19° angled nose for greater comfort and to reduce strain
- Magnetised blade holder prevents blade from falling out when casing is open
- Screw is threaded into aluminium body preventing screw from falling out when casing is opened
- Internal blade storage for up to five blades
- Includes three 4-Point Carbon Utility Blades

Product Code	Description	Shelf Pack	Barcode
2082100	Standard Retractable Utility Knife	5	0038548018232
2082300	Hi-Vis Retractable Utility Knife	5	0038548018249

Standard Fixed Utility Knife



- Strong die cast aluminium body with 19° angled nose for greater comfort and to reduce strain
- Magnetised blade plate prevents blade from falling out when casing is open
- Screw is threaded into aluminium body preventing screw from falling out when casing is opened
- Internal blade storage for up to five blades
- Includes three 4-Point Carbon Utility Blades

Product Code	Description	Shelf Pack	Barcode
2081100	Standard Fixed Utility Knife	5	0038548018225

Carpet Utility Knife



- Finger notch to gain leverage when cutting on a pull action
- Captive bail screw for easy tool-free blade changes
- Ergonomic design for blade rigidity to ensure straight cuts in flooring material
- Internal blade storage for up to five blades
- Includes three Carpet Blades

Product Code	Description	Shelf Pack	Barcode
1774107	Carpet Utility Knife	5	0038548992884

Auto-Retracting Safety Utility Knife

- Blade automatically retracts when it loses contact with cut material
- Strong die cast aluminium body with 19° angled nose for more comfortable cutting and to reduce strain
- Magnetised blade holder prevents blade from falling out when casing is open
- Captive bail screw for easy tool-free blade changes
- Internal blade storage for up to three blades
- Includes 1 Bi-Metal Safety Blade



Product Code	Description	Shelf Pack	Barcode
2088600	Auto-Retracting Safety Utility Knife	5	0038548078243

Folding Utility Knife

- Quick change button for fast and safe blade changes. Blade can only be released when folded at 45° angle preventing blade from slipping
- Lock release button for compact fold-down
- Convenient wire stripping notch
- Wide thumb ledge for leverage while cutting
- Ergonomic handle design for added comfort
- Key ring loop and anchored belt clip
- Includes 1 Bi-Metal Utility Blade



Product Code	Description	Shelf Pack	Barcode
2089100	Folding Utility Knife	10	0038548093215

ProTouch™ Snap Off Utility Knife

- Slim nose design for accuracy and maximum visibility when cutting
- Auto-lock slider holds blade securely during use
- Durable and lightweight aluminium body with stainless steel slider
- ProTouch™ soft grip for added comfort and to reduce hand fatigue
- Hinged end cap remains in place while blade cartridge is restocked. Stores up to three blades
- 18mm ProTouch™ Snap Knife includes three Bi-Metal Utility Snap Blades
- 9mm ProTouch™ Snap Knife includes three Carbon Utility Snap Blades



Product Code	Description	Shelf Pack	Barcode
2086200	9mm ProTouch™ Snap Off Utility Knife (Carbon blade)	5	0038548040332
10507106	18mm ProTouch™ Snap Off Utility Knife (Bi-Metal blade)	5	5706915071061
10504553	25mm ProTouch™ Snap Off Utility Knife	5	5706915045536

Standard Snap Off Utility Knife

- Auto-lock slider holds blade securely during use
- Strong and lightweight ABS body with stainless steel slider
- Thumb ledge for safe and controlled cutting
- Textured surface for greater grip during use
- Hinged end cap remains in place while blade cartridge is restocked. Stores up to three blades
- 18mm Standard Snap Knife includes three Bi-Metal Utility Snap Blades



Product Code	Description	Shelf Pack	Barcode
2086102	18mm Standard Snap Off Utility Knife (Bi-Metal blade)	5	0038548097343

Blades

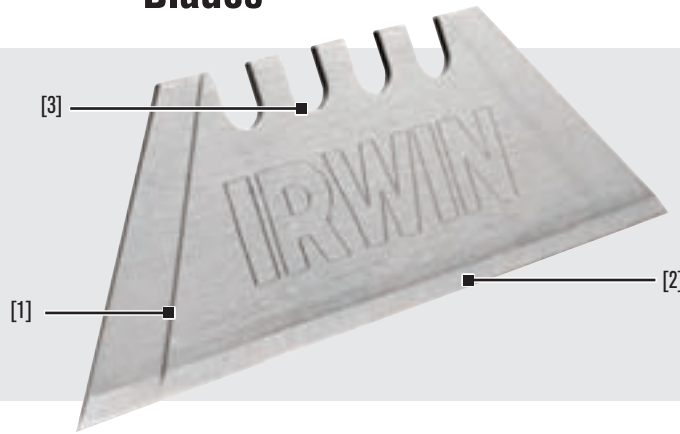

1. Scored lines to snap a sharp new point
2. Carbon steel cutting edge
3. Increased notches to maintain blade length



4-Point Carbon Utility Blades



Product Code	Blade Qty	Shelf Pack	Barcode
1764983	5	5	0038548990859
1764985	50 w/ Dispenser	5	0038548990835

Bi-Metal Utility Blades

- Bi-Metal blade for heavy duty cutting
- Shatterproof spring steel body allows blade to bend and flex
- High speed steel cutting edge stays sharper longer



Product Code	Blade Qty	Shelf Pack	Barcode
2084100	5	5	0038548018256
2084200	20 w/ Dispenser	5	0038548022253
2084300	50 w/ Dispenser	5	0038548018263
2084400	100 w/ Dispenser	5	0038548018270

Bi-Metal Safety Utility Blades

- Snub nose reduces risk of accidental puncture wounds
- Shatterproof spring steel body allows blade to bend and flex
- High speed steel cutting edge stays sharper longer



Product Code	Blade Qty	Shelf Pack	Barcode
2088100	5	5	0038548078335

Carbon Utility Blades

- Carbon blade for general purpose cutting
- Carbon steel cutting edge

Product Code	Blade Qty	Shelf Pack	Barcode
2083100	5	5	0038548018287
2083200	100 w/ Dispenser	5	0038548018294

Carpet Blades

- Straight edge allows user to efficiently and effectively cut on the pull action
- Provides blade rigidity to ensure straight cuts in flooring materials
- Carbon steel cutting edge

Product Code	Blade Qty	Shelf Pack	Barcode
1777341	5	5	0038548992235

Hook Blades

- Hooked point protects surface underneath
- Carbon Blade

Product Code	Blade Qty	Shelf Pack	Barcode
2087100	5	5	0038548040455

Bi-Metal Snap Off Blades

- Shatterproof spring steel body allows blade to bend and flex
- High speed steel cutting edge stays sharper longer
- Blade snaps cleanly at the intended point and provides user with a regular sharp new cutting tip

Product Code	Blade Qty	Length	Shelf Pack	Barcode
2086403	3	18mm	25	0024721095787
2086404	10 w/ Dispenser	18mm	5	0024721095794

Carbon Snap Off Blades

- Carbon blade for general purpose cutting
- Blade snaps cleanly at the intended point and provides user with a regular sharp new cutting tip

Product Code	Blade Qty	Length	Shelf Pack	Barcode
2086301	10 w/ Dispenser	9mm	5	0038548040387
10504559AU	10 w/ Dispenser	25mm	5	9314244005563

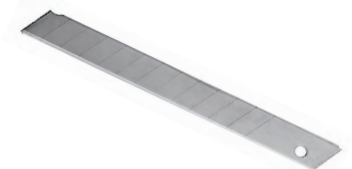
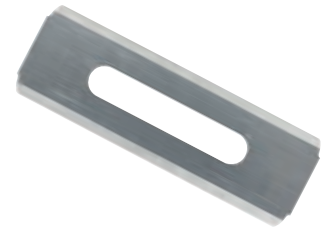



IRWIN®

STRAIT-LINE®





MARKING TOOLS

Chalk Reels

1. Easy Fill & Lock Top features a large, 1/4-turn locking top for quick chalk fill and easy access to reel internals
2. 30m hi-tensile line is stronger for fewer breaks and for use on rough, abrasive surfaces
3. 6:1 Gear ratio rewinds line 6X faster than traditional chalk reels
4. Open access back panel allows for quick line change and cleaning
5. Metal drive gear resists gear failure under heavy load
6. Robust steel handle and large ergonomic clutch for increased durability, strength, and torque
7. Wide-prong hook for secure anchoring
8. Durable aluminium housing provides impact resistance

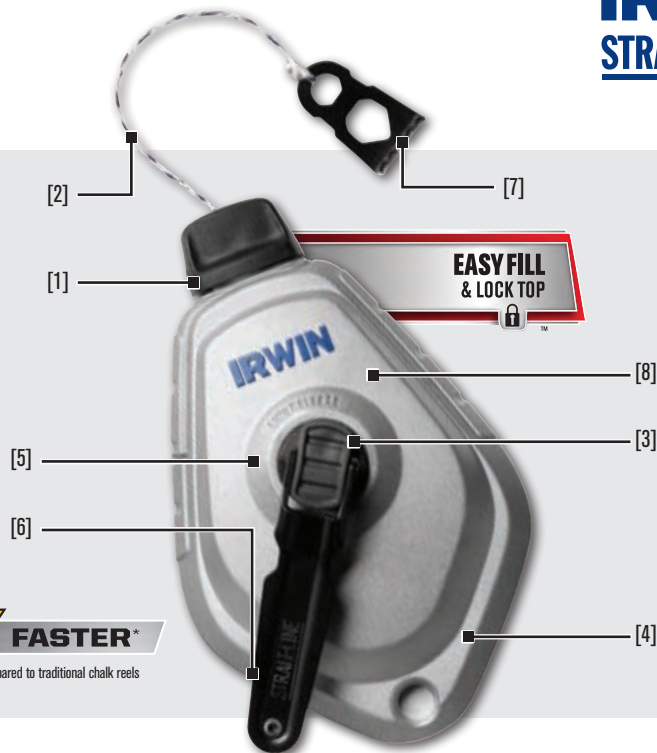

6X FASTER*
*as compared to traditional chalk reels

MACH6™ Chalk Reel

MACH6

Product Code	Description	Line Length	Shelf Pack	Barcode
1932877	MACH6 Chalk Reel (Display Tray)	30m	8	0042526936746
1932889	MACH6 Chalk Reel with Blue Chalk 4oz/113g	30m	8	0042526936883



Easy Fill & Lock Top

Open Access Back Panel

Speedline™ PRO Chalk Reel

SPEEDLINE PRO

- Easy Fill & Lock Top features a large, 1/4-turn locking top for quick chalk fill and easy access to reel internals
- 30m hi-tensile line is stronger for fewer breaks and for use on rough, abrasive surfaces
- 3:1 gear ratio rewinds line 3X faster than traditional chalk reels
- Robust steel handle and large ergonomic clutch for increased durability, strength, and torque
- Wide-prong hook for secure anchoring
- Lightweight ABS housing withstands jobsite wear and tear

Product Code	Description	Line Length	Shelf Pack	Barcode
1932876	Speedline PRO Chalk Reel (Display Tray)	30m	8	0042526936739
1932887	Speedline PRO Chalk Reel with Blue Chalk 4oz/113g	30m	8	0042526936869



2.5X STRONGER LINE*
*as compared to traditional chalk reels



Chalk Reels (continued)

SPEEDLINE

Speedline™ Chalk Reel

- Wide door for quick and easy chalk fill
- 30m abrasion-resistant poly line provides 5-6 strikes per pull
- 3:1 gear ratio rewinds line 3X faster than traditional chalk reels
- Robust steel handle and large ergonomic clutch for increased durability, strength, and torque
- Lightweight ABS housing withstands jobsite wear and tear

Product Code	Description	Line Length	Shelf Pack	Barcode
1932874	Speedline Chalk Reel (Display Tray)	30m	8	0042526936708
1932883	Speedline Chalk Reel with Blue Chalk 4oz/113g (Display Tray)	30m	8	0042526936814
1932875	Speedline Chalk Reel (Bulk)	30m	24	0042526936715

Classic Chalk Reel

- Wide door for quick and easy chalk fill
- 30m abrasion-resistant poly line provides 5-6 strikes per pull
- Item 1932871 features a 15m poly line
- 1:1 gear ratio rewinds line
- Robust steel handle and large centre hub
- Durable aluminium housing



Product Code	Description	Line Length	Shelf Pack	Barcode
1932871	Classic Chalk Reel	15m	6	0042526936678
1932872	Classic Chalk Reel (Display Tray)	30m	8	0042526936685
1932880	Classic Chalk Reel with Blue Chalk 4oz/113g (Display Tray)	30m	8	0042526936777
1932873	Classic Chalk Reel (Bulk)	30m	24	0042526936692

LayoutPro™ Chalk Reel

LAYOUTPRO

- 10oz/283g chalk capacity for fewer refills on large jobs
- 30m heavy-duty braided line resists fraying and breaking over long distances
- 2:1 gear ratio rewinds line 2X faster than traditional chalk reels
- Soft-touch ergonomic grip provides comfort and control while snapping lines
- Large sliding door for easy chalk fill
- Steel docking ring for secure anchoring
- Robust steel handle and large center hub for increased durability, strength and torque



Product Code	Description	Chalk Capacity	Line Length	Shelf Pack	Barcode
1932878	Layout Pro Chalk Reel	10oz/283g	30m	2	42526936753

LayoutPro™ XL Chalk Reel

LAYOUTPRO XL

- 20oz/567g chalk capacity for fewer refills on large jobs
- 45m heavy-duty braided line resists fraying and breaking over long distances
- 2:1 gear ratio rewinds line 2X faster than traditional chalk reels
- Soft-touch ergonomic grip provides comfort and control while snapping lines
- Large sliding door for easy chalk fill
- Steel docking ring for secure anchoring
- Robust steel handle and large center hub for increased durability, strength and torque



Product Code	Description	Chalk Capacity	Line Length	Shelf Pack	Barcode
1932879	Layout Pro XL Chalk Reel	20oz/567g	45m	2	42526936760

Replacement Lines for STRAIT-LINE Chalk Reels

Product Code	Description	Line Length	Shelf Pack	Barcode
1932892	Polyester Replacement Line	15m	6	42526936913
1932893	Polyester Replacement Line	30m	6	42526936920
1932894	Hi-Tensile Replacement Line	30m	6	42526936937
1932895	0.5mm Precision Replacement Line	30m	6	42526936944
1932896	LayoutPro Replacement Line	30m	1	42526936951

IRWIN
STRAIT-LINE



Marking Chalk

- For use on a variety of surfaces including wood, plasterboard, concrete, stone and metal
- Permanent colours, particularly black, produce long lasting lines that won't fade
- Violet Dust-Off chalk gives high visibility lines that are easy to remove
- Easy to open flip-top cap
- Hi-flow Nozzle Cap on Permanent Staining Chalk

Product Code	Description	Line Length	Shelf Pack	Barcode
Dust-Off Marking Chalk				
4935426	Light Violet Dust Off	6oz/170g	6	24721112446
Standard Marking Chalk				
64901	Blue Standard	8oz/228g	6	24721500076
65201	Blue Standard	2.5lb/1.3kg	6	24721652010
65101ZR	Blue Standard	5lb/2.26kg	4	24721500205
64904	White Standard	8oz/228g	6	24721500144
Hi-Visibility Marking Chalk				
64907	Green Fluoro Hi-Vis	8oz/228g	6	24721649072
64905ZR	Orange Fluoro Hi-Vis	8oz/228g	6	24721649058
64903	Yellow Fluoro Hi-Vis	8oz/228g	6	24721500137
Permanent Marking Chalk				
64908	Black Permanent	8oz/228g	6	24721649089
65207	Black Permanent	2.5lb/1.3kg	6	24721652072
64902	Red Permanent	8oz/228g	6	24721500120
65202	Red Permanent	2.5lb/1.3kg	6	24721652027
65102	Red Permanent	5lb/2.26kg	4	24721500212
Permanent Staining Marking Chalk				
4935519	Crimson Red Permanent Staining	6oz/170g	6	24721999276
4935518	Indigo Blue Permanent Staining	6oz/170g	6	24721999269
4935520	Black Permanent Staining	6oz/170g	6	24721999283



IRWIN TOOLS

PERMANENCY SCALE ← Low → High

0	1	2	3	4
<p>DUST-OFF</p> <p>Permanency</p> <p>INDOOR</p> <ul style="list-style-type: none"> • Eliminates the need for priming before painting • Ideal for composite decking <p>COLOURS</p> <p>Interior Finish Work</p>	<p>STANDARD</p> <p>Permanency</p> <p>INDOOR/OUTDOOR</p> <ul style="list-style-type: none"> • Temporary marking chalk <p>COLOURS</p>	<p>HI-VISIBILITY</p> <p>Permanency</p> <p>INDOOR/OUTDOOR</p> <ul style="list-style-type: none"> • Low light conditions • Corrective marking <p>COLOURS</p>	<p>PERMANENT</p> <p>Permanency</p> <p>OUTDOOR</p> <ul style="list-style-type: none"> • Weather-resistant lines remain visible after weeks of weather and jobsite wear and tear <p>COLOURS</p>	<p>PERMANENT STAINING</p> <p>Permanency</p> <p>OUTDOOR</p> <ul style="list-style-type: none"> • Withstands months of weather and jobsite wear and tear • Reduces need for additional sealant <p>COLOURS</p> <p>Extreme Conditions</p>

*Based on rainfall average of 10.0mm/month



Other Marking

Carpenter's Pencils

- For temporary marking on timber and concrete surfaces
- Available in 3 lead types: soft, medium and hard
- 178mm length

Product Code	Hardness	Shelf Pack	Barcode
Bulk Pack			
66300	Medium	12	0024721663009
66301	Soft	12	0024721663016
66302	Hard	12	0024721663028
Bulk Individual			
66305SL	Medium	72	0024721028150

Note: Available in pack quantities only

Marking Crayons

- For marking on timber and concrete surfaces
- Suitable for timber, concrete, ceramics, rubber, metal, paper and cardboard
- 6 colours available - black, white, green, yellow, red and blue
- Wax based and non-toxic
- Waterproof marking for long life
- Overall length 115mm



Product Code	Colour	Shelf Pack	Barcode
66401	Red	12	0024721664013
66402	Blue	12	0024721664020
66403	Green	12	0024721664037
66404	Black	12	0024721664044
66405	White	12	0024721664051
66406	Yellow	12	0024721664068

Note: Available in pack quantities only

Pencil Sharpener, Barrier & Flagging Tapes

Pencil Sharpener

- 50% less pencil wastage per sharpening cycle
- Integrated emery board for fine point filing
- Narrow sharpening angle for broader, more durable point and reduced lead breaking

Product Code	Description	Shelf Pack	Barcode
233250	Carpenter pencil sharpener counter box - 25 units	1	0024721007087



Barrier Tapes

- High visibility, durable, non-adhesive, non-conducting, weatherproof vinyl tape
- 90m long x 75mm wide printed

Product Code	Description	Shelf Pack	Barcode
66200	Caution Tape	8	0024721710017
66202	Danger Do Not Enter Tape	8	0024721710123



Flagging Tapes (Uncarded) - Fluorescent

- High visibility weatherproof plastic
- 45m long x 30mm wide

Product Code	Description	Shelf Pack	Barcode
65604	Lime-Glo Fluorescent	24	0024721710055
65602	Orange-Glo Fluorescent	24	0024721710031
65603	Pink-Glo Fluorescent	24	0024721710048
65601	Red-Glo Fluorescent	24	0024721710024



Tape Measures

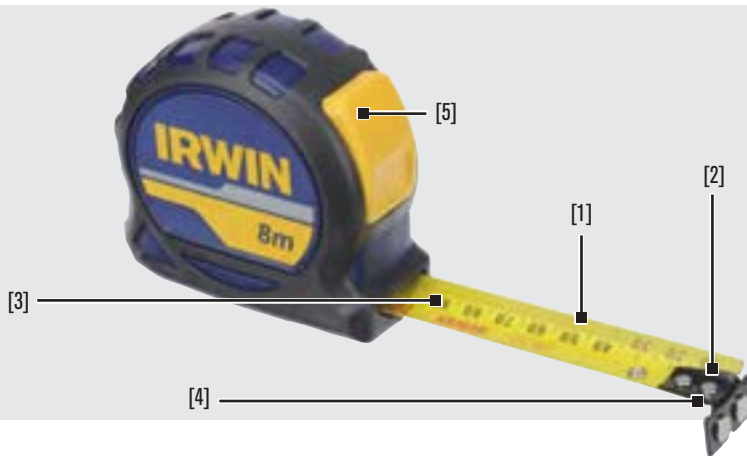

1. Nylon blade coating for longer blade life
2. Three rivet end hook with reinforced metal backing for durability
3. Double sided blade print for greater versatility
4. Magnetic blade hook for working with metal structures
5. Fast lock for quick and easy blade control

Professional Tape Measures

Product Code	Blade Length	Shelf Pack	Barcode
Carded			
1780220	8m - Metric	6	0038548992471
Bulk			
1780293	8m - Metric	12	0038548992648

Standard Tape Measures

- Acrylic blade coating for longer blade life
- ABS plastic case with ProTouch™ rubber grip for comfort and durability
- Three rivet end hook with reinforced metal backing for durability
- Sliding lock for easy blade control

Product Code	Blade Length	Shelf Pack	Barcode
Carded			
1780218	8m - Metric	6	0038548992457
Bulk			
1780291	8m - Metric	12	0038548992624

Basic Tape Measures

- Acrylic blade coating for longer blade life
- Three rivet end hook with reinforced metal backing for durability
- Sliding lock for easy blade control

Product Code	Description	Shelf Pack	Barcode
Bulk			
1780288	8m - Metric	12	0038548992563



Squares & Bevels

Metal Squares

- High quality, long life stainless steel etched blades
- Sliding level point for accurate marking
- Accurate square tolerance 0.1/100mm, blade thickness 1.25mm
- Handles made from a strong diecast aluminium block with ribbed insert for improved gripping

Product Code	Size	Shelf Pack	Barcode
10503543	250mm	4	5706915035438
10503544	300mm	4	5706915035445
10503545	350mm	4	5706915035452



Metal Bevels

- High quality, long life stainless steel blades
- Designed for free and easy movement and positive locking positions
- Accurate square tolerance 0.1/100mm, blade thickness 1.25mm

Product Code	Size	Shelf Pack	Barcode
10503546	250mm	4	5706915035469
10503547	300mm	4	5706915035476



Rosewood Bevels

- Plantation grown rosewood
- Hardened steel blade – can be locked in any position with thumb screw
- For marking regular and irregular angles

Product Code	Size	Shelf Pack	Barcode
M2226-9	225mm	4	0734442231844

IRWIN
Marples®



Gauges

Marking Gauges

- Fitted with durable hardened steel spurs
- Plantation grown rosewood and quality brass fittings
- Used to scribe parallel lines along the grain

Product Code	Shelf Pack	Barcode
MR2049	6	0734442231967







INNOVATION TIMELINE

Locking Multi-Pliers

2015

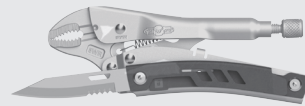

CR Jaw Locking Pliers

2010



GrooveLock Pliers

2005



Fast Release Locking Pliers

2004



Soft Grip Locking Pliers

2002



Large Capacity Locking Pliers

1994



Long Nose Locking Plier

1978



Large Throat C-Clamps

1972



Locking Chain Clamp

1962



Trigger Release Mechanism Developed

1957



C-Clamp Pinch Off Tool
Welding Clamp Sheet
Metal Tool

1948



Improved VISE-GRIP
Locking Pliers - No Trigger

1942



First VISE-GRIP Locking
Wrench

1924



First VISE-GRIP Wrench

1922



LOCKING TOOLS



Fast Release™ Locking Pliers

- Four-tools-in-one design allows users to carry less on the job site
- Fast Release™ handle offers one-handed triggerless release with no pinch points

1. Fold-out knife features a stainless steel blade for convenience
2. Fold-out screwdriver includes 1/4" bit holder with 6-8 slotted and #2 Phillips® bits
3. Constructed of high-grade, heat treated alloy steel for maximum toughness and durability
4. Hex key adjusting screw offers controlled release and draws materials together

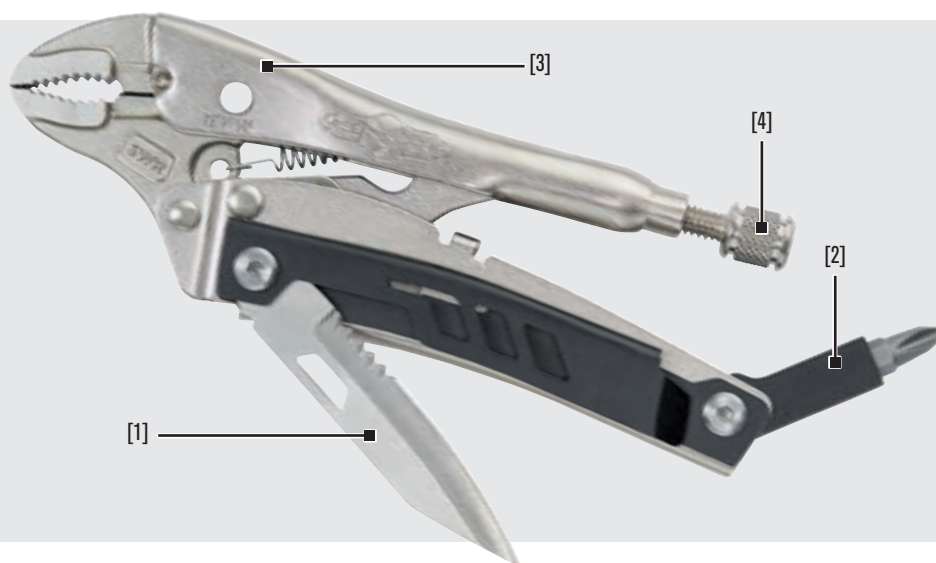

Curved Jaw Multi-Pliers with Wire Cutter

Product Code	Model	Description	Size	Tip Adjustment	Shelf Pack	Barcode
1923454	5WR	Curved Jaw w/ Wire Cutter Multi-Pliers	125mm	1-1/8" (29mm)	5	0042526935961

Curved Jaw Multi-Pliers

Product Code	Model	Description	Size	Tip Adjustment	Shelf Pack	Barcode
1923456	5CR	Curved Jaw Multi-Pliers	125mm	1-1/8" (29mm)	5	0042526935985



Long Nose Multi-Pliers

- Long nose provides easy access in narrow, hard-to-reach places

Product Code	Model	Description	Size	Tip Adjustment	Shelf Pack	Barcode
1923455	6LN	Long Nose Multi-Pliers	150mm	1-1/8" (29mm)	5	0042526935978



Fast Release™ Locking Pliers (continued)

- Fast Release™ handles offer one-handed triggerless release - eliminating pinching during release
- 2X easier to open from any angle by simply pulling - no need to put pressure on a trigger
- No pinch points - elimination of trigger means no pinching during release
- Hex key adjusting screw



1. Self-Energising lower jaw provides maximum torque without requiring heavy input pressure - jaw mechanism naturally grips tighter as more torque is applied to the tool



Fast Release™ Curved Jaw Locking Pliers

Product Code	Model	Size	Jaw Thickness	Tip Adjustment	Shelf Pack	Barcode
4935581*	5CR	125mm	6.4mm	29mm	5	0038548990743
13T	7CR	175mm	8mm	38mm	5	0038548101941
11T	10CR	250mm	9.5mm	48mm	5	0038548101934

* 125mm pliers do not include ProTouch™ soft grip

Fast Release™ Curved Jaw Locking Pliers with Wire Cutter



Product Code	Model	Size	Jaw Thickness	Tip Adjustment	Cutting Capacity	Shelf Pack	Barcode
09T*	5WR	125mm	6.4mm	29mm	1.22mm	5	0038548067506
07T	7WR	175mm	8mm	38mm	2.31mm	5	0038548067490
05T	10WR	250mm	9.5mm	47.6mm	6.50mm	5	0038548067483

* 125mm pliers do not include ProTouch™ soft grip

Fast Release™ Straight Jaw Locking Pliers

- Straight jaws provide maximum contact on flat, square or hex work



Product Code	Model	Size	Jaw Thickness	Jaw Adjustment	Shelf Pack	Barcode
03T	7R	175mm	4.1mm	33mm	5	0038548101927
01T	10R	250mm	15.9mm	44mm	5	0038548101910

Fast Release™ Long Nose Locking Pliers with Wire Cutter

- Long straight nose provides easy access in narrow, hard-to-reach places

Product Code	Model	Size	Jaw Thickness	Jaw Adjustment	Cutting Capacity	Shelf Pack	Barcode
14T*	6LN	150mm	3.2mm	51mm	1.22mm	5	0038548067513
15T	9LN	225mm	3.2mm	70mm	2.31mm	5	0038548101958

* 150mm pliers do not include ProTouch™ soft grip



Fast Release™ Locking C-Clamps

- Wide opening jaws provide greater versatility - can clamp a wide variety of shapes

Product Code	Model	Size	Jaw Thickness	Jaw Adjustment	Shelf Pack	Barcode
17T*	6R	150mm	0mm-54mm	35mm	5	0038548067537
19T	11R	275mm	0mm-85mm	63mm	5	0038548067520

* 150mm pliers do not include ProTouch™ soft grip



Fast Release™ Locking Pliers Sets

2pc Fast Release™ Curved Jaw Set

- Contains 10WR (05T) and 5WR (07T) Pliers

Product Code	Description	Shelf Pack	Barcode
214T	2pc Fast Release Curved Jaw Set (05T, 07T)	5	0038548067544



2pc Fast Release™ Locking Pliers Set

- Contains 10WR (05T) and 6LN (14T) Pliers

Product Code	Description	Shelf Pack	Barcode
77T	2pc Fast Release Locking Plier Set (05T, 14T)	5	0038548067551



3pc Fast Release™ Locking Pliers Set with Kit Bag

- Contains 10WR (05T), 9LN (15T) and 7R (03T) Pliers

Product Code	Description	Shelf Pack	Barcode
76KBT	3pc Fast Release Locking Pliers Set w/Kit Bag (05T, 15T, 03T)	5	0038548101996



5pc Fast Release™ Locking Pliers Set with Kit Bag

- Contains 10R (01T), 10CR (11T), 7WR (07T), 5WR (09T) and 6LN (14T)

Product Code	Description	Shelf Pack	Barcode
538KBT	5pc Fast Release Locking Pliers Set w/Kit Bag (01T, 11T, 07T, 09T, 14T)	5	0038548101972





'The Original' Locking Pliers

- IRWIN The Original locking tools, with a classic guarded trigger release are designed to provide maximum locking force
- Hex key adjusting screw



1. Curved jaws put tremendous pressure on four points of any style nut or bolt head and better fits on round stock
2. Can be used as a non-slip pipe wrench, pliers, adjustable wrench, emergency handle and all purpose clamp
3. Self-Energising lower jaw provides more gripping power, with no stripping on any style nut or bolt head

3X MORE GRIPPING POWER*
*vs. traditional IRWIN® VISE-GRIP Locking Pliers

The Original

Curved Jaw Locking Pliers

Product Code	Size	Jaw Thickness	Jaw Adjustment	Shelf Pack	Barcode
7CR	175mm	8mm	38mm	5	0038548013046
10CR	250mm	9.5mm	47.6mm	5	0038548011042

Curved Jaw Locking Pliers with Wire Cutter

Product Code	Size	Jaw Thickness	Jaw Adjustment	Cutting Capacity	Shelf Pack	Barcode
4WR	100mm	6.4mm	23.8mm	1.22mm	5	0038548010045
5WR	125mm	6.4mm	29mm	1.20mm	5	0038548009049
7WR	175mm	8mm	38mm	2.31mm	5	0038548007045
10WR	250mm	9.5mm	47.6mm	6.50mm	5	0038548005041

Straight Jaw Locking Pliers

- Straight jaws provide maximum contact on flat, square or hex work
- Can also be used as a portable vice

Product Code	Size	Jaw Thickness	Jaw Adjustment	Shelf Pack	Barcode
7R	175mm	4.1mm	33mm	5	0038548003047
10R	250mm	15.9mm	44mm	5	0038548001043

Long Nose Locking Pliers with Wire Cutter

- Long straight nose provides easy access to narrow, hard-to-reach places
- Ideal for precision work and hobbies

Product Code	Size	Jaw Thickness	Jaw Adjustment	Cutting Capacity	Shelf Pack	Barcode
4LN	100mm	3.2mm	38mm	1.22mm	5	0038548016047
6LN	150mm	3.2mm	51mm	2.81mm	5	0038548014043
9LN	225mm	4.8mm	70mm	6.50mm	5	0038548015040



Large Jaw Locking Pliers

- Heavy-duty jaw grips around work of all shapes
- Useful for plumbers, mechanics, welders and anyone who works with large objects

Product Code	Size	Jaw Adjustment	Throat Depth	Shelf Pack	Barcode
12LC	300mm	0mm-79mm	80mm	5	0038548012018



Locking Wrenches with Wire Cutter

- Heavy duty jaws lock onto three sides of a hex fastener, and won't slip or mark
- Designed to replace up to 16 wrench sizes

Product Code	Size	Jaw Thickness	Cutting Capacity	Shelf Pack	Barcode
7LW	175mm	11mm-19mm	2.31mm	5	0038548014043



'The Original' Locking Pliers Sets

2pc 'The Original' Locking Pliers Set

Product Code	Description	Shelf Pack	Barcode
36V	2pc 'The Original' Pliers Set (7WR, 6LN)	5	0038548000367



3pc 'The Original' Locking Pliers Set with Wallet

Product Code	Description	Shelf Pack	Barcode
73	3pc 'The Original' Pliers Set (10WR, 6LN, 5CR)	5	0038548000732



4pc 'The Original' Locking Pliers Set with Kit Bag

Product Code	Description	Shelf Pack	Barcode
428GS	4pc 'The Original' Pliers Set w/ Kit Bag (10CR, 7R, 6LN, 5WR)	5	0038548000718



6pc 'The Original' Locking Pliers Set with Kit Bag

- Includes 6 Drink Holders

Product Code	Description	Shelf Pack	Barcode
641	6pc 'The Original' Pliers Set w/ Kit Bag (10WR, 4WR, 5CR, 9LN, 6LN, 7R)	5	0038548000718





Locking C-Clamps

Locking C-Clamps with Regular Tips

- Wide opening jaws provide greater versatility – can clamp wide variety of shapes

Product Code	Size	Jaw Adjustment	Throat Depth	Shelf Pack	Barcode
6R	150mm	0mm–54mm	35mm	5	0038548000176
11R	275mm	0mm–85mm	63mm	5	0038548000190
18R	455mm	0mm–203mm	241mm	5	0038548000213
24R	600mm	0mm–254mm	393mm	5	0038548002750



Locking C-Clamps with Swivel Pads

- Swivel pads hold tapered work, awkward fabricating jobs, and delicate projects without damaging the work surface

Product Code	Size	Jaw Adjustment	Throat Depth	Shelf Pack	Barcode
4SP	100mm	0mm–41mm	25mm	5	0038548001654
6SP	150mm	0mm–54mm	31mm	5	0038548000183
9SP	225mm	0mm–115mm	120mm	5	0038548003108
11SP	275mm	0mm–85mm	63mm	5	0038548000206
18SP	455mm	0mm–203mm	241mm	5	0038548000220
24SP	600mm	0mm–254mm	393mm	5	0038548000282



Locking C-Clamps (Large Throat)

- Ideal for welding and automotive applications

Product Code	Jaw Adjustment	Throat Depth	Shelf Pack	Barcode
18DR	0mm–190mm	240mm	5	0038548002118

Specialty Locking Tools

Locking Chain Clamp

- Holds and locks around any shape or size
- Adjusts quickly for ratchet action in either direction



Product Code	Size	Description	Shelf Pack	Barcode
20R	225mm	Clamp with 455mm Chain	10	0038548000275
20EXT	455mm	Extension Chain – 455mm	1	0038548000404
20REP	455mm	Replacement Chain	1	0038548001401

Locking Pinch-Off Tool

- Pinches off and locks on tubing instantly – ideal for emergencies
- Easy-release trigger
- Ideal for refrigeration industry



Product Code	Size	Jaw Thickness	Throat Depth	Shelf Pack	Barcode
RR	175mm	6.4mm	25mm	1	0038548000299

Locking Welding Clamp

- Holds work in proper alignment – even when material is not identical in thickness
- Positive lock leaves hands free
- Deep-throat U-Shaped jaws for visibility and working space



Product Code	Size	Jaw Thickness	Throat Depth	Shelf Pack	Barcode
9R	225mm	69mm	41mm	1	0038548000251



Locking Sheet Metal Tool

- Locks to work with powerful grip
- Makes bread pan corners and can crimp and double crimp
- Excellent for upholstery work, bending, forming and crimping sheet metal

Product Code	Size	Jaw Thickness	Throat Depth	Shelf Pack	Barcode
8R	200mm	79mm	44mm	1	0038548000237



Locking Panel Clamp

- Provides quick clamping and alignment of auto body panels - bottom jaw slides in a straight motion
- Easy release trigger

Product Code	Size	Jaw Adjustment	Shelf Pack	Barcode
9AC	225mm	10mm	1	0038548002514



PLIERS

Tongue & Groove Pliers



1. Press-N-Slide Button - adjusts jaw rapidly - 2X faster than traditional Tongue & Groove pliers
2. All Purpose Jaw - grips round, hex and square work pieces
3. Multi-Groove Ratcheting System - twice the groove positions of traditional Tongue & Groove pliers, allowing for precise positioning
4. Rapid Jaw Adjustment - ratcheting action allows fast adjustment up to the workpiece by simply sliding the handle
5. Anti-Pinch non-slip ProTouch™ grips for comfort and reduces hand fatigue



GrooveLock™ Pliers

Product Code	Jaw Type	Size	Shelf Pack	Barcode
2078108	All Purpose Jaw	200mm (8")	5	0038548028088
2078110	All Purpose Jaw	250mm (10")	5	0038548028095
2078112	All Purpose Jaw	300mm (12")	5	0038548028101
2078116*	All Purpose Jaw	400mm (16")	2	0038548088099
2078120*	All Purpose Jaw	500mm (20")	1	0038548088105
4935096	Straight Jaw	250mm (10")	5	0038548108612
4935098	Straight Jaw	300mm (12")	5	0038548108636

* Dipped Grips

Groove Joint Pliers

- Right angle teeth grip in all directions for maximum bite
- Available in ProTouch (150mm, 200mm, 250mm, 300mm) or dipped (400mm) grips for comfort



Product Code	Jaw Type	Size	Shelf Pack	Barcode
2078508	All purpose jaw	200mm (8")	5	0038548028255
2078510	All purpose jaw	250mm (10")	5	0038548028262
2078512	All purpose jaw	300mm (12")	5	0038548028279
2078516	All purpose jaw	400mm (16")	2	0038548088563
4935318	Straight jaw	150mm (6")	5	0038548111575
4935321	Straight jaw	250mm (10")	5	0038548111605



Pliers

Lineman's Pliers

- Induction hardened cutting edge stays sharper longer
- Machined jaws for maximum gripping strength
- High Leverage ProTouch™ grips provide maximum force to jaws with minimal effort

Product Code	Size	Shelf Pack	Barcode
2078208*	200mm (8")	5	0038548028125



Combination Pliers

- Induction hardened cutting edge stays sharper longer
- ProTouch™ grips provide extra comfort for reduced hand fatigue

Product Code	Size	Shelf Pack	Barcode
1771974*	170mm (7")	5	0038548991504
1771975*	200mm (8")	5	0038548991511



Diagonal Cutting Pliers

- Induction hardened cutting edge stays sharper longer
- ProTouch™ grips provide extra comfort for reduced hand fatigue

Product Code	Size	Shelf Pack	Barcode
2078306*	150mm (6")	5	0038548028187
2078307*	170mm (7")	5	0038548028194
2078308*	200mm (8")	5	0038548028200



End Cutting Pliers

- Wide throat clearance allows semi-flush cutting of nails and rivets
- Induction hardened cutting edge stays sharper longer
- ProTouch™ grips provide extra comfort for reduced hand fatigue

Product Code	Size	Shelf Pack	Barcode
2078318*	200mm (8")	5	0038548028217



Cable Cutting Pliers

- Cuts up to 3/0 AWG fine stranded copper battery cable
- Induction hardened cutting edge stays sharper longer
- ProTouch™ grips provide extra comfort for reduced hand fatigue

Product Code	Size	Shelf Pack	Barcode
2078328*	200mm (8")	5	0038548028224



Long Nose Pliers

- Induction hardened cutting edge stays sharper longer
- Machined jaws for maximum gripping strength
- ProTouch™ grips provide extra comfort for reduced hand fatigue

Product Code	Size	Shelf Pack	Barcode
2078216*	150mm (6")	5	0038548028149
2078218*	200mm (8")	5	0038548028156



*Products are TÜV/GS certified for optimal safety and user confidence



Pliers (continued)

Bent Nose Pliers

- Thin profile nose gets into tight spaces, easy to reach around obstructions
- Induction hardened cutting edge stays sharper longer
- ProTouch™ grips provide extra comfort for reduced hand fatigue



Product Code	Size	Shelf Pack	Barcode
2078226*	150mm (6")	5	0038548028163
2078228*	200mm (8")	5	0038548028170

Concrete Nippers

- Induction hardened cutting edge stays sharper longer
- Precision matched jaws provide clean cut
- ProTouch™ grips provide extra comfort for reduced hand fatigue



Product Code	Size	Shelf Pack	Barcode
2078910	250mm (10")	5	00385480408163

Pliers Sets

5pc Pliers Set

Product Code	Content	Shelf Pack	Barcode
2078708	150mm Diagonal Cutting Pliers, 150mm Slip Joint Pliers, 200mm Lineman's Pliers, 250mm Adjustable Wrench, 250mm Groove Joint Pliers	2	0038548040806



Specialty Pliers

Fencing Pliers

- The only tool needed to work on metal and wood posts
- Nickel chromium steel construction for overall strength and durability
- ProTouch™ grips provide extra comfort for reduced hand fatigue



Product Code	Size	Shelf Pack	Barcode
2078901	260mm (10 1/2")	5	0038548088686

Circlip Pliers

- For internal or external use - simple adjustment converts head from internal to external snap ring pliers
- 4 interchangeable tips - 45°, 90°, 180°
- Coiled spring for positive jaw opening
- ProTouch™ grips provide extra comfort for reduced hand fatigue



Product Code	Size	Shelf Pack	Barcode
2078900	165mm (6 1/2")	5	0038548088679



*Products are TÜV/GS certified for optimal safety and user confidence



Self Adjusting Wire Stripper

- Strips wire from 10-24 AWG
- Adjustable stopper controls the length of the core strip
- Swivel knob micro-adjusts for gauges smaller than 20 AWG
- Wire cutter
- Wire crimper crimps 10-22 AWG insulated and non-insulated and 7-9mm ignition terminals

Product Code	Size	Shelf Pack	Barcode
2078300	200mm (8")	5	0038548088457



Wire Stripper/Cutter

- Dipped grips for added comfort
- Suitable for stripping 10-20 AWG wires
- Selected dial adjusts for varying sizes

Product Code	Size	Shelf Pack	Barcode
2078305	125mm (5")	5	0385480886464



Multi-Tool Stripper/Cutter/Crimper

- Induction hardened cutting edge stays sharper longer
- Strips and cuts 10-22 AWG
- Pliers style nose allows pulling and looping in wire
- Screw cutter cuts screws to size and leaves perfect lead thread
- Wire crimper crimps insulated and non-insulated terminals
- ProTouch™ grips provide maximum comfort and reduced hand fatigue

Product Code	Size	Shelf Pack	Barcode
2078309	215mm (8 1/2")	5	0038548088495





1000V Insulated Pliers

IRWIN VISE-GRIP® Insulated Pliers are fully TÜV/GS & VDE certified, meaning they are guaranteed safe for working with live electrical equipment up to AC 1000V or DV 1500V.

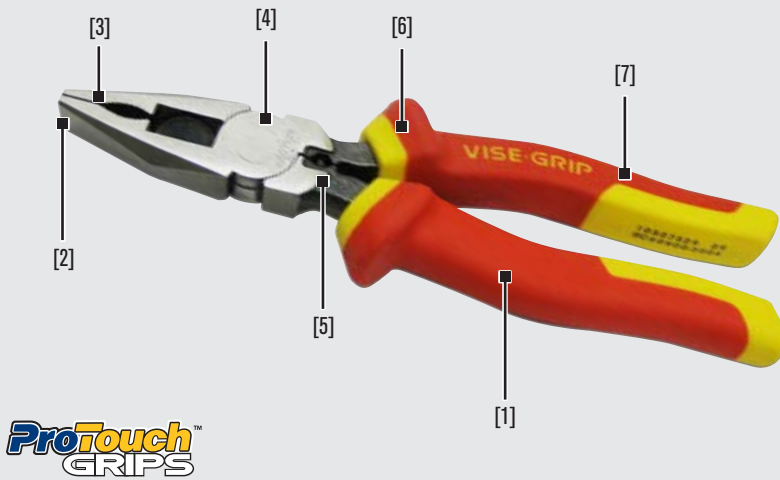

1. 1000V Insulated handle with triple layer protection for greater safety
2. Jaw Gap for stripping and twisting without damaging the copper threads/wire
3. Cross hatched jaws for maximum gripping strength
4. Nickel chromium steel with induction hardened cutting edges that stay sharper longer
5. Crimping tool suitable to crimp wire terminals and non-insulated connectors
6. Large handle shoulders to prevent user contact with the non-insulated area of the pliers
7. ProTouch grips - moulded handles for comfort and less hand fatigue



Insulated Lineman's Pliers

Product Code	Size	Shelf Pack	Barcode
10507529NA*	215mm (8 1/2")	5	0038548104089

Insulated Combination Pliers

- Strong gripping teeth
- Induction hardened cutting edge stays sharper longer
- Slim profile nose

Product Code	Size	Shelf Pack	Barcode
10505873NA*	170mm (7")	5	0038548102238

Insulated Diagonal Cutting Pliers

- Induction hardened cutting edge stays sharper longer

Product Code	Size	Shelf Pack	Barcode
10505866NA*	170mm (7")	5	0038548102108
10505867NA*	200mm (8")	5	0038548102139

Insulated Long Nose Pliers

- Induction hardened cutting edge stays sharper longer
- Slim profile nose

Product Code	Size	Shelf Pack	Barcode
10505868NA*	150mm (6")	5	0038548102160
10505869NA*	200mm (8")	5	0038548102177



*Products are TÜV/GS certified for optimal safety and user confidence



Insulated Bent Nose Pliers

- Strong gripping teeth
- Induction hardened cutting edge stays sharper longer
- Slim profile nose to reach tight spaces and around obstructions

Product Code	Size	Shelf Pack	Barcode
10505870NA*	200mm (8")	5	0038548102184



Insulated Wire Strippers

- Large handle shoulders prevent contact with the non-insulated area of the pliers

Product Code	Size	Shelf Pack	Barcode
10505871NA*	150mm (6")	5	0038548102191



3pc 1000V Insulated Pliers Set

Product Code	Contents	Shelf Pack	Barcode
10505519NA	150mm Diagonal Cutting Pliers, 200mm Long Nose Pliers, 170mm Combination Pliers	5	0038548102290



*Products are TÜV/GS certified for optimal safety and user confidence



IRWIN®

WISE-GRIP®





WRENCHES

Pipe Wrenches

1. Quick adjusting jaw for one-handed operation, speed and convenience of use - 3X Faster than traditional pipe wrenches
2. Cast aluminium construction - 40% lighter than standard pipe wrenches
3. Heat-treated steel body and forged upper jaw for strength and durability
4. Ideal for pipe diameters of up to 38mm (1-1/2")
5. Ideal for most surfaces including black, galvanised PVC and copper pipe
6. Ergonomic handle ideal for heavy torque and comfort



Quick Adjusting Pipe Wrench

Product Code	Size	Pipe Capacity	Shelf Pack	Barcode
274001	275mm	38.1mm	1	0038548016290

Cast Aluminium Pipe Wrenches

- Cast aluminium pipe wrenches are 40% lighter than equivalent cast iron pipe wrenches and are easier to manoeuvre
- Drop forged jaw is heat-treated to resist distortion or breakage
- Hardened teeth provide excellent bite
- Easy spin adjusting nut is heat-treated for durability
- I-Beam handle design provides better weight distribution



Product Code	Size	Pipe Capacity	Shelf Pack	Barcode
2074110	250mm (10")	38.1mm	5	0038548064932
2074112	300mm (12")	50.8mm	5	0038548064949
2074114	350mm (14")	50.8mm	5	0038548064956
2074118	455mm (18")	63.5mm	5	0038548064963
2074124	610mm (24")	76.2mm	1	0038548064970
2074136	910mm (36")	127mm	1	0038548064987
2074148	1220mm (48")	152.4mm	1	0038548064994



Pipe Wrenches (continued)

Cast Iron Pipe Wrenches

- Heavy-duty cast iron housing
- Drop forged jaw is heat treated to resist distortion or breakage
- Hardened teeth provide excellent bite
- I-Beam handle design provides better weight distribution

Product Code	Size	Pipe Capacity	Shelf Pack	Barcode
274105	200mm (8")	25.4mm	5	0038548020082
274101	250mm (10")	38.1mm	5	0038548019703
274106	300mm (12")	50.8mm	5	0038548020099
274102	350mm (14")	50.8mm	5	0038548019710
274103	455mm (18")	63.5mm	5	0038548019727
274104	610mm (24")	76.2mm	1	0038548019734
274107	910mm (36")	127mm	1	0038548020105
274108	1220mm (48")	152.4mm	1	0038548020112



Stillson Pipe Wrenches

- Drop forged handle and jaw
- Cast SG ductile iron frame
- Hardened and tempered jaw teeth and adjusting nut
- Conforms to British Standard BS3594 Part 1

Product Code	Size	Pipe Capacity	Shelf Pack	Barcode
300/10	250mm (10")	34mm	4	0734442111368
300/12	300mm (12")	42mm	4	0734442111603
300/18	455mm (18")	60mm	4	0734442111962
300/24	610mm (24")	76mm	1	0734442112082
300/36	910mm (36")	102mm	1	0734442112204



Chain Wrenches

Chain Pipe Wrenches

- For use in confined spaces
- Hardened and tempered drop forged jaws
- Worn jaws may be reversed – doubles tool life
- 233C, 234C & 235C feature tubular steel handles attached to solid ductile iron castings for strength and durability
- 232 1/2 feature drop forged steel handles

Product Code	Overall Length	Pipe Capacity	Proof Torque	Safe Load	Shelf Pack	Barcode
232-1/2	546mm	90mm	678 N.m.	135kg	1	0734442109204
233C	930mm	115mm	1580 N.m.	180kg	1	0734442113164
234C	1295mm	220mm	2260 N.m.	180kg	1	0734442113287
235C	1638mm	330mm	2825 N.m.	180kg	1	0734442114000

PIPE TOOLS

Pipe Cutters

Roller Pipe Cutters

- SG ductile iron body for durability
- Hardened and tempered machined wheel from solid steel
- Best for cutting steel pipe
- One fast cutting wheel and two wide rollers
- Rollers keep cutter square and smooth burrs ready for jointing or threading

Product Code	Pipe Capacity	Weight	Shelf Pack	Barcode
202	10mm-60mm	3.2kg	1	0734442115564

Tube Cutters

- Steel wheels and rollers in precision die-cast bodies
- Designed to cut copper, brass, aluminium or thin wall steel
- 200-30C features a de-burrer which folds into the body when not in use
- 200-45 also cuts plastic pipe

Product Code	Description	Pipe Capacity	Shelf Pack	Barcode
200-30C	Tube Cutter	3mm-30mm	4	0734442118084
200-45	Tube Cutter	15mm-45mm	4	0734442118183
200-30C-D	Replacement cutting wheel for 200-30C	-	1	0734442117964
200-45-D	Replacement cutting wheel for 200-45	-	1	0734442132004

IRWIN
Record®



Pipe Benders

Mini Bender

- Calibrated for 90° and return bends
- For small bore tubing
- Lightweight yet strong precision die-casting
- Integral formers and guides
- Can bend three sizes of copper, brass, aluminium or steel tube

Product Code	Pipe Capacity	Shelf Pack	Barcode
210	3mm, 4mm, 6mm	4	0734442144052

Multi Mini Bender

- Calibrated for left hand, right hand and offset bends
- For small bore tubing
- Lightweight yet strong precision die-casting
- Integral formers and guides
- Can bend three sizes of copper, brass, aluminium or steel tube

Product Code	Pipe Capacity	Shelf Pack	Barcode
676810	6mm, 8mm, 10mm	8	068618200061

IRWIN
hilmar®



IRWIN®

Bolt Cutters, Snips & Riveters



IRWIN TOOLS

Customer Service: 1800 331 491

Choosing the Right Bolt Cutter

Cutting Material Tensile Rating

High tensile material
up to 1729N/mm

- Concrete-reinforced rod and mesh
- Reinforced wire
- High tensile steel rod and bar
- Case hardened chain
- Cool drawn alloy steel
- Tempered spring wire

Medium tensile material
up to 1235N/mm

- Non-ferrous bolts, rod and bar
- Medium tensile annealed tool steel rod and bar
- Medium tensile and mild steel bolts
- Medium tensile and mild steel rod and bar
- Medium tensile single strand wire

Low tensile material
up to 695N/mm

- Non-ferrous bolts, rod and bar
- Annealed tool steel rod and bar
- Mild steel bolts, rod and bar
- Low tensile single strand wire

Bolt Cutter Selection Chart

Product Code	Tensile Rating	Material Diameter											Approx Weight	Cut Type	Adjustment	
		4	5	6	8	10	11	13	14	16						
BC914H	High	■												1.1kg	Centre	Cam
BC918H	High	■	■											1.5kg	Centre	Cam
BC924H	High	■	■	■										2.7kg	Centre	Cam
BC930H	High	■	■	■	■									4.8kg	Centre	Cam
BC936H	High	■	■	■	■	■								6.7kg	Centre	Cam
930H	High	■	■	■	■	■	■							4.9kg	Centre	Arm
936H	High	■	■	■	■	■	■	■						6.9kg	Centre	Arm
942H	High	■	■	■	■	■	■	■	■					9.5kg	Centre	Arm
909	Medium	■												0.3kg	Centre	Handle Locking Screw
TBC914	Low	■	■	■										1.1kg	Centre	Cam
TBC918	Low	■	■	■	■									1.6kg	Centre	Cam
TBC924	Low	■	■	■	■	■								2.7kg	Centre	Cam
TBC930	Low	■	■	■	■	■	■	■						4.3kg	Centre	Cam
TBC936	Low	■	■	■	■	■	■	■	■					5.9kg	Centre	Cam
BC924E	Low	■	■	■	■	■	■							2.5kg	End	Cam

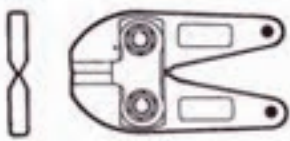

Centre Cut Head



Clipper Cut Head

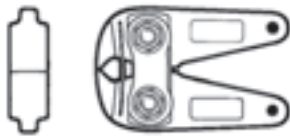

End Cut Head

Cam Adjusted Jaw Bolt Cutters

Lightweight and easy to adjust. Ideal for day-to-day use.

How to adjust the cam:

1. Loosen the locking nuts and tap through to release the cam bolt head.
2. Turn the cam bolts clockwise to close the jaws, or anti-clockwise to open.
3. When the jaws are adjusted, tap the cam bolt head into its recess and re-tighten the locking nuts.

Arm Adjusted Jaw Bolt Cutters

Wide range of easily changeable adjustments. Best suited to continuous use.

How to adjust the arm:

1. Loosen the handle adjusting nuts.
2. Turn the arm adjusting bolt to align the cutting edges.
3. Re-tighten the handle adjusting nuts.

BOLT CUTTERS

Bolt Cutters

1. Two-stage heat treated and ground jaws for extended cutting and resilience
2. High-tensile drop forged steel jaws for durability under extreme conditions
3. Drop forged steel handles for safety and reliability
4. Centre cut for general purpose use

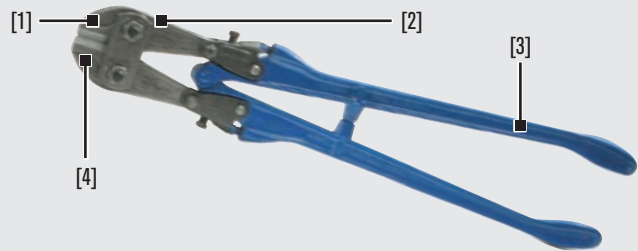

Heavy Duty Arm Adjusted Solid Handles

- Optimal performance for cutting high tensile material
- Suitable for continuous use in engineering workshops, building sites and concreting sites

Product Code	Length	Adjustment	Weight	Shelf Pack	Barcode
930H	760mm	Arm	4.9kg	1	0734442092643
936H	915mm	Arm	6.9kg	1	0734442092766
942H	1070mm	Arm	9.5kg	1	0734442092889

Cam Adjusted Solid Handles

- Cam adjustments for quick jaw alignment
- Optimal performance for cutting high tensile material
- Suitable for regular use on farms, garages or small workshops

Product Code	Length	Adjustment	Weight	Shelf Pack	Barcode
BC914H	355mm	Cam	1.1kg	1	0734442090847
BC918H	460mm	Cam	1.5kg	1	0734442092407
BC924H	610mm	Cam	2.7kg	1	0734442092520
BC930H	760mm	Cam	4.8kg	1	0734442092667
BC936H	915mm	Cam	6.1kg	1	0734442092780



Cam Adjusted Tubular Handles

- Cam adjustments for quick jaw alignment
- Optimal performance for cutting low tensile material
- Suitable for use on farms, garages or small workshops

Product Code	Length	Adjustment	Weight	Shelf Pack	Barcode
TBC914	355mm	Cam	1.1kg	1	0734442089834
TBC918	460mm	Cam	1.6kg	1	0734442089841
TBC924	610mm	Cam	2.7kg	1	0734442089858
TBC930	760mm	Cam	4.3kg	1	0734442089896
TBC936	915mm	Cam	5.9kg	1	0734442089902



Bolt Cutters (continued)

End Cut Solid Handles



- Close cutting end cut
- Optimal performance for cutting low tensile material
- Drop forged steel handles and jaws for durability

Product Code	Length	Adjustment	Weight	Shelf Pack	Barcode
BC924E	610mm	Cam	2.5kg	1	0734442093008

Medium Duty



- Drop forged steel jaws chemically blackened for rust protection
- Double fulcrum cutting action
- Pressed steel handles spring loaded for ease of use
- Capacity 4mm soft steel wire and 1.5mm hard steel wire
- Optimal performance for cutting medium tensile material

Product Code	Length	Weight	Shelf Pack	Barcode
909	228mm	0.8kg	1	0734442090601

SNIPS

Snips

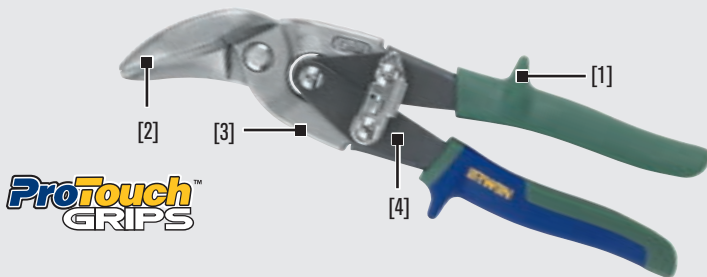

1. ProTouch™ overmoulded, non-slip grips provide superior comfort and resist twisting
2. Hot drop-forged, chrome molybdenum steel blades for strength and durability
3. Compound leverage for faster and easier cutting
4. Easy push-up safety latch for one-handed operation

Offset Snips

- For straight or curved cuts. Keeps hands safely above the work surface

Product Code	Size	Length of Cut	Cutting Pattern	Cutting Capacity		Shelf Pack	Barcode
				Cold Rolled Steel	Stainless Steel		
2073211	225mm	33mm	Straight & Angles or Left Curves	18 gauge	23 gauge	5	0038548089089
2073212	225mm	33mm	Straight & Angles or Right Curves	18 gauge	23 gauge	5	0038548089096

Bulldog Snips

- Short blades designed for more power when notching and trimming thicker material



Product Code	Size	Length of Cut	Cutting Pattern	Cutting Capacity		Shelf Pack	Barcode
				Cold Rolled Steel	Stainless Steel		
2073115	225mm	19mm	Straight & Angles	16 gauge	18 gauge	5	0038548089072

Aviation Snips

- Serrated blade grips material for a smoother cut on thin material. Ideal for heating, air conditioning, gutter work and general industrial use.

Product Code	Size	Length of Cut	Cutting Pattern	Cutting Capacity		Shelf Pack	Barcode
				Cold Rolled Steel	Stainless Steel		
2073111	250mm	33mm	Left Straight Cut	18 gauge	23 gauge	5	0038548089041
2073112	250mm	33mm	Right Straight Cut	18 gauge	23 gauge	5	0038548089058
2073113	250mm	33mm	Straight Cut	18 gauge	23 gauge	5	0038548089065



Extra Cut Snips

- Cuts sheet metal, plastic, rubber, canvas, cardboard, carpet, metal strap, vinyl flooring, gutters and much more
- Compound leverage design provides cuts up to 80mm

Product Code	Size	Length of Cut	Cutting Pattern	Cutting Capacity		Shelf Pack	Barcode
				Cold Rolled Steel	Stainless Steel		
21304	300mm	80mm	Straight & Curves	24 gauge	26 gauge	5	0038548213040



Snips & Shears

1. Safety stop prevents trapped fingers
2. Drop forged carbon steel handles and blades
3. Double hollow ground blades reduce friction for easier cutting
4. Unique non-slip joint set and tested for a perfect cut (should only be readjusted after sharpening)

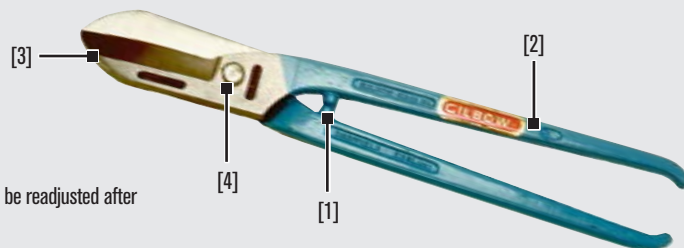

General Purpose Snips

- Hardened, tempered, ground, glazed, assembled and tested

Product Code	Size	Cutting Pattern	Cutting Capacity		Shelf Pack	Barcode
			Cold Rolled Steel	Stainless Steel		
G245/8	200mm	Straight	18 gauge	23 gauge	6	0734442188049
G245/10	250mm	Straight	18 gauge	23 gauge	6	0734442188162
G245/12	300mm	Straight	18 gauge	23 gauge	6	0734442188285
G245/14	350mm	Straight	16 gauge	18 gauge	6	0734442188407

IRWIN
GILBOW

Curved Blade Snips

- Drop forged from carbon tool steel
- Hardened, tempered, ground, glazed, assembled and tested

Product Code	Size	Cutting Pattern	Cutting Capacity		Shelf Pack	Barcode
			Cold Rolled Steel	Stainless Steel		
G246/8	200mm	Curved	18 gauge	23 gauge	6	0734442189008
G246/10	250mm	Curved	18 gauge	23 gauge	6	0734442189121
G246/12	300mm	Curved	18 gauge	23 gauge	6	0734442189244



Snips & Shears (continued)

Jeweller's Shears

- Short bladed light duty snips used by jewellers, silversmiths and model makers



Product Code	Size	Cutting Pattern	Cutting Capacity		Shelf Pack	Barcode
			Cold Rolled Steel	Stainless Steel		
G56	175mm	Straight	18 gauge	23 gauge	6	0734442190202
G056	175mm	Curved	18 gauge	23 gauge	6	0734442187929

Medium Duty Straight Handle Shears

- Used for straight cutting



Product Code	Size	Cutting Pattern	Cutting Capacity		Shelf Pack	Barcode
			Cold Rolled Steel	Stainless Steel		
G950	300mm	Straight	16 gauge	18 gauge	6	0734442189725

Heavy Duty Cranked Handle Shears

- These cranked-handled shears can be used for straight cutting
- G69 and G691 are right-hand cranked for working anticlockwise
- G67 is left-hand cranked for working clockwise



Product Code	Size	Cutting Pattern	Cutting Capacity		Shelf Pack	Barcode
			Cold Rolled Steel	Stainless Steel		
G69	275mm	Right Hand	16 gauge	18 gauge	3	0734442189480
G691	350mm	Right Hand	16 gauge	18 gauge	3	0734442189602
G67	275mm	Left Hand	16 gauge	18 gauge	3	0734442189367

RIVETERS

Hand Riveters

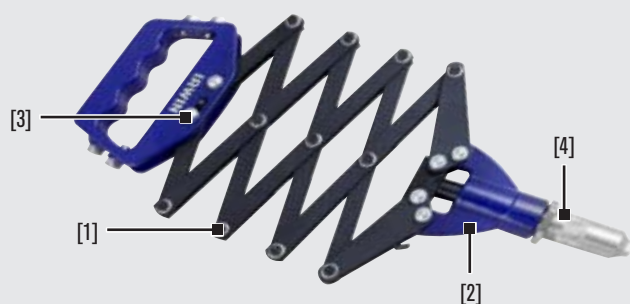

1. Accordion type riveter used primarily for joining two or more materials with rivets, can be used with steel rivets, aluminium or mixed
2. Strong and compact body, manufactured with high strength aluminium alloy
3. Dedicated security lock: prevents accidents
4. Adjustable head height adjustment allows for application of longer rivets

Product Code	Description	Overall Length	Nozzle Sizes	Shelf Pack	Barcode
1887144	Pantograph Hand Riveter	810mm	2.4 mm (3/32"), 3.2 mm (1/8"), 4.0 mm (5/32"), 4.8 mm (3/16"), 6.4 mm (1/4")	5	0038548089089

IRWIN®

Tool Storage & Workwear



IRWIN TOOLS

Customer Service: 1800 331 491

Material Overview

IRWIN® is focused on developing products that exceed the demanding needs of the tradesman. Working directly with professionals of all trades helps IRWIN® to identify and develop products of superior quality and performance. The worksite products line is just another way for IRWIN® to continue to deliver this promise.

	Oil Tanned Leather	Full Grain Leather	Suede Leather	Split Leather	Saddle Leather	Ballistic 1680 Denier Nylon	1680 Denier Nylon	600 Denier Nylon	Cotton
All weather use	●					●	●	●	
Reinforced points of wear	●	●	●	●	●	●	●	●	●
Heavy duty	●	●			●	●			
Resists tears and punctures	●	●	●		●	●	●		
Lightweight	●		●	●		●	●	●	●
Soft body conforming material	●	●	●	●		●	●	●	●
Resists moisture absorption	●					●	●	●	
Cool material for warm weather	●					●	●	●	●

Ballistic 1680 Denier Nylon

- Heavy duty 1680 denier industrial strength woven nylon for trade professionals
- Superior strength and durability
- Extremely high resistance to wear and tear
- Soft body conforming material
- Resists moisture absorption

BALLISTIC
NYLON

1680 Denier Polyester

- Premium grade polyester for heavy duty applications
- Proven for its strength, durability and wear and tear
- Resists moisture absorption

600 Denier Polyester

- Proven performance for light to medium duty applications
- Superior flexibility
- Resists moisture absorption

Cotton Fabrics

- Light trade and DIY use
- Stays cool in warm conditions
- Lightweight, soft material

Saddle Leather

- Heavy trade application for tool specific products
- Stiff top grain leather purpose moulded for tool holders
- High resistance to wear and tear
- Natural vegetable tanned leather

Split Leather

- Suitable for the handyman and DIY use
- Lighter duty sueded split leather
- Soft material, conforms to body

Full Grain Leather

- Proven performance for heavy duty trade applications
- Provides superior strength and durability
- Buffed on the grain side so it is soft and supple

Oil Tanned Split Leather

- Premium light duty sueded split leather trade specific products
- Treated with a special blend of oils and waxes to last longer in all weather conditions
- High resistance to wear and tear

Oil Tanned Full Grain Leather

- Premium full grain cowhide leather for trade specific products
- Treated with a special blend of oils and waxes to last longer in all weather conditions
- High resistance to cracking, tearing and punctures

Suede Leather

- Proven performance for light to medium duty applications
- Soft and flexible suede leather offers high performance at excellent value
- Resists cracking, tears and punctures

Note: Material colours may vary

SYNTHETIC WORKWEAR & TOOL STORAGE

Totes & Bags

1. Constructed from strong and lightweight 1680 and 600 denier polyester for durability
2. Two movable dividers for tool separation and organisation
3. Lid designed for secure and quick tool access
4. Four internal pockets and eight tool holders for safe tool storage
5. Two exterior side pockets, six tool loops and front level holding straps
6. Moulded waterproof base resistant to cracking
7. Reinforced double-wall rigid construction



Ultra Tool Bag

Product Code	Dimensions (mm) l x w x h	Shelf Pack	Barcode
9098074	600 x 280 x 300	1	931424402232

Mega Bag

- Constructed from high density 1680 denier polyester material for strength and durability with additional 600 denier polyester material for low wear areas
- Eight exterior pockets including a front cargo pocket for safe storage
- Eleven internal pockets including a cargo pocket for safe storage
- Moulded waterproof rubber base with four heavy duty rubber feet for maximum durability
- Reinforced double wall constructed for all-weather use and reflective trim for low-visibility situations

Product Code	Dimensions (mm) l x w x h	Shelf Pack	Barcode
IR-22920	500 x 254 x 290	3	9314244010970



400mm Builder's Tool Bag

- Constructed from lightweight 600 denier polyester material for durability and comfort
- Twelve interior vertical tool storage pockets, two large front exterior cargo pockets for extra storage and six back pockets including three mesh pockets for quick tool recognition
- Semi-double wall constructed for all-weather use

Product Code	Dimensions (mm) l x w x h	Shelf Pack	Barcode
IR-103-16	400 x 290 x 296	12	0019374965013



Totes & Bags (continued)



300mm Builder's Tool Bag

- Constructed from lightweight 600 denier polyester material for durability and comfort
- Six interior vertical tool storage pockets, a large exterior cargo pocket for safe storage of small items and six back pockets including three mesh pockets for quick tool recognition
- Semi-double wall constructed for all-weather use

Product Code	Dimensions (mm) l x w x h	Shelf Pack	Barcode
IR-103-12	300 x 214 x 236	12	0019374965020



Tool Centre Tote

- Constructed from lightweight 600 denier polyester material for durability and comfort
- Rigid frame design keeps tote upright with heavy duty waterproof rubber tread base for maximum durability
- Fourteen interior pockets plus multiple webbed tool tunnels for vertical tool storage
- Front and back panels zip down for full access

Product Code	Dimensions (mm) l x w x h	Shelf Pack	Barcode
IR-A22394	470 x 210 x 330	2	0019374965899



Bigfoot Tool Bag

- Constructed from lightweight 600 denier polyester material for durability and comfort
- Six exterior pockets and ten interior pockets for safe storage of small items
- Heavy duty waterproof rubber base for maximum durability
- Double wall constructed for all-weather use

Product Code	Dimensions (mm) l x w x h	Shelf Pack	Barcode
R-22516	400 x 236 x 330	6	0023437375169



600mm Builder's Tool Bag

- Constructed from lightweight 600 denier polyester material for durability and comfort
- Ideal for storing long tools and other large items
- Nineteen external pockets, including three cargo pockets for safe storage
- Eight interior pockets, six webbed loops and three tool tunnels for vertical storage
- Double wall constructed for all-weather use

Product Code	Dimensions (mm) l x w x h	Shelf Pack	Barcode
IR-0352	600 x 280 x 308	6	001937496875



Electrician's Tote

- Constructed from lightweight 600 denier polyester material for durability and comfort
- Twelve exterior pockets, including two cargo pockets and a zippered pocket for safe tool storage
- Internal webbed tool tunnels and dividers for tool separation
- Includes electrical tape loop and snap hook to hold key chains

Product Code	Dimensions (mm) l x w x h	Shelf Pack	Barcode
R-22128	212 x 210 x 407	4	0019374948245

Tool Tote

- Constructed from lightweight 600 denier polyester material for durability and comfort
- Large storage capacity with a wide open tote design for quick tool recognition and easy access
- Eight exterior pockets, tape loop and a metal tape measure holder
- Interior webbed loops and side pockets for vertical storage

Product Code	Dimensions (mm) l x w x h	Shelf Pack	Barcode
R-22217	420 x 200 x 255	2	0193749462649



Compact Utility Tote

- Constructed from lightweight 600 denier polyester material for durability and comfort
- Fourteen exterior pockets, including two cargo pockets and a large zippered pocket for safe tool storage
- Open profile design for easy tool access with internal webbed tool tunnels and dividers for tool separation and organisation
- Rotating, neoprene padded handle to allow for full access to main compartment

Product Code	Dimensions (mm) l x w x h	Shelf Pack	Barcode
IR-22225	355 x 213 x 390	6	001937494986



54 Pocket Builder's Bucket Pro

- Constructed from lightweight 600 denier polyester material for durability and comfort
- Exterior tapered tool tunnels for quick access to tools
- Multiple interior and exterior pockets for vertical tool storage
- Fits most 20 litre buckets

Product Code	Dimensions (mm) l x w x h	Shelf Pack	Barcode
R-22054	290 x 290 x 340	12	0019374949549



Rigs, Aprons, Pouches & Accessories

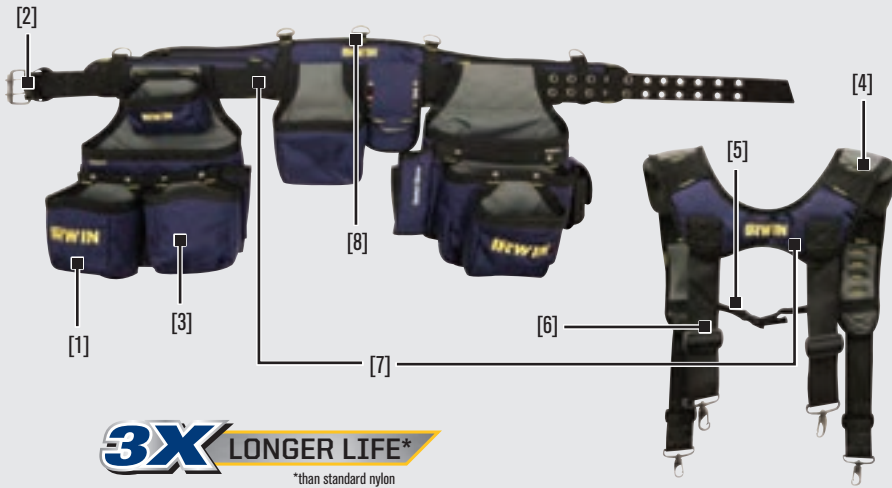

1. Constructed from superior strength 1680 denier Ballistic Nylon for up to 3X greater life than standard nylon
2. Double tongue roller buckle, fits up to a 1270mm waist
3. Multiple pockets and loops for maximum tool and fastener storage options
4. Gel padded shoulder straps also feature moisture wicking mesh for maximum breathability
5. Chest belt enables even weight distribution
6. Fully adjustable suspenders (suspenders not sold separately)
7. Maximum breathability with moisture-wicking mesh on belt and suspenders
8. Hook and loop backing and tunnel loop tops allow for easy repositioning and individual customisation

BALLISTIC
NYLON

Ballistic Nylon Rig with Suspenders

Product Code	Dimensions (mm) l x w x h	Shelf Pack	Barcode
IR-30297	1440 x 178 x 368	3	9314244011021

Heavy Duty Tool Rig

- Constructed from high density 1680 denier polyester material for strength and durability with additional 600 denier polyester material for low wear areas
- Extra-large capacity pouches, assorted pockets and loops for speciality tools
- Metal hammer holder and Monsterhook™
- Tunnel loop back pouches allow for easy repositioning and individual customisation
- Padded belt with double tongue roller buckle and mesh liner for comfortable wear
- D-ring attachments for both three or four point suspenders (suspenders not included)
- Double wall construction for all-weather use

Product Code	Dimensions (mm) l x w x h	Shelf Pack	Barcode
IR-889-SYN	1440 x 127 x 349	5	9314244011052

Universal Pouch

- Constructed from lightweight 600 denier polyester material for durability and comfort
- Multiple pockets for small hand tool storage including small front pockets for pencil or flashlight storage
- Webbed front loop for securing tape measure or other long items
- Dual attachment system with durable metal clip and webbing tunnel loop for secure attachment to belt or pants

Product Code	Dimensions (mm) l x w x h	Shelf Pack	Barcode
IR-804	127 x 64 x 248	15	9314244011137

Warning: Rigs are not designed to be used as safety harnesses

6 Pocket Electrician's Pouch

- Constructed from lightweight 600 denier polyester material for durability and comfort
- Multiple pockets to keep tools organised, an electrical tape loop, a hammer loop and an open-ended tool holder
- Stitched and rivet reinforced for added strength

Product Code	Dimensions (mm) l x w x h	Shelf Pack	Barcode
R-72500	248 x 95 x 267	2	0019374949587



Utility Pouch

- Constructed from lightweight 600 denier polyester material for durability and comfort
- Dual attachment system with durable metal clip and webbing tunnel loop for secure attachment to belt or pants
- Magnetic expansion pocket with stay open feature for easy access

Product Code	Dimensions (mm) l x w x h	Shelf Pack	Barcode
IR-680	184 x 64 x 260	2	0019374964757



Tape Measure Holder

- Constructed from lightweight 600 denier polyester material for durability and comfort
- Secures most standard tape measures
- Flip down strap design with easy one handed push up release
- Wide tunnel belt loop

Product Code	Dimensions (mm) l x w x h	Shelf Pack	Barcode
R-72464	114 x 76 x 280	6	0019374949617



Hammer Holder

- Constructed from lightweight 600 denier polyester material for durability and comfort
- Additional padding to protect leg
- Rust resistant plated steel cradle loop holds hammer securely
- Wide tunnel belt loop

Product Code	Dimensions (mm) l x w x h	Shelf Pack	Barcode
R-72439	89 x 89 x 178	12	0019374949600



PDA/Mobile Phone Holder

- Constructed from lightweight 600 denier polyester material for durability and comfort
- Neoprene phone holder adjusts to hold most mobile phones and small cameras
- Zippered compartment holds PDA or MP3 player with headphone jack access
- Dual attachment system with durable metal clip and tunnel loop for secure attachment to belt or pants
- Internal pockets to suit business cards, ID cards, credit cards, etc.

Product Code	Dimensions (mm) l x w x h	Shelf Pack	Barcode
IR-31519	102 x 51 x 210	24	0019374965051



Drill Holder

- Constructed from lightweight 600 denier polyester material for durability and comfort
- Three drill bit pockets and a wide tunnel belt loop
- 45° centre balance design

Product Code	Dimensions (mm) l x w x h	Shelf Pack	Barcode
R-72731T	737 x 89 x 280	2	0019374949563



Note: Tools not included

Rigs, Aprons, Pouches & Accessories (continued)

Smart Phone/Mobile Phone Holder



- Constructed from lightweight 600 denier polyester material with soft interior lining to protect phone
- Steel clip and web belt loop
- Hook and loop flap keeps phone in place

Product Code	Dimensions (mm) l x w x h	Shelf Pack	Barcode
R-72416	38 x 69 x 106	6	0019374948122

LEATHER WORKWEAR

Leather Aprons

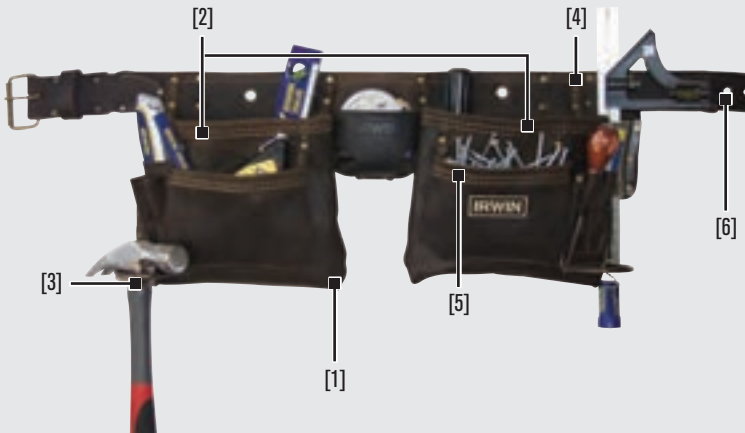

1. Constructed from premium full grain cowhide leather and treated with a special blend of oils and waxes to last longer in all weather conditions
2. Two large capacity pouches, two front pockets and six small pockets for speciality tools
3. Two metal hammer holders, a leather tape measure holder and a steel utility tool holder
4. Rivet reinforced at high stress points
5. Double stitched main pockets for extra strength
6. Leather belt with a single tongue roller buckle

10 Pocket Oil Tanned Leather Tool Apron

Product Code	Dimensions (mm) l x w x h	Shelf Pack	Barcode
CC-747-603	508 x 64 x 267	6	0019374107475

10 Pocket Full Grain Leather Tool Apron

- Constructed from premium full grain leather
- Two large capacity pouches, two front pockets and six small pockets for speciality tools
- Two metal hammer holders, a leather tape measure holder and an open-ended tool holder
- Rivet reinforced at high stress points
- Double stitched main pockets for extra strength
- Adjustable cotton web belt with a single tongue metal roller buckle

Product Code	Dimensions (mm) l x w x h	Shelf Pack	Barcode
R-427-621	495 x 64 x 254	6	0019374702472



Oil Tanned Split Leather Tool Apron

- Constructed from tough, lightweight split leather
- Treated with a special blend of oils and waxes to last longer in all weather conditions
- Two large capacity pouches, two front pockets, six small pockets for speciality tools and a separate single pouch
- Two metal hammer holders and an open-ended tool holder
- Rivet reinforced at high stress points
- Double stitched main pockets for extra strength
- Adjustable nylon web belt with a single tongue metal roller buckle



Product Code	Dimensions (mm) l x w x h	Shelf Pack	Barcode
IR-843	508 x 64 x 267	6	0019374964702

10 Pocket Suede Leather Tool Apron

- Constructed from premium suede leather for maximum flexibility and comfort
- Two large capacity pouches, two front pockets, six small pockets for speciality tools and a separate single pouch
- Two metal hammer holders and an open-ended tool holder
- Rivet reinforced at high stress points
- Double stitched main pockets for extra strength
- Adjustable nylon web belt with a single tongue metal roller buckle



Product Code	Dimensions (mm) l x w x h	Shelf Pack	Barcode
ATC-490-4	496 x 50 x 266	18	0019374334901

10 Pocket Split Leather Tool Apron

- Constructed from tough, lightweight split leather
- Two large capacity pouches, two front pockets and six small pockets for speciality tools
- A leather hammer holder, a leather tape measure holder and an open-ended tool holder
- Rivet reinforced at high stress points
- Adjustable nylon web belt with quick release belt buckle



Product Code	Dimensions (mm) l x w x h	Shelf Pack	Barcode
REI-499-4	560 x 50 x 230	24	0019374441036

5 Pocket Split Leather Tool Apron

- Constructed from tough, lightweight split leather
- Two large capacity pouches, two small pockets for speciality tools and a separate single pouch
- Two leather hammer holders
- Rivet reinforced at high stress points
- Adjustable polypropylene belt with quick release belt buckle



Product Code	Dimensions (mm) l x w x h	Shelf Pack	Barcode
REI-499-5	533 x 38 x 216	24	0019374441043

Economy Split Leather Tool Apron

- Constructed from tough, lightweight split leather
- Six pockets, a metal tape measure holder and a leather hammer holder
- Rivet reinforced at high stress points
- Adjustable nylon web belt with quick release belt buckle



Product Code	Dimensions (mm) l x w x h	Shelf Pack	Barcode
REI-221-4	432 x 38 x 254	36	0019374441012

Note: Tools not included

Leather Single Pouch Nail Bags

10 Pocket Oil Tanned Leather Nail and Tool Bag

- Constructed from premium full grain cowhide leather
- Treated with a special blend of oils and waxes to last longer in all weather conditions
- Six pockets, two small pockets for speciality tools and two metal hammer holders
- Rivet reinforced at high stress points
- Double stitched main pockets for extra strength
- Extra wide tunnel loop for belt



Product Code	Dimensions (mm) l x w x h	Shelf Pack	Barcode
CC-825	285 x 120 x 350	8	0019374608255

10 Pocket Full Grain Leather Nail and Tool Bag

- Constructed from premium full grain leather
- Six pockets, two small pockets for speciality tools and two metal hammer holders
- Rivet reinforced at high stress points
- Double stitched main pockets for extra strength
- Extra wide tunnel loop for belt



Product Code	Dimensions (mm) l x w x h	Shelf Pack	Barcode
R-823	285 x 120 x 350	8	0019374112806

6 Pocket Suede Leather Nail and Tool Bag

- Constructed from premium suede leather for maximum flexibility and comfort
- Large capacity main pocket, a corner reinforced nail pocket, three small pockets for speciality tools and a tape measure holder
- Rivet reinforced at high stress points
- Double stitched main pockets for extra strength
- Extra wide tunnel loop for belt



Product Code	Dimensions (mm) l x w x h	Shelf Pack	Barcode
RE-823	248 x 108 x 292	8	0019374123413

5 Pocket Split Leather Nail Bag

- Constructed from tough, lightweight split leather
- Four pockets and a leather hammer holder
- Rivet reinforced at high stress points
- Wide tunnel loop for belt
- Adjustable nylon belt with quick release belt buckle



Product Code	Dimensions (mm) l x w x h	Shelf Pack	Barcode
REI223-610-4	273 x 38 x 280	36	0019374441029

3 Pocket Split Leather Nail Bag

- Constructed from tough, lightweight split leather
- Three large capacity pockets for safe tool storage
- Rivet reinforced at high stress points
- Adjustable nylon belt with quick release belt buckle

Product Code	Dimensions (mm) l x w x h	Shelf Pack	Barcode
REI-227	305 x 38 x 241	40	0019374429041



2 Pocket Split Leather Nail Bag

- Constructed from tough, lightweight split leather
- Two large capacity pockets for safe tool storage
- Rivet reinforced at high stress points
- Adjustable nylon belt with quick release belt buckle

Product Code	Dimensions (mm) l x w x h	Shelf Pack	Barcode
REI-226	292 x 38 x 241	40	0019374429010



Leather Pouches

6 Pocket Saddle Leather Electrician's Tool Pouch

- Constructed from saddle leather for durability and strength
- Multiple tool pockets and slots for vertical tool storage
- Three tapered screwdriver holders, quick release tool snap, t-chain tape holder and a metal tape measure holder
- Rivet reinforced at high stress points
- Extra wide tunnel loop for belt

Product Code	Dimensions (mm) l x w x h	Shelf Pack	Barcode
R-500	305 x 76 x 265	2	0019374132019



Leather Tool Holders

Saddle Leather Open-Ended Plier and Tool Holder

- Constructed from saddle leather for durability and strength
- Die-moulded v-shape pocket
- Rivet reinforced at high stress points
- 50mm wide belt slots

Product Code	Dimensions (mm) l x w x h	Shelf Pack	Barcode
R-417	305 x 76 x 265	72	0019374131173



Saddle Leather Swinging Hammer Holder

- Constructed from saddle leather for durability and strength
- Free swinging hammer loop
- Nickel plated hammer loop for strength and rust resistance
- 57mm wide belt slots

Product Code	Dimensions (mm) l x w x h	Shelf Pack	Barcode
R-739	70 x 127 x 152	16	0019374132385



Note: Tools not included

Leather Tool Holders (continued)



Saddle Leather Hammer Holder

- Constructed from saddle leather for durability and strength
- Nickel plated hammer loop for strength and rust resistance
- 57mm wide belt slots

Product Code	Dimensions (mm) l x w x h	Shelf Pack	Barcode
R-739-1	108 x 64 x 254	16	0019374132392



Saddle Leather Plier and Tool Holder

- Constructed from saddle leather for durability and strength
- Fits most pliers and utility knives
- Rivet reinforced at high stress points
- 50mm wide belt slots

Product Code	Dimensions (mm) l x w x h	Shelf Pack	Barcode
R-401	95 x 25 x 229	72	0019374131029



Saddle Leather Roofers Knife Holder

- Constructed from saddle leather for durability and strength
- Rivet reinforced at high stress points
- 50mm wide belt slots

Product Code	Dimensions (mm) l x w x h	Shelf Pack	Barcode
R-453	25 x 89 x 241	72	0019374131531



Saddle Leather Chisel Holder

- Constructed from saddle leather for durability and strength
- Rivet reinforced at high stress points
- 50mm wide belt slots

Product Code	Dimensions (mm) l x w x h	Shelf Pack	Barcode
R-801	19 x 83 x 267	10	0019374554712



Split Leather Chisel Roll

- Constructed from tough, lightweight split leather
- Ten pockets fit different sized chisels
- Plastic quick release clip
- Rivet reinforced at high stress points

Product Code	Dimensions (mm) l x w x h	Shelf Pack	Barcode
ATC-4710	320 x 25 x 254	8	0019374946579

Riggers Belt

Rigger's Belt with Accessories – Saddle Leather

- Constructed from saddle leather for durability and strength
- Includes a podger holder, a torpedo level holder, a tape holder and a shifter holder
- Holders are rivet reinforced at high stress points
- Saddle leather belt with a single tongue roller buckle



Product Code	Dimensions (mm) l x w x h	Shelf Pack	Barcode
R-800-5	508 x 57 x 222	4	0019374544751

OTHER WORKWEAR

Cotton Workwear

10 Pocket Cotton Tool Apron

- Constructed from lightweight, body conforming cotton material
- Two large capacity pouches, two front pockets, multiple small pockets for speciality tools and a separate single pouch
- Two saddle leather hammer holders and a metal tape measure holder
- Rivet reinforced at high stress points
- Leather trimming on pockets for extra durability
- Quick release belt buckle
- Fits up to a 1300mm waist



Product Code	Dimensions (mm) l x w x h	Shelf Pack	Barcode
R-386-C-01	622 x 50 x 311	6	0019374946074

Note: Tools not included

Belts



Saddle Leather Work Belt

- Constructed from saddle leather for durability and strength
- Heavy duty double tongue roller buckle fits waists up to 1070mm
- Rivet reinforced for added strength
- 50mm wide belt

Product Code	Dimensions (mm) l x w x h	Shelf Pack	Barcode
R-603-L	70 x 76 x 241	6	0019374151041



Nylon Work Belt

- 50mm wide nylon web belt
- Rivet reinforced for added strength
- Quick release belt buckle
- Fits up to a 1070mm waist

Product Code	Dimensions (mm) l x w x h	Shelf Pack	Barcode
R-604-1	51 x 65 x 254	8	0019374736040



Cotton Work Belt

- 50mm wide cotton web belt
- Rivet reinforced for added strength
- Quick release belt buckle
- Fits up to a 1170mm waist

Product Code	Dimensions (mm) l x w x h	Shelf Pack	Barcode
R-621	50 x 64 x 254	8	0019374406219

Back Braces

Heavy Duty Support Belt

- Large adjustable waist band for a customised fit
- Breathable belt provides firm non-restrictive support
- Tapered design gives flexibility while maintaining proper support
- Moulded back panel for superior lumbar support
- Available in small/medium and large/extra-large sizing



Product Code	Size	Dimensions (mm) l x w x h	Shelf Pack	Barcode
IR-72080-S/M	S/M – 710mm-910mm	1047 x 19 x 197	10	9314244011397
IR-72080-L/XL	L/XL – 914mm-1117mm	1251 x 19 x 197	10	9314244012189

Back Support Belt – Standard

- Adjustable waist band for a customised fit
- Tapered design gives flexibility while maintaining proper support
- 32mm centre stay provides superior lumbar support
- Adjustable 32mm wide suspenders for added support
- Available in small, medium/large and extra large sizing
- Fits waists: S 560mm-8300mm, M/L 840mm-1100mm, XL 1110mm-1370mm



Product Code	Size	Shelf Pack	Barcode
RC-629-7-ML	M/L – 840mm-1100mm	24	0019374144685
RC-629-7-XL	XL/XXL – 1110mm-1370mm	24	0019374144692

Heavy Duty Suspenders

- Designed to hold nail bags and carpenter's aprons
- Heavy duty 50mm wide adjustable polypropylene front straps for strength
- Elastic nylon webbing rear straps
- Nickel plated, heavy duty hardware ensures tight grip
- One size fits most



Product Code	Dimensions (mm) l x w x h	Shelf Pack	Barcode
4031058	108 x 12 x 457	6	0024721091963

Knee Pads



1. I-Gel and foam padding provides optimum knee protection
2. Pro hinges for added comfort and to prevent pinching on the back of the leg
3. Hard cap, ridge design for easy knee swivel
4. I-Gel offers maximum impact absorption and will not compress or breakdown with extended wear

Gel Rocker Knee Pads with Hinges

Product Code	Dimensions (mm) l x w x h	Shelf Pack	Barcode
R-30509	89 x 356 x 33	5	9314244011403

Stabiliser Knee Pads



- I-Gel and foam padding provides optimum knee protection
- Flat tread design provides stable, shift-free grip and traction
- Superior stability and gripping ideal for roofing use
- I-Gel offers maximum impact absorption and will not compress or breakdown with extended wear

Product Code	Dimensions (mm) l x w x h	Shelf Pack	Barcode
R-22378	190 x 178 x 330	6	019374949211

Rocker Knee Pads



- I-Gel and foam padding provides optimum knee protection
- Hard cap, ridge design for easy knee swivel
- I-Gel offers maximum impact absorption and will not compress or breakdown with extended wear

Product Code	Dimensions (mm) l x w x h	Shelf Pack	Barcode
R-22379	178 x 127 x 330	6	019374949259

Soft Shell Knee Pads



- Won't scratch or scuff floors
- Extended cap covers entire knee region and flexes with knee
- Double strap design keeps knee pad in place when standing

Product Code	Dimensions (mm) l x w x h	Shelf Pack	Barcode
R-323	140 x 70 x 232	12	019374403232

Hard Shell Knee Pads

- Hard shell cap enables easy sliding and pivoting
- Adjustable straps with buckle closure system for convenience
- Double strap design keeps knee pad in place when standing

Product Code	Dimensions (mm) l x w x h	Shelf Pack	Barcode
R-322	140 x 70 x 232	6	019374193225



Cellular Rubber Comfort Knee Pads

- Contoured, economical design for all day use
- Made from thick natural cellular rubber for extra comfort
- Single, elastic strap with hook and loop closure for easy adjustment and convenience

Product Code	Dimensions (mm) l x w x h	Shelf Pack	Barcode
R-319	216 x 76 x 330	20	019374703196



Tri-Laminate Knee Pads

- Lightweight, economical design for all day use
- 3 layer design for superior comfort
- Single, elastic strap with hook and loop closure for easy adjustment and convenience

Product Code	Dimensions (mm) l x w x h	Shelf Pack	Barcode
R-318-3-OR	146 x 95 x 254	32	019374949556





IRWIN®

JACK®



HANDBSAWS

Panel Saws

1. Tapered pitch nose improves clearance and increases stability
2. High quality C75 steel blade ensures superior stability and power transfer
3. 0.85mm lacquered blade provides 4X better rust protection than traditional lacquer coating
4. 90° and 45° accurate templates
5. Comfort grip and finger rest
6. Unique blade and handle design eliminates binding
7. Optimised tooth design and set
8. Hardpoint Teeth stay sharp 6-8X longer than non-hardened teeth

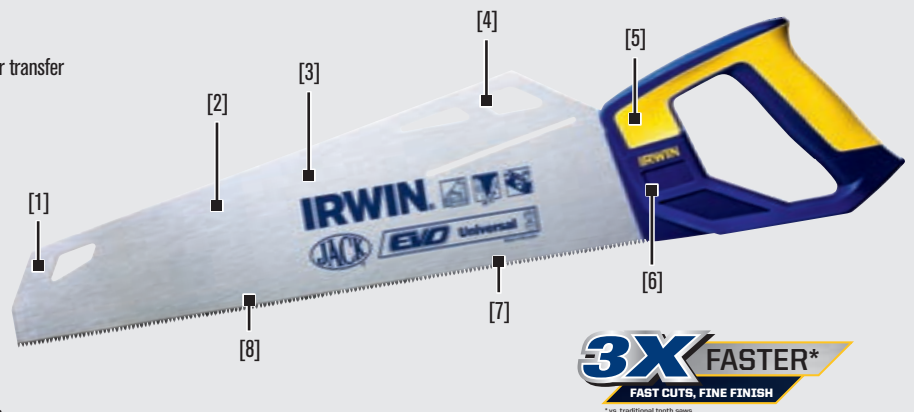

EVO Universal Saw

Product Code	Size	Tooth Count	Shelf Pack	Barcode
10507858	525mm	10T/11P	10	5706915078589
10507860	375mm	10T/11P	10	5706915078602

XPERT Universal Saw

- Triple Ground Tooth technology for clean, fast and easy cutting
- Universal toothing will cut across and with the grain
- Ideal for soft woods and board materials
- 10505546 has friction reducing PTFE coating, providing smoother, faster cutting and high rust protection

Product Code	Size	Tooth Count	Shelf Pack	Barcode
10505540	500mm	8T/9P	4	5706915055405
10505546	550mm	8T/9P	4	5706915055467

XPERT Fine Saw

- Triple Ground Tooth technology for clean, fast and easy cutting
- Ideal for cutting hardwood and for accurate finishing cuts
- 10T/11P for ultimate all round sawing performance

Product Code	Size	Tooth Count	Shelf Pack	Barcode
10505543	550mm	10T/11P	4	5706915055436
10505555	375mm	10T/11P	4	5706915055559



Panel Saws (continued)

PLUS 880 Universal Saw

- Razor sharp universal tooth design cuts on push and pull stroke
- Constructed from 0.85mm premium cold rolled steel
- Surface treated for 4X better rust resistance
- Non-slip two part comfortable grip handle

Product Code	Size	Tooth Count	Shelf Pack	Barcode
10504325	650mm	7T/8P	10	5706915043259
10504323	500mm	7T/8P	10	5706915043235
10504327	350mm	7T/8P	10	5706915043273

PLUS 770 Crosscut Saw

- Crosscut tooth design cuts across the grain on the push and pull stroke
- Constructed from 0.85mm premium cold rolled steel
- Surface treated for 4X better rust resistance
- Non-slip two part comfortable grip handle

Product Code	Size	Tooth Count	Shelf Pack	Barcode
10504324	550mm	7T/8P	10	5706915043242

PLUS 990 Universal Fine Saw

- Razor sharp universal fine tooth design cuts on push and pull stroke
- Constructed from 0.85mm premium cold rolled steel
- Surface treated for 4X better rust resistance
- Non-slip two part comfortable grip handle

Product Code	Size	Tooth Count	Shelf Pack	Barcode
10504326	500mm	9T/10P	10	5706915043266

880UHP-500ATC Panel Saw

- Constructed from 0.85mm premium cold rolled steel
- Surface treated for 4X better rust resistance
- Hardpoint razor sharp teeth – last 6X longer than non-hardened teeth

Product Code	Size	Tooth Count	Shelf Pack	Barcode
880UHP-500ATC	500mm	7T/8P	10*	5715110429409

* Available in packs of 10 only

Pull Saws

Dovetail/Detail Saw

- Flush-cutting dowels and fine detail cut
- Flexible blade for flush cuts
- User example: Interior Trim Carpenter – detail work around windows and door frames

Product Code	Size	Tooth Count	Shelf Pack	Barcode
213104	185mm	22P	4	0038548017389

Double Edge Saw

- Utility ripping and cross-cutting
- Flexible blade for flush cuts
- User example: General Carpenter – flush-cutting door shims and remodeling – cleanout of door casing prior to laying new floor tile

Product Code	Size	Tooth Count	Shelf Pack	Barcode
213103	240mm	7P/17P	4	0038548017372



Specialist Saws

PLUS 955 Tenon Saw

- Fine hardpoint teeth for precision cuts – recommended for use with mitre boxes
- Reinforced back for added stability

Product Code	Size	Tooth Count	Shelf Pack	Barcode
10504328	300mm	12T/13P	10	5706915043280



PLUS 949 Veneer Saw

- Recommended for cutting wood, moulding, PVC pipe and guttering
- Round nose with cutting teeth enables cut to start in middle of sheet

Product Code	Size	Tooth Count	Shelf Pack	Barcode
10504329	325mm	12T/13P	10	5706915043297



ProTouch™ Plasterboard Saw

- Ergonomic ProTouch™ handle for safety, durability and comfort
- Hardened and tempered 1.5mm blade
- Sharpened tip for easy punching through plaster
- 8T/9P triple ground teeth for aggressive cuts on push and pull stroke

Product Code	Tooth Count	Shelf Pack	Barcode
2014100	8T/9P	4	024721064813



Plasterboard Saw

- Ergonomic handle for superior comfort
- Extra sharp tip provides easy entry to plasterboard

Product Code	Size	Tooth Count	Shelf Pack	Barcode
10507490	165mm	6T/8P	20	5706915074901



Coping Saw

- Large frame depth (140mm depth / 165mm length)
- Flat-Bar™ frame provides a more rigid blade for longer life
- Ergonomic Protouch™ handle for safety, durability and comfort
- Solid Dura-Steel™ pins provide better durability than cast wings

Product Code	Description	Tooth Count	Shelf Pack	Barcode
2014400	Coping Saw	16T/17P	4	0024721064844
2014500	Saw Blades (coarse)	16T/17P	4	0024721064851



Gardening Saws



Combo Saw - Bow Saw/Hacksaw

- Includes wood blade and metal hacksaw blade
- Fine tooth design for a smooth cut
- Handle designed for easy blade replacement
- Available in shelf pack quantities only

Product Code	Description	Size	Shelf Pack	Barcode
XP1211-300	Combo Saw	317mm	12	5706915000122

XPERT Bow Saw



- Precision filed and hardened teeth cut on pull and push stroke
- Tooth configurations for green and dry wood
- Manufactured with high frequency welded steel tubing to maintain blade tension
- Extra strong latches ensure optimal blade tension and hand protection while working
- Available in shelf pack quantities only

Product Code	Description	Size	Shelf Pack	Barcode
XP1620-533	Oval Frame, Hardpoint Teeth	533mm	5	5706915000146
XP1120-610	Oval Frame, Hardpoint Teeth	610mm	5	5706915000160
XP1120-762	Oval Frame, Hardpoint Teeth	762mm	5	5706915000184

Basic Bow Saw



- Precision filed, double ground saw teeth cut on pull and push stroke
- Hardpoint teeth last 6-8X longer than unhardened saw teeth
- Hook and clasp design for quick, easy, tool-free blade change
- Available in shelf pack quantities only

Product Code	Description	Size	Shelf Pack	Barcode
BA1320-533	Round Frame, Hardpoint Teeth	533mm	12	5715110410575
BA1224-610	Oval Frame, Hardpoint Teeth	610mm	12	5715110410537
BA1224-762	Oval Frame, Hardpoint Teeth	762mm	12	5715110410551
BA1224-914	Oval Frame, Hardpoint Teeth	914mm	12	5715110410667

XPERT Blades - Dry Wood

- Hardpoint teeth last 6-8X longer than non-hardened teeth

Product Code	Description	Size	Shelf Pack	Barcode
XP3020-533	20mm Wide, Hardpoint Teeth, Dry	533mm	10	5715110480189
XP3020-610	20mm Wide, Hardpoint Teeth, Dry	610mm	10	5715110480219
XP3020-762	20mm Wide, Hardpoint Teeth, Dry	762mm	10	5715110480240
BA3020-914	20mm Wide, Hardpoint Teeth, Dry	914mm	10	5715110431624

XPERT Blades - Green Wood

- Hardpoint teeth last 6-8X longer than non-hardened teeth

Product Code	Description	Size	Shelf Pack	Barcode
XP3024-533	20mm Wide, Hardpoint Teeth, Green	533mm	10	5715110480271
XP3024-610	20mm Wide, Hardpoint Teeth, Green	610mm	10	5715110480332
XP3024-762	20mm Wide, Hardpoint Teeth, Green	762mm	10	5715110480301

Pruning Saw

- Razor sharp hardpoint teeth
- High quality blade construction
- Handle designed to take extension pole for high cutting
- Fastened with two screws for maximum life
- Curved blade cuts on the pull stroke only



Product Code	Description	Size	Shelf Pack	Barcode
10507491	Straight Blade Pruning Saw	343mm	6	5706915074918
10507492	Curved Blade Pruning Saw	330mm	6	5706915074925

HACKSAW FRAMES

Hacksaws

1. Jab saw for confined spaces
2. High tension frame up to 25,000 psi for straight, fast cutting and less binding
3. Built-in blade storage compartment
4. Ergonomic metal frame — gives higher blade tension and prevents blade loss when dropped
5. Comfortable soft grip handle — prevents slippage
6. Metal tensioning mechanism — for a longer life
7. 55° - 90° blade mounting

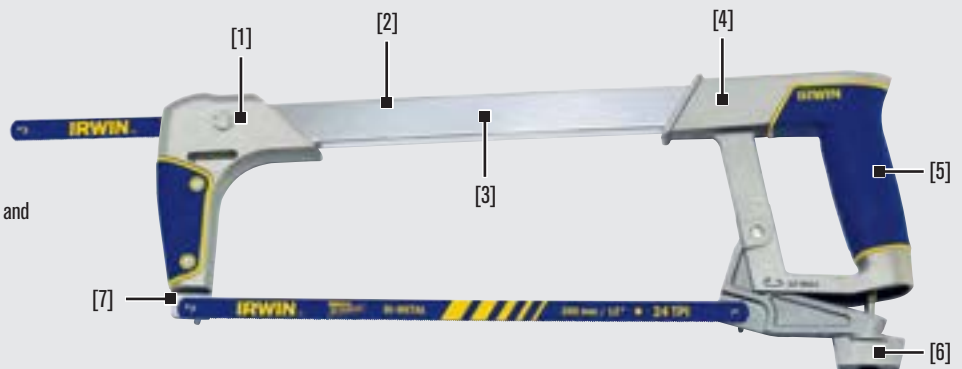

IRWIN TOOLS

I-125 High Tension Hacksaw

Product Code	Description	Shelf Pack	Barcode
10504407	I-125 High Tension Hacksaw	10	5706915044072

I-75 Lightweight Hacksaw

- Durable full metal frame - tensions up to 15,000 PSI
- Full metal tensioning mechanism for easy adjustment
- 90° - 180° blade mounting for sawing large objects
- Mushroom pins to prevent the blade from releasing if dropped

Product Code	Description	Shelf Pack	Barcode
10506437	I-75 Lightweight Hacksaw	10	5706915064377



Hacksaws (continued)



I-100 Junior Hacksaw

- Durable metal frame for higher blade tension and improved cutting
- Ergonomic handle for comfortable sawing
- Easy tensioning mechanism

Product Code	Description	Shelf Pack	Barcode
10504409	I-100 Junior Hacksaw	5	5706915044096



I-50 Mini Hacksaw

- Jab saw design for sawing in confined spaces
- Durable metal frame for a long lasting tool
- Ergonomic handle for comfortable sawing

Product Code	Description	Shelf Pack	Barcode
10504408	I-50 Mini Hacksaw	5	5706915044089



IRWIN®

Marples®



CHISELS & PLANES

IRWIN
Marples®

Chisels

1. Fully forged steel core for strength and durability
2. Extra large strike cap withstands repetitive hammer strikes and can be hit from multiple angles
3. Split-proof acetate handle for reinforced strength
4. Blade tempered, annealed and hardened to the last inch for longer life
5. ProTouch™ overmould grip for added comfort

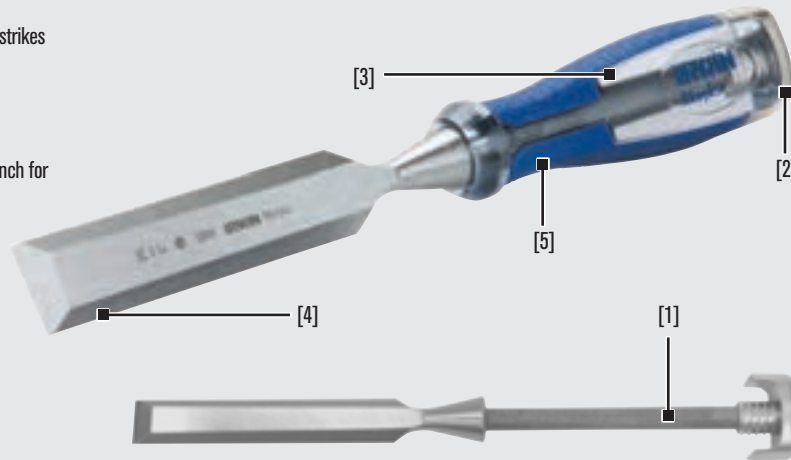

M750 High Impact Chisels

Product Code	Size (mm)	Size (inches)	Shelf Pack	Barcode
10501673ANZ	6	1/4	4	9314244011755
10501675ANZ	10	3/8	4	9314244011762
10501677ANZ	13	1/2	4	9314244011786
10501680ANZ	16	5/8	4	9314244011793
10501682ANZ	19	3/4	4	9314244011809
10501685ANZ	25	1	4	9314244011816
10501689ANZ	32	1-1/4	4	9314244011823
10501691ANZ	38	1-1/2	2	9314244011830
10501693ANZ	51	2	2	9314244011847
Sets				
10503421ANZ*	6, 10, 13, 19, 25	1/4, 3/8, 1/2, 3/4, 1	4	9314244012127
10501697ANZ**	6, 10, 13, 19, 25, 32	1/4, 3/8, 1/2, 3/4, 1, 1 1/4	5	9314244012110

*Set in fabric wallet
**Boxed in wooden case

Chisels (continued)

MS500B Construction Butt Chisels



- Large strike cap withstands repetitive hammer strikes
- Ergonomic handle design with ProTouch™ Grip is durable enough to withstand the roughest jobsite
- Short blade butt chisel provides additional control when used in tight spaces
- Premium steel quality for improved sharpness and edge retention
- Short 120mm blade tempered, annealed and hardened to the last inch for longer life

Product Code	Size (mm)	Size (inches)	Shelf Pack	Barcode
10504001ANZ	13	1/2	4	9314244011977
10504002ANZ	19	3/4	4	9314244011984
10504003ANZ	25	1	4	9314244011991
10504004ANZ	32	1 1/4	4	9314244012004
10504005ANZ	38	1 1/2	2	9314244012011
10504006ANZ	51	2	2	9314244012028
Sets				
10504007ANZ	6, 13, 19, 25	1/4, 1/2, 3/4, 1	4	9314244012141

MS500 Construction Chisels

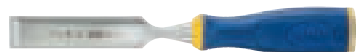

- Large strike cap withstands repetitive hammer strikes
- Ergonomic handle design with ProTouch™ Grip is durable enough to withstand the roughest jobsite
- Premium steel quality for improved sharpness and edge retention
- Blade tempered, annealed and hardened to the last inch for longer life

Product Code	Size (mm)	Size (inches)	Shelf Pack	Barcode
10501700ANZ	10	3/8	4	9314244011878
10501702ANZ	13	1/2	4	9314244011892
10501705ANZ	16	5/8	4	9314244011908
10501706ANZ	19	3/4	4	9314244011915
10501708ANZ	25	1	4	9314244011922
10503669ANZ	32	1 1/4	4	9314244011946
10503670ANZ	38	1 1/2	2	9314244011953
Sets				
10503426ANZ*	13, 19, 25	1/2, 3/4, 1	4	9314244012134

*Set in fabric wallet

M444 Woodworking Chisel Sets

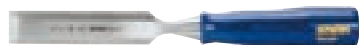

- Premium steel quality for improved sharpness and edge retention
- Slim ergonomic handle for added control, precision and comfort
- Blade tempered, annealed and hardened to the last inch for longer life
- Strong handle for use with a mallet

Product Code	Size (mm)	Size (inches)	Shelf Pack	Barcode
M444S3ANZ	13, 19, 25	1/2, 3/4, 1	4	9314244012073
M444S4ANZ	6, 13, 19, 25	1/4, 1/2, 3/4, 1	4	9314244012080



Planes

1. Cast fine-grained grey iron & CNC-machined body
2. Razor sharp high speed steel blade
3. Brass adjusting nut for fine setting
4. Robust lever cap knob for secure location of the cutting iron

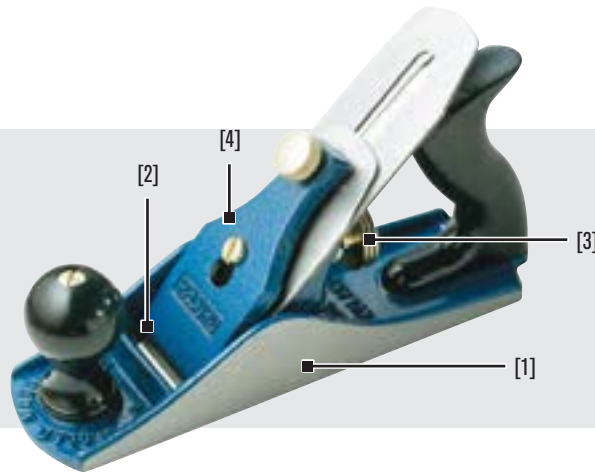

Bench Planes

- Smoothing Plane used for smoothing and final finishing

Product Code	Type	Length	Cutter Width	Shelf Pack	Barcode
SP4	Smooth (Blister Pack)	245mm	50mm	4	0734442165729

Spokeshaves

- Flat face used for chamfering and shaping
- Round face used for convex and concave surfaces
- High speed steel cutter
- Lateral and vertical adjustment

Product Code	Face	Length	Cutter Width	Shelf Pack	Barcode
A151	Flat	250mm	54mm	4	0734442056164
A151R	Round	250mm	54mm	4	0734442056287



IRWIN®

Circular Saw Blades



IRWIN TOOLS

Customer Service: 1800 331 491

The Complete Saw Blade Solution

IRWIN® offers a comprehensive line-up of circular saw blades for professional tool users. From the job site, to the fine woodworking shop, IRWIN offers a blade for every user need. Use the table below to match blades for your equipment. Locate the saw type and blade diameter in the left column. The columns to the right list the recommended blade sizes and the available number of teeth per blade.

Type of Blade	Machine Style	Blade Diameter	Arbor Size	Bush	Material	Application	Teeth
IRWIN 	Handheld	7¼", 184mm	20mm	16mm	Wood	Framing/Ripping	20T,24T
	Handheld	9¼", 235mm	25mm	16mm	Wood	Trim/Finish	40T
	Mitre	8½", 216mm	25mm	16mm	Wood	Framing/Ripping	20T
MARATHON 	Handheld	6¼", 160mm	20mm	16mm	Wood	Trim/Finish	40T
	Handheld	7¼", 184mm	20mm	16mm	Wood	Framing/Ripping	18T,24T
	Handheld	8¼", 210mm	25mm	16mm	Wood	Trim/Finish	40T,60T
	Handheld	9¼", 235mm	25mm	16mm	Wood	Framing/Ripping	24T
MARATHON WeldTec 	Handheld	8¼", 210mm	25mm	16mm	Wood	Trim/Finish	40T,60T
	Cordless	5½", 140mm	10mm	N/A	Wood	Framing/Ripping	20T
	Cordless	6½", 165mm	20mm	16mm	Wood	Framing/Ripping	18T,24T
	Handheld	6¼", 160mm	20mm	16mm	Wood	Trim/Finish	40T
	Handheld	7¼", 184mm	20mm	16mm	Fibre Cement	-	6T
	Handheld	7¼", 184mm	20mm	16mm	Wood	Framing/Ripping	24T
	Handheld	7¼", 184mm	20mm	16mm	Wood	Trim/Finish	40T
MARATHON Large Diameter 	Table & Mitre	10", 254mm	30mm	1"/25/16mm	Wood	Framing/Ripping	24T
	Table & Mitre	12", 305mm	30mm	1"/25/16mm	Wood	General Purpose	40T
	Table & Mitre	12", 305mm	30mm	1"/25/16mm	Wood	Trim/Finish	60T,80T
Professional 	Mitre	10", 254mm	30mm	1"/25/16mm	Wood	General Purpose	40T
	Mitre	12", 305mm	30mm	1"/25/20/16mm	Wood	Trim/Finish	72T,80T
Aluminium / Multi Material 	Mitre	10", 254mm	30mm	1"/25/16mm	Wood	Trim/Finish	40T,60T,80T
	Handheld	6¼", 160mm	1"	20/19/16mm	Aluminium, Plastic and Wood	Trim/Finish	56T
	Handheld	7¼", 184mm	20mm	16mm	Aluminium, Plastic and Wood	Trim/Finish	64T
	Handheld	8¼", 210mm	30mm	25/20/16mm	Aluminium, Plastic and Wood	Trim/Finish	60T
	Handheld	9¼", 235mm	25mm	20/16mm	Aluminium, Plastic and Wood	Trim/Finish	80T
	Mitre	8½", 216mm	30mm	25/16mm	Aluminium, Plastic and Wood	Trim/Finish	80T
	Table & Mitre	10", 254mm	30mm	1"/25/20/16mm	Aluminium, Plastic and Wood	Trim/Finish	60T,80T,100T
Fibre Cement 	Table & Mitre	12", 305mm	30mm	1"/25/20/16mm	Aluminium, Plastic and Wood	Trim/Finish	100T
	Handheld	7¼", 184mm	20mm	16mm	Fibre Cement	Ripping/ Cross Cutting	4T
PVC 	Handheld	7¼", 184mm	20mm	16mm	PVC	Ripping/ Cross Cutting	120T
Metal 	Cold Cut Handheld	7¼", 184mm	20mm	N/A	Metal	Steel/Thin Steel	48T,68T
	Cold Cut Mitre	12", 305mm	1"	N/A	Metal	Steel/Thin Steel	60T
	Cold Cut Mitre	14", 356mm	1"	N/A	Metal	Steel/Thin Steel	80T

CIRCULAR SAW BLADES

Handheld Blades

1. Thin kerf for fast cuts and longer life
2. Hardened and tempered steel body ensures smoother cutting action and longer life
3. Innovative heat vents and expansion slots for straighter cuts
4. UC2™ (sub-micro grain) carbide teeth are 70% tougher than standard carbide teeth
5. E.O.T™, Grind Technology, where every other tooth is ground thinner



MADE STRONGER. LASTS LONGER™

Unlike standard brazed blades, the revolutionary MARATHON® with WeldTec™ saw blade from IRWIN® has welded carbide teeth. Welding fuses the carbide teeth to the blade, making the bond as strong as the steel plate. This bond is unaffected by the build up of heat, resulting in greater life and durability.



Brazed Carbide

Welded Carbide - 50% Longer Life

2X LONGER LIFE*
vs. original MARATHON® blade

MARATHON® with WeldTec™ Blades

Product Code	Size	Teeth	RPM	Arbor	Bush	Application	Shelf Pack	Barcode
Cordless Ultra Thin Kerf								
14011WT	140mm (5½")	24T	8500	10mm	N/A	Framing/Ripping	10	9314244010468
14020WT	165mm (6½")	18T	8300	20mm	16mm	Framing/Ripping	10	9314244010475
14029WT	165mm (6½")	24T	8300	20mm	16mm	Framing/Ripping	10	9314244010482
14023WT	165mm (6½")	40T	8500	20mm	16mm	Trim/Finish	10	9314244010499
Handheld Thin Kerf								
94012WT	160mm (6¼")	20T	7000	20mm	16mm	Framing/Ripping	10	9314244010505
94013WT	160mm (6¼")	40T	7000	20mm	16mm	Trim/Finish	10	9314244010512
93029WT	184mm (7¼")	6T	7000	20mm	16mm	Fibre Cement	10	9314244010611
94010WT	184mm (7¼")	24T	7000	20mm	16mm	Framing/Ripping	10	9314244010277
94011WT	184mm (7¼")	40T	7000	20mm	16mm	Trim/Finish	10	9314244010529
94134WT	210mm (8¼")	24T	7000	25mm	16mm	Framing/Ripping	10	9314244010536
94135WT	210mm (8¼")	40T	7000	25mm	16mm	Trim/Finish	10	9314244010543
94131WT	235mm (9¼")	20T	6500	25mm	16mm	Framing/Ripping	10	9314244010550
94132WT	235mm (9¼")	40T	6500	25mm	16mm	Trim/Finish	10	9314244010567
94133WT	235mm (9¼")	60T	6500	25mm	16mm	Trim/Finish	10	9314244010574
Sets								
94142WT2PK	184mm (7¼")	24/40T	7000	20mm	16mm	Framing/Ripping/ Trim/Finish	10	9314244010581
Bulk Packs								
94140WT	184mm (7¼")	24T	7000	20mm	16mm	Framing/Ripping	10	9314244010598
94141WT	235mm (9¼")	20T	6500	25mm	16mm	Framing/Ripping	10	9314244010604

Handheld Blades (continued)

MARATHON® Series Blades

- Patented EVO[^] alternating thin kerf design provides faster speed of cut
- Expansion control slots reduce blade warping and vibration for cleaner truer cuts
- Heat vents reduces heat and aids in chip ejection
- Precision ground teeth provide smooth and accurate cuts
- Brazed construction grade carbide for longer life & increased durability



Product Code	Size	Teeth	RPM	Arbor	Bush	Application	Shelf Pack	Barcode
Cordless Series Ultra Thin Kerf								
9098011	160mm (6-1/4)	40T	8300	20	16	Trim/Finish	5	9314244021464
9098012	184mm (7-1/4)	24T	8300	20	16	Framing/Ripping	10	9314244021471
9098014	184mm (7-1/4)	40T	8300	20	16	Trim/Finish	10	9314244021495
9098016	184mm (7-1/4)	60T	8300	20	16	Trim/Finish	10	9314244021518
9098017	210mm (8-1/4)	24T	7300	25	16	Framing/Ripping	5	9314244021525
9098019	210mm (8-1/4)	40T	7300	25	16	Trim/Finish	5	9314244021549
9098020	210mm (8-1/4)	60T	7300	25	16	Trim/Finish	5	9314244021556
9098021	235mm (9-1/4)	20T	6700	25	16	Framing/Ripping	10	9314244021563
9098023	235mm (9-1/4)	40T	6700	25	16	Trim/Finish	10	9314244021587
9098024	235mm (9-1/4)	60T	6700	25	16	Trim/Finish	10	9314244021594
Sets								
9098025	184mm (7-1/4)	24/40T	8300	20	16	Framing/Ripping & Trim/Finish	10	9314244021600
9098026	184mm (7-1/4)	18/24/40T	8300	20	16	Framing/Ripping & Trim/Finish	10	9314244021617
Bulk Packs								
9098031	184mm (7-1/4)	40T	8300	20	16	Trim/Finish	10	9314244021662
9098032	235mm (9-1/4)	20T	6700	25	16	Framing/Ripping	10	9314244021679
9098033	235mm (9-1/4)	40T	6700	25	16	Trim/Finish	10	9314244021686

[^]Every other tooth is ground thinner

General Purpose Blades

IRWIN Series Blades

- Induction brazed carbide tips provide longer cutting life
- Precision ground teeth for smooth and accurate cuts
- Heavy gauge steel body reduces warping and runs straighter



Product Code	Size	Teeth	RPM	Arbor	Bush	Shelf Pack	Barcode
Cordless Series Ultra Thin Kerf							
9098004	184mm (7-1/4)	24T	8300	20	16	10	9314244021396
9098005	184mm (7-1/4)	40T	8300	20	16	10	9314244021402
9098006	216mm (8-1/2)	48T	7300	25	16	10	9314244021419
9098007	235mm (9-1/4)	20T	6700	25	16	10	9314244021426
9098008	235mm (9-1/4)	40T	6700	25	16	10	9314244021433
Sets							
9098009	184mm (7-1/4)	20/40T	8300	20	16	10	9314244021440

Large Diameter Blades

MARATHON® Large Diameter Blades

- Construction grade carbide teeth for longer life
- Precision balanced for accurate smooth cuts
- Thin kerf for fast cuts and longer life
- Face ground tips for sharper teeth and a smooth finish
- #400 grit diamond ground teeth for fast, clean cuts

Product Code	Size	Teeth	RPM	Arbor	Bush	Application	Shelf Pack	Barcode
14233ANZ	254mm (10")	24T	5900	30mm	1"/25/16mm	Framing/Ripping	10	9314244010703
14070ANZ	254mm (10")	40T	5900	30mm	1"/25/16mm	General Purpose	10	9314244010710
14074ANZ	254mm (10")	60T	5900	30mm	1"/25/16mm	Trim/Finish	10	9314244010727
14076ANZ	254mm (10")	80T	5900	30mm	1"/25/16mm	Trim/Finish	10	9314244010734
14080ANZ	305mm (12")	40T	5900	30mm	1"/25/16mm	General Purpose	10	9314244010741
14082ANZ	305mm (12")	72T	5000	30mm	1"/25/16mm	Trim/Finish	10	9314244010758
14083ANZ	305mm (12")	80T	5000	30mm	1"/25/16mm	Trim/Finish	10	9314244010765

MARATHON®



Professional Series Blades

- Precision diamond ground tungsten carbide tips for a sharper cut
- Hardened and tempered steel body ensures smoother cutting action and longer life
- Corrosion resistant coating helps prevent rusting

Product Code	Size	Teeth	RPM	Arbor	Bush	Application	Shelf Pack	Barcode
93003	254mm (10")	40T	6000	30	1"/25/16mm	Trim/Finish	5	9416143930035
93004	254mm (10")	60T	6000	30	1"/25/16mm	Trim/Finish	5	9416143930042
93015	254mm (10")	80T	6000	30	1"/25/16mm	Trim/Finish	5	9416143930158
93006	305mm (12")	60T	5000	30	1"/25/20/16mm	Trim/Finish	5	9416143930066
93008	305mm (12")	100T	5000	30	1"/25/20/16mm	Trim/Finish	5	9416143930080



Multi-Material Blades

Aluminium+ Series Blades

- Precision diamond ground tungsten carbide tips for a sharper cut
- Triple chip ground, negative hook teeth for faster, cleaner cuts
- Hardened and tempered steel body ensures smoother cutting action and longer life
- Corrosion resistant coating helps prevent rusting
- Suitable for aluminium, plastic, melamine and timber

Product Code	Size	Teeth	RPM	Arbor	Bush	Application	Shelf Pack	Barcode
Handheld Series								
95018	160mm (6¼")	56T	7000	1"	20/19/16mm	Trim/Finish	5	9416143950187
95009	184mm (7¼")	64T	7000	20mm	16mm	Trim/Finish	5	9416143950095
95026	210mm (8¼")	60T	6500	30mm	25/20/16mm	Trim/Finish	5	9416143950262
95135	235mm (9¼")	80T	6500	25mm	20/16mm	Trim/Finish	5	9416143951351
Mitre Saws								
93012	216mm (8½")	80T	6500	30mm	25/16mm	Trim/Finish	5	9416143930127
95045	254mm (10")	60T	6000	30mm	1"/25/20/16mm	Trim/Finish	5	9416143950453
95048	254mm (10")	80T	6000	30mm	1"/25/20/16mm	Trim/Finish	5	9416143950484
95049	254mm (10")	100T	6000	30mm	1"/25/20/16mm	Trim/Finish	5	9416143950491
93016	305mm (12")	100T	5000	30mm	1"/25/20/16mm	Trim/Finish	5	9416143930165



Material Specific Cutting Blades



MARATHON® PCD Fiber Cement Blades

- Ground and hardened plate body provides smooth and accurate cuts
- Polycrystalline Diamond (PCD) tipped teeth
- 4T thin kerf blade produces less dust than continuous rim blades
- Laser cut blade body and a stronger tooth bond allows for an accurate and true cut



Product Code	Size	Teeth	RPM	Arbor	Bush	Application	Shelf Pack	Barcode
4935473ANZ	184mm (7 1/4")	4T	7300	20mm	16mm	Ripping/Cross Cutting	10	9314244010819



MARATHON® PVC Cutting Blades

- Optimised, symmetric 60 degree tooth design eliminates chipping and cracking for a smooth, fast cut
- Innovative heat vents and expansion slots for straighter cuts
- Efficient chip ejection prevents binding and blade warping

Product Code	Size	Teeth	RPM	Arbor	Bush	Application	Shelf Pack	Barcode
11830ANZ	184mm (7 1/4")	120T	8300	20mm	16mm	Ripping/Cross Cutting	10	9314244010840



Metal Cutting Blades

- Laser cut anti-vibration vents keep the blade cool for smooth and accurate cuts
- Anti-kickback tooth shoulder reduces dust and sparks for safer cuts
- Metal cutting grade carbide teeth withstands impact, reduces wear and delivers long life
- Laser cut body and a stronger tooth bond allow for an accurate and true cut

Product Code	Size	Teeth	RPM	Arbor	Bush	Application	Shelf Pack	Barcode
4935555ANZ	184mm (7 1/4")	48T	5000	20mm	N/A	Steel/Thin Steel	10	9314244010772
4935560ANZ	184mm (7 1/4")	68T	4000	20mm	N/A	Steel/Thin Steel	10	9314244010789
4935559ANZ	355mm (14")	80T	1800	25.4mm	N/A	Steel/Thin Steel	10	9314244010802

IRWIN® Metal Cutting Blades are intended for use only with portable or stationary cold cut metal saws.

Saw Lubricant



- Lubricant should be applied when cutting aluminium, metal and alloys

Product Code	Size	Shelf Pack	Barcode
00064	150g	1	9314244000643
00065	1000g	1	9314244000650







STEP DRILLS

Multiple Hole Step Drill Bits - Single Flute

1. Speed point tip provides extra cutting edges for faster initial penetration and no need for centre punching (except item 10231)
2. Available in Titanium Nitride coating delivers cutting edge life up to 6X longer (available on selected models)
3. Multiple steps allows drilling of up to 13 different sized holes
4. Three-sided shank prevents drill bit slipping in chuck
5. Burr-free holes deburred by cutting edge of next larger step
6. Single cutting edge for perfectly round holes

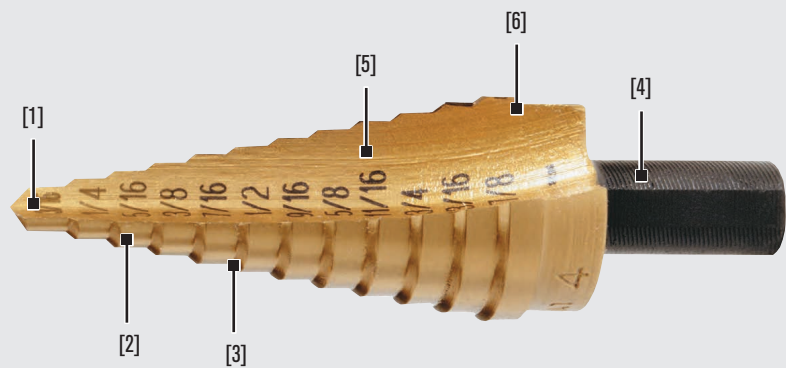

Multiple Hole Size Bits - Imperial

Hole sizes: 13

- Diameter: 1/8"–1/2" in 1/32" increments
- Step thickness: 1/8"
- Shank diameter: 1/4"
- Perfect all round bit for most common drilling jobs

Product Code	Reference #	Bit Finish	Shelf Pack	Barcode
15101	#1T	Titanium Nitride	5	0038548151014
10231	#1	High Speed Steel	5	0038548101019

Hole sizes: 6

- Diameter: 3/16"–1/2" in 1/16" increments
- Step thickness: 3/8"
- Shank diameter: 1/4"
- Ideally suited for drilling standard hole sizes in materials up to 3/8" thick

Product Code	Reference #	Bit Finish	Shelf Pack	Barcode
15102	#2T	Titanium Nitride	5	0038548151021
10232	#2	High Speed Steel	5	0038548101026

Hole sizes: 9

- Diameter: 1/4"–3/4" in 1/16" increments
- Step thickness: 1/8"
- Shank diameter: 3/8"
- Good choice for cutting medium sized holes quickly and easily

Product Code	Reference #	Bit Finish	Shelf Pack	Barcode
15103	#3T	Titanium Nitride	5	0038548151038
10233	#3	High Speed Steel	5	0038548101033



Multiple Hole Step Drill Bits - Single Flute (continued)

Multiple Hole Size Bits - Imperial - continued

Hole sizes: 12

- Diameter: 3/16"–7/8" in 1/16" increments
- Step thickness: 1/8"
- Shank diameter: 3/8"
- Fastest step drill to a 1/2" knock-out. Especially suitable for making perfectly round, miniature push button and pilot light holes

Product Code	Reference #	Bit Finish	Shelf Pack	Barcode
15104	#4T	Titanium Nitride	5	0038548151045
10234	#4	High Speed Steel	5	0038548101040

Multiple Hole Size Bits - Metric

Hole sizes: 9

- Diameter: 4mm–12mm in 1mm increments
- Step thickness: 5mm
- Shank diameter: 6mm
- Perfect all-round bit for most common drilling jobs

Product Code	Reference #	Bit Finish	Shelf Pack	Barcode
16101	#1MT	Titanium Nitride	5	0038548161013
11101	#1M	High Speed Steel	5	0038548111018

Hole sizes: 5

- Diameter: 4mm–12mm in 2mm increments
- Step thickness: 11mm
- Shank diameter: 6mm
- Ideally suited for drilling standard hole sizes in materials up to 10mm thick

Product Code	Reference #	Bit Finish	Shelf Pack	Barcode
16102	#2MT	Titanium Nitride	5	0038548161020
11102	#2M	High Speed Steel	5	0038548111025

Hole sizes: 7

- Diameter: 6mm–18mm in 2mm increments
- Step thickness: 5mm
- Shank diameter: 10mm
- Good choice for cutting medium-sized holes quickly and easily

Product Code	Reference #	Bit Finish	Shelf Pack	Barcode
16103	#3MT	Titanium Nitride	5	0038548161037
11103	#3M	High Speed Steel	5	0038548111032



Hole sizes: 10

- Diameter: 4mm–22mm in 2mm increments
- Step thickness: 5mm
- Shank diameter: 10mm
- A wide range of the most practical and popular sizes

Product Code	Reference #	Bit Finish	Shelf Pack	Barcode
16104	#4MT	Titanium Nitride	5	0038548161044
11104	#4M	High Speed Steel	5	0038548111049

Hole sizes: 13

- Diameter: 5mm–35mm in 2mm–3mm increments
- Step thickness: 3.5mm
- Shank diameter: 13mm
- Designed to drill fast, perfectly round knock-out holes

Product Code	Reference #	Bit Finish	Shelf Pack	Barcode
16105	#5MT	Titanium Nitride	5	0038548161051
11105	#5M	High Speed Steel	5	0038548111056

Single Hole Step Drill Bits - Single Flute

Single Hole Bits - Imperial

Hole size: 1/2"

- Shank diameter: 1/4"
- Creates 1/2" holes without centre punching or pilot holes.

Product Code	Reference #	Bit Finish	Shelf Pack	Barcode
10310	#10	High Speed Steel	5	0038548103105

Hole size: 7/8"

- Shank diameter: 3/8"
- Creates 7/8" knockouts quickly and easily. Especially suitable for making draw bolt holes for large knockouts and miniature pilot light holes

Product Code	Reference #	Bit Finish	Shelf Pack	Barcode
10311	#11	High Speed Steel	5	0038548103112

Hole size: 1 1/8"

- Shank diameter: 1/2"
- Fastest, easiest method of drilling perfect knock-outs for 3/4" conduit

Product Code	Reference #	Bit Finish	Shelf Pack	Barcode
10313	#13	High Speed Steel	1	0038548103136





Hole Enlarging Bits

Hole Enlarging Bits - Imperial

Hole sizes: 8



- Diameter 9/16"–1" diameter in 1/16" increments
- Step thickness: 1/8"
- Shank diameter: 1/2"
- Companion to IRWIN Unibit 10231.
- Extends diameter range from 1/8"–1", handling 99% of most common holes with just two bits
- Requires 1/2" or larger pilot hole

Product Code	Reference #	Bit Finish	Shelf Pack	Barcode
10220	#20	High Speed Steel	5	038548102207

Hole sizes: 10



- Diameter 13/16"–1 3/8" diameter in 1/16" increments
- Step thickness: 1/8"
- Shank diameter: 1/2"
- Perfect for reaming, deburring or enlarging medium-sized holes quickly
- Companion to IRWIN Unibit 10233
- Extends range from 1/4"–1 3/8"
- Requires 3/4" or larger pilot hole

Product Code	Reference #	Bit Finish	Shelf Pack	Barcode
10221	#21	High Speed Steel	5	038548102214

Hole Enlarging Bits - Metric

Hole sizes: 6



- Diameter: 14mm–24mm in 2mm increments
- Step thickness: 5mm
- Shank diameter: 13mm
- Companion to IRWIN Unibit 11101
- Extends diameter range from 4mm–24mm
- Requires 12mm or larger pilot hole

Product Code	Reference #	Bit Finish	Shelf Pack	Barcode
11580	#20M	High Speed Steel	5	038548112206

Hole sizes: 8



- Diameter: 20mm–34mm in 2mm increments
- Step thickness: 5mm
- Shank diameter: 13mm
- Companion to IRWIN Unibit 11103
- Extends diameter range from 6mm–34mm
- Perfect for reaming, deburring or enlarging medium-sized holes
- Requires 18mm or larger pilot hole

Product Code	Reference #	Bit Finish	Shelf Pack	Barcode
11581	#21M	High Speed Steel	1	038548112211

FALCON NIBBLER

1. Durable high quality, all metal construction
2. Universal attachment fits any power drill (electric or air)
3. Cuts cleanly without distortion

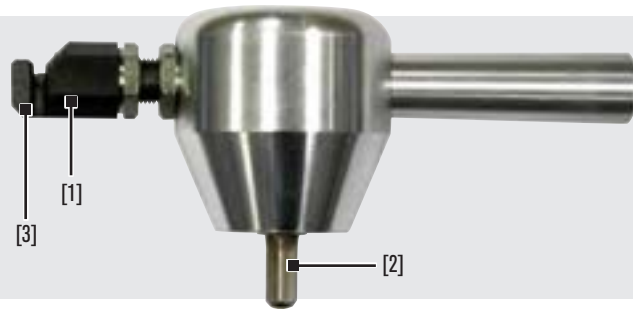

Nibbler Drill Attachment

- Provides a fast and clean method for cutting sheet metals, plastics and laminates – flat or corrugated
- Directional cutting – cuts curves or straight, even in corrugated sheet
- Width of cut: 3mm (1/8")
- Maximum gauge: mild steel 1.5mm (16 swg), aluminium etc 2mm (14 swg)

Product Code	Description	Shelf Pack	Barcode
FN	Drill Attachment Standard	1	931424400025

Nibbler Replacement Punch & Die Set

Product Code	Description	Shelf Pack	Barcode
FNDP	Replacement Punch & Die Set	1	931424400056

High Speed Steel Drill Anatomy

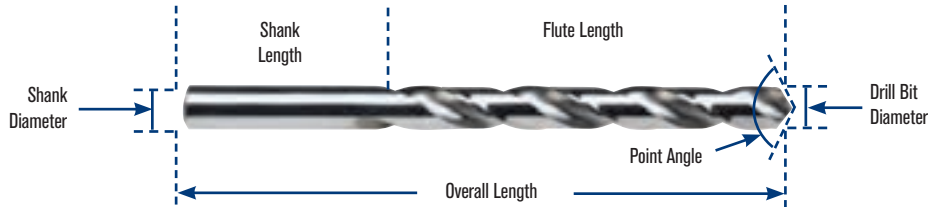

Overall Length: The length from the point to the end of the drill bit

Point Angle: The angle of the cutting edges

Drill Diameter: The cutting diameter of the drill bit

Shank Length: The end of the drill bit that is secured by the drill

Flute Length: The length from the point to the end of the flutes

Tip Geometry

118° Conventional Point

- General use
- Not self-centering
- Best used with Stationary Drills
- Performs better in softer materials than hard metal

118° Point Angle

135° Split Point

- Self-centering (won't "walk")
- Best used with Portable Drills
- Requires less force than 118°

135° Point Angle

Drill Bit Selection

Material	High Speed Steel	Cobalt
	118°	135°
Wood/Plaster	●	●
Sheet Metal	●	●
Mild Steel	●	●
High Alloy Steels	●	●
Stainless Steel	●	●
Cast Iron	●	●
Aluminium, Brass & Copper	●	●
Plastic	●	●

Key: ● Recommended ● Acceptable ● Not Recommended

HIGH SPEED STEEL BITS

High Speed Steel

1. Standard 118° point tip for general use
2. Constructed from W-9 high speed steel for the best combination of strength, heat resistance and wear resistance

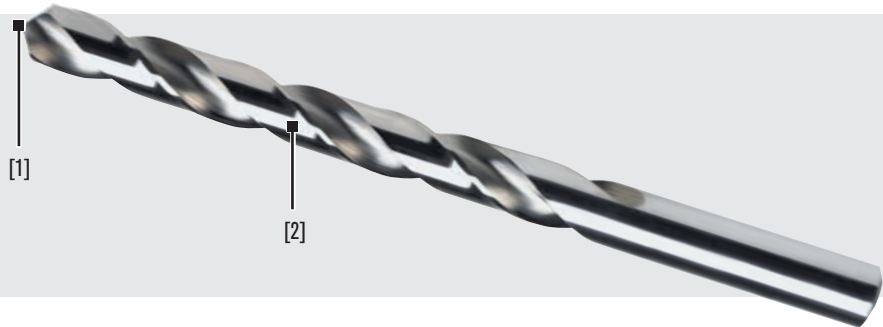

High Speed Steel Carded Stock - Metric

- General purpose use

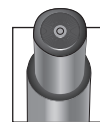

Reduced Shank:

Available on drill bits 10.5mm and above.

Suitable for use in 10mm drill chucks.



Product Code	Description	Diameter (mm)	Decimal Equivalent	Overall Length (mm)	Flute Length (mm)	Barcode
BRT0010ME	High Speed Steel 1.00mm	1.00	-	34	12	9314244005662
BRT0015ME	High Speed Steel 1.50mm	1.50	-	40	18	9314244005679
BRT0020ME	High Speed Steel 2.00mm	2.00	-	49	24	9314244005686
BRT0025ME	High Speed Steel 2.50mm	2.50	-	57	30	9314244005693
BRT0030ME	High Speed Steel 3.00mm	3.00	-	61	33	9314244005709
BRT0035ME	High Speed Steel 3.50mm	3.50	-	70	39	9314244005716
BRT0040ME	High Speed Steel 4.00mm	4.00	-	75	43	9314244005723
BRT0045ME	High Speed Steel 4.50mm	4.50	-	80	47	9314244005730
BRT0050ME	High Speed Steel 5.00mm	5.00	-	86	52	9314244005747
BRT0055ME	High Speed Steel 5.50mm	5.50	-	93	57	9314244005754
BRT0060ME	High Speed Steel 6.00mm	6.00	-	93	57	9314244005761
BRT0065ME	High Speed Steel 6.50mm	6.50	-	101	63	9314244005778
BRT0070ME	High Speed Steel 7.00mm	7.00	-	109	69	9314244005785
BRT0075ME	High Speed Steel 7.50mm	7.50	-	109	69	9314244005792
BRT0080ME	High Speed Steel 8.00mm	8.00	-	117	75	9314244005808
BRT0085ME	High Speed Steel 8.50mm	8.50	-	117	75	9314244005815
BRT0090ME	High Speed Steel 9.00mm	9.00	-	125	81	9314244005822
BRT0095ME	High Speed Steel 9.50mm	9.50	-	125	81	9314244005839
BRT0100ME	High Speed Steel 10.00mm	10.00	-	133	87	9314244005846
BRT0105ME	High Speed Steel 10.50mm #	10.50	-	133	87	9314244005853
BRT0110ME	High Speed Steel 11.00mm #	11.00	-	142	94	9314244005860
BRT0115ME	High Speed Steel 11.50mm #	11.50	-	142	94	9314244005877
BRT0120ME	High Speed Steel 12.00mm #	12.00	-	151	101	9314244005884
BRT0125ME	High Speed Steel 12.50mm #	12.50	-	151	101	9314244005891
BRT0130ME	High Speed Steel 13.00mm #	13.00	-	160	108	9314244005907

Reduced Shank (10mm)

High Speed Steel (continued)

High Speed Steel Carded Stock - Imperial

- General purpose use
- Standard 118° point
- Constructed from W-9 high speed steel for the best combination of strength, heat resistance and wear resistance

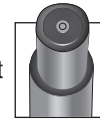

Reduced Shank:

Available on drill bits 25/64" and above.

Suitable for use in 3/8" drill chucks.



118° Point

Product Code	Description	Diameter (inches)	Decimal Equivalent	Overall Length (inches)	Flute Length (inches)	Barcode
BRT0116IM	High Speed Steel 1/16"	1/16	0.06	1-7/8	7/8	9314244005914
BRT0564IM	High Speed Steel 5/64"	5/64	0.08	2	1	9314244005921
BRT0332IM	High Speed Steel 3/32"	3/32	0.09	2-1/4	1-1/8	9314244005938
BRT0764IM	High Speed Steel 7/64"	7/64	0.11	2-5/8	1-1/2	9314244005945
BRT0018IM	High Speed Steel 1/8"	1/8	0.13	2-3/4	1-5/8	9314244005952
BRT0964IM	High Speed Steel 9/64"	9/64	0.14	2-7/8	1-3/4	9314244005969
BRT0532IM	High Speed Steel 5/32"	5/32	0.16	3-1/8	2	9314244005976
BRT1164IM	High Speed Steel 11/64"	11/64	0.17	3-1/4	2-1/8	9314244005983
BRT0316IM	High Speed Steel 3/16"	3/16	0.19	3-1/2	2-5/16	9314244005990
BRT1364IM	High Speed Steel 13/64"	13/64	0.20	3-5/8	2-7/16	9314244006003
BRT0732IM	High Speed Steel 7/32"	7/32	0.22	3-3/4	2-1/2	9314244006010
BRT1564IM	High Speed Steel 15/64"	15/64	0.23	3-7/8	2-5/8	9314244006027
BRT0014IM	High Speed Steel 1/4"	1/4	0.25	4	2-3/4	9314244006034
BRT1764IM	High Speed Steel 17/64"	17/64	0.27	17/64	2-7/8	9314244006041
BRT0932IM	High Speed Steel 9/32"	9/32	0.28	4-1/4	2-15/16	9314244006058
BRT1964IM	High Speed Steel 19/64"	19/64	0.30	4-3/8	3-1/16	9314244006065
BRT0516IM	High Speed Steel 5/16"	5/16	0.31	4-1/2	3-3/16	9314244006072
BRT2164IM	High Speed Steel 21/64"	21/64	0.33	4-5/8	3-5/16	9314244006089
BRT1132IM	High Speed Steel 11/32"	11/32	0.34	4-3/4	3-7/16	9314244006096
BRT2364IM	High Speed Steel 23/64"	23/64	0.36	4-7/8	3-1/2	9314244006102
BRT0038IM	High Speed Steel 3/8"	3/8	0.38	5	3-5/8	9314244006119
BRT2564IM	High Speed Steel 25/64" #	25/64	0.39	5-1/8	3-3/4	9314244006126
BRT1332IM	High Speed Steel 13/32" #	13/32	0.41	5-1/4	3-7/8	9314244006133
BRT2764IM	High Speed Steel 27/64" #	27/64	0.42	5-3/8	3-15/16	9314244006140
BRT0716IM	High Speed Steel 7/16" #	7/16	0.44	5-1/2	4-1/16	9314244006157
BRT2964IM	High Speed Steel 29/64" #	29/64	0.45	5-5/8	4-3/16	9314244006164
BRT1532IM	High Speed Steel 15/32" #	15/32	0.47	5-3/4	4-5/16	9314244006171
BRT3164IM	High Speed Steel 31/64" #	31/64	0.48	5-7/8	4-3/8	9314244006188
BRT0012IM	High Speed Steel 1/2" #	1/2	0.50	6	4-1/2	9314244006195

Reduced Shank (3/8")

High Speed Steel Bulk Stock - Metric

- General purpose use
- Standard 118° point
- Constructed from W-9 high speed steel for the best combination of strength, heat resistance and wear resistance

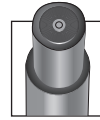

Reduced Shank:

Available on drill bits 10.5mm and above.

Suitable for use in 10mm drill chucks.



118° Point



Product Code	Description	Diameter (mm)	Decimal Equivalent	Overall Length (mm)	Flute Length (mm)	Barcode
B10010ME*	High Speed Steel 1.00mm	1.00	-	34	12	9314244007826
B10015ME*	High Speed Steel 1.50mm	1.50	-	40	18	9314244007833
B10020ME*	High Speed Steel 2.00mm	2.00	-	49	24	9314244007840
B10025ME*	High Speed Steel 2.50mm	2.50	-	57	30	9314244007857
B10030ME*	High Speed Steel 3.00mm	3.00	-	61	33	9314244007864
B10035ME*	High Speed Steel 3.50mm	3.50	-	70	39	9314244007871
B10040ME*	High Speed Steel 4.00mm	4.00	-	75	43	9314244007888
B10045ME*	High Speed Steel 4.50mm	4.50	-	80	47	9314244007895
B10050ME*	High Speed Steel 5.00mm	5.00	-	86	52	9314244007901
B10055ME*	High Speed Steel 5.50mm	5.50	-	93	57	9314244007918
B10060ME*	High Speed Steel 6.00mm	6.00	-	93	57	9314244007925
B10065ME*	High Speed Steel 6.50mm	6.50	-	101	63	9314244007932
B5070ME**	High Speed Steel 7.00mm	7.00	-	109	69	9314244007949
B5075ME**	High Speed Steel 7.50mm	7.50	-	109	69	9314244007956
B5080ME**	High Speed Steel 8.00mm	8.00	-	117	75	9314244007963
B5085ME**	High Speed Steel 8.50mm	8.50	-	117	75	9314244007970
B5090ME**	High Speed Steel 9.00mm	9.00	-	125	81	9314244007987
B5095ME**	High Speed Steel 9.50mm	9.50	-	125	81	9314244007994
B5100ME**	High Speed Steel 10.00mm	10.00	-	133	87	9314244008007
B5105ME**	High Speed Steel 10.50mm #	10.50	-	133	87	9314244008014
B5110ME**	High Speed Steel 11.00mm #	11.00	-	142	94	9314244008021
B5115ME**	High Speed Steel 11.50mm #	11.50	-	142	94	9314244008038
B5120ME**	High Speed Steel 12.00mm #	12.00	-	151	101	9314244008045
B5125ME**	High Speed Steel 12.50mm #	12.50	-	151	101	9314244008052
B5130ME**	High Speed Steel 13.00mm #	13.00	-	160	108	9314244008069

*Bulk Pack 10 **Bulk Pack 5 # Reduced Shank (10mm)

High Speed Steel (continued)

High Speed Steel Bulk Stock - Imperial

- General purpose use
- Standard 118° point
- Constructed from W-9 high speed steel for the best combination of strength, heat resistance and wear resistance

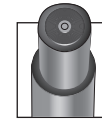

Reduced Shank:

Available on drill bits 25/64" and above.

Suitable for use in 3/8" drill chucks.



118° Point

Product Code	Description	Diameter (inches)	Decimal Equivalent	Overall Length (inches)	Flute Length (mm)	Barcode
B100164IM*	High Speed Steel 1/64"	1/64	0.40	3/4	3/16	9314244008076
B100132IM*	High Speed Steel 1/32"	1/32	0.79	1-3/8	1/2	9314244008083
B100364IM*	High Speed Steel 3/64"	3/64	1.19	1-3/4	3/4	9314244008090
B100116IM*	High Speed Steel 1/16"	1/16	0.06	1-7/8	7/8	9314244008106
B100564IM*	High Speed Steel 5/64"	5/64	0.08	2	1	9314244008113
B100332IM*	High Speed Steel 3/32"	3/32	0.09	2-1/4	1-1/8	9314244008120
B100764IM*	High Speed Steel 7/64"	7/64	0.11	2-5/8	1-1/2	9314244008137
B100018IM*	High Speed Steel 1/8"	1/8	0.13	2-3/4	1-5/8	9314244008144
B100964IM*	High Speed Steel 9/64"	9/64	0.14	2-7/8	1-3/4	9314244008151
B100532IM*	High Speed Steel 5/32"	5/32	0.16	3-1/8	2	9314244008168
B101164IM*	High Speed Steel 11/64"	11/64	0.17	3-1/4	2-1/8	9314244008175
B100316IM*	High Speed Steel 3/16"	3/16	0.19	3-1/2	2-5/16	9314244008182
B101364IM*	High Speed Steel 13/64"	13/64	0.20	3-5/8	2-7/16	9314244008199
B100732IM*	High Speed Steel 7/32"	7/32	0.22	3-3/4	2-1/2	9314244008205
B101564IM*	High Speed Steel 15/64"	15/64	0.23	3-7/8	2-5/8	9314244008212
B100014IM*	High Speed Steel 1/4"	1/4	0.25	4	2-3/4	9314244008229
B51764IM**	High Speed Steel 17/64"	17/64	0.27	17/64	2-7/8	9314244008236
B50932IM**	High Speed Steel 9/32"	9/32	0.28	4-1/4	2-15/16	9314244008243
B51964IM**	High Speed Steel 19/64"	19/64	0.30	4-3/8	3-1/16	9314244008250
B50516IM**	High Speed Steel 5/16"	5/16	0.31	4-1/2	3-3/16	9314244008267
B52164IM**	High Speed Steel 21/64"	21/64	0.33	4-5/8	3-5/16	9314244008274
B51132IM**	High Speed Steel 11/32"	11/32	0.34	4-3/4	3-7/16	9314244008281
B52364IM**	High Speed Steel 23/64"	23/64	0.36	4-7/8	3-1/2	9314244008298
B50038IM**	High Speed Steel 3/8"	3/8	0.38	5	3-5/8	9314244008304
B52564IM**	High Speed Steel 25/64" #	25/64	0.39	5-1/8	3-3/4	9314244008311
B51332IM**	High Speed Steel 13/32" #	13/32	0.41	5-1/4	3-7/8	9314244008328
B52764IM**	High Speed Steel 27/64" #	27/64	0.42	5-3/8	3-15/16	9314244008335
B50716IM**	High Speed Steel 7/16" #	7/16	0.44	5-1/2	4-1/16	9314244008342
B52964IM**	High Speed Steel 29/64" #	29/64	0.45	5-5/8	4-3/16	9314244008359
B51532IM**	High Speed Steel 15/32" #	15/32	0.47	5-3/4	4-5/16	9314244008366
B53164IM**	High Speed Steel 31/64" #	31/64	0.48	5-7/8	4-3/8	9314244008373
B50012IM**	High Speed Steel 1/2" #	1/2	0.50	6	4-1/2	9314244008380

*Bulk Pack 10 **Bulk Pack 5 # Reduced Shank (3/8")

Cobalt

Cobalt Carded Stock - Metric

- Constructed of M-35 High Speed Steel
- Contains five percent cobalt steel for super abrasive resistance in tough metals
- Heavy-duty web construction for strength and durability
- Heavy-duty spiral flute design produces faster chip ejection
- Shorter cutting lips reduce torque for drilling in high tensile strength materials
- 135° split point allows drilling to start on contact, minimising bit 'walk' and reduces feed pressure for easier penetration

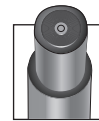

Reduced Shank:

Available on drill bits 10.5mm and above.

Suitable for use in 10mm drill chucks.



Product Code	Description	Diameter (mm)	Decimal Equivalent	Overall Length (mm)	Flute Length (mm)	Barcode
COB0010ME	Cobalt 1.00mm	1.00	-	34	12	9314244007284
COB0015ME	Cobalt 1.50mm	1.50	-	40	18	9314244007291
COB0020ME	Cobalt 2.00mm	2.00	-	49	24	9314244007307
COB0025ME	Cobalt 2.50mm	2.50	-	57	30	9314244007314
COB0030ME	Cobalt 3.00mm	3.00	-	61	33	9314244007321
COB0035ME	Cobalt 3.50mm	3.50	-	70	39	9314244007338
COB0040ME	Cobalt 4.00mm	4.00	-	75	43	9314244007345
COB0045ME	Cobalt 4.50mm	4.50	-	80	47	9314244007352
COB0050ME	Cobalt 5.00mm	5.00	-	86	52	9314244007369
COB0055ME	Cobalt 5.50mm	5.50	-	93	57	9314244007376
COB0060ME	Cobalt 6.00mm	6.00	-	93	57	9314244007383
COB0065ME	Cobalt 6.50mm	6.50	-	101	63	9314244007390
COB0070ME	Cobalt 7.00mm	7.00	-	109	69	9314244007406
COB0075ME	Cobalt 7.50mm	7.50	-	109	69	9314244007413
COB0080ME	Cobalt 8.00mm	8.00	-	117	75	9314244007420
COB0085ME	Cobalt 8.50mm	8.50	-	117	75	9314244007437
COB0090ME	Cobalt 9.00mm	9.00	-	125	81	9314244007444
COB0095ME	Cobalt 9.50mm	9.50	-	125	81	9314244007451
COB0100ME	Cobalt 10.00mm	10.00	-	133	87	9314244007468
COB0105ME	Cobalt 10.50mm #	10.50	-	133	87	9314244007475
COB0110ME	Cobalt 11.00mm #	11.00	-	142	94	9314244007482
COB0115ME	Cobalt 11.50mm #	11.50	-	142	94	9314244007499
COB0120ME	Cobalt 12.00mm #	12.00	-	151	101	9314244007505
COB0125ME	Cobalt 12.50mm #	12.50	-	151	101	9314244007512
COB0130ME	Cobalt 13.00mm #	13.00	-	160	108	9314244007529

Reduced Shank (10mm)

Cobalt (continued)

Cobalt Carded Stock - Imperial

- Constructed of M-35 High Speed Steel
- Contains five percent cobalt steel for super abrasive resistance in tough metals
- Heavy-duty web construction for strength and durability
- Heavy-duty spiral flute design produces faster chip ejection
- Shorter cutting lips reduce torque for drilling in high tensile strength materials
- 135° split point allows drilling to start on contact, minimising bit walking and reduces feed pressure for easier penetration.

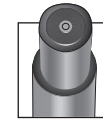

Reduced Shank:

Available on drill bits 25/64" and above.

Suitable for use in 3/8" drill chucks.



135° Split Point
Starts on contact

Product Code	Description	Diameter (inches)	Decimal Equivalent	Overall Length (inches)	Flute Length (inches)	Barcode
COB0116IM	Cobalt 1/16"	1/16	0.06	1-7/8	7/8	9314244007536
COB0564IM	Cobalt 5/64"	5/64	0.08	2	1	9314244007543
COB0332IM	Cobalt 3/32"	3/32	0.09	2-1/4	1-1/8	9314244007550
COB0764IM	Cobalt 7/64"	7/64	0.11	2-5/8	1-1/2	9314244007567
COB0018IM	Cobalt 1/8"	1/8	0.13	2-3/4	1-5/8	9314244007574
COB0964IM	Cobalt 9/64"	9/64	0.14	2-7/8	1-3/4	9314244007581
COB0532IM	Cobalt 5/32"	5/32	0.16	3-1/8	2	9314244007598
COB1164IM	Cobalt 11/64"	11/64	0.17	3-1/4	2-1/8	9314244007604
COB0316IM	Cobalt 3/16"	3/16	0.19	3-1/2	2-5/16	9314244007611
COB1364IM	Cobalt 13/64"	13/64	0.20	3-5/8	2-7/16	9314244007628
COB0732IM	Cobalt 7/32"	7/32	0.22	3-3/4	2-1/2	9314244007635
COB1564IM	Cobalt 15/64"	15/64	0.23	3-7/8	2-5/8	9314244007642
COB0014IM	Cobalt 1/4"	1/4	0.25	4	2-3/4	9314244007659
COB1764IM	Cobalt 17/64"	17/64	0.27	17/64	2-7/8	9314244007666
COB0932IM	Cobalt 9/32"	9/32	0.28	4-1/4	2-15/16	9314244007673
COB1964IM	Cobalt 19/64"	19/64	0.30	4-3/8	3-1/16	9314244007680
COB0516IM	Cobalt 5/16"	5/16	0.31	4-1/2	3-3/16	9314244007697
COB2164IM	Cobalt 21/64"	21/64	0.33	4-5/8	3-5/16	9314244007703
COB1132IM	Cobalt 11/32"	11/32	0.34	4-3/4	3-7/16	9314244007710
COB2364IM	Cobalt 23/64"	23/64	0.36	4-7/8	3-1/2	9314244007727
COB0038IM	Cobalt 3/8"	3/8	0.38	5	3-5/8	9314244007734
COB2564IM	Cobalt 25/64" #	25/64	0.39	5-1/8	3-3/4	9314244007741
COB1332IM	Cobalt 13/32" #	13/32	0.41	5-1/4	3-7/8	9314244007758
COB2764IM	Cobalt 27/64" #	27/64	0.42	5-3/8	3-15/16	9314244007765
COB0716IM	Cobalt 7/16" #	7/16	0.44	5-1/2	4-1/16	9314244007772
COB2964IM	Cobalt 29/64" #	29/64	0.45	5-5/8	4-3/16	9314244007789
COB1532IM	Cobalt 15/32" #	15/32	0.47	5-3/4	4-5/16	9314244007796
COB3164IM	Cobalt 31/64" #	31/64	0.48	5-7/8	4-3/8	9314244007802
COB0012IM	Cobalt 1/2" #	1/2	0.50	6	4-1/2	9314244007819

Reduced Shank (3/8")

Long Series

6" (152mm) Long Series - Metric

- Black Oxide finish for corrosion resistance
- Heavy-duty web construction for strength and durability
- Ideal for drilling in hard-to-reach areas and for running wires and cables
- Constructed of W-9 high speed steel for the best combination of strength, heat resistance and wear resistance
- 135° split point ensures a true start and eliminates bit walking
- Long Aircraft series available in 152mm overall length

Product Code	Description	Diameter (mm)	Decimal Equivalent	Overall Length (mm)	Flute Length (mm)	Barcode
A60015ME	152mm Long Series 1.50mm	1.50	-	152	18	9314244008397
A60020ME	152mm Long Series 2.00mm	2.00	-	152	24	9314244008403
A60025ME	152mm Long Series 2.50mm	2.50	-	152	30	9314244008410
A60030ME	152mm Long Series 3.00mm	3.00	-	152	33	9314244008427
A60035ME	152mm Long Series 3.50mm	3.50	-	152	39	9314244008434
A60040ME	152mm Long Series 4.00mm	4.00	-	152	43	9314244008441
A60045ME	152mm Long Series 4.50mm	4.50	-	152	47	9314244008458
A60050ME	152mm Long Series 5.00mm	5.00	-	152	52	9314244008465
A60055ME	152mm Long Series 5.50mm	5.50	-	152	57	9314244008472
A60060ME	152mm Long Series 6.00mm	6.00	-	152	57	9314244008489
A60065ME	152mm Long Series 6.50mm	6.50	-	152	63	9314244008496
A60070ME	152mm Long Series 7.00mm	7.00	-	152	69	9314244008502
A60075ME	152mm Long Series 7.50mm	7.50	-	152	69	9314244008519
A60080ME	152mm Long Series 8.00mm	8.00	-	152	75	9314244008526
A60085ME	152mm Long Series 8.50mm	8.50	-	152	75	9314244008533
A60090ME	152mm Long Series 9.00mm	9.00	-	152	81	9314244008540
A60095ME	152mm Long Series 9.50mm	9.50	-	152	81	9314244008557
A60100ME	152mm Long Series 10.00mm	10.00	-	152	87	9314244008564





Extra Long Series

12" (305mm) Extra Long Series - Metric

- Black Oxide finish for corrosion resistance
- Heavy-duty web construction for strength and durability
- Ideal for drilling in hard-to-reach areas and for running wires and cables
- Constructed of W-9 high speed steel for the best combination of strength, heat resistance and wear resistance
- 135° split point ensures a true start and eliminates bit walking
- Extra Long Aircraft series available in 305mm overall length

Product Code	Description	Diameter (mm)	Decimal Equivalent	Overall Length (mm)	Flute Length (mm)	Barcode
A12020ME	305mm Extra Long Series 2.00mm	2.00	-	305	24	9314244008922
A12030ME	305mm Extra Long Series 3.00mm	3.00	-	305	33	9314244008939
A12040ME	305mm Extra Long Series 4.00mm	4.00	-	305	43	9314244008946
A12050ME	305mm Extra Long Series 5.00mm	5.00	-	305	52	9314244008953
A12060ME	305mm Extra Long Series 6.00mm	6.00	-	305	57	9314244008960
A12070ME	305mm Extra Long Series 7.00mm	7.00	-	305	69	9314244008977
A12080ME	305mm Extra Long Series 8.00mm	8.00	-	305	75	9314244008984
A12090ME	305mm Extra Long Series 9.00mm	9.00	-	305	81	9314244008991
A12100ME	305mm Extra Long Series 10.00mm	10.00	-	305	87	9314244009004
A12110ME	305mm Extra Long Series 11.00mm	11.00	-	305	94	9314244009011
A12120ME	305mm Extra Long Series 12.00mm	12.00	-	305	101	9314244009028
A12130ME	305mm Extra Long Series 13.00mm	13.00	-	305	108	9314244009035

Single & Double Ended Series

Double Ended Bright

- Designed for sheet steel
- Constructed of W-9 high speed steel for the best combination of strength, heat resistance and wear resistance
- Heavy-duty web for strength and durability
- 135° split point ensures a true start and eliminates bit walking



Product Code	Description	Size	Decimal Equivalent	Overall Length (mm)	Flute Length (mm)	Barcode
DE0182PKB	Double Ended 1/8" 2pk	1/8"	3.00	49	12.00	9314244012738
DE0302PKB	Double Ended #30 2pk	#30	3.20	49	12.00	9314244012745
DE0202PKB	Double Ended #20 2pk	#20	4.00	55	14.00	9314244012752
DE0112PKB	Double Ended #11 2pk	#11	4.80	62	17.50	9314244012769
DE01810BB	Double Ended 1/8" 10pk	1/8"	3.00	49	12.00	9314244012776
DE03010BB	Double Ended #30 10pk	#30	3.20	49	12.00	9314244012783
DE02010BB	Double Ended #20 10pk	#20	4.00	55	14.00	9314244012790
DE01110BB	Double Ended #11 10pk	#11	4.80	62	17.50	9314244012806
DE01810EB	Double Ended 1/8" Bulk 10	1/8"	3.00	49	12.00	9314244012813
DE03010EB	Double Ended #30 Bulk 10	#30	3.20	49	12.00	9314244012820
DE02010EB	Double Ended #20 Bulk 10	#20	4.00	55	14.00	9314244012837
DE01110EB	Double Ended #11 Bulk 10	#11	4.80	62	17.50	9314244012844

Single Ended Bright

- Designed for sheet steel
- Constructed of W-9 high speed steel for the best combination of strength, heat resistance and wear resistance
- Heavy-duty web for strength and durability
- 135° split point ensures a true start and eliminates bit walking

Product Code	Description	Size	Decimal Equivalent	Overall Length (mm)	Flute Length (mm)	Barcode
SE0182PKB	Single Ended 1/8" 2pk	1/8"	3.00	49	12.00	9314244012653
SE0302PKB	Single Ended #30 2pk	#30	3.20	49	12.00	9314244012660
SE0202PKB	Single Ended #20 2pk	#20	4.00	55	14.00	9314244012677
SE0112PKB	Single Ended #11 2pk	#11	4.80	62	17.50	9314244012684
SE01810BB	Single Ended 1/8" Pouch 10pk	1/8"	3.00	49	12.00	9314244012691
SE03010BB	Single Ended #30 Pouch 10pk	#30	3.20	49	12.00	9314244012707
SE02010BB	Single Ended #20 Pouch 10pk	#20	4.00	55	14.00	9314244012714
SE01110BB	Single Ended #11 Pouch 10pk	#11	4.80	62	17.50	9314244012721



Glass & Tile

- Tungsten Carbide tip for longer life
- Spear point allows precision
- Best used at slow speed with coolant

Product Code	Description	Diameter (mm)	Barcode
GT0030ME	Glass & Tile 3.00mm	3	9314244009325
GT0040ME	Glass & Tile 4.00mm	4	9314244009332
GT0050ME	Glass & Tile 5.00mm	5	9314244009349
GT0060ME	Glass & Tile 6.00mm	6	9314244009356
GT0080ME	Glass & Tile 8.00mm	8	9314244009363
GT0100ME	Glass & Tile 10.00mm	10	9314244009370
GT0120ME	Glass & Tile 12.00mm	12	9314244009387

Note: Not suitable for use on toughened glass or porcelain



Silver & Deming

Silver & Deming Reduced Shank - Metric

- Standard 118° point
- Constructed from W-9 high speed steel for high resistance to abrasion during tough drilling applications
- For use in 1/2" drill chucks
- Three-flatted shank design provides better chuck grip and reduces slippage



118° Point

Product Code	Description	Diameter (mm)	Overall Length (mm)	Flute Length (mm)	Barcode
SD0135ME	Silver & Deming Reduced Shank 13.50mm	13.50	152	76	9314244009394
SD0140ME	Silver & Deming Reduced Shank 14.00mm	14.00	152	76	9314244009400
SD0145ME	Silver & Deming Reduced Shank 14.50mm	14.50	152	76	9314244009417
SD0150ME	Silver & Deming Reduced Shank 15.00mm	15.00	152	76	9314244009424
SD0155ME	Silver & Deming Reduced Shank 15.50mm	15.50	152	76	9314244009431
SD0160ME	Silver & Deming Reduced Shank 16.00mm	16.00	152	76	9314244009448
SD0165ME	Silver & Deming Reduced Shank 16.50mm	16.50	152	76	9314244009455
SD0170ME	Silver & Deming Reduced Shank 17.00mm	17.00	152	76	9314244009462
SD0175ME	Silver & Deming Reduced Shank 17.50mm	17.50	152	76	9314244009479
SD0180ME	Silver & Deming Reduced Shank 18.00mm	18.00	152	76	9314244009486
SD0185ME	Silver & Deming Reduced Shank 18.50mm	18.50	152	76	9314244009493
SD0190ME	Silver & Deming Reduced Shank 19.00mm	19.00	152	76	9314244009509
SD0195ME	Silver & Deming Reduced Shank 19.50mm	19.50	152	76	9314244009516
SD0200ME	Silver & Deming Reduced Shank 20.00mm	20.00	152	76	9314244009523
SD0205ME	Silver & Deming Reduced Shank 20.50mm	20.50	152	76	9314244009530
SD0210ME	Silver & Deming Reduced Shank 21.00mm	21.00	152	76	9314244009547
SD0215ME	Silver & Deming Reduced Shank 21.50mm	21.50	152	76	9314244009554
SD0220ME	Silver & Deming Reduced Shank 22.00mm	22.00	152	76	9314244009561
SD0225ME	Silver & Deming Reduced Shank 22.50mm	22.50	152	76	9314244009578
SD0230ME	Silver & Deming Reduced Shank 23.00mm	23.00	152	76	9314244009585
SD0235ME	Silver & Deming Reduced Shank 23.50mm	23.50	152	76	9314244009592
SD0240ME	Silver & Deming Reduced Shank 24.00mm	24.00	152	76	9314244009608
SD0245ME	Silver & Deming Reduced Shank 24.50mm	24.50	152	76	9314244009615
SD0250ME	Silver & Deming Reduced Shank 25.00mm	25.00	152	76	9314244009622
SD0260ME	Silver & Deming Reduced Shank 26.00mm	26.00	152	76	9314244009639
SD0280ME	Silver & Deming Reduced Shank 28.00mm	28.00	152	76	9314244009646
SD0300ME	Silver & Deming Reduced Shank 30.00mm	30.00	152	76	9314244009653

Silver & Deming Reduced Shank - Imperial

- Standard 118° point
- Constructed from W-9 high speed steel for high resistance to abrasion during tough drilling applications
- For use in 1/2" drill chucks
- Three-fluted shank design provides better chuck grip and reduces slippage

Product Code	Description	Diameter (inches)	Dec Equiv	Overall Length (inches)	Flute Length (inches)	Barcode
SD017321M	Silver & Deming Reduced Shank 17/32"	17/32	0.53	6	3	9314244009677
SD035641M	Silver & Deming Reduced Shank 35/64"	35/64	0.55	6	3	9314244009684
SD009161M	Silver & Deming Reduced Shank 9/16"	9/16	0.56	6	3	9314244009691
SD037641M	Silver & Deming Reduced Shank 37/64"	37/64	0.58	6	3	9314244009707
SD019321M	Silver & Deming Reduced Shank 19/32"	19/32	0.59	6	3	9314244009714
SD039641M	Silver & Deming Reduced Shank 39/64"	39/64	0.61	6	3	9314244009721
SD000581M	Silver & Deming Reduced Shank 5/8"	5/8	0.63	6	3	9314244009738
SD041641M	Silver & Deming Reduced Shank 41/64"	41/64	0.64	6	3	9314244009745
SD021321M	Silver & Deming Reduced Shank 21/32"	21/32	0.66	6	3	9314244009752
SD043641M	Silver & Deming Reduced Shank 43/64"	43/64	0.67	6	3	9314244009769
SD011161M	Silver & Deming Reduced Shank 11/16"	11/16	0.69	6	3	9314244009776
SD045641M	Silver & Deming Reduced Shank 45/64"	45/64	0.70	6	3	9314244009783
SD023321M	Silver & Deming Reduced Shank 23/32"	23/32	0.72	6	3	9314244009790
SD047641M	Silver & Deming Reduced Shank 47/64"	47/64	0.73	6	3	9314244009806
SD000341M	Silver & Deming Reduced Shank 3/4"	3/4	0.75	6	3	9314244009813
SD049641M	Silver & Deming Reduced Shank 49/64"	49/64	0.77	6	3	9314244009820
SD025321M	Silver & Deming Reduced Shank 25/32"	25/32	0.78	6	3	9314244009837
SD051641M	Silver & Deming Reduced Shank 51/64"	51/64	0.80	6	3	9314244009844
SD013161M	Silver & Deming Reduced Shank 13/16"	13/16	0.81	6	3	9314244009851
SD053641M	Silver & Deming Reduced Shank 53/64"	53/64	0.83	6	3	9314244009868
SD027321M	Silver & Deming Reduced Shank 27/32"	27/32	0.84	6	3	9314244009875
SD055641M	Silver & Deming Reduced Shank 55/64"	55/64	0.86	6	3	9314244009882
SD000781M	Silver & Deming Reduced Shank 7/8"	7/8	0.88	6	3	9314244009899
SD057641M	Silver & Deming Reduced Shank 57/64"	57/64	0.89	6	3	9314244009905
SD029321M	Silver & Deming Reduced Shank 29/32"	29/32	0.91	6	3	9314244009912
SD059641M	Silver & Deming Reduced Shank 59/64"	59/64	0.92	6	3	9314244009929
SD015161M	Silver & Deming Reduced Shank 15/16"	15/16	0.94	6	3	9314244009936
SD061641M	Silver & Deming Reduced Shank 61/64"	61/64	0.95	6	3	9314244009943
SD031321M	Silver & Deming Reduced Shank 31/32"	31/32	0.97	6	3	9314244009950
SD063641M	Silver & Deming Reduced Shank 63/64"	63/64	0.98	6	3	9314244009967
SD100001M	Silver & Deming Reduced Shank 1"	1	1.11	6	3	9314244009974
SD101641M	Silver & Deming Reduced Shank 1-1/64"	1-1/64	1.02	6	3	9314244009981
SD101321M	Silver & Deming Reduced Shank 1-1/32"	1-1/32	1.03	6	3	9314244009998
SD101161M	Silver & Deming Reduced Shank 1-1/16"	1-1/16	1.06	6	3	9314244010000
SD103321M	Silver & Deming Reduced Shank 1-3/32"	1-3/32	1.09	6	3	9314244010017





Metal Drilling Index Cases

- Three removable cartridges allow for easy transport to worksite
- Automatic indexing for easy bit access and identification
- Rubber overmoulded case protects metal casing if dropped

High Speed Steel Index Cases

Product Code	Description	Content	Finish	Barcode
BRT25ME3	25pc High Speed Steel Index Set Metric	25 pieces sized from 1.0mm to 13.0mm	Bright	9314244010116

Metal Drilling Pro Cases

- Durable hinged casing contains full length metal pin for maximum durability and life
- Moulded plastic case holds up to the rigours of daily use
- Secure latch to ensure pieces remain protected
- Easy to read label provides simple identification of set content

High Speed Steel Pro Cases

Product Code	Description	Content	Finish	Barcode
BRT15ME1	15pc High Speed Steel Pro-Case Metric	15 pieces sized from 1.5mm to 10.0mm	Bright	9314244010109
BRT15IM1	15pc High Speed Steel Pro-Case Imperial	15 pieces sized from 1/16" to 3/8"	Bright	9314244010123

Cobalt Pro Cases

Product Code	Description	Content	Finish	Barcode
COB15ME1	15pc Cobalt Pro-Case Metric	15 pieces sized from 1.5mm to 10.0mm	Cobalt	9314244010222
COB15IM1	15pc Cobalt Pro-Case Imperial	15 pieces sized from 1/16" to 3/8"	Cobalt	9314244010246

Metal Countersinks

- Precision ground 82° tip for countersinking most machinable metals, wood or plastic
- Made from industrial grade high speed steel for increased durability
- Includes a black oxide finish for added corrosion resistance
- Five flute design reduces vibration for smoother drilling and extended life
- 1/4" round shank fits all handheld and stationary drills

High Speed Steel Countersinks

Product Code	Bit Diameter	Overall Length	Flute Length	Barcode
Singles				
1877714	6.4mm (1/4")	38.9mm (1-17/32")	7.5mm (19/64")	042526917141
1877715	9.5mm (3/8")	41.3mm (1-5/8")	9.9mm (25/64")	042526917158
12411	12.7mm (1/2")	42mm (1-21/32")	11.9mm (15/32")	042526124112
12412	15.9mm (5/8")	43.7mm (1-23/32")	14.3mm (9/16")	042526124129
12413	19mm (3/4")	46mm (1-13/16")	15.9mm (5/8")	042526124136
Sets				
1877791	Set of 5 - (1/4", 3/8", 1/2", 5/8", 3/4")			042526917189



IRWIN®

Masonry Drilling











IRWIN TOOLS

Customer Service: 1800 331 491

128

Masonry Bit Selection Chart

	CORDLESS		MASONRY		PLUS		SPEED POWER HAMMER™	
	Suitable for all corded and cordless drills without hammer function		Suitable for all corded and cordless drills with hammer function		Suitable for all brands of SDS drills (including Hilti and Ramset)			
	 Straight Shank				 SDS Multi-Fit Shank (10mm)			
	4mm to 14mm		3mm to 26mm		4mm to 14mm		3mm to 26mm	
	Wall plug reference       							
Masonry & Brick	● ●	● ●	● ●	● ●	● ●	● ●	● ● ●	● ● ●
Concrete	● ●	● ●	● ●	● ●	● ●	● ●	● ● ●	● ● ●
Reinforced Concrete	●	● ●	● ●	● ●	● ●	● ●	● ● ●	● ● ●
Cement Block	● ●	● ●	● ●	● ●	● ●	● ●	● ● ●	● ● ●
Marble	● ● ●	● ●	● ●	● ●	● ●	● ●	● ● ●	● ● ●
Granite	● ● ●	● ●	● ●	● ●	● ●	● ●	● ● ●	● ● ●
Slate	● ● ●	●	●	●	●	●	●	●
Roof Tile	● ● ●	●	●	●	●	●	●	●
Ceramic Tile	● ● ●	●	●	●	×	×	×	×
Porcelain	×	×	×	×	×	×	×	×
Plastic/PVC	● ● ●	×	×	×	×	×	×	×
Thin Metals	● ● ●	×	×	×	×	×	×	×

Best ● ● ● Better ● ● Good ● Not Recommended ×

MASONRY DRILLING

SPEEDHAMMER™ SDS Bits

1. 2X more carbide and 2X more life and durability
2. Optimised tip design drills faster, especially in reinforced concrete
3. Maximised flute for greater dust and debris removal for faster drilling
4. Premium V4 steel - for superior core strength and longer life
5. Blue Band™ signifies SPEEDHAMMER™ POWER
6. SDS multi-fit shank fits all SDS drills

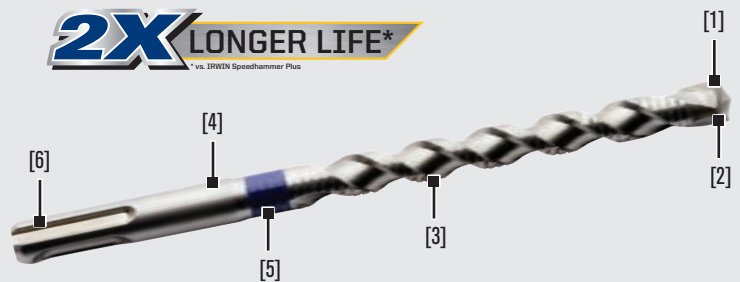

POWERS THROUGH REBAR

SPEEDHAMMER POWER Multi Fit Drill Bits

- More Carbide. More Life. MORE HOLES.
- SPEEDHAMMER POWER's unique 2-cutter tip design has 2X more carbide and is optimised for fast, continuous drilling through concrete and reinforced concrete, delivering superior performance and 2X longer life

Product Code	Diameter (mm)	Working Length	Overall Length	Shelf Pack	Barcode
10505000	5	50	110	10	9314244004689
10505001	5	100	160	10	9314244004696
10505002	5.5	50	110	10	9314244004702
10505003	5.5	100	160	10	9314244004719
10505004	6	50	110	10	9314244004726
10505005	6	100	160	10	9314244004733
10505006	6.5	50	110	10	9314244004740
10505007	6.5	100	160	10	9314244004757
10505008	7	100	160	10	9314244004764
10505009	8	100	160	10	9314244004771
10505010	8	150	210	10	9314244004788
10505011	10	50	110	10	9314244004795
10505012	10	100	160	10	9314244004801
10505013	10	150	210	10	9314244004818
10505014	12	100	160	10	9314244004825
10505015	12	200	260	10	9314244004832
10505016	12	400	460	10	9314244004849
10505017	14	150	210	10	9314244004856
10505018	16	100	160	10	9314244004863
10505019	16	150	210	10	9314244004870
10505020	18	150	210	5	9314244004887
10505021	20	240	300	5	9314244004894

* Compared to IRWIN SPEEDHAMMER PLUS

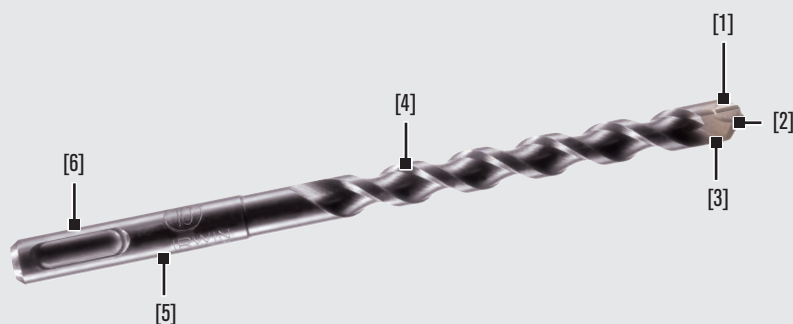

1. Tungsten carbide diamond-ground tip for faster drilling
2. Self centering tip for improved centering and cut
3. Extra short head ensures dust goes directly into flute for removal, reducing risk of clogging
4. Maximum flute capacity for fast removal of drilling dust, especially in green concrete
5. Fully hardened body made from chrome vanadium steel for maximum strength and longer life
6. SDS-Plus multi-fit shank for use with SDS-Plus, Hilti and Ramset R3 drills

SPEEDHAMMER PLUS Multi-Fit Drill Bits

Product Code	Diameter (mm)	Working Length	Overall Length	Shelf Pack	Barcode
10503025	5	50	110	10	5709131019701
10503026	5	100	160	10	5709131019909
10503027	5.5	50	110	10	5709131020189
10503028	5.5	100	160	10	5709131020318
10503029	6	50	110	10	5709131020677
10503030	6	100	160	10	5709131021018
10503031	6.5	50	110	10	5709131021285
10503032	6.5	100	160	10	5709131021476
10503033	6.5	150	210	10	5709131230267
10503696	6.5	340	400	10	5709131233527
10503036	7	100	160	10	5709131021858
10503037	8	50	110	10	5709131022176
10503038	8	100	160	10	5709131022626
10503039	8	150	210	10	5709131022879
10503041	10	75	135	10	5709131023685
10503042	10	100	160	10	5709131024019
10503043	10	150	210	10	5709131024293
10503698	10	400	460	10	5709131024729
10503046	12	100	160	10	5709131025412
10503048	12	170	230	10	5709131025665
10503700	12	400	460	10	5709131026006
10503051	13	170	230	10	5709131026402
10503054	14	150	210	10	5709131026822
10503055	14	200	260	10	5709131230298
10503058	16	100	160	5	5709131027812
10503059	16	150	210	5	5709131027928
10503060	16	240	300	5	5709131230311
10503703	16	400	460	5	5709131028260

SPEEDHAMMER PLUS Multi-Fit Drill Bits - continued

Product Code	Diameter (mm)	Working Length	Overall Length	Shelf Pack	Barcode
10503705	18	150	210	5	5709131028734
10503706	18	240	300	5	5709131243526
10503010	19	240	300	5	5709131029236
10503011	20	150	210	5	5709131029472
10503012	20	240	300	5	5709131029649
10503013	20	400	460	5	5709131029793
10503015	22	200	260	5	5709131229895
10503016	22	400	460	5	5709131030232
10503018	24	240	300	2	5709131030454
10503020	25	240	300	2	5709131030683
10503022	26	400	460	2	5709131230854
10503023	28	400	460	2	5709131230878
Sets					
105035PK	5pc Set (5, 6, 8, 10 & 12mm)			25	9314244004399
Bulk					
10507050	10pc Bulk Pack (5.0mm x 160mm)			30	9314244005136
10507060	10pc Bulk Pack (6.0mm x 160mm)			30	9314244005143
10507065	10pc Bulk Pack (6.5mm x 160mm)			30	9314244005150
10507080	5pc Bulk Pack (8.0mm x 160mm)			60	9314244005167
10507010	5pc Bulk Pack (10.0mm x 160mm)			50	9314244005174

IRWIN
joran®



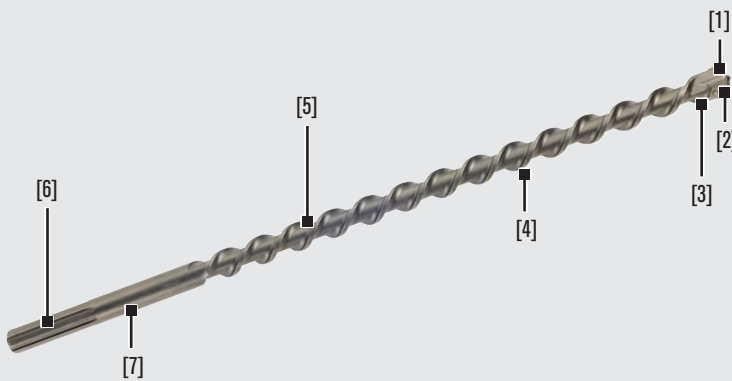

1. Tungsten carbide diamond-ground tip for faster drilling
2. 53° drilling head for 30% faster dust removal
3. Self centering tip for improved centering and cut
4. Maximum flute capacity for fast removal of drilling dust
5. Fully hardened body made from chrome vanadium steel for maximum strength and longer life
6. SDS-Max shank fits any drill with an SDS-Max tool holder
7. Shot peening and double tempering surface treatment provides extra strength and flexibility

SPEEDHAMMER MAX Drill Bits

Product Code	Diameter (mm)	Working Length	Overall Length	Shelf Pack	Barcode
Two Cutting Edges - Available on 12-15mm Diameter Drill Bits					
10502092	12	200	340	5	5709131233756
10502093	12	400	540	5	5709131233770
10502094	12	550	690	1	5709131233794
10502095	14	200	340	5	5709131233817
10502096	14	400	540	5	5709131233831
10502098	15	400	540	5	5709131233879
Four Cutting Edges - Available on 16-40mm Diameter Drill Bits					
10502099	16	200	340	5	5709131233893
10502100	16	400	540	5	5709131233916
10502101	18	200	340	5	5709131233930
10502102	18	400	540	5	5709131233954
10502103	20	200	320	5	5709131233978
10502104	20	400	520	5	5709131233992
10502105	20	800	920	1	5709131234012
10502106	22	200	320	5	5709131234036
10502107	22	400	520	5	5709131234050
10502109	24	200	320	2	5709131234098
10502110	24	400	520	2	5709131234111
10502112	25	400	520	2	5709131234159
10502113	25	800	920	1	5709131234173
10502115	28	250	370	2	5709131234197
10502116	28	450	570	2	5709131234210
10502119	30	450	570	2	5709131234272
10502121	32	450	570	2	5709131234319
10502124	35	450	570	2	5709131234364
10502127	38	450	570	1	5709131234401
10502129	40	450	570	1	5709131234425

Note: SDS-Max bits will not fit SDS-Plus machines and vice versa, without the use of an adapter

SPEEDHAMMER™ PLUS Demolition Chisels

Highest quality materials – produced from first-class alloyed steel and precision hardened for optimum performance and life

IRWIN
joran®



SPEEDHAMMER PLUS Demolition Chisels - Pointed

- For demolition and general chisel work in concrete and brickwork

Product Code	Size	Shelf Pack	Barcode
10502194	250mm long	1	5709131281979



SPEEDHAMMER PLUS Demolition Chisels - Flat

- For demolition and general chisel work in concrete and brickwork when more in-line cutting or trimming is required

Product Code	Size	Shelf Pack	Barcode
10502195	20mm x 250mm	1	5709131281986



SPEEDHAMMER PLUS Demolition Chisels - Spade

- For cutting softer materials (can be used in concrete). Requires a powerful hammer drill

Product Code	Size	Shelf Pack	Barcode
10502196	40mm x 250mm	1	5709131281993



SPEEDHAMMER™ MAX Demolition Chisels

Highest quality materials – produced from first-class alloyed steel and precision hardened for optimum performance and life



SPEEDHAMMER MAX Demolition Chisels - Pointed

- For demolition and general chisel work in concrete and brickwork

Product Code	Size	Shelf Pack	Barcode
10502185	400mm long	1	5709131281887



SPEEDHAMMER MAX Demolition Chisels - Flat

- For demolition and general chisel work in concrete and brickwork when more in-line cutting or trimming is required

Product Code	Size	Shelf Pack	Barcode
10502188	25mm x 400mm	1	570913281917



SPEEDHAMMER MAX Demolition Chisels - Spade

- For cutting softer materials (can be used in concrete)

Product Code	Size	Shelf Pack	Barcode
10502192	80mm x 300mm	1	5709131281955



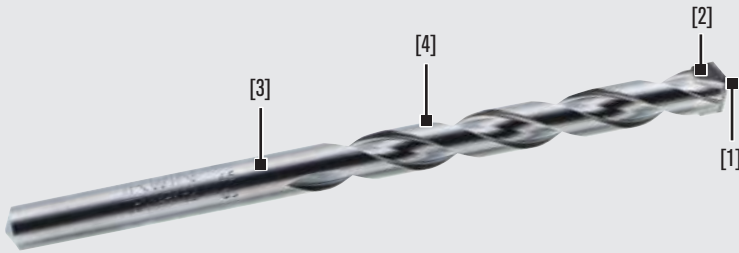

1. Tungsten carbide, diamond-ground tip for faster drilling
2. Ground single flute design for 60% faster removal of drilling dust
3. Fully hardened body made from chrome vanadium steel for maximum strength and longer life
4. Unique brazing process ensures a perfect bond between tip and body



Rotary Impact

Product Code	Diameter (mm)	Wall Plug	Length (mm)	Shank	Shelf Pack	Barcode
10501812	3	Yellow	70	Cyl	10	5709131000129
10501814	4	Yellow	80	Cyl	10	5709131055839
10501816	4.5	White	85	Cyl	10	5709131000488
10501817	5	White	90	Cyl	10	5709131055846
10501818	5	White	160	Cyl	10	5709131000778
10501819	5.5	Red	95	Cyl	10	5709131055853
10501820	5.5	Red	160	Cyl	10	5709131000952
10501821	6	Red	100	Cyl	10	5709131055860
10501822	6	Red	160	Cyl	10	5709131055877
10501824	6	Red	400	Cyl	10	5709131001249
10501826	6.5	Green	105	Cyl	10	5709131055884
10501827	6.5	Green	160	Cyl	10	5709131001461
10501829	6.5	Green	400	Cyl	10	5709131001546
10501830	7	Green	110	Cyl	10	5709131055891
10501834	8	Blue	120	Cyl	10	5709131055914
10501836	8	Blue	200	Cyl	10	5709131055921
10501838	8	Blue	400	Cyl	10	5709131002147
10501846	10	Orange	140	Cyl	10	5709131055938
10501847	10	Orange	160	Cyl	10	5709131002871
10501849	10	Orange	330	Cyl	10	5709131002963
10501850	10	Orange	400	Cyl	10	5709131002987
10501854	12	Grey	160	Cyl	10	5709131055952
10501855	12	Grey	330	Cyl	10	5709131003397
10501859	13	-	160	10mm	10	5709131003526
10501861	13	-	400	10mm	10	5709131003663
10501862	14	-	160	10mm	10	5709131055969
10501867	16	-	160	10mm	5	5709131003915
10501868	16	-	330	10mm	5	5709131003977
10501869	16	-	400	10mm	5	5709131003991
10501874	18	-	400	13mm	5	5709131004172
10501878	20	-	160	13mm	5	5709131004325
10501879	20	-	330	13mm	5	5709131004349
10501882	22	-	160	13mm	5	5709131004424
10501888	26	-	160	13mm	2	5709131004608
Sets						
10501893	7pc Set (4, 5, 6, 7, 8, 10 & 12mm)				8	5709131248149

CORDELESS

Straight Shank Drill Bits

IRWIN

joran®

1. Unique tungsten carbide tip design ensures faster drilling
2. Self centering tip for improved centering and cut
3. Ground single flute design for fast removal of dust at low RPM drilling (1200 RPM MAX)
4. Clean cut holes with minimal chipping
5. Fully hardened body made from chrome vanadium steel for maximum strength and longer life

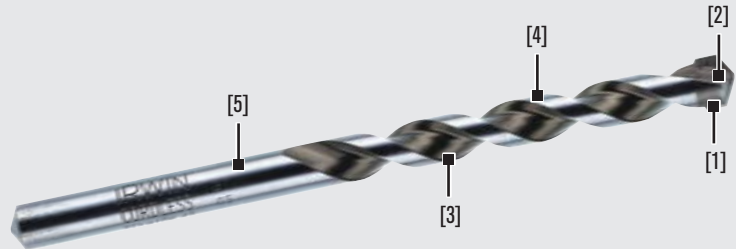

Cordless (Uni-Plus) Multipurpose Drill Bits

Product Code	Diameter (mm)	Wall Plug	Length (mm)	Shank	Shelf Pack	Barcode
10501921	4	Yellow	80	Cyl	10	5709131000303
10501922	5	White	90	Cyl	10	5709131000563
10501923	5.5	Red	95	Cyl	10	5709131000822
10501925	6	Red	100	Cyl	10	5709131000983
10501926	6	Red	160	Cyl	10	5709131001164
10501928	6.5	Green	105	Cyl	10	5709131001348
10501930	7	Green	110	Cyl	10	5709131001577
10501932	8	Blue	120	Cyl	10	5709131001836
10501934	10	Orange	140	Cyl	10	5709131002710
10501936	12	Grey	160	Cyl	10	5709131003267
10501937	14	-	160	10mm	10	5709131003717
Sets						
10501938	5pc Set (4, 5, 6, 8 & 10mm)				15	5709131247715

Note:
In cordless drills – can drill sheet metal up to approximately 1.5mm thick. Not recommended for drilling soft steel.
In drill presses – can drill short chipped materials like brass, cast iron and hardened steel.

User Tips

- Suitable for drilling tiles with a scratch hardness of up to eight
- Do not use in impact drilling mode
- A pilot hole is recommended when drilling holes greater than 6mm in diameter



IRWIN TOOLS





INNOVATION TIMELINE

SPEEDBOR MAX Short and Long Bits.

Wood Countersinks



2014

SPEEDBOR with Weld-Tec Auger Bits

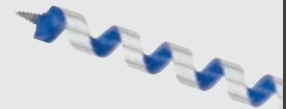

2010

SPEEDBOR MAX Wood Boring Bits



2007

SPEEDBOR Blue Groove Spade Bits



2006

SPEEDBOR Universal Spade Bits



1984

SPEEDBOR Wood Boring Spade Bits



1954

Auger Bit invented by Charles Irwin



1885

WOOD DRILLING

SPEEDBOR® Blue Groove Spade Bits

IRWIN®
SPEEDBOR®

1. Blue Groove point and cutting edge cuts the wood up to 4X faster
2. Double spurs for cleaner holes and reduced breakout
3. Curved scoop optimises control and removal of wood chips
4. 6mm hex shank prevents bit from slipping in chuck
5. Full length heat treated body is stronger and lasts longer
6. Quick-Change shank for fast changing in Quick-Change adapters.
Not applicable to 406mm length bits



SPEEDBOR® Blue Groove Spade Bits — Metric

Product Code	Size	Shelf Pack	Barcode
Singles - 160mm Length			
88906	6mm	6	0024721013811
88908	8mm	6	0024721013828
88910	10mm	6	0024721013835
88912	12mm	6	0024721013842
88913	13mm	6	0024721013859
88914	14mm	6	0024721013866
88916	16mm	6	0024721013873
88918	18mm	6	0024721013880
88919	19mm	6	0024721013897
88920	20mm	6	00024721013903
88922	22mm	6	0024721013910
88924	24mm	6	0024721013934
88925	25mm	6	00024721013941
88928	28mm	3	00024721013965
88930	30mm	3	0024721013972
88932	32mm	3	0024721013989
88935	35mm	3	0024721014009
88938	38mm	3	0024721014016
Singles - 406mm Length			
88610	10mm	6	0024721013064
88612	12mm	6	0024721014153
88616	16mm	6	0024721014191
88619	19mm	6	0024721013088
88620	20mm	6	0024721014214
88622	22mm	6	0024721014221
88625	25mm	6	0024721014245
Sets - 160mm Length			
88999	Set of 6 Blue Groove Metric Bits in Pouch — 10, 13, 16, 19, 22, 25mm	1	0024721253149
10506014	Set of 8 Blue Groove Metric Bits in Pro Case — 12, 14, 16, 18, 20, 22, 25, 32mm	1	5706915060140



SPEEDBOR® Extensions

- Carbon steel constructed sleeve and body for durability and life
- Designed for one-handed quick release
- Design to hold 1/4" ball indented bits

Product Code	Description	Shelf Pack	Barcode
88300	12" Extensions 1/4 Round Shank Grub Screw Fitment	1	0024721883001
90106	150mm Extension Quick Release	5	0024721901064
90112	300mm Extension Quick Release	5	0024721901125

SPEEDBOR® MAX



1. Three cutting spurs for faster, cleaner holes, less breakout, and extended drilling life
2. Full screw-point tip allows bit to self-feed for ease of drilling
3. Tapered tri-flute design for faster chip ejection and less binding

THE FASTEST SPEEDBOR® EVER.

SPEEDBOR® MAX Bits - 101mm Short Length Bits

- Shorter overall length for drilling in tight spaces. Ideal for holes up to 2" deep
- Quick-Change shank for fast changing in Quick-Change adapters



Product Code	Diameter	Shelf Pack	Barcode
Singles - 101mm / 4" Length			
9097828	16mm	3	9314244019522
9097829	20mm	3	9314244019539
9097830	22mm	3	9314244019546
9097831	25mm	3	9314244019553
9097832	32mm	3	9314244019560
Sets - 101mm / 4" Length			
9097848	Set of 3 - (16, 20, 25mm)	6	9314244019720



SPEEDBOR® MAX Bits - 152mm Standard Length Bits

- Ideal for holes up to 4" deep
- Quick-Change shank for fast changing in Quick-Change adaptors

Product Code	Diameter	Shelf Pack	Barcode
Singles - 152mm / 6" Length			
10507037	13mm	6	5706915070378
10506612	16mm	6	5706915066128
10506613	20mm	6	5706915066135
10506614	22mm	6	5706915066142
10506615	25mm	6	5706915066159
10506616	28mm	6	5706915066166
10506617	32mm	6	5706915066173
Sets - 152mm / 6" Length			
10506618	Set of 3 - (16, 20, 25mm)	6	5706915066180
10506619	Set of 6 in Pro Case - (16, 18, 20, 22, 25, 32mm)	6	5706915066197



SPEEDBOR® MAX Bits - 305mm, 406mm and 610mm Long Length Bits

- Ideal for holes up to 4" deep
- Hole in flute for easy wire pulling through walls, ceilings, and floors



Product Code	Diameter	Shank Size	Shelf Pack	Barcode
Singles - 305mm / 12" Length				
9097833	16mm	3/8" Hex	3	9314244019577
9097834	20mm	3/8" Hex	3	9314244019584
9097835	22mm	3/8" Hex	3	9314244019591
9097836	25mm	3/8" Hex	3	9314244019607
9097837	32mm	7/16" Hex	3	9314244019614
Singles - 406mm / 16" Length				
9097838	16mm	3/8" Hex	3	9314244019621
9097839	20mm	3/8" Hex	3	9314244019638
9097840	22mm	3/8" Hex	3	9314244019645
9097841	25mm	3/8" Hex	3	9314244019652
9097842	32mm	7/16" Hex	3	9314244019669
Singles - 610mm / 24" Length				
9097843*	16mm	3/8" Hex	25	9314244019676
9097844*	20mm	3/8" Hex	25	9314244019683
9097845*	22mm	3/8" Hex	25	9314244019690
9097846*	25mm	3/8" Hex	25	9314244019706
9097847*	32mm	7/16" Hex	25	9314244019713

*Tubed



Augers

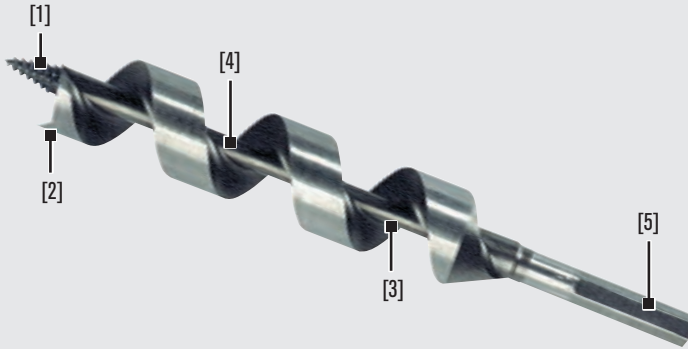

1. Self feeding screw point provides faster boring in soft woods
2. Single spur tip scribes the hole for a smoother finish
3. Solid centre provides extra rigidity while boring
4. Fully hardened body from tip to shank for extra durability
5. Hex shank prevents bit slipping in chuck

I-100 Dual Auger Wood Bits (Short) - Metric

- Overall length: 191mm (7 1/2")
- Can be used in 10mm (3/8") or larger electric drills

Product Code	Size (mm)	Size (inches)	Shank (mm)	Hex (mm)	Shelf Pack	Barcode
0006-191-06	6mm	1/4"	5.8	4.8	6	7897095021385
0006-191-08	8mm	5/16"	6.3	5.4	6	7897095021392
0006-191-10	10mm	3/8"	9.2	7.9	6	7897095021408
0006-191-11	11mm	7/16"	9.2	7.9	6	7897095021415
0006-191-12	12mm	1/2"	9.2	7.9	6	7897095021422
0006-191-14	14mm	9/16"	9.2	7.9	6	7897095021446
0006-191-16	16mm	5/8"	9.2	7.9	6	7897095021453
0006-191-17	17mm	11/16"	9.2	7.9	6	7897095021460
0006-191-19	19mm	3/4"	9.2	7.9	3	7897095021484
0006-191-22	22mm	7/8"	9.2	7.9	3	7897095021514
0006-191-25	25mm	1"	9.2	7.9	3	7897095021538

I-100 Dual Auger Wood Bits (Medium) - Metric

- Overall length: 280mm (11")
- Can be used in 10mm (3/8") or larger electric drills

Product Code	Size	Size (inches)	Shank (mm)	Hex (mm)	Shelf Pack	Barcode
0006-280-08	8mm	5/16 "	6.3	5.4	6	7897095021989
0006-280-10	10mm	3/8 "	9.2	7.9	6	7897095021996
0006-280-12	12mm	1/2 "	9.2	7.9	6	7897095022009
0006-280-13	13mm	-	9.2	7.9	6	7897095022016
0006-280-14	14mm	9/16 "	9.2	7.9	6	7897095022023
0006-280-16	16mm	5/8 "	9.2	7.9	6	7897095022030
0006-280-19	19mm	3/4 "	9.2	7.9	3	7897095022047



I-100 Dual Auger Wood Bits (Long) - Metric

- Overall length: 400mm
- Can be used in 10mm (3/8") or larger electric drills

Product Code	Size (mm)	Size (inches)	Shank (mm)	Hex (mm)	Shelf Pack	Barcode
0006-400-10	10mm	3/8"	9.2	7.9	6	7897095021606
0006-400-12	12mm	1/2"	9.2	7.9	6	7897095021613
0006-400-14	14mm	9/16"	9.2	7.9	6	7897095021637
0006-400-16	16mm	5/8"	9.2	7.9	6	7897095021644
0006-400-18	18mm	-	9.2	7.9	3	7897095021651
0006-400-19	19mm	3/4"	9.2	7.9	3	7897095021668
0006-400-20	20mm	-	9.2	7.9	3	7897095021675
0006-400-22	22mm	7/8"	9.2	7.9	3	7897095021682

Note: Imperial sizes are the approximate equivalent

Power Ship Augers



- Patent pending welded cutting edge for increased durability when boring holes in nail-embedded wood
- Aggressive screw pitch for faster drilling
- Wide flutes for maximum chip removal
- Fully forged bit** for durability
- 7/16" Quick-Change Impact Shank - for fast bit changes (items 3043004 and 3043005 feature a 3/8" Shank)

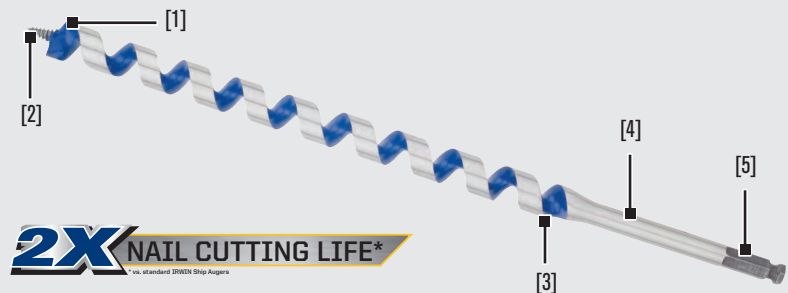

IRWIN TOOLS

SPEEDBOR® with WeldTec™ Power Ship Augers

Product Code	Size (mm)	Size (inches)	Shank (mm)	Shelf Pack	Barcode
3043004	10mm	3/8"	9.52	6	0024721105455
3043005	12mm	1/2"	9.52	6	0024721105462
3043006	14mm	9/16"	11.11	6	0024721105479
3043007	16mm	5/8"	11.11	6	0024721105486
3043008	17mm	11/16"	11.11	6	0024721105493
3043009	19mm	3/4"	11.11	6	0024721105509
3043010	21mm	13/16"	11.11	6	0024721105516
3043011	22mm	7/8"	11.11	6	0024721105523
3043012	24mm	15/16"	11.11	6	0024721105530
3043013	25mm	1"	11.11	6	0024721105547
3043014	28mm	1 1/8"	11.11	3	0024721105554
3043015	32mm	1 1/4"	11.11	3	0024721105561
3043016	38mm	1 1/2"	11.11	3	0024721105578

Note: Metric sizes are the approximate equivalent
 **Fully forged on bits 3/4" diameter and longer



* vs. standard pole augers.

Power Ship Augers (continued)

Power Ship Auger Drill Bit Extensions

Product Code	Size	Shank Suitability	Size Bit Followed	Shelf Pack	Barcode
43805	18"	5/16" hex shank	11/16"	1	0024721438058

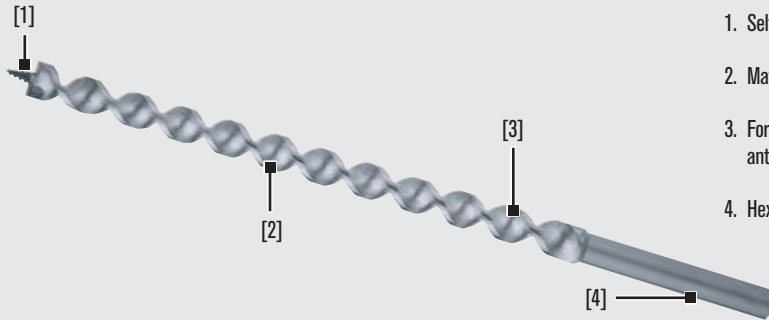

1. Self-feeding screw point for faster boring into all types of wood
2. Mathieson-type twist for drilling in hard woods
3. Forged SAE 1060 steel, austemper heat-treated and coated with anti-corrosive oil for longer life
4. Hex shank prevents bit from slipping in chuck

Scotch Pattern Augers

- Overall length: 305mm (12")
- Shank: hex

Product Code	Size (mm)	Size (inches)	Shank Diameter	Shelf Pack	Barcode
Singles					
1008-305-06	6mm	1/4"	1/4"	1	7897095025925
1008-305-08	8mm	5/16"	5/16"	1	7897095025932
1008-305-10	10mm	3/8"	3/8"	1	7897095025949
1008-305-11	11mm	7/16"	7/16"	1	7897095025956
1008-305-12	12mm	1/2"	1/2"	1	7897095025963
1008-305-14	14mm	9/16"	1/2"	1	7897095025970
1008-305-16	16mm	5/8"	1/2"	1	7897095025987
1008-305-17	17mm	11/16"	1/2"	1	7897095025994
1008-305-19	19mm	3/4"	1/2"	1	7897095026007
1008-305-21	21mm	13/16"	1/2"	1	7897095026014
1008-305-22	22mm	7/8"	1/2"	1	7897095026021
1008-305-25	25mm	1"	1/2"	1	7897095026045
Bulk					
1008C-30514	14mm	9/16"	1/2"	75	7897095044346
1008C-30516	16mm	5/8"	1/2"	60	7897095044353
1008C-30519	19mm	3/4"	1/2"	45	7897095044377
1008C-30521	21mm	13/16"	1/2"	X	7897095044384

Scotch Pattern Screw Eyed Augers

- Overall length: 610mm (24")



Product Code	Size (mm)	Size (inches)	Shelf Pack	Barcode
0004-610-12	12mm	1/2"	6	7897095007242
0004-610-14	14mm	9/16"	6	7897095007259
0004-610-16	16mm	5/8"	6	7897095007266
0004-610-19	19mm	3/4"	6	7897095007280
0004-610-22	22mm	7/8"	6	7897095007297
0004-610-25	25mm	1"	6	7897095007303

Note: Imperial sizes are the approximate equivalent

Wood Countersinks

1. Tapered drill with widened flutes for drilling fast, clean pilot holes, and ensures tight fit for screws
2. Adjustable four-cutter counterbore cuts and clears chips quicker for fast, smooth countersinking
3. Counterbore attaches to flats on shank with two hex screws for a secure fit, and can be adjusted for controlled pilot hole depth
4. 1/4" quick-change shank reduces slipping in standard chucks and is compatible with all 1/4" quick-change chucks, including impact drills
5. Adjustable stop collar attaches to counterbore with hex screw for a secure fit and can be adjusted for desired counterbore depth (Included in sets only)

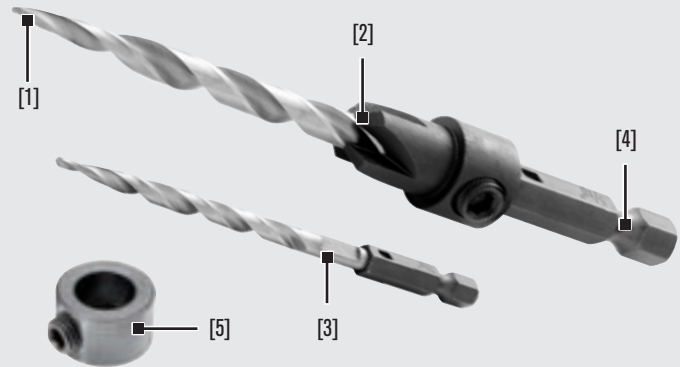

Countersink Tools

Product Code	Screw Size	Bit Diameter	Overall Length	Flute Length	Counterbore Size	Plug Size	Shelf Pack	Barcode
Singles								
1882630	#4	2.8mm (7/64")	86mm (3-3/8")	38mm (1-1/2")	6.4mm (1/4")	6.4mm (1/4")	6	042526923074
1882781	#6	3.6mm (9/64")	92.5mm (3-5/8")	45mm (1-3/4")	7.9mm (5/16")	7.9mm (5/16")	6	042526923081
1882782	#8	4.4mm (11/64")	101.8mm (4")	54mm (2-1/8")	9.5mm (3/8")	9.5mm (3/8")	6	042526923098
1882783	#10	4.8mm (3/16")	108.2mm (4-1/4")	59mm (2-5/16")	11.1mm (7/16")	11.1mm (7/16")	6	042526923104
1882784	#12	5.6mm (7/32")	114.5mm (4-1/2")	64.5mm (2-1/2")	11.1mm (7/16")	11.1mm (7/16")	6	042526923111
1882785	#14	6.4mm (1/4")	120mm (4-3/4")	70mm (2-3/4")	12.7mm (1/2")	12.7mm (1/2")	6	042526923128
Sets								
1882793	Set of 4 - (#6, #8, #10, Small Depth Stop)						6	042526923210
1882792	Set of 8 - (#4, #6, #8, #10, #12, #14, Small Depth Stop, Large Depth Stop)						6	042526923203



Replacement Bits

Product Code	Bit Diameter	Replacement Bit For	Shelf Pack	Barcode
1882786	2.8mm (7/64")	1882630	6	042526923135
1882787	3.6mm (9/64")	1882781	6	042526923159
1882788	4.4mm (11/64")	1882782	6	042526923166
1882789	4.8mm (3/16")	1882783	6	042526923173
1882790	5.6mm (7/32")	1882784	6	042526923180
1882791	6.4mm (1/4")	1882785	6	042526923197



Door Lock Installation Kit

Bi-Metal Door Lock Installation Kit

- Enables simple installation of door lock hardware
- For metal and wood doors
- 3 easy steps: drill, route and install
- Includes Bi-Metal hole saws; 2X longer life than carbon hole saws



Product Code	Contents	Shelf Pack	Barcode
3111002	Double sided jig (fits all standard doors and backsets) Bolt plate template Custom router bit Hinge plate template 21/8" (54mm) Bi-Metal Hole Saw 1" (25.4mm) Bi-Metal Hole Saw 3/8" (9.5mm) Arbor	1	0038548037547





BOLT EXTRACTION

Bolt Extraction

Power Grip™ 7pc Set

- Use with power drill for easy removal of rusted, painted-over or burred fasteners/bolts/screws, etc
- Left-hand spiral teeth bite down for a positive grip on the fastener head
- Quick-Change shank for fast loading in Quick-Change adapters
- 1/4" hex shank for use in cordless drills, impact drivers and corded drills
- Universal lobular design is suitable for both metric and imperial fasteners



Product Code	Contents	Shelf Pack	Barcode
394100	3/16", 1/4", 5/16", 3/8", 10mm, 7/16" (11mm) & 1/2"	5	0024721037633

Bolt Grip™ 5pc Sets

- Use with spanner or VISE-GRIP Locking Pliers for easy removal of rusted, painted-over or burred fasteners/bolts/screws, etc - fits with 3/8" socket adapters
- Left-hand spiral teeth bite down for a positive grip on the fastener head
- Universal lobular design is suitable for both metric and imperial fasteners



Product Code	Description	Contents	Shelf Pack	Barcode
394001	Bolt-Grip™ 5 Piece Base Set in Pro Case	3/8", 7/16" (11mm) & 1/2", 9/16" (14mm) & 5/8" (16mm)	5	0024721012579
394002	Bolt-Grip™ 5 Piece Expansion Set	5/16" (8mm), 10mm, 13mm, 11/16" & 3/4" (19mm)	5	0024721016126

For all Impact Screw & Bolt Grip Extractors refer to Fastener Drive.

IRWIN®

Fastener Drive



IRWIN TOOLS

Customer Service: 1800 331 491

IMPACT ACCESSORIES



Impact Double-Ended Screwdriving Bits

1. Precision tip geometry delivers superior fitment, reducing stripping and cam-out
2. Power Groove designed for compatibility with IRWIN® Impact Performance Series™ Magnetic Screw-Hold Attachment
3. DoubleLok Technology™ ensures both ends of bit lock securely in impact drivers and quick-change chucks, enabling use of two tips from one bit for added convenience and extended life
4. Manufactured with heavy-duty, cold-forged, high-grade steel to withstand high torque output

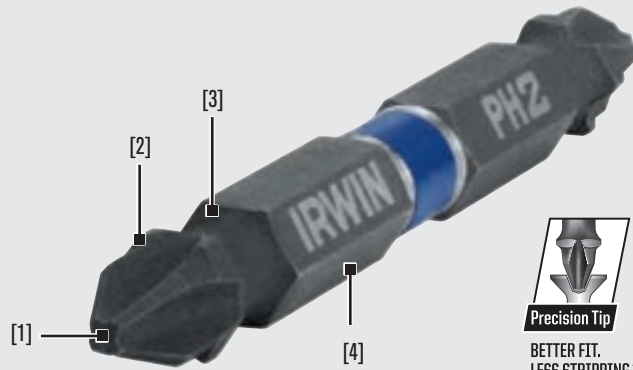

Compatible with IRWIN Impact Performance Series Magnetic Screw-Hold Attachment**

Impact Double-Ended Screwdriving Bits - Phillips® Bits



Product Code	Bits in Pack	Insert Size	Length	Shelf Pack	Barcode
Carded					
1870983	2	#2PH/#2PH	60mm	5	0042526915048
1871068	1	#2PH/#2PH	100mm	5	0042526915185
1871082	1	#2PH/#2PH	150mm	5	0042526915321
Product Code	Bits in Pack	Insert Size	Length	Min Qty	Barcode
Bulk					
9097982	1	#2PH/#2PH	60mm	10	9314244019812



Impact Double-Ended Screwdriving Bits - Pozi Bits® Bits



Product Code	Bits in Pack	Insert Size	Length	Shelf Pack	Barcode
Carded					
9097680	2	#2PZ/#2PZ	60mm	5	9314244018716
Product Code	Bits in Pack	Insert Size	Length	Min Qty	Barcode
Bulk					
9097684	1	#2PZ/#2PZ	60mm	10	9314244018754



Impact Double-Ended Screwdriving Bits - Square Recess Bits



Product Code	Bits in Pack	Insert Size	Length	Shelf Pack	Barcode
Carded					
1870986	1	#2SQ/#2SQ	60mm	5	0042526915079
1871071	1	#2SQ/#2SQ	100mm	5	0042526915215
1871085	1	#2SQ/#2SQ	150mm	5	0042526915352
Bulk					
9097983	1	#2SQ/#2SQ	60mm	10	9314244019829



Phillips® & POZIDRIV® are registered trademarks of the Phillips Screw Company



Impact Double-Ended Screwdriving Bits (continued)

Impact Double-Ended Screwdriving Bits - Hex Bits



Product Code	Bits in Pack	Insert Size	Length	Shelf Pack	Barcode
Carded					
9097679	2	HEX5/HEX5	60mm	5	9314244018709
Bulk					
9097683	1	HEX5/HEX5	60mm	10	9314244018747

Impact Double-Ended Screwdriving Bits - Combination Bits



Product Code	Bits in Pack	Insert Size	Length	Shelf Pack	Barcode
Carded					
1870988	2	#2SQ/#2PH	60mm	5	0042526915093
9097681	2	#2SQ/HEX5MM	60mm	5	9314244018723
9097682	2	#2PH/#2PZ	60mm	5	9314244018730
Bulk					
9097685	1	#2SQ/HEX5MM	60mm	10	9314244018761
9097686	1	#2PH/#2PZ	60mm	10	9314244018778

Impact Double-Ended Screwdriving Bits - Sets



Product Code	Bits in Pack	Contents	Shelf Pack	Barcode
Clamshell				
1882352	3	PH1/PH1, PH2/PH2, PH3/PH3	5	0042526922930
1882353	3	SQ1/SQ1, SQ2/SQ2, SQ3/SQ3	5	0042526922947
1882354	3	PH2/PH2, SQ2/SQ2, PH2/SQ2	5	0042526922954
1892093	3	T15/T20, T20/T25, T25/T30	5	0042526927874
1903513	4	PH2/PH2(3), Mag Bit Holder	5	0042526932366
1903514	4	SQ2/SQ2(3), Mag Bit Holder	5	0042526932373
1903516	4	PH1/PH1, PH2/PH2, PH3/PH3, Mag Bit Holder	5	0042526932403
1903520	5	PH2/PH2(2), PH1/PH2, PH2/PH3, Mag Bit Holder	5	0042526932441
1903522	5	T15/T20, T20/T25, T25/T30, T25/T25, Mag Bit Holder	5	0042526932472
1903523	7	PH2/PH2(3), SQ2/SQ2(3), Mag Bit Holder	5	0042526932489

Magnetic Screw-Hold Attachment



Product Code	Bits in Pack	Contents	Shelf Pack	Barcode
Carded				
1903524	1	Magnetic Screw-Hold	5	0042526932496

Impact Screwdriving Bits



1. Power Groove designed for compatibility with IRWIN® Impact Performance Series™ Magnetic Screw-Hold Attachment***
2. Precision tip geometry delivers superior fitment, reducing stripping and cam-out
3. Manufactured with heavy-duty, cold-forged, high-grade steel to withstand high torque output

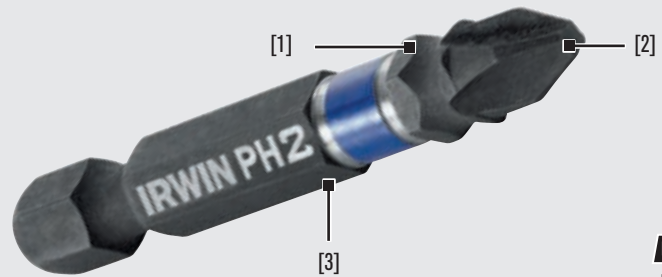

Compatible with IRWIN Impact Performance Series Magnetic Screw-Hold Attachment**

*vs. standard screwdriving bits
**excludes T40, SL10-12, SL12-14, Hex 6mm, Hex 8mm, Hex 1/4"
***Power Groove Inclusion will be a rolling change to current IMPACT single ended power bits

Impact Screwdriving Bits - Phillips® Insert Bits



Product Code	Bits in Pack	Insert Size	Length	Shelf Pack	Barcode
Carded					
9097279	2	PH#1	25mm	5	9314244017467
9097280	2	PH#2	25mm	5	9314244017474
9097282	2	PH#3	25mm	5	9314244017498
Product Code	Bits in Pack	Insert Size	Length	Min Qty	Barcode
Bulk					
9097301	1	PH#1	25mm	25	9314244017689
9097302	1	PH#2	25mm	25	9314244017696
9097303	1	PH#3	25mm	25	9314244017702



IRWIN TOOLS

Impact Screwdriving Bits - Square Recess Bits



Product Code	Bits in Pack	Insert Size	Length	Shelf Pack	Barcode
Carded					
9097284	2	SQ#1	25mm	5	9314244017511
9097285	2	SQ#2	25mm	5	9314244017528
9097286	2	SQ#3	25mm	5	9314244017535
Product Code	Bits in Pack	Insert Size	Length	Min Qty	Barcode
Bulk					
9097304	2	SQ#1	25mm	25	9314244017719
9097305	2	SQ#2	25mm	25	9314244017726
9097306	2	SQ#3	25mm	25	9314244017733



Phillips® is a registered trademarks of the Phillips Screw Company



Impact Screwdriving Bits (continued)

Impact Screwdriving Bits - Torx Insert Bits



Product Code	Bits in Pack	Insert Size	Length	Shelf Pack	Barcode
Carded					
1837390	1	T6	25mm	5	0673765170082
1837392	1	T7	25mm	5	0673765170105
1837394	1	T8	25mm	5	0673765170129
1837396	1	T9	25mm	5	0673765170143
1837398	1	T10	25mm	5	0673765170167
1837400	1	T15	25mm	5	0673765170181
1837402	1	T20	25mm	5	0673765170204
1837404	1	T25	25mm	5	0673765170228
1837408	1	T27	25mm	5	0673765170266
1837410	1	T30	25mm	5	0673765170280
1837412	1	T40	25mm	5	0673765170303
Set					
1837414	6	TR10, TR15, TR20, TR25, TR27, TR30	25mm	5	0673765170327

Impact Screwdriving Bits - Hex Insert Bits



Product Code	Bits in Pack	Insert Size	Length	Shelf Pack	Barcode
Carded					
9097317	1	5mm	25mm	5	9314244017832

Impact Screwdriving Bits - Bit Holders



Product Code	Bits in Pack	Insert Size	Length	Shelf Pack	Barcode
Carded					
1837577	1	1/4"	57mm	5	0673765171119
1837579	1	1/4"	76mm	5	0673765171133
Product Code	Bits in Pack	Insert Size	Length	Min Qty	Barcode
Bulk					
9097786	1	1/4"	76mm	5	9314244019409

Impact Screwdriving Bits - Phillips® Power Bits



Product Code	Bits in Pack	Insert Size	Length	Shelf Pack	Barcode
Carded					
9097288	2	PH#1	50mm	5	9314244017559
1837437	1	PH#1	75mm	5	0673765105985
1837439	1	PH#1	100mm	5	0673765106012
1837451	1	PH#1	150mm	5	0673765106043
9097289	2	PH#2	50mm	5	9314244017566
1837454	5	PH#2	50mm	5	0673765170518
9097290	1	PH#2	75mm	5	9314244017573
9097291	1	PH#2	100mm	5	9314244017580
9097292	1	PH#2	150mm	5	9314244017597
9097287	2	PH#3	50mm	5	9314244017542
1837462	1	PH#3	75mm	5	0673765106005
1837464	1	PH#3	100mm	5	0673765106036
1837466	1	PH#3	150mm	5	0673765106067
Product Code	Bits in Pack	Insert Size	Length	Min Qty	Barcode
Bulk					
9097307	1	PH#1	50mm	10	9314244017740
9097308	1	PH#2	50mm	10	9314244017757
9097309	1	PH#3	50mm	10	9314244017764
9097986	1	PH#2	100mm	10	9314244019850
9097991	1	PH#2	150mm	10	9314244019904

Impact Screwdriving Bits - Square Recessed Power Bits



Product Code	Bits in Pack	Insert Size	Length	Shelf Pack	Barcode
Carded					
9097296	2	SQ#1	50mm	5	9314244017634
1837470	1	SQ#1	75mm	5	0673765106166
1837472	1	SQ#1	100mm	5	0673765106197
1837474	1	SQ#1	150mm	5	0673765106227
9097297	2	SQ#2	50mm	5	9314244017641
1837478	5	SQ#2	50mm	5	0673765170525
9097293	1	SQ#2	75mm	5	9314244017603
9097294	1	SQ#2	100mm	5	9314244017610
9097295	1	SQ#2	150mm	5	9314244017627
9097298	2	SQ#3	50mm	5	9314244017658
1837487	1	SQ#3	75mm	5	0673765106180
1837489	1	SQ#3	100mm	5	0673765106210
1837491	1	SQ#3	150mm	5	0673765106241
Product Code	Bits in Pack	Insert Size	Length	Min Qty	Barcode
Bulk					
9097310	1	SQ#1	50mm	10	9314244017771
9097311	1	SQ#2	50mm	10	9314244017788
9097312	1	SQ#3	50mm	10	9314244017795
9097987	1	SQ#2	100mm	10	9314244019867
9097992	1	SQ#2	150mm	10	9314244019911

Note: Phillips® & POZIDRIV® is a registered trademarks of the Phillips Screw Company
TORX® is a registered trademark of Camcar, a division of Textron Industries



Impact Screwdriving Bits (continued)



Impact Screwdriving Bits - Hex Power Bits

Product Code	Bits in Pack	Insert Size	Length	Shelf Pack	Barcode
Carded					
9097324	1	4mm	50mm	5	9314244017900
9097325	5	5mm	50mm	5	9314244017917
9097326	10	5mm	50mm	5	9314244017924
5121784	1	6mm	50mm	5	9314244023116
9097327	5	3,4,5,6,8mm	50mm	5	9314244017931
Product Code	Bits in Pack	Insert Size	Min Qty	Shelf Pack	Barcode
Bulk					
9097328	1	5mm	50mm	10	9314244017948



Impact Screwdriving Bits - Torx Power® Bits

Product Code	Bits in Pack	Insert Size	Length	Shelf Pack	Barcode
Carded					
1837493	3	T15,T20,T25	50mm	5	0673765170532



Impact Screwdriving Bits - Slotted Bits

Product Code	Bits in Pack	Insert Size	Length	Shelf Pack	Barcode
Carded					
1899804	2	SL6-8	50mm	5	0042526929151
1899806	2	SL8-10	50mm	5	0042526929175
1899808	2	SL10-12	50mm	5	0042526929199

Impact Magnetic Nutsetters



1. Lobular design drives fastener on side instead of corner for less stripping and longer life
2. Rare earth magnets hold fasteners securely with 4X the hold of standard magnets
3. 1/4" quick-change shank is designed to work with impact drivers, and reduces slipping in standard drill chucks



Impact Magnetic Nutsetters

Product Code	Bits in Pack	Insert Size	Length	Shelf Pack	Barcode
Carded					
1837545	1	1/4"	65mm	5	0673765172079
1837547	1	5/16"	65mm	5	0673765172093
1837550	1	3/8"	65mm	5	0673765172123
1837562	1	1/4"	152mm	5	0673765170969
1837564	1	5/16"	152mm	5	0673765170983
1837566	1	3/8"	152mm	5	0673765171003
1837568	1	1/4"	304mm	6	0673765171027
1837569	1	5/16"	304mm	6	0673765171034
1837570	1	3/8"	304mm	6	0673765171041
1837531	3	1/4", 5/16", 3/8"	47mm	5	0673765171935
Product Code	Bits in Pack	Insert Size	Length	Min Qty	Barcode
Bulk					
9097984	1	5/16"	100mm	10	9314244019836
9097985	1	3/8"	100mm	10	9314244019843



Note: Phillips® & POZIDRIV® is a registered trademarks of the Phillips Screw Company
TORX® is a registered trademark of Camcar, a division of Textron Industries



Impact Fastener Drive Sets

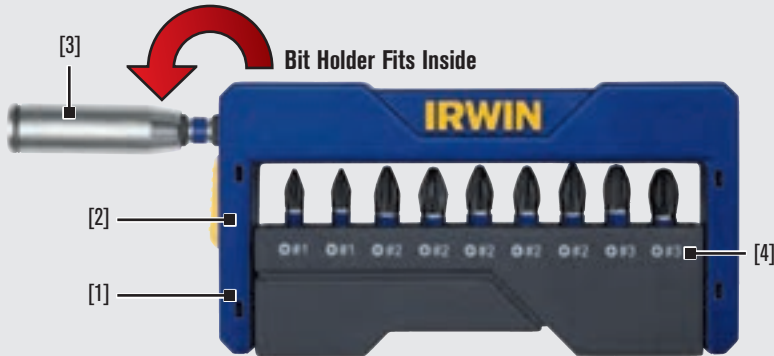

1. Compact, portable design allows for easy transport to and from the worksite and ease-of-use while on the job
2. Molded ABS resin case holds up to rigors of daily use
3. Convenient bit holder storage compartment incorporated into top of case (insert bit cases only)
4. Easy-to-read size markings provide simple identification of set contents

Impact Insert Bit Pocket Case Sets



Product Code	Bits in Pack	Shelf Pack	Barcode
9097013	10	6	9314244017009

Bit Description	Quantity
PH#1 25mm	1
PH#2 25mm	2
PH#3 25mm	1
Hex 5mm 25mm	1

Bit Description	Quantity
SQ#1 25mm	1
SQ#2 25mm	2
SQ#3 25mm	1
Magnetic Impact Bit Holder 1	1



Product Code	Bits in Pack	Shelf Pack	Barcode
9097051	10	6	9314244018464

Bit Description	Quantity
PH2 #2 25mm	5
Magnetic Bit Holder	1

Bit Description	Quantity
SQ #2 25mm	4

Impact Power Bit Pocket Case Set



Product Code	Bits in Pack	Insert Size	Length	Shelf Pack	Barcode
9097043	5	PH#2	50mm	6	9314244018389
9097045	5	HEX5	50mm	6	9314244018402
9097046	5	SQ#2	50mm	6	9314244018419

Impact Mixed Power Bit Pocket Cases

Product Code	Bits in Pack	Contents	Length	Shelf Pack	Barcode
9097049	5	HEX-3,4,5,6,8mm	50mm	6	9314244018440

Product Code	Bits in Pack	Shelf Pack	Barcode
9097011	5	6	9314244016989

Bit Description	Quantity
PH#1 50mm	1
PH#2 50mm	1
PH#3 50mm	1

Bit Description	Quantity
SQ #2 50mm	1
Hex 5mm 50mm	1

Product Code	Bits in Pack	Shelf Pack	Barcode
9097052	3	6	9314244018471

Bit Description	Quantity
Adapter 1/4"	1
Adapter 1/2"	1

Bit Description	Quantity
Adapter 3/8"	1

Impact 20 Piece PRO-PAK™ Sets

Product Code	Bits in Pack	Insert Size	Length	Shelf Pack	Barcode
9097283	20	PH#2	25mm	10	9314244017504
1837387	20	SQ#2	25mm	10	0673765108696

Impact Power Bit Clam Set

Product Code	Bits in Pack	Shelf Pack	Barcode
9097299	6	6	9314244017665

Bit Description	Quantity
PH#1 50mm	1
PH#2 50mm	2
SQ#1 50mm	1

Bit Description	Quantity
SQ#2 50mm	1
63mm Lock-n-Load Extension	1

Impact Insert Bit Clam Set

Product Code	Bits in Pack	Shelf Pack	Barcode
9097300	14	6	9314244017672

Bit Description	Quantity
PH#1 25mm	2
PH#2 25mm	4
SQ#1 25mm	2

Bit Description	Quantity
SQ#2 25mm	4
57mm Magnetic Bit Holder 1	1
76-120mm Magnetic Screwguide	1



Note: Phillips® & POZIDRIV® is a registered trademarks of the Phillips Screw Company



Impact Sockets



Six-point recessed corners for secure fit

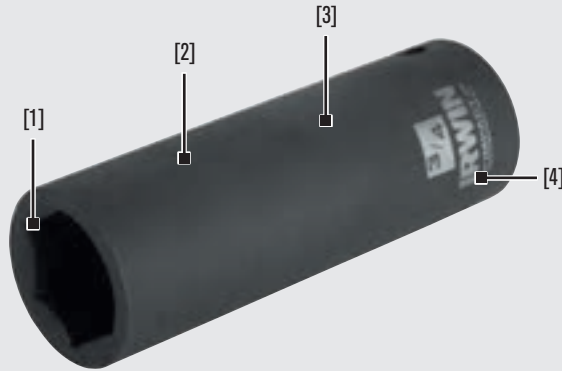

1. Six-point deep wells with recessed corners drive torque across the flats for more secure fit and longer life
2. Made from heavy-duty chrome molybdenum steel for maximum durability and long life with impact drivers
3. Thin wall construction increases access to tight spaces
4. Permanent, large, laser-etched size markings for easy identification

Impact 3/8" Drive Deep Well Sockets - Imperial



Product Code	Diameter	Overall Length	Base Outside Diameter	Tip Outside Diameter	Drive	Shelf Pack	Barcode
Hangsell							
1877471	1/4"	63mm	11mm	19mm	3/8" Square		0042526916830
1877472	5/16"	63mm	12.5mm	19mm	3/8" Square		0042526916847
1878736	11/32"	63mm	13mm	19mm	3/8" Square		0042526928062
1877473	3/8"	63mm	14.5mm	19mm	3/8" Square		0042526916861
1877474	7/16"	63mm	17mm	19mm	3/8" Square		0042526916878
1877475	1/2"	63mm	19mm	19mm	3/8" Square		0042526916885
1877476	9/16"	63mm	20mm	20mm	3/8" Square		0042526916892
1877477	5/8"	63mm	23.8mm	23.8mm	3/8" Square		0042526916908
1877478	11/16"	63mm	26mm	26mm	3/8" Square		0042526916915
1877479	3/4"	63mm	27mm	27mm	3/8" Square		0042526916922
1882332	13/16"	63mm	30mm	30mm	3/8" Square		0042526922428
1877480	7/8"	63mm	30mm	30mm	3/8" Square		0042526916939
1882333	15/16"	63mm	32mm	32mm	3/8" Square		0042526922435
1882334	1"	63mm	32mm	32mm	3/8" Square		0042526922442

Impact 3/8" Drive Deep Well Sockets - Metric



Product Code	Diameter	Overall Length	Base Outside Diameter	Tip Outside Diameter	Drive	Shelf Pack	Barcode
Hangsell							
1877483	10mm	63mm	15mm	19mm	3/8" Square		0042526916960
1877484	11mm	63mm	17mm	19mm	3/8" Square		0042526916977
1877485	12mm	63mm	19mm	19mm	3/8" Square		0042526916984
1877486	13mm	63mm	22mm	22mm	3/8" Square		0042526916991
1877487	14mm	63mm	22mm	22mm	3/8" Square		0042526917004
1877488	15mm	63mm	22.9mm	22.9mm	3/8" Square		0042526917011
1877489	16mm	63mm	24mm	24mm	3/8" Square		0042526917035
1877490	17mm	63mm	25mm	25mm	3/8" Square		0042526917042
1877491	18mm	63mm	25mm	25mm	3/8" Square		0042526917059
1877492	19mm	63mm	27.8mm	27.8mm	3/8" Square		0042526917066
1877493	21mm	63mm	30mm	30mm	3/8" Square		0042526917073

Impact Sockets Rail Sets

- Powerful rare earth magnets, with 4X the hold of standard magnets, for secure attachment to work and storage surfaces
- Non-mark foam backing to protect against scratches



Product Code	Bits in Pack	Contents	Shelf Pack	Barcode
Sets				
1877481	8	5/16, 3/8, 7/16, 1/2, 9/16, 5/8, 11/16, 3/4	6	0042526916946
1882413	8	10, 11, 12, 13, 14, 17, 18, 19mm	6	0042526922633

Impact Square Drive Extensions



Product Code	Bits in Pack	Drive Size	Length	Shelf Pack	Barcode
Hangsell					
1877494	1	3/8" Square	76mm	6	0042526917080
1877495	1	3/8" Square	150mm	6	0042526917097
1877496	1	3/8" Square	305mm	6	0042526917103
1877497	3	3/8" Square	76,150,305mm	6	0042526917110



Impact Square Drive Reducers

Product Code	Bits in Pack	Drive Size	Length	Shelf Pack	Barcode
Hangsell					
1877498	1	1/2" Square	3/8" Square	6	0042526917127
1877499	1	3/8" Square	1/4" Square	6	0042526917134



Impact Socket Adapters

Product Code	Bits in Pack	Drive Size	Length	Shelf Pack	Barcode
Hangsell					
1837571	1	1/4" Square	50mm	5	0673765171058
1837572	1	3/8" Square	50mm	5	0673765171065
1837573	1	1/2" Square	50mm	5	0673765171072
1899889	1	1/4" Square	150mm	5	0042526929991
1899890	1	3/8" Square	150mm	5	0042526930003
1899891	1	1/2" Square	150mm	5	0042526930010
1899892	1	1/4" Square	305mm	6	0042526930027
1899893	1	3/8" Square	305mm	6	0042526930034
1899894	1	1/2" Square	305mm	3	0042526930041
Product Code	Bits in Pack	Drive Size	Min Qty	Shelf Pack	Barcode
Bulk					
9097988	1	1/4" Square	152mm	10	9314244019874
9097989	1	3/8" Square	152mm	10	9314244019881
9097990	1	1/2" Square	152mm	10	9314244019898





Impact Metal Drilling

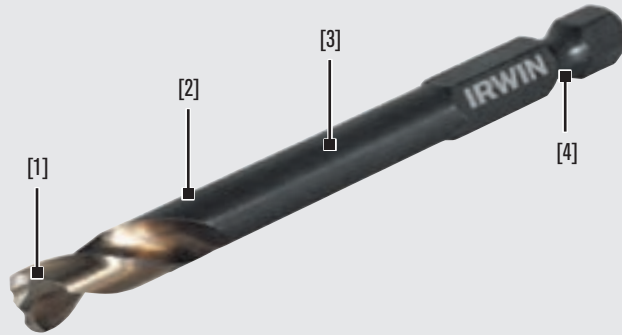

1. Exclusive JETPOINT™ tip minimises walking, delivers 10X faster starts, and stays sharp longer*
2. One-piece construction withstands higher torque loads than standard quick-change bits
3. Made from premium high speed steel with black oxide finish for added corrosion resistance
4. 1/4" quick-change shank is designed to work with impact drivers, and reduces slipping in standard drill chucks

Impact JETPOINT™ Bits



Product Code	Size	Overall Length	Flute Length	Shelf Pack	Barcode
Carded					
9097708	2.0mm	65mm	17mm	5	9314244018990
9097709	2.5mm	67mm	19mm	5	9314244019003
9097710	3.0mm	70mm	22mm	5	9314244019010
9097711	3.5mm	72mm	24mm	5	9314244019027
9097712	4.0mm	74mm	25mm	5	9314244019034
9097713	4.5mm	77mm	27mm	5	9314244019041
9097714	5.0mm	78mm	27mm	5	9314244019058
9097715	5.5mm	80mm	27mm	5	9314244019065
9097716	6mm	82mm	27mm	5	9314244019072
9097717	6.5mm	84mm	27mm	5	9314244019089
9097718	8mm	92mm	32mm	5	9314244019096
9097719	10.0mm	98mm	38mm	5	9314244019102

Impact JETPOINT™ Bit Sets



Product Code	Bits in Pack	Contents	Shelf Pack	Barcode
Pro Set				
9097722	5	2, 3, 4, 5, 6mm	6	9314244019133
9097723	12	2, 2.5, 3, 3.5, 4, 4.5, 5, 5.5, 6, 6.5, 8, 10mm	6	9314244019140

Impact Masonry Drilling



1. Innovative pressed carbide tip with aggressive cutting angles for faster drilling and longer bit life
2. One-piece construction withstands higher torque loads than standard quick-change bits
3. Black oxide finish resists corrosion and increases life of bit
4. 1/4" quick-change shank is designed to work with impact drivers, and reduces slipping in standard drill chucks

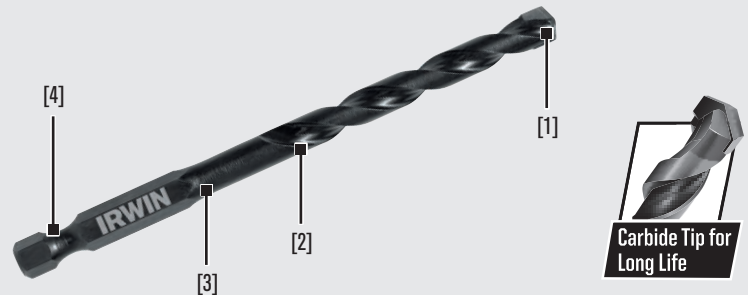

Impact Masonry Bits

Product Code	Size	Overall Length	Flute Length	Shelf Pack	Barcode
Carded					
9097688	3mm	100mm	54mm	5	9314244018792
9097689	4mm	100mm	54mm	5	9314244018808
9097690	5mm	100mm	54mm	5	9314244018815
9097691	6mm	100mm	54mm	5	9314244018822
9097692	4mm	150mm	95mm	5	9314244018839
9097693	5mm	150mm	95mm	5	9314244018846
9097694	6mm	150mm	95mm	5	9314244018853

Impact Tapcon® Installation Drill / Drive System

1. Built-in hex collar serves as a stop feature for drilling the perfect hole depth for Tapcon® screws and other concrete screws
2. Drill / drive installation sleeve slides over bit and engages with hex collar to quickly drive hex or Phillips® head fasteners
3. One-piece construction withstands higher torque loads than standard quick-change bits
4. 1/4" quick-change shank is designed to work with impact drivers, and reduces slipping in standard drill chucks

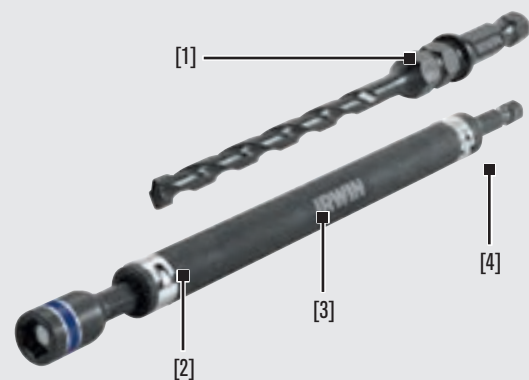

Impact Tapcon Installation Bits

Product Code	Size	Overall Length	Flute Length	Shelf Pack	Barcode
Carded					
1870565	5/32"	100mm	57mm	5	0042526914386
1870566	5/32"	127mm	82mm	5	0042526914393
1870567	3/16"	100mm	57mm	5	0042526914409
1870568	3/16"	127mm	82mm	5	0042526914416
1870569	3/16"	152mm	108mm	5	0042526914423





Impact Tapcon® Installation Drill / Drive System (continued)

Impact Tapcon Drive Sleeve

Product Code	Description	Shelf Pack	Barcode
Carded			
1900836	Install Sleeve	5	0042526930973

Impact Tapcon Installation Drill / Drive Sets

Product Code	Bits In Pack	Contents	Shelf Pack	Barcode
1881080	7	5/32" x 127mm, Drill Bit 3/16" x 127mm, Install Sleeve, 1/4" & 5/16" Nut Driver, PH#2 & PH#3 Power Bit	6	0042526922244
1881131	9	5/32" X 100mm, 5/32" X 127mm Drill Bit, 3/16" X 100mm 3/16" X 127mm Drill Bits, 1/4" & 5/16" Nut Driver, PH#2 & PH#3 Power Bits, Install Sleeve	6	0042526922251
1888627	4	5/32" X 127mm, Install Sleeve, 1/4" Nut Driver, PH#2 Power Bit	6	0042526924934
1888628	4	3/16" X 127mm, Install Sleeve, 5/16" Nut Driver, PH#3 Power Bit	6	0042526924941

Impact Adapters & Extensions

Impact Quick-Change Extension

- Patented jaw design is compatible with all 1/4" hex shank accessories including insert bits
- Large chuck withstands higher torque demands of impact drills
- 1/4" quick-change shank is designed to work with impact drivers, and reduces slipping in standard drill chucks



Product Code	Length	Head Diameter	Shelf Pack	Barcode
Hangtag				
1882442	63mm	18.9mm	3	0042526922923
1869516	152mm	18.9mm	3	0042526914164
1869517	305mm	18.9mm	3	0042526914171
1869518	457mm	18.9mm	3	0042526914188

Impact Right Angle Drive Tool

- Low profile right angle attachment for accessing tight spots
- Chuck accepts all standard 1/4" hex shank accessories including insert bits
- Constructed with steel gears and ball bearing drive for smooth drilling and long life
- Moulded handle for secure and comfortable grip
- All metal housing for durability



Product Code	Shelf Pack	Barcode
1902386	3	0042526932038

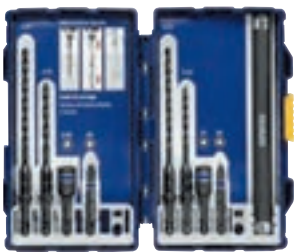

Impact Quick Change Adapter

- Adapts standard square drive chucks to 1/4" hex drive chucks that are compatible with impact drilling accessories
- Patented jaw design is compatible with all 1/4" hex shank accessories including insert bits
- Large chuck withstands higher torque demands of impact drivers

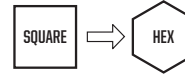

Product Code	Converts	Head Diameter	Length	Shelf Pack	Barcode
Hangtag					
1869511	1/4" Square to 1/4" Hex	18.9mm	63mm	3	0042526914119
1869512	3/8" Square to 1/4" Hex	18.9mm	63mm	3	0042526914126
1869513	1/2" Square to 1/4" Hex	18.9mm	63mm	3	0042526914133

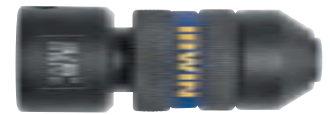

Impact Keyless Chuck Adapter

Product Code	Size	Shelf Pack	Barcode
Carded			
1869514	1mm-10mm	3	0042526914140



Impact Screw Extractors

- DoubleLok Technology™ ensures both ends of bit lock securely in impact drivers and quick-change chucks, enabling use of a single bit to remove stripped, damaged or rusted screws and small bolts in three easy steps: drill, flip bit, and extract
- Manufactured with M2 high speed steel and extra-hardened for maximum durability and long life with impact drivers
- Tip of drill end is designed to start fast with minimal walking, and tip of extractor end is serrated for increased torque to remove even the toughest bolts and screws

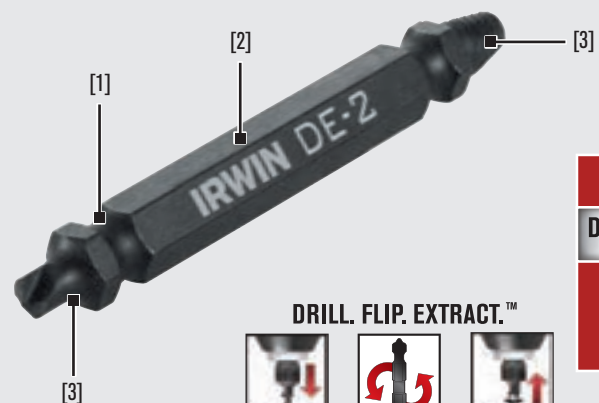

DRILL. FLIP. EXTRACT.™



	Screws - SAE								Bolts - SAE			Bolts - Metric		
	4	5	6-7	8	9-10	11-12	14	10-12	1/4"	5/16"	5	6	8	
DE1	X	X	X					X			X			
DE2				X	X				X			X		
DE3						X	X			X			X	

Impact SCREW-GRIP™ Double-Ended Screw Extractors

Product Code	Type	Length	Tip Length	Extractor Length	Removes Bolts	Removes Screws	Shelf Pack	Barcode
Carded								
1876221	DE-1	50mm	3.30mm	3.81mm	10-12 / 5mm	4, 5, 6, 7	5	0042526916526
1876222	DE-2	50mm	3.30mm	3.81mm	1/4" / 6mm	8, 9, 10	5	0042526916533
1876223	DE-3	50mm	3.30mm	3.81mm	5/16" / 8mm	11, 12, 14	5	0042526916540



Impact SCREW-GRIP™ Double-Ended Screw Extractor Sets

Product Code	Bits in Pack	Contents	Shelf Pack	Barcode
Carded				
1876224	3	DE-1 DE-2 DE-3	6	0042526916557



Impact BOLT-GRIP® Extractors

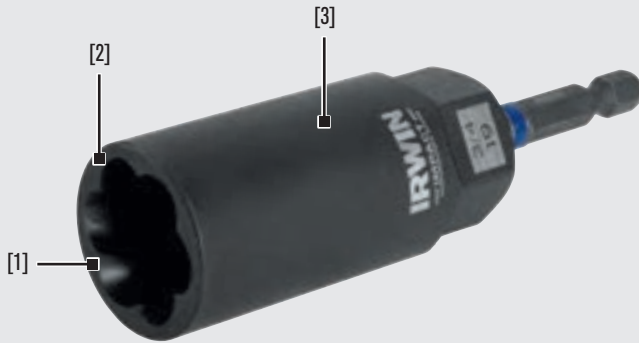

1. Reverse spiral flutes engineered to provide maximum gripping power to easily remove broken, damaged, or rusted nuts, bolts and screws
2. Universal lobular design fits all types of fasteners
3. High carbon steel ensures longer life and greater durability

Impact BOLT-GRIP® Bolt Extractors



Product Code	Size	Base Hex OAW	Head OAW	Length	Drive Size	Shelf Pack	Barcode
Clamshell							
1859101	1/4" / 6mm	15.88mm	10.72mm	63.5mm	3/8"	5	0673765178835
1859102	5/16" / 8mm	15.88mm	12.7mm	63.5mm	3/8"	5	0673765178842
1859103	3/8"	15.88mm	15.48mm	63.5mm	3/8"	5	0673765178859
1859104	10mm	19.05mm	15.48mm	63.5mm	3/8"	5	0673765178866
1859105	7/16" / 11mm	19.05mm	17.46mm	63.5mm	3/8"	5	0673765178873
1859106	12mm	19.05mm	19.05mm	63.5mm	3/8"	5	0673765178880
1859107	1/2"	19.05mm	19.45mm	63.5mm	3/8"	5	0673765178897
1859108	13mm	19.05mm	19.45mm	63.5mm	3/8"	5	0673765178903
1859109	9/16" / 14mm	22.23mm	20.64mm	63.5mm	3/8"	5	0673765178910
1859110	5/8" / 16mm	22.23mm	20.64mm	63.5mm	3/8"	5	0673765178927
1859111	17mm	25.4mm	25.4mm	63.5mm	3/8"	5	0673765178934
1859112	11/16"	25.4mm	25.4mm	63.5mm	3/8"	5	0673765178941
1881059	3/4" / 19mm	26.98mm	26.98mm	63.5mm	3/8"	5	0042526923302
1859113	3/4" / 19mm	31.75mm	28.57mm	63.5mm	1/2"	5	0673765178958
1859114	13/16" / 21mm	31.75mm	30.16mm	63.5mm	1/2"	5	0673765178965
1859115	7/8" / 22mm	36.51mm	34.98mm	63.5mm	1/2"	4	0673765178972
1859116	15/16" / 24mm	36.51mm	34.98mm	63.5mm	1/2"	5	0673765178989
1859117	1"	36.51mm	34.98mm	63.5mm	1/2"	5	0673765178996

Impact BOLT-GRIP® Deep Well Bolt Extractors

Product Code	Size	Base Hex OAW	Head OAW	Length	Drive Size	Shelf Pack	Barcode
Clamshell							
1859118	1/4" / 6mm	15.88mm	10.72mm	63.5mm	3/8"	5	0673765179009
1859119	5/16" / 8mm	15.88mm	12.7mm	63.5mm	3/8"	5	0673765179016
1859120	3/8"	15.88mm	15.48mm	63.5mm	3/8"	5	0673765179023
1859121	10mm	19.05mm	15.48mm	63.5mm	3/8"	5	0673765179030
1859122	7/16" / 11mm	19.05mm	17.46mm	63.5mm	3/8"	5	0673765179047
1859123	12mm	19.05mm	19.05mm	63.5mm	3/8"	5	0673765179054
1859124	1/2"	19.05mm	19.45mm	63.5mm	3/8"	5	0673765179061
1859125	13mm	19.05mm	19.45mm	63.5mm	3/8"	5	0673765179078
1859126	9/16" / 14mm	22.23mm	20.64mm	63.5mm	3/8"	5	0673765179085
1859127	5/8" / 16mm	22.23mm	20.64mm	63.5mm	3/8"	5	0673765179092
1859128	17mm	25.4mm	25.4mm	63.5mm	3/8"	5	0673765179108
1859129	11/16"	25.4mm	25.4mm	63.5mm	3/8"	5	0673765179115
1859130	3/4" / 19mm	26.98mm	26.98mm	63.5mm	3/8"	5	0673765179122
1881060	3/4" / 19mm	31.75mm	28.57mm	63.5mm	1/2"	5	0042526923319
1859131	13/16" / 21mm	31.75mm	30.16mm	63.5mm	1/2"	5	0673765179139
1859132	7/8" / 22mm	36.51mm	33.34mm	63.5mm	1/2"	5	0673765179146
1859133	15/16" / 24mm	36.51mm	34.98mm	63.5mm	1/2"	5	0673765179153
1859134	1"	36.51mm	34.98mm	63.5mm	1/2"	5	0673765179160



Engineered with reverse spiral flutes and extended reach to fit over exposed studs and easily grip and remove recessed fasteners including broken, damaged, or rusted nuts, bolts and screws

Impact BOLT-GRIP® Clam Sets

Product Code	Bits in Pack	Type	Contents	Shelf Pack	Barcode
Clam Set					
1859143	6	Standard	1/4" / 6mm, 5/16" / 8mm, 3/8", 7/16" / 11mm, 1/2", 1/4" to 3/8" Adapter	5	0673765178729
1859147	6	Deep Well	1/4" / 6mm, 5/16" / 8mm, 3/8", 7/16" / 11mm, 1/2", 1/4" to 3/8" Adapter	5	0673765178767



Impact BOLT-GRIP® Pro Sets

- Moulded ABS resin case holds up to rigours of daily use
- Full-length metal pin in hinge for added durability and life

Product Code	Bits in Pack	Type	Contents	Shelf Pack	Barcode
Pro Set					
1859148	8	Standard	1/4" / 6mm, 5/16" / 8mm, 3/8", 10mm, 7/16" / 11mm, 1/2", 9/16" / 14mm, 1/4" to 3/8" Adapter	5	0673765178774
1859149	8	Deep Well	1/4" / 6mm, 5/16" / 8mm, 3/8", 10mm, 7/16" / 11mm, 12mm, 1/2", 1/4" to 3/8" Adapter	5	0673765178781



Impact BOLT-GRIP® Extractors (continued)

Impact BOLT-GRIP® Rail Sets

- Powerful rare earth magnets, with 4X the hold of standard magnets, for secure attachment to work and storage surfaces
- Non-mar foam backing to protect against scratches
- Clips feature ball-lock retention design for easy on / off storage



Product Code	Bits in Pack	Type	Contents	Shelf Pack	Barcode
Rail Set					
1876226	8	Standard	1/4" / 6mm, 5/16" / 8mm, 3/8", 10mm, 7/16" / 11mm, 12mm, 1/2", 1/4" to 3/8" Adapter	3	0042526916571
1876228	14	Standard	1/4" / 6mm, 5/16" / 8mm, 3/8", 10mm, 7/16" / 11mm, 12mm, 1/2", 13mm, 9/16" / 14mm, 5/8" / 16mm, 17mm, 11/16", 3/4" / 19mm 3/8" Drive, 1/4" to 3/8" Adapter	3	0042526916595
1876227	8	Deep Well	1/4" / 6mm, 5/16" / 8mm, 3/8", 10mm, 7/16" / 11mm, 12mm, 1/2", 1/4" to 3/8" Adapter	3	0042526916588
1876229	14	Deep Well	1/4" / 6mm, 5/16" / 8mm, 3/8", 10mm, 7/16" / 11mm, 12mm, 1/2", 13mm, 9/16" / 14mm, 5/8" / 16mm, 17mm, 11/16", 3/4" / 19mm 3/8" Drive, 1/4" to 3/8" Adapter	3	0042526916601
Rail Expansion Set					
1881175	6	Standard	13mm, 9/16" / 14mm, 5/8" / 16mm, 17mm, 11/16", 3/4" / 19mm 3/8" Drive	5	0042526923142
1881456	6	Deep Well	13mm, 9/16" / 14mm, 5/8" / 16mm, 17mm, 11/16", 3/4" / 19mm 3/8" Drive	5	0042526923296

Impact BOLT-GRIP® Drawer Sets

- Compact, flat design for convenient storage in drawers and tool cabinets
- Moulded ABS resin case holds up to rigours of daily use



Product Code	Bits in Pack	Type	Contents	Shelf Pack	Barcode
Clam Set					
1859150	8	Standard	1/4" / 6mm, 5/16" / 8mm, 3/8", 10mm, 7/16" / 11mm, 12mm, 1/2", 1/4" to 3/8" Adapter	5	0673765178798
1859152	19	Standard	1/4" / 6mm, 5/16" / 8mm, 3/8", 10mm, 7/16" / 11mm, 12mm, 1/2", 13mm, 9/16" / 14mm, 5/8" / 16mm, 17mm, 11/16", 3/4" / 19mm 1/2 Drive, 13/16" / 21mm, 7/8" / 22mm, 15/16" / 24mm, 1", 1/4" to 3/8" Adapter, 1/4" to 1/2" Adapter	5	0673765178811
1859151	8	Deep Well	1/4" / 6mm, 5/16" / 8mm, 3/8", 10mm, 7/16" / 11mm, 12mm, 1/2", 1/4" to 3/8" Adapter	5	0673765178804
1859153	14	Deep Well	1/4" / 6mm, 5/16" / 8mm, 3/8", 10mm, 7/16" / 11mm, 12mm, 1/2", 13mm, 9/16" / 14mm, 5/8" / 16mm, 17mm, 11/16", 3/4" / 19mm 3/8" Drive, 1/4" to 3/8" Adapter	5	0673765178828

Impact Square Drive Extensions

Product Code	Bits in Pack	Type	Contents	Shelf Pack	Barcode
Hangsell					
1877496	1	3/8" Square	305mm	6	0042526917103
1877497	3	3/8" Square	76,150,305mm	6	0042526917110
1877494	1	3/8" Square	76mm	6	0042526917080
1877495	1	3/8" Square	150mm	6	0042526917097

Impact Square Drive Reducers

Product Code	Bits in Pack	Insert Size	Drive Size	Shelf Pack	Barcode
Hangsell					
1877498	1	1/2" Square	3/8" Square	6	0042526917127
1877499	1	3/8" Square	1/4" Square	6	0042526917134

Impact Socket Adapters



Product Code	Bits in Pack	Type	Contents	Shelf Pack	Barcode
Hangsell					
1837571	1	1/4" Square	50mm	5	0673765171058
1837572	1	3/8" Square	50mm	5	0673765171065
1837573	1	1/2" Square	50mm	5	0673765171072
1899889	1	1/4" Square	150mm	5	0042526929991
1899890	1	3/8" Square	150mm	5	0042526930003
1899891	1	1/2" Square	150mm	5	0042526930010
1899892	1	1/4" Square	305mm	6	0042526930027
1899893	1	3/8" Square	305mm	6	0042526930034
1899894	1	1/2" Square	305mm	3	0042526930041
Product Code	Bits in Pack	Type	Contents	Min Qty	Barcode
Bulk					
9097988	1	1/4" Square	152mm	10	9314244019874
9097989	1	3/8" Square	152mm	10	9314244019881
9097990	1	1/2" Square	152mm	10	9314244019898



Standard Insert Bits

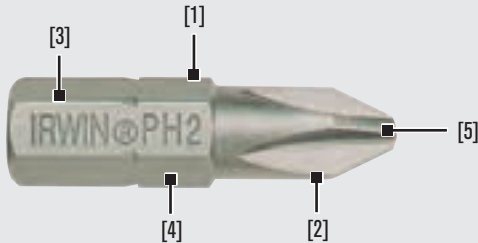

1. Tough shock grade S2 alloy tool steel
2. Tough durable bits with Rockwell Hardness between 58-62 HRC
3. 1/4" hex for use in bit holders
4. Retaining ring notch
5. Available in a wide variety of tip configurations to fit many different applications

Phillips® Head Insert Bits



Product Code	Bits in Pack	Insert Size	Length	Shelf Pack	Barcode
Carded					
351011XC	10	PH#2	25mm	5	0673765012900
Product Code	Quantity	Insert Size	Length	Min Qty	Barcode
Bulk					
92039S	1	PH#2	51mm	25	9314244003712
92045S	1	PH#2	64mm	25	9314244003729
357320	20	PH#2	25mm	10	0673765014003



Phillips® Drywall Screwsetter Insert Bits



- Bits designed specifically for use with Phillips® drywall screws

Product Code	Bits in Pack	Insert Size	Length	Shelf Pack	Barcode
Carded					
3510641C	1	PH#2	25mm	5	0673765013013



Hex Head Insert Bits



- Designed for a tighter fit in fasteners

Product Code	Bits in Pack	Insert Size	Length	Shelf Pack	Barcode
Bulk					
92513S	1	5mm	32mm	10	9314244002678

Standard Power Bits

1. Tough durable bit with rockwell hardness between 58-62 HRC
2. Tough shock grade S2 alloy tool steel
3. Bearing groove for use in Quick-Change adapters
4. Available in a wide range of tip configurations to suit many different applications
5. 1/4" hex end



Phillips® Head Power Bits



Product Code	Bits in Pack	Insert Size	Length	Shelf Pack	Barcode
Carded					
3520251C	1	PH#2	89mm	5	673765013464
3520671C	1	PH#2	150mm	5	673765013488
3520075C	5	PH#2	49mm	5	673765013426
3521993C	3	PH#1 PH#2, PH#3	49mm	5	673765013501
Product Code	Quantity	Insert Size	Length	Min Qty	Barcode
Bulk					
93017S	10	PH#1	69mm	10	9314244002548
93019S	10	PH#2	69mm	10	9314244002555
93047S	10	PH#2	75mm	10	9314244002562
93025S	10	PH#2	89mm	10	9314244002579
93057S	10	PH#2	100mm	10	9314244002586
93067S	10	PH#2	150mm	10	9314244002593

Phillips® Head Double Ended Power Bits



Product Code	Bits in Pack	Insert Size	Length	Shelf Pack	Barcode
Carded					
3054013E	10	PH#2	45mm	5	9314244004306
3054012E	10	PH#2	76mm	5	9314244004290



Note: Phillips® is a registered trademarks of the Phillips Screw Company

Standard Power Bits (continued)

POZIDRIV® Power Bits

- Design allows closer fit to reduce cam out
- Tough durable bit with rockwell hardness between 58-62 HRC
- Tough shock grade S2 alloy tool steel
- Bearing groove for use in Quick-Change adapters



Product Code	Bits in Pack	Insert Size	Length	Shelf Pack	Barcode
Carded					
3052007E	1	#1	49mm	5	0673765020967
3052008E	1	#2	49mm	5	0673765020974
3052011E	1	#2	70mm	5	0673765021001
Product Code	Quantity	Insert Size	Length	Min Qty	Barcode
Bulk					
93077S	10	#2	49mm	10	9314244002388

Hex Head Power Bits

- Designed for a tighter fit in fastener



Product Code	Bits in Pack	Insert Sizes	Length	Shelf Pack	Barcode
Carded					
3054014C	5	5mm	49mm	5	9314244010383
Product Code	Quantity	Insert Sizes	Length	Min Qty	Barcode
Bulk					
3054014BS	1	5mm	49mm	10	9314244004252

Nutsetters

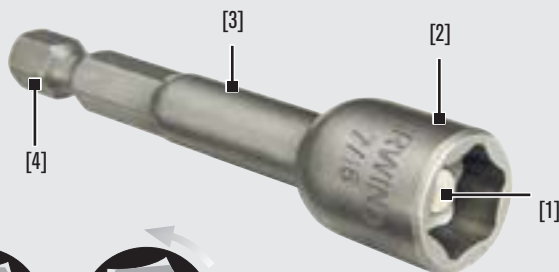

1. Uses a rare earth magnet that is 4 times stronger than common magnets
2. Uses lobular design hex drive to deliver less stripping of fasteners
3. Tough shock grade S2 alloy tool steel
4. 1/4" hex body for use in power tools and Quick-Change adapters

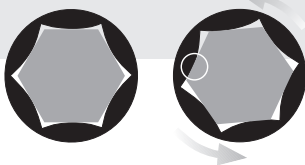

Lobular Design Drive

- Drives the fastener on the side instead of forcing the corners to turn
- Maintains the true shape of the fastener, dramatically reducing breakage and stripping damage
- Provides more clearance on the corners of the fastener where paint build-up can occur

Product Code	Quantity	Insert Size	Length	Min Qty	Barcode
Bulk					
94712S	1	1/4"	47mm	10	9314244003309
94732S	1	5/16"	47mm	10	9314244003316
94752S	1	3/8"	47mm	10	9314244003323
94812S	1	1/4"	64mm	10	9314244003330
94832S	1	5/16"	64mm	10	9314244003347
94852S	1	3/8"	64mm	10	9314244003354

Note: POZIDRIV® is a registered trademarks of the Phillips Screw Company

Insert Bit Holders

- Tough shock grade S2 alloy tool steel
- Rare earth magnet 4 times stronger than standard magnets
- Bearing groove for use in Quick-Change adapters
- 1/4" hex end
- Designed for use with insert bits only but can be used with a socket wrench or socket adapter

Product Code	Quantity	Insert Sizes	Length	Min Qty	Barcode
Bulk					
93712S	1	1/4"	57mm	10	9314244003675
93718S	1	1/4"	76mm	10	9314244003682



Retracting Sleeve Screw Guides

- Tough shock grade S2 alloy tool steel
- Retracting sleeve to guide in screws
- Rare earth magnet 4 times stronger than standard magnets
- Bearing groove for use in Quick-Change adapters
- 1/4" hex end
- Designed for use with insert bits only

Product Code	Bits in Pack	Insert Sizes	Length	Shelf Pack	Barcode
Carded					
3555511C	10	1/4"	76-120mm	5	0673765013914
Bulk					
93551S	1	1/4"	76-120mm	5	9314244003651



Socket Adapters

1. Ball retention design for Quick-Change applications
2. Tough shock grade S2 alloy tool steel
3. Tough durable bits with Rockwell Hardness between 58-62 HRC
4. Bearing groove for use in Quick-Change adapters
5. 1/4" hex end

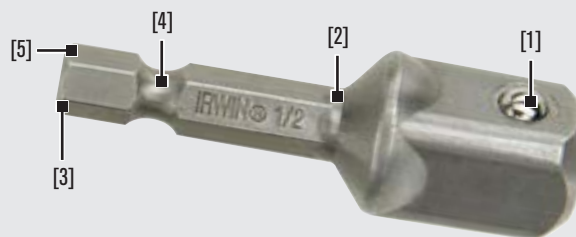

Product Code	Bits in Pack	Insert Sizes	Length	Shelf Pack	Barcode
Carded					
3567611C	1	1/4"	50mm	5	0673765013938
3567841C	1	3/8"	50mm	5	0673765013945
3567951C	1	1/2"	50mm	5	0673765013952
Bulk					
93761S	1	1/4"	50mm	10	9314244002708
93784S	1	3/8"	50mm	10	9314244002715
93795S	1	1/2"	50mm	10	9314244002722

Fastener Drive Sets

Screwdriver Bit 7pc Set



Product Code	Bits in Pack	Shelf Pack	Barcode
3057011DSAU	7	6	9314244003972

Bit Description	Quantity	Bit Description	Quantity
Magnetic Screwguide 76mm	1	POZIDRIV® #2 25mm	1
Phillips® #2 25mm	3	Slotted 8-10 25mm	2

Screwdriver Bit 13pc Set



Product Code	Bits in Pack	Shelf Pack	Barcode
3057013DSAU	13	6	9314244003989

Bit Description	Quantity	Bit Description	Quantity
Phillips® #1 25mm	1	Pozidriv® #2 25mm	2
Phillips® #2 25mm	4	Slotted 8-10 25mm	2
Phillips® #3 25mm	1	Magnetic Bit Holder 120mm	1
Pozidriv® #1 25mm	2		

Screwdriver Bit 21pc Set



Product Code	Bits in Pack	Shelf Pack	Barcode
3057002DSAU	21	6	9314244003996

Bit Description	Quantity	Bit Description	Quantity
Magnetic Screwguide 120mm	1	Slotted 8-10 25mm	5
Phillips® #2 25mm	15		

Quick-Change Screwdriver Bit 7pc Set



Product Code	Bits in Pack	Shelf Pack	Barcode
3057003DS	7	6	0673765087359

Bit Description	Quantity	Bit Description	Quantity
Lock-n-Load™ Extension 50mm	1	Slotted 8-10 49mm	1
Phillips® #1 49mm	1	Square Recess #2 49mm	2
Phillips® #2 49mm	2		

Screwdriver Bit 16pc Case Set



Product Code	Bits in Pack	Shelf Pack	Barcode
3057014AU	16	6	9314244004016

Bit Description	Quantity	Bit Description	Quantity
Phillips® #1 25mm	1	Nutsetter 5/16" 47mm	1
Phillips® #2 25mm	2	Nutsetter 3/8" 47mm	1
Phillips® #3 25mm	1	Phillips® #2 49mm	2
Pozidriv® #2 25mm	2	Pozidriv® #2 49mm	1
Slotted 8-10 25mm	1	Slotted 6-8 49mm	1
Magnetic Bit Holder 57mm	1	Slotted 8-10 49mm	1
Nutsetter 1/4" 47mm	1		

Screwdriver Bit 24pc Case Set

Product Code	Bits in Pack	Shelf Pack	Barcode
3057015AU	24	6	9314244004023

Bit Description	Quantity	Bit Description	Quantity
Phillips® #1 25mm	1	Nutsetter 1/4" 47mm	1
Phillips® #2 25mm	5	Nutsetter 5/16" 47mm	1
Phillips® #3 25mm	1	Nutsetter 3/8" 47mm	1
Pozidriv® #1 25mm	2	Phillips® #2 49mm	2
Pozidriv® #2 25mm	4	Pozidriv® #2 49mm	1
Slotted 8-10 25mm	1	Slotted 8-10 25mm	1
Magnetic Screw Guide 76mm	1	Phillips® #2 100mm	1
Pozidriv® #2 100mm	1		



Screwdriver Bit 33pc Case Set

Product Code	Bits in Pack	Shelf Pack	Barcode
3057017	33	6	973765089292

Bit Description	Quantity	Bit Description	Quantity
Phillips® #1 25mm	2	Slotted 8-10 25mm	2
Phillips® #2 25mm	12	Slotted 10-12 25mm	1
Phillips® #3 25mm	2	Magnetic Bit Holder 57mm	1
Square Recess #1 25mm	1	Nutsetter 1/4" 47mm	1
Square Recess #2 25mm	5	Nutsetter 5/16" 47mm	1
Square Recess #3 25mm	1	Nutsetter 3/8" 47mm	1
Slotted 6-8 25mm	2	Phillips® #2 49mm	1

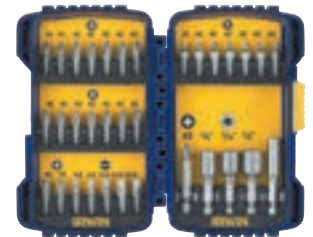

Fastener Drive 34pc Case Set

Product Code	Bits in Pack	Shelf Pack	Barcode
3057034	34	1	0673765021766

Bit Description	Quantity	Bit Description	Quantity
Phillips® #1 49mm	1	Phillips® #1 150mm	1
Phillips® #2 49mm	1	Phillips® #2 150mm	1
Phillips® #3 49mm	1	Phillips® #3 150mm	1
Pozidriv® #1 49mm	1	Pozidriv® #2 150mm	1
Pozidriv® #2 49mm	1	Torx® T15 150mm	1
Pozidriv® #3 49mm	1	Torx® T20 150mm	1
Torx® T8 49mm	1	Torx® T25 150mm	1
Torx® T9 49mm	1	Torx® T27 150mm	1
Torx® T10 49mm	1	Torx® T30 150mm	1
Phillips® #1 89mm	1	Socket Adapter 1/4" 50mm	1
Phillips® #2 89mm	1	Socket Adapter 3/8" 50mm	1
Phillips® #3 89mm	1	Socket Adapter 1/2" 50mm	1
Pozidriv® #2 89mm	1	Nutsetter 5/16" 47mm	1
Torx® T15 89mm	1	Nutsetter 3/8" 47mm	1
Torx® T20 89mm	1	Nutsetter 1/2" 47mm	1
Torx® T25 89mm	1	Lock-n-Load™ Extension 50mm	1
Torx® T30 89mm	1	Lock-n-Load™ Extension 150mm	1



Phillips® & POZIDRIV® are registered trademarks of the Phillips Screw Company
 Note: TORX® is a registered trademark of the Camcar, a division of Textron Industries

NEWELL AUSTRALIA PTY LTD (ACN 075 071 233)

TERMS AND CONDITIONS OF SALE

DEFINITIONS:

'BUYER'	means the purchaser of any goods specified on a purchaser order to the Company.
'COMPANY'	means Newell Australia Pty Ltd (ACN 075 071 233) (Newell).
'CONSUMER'	means an individual who buys products for personal use and not for manufacture or resale.
'GOODS'	means the products and, if any, services specified on a purchase order from the Buyer to the Company.
'GST'	means Goods and Services Tax in Australia as determined in accordance with the GST Act.
'GST ACT'	means the A New Tax System (Goods and Services) Act 1999.
'PPSA'	means the Personal Properties Securities Act 2009.
'PMSI'	means a purchase money security interest as defined by the PPSA.
"SECURITY INTEREST"	and "purchase money security interest", "attached", "attachment", "perfected", "accession", "commingled" and all related terms have the meanings given them by the PPSA.

1. GENERAL

- i. These Terms and Conditions of trade (Terms and Conditions) and the Company's Privacy Policy <http://newellrubbermaid.com/customer/terms-and-conditions/AU/Pages/PrivacyPolicy.aspx> (Privacy Policy) apply to all sales of goods by the Company to the Buyer (including any sale to which a quotation relates) and supersede any previous terms of trade applying between the Company and the Buyer (however communicated). These Terms and Conditions and the Privacy Policy prevail over any Buyer's terms of trade so that any sale by the Company is on these Terms and Conditions and the Privacy Policy only.
- ii. Notwithstanding clause i, the Company may change these Terms and Conditions at its own discretion and such amended Terms and Conditions will be either posted on the Company's website <http://newellrubbermaid.com/customer/terms-and-conditions/AU/Pages/Home.aspx> or provided in writing to the Buyer and will apply to all Goods ordered by the Buyer from the date of such notice.
- iii. Notwithstanding clause i, the Company may change and/or update its Privacy Policy from time to time in line with relevant Australian privacy laws. The Company will notify the Buyer of material changes in the way it treats personally identifiable information by placing a notice on the Company's website or by writing to and/or emailing the Buyer. Such an amended Privacy Policy will apply to all personal information of the Buyer collected, held, used and disclosed by the Company.

2. PRICING AND DELIVERY

- i. The price of the Goods is to be calculated by reference to the Company's current price list.
- ii. The prices and product specifications contained in the Company's price list are subject to change at the absolute discretion of the Company and without notice to the Buyer.
- iii. The Buyer agrees that the delivery docket signed, whether by any employee of the Buyer or any other person signing for or on behalf of the Buyer, shall be conclusive evidence of delivery.
- iv. The Company will deliver FIS (free into store) for orders over the value of \$350.00 (excluding Northern Territory), or over the value of \$500 for Northern Territory (order values are excluding GST), otherwise the Company reserves the right to charge for freight.

3. ORDERS

- i. An order for Goods constitutes an offer to purchase the Goods by the Buyer subject to these Terms and Conditions.
- ii. Orders accepted by the Company may not be cancelled or altered in whole or in part without the Company's written consent.
- iii. The Company may at its absolute discretion decline any order either in whole or in part.
- iv. The Company reserves the right to specify the minimum order value that will be accepted from time to time. The Company may at the Company's absolute discretion, supply orders below the specified minimum order value and charge a handling fee, as determined by the Company, on all such orders.
- v. The Company reserves the right to charge a \$20.00 handling fee (plus GST) on orders of less than the value of \$350.00 (excl. GST).
- vi. In placing any order the Buyer expressly represents that the Buyer:
 - a. Is solvent; and
 - b. Has not committed an act of bankruptcy; and
 - c. knows of no circumstances which would entitle any creditor or secured creditor to appoint a receiver or which would entitle any creditor or shareholder to apply to the Court to liquidate the Buyer or exercise any other rights over or against the Buyers' assets.

4. TERMS OF PAYMENT

- i. All invoices are due and payable in full on the last banking day of the month following the date of invoice.
- ii. Should the Buyer fail to pay the Company's invoices by the due date then:

- iii. The Company may charge interest on any overdue invoice at the penalty rate fixed under the Penalty Interest Rate Act 1983 (Victoria) calculated and payable daily, compounded from the due date until the invoice is paid in full, and;
- iv. The Buyer shall pay all of the Company's costs and expenses (including legal costs determined as between solicitor/own client and mercantile agents fees) which may be incurred in the recovery or attempted recovery of the overdue amounts from the Buyer.
- v. The Company may set off any amount owed by the Company to the Buyer from any amount due by the Buyer to the Company.
- vi. The Company reserves the right to charge an additional fee for accepting payment by credit card.

5. GOODS AND SERVICES TAX ('GST')

- i. All prices will be quoted exclusive of GST. However, all goods will be sold on a 'plus GST (if any)' basis.
- ii. Any discounts or other terms agreed between the Buyer and the Company will be calculated on and applied to the Purchase Price exclusive of GST.
- iii. Payment for GST
 - a. If GST is imposed on any supply made by the Company to the Buyer pursuant to these Terms and Conditions (the GST Amount), the Buyer must pay the GST Amount to the Company, in addition to any amount payable, and any non-cash consideration provided, for that supply (without any deduction or set-off) by the Buyer under any other clause in these Terms and Conditions). Any GST Amount payable is payable upon demand by the Company whether such demand is by means of any invoice or otherwise.
 - b. If any part of the Purchase Price is referable to both a Taxable Supply (as defined in the GST Law) and anything that is not a Taxable Supply, the apportionment of the purchase price between those supplies shall be determined by the Company, and GST applied accordingly.
 - c. If the Company determines on reasonable grounds that an adjustment is required to the purchase price, it will promptly issue any 'Adjustment Notes' that are prescribed by the GST Law.

6. WARRANTY

- i. This clause is to be read together with any benefits that the Company may provide under Australian statute.
- ii. The Goods are guaranteed against defects in material or workmanship subject to fair and proper usage.
- iii. The Buyer is not authorised to issue replacements to their customers for the Company's products without prior written approval from the Company.
- iv. The Buyer shall immediately notify the Company in writing of any defect in the Goods supplied.
- v. Nothing in these Terms and Conditions purports to modify or exclude the conditions, warranties, guarantees and undertakings, and other legal rights, under the Australian Consumer Law and other Australian laws which cannot be modified or excluded. Except as expressly set out in these Terms and Conditions and as required by the Australian Consumer Law, the Company makes no warranties or other representations to the Buyer. The Company's liability in respect of these warranties, representations, undertakings and guarantees is limited to the fullest extent permitted by law. Any warranties made by the Company to the ultimate consumer of the Goods is solely for the benefit of the Consumer, and no Buyer purchasing goods for resale shall be entitled to bring claims under any such warranties.
- vi. Without limiting the above clauses:
 - a. Our goods come with guarantees that cannot be excluded under the Australian Consumer Law. A Consumer is entitled to a replacement or refund for a major failure and for compensation for any other reasonably foreseeable loss or damage. A Consumer is also entitled to have the goods repaired or replaced if the goods fail to be of acceptable quality and the failure does not amount to a major failure.
 - b. To the extent permitted by statute, the liability, if any, of the Company arising from the breach of any implied conditions or warranties, or failure to comply with a statutory guarantee under the Australian Consumer Law, in relation to the supply of Goods, shall at the Company's option be limited to:
 - c. the replacement of the Goods or resupply of the Goods, or the cost of replacement or resupply of the Goods;
 - d. refund of the Purchase Price; or
 - e. the repair of the Goods, or the cost of repair of the Goods.
 - f. Subject to clauses 6.vi(a) and 6.vi(b), the Company shall not in any circumstances be liable to the Buyer under or in connection with these Terms and Conditions, or in negligence or any other tort or otherwise howsoever, as a result of any act or omission in the course of or in connection with the performance of these Terms and Conditions, for or in respect of any excluded loss.
 - g. Unless otherwise specified, this warranty does not cover:
 - h. Modified, abused, neglected, accidentally damaged or excessively worn Goods, or Goods that have become damaged or defective as a result of improper use;
 - i. Repairs attempted or made by the Buyer, a Consumer or a third party;

- j. Conditions or malfunctions caused by the reasonable effects of fair wear and tear or the malfunction of normally wearing parts;
- k. Products that are not distributed by the Company through an authorised distributor or reseller.
- vii. Unless otherwise specified, the process for making a warranty claim as a Consumer is as follows:
 - a. Any Good subject to a warranty claim should be returned to the place of purchase for assessment by an authorised distributor or the Company representative. The Consumer is responsible for returning the Good to the place of purchase unless the cost of returning, removing or transporting the product is significant, in which case the Consumer should contact the Company to make alternative arrangements.
 - b. The Consumer must present proof of purchase when making a warranty claim.
 - c. The claim under a warranty (the Consumer may have additional rights under the Australian Consumer Law) will be assessed by the Company, authorised distributor or representative on the basis of their product knowledge and reasonable judgment (subject to clause 6.vi(d)) and will be accepted if:
 - I. a relevant defect is found; and
 - II. the warranty claim is made during the relevant warranty period.
 - d. Upon acceptance of a claim under a warranty, the Company will arrange a replacement product or arrange for the product to be repaired free of charge.
 - e. Any warranty related enquiries or claims should be directed to:
Newell Rubbermaid
500 Princes Highway
Noble Park, Victoria 3174
Customer Service: 1800 331 491
Customer Service (WA): 1800 282 866
- viii. Unless otherwise specified, the process for making a warranty claim by or on behalf of a Consumer is as follows:
 - a. The Company must be informed as soon as the warranty claim arises;
 - b. The original proof of purchase along with the written description of the fault must be provided;
 - c. If the warranty claim is accepted, the Company will, at its cost, credit, repair or replace any faulty parts or rectify any faulty workmanship.

7. OTHER CLAIMS

- i. Any claims by the Buyer for short or wrongful delivery of the Goods must be notified to the Company in writing within seven days after delivery of the Goods to the Buyer and any claim which the Buyer does not notify within the time aforesaid (time being of the essence) shall be deemed to have been absolutely waived.
- ii. Any claims by the Buyer associated with trade promotions in relation to the Company's products must be made in writing within 3 months of completion of the trade promotion and must be accompanied by copies of all documents that are necessary to justify the Buyer's claim.
- iii. Any other claims for adjustment to any invoice for any reason whatsoever must be made in writing within the prescribed time periods provided by law.

8. RETURN OF GOODS

- i. The Company will not accept returns for credit, other than defective Goods and warranty claims for which a credit or refund is required by law, without prior authorization. To the greatest extent permitted by law, the Buyer's rights and remedies in respect of any defective Goods and warranty claims will be limited to the return of the relevant Goods for credit in accordance with this clause 8.
- ii. Any Goods which the Buyer returns for credit, other than defective Goods and warranty claims will only be accepted if they are in the original packaging and in as new saleable order and condition.
- iii. If the Company authorises the return of Goods a Return Authority (RA) will be raised and the RA number must be quoted by the Buyer on or with any claim documentation sent with the Goods, which must be sent freight pre-paid or otherwise, if approved by the Company, carried by the Company's nominated carrier.
- iv. The Company reserves the right, except for credits for defective Goods, to charge a handling fee equal to the greater of 15% of the credit value (plus GST) or \$20 and to deduct this fee from the credit amount.

9. IMPLIED TERMS

- i. It is hereby acknowledged by the Buyer that, under the Australian Consumer Law, certain conditions and warranties may be implied in the contract between the Company and the Buyer and rights and remedies conferred upon the Buyer and other parties in relation to Goods or services which cannot be excluded, restricted or modified by agreement ("Non-excludable Rights"). The limitations below are subject to these Non-excludable Rights.

- ii. Subject to the clause 9.i, the Company disclaims all conditions and warranties expressed or implied, and rights and remedies conferred on the Buyer or other parties, by statute the common law, equity, trade, custom or usage or otherwise howsoever and all such conditions and warranties and such rights and remedies are hereby expressly excluded other than any Non-excludable Rights.
- iii. The Company's liability under s74 of the Competition and Consumer Act 2010 (CCA) is expressly limited to a liability to pay or credit to the purchaser an amount equal to:
 - a. the cost of replacing the Goods;
 - b. the cost of obtaining equivalent Goods; or
 - c. the cost of having the Goods repaired, whichever is the lowest amount.
- iv. Where so permitted the liability of the Company for a breach of a Non-excludable Right is limited, at the Company's option, in the case of Goods, to the replacement or repair of the Goods or the supply of equivalent Goods or the cost of replacing or repairing the Goods or of acquiring equivalent Goods and, in the case of services, to the supplying of the services again or the payment of the cost of having the services supplied again.
- v. Accordingly, subject to clause 9.i, in no event shall the Company be liable (whether before or after discharge of the contract or otherwise) for any loss or damage to the Buyer howsoever arising including any loss or damage arising from or caused or contributed to by negligence of the Company, its servants or agents, nor shall the Company be liable for special, incidental, indirect or consequential loss or damage suffered by the Buyer as a result of a breach by the Company of its obligations or otherwise including but not limited to economic or moral loss, loss of profits or revenue or costs arising from such breach.

10. INDEMNITY

- i. Subject to Clause 9, the Buyer shall indemnify and keep indemnified and hold the Company harmless from and against all liabilities, losses, damages, costs or expenses incurred or suffered by the Company, and from and against all actions, proceedings, claims or demands made against the Company, arising from one or more of the following:
 - a. As a result of the Buyer's failure to comply with any laws, rules, standards or regulations applicable in relation to the Goods or the use of the Goods;
 - b. As a result of any other negligence or other breach of duty by the Buyer; or
 - c. As a result of any compliance or adherence by the Company with any instructions of the Buyer in relation to the Goods or their manner of fabrication.

11. RIGHTS IN RELATION TO THE GOODS

- i. In connection with the Goods while they remain the property of the Company, the Buyer agrees with the Company that:
 - a. The Buyer has no right or claim to any interest in the Goods to secure any liquidated or unliquidated debt or obligation the Company owes to the Buyer;
 - b. The Buyer cannot claim any lien over the Goods;
 - c. The Buyer will not create any absolute or defeasible interest in the Goods in relation to any third party except as may be authorised by the Company;
 - d. Where the Buyer is in actual or constructive possession of the Goods:
 - I. The Buyer will not deliver them or any document of title to the Goods to any person except as directed by the Company; and
 - II. It is in possession of the Goods as a bailee of those Goods and owes the Company the duties and liabilities of a bailee.
- ii. In connection with the Goods, the Company states to the Buyer that:
 - a. The Company has the right to supply the Goods to the Buyer; and
 - b. If the Goods are not owned by the Company, that the Company is authorised to supply the Goods to the Buyer.
- iii. The Company and the Buyer agree that:
 - a. All risk of loss in respect of the Goods transfers to the Buyer upon completion of the Company's delivery obligations;
 - b. The property of the Company in the Goods remains with the Company until the Company has been paid in full for the Goods under all individual contracts for the supply of the Goods between the Company and the Buyer;
 - c. The Buyer is a bailee of the Goods until such time as property in them passes to the Buyer and that this bailment continues in relation to each of the Goods until the price of the Goods has been paid in full;
 - d. Pending payment in full for the Goods, the Buyer:
 - I. Must not supply any of the Goods to any person outside of its ordinary or usual course of business;
 - II. Must not allow any person to have or acquire any security interest in the Goods;
 - III. Must insure the Goods for their full insurable or replacement value (whichever is the higher) with an insurer licensed or authorised to conduct the business of insurance in the place where the Buyer carries on business and;
 - IV. Must not remove, deface or obliterate any identifying plate, mark or number on any of the Goods.

- iv. Despite clause 11.iii, if the Buyer supplies any of the Goods to any person before all monies payable by the Buyer have been paid to the Company (and have not been claimed or clawed-back by any person standing in the place of or representing the Buyer), the Buyer agrees that:
 - a. It holds the proceeds of re-supply of all the Goods on trust for and as agent for the Company immediately when they are receivable or are received;
 - b. It must either pay the amount of the proceeds or re-supply to the Company immediately when they are received or pay those proceeds into an account with a bank or a financial institution or deposit-taking institution as trustee for the Company;
 - c. Any accessory or item which accedes to any of the Goods by an act of the Buyer or any person at the direction or request of the Buyer becomes and remains the property of the Company until the Company is paid in accordance with clause 11.iv(a) when the property in the Goods (including the accessory) passes to the Buyer and;
 - d. If the Buyer fails to pay for the Goods within the period of credit (if any) extended by the Company to the Buyer, the Company may recover possession of all the Goods at any site owned, possessed or controlled by the Buyer and the Buyer agrees that the Company has an irrevocable licence to do so.
 - e. Notwithstanding clauses 11.iv(a) – 11.iv(d), the Buyer acknowledges that the Company has a security interest in the Goods and in addition, in the proceeds of the Goods, that constitute both a 'security interest' in the original Goods and a 'purchase money security interest' in the proceeds of the Goods within the meaning of the Personal Property Securities Act 2009 (the Act)
 - f. The Buyer warrants that in the event that it grants a 'non-purchase money security interest' in the account, within the meaning of the Act, to a Third Party as original collateral for new value, the Buyer will:
 - I. On the direction of the Company, purchase new inventory from the Company with the proceeds of sale, within 7 days of any notice pursuant to the Act, delivered to the Company by the Third Party; or
 - II. On the direction of the Company, pay the Company all outstanding amounts in the account to satisfy the Customer's primary obligation to the Company, within 7 days of any notice pursuant to the Act, delivered to the Company by the Third Party; whichever of 11.iv(f)(i) or 11.i(f)(II) the Company so directs.
- v. The Buyer acknowledges and agrees that a failure to comply with a direction by the Company in accordance with the above will constitute a default and breach of the security agreement between the Company and the Buyer which will allow the Company to enforce the Buyer's obligations to the Company.

12. WITHHOLDING SUPPLY

- i. The Company reserves the right, irrespective of whether or not an order has been accepted and without notice to the Buyer, to withhold supply to the Buyer and the Company will not be liable for loss or damage resulting directly or indirectly from such action where:
 - a. The Company has insufficient Goods to fill the order;
 - b. The Goods ordered have been discontinued; or
 - c. The Company has determined in the Company's absolute discretion that credit should no longer be extended to the Buyer.

13. MODIFICATIONS OF LABELS

- i. The Buyer shall not, without the Company's written consent, alter, remove, or obliterate any labels which the Company attaches to the Goods.

14. PERFORMANCE AND REPRESENTATIONS

- i. The Buyer acknowledges that neither the Company nor any person purporting to act on its behalf has made any representation or given any promise or undertaking which is not expressly set out in writing whether as to the fitness of the Goods for any particular purpose or any other matter.

15. DEFAULT IN PAYMENT

- i. The Company will treat any default by the Buyer in payment of any monies due to the Company as a breach of these Terms and Conditions. The Company reserves the right thereupon to cease work on the relevant order and all other orders placed by the Buyer and hold all the Buyer's work until the due payment or payments on all moneys owed are made. Recurring payments default may, at the Company's discretion, lead to the Buyer's account with the Company being closed and any further order placed by the Buyer and accepted by the Company will only be processed when prepaid at the Company's absolute discretion.

16. WAIVER

- i. Failure by the Company to insist upon strict performance of any term, warranty or condition of these Terms and Conditions shall not be deemed as a waiver thereof or of any rights the Company may have and no express waiver shall be deemed a waiver of any subsequent breach of any term warranty or condition.

17. BUYERS ACKNOWLEDGMENT

- i. The Buyer acknowledges that the Goods are not of a kind ordinarily acquired for private use or consumption but are acquired for business purposes.

18. INTELLECTUAL PROPERTY RIGHTS

- i. The Buyer warrants that any design or instruction furnished to the Company shall not be such as will cause the Company to infringe any intellectual property rights (including patents, registered designs, trademarks, copyright, confidential information and the like) in the execution of the Buyer's order and the Buyer agrees to indemnify the Company against any infringement or unauthorised use of the intellectual property rights arising out of the manufacture or use of the Goods and it is especially agreed that the sale and purchase of Goods does not confer on the Buyer any licence or rights under any intellectual property rights which is the property of the Company. Buyer acknowledges and agrees that Company and/or its affiliates are the sole and exclusive owners of all trademarks, trade dress and trade names used by the Company and its affiliates in connection with the Goods and any local language variants thereof (the "Trademarks"). Any use of the Trademarks by Buyer shall be made only with the Company's prior written approval and solely in connection with the advertising, promoting or selling of the Goods and any such use shall inure to the benefit of Company and/or its affiliates. In no event shall Buyer or its affiliates file any application to register a trademark or a domain name or use any trademark, domain name, business name or trade style that incorporates or is confusingly similar to any of the Trademarks. If Buyer files any application of any kind that incorporates or is confusingly similar to any Trademark, it shall immediately transfer such application or any rights derived therefrom to Company or an affiliate as designated by Company.

19. NOTICES

- i. Any notice to be given by the Buyer to the Company must be in writing and shall be sent to the Company's address which is, until notified otherwise, as follows:
500 Princes Highway
Noble Park, Victoria 3174
- ii. No notice shall be deemed to have been given until it is actually received at such address.

20. PRIVACY

- i. Any personal information provided to the Company by the Buyer is collected, stored, used, disclosed and transferred in accordance with the Privacy Policy <http://newellrubbermaid.com/customer/terms-and-conditions/AU/Pages/PrivacyPolicy.aspx>. Please review the Privacy Policy carefully. By purchasing goods from the Company or providing personal information the Buyer accepts and consents to the Company collecting, holding, using and disclosing the Buyer's personal information in accordance with the Privacy Policy.

21. SEVERANCE

- i. It is agreed that if any provision of these Terms and Conditions should be determined to be void by any court of competent jurisdiction, then such determination shall not affect any other provision hereof and each such other provision shall remain in full force and effect.

22. GOVERNING LAW

- i. These Terms and Conditions shall be governed by and construed in accordance with the laws of Victoria. The Buyer and the Company agree to submit to the non-exclusive jurisdiction of Victoria and the Federal Court of Australia.

23. ENTIRE AGREEMENT

- i. These Terms and Conditions and the Privacy Policy contain all the terms of the agreement between the parties and supersede all prior discussions and arrangements. In the event that there is any conflict between the provisions of these Terms and Conditions and the provisions of a Purchase Order, and the Privacy Policy, or any record of any other agreement that the Company may have with the Buyer, then the provisions of these Terms and Conditions and the Privacy Policy shall prevail. The only exception to the foregoing will be a signed Trading Terms agreement (if applicable) that will prevail in relation to specific clauses relating to Pricing, Minimum Order Values and Delivery Terms.

24. CLERICAL ERRORS

- i. The Company reserves the right to correct clerical errors without notification.

25. PERSONAL PROPERTIES SECURITIES ACT 2009

- i. The Buyer hereby acknowledges that these Terms and Conditions constitute a security agreement which creates a security interest in favour of the Company in all Goods previously supplied by the Company to the Buyer (if any) and all after acquired Goods supplied by the Company to the Buyer (or for the Buyer's account) to secure the Buyer's payment obligations to the Company from time to time and at any time, including future advances. The Buyer agrees to grant a "Purchase Money Security Interest" to the Company.

- ii. The Buyer acknowledges and agrees that by assenting to these terms the Buyer grants a security interest (by virtue of the retention of title clause in these Terms and Conditions) to the Company and all Goods previously supplied by the Company to the Buyer (or for the Buyer's account) and these terms shall apply notwithstanding anything express or implied to the contrary contained in the Buyer's purchase order.
- iii. The Buyer undertakes to:
 - a. sign any further documents and/or provide any further information (which information the Buyer warrants to be complete, accurate and up-to-date in all respects) which the Company may reasonably require to enable registration of a financing statement or financing change statement on the Personal Property Securities Register ("PPSR");
 - b. not register a financing change statement as defined in section 10 of the PPSA or make a demand to alter the financing statement pursuant to section 178 of the PPSA in respect of the Goods without the prior written consent of the Company;
 - c. give the Company not less than 14 days' written notice of any proposed change in the Buyer's name and/or any other changes in the Buyer's details (including by not limited to changes in the Buyer's address, facsimile number, email address, trading name or business practice);
 - d. pay all costs incurred by the Company in registering and maintaining a financing statement (including registering a financing change statement) on the PPSR and/or enforcing or attempting to enforce the security interest created by these Terms and Conditions including executing subordination agreements;
 - e. be responsible for the full costs incurred by the Company (including actual legal fees and disbursements on a solicitor and client basis) in obtaining an order pursuant to section 182 of the PPSA;
 - f. give the Company free and immediate access to its premises or places within its control to enable the Company to enforce its Security Interests; and
 - g. procure, immediately upon request by the Company from any persons considered by the Company to be relevant to its security position, such agreement and waivers as the Company may at any time require; and
 - h. the Buyer waives any rights it may have under sections 115 of the PPSA upon enforcement.
- iv. Pursuant to section 157 of the PPSA, unless otherwise agreed to in writing by the Company, the Buyer waives the right to receive the verification statement in respect of any financing statement or financing change statement relating to the security interest.
- v. The Buyer agrees that immediately on request by the Company the Buyer will procure from any persons considered by the Company to be relevant to its security position such agreement and waivers as the Company may at any time require.

26. SECURITY INTEREST

- i. The Buyer gives the Company a Security Interest in all of the Buyer's present and after-acquired property in which Goods or materials supplied or financed by the Company have been attached or incorporated.