



enter
your
element

MOEN

Contents



Innovations

- 26 MotionSense™
- 28 MotionSense Wave™ **NEW!**
- 30 Spot Resist™ Stainless Finish
- 30 Power Clean™
- 32 Power Boost™ **NEW!**
- 32 Reflex®
- 90 M•PACT® Common Valve System
- 90 Pro-Fit® Installation
- 91 Roman Tub Valves
- 298 U by Moen™ Showering
- 300 Immersion® Rainshower Technology
- 386 Bath Safety

Suggested List Prices

- 3 Wholesale
- 24 Bulk
- 405 Moen Genuine Parts
- 535 Commercial

Hands-Free Kitchen

Styles with MotionSense™

- 27 STō®
- 27 Align®
- 27 Brantford
- 27 Arbor®

Styles with MotionSense Wave™

- 29 Align® Spring **NEW!**
- 29 Arbor® **NEW!**
- 29 Sleek™ **NEW!**

Kitchen and Bar Collections

Premium Kitchen Collections

- 34 Waterhill®
- 35 Weymouth®
- 35 90°™
- 36 STō®
- 36 Etch®

Kitchen Collections

- 37 Aberdeen™
- 37 Woodmere®
- 38 Tilt™
- 38 Voss™
- 38 Notch™
- 39 Align®
- 40 Brantford®
- 41 Genta™ **NEW!**
- 41 Arbor®
- 43 Camerist®
- 44 Sleek™ **NEW!**
- 45 Belfield™
- 45 Integra®
- 46 Method™
- 46 Chateau®
- 48 Torrance™
- 48 Banbury®

Kitchen Compliments

- 50 Pot Fillers
- 51 Premium Bar/Prep Faucets
- 53 Bar/Prep Faucets
- 56 Laundry Faucets
- 57 Premium Beverage and Filtering Faucets
- 59 Premium Soap/Lotion Dispensers
- 60 Soap/Lotion Dispensers, Air Gaps, Hose Management

Stainless Steel Sinks

- 63 1600™ Professional Series
- 64 1800™ Series
- 71 2000™ Series
- 76 2200™ Series
- 78 Sink Accessories

Disposals

- 84 GX Series
- 85 GX Pro Series
- 86 Disposal Accessories

Bath and Shower Collections

Premium Bath Collections

- 92 Weymouth®
- 105 Arris®
- 117 Waterhill®
- 125 90°™
- 139 Via®
- 145 Rothbury™
- 158 Icon™

Bath Collections

- 169 Wynford®
- 180 Align®
- 190 Voss™
- 203 Belfield™
- 214 Kingsley®
- 227 Rizon™
- 234 Dartmoor™
- 241 Glyde™
- 248 Vichy™
- 250 Brantford®
- 259 Eva®
- 268 Method™
- 275 Gibson™
- 281 Genta™
- 286 Chateau®

Spa and Shower Custom Options

- 302 U by Moen™ Showering
- 306 ExactTemp® 3/4" Thermostatic Showering
- 312 Moentrol® Multi-Function Showering Options
- 315 Moentrol® with Annex™ Shower Rail
- 316 Moentrol® and Standard Transfer Valve Showering Components
- 325 Posi-Temp® with Annex™ Shower Rail
- 326 Posi-Temp® and Standard Transfer Valve Showering Components
- 339 Showerheads
- 351 Shower Arm and Flanges
- 354 Handheld Showers
- 364 Handheld Shower Accessories
- 368 Body Sprays
- 369 Diverter Tub Spouts
- 374 Non-Diverter Tub Spouts
- 376 Drains

Bath Accessories

- 379 Coordinating Accessories
- 386 Bath Safety

Moen Genuine Parts

- 389 Genuine Replacement Parts

Bulk Pack Products

- 435 Bulk Packs

Commercial

- 459 Faucets, Valves and Sinks

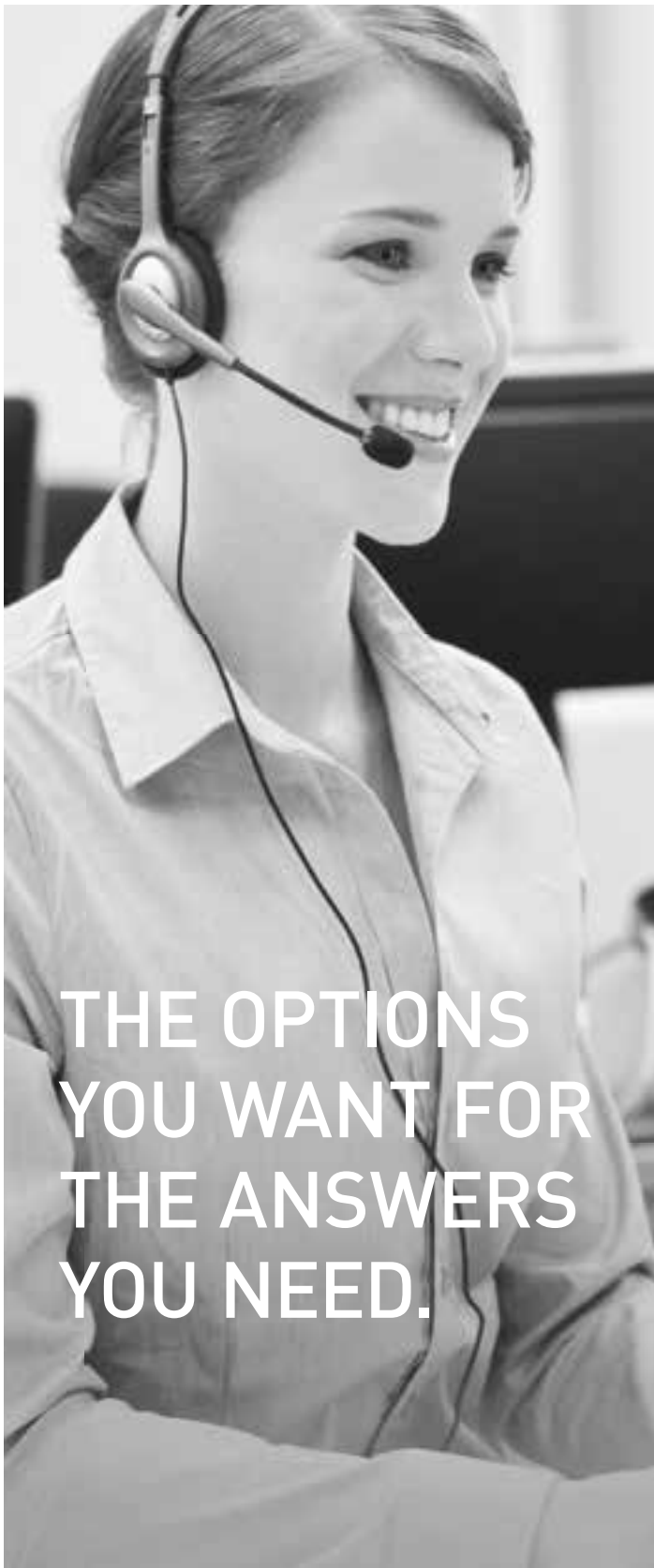

THE OPTIONS
YOU WANT FOR
THE ANSWERS
YOU NEED.

To make sure you receive support as outstanding as our products, Moen offers all the service options you need, including our Customer Service team, our Professional team and our comprehensive online resources. In particular, you'll appreciate CustomerNet, which not only gives you online visibility to inventory availability, order status and tracking information, but also provides other invaluable tools. With CustomerNet, the answers to the majority of your questions are just a click away.

CUSTOMER SERVICE

Moen, Commercial, CFG and Garbage Disposal

Moen Faucet Products

Phone: (800) 531-1600

Fax: (800) 848-6636

Email orders and general inquiries to:

moencustomerservicewholesaleUS@moen.com

Moen Accessories Products

Phone: (800) 882-0116

Fax: (888) 379-2720

Email orders and general inquiries to:

moencustomerserviceUS@moen.com

CustomerNet

To enroll for access to Website, password resets and CustomerNet inquiries:

Phone: (888) 450-5829

Email: cncontacts@moen.com

Website: customernet.moen.com

MOEN PROFESSIONAL

For technical and warranty assistance

Moen's Professional Line:

Phone: 1-877-Moen-Pro (1-877-663-6776)

Email: moenpro@moen.com

Website: moenpro.com

HELPFUL WEBSITES

moen.com

www.cfgonline.com

moen.com/commercial

csi.moen.com



Buy it for looks. Buy it for life.®

MODEL NUMBER	LIST PRICE	PAGE NO.	UNIVERSAL PRODUCT CODE	CASE QTY	MODEL NUMBER	LIST PRICE	PAGE NO.	UNIVERSAL PRODUCT CODE	CASE QTY
601	36.55	58	026508072158	12	3808	66.45	285	026508118252	12
695	1,500.00	192	026508280973	1	3808BN	96.10	285	026508118283	12
695BN	1,950.00	192	026508280980	1	3808ORB	105.80	285	026508113523	12
695ORB	2,145.00	192	026508280997	1	3808P	102.90	285	026508118276	12
1011	15.70	86	026508269176	24	3808WR	105.80	285	026508118290	12
1016	8.15	87	026508269183	100	3809BN	92.10	370	026508131800	12
1023	8.40	87	029122010230	24	3814	74.65	370	026508251041	6
1024	10.25	86	029122010247	24	3814BN	108.25	370	026508251058	6
1026	9.40	86	029122010261	6	3814ORB	119.10	370	026508251065	6
1037	9.00	87	29122010850	10	3828	44.65	375	026508133736	12
2352	152.95	387	026508025659	12	3829	44.65	375	026508133743	12
2353	174.80	290	026508025697	12	3829BC	74.00	375	026508149393	12
2363	199.70	290	026508025703	12	3829BN	102.55	375	026508133804	12
2510	119.75	101	026508074541	6	3829ORB	112.85	375	026508134375	12
2520	119.75	101	026508073001	6	3830	53.50	372	026508133750	12
2570	145.35	101	026508073018	6	3830P	123.10	372	026508133781	12
2580	119.75	101	026508233566	6	3839	52.00	373	026508239490	12
2590	145.35	101	026508073025	6	3839BN	75.40	373	026508260203	1
2919EP	171.45	295	026508270783	6	3853	53.15	373	026508070345	12
2982EP	171.45	295	026508270790	6	3853BN	110.35	373	026508164518	12
2995EP	200.65	295	026508270806	6	3853BRB	81.85	373	026508271858	12
3233EP	99.15	344	026508219430	12	3853ORB	121.35	373	026508164525	12
3233EPBN	168.25	344	026508219447	12	3853SRN	74.40	373	026508271865	12
3320	275.85	150	026508081761	6	3855	99.15	344	026508070376	12
3330	275.85	150	026508081754	6	3855EP	99.15	344	026508229972	12
3350	275.85	150	026508228227	6	3857	73.20	370	026508070406	6
3362	192.60	98	026508284568	6	3857BN	106.25	370	026508162453	6
3372	172.00	98	026508201930	12	3857ORB	116.90	370	026508162460	6
3375	172.00	98	026508228234	12	3858	65.70	374	026508162477	6
3510	164.10	99	026508102336	6	3858BN	95.40	374	026508162484	6
3520	164.10	99	026508102329	6	3858ORB	104.95	374	026508162491	6
3558EP	220.00	357	026508282274	6	3861EP	244.35	357	026508219508	6
3558EPBN	297.00	357	026508282281	6	3861EPBN	497.60	357	026508219515	6
3558EPORB	326.70	357	026508282298	6	3861EPNL	497.60	357	026508250969	6
3570	195.50	99	026508072981	6	3861EPORB	548.90	357	026508219522	6
3636EP	254.10	357	026508241677	6	3863EP	244.25	356	026508219539	6
3636EPBN	483.65	357	026508241684	6	3863EPBN	507.05	356	026508219546	6
3636EPORB	532.00	357	026508242773	6	3865EP	182.90	358	026508221495	6
3638	99.15	344	026508241691	12	3865EPBN	265.45	358	026508221501	6
3638BN	168.25	344	026508241707	12	3865EPORB	292.10	358	026508227619	6
3638EP	99.15	344	026508242131	12	3868EP	224.20	356	026508221532	6
3638EPBN	168.25	344	026508242148	12	3868EPBN	324.50	356	026508221549	6
3638ORB	185.15	344	026508242155	12	3868EPORB	356.65	356	026508227633	6
3662EP	180.00	359	026508279861	6	3869EP	277.15	355	026508222140	6
3662EPBN	244.00	359	026508279878	6	3869EPBN	550.45	355	026508223222	6
3662EPORB	307.00	359	026508279885	6	3869EPORB	605.50	355	026508223215	6
3667EP	267.80	355	026508242162	6	3869EPWR	611.60	355	026508250709	6
3667EPBN	529.55	355	026508242179	6	3887EP	248.75	356	026508222157	6
3667EPORB	582.45	355	026508242186	6	3887EPBL	543.65	356	026508283509	1
3668EP	224.20	356	026508242193	6	3887EPBN	494.25	356	026508223239	6
3668EPBN	324.50	356	026508242209	6	3890	66.95	372	026508174746	12
3668EPORB	356.65	356	026508242216	6	3890BN	97.15	372	026508174753	12
3669EP	267.80	355	026508242223	6	3892	54.60	375	026508174760	12
3669EPBN	529.55	355	026508242230	6	3892BL	92.90	375	026508279427	6
3669EPORB	582.45	355	026508242247	6	3892BN	84.45	375	026508174777	12
3737	72.75	371	026508265642	6	3911	53.35	373	026508004258	12
3737BN	105.55	371	026508265659	6	3926	50.45	373	026508004272	12
3737ORB	116.15	371	026508265666	6	3929BC	83.60	373	026508137284	12
3800	60.30	372	026508030639	12	3931	50.45	373	026508004289	12
3801	60.30	372	026508029473	12	3942	46.80	60	026508187586	6
3804	22.65	375	026508030707	12	3942BL	58.50	60	026508187890	6
3805	22.65	375	026508008614	12	3942SRS	63.05	60	026508234341	6
3806	72.90	371	026508041680	12	3942W	58.50	60	026508187913	6
3806W	109.35	371	026508050248	12	3944	45.85	60	026508187616	6
3807	72.90	371	026508041710	12	3944ORB	69.80	60	026508187937	6
3807BN	101.85	371	026508138434	12	3944SRS	63.05	60	026508234358	6
3807CP	77.30	371	026508041734	12	3959	51.95	375	026508004296	12

Wholesale

Listed in numerical order

MODEL NUMBER	LIST PRICE	PAGE NO.	UNIVERSAL PRODUCT CODE	CASE QTY
3960	53.35	373	026508004302	12
3972	55.20	372	026508120156	12
3972BN	85.60	372	026508143988	12
3988EP	248.75	356	026508282304	6
3988EPBN	494.25	356	026508282328	6
3988EPBRB	382.25	356	026508282335	6
3988EPORB	543.65	356	026508282342	6
3988EPSRN	347.50	356	026508282359	6
4500	258.85	169	026508253649	3
4500BN	385.55	169	026508253656	3
4500NL	385.55	169	026508255650	3
4500ORB	424.15	169	026508255667	3
4505	246.60	169	026508255674	3
4505BN	367.25	169	026508255681	3
4505NL	367.25	169	026508255698	3
4505ORB	404.00	169	026508255704	3
4507	383.25	169	026508255711	3
4507BN	560.25	169	026508255728	3
4507ORB	616.25	169	026508255742	3
4792	143.70	95	026508229583	6
4793	162.70	95	026508229590	6
4794	155.15	95	026508244050	6
4796	135.35	95	026508229606	6
4797	138.00	95	026508229613	6
4798	138.00	95	026508229620	6
4902	185.90	288	026508023204	6
4903	97.95	55	026508085325	12
4904	178.65	55	026508207505	3
4904SRS	215.60	55	026508274811	1
4905	203.55	54	026508138748	3
4905ORB	293.40	54	026508164884	3
4905SRS	273.70	54	026508242902	3
4925	151.80	287	026508002360	12
4925BC	193.95	287	026508136737	12
4945	265.85	287	026508002537	6
4962	245.90	287	026508006009	6
4975	99.85	56	026508003206	12
5923	448.95	29	026508267028	3
5923BL	561.70	29	026508282557	3
5923EWC	582.50	29	026508279007	3
5923EWSRS	617.45	29	026508279014	1
5923SRS	574.65	29	026508267035	3
5965	352.75	54	026508240007	3
5965BL	441.00	54	026508282564	3
5965SRS	454.00	54	026508240014	3
5985	341.25	54	026508211748	3
5985ORB	470.85	54	026508211809	3
5985SRS	437.30	54	026508242926	3
5995	321.85	54	026508207291	3
5995BL	402.30	54	026508228395	3
5995ORB	431.30	54	026508209790	3
5995SRS	412.30	54	026508231968	3
6101	246.60	214	026508107942	6
6101BN	367.25	214	026508115299	6
6101ORB	404.00	214	026508116272	6
6102	258.85	214	026508128886	3
6102BN	385.55	214	026508128893	3
6102ORB	424.15	214	026508131961	3
6102P	431.75	214	026508174791	3
6102WR	424.15	214	026508128909	3
6121	283.55	214	026508126745	3
6121BN	422.25	214	026508126769	3
6121ORB	464.55	214	026508131978	3
6121P	473.00	214	026508232484	3
6121WR	464.55	214	026508126776	3
6124C	382.90	53	026508254608	3
6124ORB	537.25	53	026508254615	3

MODEL NUMBER	LIST PRICE	PAGE NO.	UNIVERSAL PRODUCT CODE	CASE QTY
6124SRS	488.35	53	026508254622	3
6145	174.70	275	026508272060	3
6150	147.05	275	026508272077	3
6172	166.70	241	026508261163	3
6172BN	226.45	241	026508261170	3
6190	258.85	180	026508244913	3
6190BL	424.15	180	026508274989	3
6190BN	385.55	180	026508249567	3
6191	251.95	180	026508249598	3
6191BL	416.60	180	026508274996	3
6191BN	378.70	180	026508249604	3
6192	383.25	180	026508249611	3
6192BN	560.25	180	026508249628	3
	33.20	350	026508154724	12
6300BN	50.75	350	026508207574	12
6300EP	33.20	350	026508208557	12
6300EP15	33.20	350	026508241745	12
6300EPBC	38.85	350	026508208564	12
6300EPBN	50.75	350	026508208571	12
6300P	59.20	350	026508154748	12
6302	85.70	345	026508142417	12
6302BN	133.85	345	026508142431	12
6302EP	85.70	345	026508208595	12
6302EP15	85.70	345	026508241752	12
6302EPBN	133.85	345	026508208625	12
6302EPORB	147.25	345	026508208632	12
6302EPP	149.25	345	026508208649	12
6302ORB	147.25	345	026508142448	12
6302P	149.25	345	026508142462	12
6302WR	147.25	345	026508142486	12
6303	47.40	348	026508153314	12
6303BN	72.60	348	026508153321	12
6303EP	47.40	348	026508208687	12
6303EPBN	72.60	348	026508208694	12
6303EPORB	79.85	348	026508208700	12
6303ORB	79.85	348	026508153338	12
6304	38.65	349	026508156223	12
6304EP	38.65	349	026508208717	12
6313	47.40	348	026508214862	12
6313BN	72.60	348	026508214879	12
6313ORB	79.85	348	026508214886	12
6322	84.70	346	026508239506	12
6322BN	132.25	346	026508260210	1
6322EP	84.70	346	026508239513	12
6322EPBN	132.25	346	026508260227	1
6325	84.70	346	026508230107	12
6325BN	132.25	346	026508230114	12
6325EP	84.70	346	026508230121	12
6325EPBN	132.25	346	026508230138	12
6325EPORB	145.55	346	026508230145	12
6325ORB	145.55	346	026508230152	12
6345	82.00	342	026508238554	3
6345BN	92.40	342	026508271469	3
6345EP	82.00	342	026508281857	1
6345EPBN	92.40	342	026508281864	1
6345EPORB	102.75	342	026508281871	1
6345ORB	102.75	342	026508271476	3
6370	50.85	347	026508266632	12
6370BN	77.85	347	026508266687	12
6370EP	50.85	347	026508281840	1
6370EPBN	77.85	347	026508281796	1
6371	50.85	347	026508266625	12
6371BN	77.85	347	026508266649	12
6371EP	50.85	347	026508281802	1
6371EPBN	77.85	347	026508281819	1
6371EPORB	85.70	347	026508281826	1
6371ORB	85.70	347	026508266670	12

Wholesale

Listed in numerical order

SUGGESTED LIST PRICES

MODEL NUMBER	LIST PRICE	PAGE NO.	UNIVERSAL PRODUCT CODE	CASE QTY	MODEL NUMBER	LIST PRICE	PAGE NO.	UNIVERSAL PRODUCT CODE	CASE QTY
6399	84.70	346	026508174722	12	7250ORB	375.75	45	026508259948	3
6399BL	145.50	346	026508275009	12	7250SRS	341.55	45	026508259955	3
6399BN	132.25	346	026508174739	12	7255C	294.10	45	026508259962	3
6399EP	84.70	346	026508208762	12	7255ORB	436.80	45	026508259979	3
6399EP15	84.70	347	026508274682	12	7255SRS	397.10	45	026508259986	3
6399EP15BL	145.50	347	026508275016	12	7294BL	416.40	42	026508228838	3
6399EPBL	145.50	346	026508275023	12	7294C	333.10	42	026508228845	3
6399EPBN	132.25	346	026508208779	12	7294ORB	453.00	42	026508228869	3
6400	231.55	259	026508195369	3	7294SRS	426.65	42	026508231975	3
6400BN	302.95	259	026508195376	3	7295C	337.70	41	026508267158	3
6400ORB	333.25	259	026508195383	3	7295ORB	474.75	41	026508267172	3
6401	253.55	212	026508275337	3	7295SRS	452.15	41	026508267165	3
6401BN	354.95	212	026508275344	3	7365	320.80	40	026508251171	3
6401ORB	380.25	212	026508275351	3	7365SRS	412.85	40	026508251188	3
6402	255.05	203	026508275153	3	7423	135.20	46	026508053157	6
6402BN	357.35	203	026508275160	3	7425	132.55	46	026508052938	6
6402ORB	382.80	203	026508275177	3	7425SRS	153.00	46	026508274873	6
6410	166.70	259	026508153109	6	7430	166.80	46	026508052853	6
6410BN	226.45	259	026508153116	6	7430SRS	192.55	46	026508274880	6
6410ORB	249.10	259	026508153123	6	7434	166.80	46	026508053034	6
6600	231.55	250	026508195390	3	7437	170.35	46	026508053126	6
6600BN	302.95	250	026508195406	3	7545C	337.70	43	026508138816	3
6600ORB	333.25	250	026508195413	3	7545ORB	474.75	43	026508164907	3
6610	166.70	250	026508162057	6	7545SRS	452.15	43	026508242964	3
6610BN	226.45	250	026508160992	6	7565	392.00	27	026508240045	3
6610ORB	249.10	250	026508161005	6	7565BL	490.00	27	026508274736	3
6615SRS	516.60	53	026508267141	3	7565EC	687.10	27	026508257944	3
6702	174.70	281	026508271186	3	7565ESRS	733.25	27	026508257951	3
6710	211.45	248	026508273074	3	7565SRS	504.50	27	026508240052	3
6802	166.70	234	026508264386	3	7585C	194.50	46	026508270318	3
6802BN	226.45	234	026508264393	3	7585SRS	262.90	46	026508270325	3
6802ORB	249.10	234	026508264409	3	7590C	634.20	37	026508108543	2
6810	231.55	268	026508206959	3	7590CSL	756.15	37	026508198933	2
6810BN	302.95	268	026508206966	3	7590ORB	793.90	37	026508144312	2
6900	258.85	227	026508235096	3	7594BL	447.00	29	026508228388	3
6900BN	385.55	227	026508258293	3	7594C	357.60	29	026508205037	3
6901	246.60	190	026508230169	3	7594EC	640.95	29	026508233863	3
6901BN	367.25	190	026508230176	3	7594EORB	709.65	29	026508233870	3
6901ORB	404.00	190	026508230183	3	7594ESRS	676.85	29	026508233887	3
6903	258.85	190	026508230190	3	7594EWC	494.50	29	026508279021	3
6903BN	385.55	190	026508230206	3	7594EWORB	548.90	29	026508279038	3
6903ORB	424.15	190	026508230213	3	7594EWSRS	524.20	29	026508279045	3
7050	99.55	48	026508274750	3	7594ORB	479.30	29	026508209806	3
7050SRS	121.15	48	026508274767	3	7594SRS	458.05	29	026508231982	3
7051	109.00	48	026508274774	3	7615C	478.50	37	026508267110	3
7051SRS	127.65	48	026508274781	3	7615ORB	673.75	37	026508267134	3
7052	109.00	48	026508274798	3	7615SRS	612.50	37	026508267127	3
7081	127.70	48	026508274828	3	7626C	432.35	38	026508267059	3
7081SRS	165.75	48	026508274835	3	7626SRS	551.45	38	026508267066	3
7082	160.70	48	026508274842	3	7735ORB	496.00	41	026508211823	3
7082SRS	208.60	48	026508274859	3	7735SRS	463.00	41	026508242971	3
7083	160.70	48	026508274866	3	7790	339.00	42	026508207581	3
7165	364.55	40	026508240021	3	7790SRS	436.65	42	026508231999	3
7165SRS	469.25	40	026508240038	3	7825	173.65	43	026508138786	3
7185C	379.25	27	026508211786	3	7825ORB	293.40	43	026508164914	3
7185EC	656.30	27	026508242308	3	7825SRS	266.40	43	026508242988	3
7185EORB	723.00	27	026508242315	3	7835	207.05	43	026508138809	3
7185ESRS	697.35	27	026508242322	3	7835SRS	306.35	43	026508242995	3
7185ORB	522.30	27	026508211816	3	7840	207.05	43	026508138847	3
7185SRS	485.65	27	026508242940	3	7840ORB	326.00	43	026508164938	3
7240C	267.50	45	026508259870	3	7840SRS	303.70	43	026508243008	3
7240ORB	397.40	45	026508259887	3	7864	317.90	29	026508278444	1
7240SRS	361.30	45	026508259894	3	7864BL	397.40	29	026508278451	3
7245C	311.10	45	026508259900	3	7864EWC	467.90	29	026508279052	3
7245ORB	462.05	45	026508259917	3	7864EWSRS	496.00	29	026508279069	1
7245SRS	419.95	45	026508259924	3	7864SRS	406.90	29	026508278468	3
7250C	252.95	45	026508259931	3	7882	345.00	41	026508279311	1

Wholesale

Listed in numerical order

MODEL NUMBER	LIST PRICE	PAGE NO.	UNIVERSAL PRODUCT CODE	CASE QTY
7882SRS	437.75	41	026508279328	1
7900	98.90	47	026508004135	12
7906	125.80	47	026508003398	6
7907	158.35	47	026508030318	6
7910	126.50	47	026508004142	12
9000	123.55	92	026508081112	6
9001	97.15	58	026508094709	6
9124C	425.40	38	026508254639	3
9124ORB	596.95	38	026508254646	3
9124SRS	542.60	38	026508254653	3
9125C	432.35	38	026508254325	3
9125ORB	606.55	38	026508254332	3
9125SRS	551.45	38	026508254349	3
9265	254.45	178	026508255155	6
9601	54.95	58	026508153918	18
9700	174.75	93	026508230008	3
9792	323.75	96	026508229637	6
9793	331.35	96	026508229644	6
10154	19.75	352	026508050903	20
10154BN	35.45	352	026508105344	20
10154BRB	31.80	352	026508210628	20
10154CBN	19.15	352	026508188095	20
10154NL	35.45	352	026508104248	1
10154ORB	39.00	352	026508100325	20
10154P	37.60	352	026508052051	1
10154SLP	31.45	352	026508122068	20
10154WR	39.00	352	026508117101	20
20001	34.95	350	026508255377	3
22001	16.40	115	026508167687	1
22002	15.80	114	026508167694	1
22036	19.35	80	026508017593	24
22037	16.90	80	026508008652	40
22132Q	299.00	75	026508284087	1
22174	8.75	80	026508038314	30
22175	4.20	81	026508036006	1000
22194	6.10	81	026508038321	1
22201	14.50	80	026508036037	142
22504	15.80	69	026508102039	1
22505	16.40	69	026508102046	1
22506	15.80	69	026508102053	1
22507	16.40	68	026508102060	1
22508	16.40	71	026508102077	1
22509	15.80	67	026508102084	1
22510	16.40	71	026508008843	1
22511	16.40	66	026508017500	1
22512	17.55	64	026508247907	1
22514	16.40	66	026508017524	1
22516	16.40	64	026508247921	1
22517	16.40	64	02650817548	1
22518	16.40	64	026508017555	1
22519	16.40	64	026508247938	1
22520	16.40	65	026508116159	1
22521	16.40	65	026508116166	1
22522	16.40	65	026508116173	1
22523	16.40	65	026508116180	1
22524	15.80	66	026508140819	1
22525	16.40	68	026508225257	1
22526	16.40	65	026508008850	1
22527	16.40	65	026508017517	1
22537	16.40	63	026508155035	1
22538	15.80	63	026508155042	1
22539	16.40	63	026508155059	1
22540	15.80	63	026508155066	1
22541	16.40	67	026508193099	1
22543	15.80	66	026508193112	1
22650	12.35	81	026508104385	1
22681	4.55	81	026508032336	1

MODEL NUMBER	LIST PRICE	PAGE NO.	UNIVERSAL PRODUCT CODE	CASE QTY
22682	5.40	81	026508032374	1
22684	3.75	81	026508032299	1
22897	1.05	81	026508038307	1
23026	39.95	349	026508224281	4
26100EP	59.95	361	026508266540	2
26100EPSRN	73.30	361	026508266557	2
67315C	239.05	45	026508069257	6
67315SRS	337.90	45	026508242933	6
74998	75.10	56	026508028070	12
90410	122.70	376	026508904107	10
90410BN	196.40	376	026508132050	10
90410ORB	216.00	376	026508132067	10
90480	138.75	376	026508904800	8
90480BN	218.75	376	026508120873	8
90480ORB	231.25	376	026508132081	8
90530	47.65	376	026508905302	10
101663BN	28.75	377	026508120897	12
101663ORB	31.65	377	026508100349	12
101663P	26.25	377	026508066119	12
101663WR	31.65	377	026508120927	12
101664BN	35.75	377	026508120903	12
101664ORB	39.35	377	026508100363	12
101664P	35.75	377	026508066126	1
101664WR	39.35	377	026508120934	12
102763BN	35.75	377	026508120910	12
102763ORB	39.35	377	026508100387	12
102763P	35.75	377	026508073339	1
102763WR	39.35	377	026508120941	12
104465	173.00	95	026508204368	12
104466	173.00	95	026508267103	12
105895BL	30.40	60	026508098011	6
105895CSL	31.40	60	026508185803	6
105895ORB	32.50	60	026508144336	6
105895SRS	31.10	60	026508214138	6
114348	81.60	366	026508118085	12
114348BN	118.30	366	026508118115	12
114348NH	308.35	366	026508218976	6
114348NHBN	422.55	366	026508218983	6
114348NHORB	422.55	366	026508218990	6
114348NL	94.80	366	026508146354	12
114348ORB	130.10	366	026508101766	12
114348WR	130.10	366	026508118122	12
116651	13.65	351	026508128572	6
116651BN	23.10	351	026508128589	6
116651NL	23.10	351	026508147146	6
116651ORB	30.00	351	026508147191	6
116651WR	30.00	351	026508128596	6
123815	26.90	352	026508140437	12
123815BL	49.20	352	026508279410	12
123815BN	44.75	352	026508152881	12
123815ORB	49.20	352	026508164983	12
128284	25.65	309	026508156568	12
137488	7.65	353	026508178454	12
137488BL	7.55	353	026508277409	12
137488BN	19.95	353	026508178461	12
140680	12.80	376	026508184431	12
140690	14.40	376	026508184448	12
140715	10.75	95	026508187517	200
140780	59.20	93	026508165720	12
140780BN	82.60	93	026508165737	12
140780NL	81.90	93	026508230923	12
140780ORB	93.30	93	026508165744	12
141002	47.95	27	026508187296	6
141002BL	55.05	27	026508229019	6
141002NL	52.20	27	026508265765	6
141002ORB	60.65	27	026508211410	6
141002SRS	55.05	27	026508209370	6

MODEL NUMBER	LIST PRICE	PAGE NO.	UNIVERSAL PRODUCT CODE	CASE QTY	MODEL NUMBER	LIST PRICE	PAGE NO.	UNIVERSAL PRODUCT CODE	CASE QTY
142538	5.15	376	026508188668	180	164928ORB	111.80	360	026508241639	6
147204	25.80	125	026508204450	12	164929	58.70	362	026508241646	6
147204BN	62.45	125	026508205136	12	164929BN	85.15	362	026508241653	6
147547	84.90	359	026508204610	6	164929NL	84.90	362	026508271872	6
147547BN	124.55	359	026508205143	6	164929ORB	93.70	362	026508241660	6
147556	135.70	125	026508204696	6	165006	23.60	227	026508239926	20
147556BN	199.05	125	026508205211	6	165006BN	44.35	227	026508260067	20
147572	11.00	353	026508204849	12	165212	58.70	361	026508245644	12
147572BN	16.10	353	026508205327	12	165212BN	85.15	361	026508245651	12
147913	124.25	359	026508200513	6	165914	137.15	370	026508242339	6
147913BN	183.90	359	026508200520	6	165914BN	232.60	370	026508242346	6
151380	69.80	351	026508207413	6	169031	132.55	27	026508266199	12
151380BN	118.70	351	026508207420	6	172656	68.30	371	026508251003	6
151380ORB	130.50	351	026508207437	6	172656BL	119.10	371	026508274675	6
152027	59.45	372	026508207550	12	172656BN	108.25	371	026508251010	6
152027BN	88.55	372	026508207567	12	172657	68.30	371	026508251027	6
154296	257.80	363	026508218266	6	172657BN	108.25	371	026508251034	6
154296BN	283.55	363	026508218273	6	172666	16.15	180	026508250938	20
154296NL	311.90	363	026508231029	6	172666BL	28.25	180	026508280942	20
154296ORB	311.90	363	026508218280	6	172666BN	20.05	180	026508250945	20
154305	126.60	359	026508218488	6	175385	71.65	371	026508257753	6
154305BN	183.50	359	026508218495	6	175385BN	111.20	371	026508257760	6
154305NL	194.90	359	026508231098	6	175385NL	111.20	371	026508257777	6
154305ORB	194.90	359	026508218501	6	175385ORB	122.20	371	026508257784	6
155694	22.65	366	026508221372	12	176015	75.35	360	026508253335	12
155694BN	32.70	366	026508221389	12	176015BN	109.20	360	026508253359	12
155694ORB	36.10	366	026508227565	12	176015ORB	120.20	360	026508253373	12
155746	183.05	363	026508221396	6	176015P	148.35	360	026508256695	12
155746BN	265.40	363	026508221402	6	176015WR	152.60	360	026508254028	12
155746ORB	291.95	363	026508227572	6	176257	84.90	360	026508254974	6
155747	58.70	361	026508221419	6	176257BN	124.55	360	026508254981	6
155747BN	85.15	361	026508221426	6	179573	65.00	305	026508274224	6
155747ORB	93.70	361	026508227589	6	179791	86.55	370	026508264171	6
155748	35.00	364	026508221433	8	179791BN	110.10	370	026508264188	6
155748BL	52.45	364	026508280775	8	179834	13.85	353	026508263969	20
155748BN	50.85	364	026508221440	8	180238	47.90	362	026508262276	6
155748BR	52.45	364	026508280782	8	181250	69.50	81	026508266601	12
155891	58.70	361	026508223178	6	185820	93.25	370	026508276969	6
155891BL	93.70	361	026508278185	6	185820BN	111.25	370	026508276976	6
155891BN	85.15	361	026508223185	6	185820ORB	121.15	370	026508276983	6
157276	58.70	361	026508221457	6	186589	9.30	86	026508275221	6
157276BN	85.15	361	026508221464	6	187054	120.00	359	026508281147	1
157276EP15	58.70	362	026508241714	6	187054BN	150.00	359	026508281154	1
157276EP15BN	85.15	362	026508241721	6	187054ORB	170.00	359	026508281161	1
157276EP15ORB	93.70	362	026508241738	6	189315	55.00	362	026508282120	6
157276ORB	93.70	361	026508227602	6	189315BN	74.25	362	026508282137	6
157328	42.90	53	026508239056	6	189315ORB	81.70	362	026508282144	6
157328ORB	54.30	53	026508255179	6	189318	58.70	362	026508282151	6
157328SRS	49.35	53	026508225103	6	189318BN	89.15	362	026508282168	6
159060	18.80	60	026508231425	6	189318BRB	93.70	362	026508282175	6
160042	90.30	359	026508228166	6	189318ORB	83.70	362	026508282182	6
160042BN	131.00	359	026508228173	6	189318SRN	89.15	362	026508282199	6
160042ORB	144.05	359	026508228180	6	191956	64.80	374	026508281178	6
161951	91.50	351	026508233559	12	191956BN	94.00	374	026508281185	6
161951BN	123.75	351	026508233610	12	191956ORB	103.40	374	026508281192	6
161951ORB	136.15	351	026508233627	12	195386	64.50	374	026508281208	6
161955	72.05	371	026508233726	6	195386BN	93.50	374	026508281215	6
161955BN	111.70	371	026508233733	6	195386NL	93.50	374	026508281222	6
161955ORB	122.90	371	026508233740	6	195386ORB	102.85	374	026508281239	6
164745	10.90	353	026508239247	20	221672	22.80	92	026508224519	12
164745BN	16.00	353	026508239254	20	221672BN	30.30	92	026508224526	12
164745ORB	20.75	353	026508239261	20	221672NL	30.30	92	026508231135	12
164927	68.40	360	026508241585	6	221672ORB	33.50	92	026508224533	12
164927BN	99.10	360	026508241592	6	221673	15.45	98	026508224540	12
164927ORB	111.80	360	026508241608	6	221673BN	20.60	98	026508224557	12
164928	70.10	360	026508241615	6	221673NL	20.60	98	026508231142	12
164928BN	101.60	360	026508241622	6	221673ORB	22.75	98	026508224564	12

Wholesale

Listed in numerical order

SUGGESTED LIST PRICES

MODEL NUMBER	LIST PRICE	PAGE NO.	UNIVERSAL PRODUCT CODE	CASE QTY
221772	14.65	94	026508256947	12
221772BN	19.45	94	026508256954	12
226651	42.10	351	026508165751	6
226651BN	81.80	351	026508165782	6
226651NL	81.80	351	026508165799	6
226651ORB	89.90	351	026508165805	6
226651WR	89.90	351	026508165829	6
336651	63.10	351	026508282229	6
336651BL	134.85	351	026508282236	6
336651BN	122.70	351	026508282243	6
336651NL	122.70	351	026508282250	6
336651ORB	134.85	351	026508282267	6
A501	91.70	368	026508149119	12
A501BN	114.65	368	026508149300	12
A501NL	114.65	368	026508149171	12
A501ORB	126.10	368	026508149256	12
A501P	114.65	368	026508149140	12
A501WR	126.10	368	026508149188	12
A701	46.00	367	026508232941	12
A701BN	66.60	367	026508232958	12
A701ORB	73.25	367	026508232965	12
A714	39.65	366	026508042847	24
A714ORB	63.30	366	026508181317	12
A714ST	57.55	366	026508081013	24
A714WR	63.30	366	026508167014	12
A720	70.50	367	026508042892	12
A720BN	95.75	367	026508141984	12
A720ORB	105.30	367	026508141991	12
A720P	84.55	367	026508079447	12
A721	63.15	365	026508227725	12
A721BN	89.05	365	026508227732	12
A721BRB	97.55	365	026508282489	1
A721ORB	97.55	365	026508282472	1
A721SRN	89.05	365	026508282465	1
A725	49.40	365	026508044551	12
A725BN	69.90	365	026508121955	12
A725CBN	69.75	365	026508191224	12
A725NL	69.90	365	026508079232	12
A725ORB	76.90	365	026508132166	12
A725P	69.90	365	026508044575	12
A725WR	76.90	365	026508121962	12
A726	94.55	364	026508073032	12
A726BR	174.95	364	026508181225	12
A726NL	168.80	364	026508079638	24
A726P	168.80	364	026508073049	24
A726SRN	168.80	364	026508282458	12
A726ST	168.80	364	026508079645	24
A726WR	107.65	364	026508118412	6
A730	48.30	366	026508073100	12
A730P	112.00	366	026508073117	12
A730ST	112.00	366	026508079768	12
A735	147.60	363	026508172728	6
A735BN	214.00	363	026508172735	6
A735CP	169.70	363	026508172780	6
A735ORB	227.15	363	026508172742	6
A735P	227.15	363	026508172803	6
A735WR	227.15	363	026508172766	6
A742	159.60	382	026508204078	6
A742BN	231.55	382	026508205433	6
A742BRB	245.35	382	026508282434	6
A742ORB	245.35	382	026508282427	6
A742SRN	223.05	382	026508282403	6
A750	29.50	366	034584010643	24
A755	126.30	365	026508232972	12
A755BN	183.15	365	026508232989	12
A755ORB	201.50	365	026508232996	12
A780	111.50	364	026508227138	20

MODEL NUMBER	LIST PRICE	PAGE NO.	UNIVERSAL PRODUCT CODE	CASE QTY
A1616	121.85	145	026508125786	6
A1616BN	174.50	145	026508125793	6
A1616ORB	192.05	145	026508132142	6
A1616P	195.45	145	026508232491	6
A1616WR	192.05	145	026508125809	6
A1717	135.35	158	026508166116	6
A1717BN	193.95	158	026508166123	6
A1717ORB	210.70	158	026508199015	6
A2020	134.10	268	026508206973	6
A2020BN	192.10	268	026508206980	6
ARC-4200	62.50	86	029122010520	60
AS-4201-AL	12.50	86	029122010667	100
AS-4201-BIS	12.50	86	029122010643	100
AS-4201-BR	21.00	86	029122010650	100
AS-4201-BRB	31.75	86	026508251706	100
AS-4201-CH	21.00	86	029122010681	100
AS-4201-SN	42.00	86	029122010674	100
AS-4201-WH	12.50	86	029122010636	100
AT2099	16.10	353	026508065112	12
AT2099BN	40.90	353	026508105924	12
AT2099ORB	44.95	353	026508132173	12
AT2099P	43.30	353	026508065129	12
AT2199	7.65	353	026508065136	48
AT2199BN	20.10	353	026508130162	48
AT2199NL	20.10	353	026508104057	48
AT2199ORB	22.15	353	026508132180	48
AT2199P	21.30	353	026508065143	48
AT2199SLP	14.40	353	026508123386	48
AT2199WR	22.15	353	026508118436	12
BH0903CH	19.05	127	034584027863	12
BH0924CH	30.90	252	034584027894	3
BH0986CH	22.05	269	034584027900	3
BH3803CH	22.10	285	034584024848	12
BH3808CH	39.80	285	034584024855	3
BH3818CH	40.10	285	034584024862	3
BH3824CH	41.50	285	034584024879	3
BH3886CH	30.40	285	034584024886	3
BP3703BN	25.90	384	034584025401	24
BP3703CH	23.00	384	034584025418	24
BP3708BN	35.75	384	034584025425	6
BP3708CH	31.80	384	034584025432	6
BP3718BN	50.65	384	034584025449	6
BP3718CH	45.10	384	034584025456	6
BP3724BN	55.10	384	034584025463	6
BP3724CH	47.10	384	034584025470	6
BP3786BN	38.00	384	034584025487	6
BP3786CH	33.80	384	034584025494	6
CL703	78.40	381	026508250549	12
CL703BN	113.70	381	026508250556	12
CL703ORB	125.10	381	026508250563	12
CL707	106.45	381	026508250570	12
CL707BN	154.30	381	026508250587	12
CL707ORB	169.80	381	026508250594	12
CL6302	85.70	345	026508254240	12
CL6302BN	133.85	345	026508254257	12
CL6302EP	85.70	345	026508266892	12
CL6302EPBN	133.85	345	026508266908	12
CL6303	47.40	349	026508254264	12
CL6303BN	72.60	349	026508254271	12
CL6303EP	47.40	349	026508266878	12
CL6303EPBN	72.60	349	026508266885	12
CL10154	27.40	352	026508254103	12
CL10154BN	55.55	352	026508254110	12
CL26500	50.45	348	026508254226	12
CL26500BN	82.35	348	026508254233	12
CL26500EP	50.45	348	026508266915	12
CL26500EPBN	82.35	348	026508266922	12

Wholesale

Listed in numerical order

SUGGESTED LIST PRICES

MODEL NUMBER	LIST PRICE	PAGE NO.	UNIVERSAL PRODUCT CODE	CASE QTY	MODEL NUMBER	LIST PRICE	PAGE NO.	UNIVERSAL PRODUCT CODE	CASE QTY
CL123815	34.45	352	026508254127	12	DN6818ORB	37.25	380	034584016003	3
CL123815BN	64.90	352	026508254134	12	DN6822BN	59.15	380	034584002297	3
CL155694	22.65	366	026508254141	12	DN6824BN	38.90	380	034584483379	3
CL155694BN	32.70	366	026508254158	12	DN6824CH	26.70	380	034584483362	3
CL155747	58.70	361	026508254776	6	DN6824ORB	40.50	380	034584016010	3
CL155747BN	85.15	361	026508254783	6	DN6850BN	57.85	380	034584483416	2
CL155748	35.00	364	026508254165	12	DN6886BN	27.15	380	034584483393	3
CL155748BN	50.85	364	026508254172	12	DN6886CH	17.40	380	034584483386	3
CL164928	70.10	360	026508254202	6	DN6886ORB	27.45	380	034584016027	3
CL164928BN	101.60	360	026508254219	6	DN6890BN	58.60	380	034584485564	3
CLA701	46.00	367	026508254288	12	DN6892BN	111.65	380	034584002235	3
CLA701BN	66.60	367	026508254295	12	DN7025	50.85	388	034584179661	2
CSR2160BN	53.80	385	034584008848	10	DN7065	124.50	388	034584484284	1
CSR2160CH	48.90	385	034584008831	10	DN7110	378.80	388	034584019141	2
CSR2160WB	61.55	385	034584008855	10	DN7110WB	439.40	388	034584023827	2
CSR2164BN	53.80	385	034584024381	10	DN8303BN	15.70	383	034584004482	24
CSR2164WB	61.55	385	034584024398	10	DN8303CH	14.05	383	034584004413	24
CSR2165BN	41.40	385	034584008800	10	DN8308BN	30.00	383	034584004499	3
CSR2165CH	38.70	385	034584008794	10	DN8308CH	26.90	383	034584004420	3
CSR2165WB	49.75	385	034584011336	10	DN8318BN	30.75	383	034584004505	3
DN0703BN	20.95	381	034584012890	24	DN8318CH	27.50	383	034584004437	3
DN0703CH	18.65	381	034584008268	12	DN8322BN	50.80	383	034584004512	3
DN0705BN	9.35	381	034584018472	144	DN8322CH	45.45	383	034584004444	3
DN0705CH	8.05	381	034584018489	48	DN8324BN	33.35	383	034584004529	3
DN0707BN	17.25	381	034584018144	144	DN8324CH	29.80	383	034584004451	3
DN0707CH	16.00	381	034584018496	48	DN8386BN	21.70	383	034584004536	3
DN0708BN	44.60	381	034584012906	3	DN8386CH	19.45	383	034584004468	3
DN0708CH	39.60	381	034584008275	3	DN8390BN	56.65	383	034584004543	3
DN0709BN	37.70	381	034584017307	3	DN8390CH	50.80	383	034584004475	3
DN0709CH	33.75	381	034584017314	3	G16100	1,809.85	63	026508240267	1
DN0718BN	40.95	381	034584012913	3	G16200	1,961.15	63	026508240274	1
DN0718CH	36.45	381	034584008282	3	G16221	2,041.10	63	026508240281	1
DN0722BN	66.75	381	034584012920	3	G16430	1,070.30	63	026508240298	1
DN0722CH	59.45	381	034584008299	3	G18110	875.25	68	026508240304	1
DN0724BN	44.60	381	034584012937	3	G18121	997.80	65	026508248447	1
DN0724CH	39.60	381	034584008305	3	G18160	627.80	66	026508248133	1
DN0761BN	135.75	382	034584018625	2	G18161	673.85	66	026508265079	1
DN0761CH	107.80	382	034584018632	2	G18163	716.85	66	026508256206	1
DN0762BN	190.05	382	034584018649	2	G18165	929.85	66	026508248126	1
DN0762CH	153.85	382	034584018656	2	G18180	693.65	64	026508248119	1
DN0763BN	236.00	382	034584018663	2	G18185	586.80	64	026508248140	1
DN0763CH	188.70	382	034584018670	2	G18190	582.40	68	026508240311	1
DN0764BN	302.15	382	034584018687	2	G18191	351.15	68	026508240328	1
DN0764CH	241.75	382	034584018694	2	G18192	329.50	68	026508240335	1
DN0769	19.90	382	034584019097	3	G18192B	329.50	68	026508271285	1
DN0786BN	28.95	381	034584012982	3	G18192L	329.50	68	026508271292	1
DN0786CH	25.75	381	034584008312	3	G18195	307.70	68	026508244470	1
DN0790BN	74.90	381	034584012999	3	G18195L	307.70	68	026508248089	1
DN0790CH	66.55	381	034584008329	3	G18210	529.50	67	026508240366	1
DN0792BN	108.25	381	034584013101	3	G18211	557.40	67	026508240373	1
DN0792CH	96.15	381	034584008336	3	G18212	808.25	67	026508240403	1
DN0794BN	168.50	381	034584015174	2	G18212B	808.25	67	026508265086	1
DN0794CH	155.85	381	034584015167	2	G18215	304.35	67	026508248096	1
DN2141BN	72.35	385	034584017543	2	G18220	1,048.45	64	026508248454	1
DN2141CH	66.40	385	034584017536	2	G18231	821.20	67	026508240458	1
DN2141WB	84.25	385	034584017550	2	G18237	918.45	65	026508240489	1
DN6801BN	28.40	380	034584001146	12	G18242	826.55	67	026508240496	1
DN6801CH	18.70	380	034584001139	3	G18246	961.70	65	026508240502	1
DN6801ORB	32.70	380	034584009333	12	G18252	889.95	65	026508255032	1
DN6803BN	19.45	380	034584483317	12	G18253	940.05	65	026508255049	1
DN6803CH	11.00	380	034584483300	3	G18255	783.35	66	026508240519	1
DN6803ORB	19.70	380	034584015983	24	G18256	432.20	66	026508240526	1
DN6808BN	30.35	380	034584483331	3	G18258B	406.25	66	026508265093	1
DN6808CH	21.10	380	034584483324	3	G18264	961.70	65	026508240557	1
DN6808ORB	33.55	380	034584015990	3	G18265	649.40	66	026508240564	1
DN6818BN	35.85	380	034584483355	3	G18273	918.45	65	026508240571	1
DN6818CH	24.65	380	034584483348	3	G18287	747.10	64	026508248157	1

Wholesale

Listed in numerical order

MODEL NUMBER	LIST PRICE	PAGE NO.	UNIVERSAL PRODUCT CODE	CASE QTY
G18288	694.70	64	026508248164	1
G18440	340.35	69	026508240618	1
G18442	420.35	69	026508240625	1
G18443	332.30	69	026508240632	1
G18450	248.55	69	026508240649	1
G18461	426.50	68	026508248171	1
G20160B	229.00	71	026508284094	1
G20192	229.00	72	026508240663	1
G20192B	229.00	72	026508258422	1
G20193	219.00	72	026508240670	1
G20193B	219.00	72	026508274965	1
G20194B	199.00	72	026508271308	1
G20210	299.00	71	026508240687	1
G20210B	299.00	71	026508258439	1
G20213B	279.00	71	026508284100	1
G20214	269.00	72	026508240694	1
G20214B	269.00	72	026508271339	1
G20216B	259.00	72	026508284117	1
G20256	389.00	71	026508240717	1
G20273	359.00	71	026508240724	1
G181631Q	522.20	70	026508274361	1
G181953Q	577.75	70	026508274378	1
G181954Q	577.75	70	026508274385	1
G182114Q	493.85	69	026508274392	1
G182133Q	392.80	69	026508274408	1
G182134Q	392.80	69	026508274415	1
G182154Q	374.85	69	026508274422	1
G182571Q	775.65	69	026508274439	1
G182574Q	775.65	69	026508274446	1
G201961BQ	159.00	74	026508284124	1
G201962BQ	159.00	74	026508284254	1
G201963BQ	159.00	74	026508284131	1
G201963Q	159.00	74	026508239209	1
G201964BQ	159.00	74	026508284148	1
G201964Q	159.00	74	026508240588	1
G201974BQ	139.00	74	026508284155	1
G201974LQ	139.00	74	026508283295	1
G201974RQ	139.00	74	026508283288	1
G202131Q	239.00	73	026508283349	1
G202133Q	239.00	73	026508283400	1
G202134BQ	239.00	73	026508283226	1
G202134Q	239.00	73	026508283394	1
G202153BQ	219.00	74	026508284162	1
G202154BQ	219.00	74	026508284179	1
G202173BQ	199.00	74	026508283264	1
G202174BQ	199.00	74	026508283257	1
G202334Q	299.00	73	026508283387	1
G202594BQ	344.00	73	026508283363	1
G202714BQ	224.00	73	026508284186	1
G202721BQ	219.00	73	026508284193	1
G202852BQ	344.00	73	026508283240	1
G202853BQ	199.00	73	026508284209	1
G202854BQ	199.00	73	026508284216	1
G202861Q	239.00	73	026508283318	1
G202864Q	239.00	73	026508283356	1
G204502	169.00	72	026508284681	1
G204502B	169.00	72	026508284001	1
G204571BQ	219.00	75	026508284223	1
G204573BQ	219.00	75	026508284230	1
G221203B	94.00	77	026508280560	1
G221204B	94.00	77	026508280577	1
G221963B	129.00	77	026508280584	1
G221964B	129.00	77	026508280591	1
G221983B	104.00	77	026508280607	1
G221984B	104.00	77	026508280614	1
G222133	184.00	76	026508284698	1
G222133B	184.00	76	026508280621	1

MODEL NUMBER	LIST PRICE	PAGE NO.	UNIVERSAL PRODUCT CODE	CASE QTY
G222134	184.00	76	026508284704	1
G222134B	184.00	76	026508280638	1
G222153B	144.00	76	026508280645	1
G222154B	144.00	76	026508280652	1
G222163	124.00	76	026508284476	1
G222163B	124.00	76	026508280669	1
G222164	16.40	76	026508284483	1
G222164B	124.00	76	026508280676	1
G222203B	114.00	76	026508280683	1
G222204B	114.00	76	026508280690	1
G2245622B	84.00	77	026508280706	1
GA716	100.65	79	026508248027	10
GA719	145.45	78	026508248034	8
GA726	70.75	364	026508248041	15
GA728	95.45	79	026508248058	12
GA746B	119.85	78	026508248188	15
GA748B	135.90	78	026508248195	12
GA749B	152.10	78	026508248201	6
GA760	170.15	78	026508248218	6
GA763	125.80	382	026508248225	12
GA768	148.45	78	026508248232	10
GA771	163.50	79	026508248249	6
GA772	125.30	79	026508248256	12
GA780B	166.25	364	026508248263	6
GA781B	148.45	79	026508248270	8
GA782B	125.80	79	026508248287	15
GA785B	137.25	79	026508248294	12
GA821	92.60	80	026508248331	10
GA841	125.30	80	026508248348	10
GA922	111.65	217	026508248386	5
GA944	163.20	261	026508248393	5
GX50C	172.00	85	026508261798	2
GX75C	292.00	84	026508277751	2
GX100C	372.00	84	026508277720	1
GXB75C	319.75	84	026508274453	2
GXL1000C	452.00	387	026508277768	1
GXP33C	113.25	85	026508261811	2
GXP50C	133.25	85	026508261804	2
GXS75C	238.70	84	026508261781	2
KG2045522BQ	119.00	75	026508284247	1
KG2045622BQ	119.00	75	026508284018	1
L2352	152.95	387	026508047538	6
L2352EP	152.95	387	026508269787	6
L2353	174.80	290	026508047569	6
L2353EP	174.80	290	026508269794	6
L2361	166.60	294	026508047613	6
L2362	177.80	292	026508047545	6
L2363	199.70	290	026508047583	6
L2368EP	221.15	292	026508241813	3
L2369EP	238.60	290	026508241820	3
L4601	133.60	286	026508047293	12
L4605	133.60	286	026508060759	12
L4621	165.00	286	026508047286	12
L4621BC	198.00	286	026508136706	12
L4621P	279.25	286	026508047385	12
L4625	165.00	286	026508047323	6
L4631BC	198.00	286	026508139301	6
L4635	165.00	286	026508061527	12
LR2350DBN	59.25	387	034584017598	3
LR2350DCH	57.00	387	034584020857	3
LR2350DOWB	62.85	387	034584020864	3
LR2352DBN	59.25	387	034584017604	3
LR2352DCH	57.00	387	034584020871	3
LR2352DOWB	62.85	387	034584020888	3
LR2354DBN	59.25	387	034584020550	3
LR2354DCH	57.00	387	034584020918	3
LR2354DOWB	62.85	387	034584020925	3

MODEL NUMBER	LIST PRICE	PAGE NO.	UNIVERSAL PRODUCT CODE	CASE QTY	MODEL NUMBER	LIST PRICE	PAGE NO.	UNIVERSAL PRODUCT CODE	CASE QTY
LR2356DCH	57.00	387	034584020895	3	S1311EP	402.70	339	026508213988	3
P5118BN	9.05	201	034584027511	36	S1311EPBN	549.65	339	026508214015	3
P5124BN	9.95	201	034584027528	36	S1311EPNL	549.65	339	026508231180	3
P26100EP	59.95	361	026508266540	12	S1311EPORB	604.55	339	026508214022	3
R2356DBN	59.25	387	034584025258	3	S1311NL	549.65	339	026508231197	3
R2356DOWB	62.85	387	034584025265	3	S1311ORB	604.55	339	026508152195	3
S110	110.40	351	026508242353	6	S3102	700.00	305	026508269916	3
S110BL	147.00	351	026508279434	6	S3104	1,500.00	305	026508269923	3
S110BN	133.65	351	026508242360	6	S3371	508.90	97	026508216408	6
S112	377.50	339	026508132753	3	S3600	129.35	97	026508216439	12
S112BN	511.10	339	026508132760	3	S3840	79.75	370	026508220726	6
S112EP	377.50	339	026508221761	3	S3840BN	123.55	370	026508220894	6
S112EPBN	511.10	339	026508222065	3	S3842	64.20	375	026508220733	6
S112EPNL	562.20	339	026508222072	3	S3842BN	99.40	375	026508220917	6
S112EPORB	562.20	339	026508222089	3	S3859	95.30	369	026508220740	6
S112NL	562.20	339	026508144671	3	S3859BN	138.20	369	026508220931	6
S112ORB	562.20	339	026508144664	3	S3859ORB	151.90	369	026508220948	6
S112WR	562.20	339	026508132777	3	S3860	93.75	374	026508220412	6
S113	110.40	351	026508133965	3	S3860BN	136.00	374	026508220436	6
S113BN	133.65	351	026508133972	3	S3860ORB	149.45	374	026508220443	6
S113NL	133.65	351	026508144695	3	S3870EP	323.10	354	026508228975	6
S113ORB	147.00	351	026508144688	3	S3870EPBN	647.95	354	026508228982	6
S113WR	147.00	351	026508133989	3	S3870EPORB	713.40	354	026508228999	6
S114	128.95	369	026508185261	6	S3879EP	285.20	354	026508221884	6
S114BN	211.05	369	026508185278	6	S3879EPBN	572.20	354	026508221891	6
S114NL	211.05	369	026508185285	6	S3894	99.55	369	026508240144	6
S114ORB	232.05	369	026508185292	6	S3896	95.30	369	026508220764	6
S115	140.25	117	026508186190	6	S3896BN	138.20	369	026508222126	6
S115BN	231.65	117	026508186206	6	S3898	93.75	374	026508220450	6
S115NL	231.65	117	026508186213	6	S3898BN	136.00	374	026508220467	6
S115ORB	254.80	117	026508186220	6	S3900	128.45	161	026508263990	6
S122	42.35	351	026508223499	6	S3901	115.65	374	026508281284	6
S122BN	87.60	351	026508223512	6	S3945C	138.15	59	026508248911	6
S122ORB	96.40	351	026508223529	6	S3945ORB	172.65	59	026508248928	6
S133	42.35	352	026508223536	6	S3945SRS	165.85	59	026508248935	6
S133BN	87.60	352	026508223543	6	S3946BL	172.70	59	026508247167	6
S156	167.55	341	026508167908	3	S3946C	138.15	59	026508248942	6
S176	167.55	341	026508139189	3	S3946ORB	172.65	59	026508248959	6
S176BL	241.85	341	026508279335	3	S3946SRS	165.85	59	026508248966	6
S176BN	230.40	341	026508152911	3	S3947C	138.15	59	026508248973	6
S176EP	167.55	341	026508214558	3	S3947SRS	165.85	59	026508247327	6
S176EPBL	241.85	341	026508279342	3	S3948C	138.15	59	026508247150	6
S176EPBN	230.40	341	026508214565	3	S3948ORB	172.65	59	026508250273	6
S177	42.25	352	026508223550	6	S3948SRS	165.85	59	026508250280	6
S177BN	87.60	352	026508223574	6	S5170	421.75	201	026508222102	3
S411	464.50	117	026508132524	3	S5170SRS	527.15	201	026508241974	3
S411BN	711.75	117	026508132739	3	S5500	244.70	57	026508249475	6
S411NL	711.75	117	026508144558	3	S5510	282.80	57	026508249482	3
S411ORB	767.75	117	026508144541	3	S5510ORB	435.10	57	026508249499	3
S664	755.15	50	026508200063	3	S5510SRS	395.90	57	026508249505	3
S664ORB	1,141.35	50	026508169032	3	S5520	282.80	57	026508249512	3
S664SRS	1,037.65	50	026508234242	3	S5520ORB	435.10	57	026508249529	3
S665	755.15	50	026508205617	3	S5520SRS	395.90	57	026508249536	3
S665SRS	1,037.65	50	026508234259	3	S5530	282.80	57	026508249543	3
S711	571.85	34	026508098943	3	S5530SRS	395.90	57	026508249550	3
S711ORB	847.95	34	026508144442	3	S6202	415.60	145	026508216507	3
S711SRS	770.70	34	026508242056	3	S6202BN	686.10	145	026508216521	3
S712	721.10	382	026508132678	2	S6202ORB	722.70	145	026508216538	3
S712ORB	1,080.40	382	026508144428	2	S6310	167.55	341	026508220771	3
S712SRS	982.15	382	026508242063	2	S6310BN	230.40	341	026508220986	3
S713	947.25	34	026508132784	3	S6310EP	167.55	341	026508221921	3
S713ORB	1,406.60	34	026508144404	3	S6310EPBN	230.40	341	026508221938	3
S713SRS	1,278.75	34	026508242070	3	S6310EPNL	219.40	341	026508234389	3
S713WR	1,184.10	34	026508132807	3	S6310EPORB	241.85	341	026508221945	3
S1300	87.80	368	026508219621	6	S6310EPWR	241.85	341	026508281000	1
S1311	402.70	339	026508152171	3	S6310NL	219.40	341	026508234549	3
S1311BN	549.65	339	026508152188	3	S6310ORB	241.85	341	026508220993	3

Wholesale

Listed in numerical order

MODEL NUMBER	LIST PRICE	PAGE NO.	UNIVERSAL PRODUCT CODE	CASE QTY
S6310WR	241.85	341	026508221013	3
S6312	109.00	343	026508220788	12
S6312BN	129.55	343	026508221037	12
S6312EP	109.00	343	026508222003	12
S6312EPBN	129.55	343	026508222027	12
S6312EPNL	129.55	343	0265082260845	6
S6312EPORB	142.45	343	0265082260852	6
S6312NL	129.55	343	0265082260869	12
S6312ORB	142.45	343	0265082260876	12
S6320	262.50	340	026508220795	3
S6320BN	412.45	340	026508221068	3
S6320EP	262.50	340	026508221853	3
S6320EPBN	412.45	340	026508221860	3
S6320EPORB	453.70	340	026508221877	3
S6320ORB	453.70	340	026508221075	3
S6335	131.35	343	026508220849	6
S6335BN	178.85	343	026508220863	6
S6335EP	131.35	343	026508221778	6
S6335EP15	131.35	343	0265082264218	6
S6335EPBN	178.85	343	026508222041	6
S6335EPORB	196.65	343	026508222058	6
S6335ORB	196.65	343	0265082220870	6
S6340	167.55	341	026508220801	3
S6340BN	230.40	341	026508220634	3
S6340EP	167.55	342	026508221907	3
S6340EP15	167.55	342	026508241790	3
S6340EP15BN	230.40	342	026508241806	3
S6340EPBN	230.40	342	026508221914	3
S6345	262.50	340	0265082260944	3
S6345BN	412.45	340	0265082260951	3
S6345EP	262.50	340	0265082260968	3
S6345EPBN	412.45	340	0265082260975	3
S6360	243.90	340	026508220481	3
S6360BN	365.90	340	0265082220498	3
S6360EP	243.90	340	0265082220504	3
S6360EPBN	365.90	340	0265082220511	3
S6360EPORB	403.10	340	026508224946	3
S6360ORB	403.10	340	026508224953	3
S6365	167.55	342	026508230220	3
S6365BN	230.40	342	026508230237	3
S6365EP	167.55	342	026508230244	3
S6365EPBN	230.40	342	026508230251	3
S6365EPORB	241.85	342	026508230268	3
S6365ORB	241.85	342	026508230275	3
S6500	361.80	158	026508216545	3
S6500BN	597.40	158	026508216569	3
S6510	297.70	158	026508216576	3
S6510BN	451.80	158	026508216590	3
S6700	415.60	125	026508216606	3
S6700BN	686.10	125	026508216613	3
S6705	519.45	125	026508242377	3
S6705BN	857.60	125	026508242384	3
S6711	581.70	125	026508216620	3
S6711BN	877.05	125	026508216637	3
S7170	468.60	35	026508216644	3
S7170SRS	585.75	35	026508242100	3
S7597C	714.25	35	026508216668	3
S7597SRS	868.15	35	026508242124	3
S8000	332.15	296	026508261446	3
S8001	321.80	139	026508261453	3
S11705EP	232.35	357	026508221969	6
S11705EPBN	336.80	357	026508221952	6
S12104	146.05	369	026508215531	6
S12104BN	231.30	369	026508215548	6
S12104NL	233.60	369	026508231166	6
S12104ORB	254.40	369	026508215555	6
S12105	131.45	374	026508281246	6

MODEL NUMBER	LIST PRICE	PAGE NO.	UNIVERSAL PRODUCT CODE	CASE QTY
S12105BN	190.65	374	026508281253	6
S12105NL	190.65	374	026508281260	6
S12105ORB	209.70	374	026508281277	6
S12107EP	469.45	354	026508218945	6
S12107EPBN	663.80	354	026508218952	6
S12107EPNL	663.80	354	026508231173	6
S12107EPORB	730.15	354	026508218969	6
S16900	123.45	374	026508282946	1
S16900BN	209.34	374	026508282953	1
S22105	1,665.10	94	026508251072	1
S22105BN	2,414.45	94	026508251089	1
S22105ORB	2,655.90	94	026508285015	1
S22110	1,665.10	94	026508255001	1
S22110BN	2,414.45	94	026508255018	1
S22110ORB	2,655.90	94	026508285022	1
S42107	532.70	92	026508215562	3
S42107BN	819.45	92	026508215579	3
S42107NL	819.45	92	026508231203	3
S42107ORB	884.15	92	026508215586	3
S43001	486.30	105	026508242391	3
S43001BN	708.90	105	026508242407	3
S62101	456.40	51	026508236420	3
S62101NL	684.70	51	026508236437	3
S62101ORB	781.95	51	026508236444	3
S62101SRS	716.65	51	026508236451	3
S62308	426.15	52	026508236796	3
S62308BL	532.60	52	026508236802	3
S62308SRS	561.15	52	026508236819	3
S62608	484.55	51	026508248478	3
S62608SRS	629.85	51	026508248485	3
S72101	759.50	35	026508236468	3
S72101NL	906.80	35	026508236475	3
S72101ORB	1,042.55	35	026508236482	3
S72101SRS	1,002.45	35	026508236499	3
S72308	532.65	27	026508236826	3
S72308BL	665.80	27	026508236833	3
S72308EC	846.05	27	026508257968	3
S72308ESRS	933.20	27	026508257975	3
S72308SRS	701.50	27	026508236840	3
S72608	538.35	36	026508248492	3
S72608SRS	699.85	36	026508248508	3
S93005	1,569.65	106	026508251096	1
S93005BN	2,276.00	106	026508251102	1
SFT3293NH	177.85	184	026508279823	3
SMA1000CH	31.20	387	034584007728	24
SMA1000OWB	31.20	387	034584007735	24
SMA1001CH	27.70	387	034584007759	10
SR2100BN	13.70	385	034584013361	25
SR2100CH	11.95	385	034584013354	25
SR2100OWB	13.90	385	034584013378	25
T181	34.55	294	026508029565	12
T373	268.80	242	026508261316	3
T373BN	402.15	242	026508261323	3
T393	364.55	181	026508249642	3
T393BL	539.85	181	026508281925	1
T393BN	509.45	181	026508249659	3
T394	567.90	182	026508249666	3
T394BN	934.80	182	026508249673	3
T653	364.55	171	026508253830	3
T653BN	509.45	171	026508253847	3
T653NL	509.45	171	026508256091	3
T653ORB	560.35	171	026508256107	3
T654	567.90	172	026508256114	3
T654BN	934.80	172	026508254448	3
T654NL	934.80	172	026508254509	3
T654ORB	1,028.25	172	026508254578	3
T657	371.80	171	026508253854	3

MODEL NUMBER	LIST PRICE	PAGE NO.	UNIVERSAL PRODUCT CODE	CASE QTY	MODEL NUMBER	LIST PRICE	PAGE NO.	UNIVERSAL PRODUCT CODE	CASE QTY
T657BN	519.60	171	026508253861	3	T2112BN	281.55	223	026508115312	3
T657NL	519.60	171	026508256121	3	T2112EP	154.80	223	026508208823	3
T657ORB	571.55	171	026508256138	3	T2112EPBN	281.55	223	026508208854	3
T658	579.30	172	026508256145	3	T2112EPORB	309.65	223	026508208861	3
T658BN	953.50	172	026508256152	3	T2112EPP	394.65	223	026508232507	3
T658ORB	1,048.80	172	026508256176	3	T2112NH	123.15	223	026508208885	3
T683	268.80	235	026508264621	3	T2112NHBN	223.65	223	026508208915	3
T683BN	402.15	235	026508264638	3	T2112NHORB	246.00	223	026508208922	3
T683ORB	442.45	235	026508264645	3	T2112ORB	309.65	223	026508132371	3
T693	364.55	193	026508230701	3	T2112P	394.65	223	026508115237	3
T693BN	509.45	193	026508230718	3	T2112WR	309.65	223	026508115398	3
T693ORB	560.35	193	026508230725	3	T2113	196.90	222	026508108000	3
T694	567.90	194	026508230732	3	T2113BN	357.90	222	026508115329	3
T694BN	934.80	194	026508230749	3	T2113EP	196.90	222	026508208946	3
T694ORB	1,028.25	194	026508230756	3	T2113EPBN	357.90	222	026508208977	3
T920	419.25	216	026508126868	3	T2113EPORB	393.85	222	026508208984	3
T920BN	585.75	216	026508126882	3	T2113EPP	487.15	222	026508232521	3
T920ORB	644.30	216	026508132494	3	T2113NH	132.60	222	026508209004	3
T920P	640.45	216	026508164105	3	T2113NHBN	259.35	222	026508209035	3
T920WR	644.30	216	026508126899	3	T2113NHORB	285.30	222	026508209042	3
T922	653.10	217	026508126905	3	T2113ORB	393.85	222	026508132388	3
T922BN	1,075.00	217	026508126929	3	T2113P	487.15	222	026508115244	3
T922ORB	1,182.50	217	026508132500	3	T2113WR	393.85	222	026508115404	3
T924	422.05	252	026508162019	3	T2131	54.80	265	026508153222	3
T924BN	534.65	252	026508161036	3	T2131BN	125.15	265	026508153239	3
T924ORB	588.15	252	026508161043	3	T2131ORB	137.65	265	026508153246	3
T933	268.80	251	026508162118	3	T2132	71.85	264	026508153253	3
T933BN	402.15	251	026508162132	3	T2132BN	154.65	264	026508153260	3
T933ORB	442.45	251	026508162125	3	T2132EPBN	154.65	264	026508209066	3
T935	364.55	228	026508027806	3	T2132EPORB	170.10	264	026508209073	3
T935BN	509.45	228	026508258385	3	T2132NHBN	132.60	264	026508207819	3
T936	567.90	229	026508235171	3	T2132NHORB	145.85	264	026508207826	3
T943	268.80	260	026508153192	3	T2132ORB	170.10	264	026508153277	3
T943BN	402.15	260	026508153208	3	T2133	104.65	263	026508153284	3
T943ORB	442.45	260	026508153215	3	T2133BN	204.00	263	026508153291	3
T944	422.05	261	026508153161	3	T2133EPBN	204.00	263	026508207833	3
T944BN	534.65	261	026508153178	3	T2133EPORB	224.40	263	026508207840	3
T944ORB	588.15	261	026508153185	3	T2133NHBN	156.25	263	026508207857	3
T961	263.10	276	026508272190	3	T2133NHORB	167.20	263	026508207864	3
T986	268.80	269	026508207178	3	T2133ORB	224.40	263	026508153307	3
T986BN	402.15	269	026508207185	3	T2137EP	128.35	263	026508272411	3
T987	422.05	270	026508207192	3	T2137EPBN	236.00	263	026508272428	3
T987BN	534.65	270	026508207208	3	T2137EPORB	261.15	263	026508272435	3
T990	257.95	288	026508125724	6	T2151	54.80	256	026508162149	3
T990BC	318.45	288	026508136751	6	T2151BN	125.15	256	026508162163	3
T991	383.65	289	026508125731	6	T2151ORB	137.65	256	026508162156	3
T994	159.05	288	026508017173	6	T2152	71.85	255	026508162170	3
T999	200.95	288	026508015858	6	T2152BN	154.65	255	026508162194	3
T2011	90.50	262	026508281420	12	T2152EPBN	154.65	255	026508207871	3
T2011BN	121.60	262	026508281437	12	T2152EPORB	170.10	255	026508207888	3
T2011ORB	133.80	262	026508281444	12	T2152NHBN	132.60	255	026508207895	3
T2021	90.50	253	026508281451	12	T2152NHORB	145.85	255	026508207901	3
T2021BN	121.60	253	026508281468	12	T2152ORB	170.10	255	026508162187	3
T2021ORB	133.80	253	026508281475	12	T2153	104.65	254	026508162200	3
T2031	90.50	236	026508281482	12	T2153BN	204.00	254	026508162224	3
T2031BN	121.60	236	026508281499	12	T2153EPBN	204.00	254	026508207918	3
T2031ORB	133.80	236	026508281505	12	T2153EPORB	224.40	254	026508207925	3
T2081	106.50	230	026508281543	12	T2153NHBN	156.25	254	026508207932	3
T2081BN	143.10	230	026508281604	12	T2153NHORB	167.20	254	026508207949	3
T2082	106.50	230	026508281611	12	T2153ORB	224.40	254	026508162217	3
T2082BN	143.10	230	026508281628	12	T2157EP	128.35	254	026508272442	3
T2111	116.15	224	026508107980	3	T2157EPBN	236.00	254	026508272459	3
T2111BN	210.90	224	026508115305	3	T2157EPORB	261.15	254	026508272466	3
T2111ORB	232.05	224	026508132364	3	T2181	44.35	239	026508264423	3
T2111P	313.75	224	026508115220	3	T2181BN	125.15	239	026508264430	3
T2111WR	232.05	224	026508115381	3	T2181ORB	137.65	239	026508264447	3
T2112	154.80	223	026508107997	3	T2182	59.60	238	026508264454	3

Wholesale

Listed in numerical order

MODEL NUMBER	LIST PRICE	PAGE NO.	UNIVERSAL PRODUCT CODE	CASE QTY
T2182BN	154.65	238	026508264461	3
T2182EP	59.60	238	026508264478	3
T2182EPBN	154.65	238	026508264485	3
T2182EPORB	170.10	238	026508264492	3
T2182ORB	170.10	238	026508264508	3
T2183	89.80	237	026508264515	3
T2183BN	204.00	237	026508264522	3
T2183EP	89.80	237	026508264539	3
T2183EPBN	204.00	237	026508264546	3
T2183EPORB	224.40	237	026508264553	3
T2183ORB	224.40	237	026508264560	3
T2191	116.15	188	026508249680	3
T2191BL	232.05	188	026508275030	3
T2191BN	210.90	188	026508249178	3
T2192	154.80	187	026508249710	3
T2192BL	309.75	187	026508281888	3
T2192BN	281.55	187	026508249727	3
T2192EP	154.80	187	026508249185	3
T2192EPBL	309.75	187	026508281895	3
T2192EPBN	281.55	187	026508249192	3
T2192NH	123.15	187	026508249314	3
T2192NHBL	246.00	187	026508275047	3
T2192NHBN	223.65	187	026508249321	3
T2193	196.90	186	026508249758	3
T2193BL	393.70	186	026508281901	3
T2193BN	357.90	186	026508249765	3
T2193EP	196.90	186	026508249208	3
T2193EPBL	393.70	186	026508281918	3
T2193EPBN	357.90	186	026508249772	3
T2193NH	132.60	186	026508249338	3
T2193NHBL	285.30	186	026508275054	3
T2193NHBN	259.35	186	026508249345	3
T2232EP	111.85	264	026508271414	4
T2232EPBN	192.90	264	026508271544	4
T2232EPORB	207.95	264	026508271551	4
T2233EP	143.90	263	026508271407	4
T2233EPBN	241.20	263	026508271568	4
T2233EPORB	261.15	263	026508271575	4
T2252EP	111.85	255	026508271391	4
T2252EPBN	192.90	255	026508271582	4
T2252EPORB	207.95	255	026508271599	4
T2253EP	143.90	254	026508271384	4
T2253EPBN	241.20	254	026508271605	4
T2253EPORB	261.15	254	026508271612	4
T2282EP	111.85	238	026508271438	4
T2282EPBN	192.90	238	026508271629	4
T2282EPORB	207.95	238	026508271636	4
T2283EP	143.90	237	026508271421	4
T2283EPBN	241.20	237	026508271643	4
T2283EPORB	261.15	237	026508271650	4
T2311	111.90	211	026508275429	3
T2311BN	203.20	211	026508275436	3
T2311ORB	223.55	211	026508275443	3
T2312	149.15	210	026508275450	4
T2312BN	271.25	210	026508275467	4
T2312EP	149.15	210	026508275474	4
T2312EPBN	271.25	210	026508275481	4
T2312EPORB	298.30	210	026508275498	4
T2312NH	118.65	210	026508275504	3
T2312NHBN	215.45	210	026508275511	3
T2312NHORB	236.55	210	026508275528	3
T2312ORB	298.30	210	026508275535	4
T2313	189.70	209	026508275542	4
T2313BN	344.80	209	026508275559	4
T2313EP	189.70	209	026508275566	4
T2313EPBN	344.80	209	026508275573	4
T2313EPORB	379.45	209	026508275580	4

MODEL NUMBER	LIST PRICE	PAGE NO.	UNIVERSAL PRODUCT CODE	CASE QTY
T2313NH	127.75	209	026508275597	3
T2313NHBN	249.85	209	026508275603	3
T2313NHORB	274.85	209	026508275610	3
T2313ORB	379.45	209	026508275627	4
T2401	90.50	274	026508281550	12
T2402	90.50	281	026508281635	12
T2471	53.65	284	026508271223	3
T2472EP	58.35	283	026508271230	3
T2472NH	55.50	283	026508271247	3
T2473EP	87.85	282	026508271254	3
T2473NH	75.25	282	026508271261	3
T2661	53.65	249	026508273081	3
T2662EP	58.35	249	026508273098	3
T2662NH	55.50	249	026508273104	3
T2663EP	87.85	248	026508273111	3
T2663NH	75.25	248	026508273128	3
T2691	116.15	200	026508230282	3
T2691BN	210.90	200	026508230299	3
T2691ORB	232.05	200	026508230305	3
T2692	154.80	199	026508230312	3
T2692BN	281.55	199	026508230329	3
T2692EP	154.80	199	026508230336	3
T2692EPBN	281.55	199	026508230343	3
T2692EPORB	309.65	199	026508230350	3
T2692NH	123.15	199	026508230367	3
T2692NHBN	223.65	199	026508230374	3
T2692NHORB	246.00	199	026508230381	3
T2692ORB	309.65	199	026508230398	3
T2693	196.90	198	026508230404	3
T2693BN	357.90	198	026508230411	3
T2693EP	196.90	198	026508230428	3
T2693EPBN	357.90	198	026508230435	3
T2693EPORB	393.85	198	026508230442	3
T2693NH	132.60	198	026508230459	3
T2693NHBN	259.35	198	026508230466	3
T2693NHORB	285.30	198	026508230473	3
T2693ORB	393.85	198	026508230480	3
T2721	90.50	243	026508281567	6
T2721BN	121.60	243	026508281574	6
T2741	44.35	246	026508261217	3
T2741BN	125.15	246	026508261224	3
T2742	59.60	245	026508261231	3
T2742BN	154.65	245	026508261248	3
T2742EP	59.60	245	026508261255	3
T2742EPBN	154.65	245	026508261262	3
T2743	89.80	244	026508261279	3
T2743BN	204.00	244	026508261286	3
T2743EP	89.80	244	026508261293	3
T2743EPBN	204.00	244	026508261309	3
T2801	54.80	266	026508207055	3
T2801BN	125.15	266	026508207062	3
T2802	71.85	272	026508207079	3
T2802BN	154.65	272	026508207086	3
T2802EPBN	154.65	272	026508208311	3
T2802NH	61.30	272	026508224489	3
T2802NHBN	132.60	272	026508208328	3
T2803	104.65	266	026508207093	3
T2803BN	204.00	266	026508207109	3
T2803EPBN	204.00	266	026508208335	3
T2803NH	76.55	266	026508224496	3
T2803NHBN	156.25	266	026508208342	3
T2811	116.15	233	026508235102	3
T2811BN	210.90	233	026508258323	3
T2812	154.80	266	026508235119	3
T2812BN	281.55	266	026508258330	3
T2812EP	154.80	266	026508235126	3
T2812EPBN	281.55	266	026508258347	3

MODEL NUMBER	LIST PRICE	PAGE NO.	UNIVERSAL PRODUCT CODE	CASE QTY	MODEL NUMBER	LIST PRICE	PAGE NO.	UNIVERSAL PRODUCT CODE	CASE QTY
T2812NH	123.15	266	026508256671	3	T3693BN	484.80	196	026508230565	3
T2812NHBN	223.65	266	026508277997	3	T3693NH	169.40	196	026508270943	3
T2813	196.90	231	026508235133	3	T3693NHBN	329.65	196	026508270950	3
T2813BN	357.90	231	026508258354	3	T3693ORB	533.25	196	026508230572	3
T2813EP	196.90	231	026508235140	3	T4111	159.40	218	026508115176	3
T2813EPBN	357.90	231	026508258361	3	T4111BN	214.10	218	026508115558	3
T2813NH	132.60	231	026508256688	3	T4111ORB	235.50	218	026508132425	3
T2813NHBN	259.35	231	026508278000	3	T4111P	236.45	218	026508115503	3
T2842EP	111.85	245	026508271452	4	T4171	105.80	322	026508201947	6
T2842EPBN	192.90	245	026508271667	4	T4171BN	142.25	322	026508201954	6
T2843EP	143.90	244	026508271445	4	T4171ORB	156.50	322	026508201961	6
T2843EPBN	241.20	244	026508271674	4	T4191	106.50	183	026508249253	12
T2901	53.65	280	026508272121	3	T4191BL	157.40	183	026508275061	12
T2902EP	58.35	279	026508272138	3	T4191BN	143.10	183	026508249260	12
T2902NH	55.50	279	026508272145	3	T4192	106.50	183	026508260326	12
T2903EP	87.85	278	026508272152	3	T4192BL	157.40	183	026508281659	12
T2903NH	75.25	278	026508272169	3	T4192BN	143.10	183	026508281666	12
T2921	90.50	277	026508281581	12	T4301	102.60	206	026508275726	12
T2922	90.50	277	026508281642	12	T4301BN	137.85	206	026508275733	12
T3002EP	99.85	279	026508272176	4	T4301ORB	151.65	206	026508275740	12
T3003EP	129.40	278	026508272183	4	T4311	106.50	218	026508250402	6
T3111	123.00	221	026508108017	3	T4311BN	143.10	218	026508250419	6
T3111BN	287.00	221	026508115336	3	T4311ORB	157.40	218	026508250426	6
T3111ORB	315.70	221	026508132395	3	T4501	116.15	178	026508253441	3
T3111P	333.45	221	026508115251	3	T4501BN	210.90	178	026508253458	3
T3112	164.15	220	026508108024	3	T4501NL	210.90	178	026508255759	3
T3112BN	371.85	220	026508115343	3	T4501ORB	232.05	178	026508255766	3
T3112NH	111.65	220	026508270820	3	T4502	154.80	177	026508253465	3
T3112NHBN	252.85	220	026508270837	3	T4502BN	281.55	177	026508253472	3
T3112NHORB	278.20	220	026508270844	3	T4502EP	154.80	177	026508253489	3
T3112ORB	409.10	220	026508132401	3	T4502EPBN	281.55	177	026508253496	3
T3112P	432.20	220	026508115268	3	T4502EPORB	309.65	177	026508255780	3
T3113	222.70	219	026508108031	3	T4502NH	123.15	177	026508253663	3
T3113BN	474.95	219	026508115350	3	T4502NHBN	223.65	177	026508253502	3
T3113NH	151.45	219	026508270851	3	T4502NL	281.55	177	026508255803	3
T3113NHBN	322.95	219	026508270868	3	T4502ORB	309.65	177	026508255810	3
T3113NHORB	355.20	219	026508270875	3	T4503	196.90	176	026508253519	3
T3113ORB	522.30	219	026508132418	3	T4503BN	357.90	176	026508253526	3
T3113P	551.80	219	026508115275	3	T4503EP	196.90	176	026508253533	3
T3291	137.50	185	026508249819	3	T4503EPBN	357.90	176	026508253540	3
T3291BN	292.90	185	026508249826	3	T4503EPORB	393.85	176	026508255834	3
T3292	183.50	185	026508249215	3	T4503NH	132.60	176	026508253557	3
T3292BN	379.70	185	026508249222	3	T4503NHBN	259.35	176	026508253670	3
T3292NH	124.80	185	026508270882	3	T4503NL	357.90	176	026508255865	3
T3292NHBN	258.20	185	026508270899	3	T4503ORB	393.85	176	026508255872	3
T3293	249.05	184	026508249239	3	T4511	106.50	173	026508253687	12
T3293BN	484.80	184	026508249246	3	T4511BN	143.10	173	026508253694	12
T3293NH	169.40	184	026508270905	3	T4511NL	143.10	173	026508255889	12
T3293NHBN	329.65	184	026508270912	3	T4511ORB	157.40	173	026508255896	12
T3311	118.50	208	026508275634	3	T4512	106.50	173	026508281291	12
T3311BN	276.50	208	026508275641	3	T4512BN	143.10	173	026508281307	12
T3311ORB	304.15	208	026508275658	3	T4512NL	143.10	173	026508281314	12
T3312NH	107.55	208	026508275665	3	T4512ORB	157.40	173	026508281321	12
T3312NHBN	243.60	208	026508275672	3	T4520	257.60	170	026508253403	3
T3312NHORB	268.00	208	026508275689	3	T4520BN	432.95	170	026508253700	3
T3313NH	145.90	207	026508275696	3	T4520NL	432.95	170	026508255902	3
T3313NHBN	311.15	207	026508275702	3	T4520ORB	476.20	170	026508255919	3
T3313NHORB	342.20	207	026508275719	3	T4524	262.70	170	026508253717	3
T3691	137.50	197	026508230497	3	T4524BN	441.55	170	026508253762	3
T3691BN	292.90	197	026508230503	3	T4524NL	441.55	170	026508255926	3
T3691ORB	322.25	197	026508230510	3	T4524ORB	485.75	170	026508255933	3
T3692	183.50	197	026508230527	3	T4611	106.50	195	026508230589	12
T3692BN	379.70	197	026508230534	3	T4611BN	143.10	195	026508230596	12
T3692NH	124.80	197	026508270929	3	T4611ORB	157.40	195	026508230602	12
T3692NHBN	258.20	197	026508270936	3	T4612	106.50	195	026508281338	12
T3692ORB	417.65	197	026508230541	3	T4612BN	143.10	195	026508281345	12
T3693	249.05	196	026508230558	3	T4612ORB	157.40	195	026508281352	12

Wholesale

Listed in numerical order

MODEL NUMBER	LIST PRICE	PAGE NO.	UNIVERSAL PRODUCT CODE	CASE QTY
T4943	202.85	251	026508162088	3
T4943BN	264.75	251	026508162101	3
T4943ORB	291.15	251	026508162095	3
T5191	401.50	188	026508249277	3
T5191BN	549.85	188	026508249284	3
T5210	401.50	224	026508115152	3
T5210BN	549.85	224	026508115565	3
T5210ORB	604.80	224	026508171905	3
T5220	366.95	265	026508171769	3
T5220BN	443.10	265	026508171776	3
T5220ORB	487.40	265	026508171783	3
T5225	366.95	256	026508171790	3
T5225BN	443.10	256	026508171806	3
T5225ORB	487.40	256	026508171813	3
T5245	401.50	178	026508255940	3
T5245BN	549.85	178	026508255957	3
T5245ORB	604.80	178	026508255971	3
T5269	401.50	200	026508230619	3
T5269BN	549.85	200	026508230626	3
T5269ORB	604.80	200	026508230633	3
T5501	137.50	175	026508253779	3
T5501BN	292.90	175	026508253786	3
T5501NL	292.90	175	026508256039	3
T5501ORB	322.25	175	026508256046	3
T5502	183.50	175	026508253793	3
T5502BN	379.70	175	026508253809	3
T5502NH	124.80	175	026508270974	3
T5502NHBN	258.20	175	026508270981	3
T5502NHORB	284.05	175	026508270998	3
T5502NL	379.70	175	026508256053	3
T5502ORB	417.65	175	026508256060	3
T5503	249.05	174	026508253816	3
T5503BN	484.80	174	026508253823	3
T5503NH	169.40	174	026508271001	3
T5503NHBN	329.65	174	026508271018	3
T5503NHORB	362.65	174	026508271025	3
T5503NL	484.80	174	026508256077	3
T5503ORB	533.25	174	026508256084	3
T6105	257.60	215	026508107966	3
T6105BN	432.95	215	026508115527	3
T6105ORB	476.20	215	026508132449	3
T6107	293.70	215	026508166031	3
T6107BN	478.25	215	026508166048	3
T6107ORB	526.20	215	026508166055	3
T6125	296.20	215	026508126820	3
T6125BN	497.75	215	026508126844	3
T6125ORB	547.60	215	026508132463	3
T6125P	560.45	215	026508164099	3
T6125WR	547.60	215	026508126851	3
T6142	161.15	275	026508272114	3
T6173	164.70	241	026508261330	3
T6173BN	246.90	241	026508261347	3
T6193	257.60	180	026508249857	3
T6193BL	476.20	180	026508275078	3
T6193BN	432.95	180	026508249291	3
T6405	265.90	203	026508275757	3
T6405BN	414.50	203	026508275764	3
T6405ORB	451.60	203	026508275771	3
T6420	164.70	259	026508153130	3
T6420BN	246.90	259	026508153147	3
T6420ORB	271.50	259	026508153154	3
T6620	164.70	250	026508162071	3
T6620BN	246.90	250	026508161012	3
T6620ORB	271.50	250	026508161029	3
T6805	164.70	234	026508264591	3
T6805BN	246.90	234	026508264607	3
T6805ORB	271.50	234	026508264614	3

MODEL NUMBER	LIST PRICE	PAGE NO.	UNIVERSAL PRODUCT CODE	CASE QTY
T6820	164.70	268	026508207154	3
T6820BN	246.90	268	026508207161	3
T6905	257.60	190	026508230640	3
T6905BN	432.95	190	026508230657	3
T6905ORB	476.20	190	026508230664	3
T6906	293.70	191	026508230671	3
T6906BN	478.25	191	026508230688	3
T6906ORB	526.20	191	026508230695	3
T6920	257.60	227	026508235157	3
T6920BN	432.95	227	026508258378	3
T9023	328.40	204	026508275788	3
T9023BN	461.50	204	026508275795	3
T9023ORB	501.15	204	026508275801	3
T9024	446.35	205	026508275818	3
T9024BN	628.55	205	026508275825	3
T9024ORB	674.10	205	026508275832	3
T62132EP	59.60	264	026508208359	12
T62132NH	56.65	264	026508208366	12
T62133EP	89.80	263	026508208373	12
T62133NH	76.90	263	026508208380	12
T62152EP	59.60	255	026508208397	12
T62152NH	56.65	255	026508208403	12
T62153EP	89.80	254	026508208410	12
T62153NH	76.90	254	026508208427	12
T62802EP	59.60	272	026508208434	12
T62803EP	89.80	271	026508208458	12
T90331	32.45	376	026508184455	12
T90331BN	102.30	376	026508184509	12
T90331NL	102.30	376	026508184516	12
T90331ORB	112.55	376	026508184523	12
T90331P	112.55	376	026508184530	12
T90331WR	112.55	376	026508184578	12
TG2045522BQ	269.00	75	026508284025	1
TG2045622BQ	269.00	75	026508284032	1
TL181	34.55	294	026508047620	12
TL182	38.05	293	026508047552	12
TL182EP	38.05	293	026508208472	12
TL182EPBC	71.30	293	026508208489	12
TL183	61.70	291	026508047590	12
TL183EP	61.70	291	026508208519	12
TL183EPBC	95.40	291	026508208526	12
TL2368EP	80.15	292	026508242414	6
TL2369EP	97.55	290	026508242421	6
TL5265	226.40	295	026508255162	3
TR1000BN	33.25	387	034584017710	3
TR1000CH	33.25	387	034584017727	3
TR1000OWB	33.25	387	034584017734	3
TS214	712.70	118	026508170267	3
TS214BN	1,011.30	118	026508170274	3
TS214NL	1,011.30	118	026508170281	3
TS214ORB	1,091.20	118	026508170298	3
TS310	248.15	122	026508184707	3
TS310BN	362.10	122	026508184714	3
TS310NL	362.10	122	026508184721	3
TS310ORB	390.70	122	026508184738	3
TS312	483.60	121	026508170410	3
TS312BN	692.90	121	026508170427	3
TS312NL	692.90	121	026508170434	3
TS312ORB	747.60	121	026508170441	3
TS314	579.10	121	026508170519	3
TS314BN	824.05	121	026508170526	3
TS314NL	824.05	121	026508170533	3
TS314ORB	889.00	121	026508170540	3
TS325	223.35	120	026508250488	6
TS325BN	271.55	120	026508250495	6
TS325NL	271.55	120	026508251157	6
TS325ORB	293.00	120	026508250501	6

MODEL NUMBER	LIST PRICE	PAGE NO.	UNIVERSAL PRODUCT CODE	CASE QTY	MODEL NUMBER	LIST PRICE	PAGE NO.	UNIVERSAL PRODUCT CODE	CASE QTY
TS325WR	293.00	120	026508251164	6	TS2213BN	536.20	153	026508216941	3
TS418	547.25	189	026508170618	3	TS2213EP	289.40	153	026508222188	3
TS418BN	830.30	189	026508170625	3	TS2213EPBN	536.20	153	0265082223376	3
TS418NL	830.30	189	026508170632	3	TS2213EPORB	564.85	153	026508223383	3
TS418ORB	895.85	189	026508170649	3	TS2213ORB	564.85	153	026508216958	3
TS514	151.70	119	026508170762	6	TS2711	162.55	136	026508215111	3
TS514BN	217.10	119	026508170779	6	TS2711BN	301.00	136	026508216989	3
TS514NL	217.10	119	026508170786	6	TS2712	216.80	135	026508215128	3
TS514ORB	234.30	119	026508170793	6	TS2712BN	401.60	135	026508216996	3
TS903	510.30	127	026508215371	3	TS2712EP	216.80	135	026508222218	3
TS903BN	726.65	127	026508217771	3	TS2712EPBN	401.60	135	026508223413	3
TS904	794.80	128	026508215395	3	TS2712NH	172.25	135	026508222225	3
TS904BN	1,333.45	128	026508217795	3	TS2712NHBN	319.10	135	026508223420	3
TS923	535.85	146	026508215432	3	TS2713	275.60	134	026508215135	3
TS923BN	763.00	146	026508217856	3	TS2713BN	510.60	134	026508217009	3
TS923ORB	803.60	146	026508217863	3	TS2713EP	275.60	134	026508222249	3
TS925	834.50	147	026508215449	3	TS2713EPBN	510.60	134	026508223437	3
TS925BN	1,400.20	147	026508217887	3	TS2713NH	185.55	134	026508222232	3
TS925ORB	1,474.85	147	026508217894	3	TS2713NHBN	369.95	134	026508223444	3
TS963	434.75	159	026508215470	3	TS3100	273.90	129	026508223581	3
TS963BN	619.00	159	026508217931	3	TS3100BN	414.35	129	026508223598	3
TS964	677.25	160	026508215487	3	TS3110	265.45	119	026508184752	3
TS964BN	1,136.20	160	026508217955	3	TS3110BN	390.75	119	026508184769	3
TS1320	128.75	368	026508219638	6	TS3110NL	390.75	119	026508184776	3
TS1320BN	181.45	368	026508219645	6	TS3110ORB	421.60	119	026508184783	3
TS1320NL	181.45	368	026508250754	6	TS3200	126.45	161	026508223604	6
TS1320ORB	204.80	368	026508219652	6	TS3200BN	168.60	161	026508223628	6
TS1322	128.75	368	026508219669	6	TS3210	274.60	103	026508215715	3
TS1322BN	181.45	368	026508219676	6	TS3210BN	388.35	103	026508215845	3
TS1322NL	181.45	368	026508250761	6	TS3210NL	388.35	103	026508231319	3
TS1322ORB	204.80	368	026508219683	6	TS3210ORB	419.10	103	026508215852	3
TS1420	199.15	368	026508252543	6	TS3211	183.75	152	026508215142	3
TS1420BN	269.90	368	026508258743	6	TS3211BN	457.70	152	026508217115	3
TS1420NL	269.90	368	026508258750	6	TS3211ORB	482.15	152	026508217122	3
TS1420ORB	297.00	368	026508258767	6	TS3212	245.25	151	026508215159	3
TS1422	199.15	368	026508258798	6	TS3212BN	593.10	151	026508217146	3
TS1422BN	269.90	368	026508258804	6	TS3212ORB	624.80	151	026508217153	3
TS1422NL	269.90	368	026508258811	6	TS3213	332.85	151	026508215166	3
TS1422ORB	297.00	368	026508258828	6	TS3213BN	757.50	151	026508217177	3
TS2141	138.45	385	026508215029	3	TS3213ORB	797.90	151	026508217184	3
TS2141BN	256.45	385	026508216767	3	TS3300	126.45	129	026508223635	6
TS2142	184.65	166	026508215036	3	TS3300BN	168.60	129	026508223642	6
TS2142BN	342.20	166	026508216781	3	TS3302TB	460.00	305	026508269930	3
TS2142EP	184.65	166	026508222256	3	TS3304TB	700.00	305	026508269947	3
TS2142EPBN	342.20	166	026508223253	3	TS3400	426.05	309	026508215173	3
TS2143	234.95	165	026508215043	3	TS3400BN	724.05	309	026508217221	3
TS2143BN	435.10	165	026508216804	3	TS3400ORB	760.15	309	026508217238	3
TS2143EP	234.95	165	026508222263	3	TS3411	204.90	311	026508215203	3
TS2143EPBN	435.10	165	026508223277	3	TS3411BN	321.90	311	026508217313	3
TS2154	146.70	164	026508215050	3	TS3411ORB	338.10	311	026508217320	3
TS2154BN	348.70	164	026508216828	3	TS3600	105.80	97	026508215258	6
TS2155	195.70	163	026508215067	3	TS3600BN	188.25	97	026508217511	6
TS2155BN	451.95	163	026508216842	3	TS3600ORB	197.75	97	026508217528	6
TS2156	265.60	163	026508215074	3	TS3661NH	461.90	320	026508266991	3
TS2156BN	577.25	163	026508216866	3	TS3661NHBL	769.95	320	026508279441	3
TS2171	136.45	140	026508281598	12	TS3661NHBN	729.70	320	026508279458	3
TS2172	136.45	140	026508281673	12	TS3661NHORB	769.95	320	026508279465	3
TS2211	170.70	155	026508215081	3	TS3711	175.05	133	026508215265	3
TS2211BN	316.00	155	026508216880	3	TS3711BN	435.90	133	026508217559	3
TS2211ORB	332.90	155	026508216897	3	TS3713	317.00	131	026508215272	3
TS2212	227.55	257	026508215098	3	TS3713BN	721.40	131	026508217566	3
TS2212BN	421.75	257	026508216910	3	TS3713NH	215.55	131	026508271063	3
TS2212EP	227.55	257	026508222164	3	TS3715	233.50	132	026508215289	3
TS2212EPBN	421.75	257	026508223314	3	TS3715BN	565.00	132	026508217573	3
TS2212EPORB	444.10	257	026508223321	3	TS3715NH	158.75	132	026508271070	3
TS2212ORB	444.10	257	026508216927	3	TS3760	273.90	148	026508223659	3
TS2213	289.40	153	026508215104	3	TS3760BN	414.35	148	026508223673	3

Wholesale

Listed in numerical order

MODEL NUMBER	LIST PRICE	PAGE NO.	UNIVERSAL PRODUCT CODE	CASE QTY
TS37600RB	436.50	148	026508223680	3
TS3820	126.45	148	026508223697	6
TS3820BN	168.60	148	026508223710	6
TS3820ORB	177.60	148	026508223727	6
TS3900	273.90	161	026508223734	3
TS3900BN	414.35	161	026508223758	3
TS4112	190.15	162	026508215296	3
TS4112BN	260.35	162	026508217597	3
TS4172	143.05	130	026508227749	6
TS4172BN	193.20	130	026508227756	6
TS4173	143.05	130	026508281727	12
TS4173BN	193.20	130	026508281734	12
TS4211	234.30	150	026508215302	3
TS4211BN	320.80	150	026508217610	3
TS4211ORB	337.90	150	026508217627	3
TS5205	153.60	149	026508250518	6
TS5205BN	205.35	149	026508250525	6
TS5205ORB	216.35	149	026508250532	6
TS6205	372.05	145	026508215333	3
TS6205BN	637.45	145	026508217696	3
TS6205ORB	671.55	145	026508217702	3
TS6520	311.05	158	026508215340	3
TS6520BN	532.85	158	026508217726	3
TS6720	372.05	126	026508215364	3
TS6720BN	637.45	126	026508217757	3
TS6730	431.50	126	026508221679	3
TS6730BN	719.80	126	026508221686	3
TS8002	355.10	139	026508264003	3
TS8711	155.15	143	026508264010	3
TS8712	206.85	142	026508264027	3
TS8712EP	206.85	142	026508264034	3
TS8713	263.05	141	026508264041	3
TS8713EP	263.05	141	026508264058	3
TS21102	1,187.65	96	026508215593	3
TS21102BN	2,067.35	96	026508215609	3
TS21102NL	2,067.35	96	026508231210	3
TS21102ORB	2,230.45	96	026508215616	3
TS21104	1,187.65	96	026508215623	3
TS21104BN	2,067.35	96	026508215630	3
TS21104NL	2,067.35	96	026508231227	3
TS21104ORB	2,230.45	96	026508215647	3
TS22001	255.20	115	026508242438	3
TS22001BN	379.50	115	026508242445	3
TS22002	497.30	114	026508242452	3
TS22002BN	726.30	114	026508242469	3
TS22002EP	497.30	114	026508242476	3
TS22002EPBN	726.30	114	026508242483	3
TS22003	595.40	113	026508242513	3
TS22003BN	863.65	113	026508242520	3
TS22003EP	595.40	113	026508242537	3
TS22003EPBN	863.65	113	026508242544	3
TS22101	779.00	95	026508215654	3
TS22101BN	1,102.60	95	026508215661	3
TS22101NL	1,102.60	95	026508231234	3
TS22101ORB	1,189.55	95	026508215678	3
TS22103	779.00	95	026508215685	3
TS22103BN	1,102.60	95	026508215692	3
TS22103NL	1,102.60	95	026508231241	3
TS22103ORB	1,189.55	95	026508215708	3
TS23005	232.25	110	026508250433	6
TS23005BN	287.85	110	026508250440	6
TS23006	232.25	110	026508282984	12
TS23006BN	287.85	110	026508282991	12
TS25105	694.70	94	026508251119	3
TS25105BN	1,007.30	94	026508251126	3
TS32001	376.15	112	026508283004	3
TS32001BN	549.35	112	026508283011	3

MODEL NUMBER	LIST PRICE	PAGE NO.	UNIVERSAL PRODUCT CODE	CASE QTY
TS32002NH	417.95	111	026508283028	3
TS32002NHBN	610.40	111	026508283035	3
TS32003NH	461.75	111	026508283042	3
TS32003NHBN	669.80	111	026508283059	3
TS32102	523.60	102	026508215722	3
TS32102BN	764.35	102	026508215739	3
TS32102EP	523.60	102	026508218877	3
TS32102EPBN	764.35	102	026508218884	3
TS32102EPNL	764.35	102	026508231258	3
TS32102EPORB	824.55	102	026508218891	3
TS32102NL	764.35	102	026508231272	3
TS32102ORB	824.55	102	026508215777	3
TS32104	638.55	101	026508215784	3
TS32104BN	895.85	101	026508215791	3
TS32104EP	638.55	101	026508218914	3
TS32104EPBN	895.85	101	026508218921	3
TS32104EPNL	895.85	101	026508231289	3
TS32104EPORB	966.55	101	026508218938	3
TS32104NL	895.85	101	026508231302	3
TS32104ORB	966.55	101	026508215838	3
TS32110	332.05	97	026508215869	3
TS32110BN	488.70	97	026508215876	3
TS32110NL	488.70	97	026508231326	3
TS32110ORB	527.15	97	026508215883	3
TS32205	249.95	98	026508250457	6
TS32205BN	294.70	98	026508250464	6
TS32205NL	294.70	98	026508251218	6
TS32205ORB	317.95	98	026508250471	6
TS32206	249.95	98	026508281680	12
TS32206BN	294.70	98	026508281697	12
TS32206NL	294.70	98	026508281703	12
TS32206ORB	317.95	98	026508281710	12
TS33002	273.00	109	026508242599	3
TS33002BN	409.55	109	026508242605	3
TS33003	155.95	109	026508242612	6
TS33003BN	227.55	109	026508242629	6
TS33101	396.05	100	026508283103	3
TS33101BN	578.10	100	026508283110	3
TS33101NL	578.10	100	026508283127	3
TS33101ORB	625.00	100	026508283134	3
TS33102NH	440.05	99	026508283141	3
TS33102NHBN	642.35	99	026508283158	3
TS33102NHNL	642.35	99	026508283165	3
TS33102NHORB	692.95	99	026508283172	3
TS33103NH	495.20	99	026508283189	3
TS33103NHBN	694.75	99	026508283196	3
TS33103NHNL	694.75	99	026508283202	3
TS33103NHORB	749.55	99	026508283219	3
TS42106	578.70	93	026508215951	3
TS42106BN	813.00	93	026508215968	3
TS42106NL	813.00	93	026508231357	3
TS42106ORB	877.15	93	026508215975	3
TS42108	565.60	92	026508215982	3
TS42108BN	858.15	92	026508215999	3
TS42108NL	858.15	92	026508231364	3
TS42108ORB	925.90	92	026508216002	3
TS42112	578.70	93	026508216019	3
TS42112BN	813.00	93	026508216026	3
TS42112NL	813.00	93	026508231371	3
TS42112ORB	877.15	93	026508216033	3
TS42114	565.60	92	026508216040	3
TS42114BN	858.15	92	026508216057	3
TS42114NL	858.15	92	026508231388	3
TS42114ORB	925.90	92	026508216064	3
TS43002	526.55	105	026508242636	3
TS43002BN	814.35	105	026508242643	3
TS43003	538.90	105	026508242650	3

Wholesale

Listed in numerical order

MODEL NUMBER	LIST PRICE	PAGE NO.	UNIVERSAL PRODUCT CODE	CASE QTY	MODEL NUMBER	LIST PRICE	PAGE NO.	UNIVERSAL PRODUCT CODE	CASE QTY
TS43003BN	812.35	105	026508242667	3	YB2201CH	19.20	257	034584008015	6
TS50100	275.75	106	026508251133	2	YB2201ORB	32.35	257	034584008022	6
TS50110	234.40	106	026508258231	2	YB2203BN	20.80	257	034584008039	24
TS50200	413.65	94	026508251140	2	YB2203CH	13.65	257	034584008046	24
TS50210	351.55	94	026508258248	2	YB2203ORB	22.90	257	034584008053	24
TS52104	172.35	97	026508216071	6	YB2208BN	37.45	257	034584008060	6
TS52104BN	238.10	97	026508216088	6	YB2208CH	24.40	257	034584008077	6
TS52104NL	238.10	97	026508231395	6	YB2208ORB	41.15	257	034584008084	6
TS52104ORB	256.75	97	026508216095	6	YB2218BN	46.00	257	034584008091	6
TS93003	685.80	107	026508242735	3	YB2218CH	29.95	257	034584008107	6
TS93003BN	991.80	107	026508242742	3	YB2218ORB	50.60	257	034584008114	6
TS93004	1,047.05	108	026508242759	3	YB2224BN	48.35	257	034584008121	6
TS93004BN	1,867.50	108	026508242766	3	YB2224CH	31.55	257	034584008138	6
YB0402BL	56.55	189	034584026750	24	YB2224ORB	53.20	257	034584008145	6
YB0402BN	51.45	189	034584022530	24	YB2261BN	135.10	258	034584022226	2
YB0402CH	45.25	189	034584022547	24	YB2261CH	108.10	258	034584022233	2
YB0403BL	30.25	189	034584026767	24	YB2261ORB	135.10	258	034584022240	2
YB0403BN	27.50	189	034584022554	24	YB2262BN	189.20	258	034584022257	2
YB0403CH	24.95	189	034584022561	24	YB2262CH	151.30	258	034584022264	2
YB0408BL	55.55	189	034584026774	6	YB2262ORB	189.20	258	034584022271	2
YB0408BN	50.50	189	034584022578	6	YB2263BN	234.90	258	034584022288	2
YB0408CH	45.65	189	034584022585	6	YB2263CH	187.90	258	034584022295	2
YB0409BL	47.00	189	034584026781	6	YB2263ORB	234.90	258	034584022301	2
YB0409BN	42.75	189	034584022592	6	YB2264BN	300.75	258	034584022318	2
YB0409CH	38.85	189	034584022608	6	YB2264CH	240.65	258	034584022325	2
YB0418BL	64.05	189	034584026798	6	YB2264ORB	300.75	258	034584022332	2
YB0418BN	58.25	189	034584022615	6	YB2269	20.20	258	034584022349	3
YB0418CH	53.00	189	034584022622	6	YB2286BN	28.40	257	034584008152	6
YB0424BL	66.35	189	034584026804	6	YB2286CH	18.65	257	034584008169	6
YB0424BN	60.30	189	034584022639	6	YB2286ORB	31.35	257	034584008176	6
YB0424CH	54.65	189	034584022646	6	YB2303BN	21.90	247	034584024596	24
YB0486BL	44.75	189	034584026811	6	YB2303CH	14.35	247	034584024602	24
YB0486BN	40.70	189	034584022653	6	YB2308BN	37.45	247	034584024619	6
YB0486CH	37.20	189	034584022660	6	YB2308CH	24.40	247	034584024626	6
YB0801BN	93.35	116	034584021700	24	YB2318BN	46.00	247	034584024633	6
YB0801CH	76.85	116	034584021717	24	YB2318CH	29.95	247	034584024640	6
YB0803BN	81.00	116	034584021724	24	YB2324BN	48.35	247	034584024657	6
YB0803CH	73.80	116	034584021731	24	YB2324CH	31.55	247	034584024664	6
YB0808BN	115.55	116	034584021748	6	YB2386BN	28.40	247	034584024671	6
YB0808CH	105.05	116	034584021755	6	YB2386CH	18.65	247	034584024688	6
YB0818BN	133.70	116	034584021762	6	YB2401BN	29.45	274	034584016317	6
YB0818CH	121.60	116	034584021779	6	YB2401CH	19.20	274	034584016324	24
YB0824BN	144.60	116	034584021786	6	YB2403BN	20.80	274	034584016331	24
YB0824CH	131.25	116	034584021793	6	YB2403CH	13.65	274	034584016348	24
YB0886BN	93.25	116	034584021809	6	YB2408BN	37.45	274	034584016355	6
YB0886CH	84.90	116	034584021816	6	YB2408CH	24.40	274	034584016362	6
YB0892BN	242.00	116	034584021823	3	YB2418BN	46.00	274	034584016379	6
YB0892CH	211.75	116	034584021830	3	YB2418CH	29.95	274	034584016386	6
YB2101BN	29.45	240	034584024985	24	YB2422BN	70.75	274	034584024534	6
YB2101CH	19.20	240	034584024992	24	YB2422CH	55.60	274	034584024541	6
YB2101ORB	32.35	240	034584025005	24	YB2424BN	48.35	274	034584016393	6
YB2103BN	20.80	240	034584025012	24	YB2424CH	31.55	274	034584016409	6
YB2103CH	13.65	240	034584025029	24	YB2486BN	28.40	274	034584016416	6
YB2103ORB	22.90	240	034584025036	24	YB2486CH	18.65	274	034584016423	6
YB2108BN	37.45	240	034584025043	6	YB2801BN	29.45	266	034584005663	6
YB2108CH	24.40	240	034584025050	6	YB2801CH	19.20	266	034584005601	6
YB2108ORB	41.15	240	034584025067	6	YB2801ORB	32.35	266	034584005724	6
YB2118BN	46.00	240	034584025074	6	YB2803BN	20.80	266	034584005618	24
YB2118CH	29.95	240	034584025098	6	YB2803CH	13.65	266	034584005557	24
YB2118ORB	50.60	240	034584025081	6	YB2803ORB	22.90	266	034584005670	24
YB2124BN	48.35	240	034584025104	6	YB2808BN	37.45	266	034584005625	6
YB2124CH	31.55	240	034584025111	6	YB2808CH	24.40	266	034584005564	6
YB2124ORB	53.20	240	034584025128	6	YB2808ORB	41.15	266	034584005687	6
YB2186BN	28.40	240	034584025135	6	YB2818BN	46.00	266	034584005632	6
YB2186CH	18.65	240	034584025142	6	YB2818CH	29.95	266	034584005571	6
YB2186ORB	31.35	240	034584025159	6	YB2818ORB	50.60	266	034584005694	6
YB2201BN	29.45	257	034584008008	6	YB2824BN	48.35	266	034584005649	6

Wholesale

Listed in numerical order

MODEL NUMBER	LIST PRICE	PAGE NO.	UNIVERSAL PRODUCT CODE	CASE QTY
YB2824CH	31.55	266	034584005588	6
YB2824ORB	53.20	266	034584005700	6
YB2861BN	135.10	267	034584022356	2
YB2861CH	108.10	267	034584022363	2
YB2861ORB	135.10	267	034584022370	2
YB2862BN	189.20	267	034584022387	2
YB2862CH	151.30	267	034584022394	2
YB2862ORB	189.20	267	034584022400	2
YB2863BN	234.90	267	034584022417	2
YB2863CH	187.90	267	034584022424	2
YB2863ORB	234.90	267	034584022431	2
YB2864BN	300.75	267	034584022448	2
YB2864CH	240.65	267	034584022455	2
YB2864ORB	300.75	267	034584022462	2
YB2869	20.20	267	034584022479	3
YB2886BN	28.40	266	034584005656	6
YB2886CH	18.65	266	034584005595	6
YB2886ORB	31.35	266	034584005717	6
YB2894BN	167.50	266	034584015136	2
YB2894CH	152.70	266	034584015143	2
YB2894ORB	184.25	266	034584015150	2
YB5003CH	43.30	144	034584024701	24
YB5008CH	79.60	144	034584024718	6
YB5012CH	86.10	144	034584024725	6
YB5018CH	91.60	144	034584024732	6
YB5024CH	94.95	144	034584024749	6
YB5086CH	64.00	144	034584024756	6
YB5101BN	35.85	201	034584020611	24
YB5101CH	32.50	201	034584020628	24
YB5101ORB	39.40	201	034584020635	24
YB5103BN	27.50	201	034584020642	24
YB5103CH	24.95	201	034584020659	24
YB5103ORB	30.25	201	034584020666	24
YB5108BN	50.50	201	034584020673	6
YB5108CH	45.65	201	034584020680	6
YB5108ORB	55.60	201	034584020697	6
YB5118BN	58.25	201	034584020703	6
YB5118CH	53.00	201	034584020710	6
YB5118ORB	64.05	201	034584020727	6
YB5124BN	60.30	201	034584020734	6
YB5124CH	54.65	201	034584020741	6
YB5124ORB	66.40	201	034584020758	6
YB5161BN	159.25	202	034584023834	2
YB5161CH	127.35	202	034584023841	2
YB5161ORB	159.25	202	034584023858	2
YB5162BN	222.75	202	034584023865	2
YB5162CH	178.20	202	034584023872	2
YB5162ORB	222.75	202	034584023889	2
YB5163BN	276.70	202	034584023896	2
YB5163CH	221.30	202	034584023902	2
YB5163ORB	276.70	202	034584023919	2
YB5164BN	354.25	202	034584023926	2
YB5164CH	283.45	202	034584023933	2
YB5164ORB	354.25	202	034584023940	2
YB5169	23.35	202	034584023957	3
YB5170BN	38.15	201	034584020765	6
YB5170CH	35.55	201	034584020772	6
YB5170ORB	44.00	201	034584020789	6
YB5186BN	40.70	201	034584020796	6
YB5186CH	37.20	201	034584020802	6
YB5186ORB	44.75	201	034584020819	6
YB5201BN	35.85	179	034584023094	6
YB5201CH	32.50	179	034584023087	6
YB5201NL	39.40	179	034584023568	6
YB5201ORB	39.40	179	034584023575	6
YB5203BN	27.50	179	034584023117	24
YB5203CH	24.95	179	034584023100	24

MODEL NUMBER	LIST PRICE	PAGE NO.	UNIVERSAL PRODUCT CODE	CASE QTY
YB5203NL	30.25	179	034584023582	24
YB5203ORB	30.25	179	034584023599	24
YB5208BN	50.50	179	034584023131	6
YB5208CH	45.65	179	034584023124	6
YB5208NL	55.60	179	034584023605	6
YB5208ORB	55.60	179	034584023612	6
YB5218BN	58.25	179	034584023155	6
YB5218CH	53.00	179	034584023148	6
YB5218NL	64.05	179	034584023629	6
YB5218ORB	64.05	179	034584023636	6
YB5222BN	76.45	179	034584023179	6
YB5222CH	70.95	179	034584023162	6
YB5222NL	84.20	179	034584023643	6
YB5222ORB	84.20	179	034584023650	6
YB5224BN	60.30	179	034584023193	6
YB5224CH	54.65	179	034584023186	6
YB5224NL	66.40	179	034584023667	6
YB5224ORB	66.40	179	034584023674	6
YB5275BN	129.35	179	034584023537	6
YB5275CH	113.05	179	034584023544	6
YB5275OWB	140.25	179	034584023551	6
YB5286BN	40.70	179	034584023216	6
YB5286CH	37.20	179	034584023209	6
YB5286NL	44.75	179	034584023681	6
YB5286ORB	44.75	179	034584023698	6
YB5401BN	35.85	225	034584006103	24
YB5401CH	32.50	225	034584006127	24
YB5401ORB	39.40	225	034584001184	24
YB5401PB	30.15	225	034584020932	24
YB5401WR	39.40	225	034584006134	24
YB5403BN	27.50	225	034584483003	24
YB5403CH	24.95	225	034584482761	6
YB5403ORB	30.25	225	034584000330	24
YB5403PB	23.20	225	034584482921	24
YB5403WR	30.25	225	034584483089	24
YB5405BN	9.70	225	034584018151	48
YB5405CH	7.70	225	034584018168	48
YB5405ORB	10.30	225	034584018502	48
YB5407BN	19.10	225	034584018175	48
YB5407CH	15.35	225	034584018182	48
YB5407ORB	20.80	225	034584018519	48
YB5408BN	50.50	225	034584483010	6
YB5408CH	45.65	225	034584482778	6
YB5408ORB	55.60	225	034584000347	6
YB5408PB	42.40	225	034584482938	6
YB5408WR	55.60	225	034584483096	6
YB5418BN	58.25	225	034584483027	6
YB5418CH	53.00	225	034584482785	6
YB5418ORB	64.05	225	034584000606	6
YB5418PB	52.15	225	034584482945	6
YB5418WR	64.05	225	034584483102	6
YB5422BN	76.45	225	034584015686	6
YB5422CH	70.95	225	034584015693	6
YB5422ORB	84.20	225	034584015709	6
YB5422PB	68.45	225	034584020949	6
YB5422WR	84.20	225	034584015716	6
YB5424BN	60.30	225	034584483034	6
YB5424CH	54.65	225	034584482792	6
YB5424ORB	66.40	225	034584000613	6
YB5424PB	50.45	225	034584482952	6
YB5424WR	66.40	225	034584483119	6
YB5486BN	40.70	225	034584483065	6
YB5486CH	37.20	225	034584482822	6
YB5486ORB	44.75	225	034584000644	6
YB5486PB	34.50	225	034584482983	6
YB5486WR	44.75	225	034584483140	6
YB5490BN	75.70	225	034584483072	3

MODEL NUMBER	LIST PRICE	PAGE NO.	UNIVERSAL PRODUCT CODE	CASE QTY	MODEL NUMBER	LIST PRICE	PAGE NO.	UNIVERSAL PRODUCT CODE	CASE QTY
YB5490CH	70.40	225	034584482839	3	YB8003SN	5.05	296	034584003461	50
YB5490ORB	83.35	225	034584000651	3	YB8081	10.90	296	034584016836	25
YB5490WR	83.35	225	034584483157	3	YB8086BC	9.60	296	034584002228	50
YB5494BN	195.65	225	034584015075	2	YB8086CH	7.25	296	034584001689	50
YB5494CH	177.50	225	034584015082	2	YB8086OWB	11.10	296	034584009289	50
YB5494ORB	215.25	225	034584015099	2	YB8086SN	10.40	296	034584003515	50
YB5801BN	46.60	168	034584005861	6	YB8088CH	8.00	296	034584020963	25
YB5801CH	42.95	168	034584005786	24	YB8088SN	13.00	296	034584020970	25
YB5803BN	35.75	168	034584005809	24	YB8094BC	4.70	296	034584002211	50
YB5803CH	33.05	168	034584006097	24	YB8094CH	3.65	296	034584001672	50
YB5805BN	13.35	168	034584018526	144	YB8094OWB	7.45	296	034584009272	50
YB5805CH	10.20	168	034584018199	144	YB8094SN	6.05	296	034584003454	50
YB5807BN	24.75	168	034584018533	144	YB8098BC	4.00	296	034584002204	50
YB5807CH	20.30	168	034584018205	48	YB8098CH	3.15	296	034584001665	50
YB5808BN	65.65	168	034584005816	6	YB8098OWB	5.60	296	034584009265	50
YB5808CH	60.50	168	034584005731	6	YB8098SN	4.80	296	034584003492	50
YB5818BN	75.55	168	034584005823	6	YB8099BC	2.65	296	034584002198	50
YB5818CH	70.10	168	034584005748	6	YB8099CH	1.55	296	034584001658	50
YB5822BN	99.30	168	034584005847	6	YB8099OWB	1.95	296	034584009258	50
YB5822CH	94.00	168	034584005762	6	YB8099SN	2.30	296	034584003485	50
YB5824BN	78.40	168	034584005830	6	YB8201BN	64.50	156	034584011374	24
YB5824CH	72.40	168	034584005755	6	YB8201CH	59.75	156	034584011459	24
YB5886BN	52.80	168	034584005854	6	YB8201ORB	70.90	156	034584011534	24
YB5886CH	49.30	168	034584005779	6	YB8203BN	49.50	156	034584011381	24
YB5890BN	98.35	168	034584005878	6	YB8203CH	45.80	156	034584011466	24
YB5890CH	93.10	168	034584005793	6	YB8203ORB	54.45	156	034584011541	24
YB6401BN	34.55	212	034584027030	24	YB8205BN	13.95	156	034584018540	48
YB6401CH	31.30	212	034584027047	24	YB8205CH	12.05	156	034584018212	48
YB6401ORB	37.95	212	034584027054	24	YB8205ORB	15.25	156	034584018229	48
YB6403BN	26.50	212	034584027061	24	YB8207BN	26.05	156	034584018557	48
YB6403CH	24.05	212	034584027078	24	YB8207CH	24.15	156	034584018236	48
YB6403ORB	29.15	212	034584027085	24	YB8207ORB	28.40	156	034584018243	48
YB6408BN	48.65	212	034584027092	6	YB8208BN	90.90	156	034584011398	6
YB6408CH	44.00	212	034584027108	6	YB8208CH	84.25	156	034584011473	6
YB6408ORB	53.55	212	034584027115	6	YB8208ORB	100.00	156	034584011558	6
YB6418BN	56.10	212	034584027122	6	YB8218BN	104.65	156	034584011404	6
YB6418CH	51.05	212	034584027139	6	YB8218CH	96.90	156	034584011480	6
YB6418ORB	61.70	212	034584027146	6	YB8218ORB	115.10	156	034584011565	6
YB6422BN	73.65	212	034584027153	6	YB8224BN	108.50	156	034584011428	6
YB6422CH	68.35	212	034584027160	6	YB8224CH	100.35	156	034584011503	6
YB6422ORB	81.10	212	034584027177	6	YB8224ORB	119.35	156	034584011589	6
YB6424BN	58.10	212	034584027184	6	YB8261BN	191.85	157	034584018700	2
YB6424CH	52.65	212	034584027191	6	YB8261CH	153.50	157	034584018717	2
YB6424ORB	63.95	212	034584027207	6	YB8261ORB	191.85	157	034584018724	2
YB6461BN	153.40	213	034584027214	1	YB8262BN	268.50	157	034584018731	2
YB6461CH	122.70	213	034584027344	1	YB8262CH	214.80	157	034584018748	2
YB6461ORB	153.40	213	034584027351	1	YB8262ORB	268.50	157	034584018755	2
YB6462BN	214.60	213	034584027368	1	YB8263BN	333.50	157	034584018762	2
YB6462CH	171.70	213	034584027375	1	YB8263CH	266.70	157	034584018779	2
YB6462ORB	214.60	213	034584027382	1	YB8263ORB	333.50	157	034584018786	2
YB6463BN	266.55	213	034584027399	1	YB8269	28.15	157	034584019103	3
YB6463CH	213.20	213	034584027443	1	YB8286BN	73.00	156	034584011435	6
YB6463ORB	266.55	213	034584027405	1	YB8286CH	67.70	156	034584011510	6
YB6464BN	341.30	213	034584027412	1	YB8286ORB	80.35	156	034584011596	6
YB6464CH	273.05	213	034584027450	1	YB8401BN	99.15	104	034584017901	6
YB6464ORB	341.30	213	034584027429	1	YB8401CH	87.10	104	034584017918	24
YB6469	22.50	213	034584027436	3	YB8401NL	109.05	104	034584020420	24
YB6486BN	39.20	212	034584027221	6	YB8401ORB	109.05	104	034584017925	24
YB6486CH	35.85	212	034584027238	6	YB8403BN	90.50	104	034584017932	24
YB6486ORB	43.10	212	034584027245	6	YB8403CH	79.05	104	034584017949	24
YB8000BC	5.60	296	034584002181	50	YB8403NL	99.65	104	034584020437	24
YB8000CH	4.40	296	034584001641	50	YB8403ORB	99.65	104	034584017956	24
YB8000OWB	9.40	296	034584009234	50	YB8405BN	16.55	104	034584021847	48
YB8000SN	7.25	296	034584003478	50	YB8405CH	14.60	104	034584021854	48
YB8003BC	4.90	296	034584002174	50	YB8405NL	18.15	104	034584021861	48
YB8003CH	3.85	296	034584001634	50	YB8405ORB	18.15	104	034584021878	48
YB8003OWB	5.70	296	034584009241	50	YB8407BN	29.20	104	034584021885	48

Wholesale

Listed in numerical order

SUGGESTED LIST PRICES

MODEL NUMBER	LIST PRICE	PAGE NO.	UNIVERSAL PRODUCT CODE	CASE QTY
YB8407CH	27.25	104	034584021892	48
YB8407NL	32.05	104	034584021908	48
YB8407ORB	32.05	104	034584021915	48
YB8408BN	125.15	104	034584017963	6
YB8408CH	114.15	104	034584017970	6
YB8408NL	137.65	104	034584020444	6
YB8408ORB	137.65	104	034584017987	6
YB8418BN	146.40	104	034584017994	6
YB8418CH	128.90	104	034584018007	6
YB8418NL	161.15	104	034584020451	6
YB8418ORB	161.15	104	034584018014	6
YB8424BN	157.85	104	034584018021	6
YB8424CH	139.10	104	034584018038	6
YB8424NL	173.60	104	034584020468	6
YB8424ORB	173.60	104	034584018045	6
YB8486BN	102.60	104	034584018052	6
YB8486CH	89.90	104	034584018069	6
YB8486NL	112.90	104	034584020475	6
YB8486ORB	112.90	104	034584018076	6
YB8801BN	64.50	137	034584016492	24
YB8801CH	59.75	137	034584014696	24
YB8803BN	49.50	137	034584016508	24
YB8803CH	45.80	137	034584014702	24
YB8805BN	13.95	137	034584018250	48
YB8805CH	12.05	137	034584018564	48
YB8807BN	26.05	137	034584018267	48
YB8807CH	24.15	137	034584018571	48
YB8808BN	90.90	137	034584016515	6
YB8808CH	84.25	137	034584014719	6
YB8818BN	104.65	137	034584016522	6
YB8818CH	96.90	137	034584014726	6
YB8824BN	108.50	137	034584016539	6
YB8824CH	100.35	137	034584014733	6
YB8861BN	191.85	138	034584023964	2
YB8861CH	153.50	138	034584023971	2
YB8862BN	268.50	138	034584023988	2
YB8862CH	214.75	138	034584023995	2
YB8863BN	333.55	138	034584024008	2
YB8863CH	266.70	138	034584024015	2
YB8864BN	427.00	138	034584024022	2
YB8864CH	341.60	138	034584024039	2
YB8869	28.15	138	034584024046	3
YB8886BN	73.00	137	034584016546	6
YB8886CH	67.70	137	034584014740	6
YB9801BN	93.30	123	034584015617	3
YB9801CH	74.20	123	034584015624	3
YB9801NL	99.30	123	034584015631	3
YB9801ORB	99.30	123	034584015648	3
YB9803BN	81.00	123	034584000064	24
YB9803CH	73.80	123	034584000019	6
YB9803NL	89.05	123	034584003706	24
YB9803ORB	85.80	123	034584003768	24
YB9805BN	16.55	123	034584018601	48
YB9805CH	14.60	123	034584018274	48
YB9805ORB	18.15	123	034584018281	48
YB9807BN	29.20	123	034584018618	48
YB9807CH	27.25	123	034584018298	48
YB9807ORB	32.05	123	034584018304	48
YB9808BN	115.55	123	034584000224	6
YB9808CH	105.05	123	034584000217	6
YB9808NL	127.10	123	034584003713	6
YB9808ORB	127.10	123	034584003775	6
YB9818BN	133.70	123	034584000088	6
YB9818CH	121.60	123	034584000033	6
YB9818NL	147.15	123	034584003720	6
YB9818ORB	147.15	123	034584003782	6
YB9824BN	144.60	123	034584000095	6

MODEL NUMBER	LIST PRICE	PAGE NO.	UNIVERSAL PRODUCT CODE	CASE QTY
YB9824CH	131.25	123	034584000200	6
YB9824NL	159.00	123	034584003737	6
YB9824ORB	159.00	123	034584003799	6
YB9861BN	191.85	124	034584015433	2
YB9861CH	153.50	124	034584015440	2
YB9861ORB	191.85	124	034584015457	2
YB9862BN	268.50	124	034584015464	2
YB9862CH	214.75	124	034584015471	2
YB9862ORB	258.65	124	034584015488	2
YB9863BN	333.55	124	034584015495	2
YB9863CH	266.70	124	034584015501	2
YB9863ORB	333.50	124	034584015518	2
YB9864BN	427.00	124	034584015525	2
YB9864CH	341.60	124	034584015532	2
YB9864ORB	427.00	124	034584015549	2
YB9869	28.15	124	034584016645	3
YB9886BN	93.25	123	034584000101	6
YB9886CH	84.90	123	034584000040	6
YB9886NL	102.65	123	034584003744	6
YB9886ORB	102.65	123	034584003805	6
YG0412BN	107.40	189	034584024107	6
YG0412CH	88.85	189	034584024091	6
YG0418BN	112.60	189	034584024121	6
YG0418CH	92.85	189	034584024114	6
YG0424BN	121.50	189	034584024145	6
YG0424CH	96.95	189	034584024138	6
YG0436BN	136.75	189	034584024169	6
YG0436CH	110.40	189	034584024152	6
YG0442BN	202.50	189	034584024183	6
YG0442CH	162.00	189	034584024176	6
YG0712BN	69.50	382	034584021922	6
YG0712CH	62.00	382	034584021939	6
YG0718BN	73.20	381	034584021946	6
YG0718CH	65.40	381	034584021953	6
YG0724BN	76.95	381	034584021960	6
YG0724CH	68.75	381	034584021977	6
YG0736BN	87.65	382	034584021984	6
YG0736CH	78.30	382	034584021991	6
YG0742BN	129.70	382	034584022752	6
YG0742CH	115.10	382	034584022769	6
YG0812BN	149.65	116	034584022035	6
YG0812CH	138.45	116	034584022042	6
YG0818BN	156.80	116	034584022059	6
YG0818CH	144.65	116	034584022066	6
YG0824BN	169.25	116	034584022073	6
YG0824CH	151.15	116	034584022080	6
YG0836BN	190.60	116	034584022097	6
YG0836CH	172.10	116	034584022103	6
YG0842BN	266.75	116	034584022776	3
YG0842CH	240.85	116	034584022783	6
YG2212BN	98.20	257	034584024206	6
YG2212CH	80.50	257	034584024190	6
YG2212ORB	107.30	257	034584024213	6
YG2218BN	103.15	257	034584024237	6
YG2218CH	85.10	257	034584024220	6
YG2218ORB	112.85	257	034584024244	6
YG2224BN	111.70	257	034584024268	6
YG2224CH	89.10	257	034584024251	6
YG2224ORB	124.50	257	034584024275	6
YG2812BN	98.20	266	034584024299	6
YG2812CH	80.50	266	034584024282	6
YG2812ORB	107.30	266	034584024305	6
YG2818BN	103.15	266	034584024329	6
YG2818CH	85.10	266	034584024312	6
YG2818ORB	112.85	266	034584024336	6
YG2824BN	111.70	266	034584024350	6
YG2824CH	89.10	266	034584024343	6

MODEL NUMBER	LIST PRICE	PAGE NO.	UNIVERSAL PRODUCT CODE	CASE QTY
YG2824ORB	124.50	266	034584024367	6
YG5112BN	107.40	201	034584025241	6
YG5112CH	88.85	201	034584025166	6
YG5112ORB	118.10	201	034584025173	6
YG5118BN	112.60	201	034584025180	6
YG5118CH	92.85	201	034584025197	6
YG5118ORB	123.90	201	034584025203	6
YG5124BN	121.50	201	034584025210	6
YG5124CH	96.95	201	034584025227	6
YG5124ORB	133.70	201	034584025234	6
YG5412BN	107.40	226	034584483683	3
YG5412CH	88.85	226	034584482648	3
YG5412ORB	118.10	226	034584007476	3
YG5418BN	112.60	225	034584483690	3
YG5418CH	92.85	225	034584482655	3
YG5418ORB	123.90	225	034584007483	3
YG5424BN	121.50	225	034584483706	3
YG5424CH	96.95	225	034584482662	3
YG5424ORB	133.70	225	034584007490	3
YG5430BN	126.55	226	034584483713	3
YG5430CH	103.75	226	034584482679	3
YG5436BN	136.75	226	034584483720	3
YG5436CH	110.40	226	034584482686	3
YG5442BN	202.50	226	034584483737	3
YG5442CH	162.00	226	034584482693	3
YG6412BN	103.45	212	034584027252	6
YG6412CH	85.60	212	034584027269	6
YG6412ORB	113.80	212	034584027276	6
YG6418BN	108.50	212	034584027283	6
YG6418CH	89.45	212	034584027290	6
YG6418ORB	119.35	212	034584027306	6
YG6424BN	117.05	212	034584027313	6
YG6424CH	93.40	212	034584027320	6
YG6424ORB	128.80	212	034584027337	6
YG8812BN	149.65	137	034584022110	6
YG8812CH	138.45	137	034584022127	6
YG8818BN	156.80	137	034584022134	6
YG8818CH	144.65	137	034584022141	6
YG8824BN	169.25	137	034584022158	6
YG8824CH	151.15	137	034584022165	6
YG8836BN	190.60	137	034584022172	6
YG8836CH	172.10	137	034584022189	6
YG8842BN	280.00	137	034584022790	6
YG8842CH	253.25	137	034584022806	6

Bulk

Listed in numerical order

MODEL NUMBER	LIST PRICE	PAGE NO.	UNIVERSAL PRODUCT CODE	CASE QTY
62300	111.35	453	026508025857	12
62320	111.35	453	026508009208	12
62330	147.55	453	026508102312	12
62340	123.55	453	026508102305	12
62345	111.35	453	026508252512	12
62360	135.30	453	026508102275	12
62365	111.35	455	026508227251	12
62370	135.30	454	026508009215	12
62380	111.35	454	026508102268	12
62385	135.30	455	026508227268	12
62390	135.30	454	026508067055	12
62700	101.40	458	026508009277	12
62720	101.40	458	026508009284	12
63150	181.85	444	026508047170	12
63170	181.85	444	026508047187	12
64601	117.65	440	026508040751	12
64620	153.55	440	026508017241	12
64621	144.65	440	026508002896	12
64625	146.15	440	026508002902	12
64900	77.80	443	026508040775	12
64919	113.80	443	026508017265	12
64920	109.25	443	026508002889	12
64922	92.00	443	026508147955	12
64925	127.60	443	026508134542	12
66172	150.25	442	026508261194	6
66410	150.25	442	026508152485	6
66411	150.25	442	026508164051	6
66600	183.25	440	026508195420	6
66610	150.25	442	026508162064	6
66802	150.25	442	026508264379	6
66810	192.60	440	026508206942	6
67315C	239.05	438	026508069257	6
67315SRS	337.90	438	026508242933	6
67425	129.95	439	026508052983	6
67430	163.30	439	026508052884	6
67434	163.30	439	026508053041	6
67545C	314.90	438	026508209165	3
67840	198.05	438	026508138861	6
67900	96.05	439	026508015544	12
67901	98.10	439	026508092941	12
69000	109.55	443	026508045114	6
FP62300	111.35	454	026508154502	12
FP62320	111.35	453	026508154496	12
FP62340	123.55	454	026508199213	12
FP62365	111.35	455	026508233580	12
FP62370	135.30	454	026508154519	12
FP62380	111.35	454	026508154526	12
FP62385	135.30	455	026508264713	12
FP62390	135.30	455	026508235232	12
L64600	117.65	441	026508063705	12
L64601	117.65	441	026508063712	12
L64620	153.55	441	026508047309	12
L64621	144.65	441	026508047316	12
L64624	158.00	441	026508047347	12
L64625	146.15	441	026508047354	12
L64635	158.00	442	026508061534	12
T181	34.55	452	026508029565	12
T182	38.05	450	026508029589	12
T182EP	38.05	450	026508208786	12
T183	61.70	447	026508029602	12
T183EP	61.70	447	026508208809	12
T187	34.55	452	026508019832	12
T470	36.70	458	026508019825	12
T471	70.80	456	026508015742	12
T471EP	70.80	456	026508270813	12
T473	43.75	457	026508015728	12
T473EP	43.75	457	026508270967	12

MODEL NUMBER	LIST PRICE	PAGE NO.	UNIVERSAL PRODUCT CODE	CASE QTY
T62131	44.35	452	026508152492	12
T62132	59.60	449	026508152508	12
T62132EP	59.60	449	026508208359	12
T62132NH	56.65	449	026508208366	12
T62133	89.80	446	026508152515	12
T62133EP	89.80	446	026508208373	12
T62133NH	76.90	446	026508208380	12
T62151	44.35	452	026508162026	12
T62152	59.60	448	026508162033	12
T62152EP	59.60	449	026508208397	12
T62152NH	56.65	449	026508208403	12
T62153	89.80	445	026508162040	12
T62153EP	89.80	445	026508208410	12
T62153NH	76.90	445	026508208427	12
T62182	59.60	448	026508264577	12
T62183	89.80	445	026508264584	12
T62742	59.60	448	026508261354	12
T62743	89.80	445	026508261361	6
T62802	59.60	450	026508207130	12
T62802EP	59.60	450	026508208434	12
T62802NH	56.65	450	026508208441	12
T62803	89.80	446	026508207147	12
T62803EP	89.80	446	026508208458	12
T62803NH	76.90	447	026508208465	12
TL170	46.00	444	026508048870	12
TL171	50.55	444	026508048887	12
TL171NH	34.35	444	026508271032	12
TL172	82.70	444	026508048863	12
TL172NH	56.20	444	026508271049	12
TL181	34.55	452	026508047620	12
TL182	38.05	451	026508047552	12
TL182BC	75.75	451	026508137130	12
TL182EP	38.05	451	026508208472	12
TL182EPBC	71.30	451	026508208489	12
TL182NH	36.05	451	026508208496	12
TL182NHBC	70.20	451	026508208502	12
TL183	61.70	447	026508047590	12
TL183BC	101.40	447	026508137147	12
TL183EP	61.70	448	026508208519	12
TL183EPBC	95.40	448	026508208526	12
TL183NH	54.25	448	026508208533	12
TL183NHBC	94.85	448	026508208540	12
TL470	36.70	458	026508047842	12
TL471	70.80	456	026508047828	12
TL471EP	70.80	456	026508271056	12
TL473	43.75	457	026508047774	12
TL473EP	43.75	457	026508271087	12

Kitchen and Bar Collections

Genta™ One-Handle Pulldown Kitchen Faucet / 7882SRS

Please see [moen.com/consumer-support/warranty](https://www.moen.com/consumer-support/warranty)
for complete product warranty information.

imagination makes the
everyday
extraordinary.

KITCHEN



Align® One-Handle Pulldown
Kitchen Faucet with MotionSense in
Chrome Finish 7565E

We've reimagined kitchen convenience with hands-free technology as inspiring as you are.



MotionSense™ touchless activation allows you to easily turn water on and off with the wave of a hand, keeping messes and germs at bay. The Ready Sensor detects objects like cups or hands so it's always ready when you are. No hands, just freedom.

Moen® faucets with MotionSense are thoughtfully designed from start to finish — from the snap-on mounting of the control box to the push-fit hose connections, it's that easy. Installing this hands-free faucet technology is just as intuitive as using the faucet.



Kitchen Faucets with MotionSense™

KITCHEN



	MODEL NUMBER	LIST PRICE	FINISH/COLOR	CASE QTY
--	--------------	------------	--------------	----------

STÖ®	ONE-HANDLE PULLDOWN KITCHEN FAUCET - MOTIONSENSE			
	 <ul style="list-style-type: none"> • application: one hole • overall height: 17.30" • connection size: 3/8" • connection type: compression • number of functions: two-function • spray type: aerated stream; powerful cleaning rinse • water usage: 1.5 gpm (5.7 L/min) max. • handle mounting: right only • hose length: 68" 	PREMIUM		
572308EC		846.05	Chrome	3
572308ESRS ●		933.20	Spot Resist Stainless	3
AC ADAPTERS SOLD SEPARATELY				
	169031	132.55		12



motionsense® POWERCLEAN reflex DURALOCK® DURALAST®

ALIGN®	ONE-HANDLE PULLDOWN KITCHEN FAUCET - MOTIONSENSE			
	  <ul style="list-style-type: none"> • application: one or three hole • overall height: 15.70" • connection size: 3/8" • connection type: compression • number of functions: two-function • spray type: aerated stream; powerful cleaning rinse • water usage: 1.5 gpm (5.7 L/min) max. • handle mounting: right only • hose length: 68" 	7565EC	687.10	Chrome
7565ESRS ●		733.25	Spot Resist Stainless	3
DECKPLATES SOLD SEPARATELY				
		141002	47.95	Chrome
	141002SRS ●	55.05	Spot Resist Stainless	6
	AC ADAPTERS SOLD SEPARATELY			
	169031	132.55		12

motionsense® POWERCLEAN reflex DURALOCK® DURALAST®

BRANTFORD®	ONE-HANDLE PULLDOWN KITCHEN FAUCET - MOTIONSENSE			
	  <ul style="list-style-type: none"> • application: one or three hole • overall height: 15.50" • connection size: 3/8" • connection type: compression • number of functions: three-function • spray type: powerful cleaning rinse; aerated stream; pause function • water usage: 1.5 gpm (5.7 L/min) max. • handle mounting: right only • hose length: 68" • deckplate: included 	7185EC	656.30	Chrome
7185ESRS ●		697.35	Spot Resist Stainless	3
7185EORB		723.00	Oil Rubbed Bronze	3
AC ADAPTERS SOLD SEPARATELY				
	169031	132.55		12

motionsense® POWERCLEAN reflex DURALOCK® DURALAST®

ARBOR®	ONE-HANDLE PULLDOWN KITCHEN FAUCET - MOTIONSENSE			
	  <ul style="list-style-type: none"> • application: one or three hole • overall height: 15.50" • connection size: 3/8" • connection type: compression • number of functions: three-function • spray type: powerful cleaning rinse; aerated stream; pause function • water usage: 1.5 gpm (5.7 L/min) max. • handle mounting: right only • hose length: 68" • deckplate: included 	7594EC	640.95	Chrome
7594ESRS ●		676.85	Spot Resist Stainless	3
7594EORB		709.65	Oil Rubbed Bronze	3
AC ADAPTERS SOLD SEPARATELY				
	169031	132.55		12

motionsense® POWERCLEAN reflex DURALOCK® DURALAST®

Deck Extension kits available on page 400.
Bar/Prep faucets available. See page 51 to 55.

WANT TO ADD WATER FILTRATION OR A SOAP DISPENSER IN THE KITCHEN? SEE pages 57 -60.

NOTES

- Spot Resist Stainless Finish 
-  MotionSense™ Hands-free Kitchen Faucet
-  Power Clean™ Technology
-  Self-Retracting Spray Hose
-  Duralock® Quick Connections
-  Duralast® Cartridge

freedom is the *wave* of the future.

KITCHEN



Sleek™ One-Handle Pulldown
Kitchen Faucet with
MotionSense Wave in Chrome
Finish 7864EWC

Just because life is full doesn't mean it can't feel free.



MotionSense Wave™ technology is ideal for full or messy hands. By detecting hand movement to activate water flow, this innovation limits dirt and germs. Water is delivered only when you need it for maximum freedom and minimized waste.

Moen® faucets with MotionSense™ are thoughtfully designed from start to finish — from the snap-on mounting of the control box to the push-fit hose connections, it's that easy. Installing this hands-free faucet technology is just as intuitive as using the faucet.

To learn more visit <https://www.moen.com/wave>

Kitchen Faucets with MotionSense Wave™

	MODEL NUMBER	LIST PRICE	FINISH/COLOR	CASE QTY	
ALIGN® 	ONE-HANDLE PULLDOWN SPRING KITCHEN FAUCET - MOTIONSENSE WAVE				
		5923EWC	582.50	Chrome	3
		5923EWSRS ●	617.45	Spot Resist Stainless	3
	DECKPLATES SOLD SEPARATELY				
		141002	47.95	Chrome	6
		141002SRS ●	55.05	Spot Resist Stainless	6
AC ADAPTERS SOLD SEPARATELY					
	169031	132.55		12	

 **motion**sense **WAVE** POWER CLEAN™ DURALOCK® DURALAST®

ARBOR® 	ONE-HANDLE PULLDOWN KITCHEN FAUCET - MOTIONSENSE WAVE				
		7594EWC	494.50	Chrome	3
		7594EWSRS ●	524.20	Spot Resist Stainless	3
		7594EWORB	548.90	Oil Rubbed Bronze	3
	AC ADAPTERS SOLD SEPARATELY				
		169031	132.55		12

 **motion**sense **WAVE** POWER CLEAN™ reflex™ DURALOCK® DURALAST®







SLEEK™ 	ONE-HANDLE PULLDOWN KITCHEN FAUCET - MOTIONSENSE WAVE				
		7864EWC	467.90	Chrome	3
		7864EWSRS ●	496.00	Spot Resist Stainless	3
	AC ADAPTERS SOLD SEPARATELY				
		169031	132.55		12

 **motion**sense **WAVE** POWER CLEAN™ reflex™ DURALOCK® DURALAST®

Deck Extension kits available on page 400.
 Bar/Prep faucets available. See page 51 to 55.

WANT TO ADD WATER FILTRATION OR A SOAP DISPENSER IN THE KITCHEN? SEE pages 57 -60.

NOTES

- Spot Resist Stainless Finish 
-  MotionSense Wave™ Hands-free Kitchen Faucet
-  Power Clean™ Technology
-  Self-Retracting Spray Hose
-  Duralock® Quick Connections
-  Duralast® Cartridge

KITCHEN

adore



life can get *crazy,*

but it doesn't have to look it.



ST6 One-Handle High-Arc
Pulldown Kitchen Faucet in
Spot Resist Stainless
S72308SRS

KITCHEN

Meet the technologies making today's messes ancient history.



Spot Resist™ Stainless finish maintains the brilliance of your faucets so you can leave the extra cleaning to them. Keep your fixtures spot-free so you can focus on keeping moments with your family wonder-filled. You only get one life. Why spend it cleaning?



Power Clean™ packs 50 percent more force* to attack tough messes for good, keeping your kids' kitchen experiments in their imaginations and not on your pans. More force means faster cleanup with less water used. Life may be a beautiful mess, but with Power Clean, your kitchen can just be beautiful.

Moen's Duralock® Quick-Connect Wiring System assures quick, secure and hassle-free installation for Moen® kitchen and bath faucets. This solution helps save valuable time for plumbers and DIY installers alike.

*Compared to other Moen products without Power Clean.

trim the to-do list and *fulfill* your bucket list.

KITCHEN



Arbor® Pulldown Kitchen Faucet
in Matte Black Finish 7594BL

We help get the job done quickly so you can get back to living.

POWERBOOST™

Power Boost™ technology provides a boosted stream that fills pots and pitchers quickly and a boosted spray that cleans 50 percent faster.* A boost in performance saves on time, so you can fill life with what you love.

reflex

Reflex® technology makes cleaning up after cleanup a breeze. This self-docking hose is designed to put itself away, giving you all the benefits of a flexible hose and the convenience of a spray head that retracts fully and securely.

Moen's Duralock® Quick-Connect Wiring System assures quick, secure and hassle-free installation for Moen® kitchen and bath faucets. This solution helps save valuable time for plumbers and DIY installers alike.

*Compared to other Moen products without Power Clean™ or Power Boost.



KITCHEN



explore

Premium Kitchen Faucets

KITCHEN

Waterhill®

Weymouth®

90°™







STō®

Etch®

Premium Kitchen Faucets

Bring elegance to your home with premium kitchen faucet selections from Moen®. From the sophistication of period traditional to the streamlined refinement of minimalist contemporary, you'll find a host of amazing ways to be expressive in the kitchen.



		MODEL NUMBER	LIST PRICE	FINISH/COLOR	CASE QTY
WATERHILL® TWO-HANDLE KITCHEN FAUCET					
 <ul style="list-style-type: none"> • application: three or four hole • overall height: 11.47" • connection size: 1/2" • connection type: IPS • water usage: 1.5 gpm (5.7 L/min) max. • side spray: included • side spray: can be installed with or without 	 DURALOCK® DURALAST®	PREMIUM			
		S713	947.25	Chrome	3
		S713WR	1184.10	Wrought Iron	3
		S713SRS ●	1278.75	Spot Resist Stainless	3
		S713ORB	1406.60	Oil Rubbed Bronze	3
WEYMOUTH® TWO-HANDLE KITCHEN FAUCET					
 <ul style="list-style-type: none"> • application: four hole • overall height: 12.25" • connection size: 1/2" • connection type: IPS • water usage: 1.5 gpm (5.7 L/min) max. • side spray: included 	 DURALOCK® DURALAST®	PREMIUM			
		S712	721.10	Chrome	2
		S712SRS ●	982.15	Spot Resist Stainless	2
		S712ORB	1080.40	Oil Rubbed Bronze	2
90°™ ONE-HANDLE KITCHEN FAUCET					
 <ul style="list-style-type: none"> • application: three hole • overall height: 12.25" • connection size: 3/8" • connection type: compression • water usage: 1.5 gpm (5.7 L/min) max. • side spray: included 	 DURALOCK® DURALAST®	PREMIUM			
		S711	571.85	Chrome	3
		S711SRS ●	770.70	Spot Resist Stainless	3
		S711ORB	847.95	Oil Rubbed Bronze	3

Deck Extension kits available on page 400.

Bar/Prep faucets available. See page 51 to 55.

WANT TO ADD WATER FILTRATION OR A SOAP DISPENSER IN THE KITCHEN? SEE pages 57 -60.

NOTES

- Spot Resist Stainless Finish 
- DURALOCK® Duralock® Quick Connections
- DURALAST® Duralast® Cartridge

Premium Kitchen Faucets

All Polished Nickel faucet components feature the LifeShine® Non-Tarnish Finish.

	MODEL NUMBER	LIST PRICE	FINISH/COLOR	CASE QTY	
 <p>WEYMOUTH® ONE-HANDLE KITCHEN FAUCET</p> <ul style="list-style-type: none"> • application: one or two holes • overall height: 10.50" • connection size: 3/8" • connection type: compression • water usage: 1.5 gpm (5.7 L/min) max. • handle mounting: right only • side spray: included • side spray: can be installed with or without 	PREMIUM				
	S72101	759.50	Chrome	3	
	S72101NL	906.80	Polished Nickel	3	
	S72101SRS ●	1002.45	Spot Resist Stainless	3	
	S72101ORB	1042.55	Oil Rubbed Bronze	3	
	DECKPLATES SOLD SEPARATELY				
	141002	47.95	Chrome	6	
	141002NL	52.20	Polished Nickel	6	
	141002SRS ●	55.05	Spot Resist Stainless	6	
	141002ORB	60.65	Oil Rubbed Bronze	6	



DURALOCK® DURALAST®

	MODEL NUMBER	LIST PRICE	FINISH/COLOR	CASE QTY
 <p>90 DEGREE™ ONE-HANDLE PULLOUT KITCHEN FAUCET</p> <ul style="list-style-type: none"> • application: one hole • overall height: 12.38" • connection size: 3/8" • connection type: compression • number of functions: three-function • spray type: aerated stream; powerful cleaning rinse; pause function • water usage: 1.5 gpm (5.7 L/min) max. • handle mounting: left or right • hose length: 59" 	PREMIUM			
	S7597C	714.25	Chrome	3
	S7597SRS ●	868.15	Spot Resist Stainless	3



DURALOCK® DURALAST®

	MODEL NUMBER	LIST PRICE	FINISH/COLOR	CASE QTY
 <p>ONE-HANDLE KITCHEN FAUCET</p> <ul style="list-style-type: none"> • application: one hole • overall height: 12.00" • connection size: 3/8" • connection type: compression • water usage: 1.5 gpm (5.7 L/min) max. • handle mounting: left or right 	PREMIUM			
	S7170	468.60	Chrome	3
	S7170SRS ●	585.75	Spot Resist Stainless	3



DURALAST®

Deck Extension kits available on page 400.
 Bar/Prep faucets available. See page 51 to 55.

WANT TO ADD WATER FILTRATION OR A SOAP DISPENSER IN THE KITCHEN? SEE pages 57 -60.

NOTES

- Spot Resist Stainless Finish **SPOT RESIST**
- DURALOCK® Duralock® Quick Connections
- DURALAST® Duralast® Cartridge

KITCHEN

Premium Kitchen Faucets

KITCHEN

		MODEL NUMBER	LIST PRICE	FINISH/COLOR	CASE QTY
	STO® ONE-HANDLE PULLDOWN KITCHEN FAUCET - MOTIONSENSE				
		PREMIUM			
		S72308EC	846.05	Chrome	3
		S72308ESRS ●	933.20	Spot Resist Stainless	3
		AC ADAPTERS SOLD SEPARATELY			
	169031	132.55		12	

 **motion**sense® POWER CLEAN reflex DURALOCK® DURALAST®





	ONE-HANDLE PULLDOWN KITCHEN FAUCET				
		PREMIUM			
		S72308	532.65	Chrome	3
		S72308BL	665.80	Matte Black	3
	S72308SRS ●	701.50	Spot Resist Stainless	3	

 POWER CLEAN reflex DURALOCK® DURALAST®

	ETCH® ONE-HANDLE PULLDOWN KITCHEN FAUCET				
		PREMIUM			
		S72608	538.35	Chrome	3
		S72608SRS ●	699.85	Spot Resist Stainless	3

 POWER CLEAN reflex DURALOCK® DURALAST®

NOTES

- Spot Resist Stainless Finish 
-  MotionSense™ Hands-free Kitchen Faucet
-  Power Clean™ Technology
-  Self-Retracting Spray Hose
-  Duralock® Quick Connections
-  Duralast® Cartridge

Deck Extension kits available on page 400.

Bar/Prep faucets available. See page 51 to 55.

WANT TO ADD WATER FILTRATION OR A SOAP DISPENSER IN THE KITCHEN? SEE pages 57 -60.





- Aberdeen™
- Woodmere®
- Tilt™
- Voss™
- Notch®
- Align®
- Brantford®
- Genta™
- Arbor®
- Camerist®
- Sleek™
- Belfield™
- Integra®
- Method™
- Chateau®
- Torrance™
- Banbury®

Kitchen Faucets

Moen® kitchen faucets combine meaningful innovations with an exceptional variety of attractive styles and dazzling finishes. With almost limitless design possibilities, kitchen faucets from Moen offer design, functionality and value.



KITCHEN

		MODEL NUMBER	LIST PRICE	FINISH/COLOR	CASE QTY
ABERDEEN™	ONE-HANDLE PULLDOWN KITCHEN FAUCET				
	<ul style="list-style-type: none"> • application: two hole • overall height: 14.63" • connection size: 3/8" • connection type: compression • number of functions: three-function • spray type: aerated stream; pause function; powerful cleaning rinse • water usage: 1.5 gpm (5.7 L/min) max. • hose length: 68" 	7590C	634.20	Chrome	2
		7590CSL	756.15	Classic Stainless	2
		7590ORB	793.90	Oil Rubbed Bronze	2
	 POWERCLEAN™ reflex™ DURALOCK® DURALAST®				
WOODMERE®	ONE-HANDLE PULLDOWN KITCHEN FAUCET				
	<ul style="list-style-type: none"> • application: one hole • overall height: 16.88" • connection size: 3/8" • connection type: compression • number of functions: three-function • spray type: aerated stream; pause function; powerful cleaning rinse • water usage: 1.5 gpm (5.7 L/min) max. • handle mounting: right only • hose length: 68" 	7615C	478.50	Chrome	3
		7615SRS ●	612.50	Spot Resist Stainless	3
		7615ORB	673.75	Oil Rubbed Bronze	3
	 POWERCLEAN™ reflex™ DURALOCK® DURALAST®				

NOTES







Deck Extension kits available on page 400.
 Bar/Prep faucets available. See page 51 to 55.

WANT TO ADD WATER FILTRATION OR A SOAP DISPENSER IN THE KITCHEN? SEE pages 57 -60.

- Spot Resist Stainless Finish **SPOT RESIST**
- POWERCLEAN™** Power Clean™ Technology
- reflex™** Self-Retracting Spray Hose
- DURALOCK®** Duralock® Quick Connections
- DURALAST®** Duralast® Cartridge

Kitchen Faucets

KITCHEN

		MODEL NUMBER	LIST PRICE	FINISH/COLOR	CASE QTY
TILT™ 	ONE-HANDLE PULLOUT KITCHEN FAUCET				
	<ul style="list-style-type: none"> • application: one hole • overall height: 11.92" • connection size: 3/8" • connection type: compression • number of functions: two-function • spray type: aerated stream; powerful cleaning rinse • water usage: 1.5 gpm (5.7 L/min) max. • hose length: 59" 	7626C 7626SRS ●	432.35 551.45	Chrome Spot Resist Stainless	3 3
		DURALOCK® DURALAST®			
VOSS™ 	ONE-HANDLE PULLOUT KITCHEN FAUCET				
	<ul style="list-style-type: none"> • application: one hole • overall height: 12.30" • connection size: 3/8" • connection type: compression • number of functions: two-function • spray type: powerful cleaning rinse; aerated stream • water usage: 1.5 gpm (5.7 L/min) max. • hose length: 68" 	9125C 9125SRS ● 9125ORB	432.35 551.45 606.55	Chrome Spot Resist Stainless Oil Rubbed Bronze	3 3 3
		POWERCLEAN® reflex® DURALOCK® DURALAST®			
NOTCH®  	ONE-HANDLE PULLDOWN KITCHEN FAUCET				
	<ul style="list-style-type: none"> • application: one or three hole • overall height: 16.23" • connection size: 3/8" • connection type: compression • number of functions: three-function • spray type: powerful cleaning rinse; aerated stream; pause function • water usage: 1.5 gpm (5.7 L/min) max. • handle mounting: right only • hose length: 68" 	9124C 9124SRS ● 9124ORB	425.40 542.60 596.95	Chrome Spot Resist Stainless Oil Rubbed Bronze	3 3 3
		DECKPLATES SOLD SEPARATELY			
		157328 157328SRS ● 157328ORB	42.90 49.35 54.30	Chrome Spot Resist Stainless Oil Rubbed Bronze	6 6 6
		POWERBOOST® reflex® DURALOCK® DURALAST®			



Deck Extension kits available on page 400.



Bar/Prep faucets available. See page 51 to 55.



WANT TO ADD WATER FILTRATION OR A SOAP DISPENSER IN THE KITCHEN? SEE pages 57 -60.



NOTES

- Spot Resist Stainless Finish **SPOT RESIST**
- POWERCLEAN** Power Clean™ Technology
- NEW! POWERBOOST** Powerboost™
- reflex** Self-Retracting Spray Hose
- DURALOCK** Duralock® Quick Connections
- DURALAST** Duralast® Cartridge

	MODEL NUMBER	LIST PRICE	FINISH/COLOR	CASE QTY	
 <p>ALIGN®</p> <p>ONE-HANDLE PULLDOWN SPRING KITCHEN FAUCET - MOTIONSENSE WAVE</p> <ul style="list-style-type: none"> • application: one or three hole • overall height: 22.50" • connection size: 3/8" • connection type: compression • number of functions: two-function • spray type: aerated stream; powerful cleaning rinse • water usage: 1.5 gpm (5.7 L/min) max. • handle mounting: right only • hose length: 68" <p> motion sense POWER CLEAN™ DURALOCK® DURALAST®</p>	5923EWC	582.50	Chrome	3	
	5923EWSRS ●	617.45	Spot Resist Stainless	3	
	DECKPLATES SOLD SEPARATELY				
	141002	47.95	Chrome	6	
	141002SRS ●	55.05	Spot Resist Stainless	6	
	AC ADAPTERS SOLD SEPARATELY				
	169031	132.55		12	

 <p>ONE-HANDLE PULLDOWN SPRING KITCHEN FAUCET</p> <ul style="list-style-type: none"> • application: one or three hole • overall height: 22.50" • connection size: 3/8" • connection type: compression • number of functions: two-function • spray type: aerated stream; powerful cleaning rinse • water usage: 1.5 gpm (5.7 L/min) max. • handle mounting: right only • hose length: 68" <p> POWER CLEAN™ DURALOCK® DURALAST®</p>	5923	448.95	Chrome	3	
	5923BL	561.70	Matte Black	3	
	5923SRS ●	574.65	Spot Resist Stainless	3	
	DECKPLATES SOLD SEPARATELY				
	141002	47.95	Chrome	6	
	141002BL	55.05	Matte Black	6	
	141002SRS ●	55.05	Spot Resist Stainless	6	





 <p>ONE-HANDLE PULLDOWN KITCHEN FAUCET - MOTIONSENSE</p> <ul style="list-style-type: none"> • application: one or three hole • overall height: 15.70" • connection size: 3/8" • connection type: compression • number of functions: two-function • spray type: aerated stream; powerful cleaning rinse • water usage: 1.5 gpm (5.7 L/min) max. • handle mounting: right only • hose length: 68" <p> motion sense POWER CLEAN™ reflex DURALOCK® DURALAST®</p>	7565EC	687.10	Chrome	3	
	7565ESRS ●	733.25	Spot Resist Stainless	3	
	DECKPLATES SOLD SEPARATELY				
	141002	47.95	Chrome	6	
	141002SRS ●	55.05	Spot Resist Stainless	6	
	AC ADAPTERS SOLD SEPARATELY				
	169031	132.55		12	

 <p>ONE-HANDLE PULLDOWN KITCHEN FAUCET</p> <ul style="list-style-type: none"> • application: one or three hole • overall height: 15.63" • connection size: 3/8" • connection type: compression • number of functions: two-function • spray type: aerated stream; powerful cleaning rinse • water usage: 1.5 gpm (5.7 L/min) max. • handle mounting: right only • hose length: 68" <p> POWER CLEAN™ reflex DURALOCK® DURALAST®</p>	7565	392.00	Chrome	3	
	7565BL	490.00	Matte Black	3	
	7565SRS ●	504.50	Spot Resist Stainless	3	
	DECKPLATES SOLD SEPARATELY				
	141002	47.95	Chrome	6	
	141002BL	55.05	Matte Black	6	
	141002SRS ●	55.05	Spot Resist Stainless	6	

Deck Extension kits available on page 400.
 Bar/Prep faucets available. See page 51 to 55.













WANT TO ADD WATER FILTRATION OR A SOAP DISPENSER IN THE KITCHEN? SEE pages 57 -60.

NOTES

- Spot Resist Stainless Finish 
-  MotionSense™ Hands-free Kitchen Faucet
-  Power Clean™ Technology
-  Self-Retracting Spray Hose
-  Duralock® Quick Connections
-  Duralast® Cartridge

KITCHEN

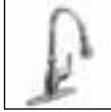
Kitchen Faucets

		MODEL NUMBER	LIST PRICE	FINISH/COLOR	CASE QTY
ALIGN® ONE-HANDLE KITCHEN FAUCET					
  <ul style="list-style-type: none"> • application: two or four hole • overall height: 15.31" • connection size: 3/8" • connection type: compression • water usage: 1.5 gpm (5.7 L/min) max. • handle mounting: right only • side spray: included 		7165	364.55	Chrome	3
		7165SRS ●	469.25	Spot Resist Stainless	3
		DECKPLATES SOLD SEPARATELY			
		141002	47.95	Chrome	6
		141002SRS ●	55.05	Spot Resist Stainless	6
	 DURALOCK® DURALAST®				
7365 ONE-HANDLE KITCHEN FAUCET					
  <ul style="list-style-type: none"> • application: one or three hole • overall height: 15.31" • connection size: 3/8" • connection type: compression • water usage: 1.5 gpm (5.7 L/min) max. • handle mounting: right only 		7365	320.80	Chrome	3
		7365SRS ●	412.85	Spot Resist Stainless	3
		DECKPLATES SOLD SEPARATELY			
		141002	47.95	Chrome	6
		141002SRS ●	55.05	Spot Resist Stainless	6
	 DURALAST®				
BRANTFORD® ONE-HANDLE PULLDOWN KITCHEN FAUCET - MOTIONSENSE					
  <ul style="list-style-type: none"> • application: one or three hole • overall height: 15.50" • connection size: 3/8" • connection type: compression • number of functions: three-function • spray type: powerful cleaning rinse; aerated stream; pause function • water usage: 1.5 gpm (5.7 L/min) max. • handle mounting: right only • hose length: 68" • deckplate: included 		7185EC	656.30	Chrome	3
		7185ESRS ●	697.35	Spot Resist Stainless	3
		7185EORB	723.00	Oil Rubbed Bronze	3
		AC ADAPTERS SOLD SEPARATELY			
		169031	132.55		12
	 motion sense™ POWERCLEAN™ reflex™ DURALOCK® DURALAST®				
ONE-HANDLE PULLDOWN KITCHEN FAUCET					
  <ul style="list-style-type: none"> • application: one or three hole • overall height: 15.50" • connection size: 3/8" • connection type: compression • number of functions: three-function • spray type: aerated stream; pause function; powerful cleaning rinse • water usage: 1.5 gpm (5.7 L/min) max. • handle mounting: right only • hose length: 68" • deckplate: included 		7185C	379.25	Chrome	3
		7185SRS ●	485.65	Spot Resist Stainless	3
		7185ORB	522.30	Oil Rubbed Bronze	3
		 POWERBOOST reflex™ DURALOCK® DURALAST®			

NOTES

- Spot Resist Stainless Finish **SPOT RESIST**
- motion**sense™ MotionSense™ Hands-free Kitchen Faucet
- POWERCLEAN™** Power Clean™ Technology
- NEW! POWERBOOST** Powerboost™
- reflex™** Self-Retracting Spray Hose
- DURALOCK** Duralock® Quick Connections
- DURALAST** Duralast® Cartridge

Deck Extension kits available on page 400.

Bar/Prep faucets available. See page 51 to 55.

WANT TO ADD WATER FILTRATION OR A SOAP DISPENSER IN THE KITCHEN? SEE pages 57 -60.

		MODEL NUMBER	LIST PRICE	FINISH/COLOR	CASE QTY
--	--	--------------	------------	--------------	----------

BRANTFORD® ONE-HANDLE PULLOUT KITCHEN FAUCET



- application: one or three hole
- overall height: 12.94"
- connection size: 3/8"
- connection type: compression
- number of functions: two-function
- spray type: aerated stream; powerful cleaning rinse
- water usage: 1.5 gpm (5.7 L/min) max.
- hose length: 68"
- deckplate: included

7295C	337.70	Chrome	3
7295SRS ●	452.15	Spot Resist Stainless	3
7295ORB	474.75	Oil Rubbed Bronze	3



POWERCLEAN reflex DURALOCK® DURALAST®

ONE-HANDLE KITCHEN FAUCET



- application: one to four hole
- overall height: 15.50"
- connection size: 3/8"
- connection type: compression
- water usage: 1.5 gpm (5.7 L/min) max.
- handle mounting: right only
- deckplate: included
- side spray: included
- side spray: can be installed with or without

7735SRS ●	463.00	Spot Resist Stainless	3
7735ORB	496.00	Oil Rubbed Bronze	3



DURALOCK® DURALAST®

GENTA™ ONE-HANDLE PULLDOWN KITCHEN FAUCET

NEW!



- application: one or three hole
- overall height: 16.00"
- connection size: 3/8"
- connection type: compression
- number of functions: two-function
- spray type: aerated stream; powerful cleaning rinse
- water usage: 1.5 gpm (5.7 L/min) max.
- handle mounting: right only
- hose length: 68"
- deckplate: included

7882	345.00	Chrome	3
7882SRS ●	437.75	Spot Resist Stainless	3



POWERCLEAN reflex DURALOCK® DURALAST®

ARBOR® ONE-HANDLE PULLDOWN KITCHEN FAUCET - MOTIONSENSE



- application: one or three hole
- overall height: 15.50"
- connection size: 3/8"
- connection type: compression
- number of functions: three-function
- spray type: powerful cleaning rinse; aerated stream; pause function
- water usage: 1.5 gpm (5.7 L/min) max.
- handle mounting: right only
- hose length: 68"
- deckplate: included

7594EC	640.95	Chrome	3
7594ESRS ●	676.85	Spot Resist Stainless	3
7594EORB	709.65	Oil Rubbed Bronze	3
AC ADAPTERS SOLD SEPARATELY			
169031	132.55		12



motionsense **POWERCLEAN** reflex DURALOCK® DURALAST®

NOTES

Deck Extension kits available on page 400.

Bar/Prep faucets available. See page 51 to 55.

WANT TO ADD WATER FILTRATION OR A SOAP DISPENSER IN THE KITCHEN? SEE pages 57 -60.

● Spot Resist Stainless Finish **SPOT RESIST**

motionsense MotionSense™ Hands-free Kitchen Faucet

POWERCLEAN Power Clean™ Technology



reflex Self-Retracting Spray Hose

DURALOCK Duralock® Quick Connections

DURALAST Duralast® Cartridge



Kitchen Faucets

KITCHEN



		MODEL NUMBER	LIST PRICE	FINISH/COLOR	CASE QTY		
 	ARBOR® ONE-HANDLE PULLDOWN KITCHEN FAUCET - MOTIONSENSE WAVE	<ul style="list-style-type: none"> • application: one or three hole • overall height: 15.70" • connection size: 3/8" • connection type: compression • number of functions: three-function • spray type: aerated stream; powerful cleaning rinse; pause function • water usage: 1.5 gpm (5.7 L/min) max. • handle mounting: right only • hose length: 68" • deckplate: included 	7594EWC	494.50	Chrome	3	
		<ul style="list-style-type: none"> • application: one or three hole • overall height: 15.70" • connection size: 3/8" • connection type: compression • number of functions: three-function • spray type: aerated stream; powerful cleaning rinse; pause function • water usage: 1.5 gpm (5.7 L/min) max. • handle mounting: right only • hose length: 68" • deckplate: included 	7594EWSRS ●	524.20	Spot Resist Stainless	3	
		<ul style="list-style-type: none"> • application: one or three hole • overall height: 15.70" • connection size: 3/8" • connection type: compression • number of functions: three-function • spray type: aerated stream; powerful cleaning rinse; pause function • water usage: 1.5 gpm (5.7 L/min) max. • handle mounting: right only • hose length: 68" • deckplate: included 	7594EWORB	548.90	Oil Rubbed Bronze	3	
					AC ADAPTERS SOLD SEPARATELY		
					169031	132.55	12





POWERCLEAN™ **reflex™** **DURALOCK®** **DURALAST®**

 	ONE-HANDLE PULLDOWN KITCHEN FAUCET	<ul style="list-style-type: none"> • application: one or three hole • overall height: 15.50" • connection size: 3/8" • connection type: compression • number of functions: three-function • spray type: aerated stream; pause function; powerful cleaning rinse • water usage: 1.5 gpm (5.7 L/min) max. • handle mounting: right only • hose length: 68" • deckplate: included 	7594C	357.60	Chrome	3
		<ul style="list-style-type: none"> • application: one or three hole • overall height: 15.50" • connection size: 3/8" • connection type: compression • number of functions: three-function • spray type: aerated stream; pause function; powerful cleaning rinse • water usage: 1.5 gpm (5.7 L/min) max. • handle mounting: right only • hose length: 68" • deckplate: included 	7594BL	447.00	Matte Black	3
		<ul style="list-style-type: none"> • application: one or three hole • overall height: 15.50" • connection size: 3/8" • connection type: compression • number of functions: three-function • spray type: aerated stream; pause function; powerful cleaning rinse • water usage: 1.5 gpm (5.7 L/min) max. • handle mounting: right only • hose length: 68" • deckplate: included 	7594SRS ●	458.05	Spot Resist Stainless	3
		<ul style="list-style-type: none"> • application: one or three hole • overall height: 15.50" • connection size: 3/8" • connection type: compression • number of functions: three-function • spray type: aerated stream; pause function; powerful cleaning rinse • water usage: 1.5 gpm (5.7 L/min) max. • handle mounting: right only • hose length: 68" • deckplate: included 	7594ORB	479.30	Oil Rubbed Bronze	3

POWERBOOST™ **reflex™** **DURALOCK®** **DURALAST®**





 	ONE-HANDLE PULLOUT KITCHEN FAUCET	<ul style="list-style-type: none"> • application: one or three hole • overall height: 12.13" • connection size: 3/8" • connection type: compression • number of functions: three-function • spray type: aerated stream; pause function; powerful cleaning rinse • water usage: 1.5 gpm (5.7 L/min) max. • handle mounting: right only • hose length: 59" • deckplate: included 	7294C	333.10	Chrome	3
		<ul style="list-style-type: none"> • application: one or three hole • overall height: 12.13" • connection size: 3/8" • connection type: compression • number of functions: three-function • spray type: aerated stream; pause function; powerful cleaning rinse • water usage: 1.5 gpm (5.7 L/min) max. • handle mounting: right only • hose length: 59" • deckplate: included 	7294BL	416.40	Matte Black	3
		<ul style="list-style-type: none"> • application: one or three hole • overall height: 12.13" • connection size: 3/8" • connection type: compression • number of functions: three-function • spray type: aerated stream; pause function; powerful cleaning rinse • water usage: 1.5 gpm (5.7 L/min) max. • handle mounting: right only • hose length: 59" • deckplate: included 	7294SRS ●	426.65	Spot Resist Stainless	3
		<ul style="list-style-type: none"> • application: one or three hole • overall height: 12.13" • connection size: 3/8" • connection type: compression • number of functions: three-function • spray type: aerated stream; pause function; powerful cleaning rinse • water usage: 1.5 gpm (5.7 L/min) max. • handle mounting: right only • hose length: 59" • deckplate: included 	7294ORB	453.00	Oil Rubbed Bronze	3

POWERCLEAN™ **DURALOCK®** **DURALAST®**

 	ONE-HANDLE KITCHEN FAUCET	<ul style="list-style-type: none"> • application: one to four hole • overall height: 15.50" • connection size: 3/8" • connection type: compression • water usage: 1.5 gpm (5.7 L/min) max. • handle mounting: right only • deckplate: included • side spray: included • side spray: can be installed with or without 	7790	339.00	Chrome	3
		<ul style="list-style-type: none"> • application: one to four hole • overall height: 15.50" • connection size: 3/8" • connection type: compression • water usage: 1.5 gpm (5.7 L/min) max. • handle mounting: right only • deckplate: included • side spray: included • side spray: can be installed with or without 	7790SRS ●	436.65	Spot Resist Stainless	3

DURALOCK® **DURALAST®**









NOTES

- Spot Resist Stainless Finish 
-  MotionSense Wave™ Hands-free Kitchen Faucet
-  Power Clean™ Technology
-   Powerboost™
-  Self-Retracting Spray Hose
- DURALOCK®** Duralock® Quick Connections
- DURALAST®** Duralast® Cartridge

Deck Extension kits available on page 400.

Bar/Prep faucets available. See page 51 to 55.

WANT TO ADD WATER FILTRATION OR A SOAP DISPENSER IN THE KITCHEN? SEE pages 57 -60.

	MODEL NUMBER	LIST PRICE	FINISH/COLOR	CASE QTY	
CAMERIST® ONE-HANDLE PULLOUT KITCHEN FAUCET					
	• application: one or three hole	7545C ◆	337.70	Chrome	3
	• overall height: 12.00"	7545SRS ●	452.15	Spot Resist Stainless	3
	• connection size: 3/8"	7545ORB	474.75	Oil Rubbed Bronze	3
	<ul style="list-style-type: none"> • connection type: compression • number of functions: two-function • spray type: aerated stream; powerful cleaning rinse • water usage: 1.5 gpm (5.7 L/min) max. • hose length: 68" • deckplate: included 				
	 POWERCLEAN reflex DURALOCK® DURALAST®				
ONE-HANDLE KITCHEN FAUCET					
	• application: three hole	7835	207.05	Chrome	3
	• overall height: 8.13"	7835SRS ●	306.35	Spot Resist Stainless	3
	• connection size: 3/8"				
	<ul style="list-style-type: none"> • connection type: compression • water usage: 1.5 gpm (5.7 L/min) max. • deckplate: included • side spray: included 				
	 DURALOCK ® DURALAST ®				
ONE-HANDLE PULLOUT KITCHEN FAUCET					
	• application: two or four hole	7840 ◆	207.05	Chrome	3
	• overall height: 8.13"	7840SRS ●	303.70	Spot Resist Stainless	3
	• connection size: 3/8"	7840ORB	326.00	Oil Rubbed Bronze	3
	<ul style="list-style-type: none"> • connection type: compression • water usage: 1.5 gpm (5.7 L/min) max. • deckplate: included • side spray: included 				
	 DURALOCK ® DURALAST ®				
ONE-HANDLE PULLOUT KITCHEN FAUCET					
	• application: one or three hole	7825	173.65	Chrome	3
	• overall height: 8.13"	7825SRS ●	266.40	Spot Resist Stainless	3
	• connection size: 3/8"	7825ORB	293.40	Oil Rubbed Bronze	3
	<ul style="list-style-type: none"> • connection type: compression • water usage: 1.5 gpm (5.7 L/min) max. • deckplate: included 				
	 DURALAST ®				

Deck Extension kits available on page 400.
Bar/Prep faucets available. See page 51 to 55.

WANT TO ADD WATER FILTRATION OR A SOAP DISPENSER IN THE KITCHEN? SEE pages 57 -60.











NOTES

- Spot Resist Stainless Finish **SPOT RESIST**
- POWERCLEAN** Power Clean™ Technology
- reflex** Self-Retracting Spray Hose
- DURALOCK** Duralock® Quick Connections
- DURALAST** Duralast® Cartridge
- ◆ Also available in bulk pack. See page 435.

KITCHEN

Kitchen Faucets

KITCHEN







		MODEL NUMBER	LIST PRICE	FINISH/COLOR	CASE QTY
SLEEK™		ONE-HANDLE PULLDOWN KITCHEN FAUCET - MOTIONSENSE WAVE			
	<ul style="list-style-type: none"> • application: one or three hole • overall height: 15.56" • connection size: 3/8" • connection type: compression • number of functions: two-function • spray type: aerated stream; powerful cleaning rinse • water usage: 1.5 gpm (5.7 L/min) max. • handle mounting: right only • hose length: 68" • deckplate: included 	7864EWC	467.90	Chrome	3
		7864EWSRS ●	496.00	Spot Resist Stainless	3
		AC ADAPTERS SOLD SEPARATELY			
		169031	132.55		12
		    			
ONE-HANDLE PULLDOWN KITCHEN FAUCET					
	<ul style="list-style-type: none"> • application: one or three hole • overall height: 15.56" • connection size: 3/8" • connection type: compression • number of functions: two-function • spray type: aerated stream; powerful cleaning rinse • water usage: 1.5 gpm (5.7 L/min) max. • handle mounting: right only • hose length: 68" • deckplate: included 	7864	317.90	Chrome	3
		7864BL	397.40	Matte Black	3
		7864SRS ●	406.90	Spot Resist Stainless	3
		DECKPLATES SOLD SEPARATELY			
	141002	47.95	Chrome	6	
	141002BL	55.05	Matte Black	6	
	141002SRS ●	55.05	Spot Resist Stainless	6	
		   			













Deck Extension kits available on page 400.

Bar/Prep faucets available. See page 51 to 55.

WANT TO ADD WATER FILTRATION OR A SOAP DISPENSER IN THE KITCHEN? SEE pages 57 -60.

NOTES



- Spot Resist Stainless Finish 
-  MotionSense Wave™ Hands-free Kitchen Faucet
-  Power Clean™ Technology
-  Self-Retracting Spray Hose
-  Duralock® Quick Connections
-  Duralast® Cartridge

		MODEL NUMBER	LIST PRICE	FINISH/COLOR	CASE QTY
BELFIELD™ ONE-HANDLE KITCHEN FAUCET					
  <ul style="list-style-type: none"> • application: two or four hole • overall height: 12.22" • connection size: 3/8" • connection type: compression • water usage: 1.5 gpm (5.7 L/min) max. • deckplate: included • side spray: included 	 DURALOCK® DURALAST®	7245C	311.10	Chrome	3
		7245SRS ●	419.95	Spot Resist Stainless	3
		7245ORB	462.05	Oil Rubbed Bronze	3
TWO-HANDLE KITCHEN FAUCET					
  <ul style="list-style-type: none"> • application: one or three hole • overall height: 12.22" • connection size: 3/8" • connection type: compression • water usage: 1.5 gpm (5.7 L/min) max. • deckplate: included 	 DURALAST®	7240C	267.50	Chrome	3
		7240SRS ●	361.30	Spot Resist Stainless	3
		7240ORB	397.40	Oil Rubbed Bronze	3
TWO-HANDLE KITCHEN FAUCET					
 <ul style="list-style-type: none"> • application: four hole • overall height: 9.34" • connection size: 1/2" • connection type: IPS • water usage: 1.5 gpm (5.7 L/min) max. • deckplate: included • side spray: included 	 DURALOCK® DURALAST®	7255C	294.10	Chrome	3
		7255SRS ●	397.10	Spot Resist Stainless	3
		7255ORB	436.80	Oil Rubbed Bronze	3
 <ul style="list-style-type: none"> • application: three hole • overall height: 9.34" • connection size: 1/2" • connection type: IPS • water usage: 1.5 gpm (5.7 L/min) max. • deckplate: included 	 DURALAST®	7250C	252.95	Chrome	3
		7250SRS ●	341.55	Spot Resist Stainless	3
		7250ORB	375.75	Oil Rubbed Bronze	3
INTEGRA® ONE-HANDLE PULLOUT KITCHEN FAUCET					
  <ul style="list-style-type: none"> • application: one or three hole • overall height: 10.63" • connection size: 3/8" • connection type: compression • number of functions: two-function • spray type: powerful cleaning rinse; aerated stream • water usage: 1.5 gpm (5.7 L/min) max. • hose length: 59" • deckplate: included 	 POWERCLEAN® DURALOCK® DURALAST®	67315C ◆	239.05	Chrome	6
		67315SRS ●◆	337.90	Spot Resist Stainless	6

Deck Extension kits available on page 400.
 Bar/Prep faucets available. See page 51 to 55.













WANT TO ADD WATER FILTRATION OR A SOAP DISPENSER IN THE KITCHEN? SEE pages 57 -60.

NOTES

- Spot Resist Stainless Finish 
-  Power Clean™ Technology
- DURALOCK Duralock® Quick Connections
- DURALAST Duralast® Cartridge
- ◆ Also available in bulk pack. See page 435.

Kitchen Faucets







KITCHEN

		MODEL NUMBER	LIST PRICE	FINISH/COLOR	CASE QTY
METHOD™ ONE-HANDLE PULLOUT KITCHEN FAUCET					
	<ul style="list-style-type: none"> • application: one or three hole • overall height: 9.04" • connection size: 3/8" • connection type: compression • number of functions: two-function • spray type: powerful cleaning rinse; aerated stream • water usage: 1.5 gpm (5.7 L/min) max. • hose length: 68" • deckplate: included 	7585C	194.50	Chrome	3
		7585SRS ●	262.90	Spot Resist Stainless	3
 POWER CLEAN™ DURALOCK® DURALAST®					
CHATEAU® ONE-HANDLE KITCHEN FAUCET					
	<ul style="list-style-type: none"> • application: four hole • overall height: 8.50" • connection size: 3/8" • connection type: compression • water usage: 1.5 gpm (5.7 L/min) max. • side spray: included 	7430 ◆	166.80	Chrome	6
		7430SRS ●	192.55	Spot Resist Stainless	6
 DURALOCK® DURALAST®					
	<ul style="list-style-type: none"> • application: three hole • overall height: 8.50" • connection size: 3/8" • connection type: compression • water usage: 1.5 gpm (5.7 L/min) max. • side spray: included 	7434 ◆	166.80	Chrome	6
		 DURALOCK® DURALAST®			
	<ul style="list-style-type: none"> • application: two hole • overall height: 8.94" • connection size: 3/8" • connection type: compression • water usage: 1.5 gpm (5.7 L/min) max. • side spray: included 	7437	170.35	Chrome	6
		 DURALOCK® DURALAST®			
	<ul style="list-style-type: none"> • application: one hole • overall height: 8.94" • connection size: 3/8" • connection type: compression • water usage: 1.5 gpm (5.7 L/min) max. 	7423	135.20	Chrome	6
		 DURALAST®			
	<ul style="list-style-type: none"> • application: three hole • overall height: 8.50" • connection size: 3/8" • connection type: compression • water usage: 1.5 gpm (5.7 L/min) max. 	7425 ◆	132.55	Chrome	6
		7425SRS ●	153.00	Spot Resist Stainless	6
 DURALAST®					

NOTES

- Spot Resist Stainless Finish 
- POWER CLEAN™** Power Clean™ Technology
- DURALOCK** Duralock® Quick Connections
- DURALAST** Duralast® Cartridge
- ◆ Also available in bulk pack. See page 435..

Kitchen Faucets

		MODEL NUMBER	LIST PRICE	FINISH/COLOR	CASE QTY
CHATEAU®	TWO-HANDLE KITCHEN FAUCET				
	<ul style="list-style-type: none"> • application: four hole • overall height: 6.50" • connection size: 1/2" • connection type: IPS • water usage: 1.5 gpm (5.7 L/min) max. • side spray: included 	7907	158.35	Chrome	6
	 DURALOCK®				
	<ul style="list-style-type: none"> • application: three hole • overall height: 6.50" • connection size: 1/2" • connection type: IPS • water usage: 1.5 gpm (5.7 L/min) max. 	7906	125.80	Chrome	6
					
	<ul style="list-style-type: none"> • application: four hole • overall height: 6.50" • connection size: 1/2" • connection type: IPS • water usage: 1.5 gpm (5.7 L/min) max. • side spray: included 	7910 ♦	126.50	Chrome	12
	DURALOCK®				
	<ul style="list-style-type: none"> • application: three hole • overall height: 6.50" • connection size: 1/2" • connection type: IPS • water usage: 1.5 gpm (5.7 L/min) max. 	7900 ♦	98.90	Chrome	12

KITCHEN

Deck Extension kits available on page 400.







Bar/Prep faucets available. See page 51 to 55.

WANT TO ADD WATER FILTRATION OR A SOAP DISPENSER IN THE KITCHEN? SEE pages 57 -60.

NOTES

DURALOCK® Duralock® Quick Connection
 ♦ Also available in bulk pack. See page 435.

Kitchen Faucets

		MODEL NUMBER	LIST PRICE	FINISH/COLOR	CASE QTY
	<ul style="list-style-type: none"> • application: one to three hole • overall height: 9.00" • connection size: 3/8" • connection type: compression • water usage: 1.5 gpm (5.7 L/min) max. 	7081	127.70	Chrome	3
		7081SRS ●	165.75	Spot Resist Stainless	3
	<ul style="list-style-type: none"> • application: two or four hole • overall height: 9.00" • connection size: 3/8" • connection type: compression • water usage: 1.5 gpm (5.7 L/min) max. • side spray: included 	7082	160.70	Chrome	3
		7082SRS ●	208.60	Spot Resist Stainless	3
	<ul style="list-style-type: none"> • application: three hole • overall height: 9.00" • connection size: 3/8" • connection type: compression • water usage: 1.5 gpm (5.7 L/min) max. • side spray: included 	7083	160.70	Chrome	3
		7083SRS ●	208.60	Spot Resist Stainless	3
	<ul style="list-style-type: none"> • application: three hole • overall height: 7.50" • connection size: 3/8" • connection type: compression • water usage: 1.5 gpm (5.7 L/min) max. 	7050	99.55	Chrome	3
		7050SRS ●	121.15	Spot Resist Stainless	3
	<ul style="list-style-type: none"> • application: four hole • overall height: 7.50" • connection size: 3/8" • connection type: compression • water usage: 1.5 gpm (5.7 L/min) max. • side spray: included 	7051	109.00	Chrome	3
		7051SRS ●	127.65	Spot Resist Stainless	3
	<ul style="list-style-type: none"> • application: three hole • overall height: 7.50" • connection size: 3/8" • connection type: compression • water usage: 1.5 gpm (5.7 L/min) max. • side spray: included 	7052	109.00	Chrome	3
		7052SRS ●	127.65	Spot Resist Stainless	3

NOTES

- Spot Resist Stainless Finish 
- DURALOCK Duralock® Quick Connections
- DURALAST Duralast® Cartridge

Kitchen Compliments

Kitchen Compliments is about creating a kitchen without compromise. Moen offers exceptional products that deliver all the style and functionality required for a dream kitchen — now with the convenience of getting it all from one, trusted brand. That means guaranteed style compatibility, guaranteed quality and guaranteed satisfaction.

Bundling creates excellent opportunities to cross-sell coordinating products.



You Can Offer Your Customers



Our expanded line of stainless steel sinks are complemented by rinse baskets, cutting boards and other sink accessories.



New soap dispenser designs coordinate with traditional, transitional and modern style options to coordinate with décor.



Sip™ Beverage Faucets provide clean, filtered water at the kitchen sink or a separate beverage sink while hiding the filter under the cabinet.



Moen bar faucets, pot fillers and filtering faucets are guaranteed to match our kitchen faucets in finishes, performance and quality.

The Quick-Connect Wiring System from Moen easily and seamlessly coordinates stylish lighting from the 90™ and Voss™ collections with our kitchen and bath collections. Additional Moen lighting collections include: Brantford®, Eva™, Iso™, Rothbury™ and Waterhill®.



Our towel bars, towel rings, hooks, knobs, pulls and other accessories create consistent style throughout the kitchen.

Modern
Traditional

Premium Pot Fillers

The pot filler is the ultimate epicurean luxury, with all the details needed to ensure convenient flow control over a cooktop. They are available in traditional and modern styles to coordinate with any décor preference.



		MODEL NUMBER	LIST PRICE	FINISH/COLOR	CASE QTY
	MODERN POT FILLER TWO-HANDLE KITCHEN FAUCET <ul style="list-style-type: none"> • application: one hole • spout reach: 24.00" • connection size: 1/2" • connection type: IPS • spray type: aerated stream • water usage: 5.5 gpm (21 L/min) max. 	PREMIUM			
		S665	755.15	Chrome	3
		S665SRS ●	1037.65	Spot Resist Stainless	3
	TRADITIONAL POT FILLER TWO-HANDLE KITCHEN FAUCET <ul style="list-style-type: none"> • application: one hole • spout reach: 24.00" • connection size: 1/2" • connection type: IPS • spray type: aerated stream • water usage: 5.5 gpm (21 L/min) max. 	PREMIUM			
		S664	755.15	Chrome	3
		S664SRS ●	1037.65	Spot Resist Stainless	3
		S664ORB	1141.35	Oil Rubbed Bronze	3

NOTES

- Spot Resist Stainless Finish 

Deck Extension kits available on page 400.

WANT TO ADD WATER FILTRATION OR A SOAP DISPENSER IN THE KITCHEN? SEE pages 57 -60.

Premium Bar/Prep Faucets

All Polished Nickel faucet components feature the LifeShine® Non-Tarnish Finish.

Etch®
Weymouth®
STō®
90°™

Premium Bar/Prep Kitchen Faucets

Perfect for secondary sinks, bar/prep kitchen faucets combine design and functionality. Available in array of design options, Moen® bar/prep kitchen faucets match perfectly with almost any decorating style.



KITCHEN

	MODEL NUMBER	LIST PRICE	FINISH/COLOR	CASE QTY
--	--------------	------------	--------------	----------

ETCH® ONE-HANDLE PULLDOWN BAR FAUCET



- application: one hole
- overall height: 15.50"
- connection size: 3/8"
- connection type: compression
- number of functions: two-function
- spray type: powerful cleaning rinse; aerated stream
- water usage: 1.5 gpm (5.7 L/min) max.
- handle mounting: right only
- hose length: 68"

PREMIUM			
S62608	484.55	Chrome	3
S62608SRS ●	629.85	Spot Resist Stainless	3

POWERCLEAN reflex **DURALOCK** **DURALAST**

WEYMOUTH® ONE-HANDLE BAR FAUCET



- application: one hole
- overall height: 7.81"
- connection size: 3/8"
- connection type: compression
- spray type: aerated stream
- water usage: 1.5 gpm (5.7 L/min) max.
- handle mounting: right only

PREMIUM			
S62101	456.40	Chrome	3
S62101NL	684.70	Polished Nickel	3
S62101SRS ●	716.65	Spot Resist Stainless	3
S62101ORB	781.95	Oil Rubbed Bronze	3

DURALAST

NOTES





- Spot Resist Stainless Finish
- reflex Self-Retracting Spray Hose
- POWERCLEAN** Power Clean™ Technology
- DURALOCK** Duralock® Quick Connections
- DURALAST** Duralast® Cartridge

Deck Extension kits available on page 400.

WANT TO ADD WATER FILTRATION OR A SOAP DISPENSER IN THE KITCHEN? SEE pages 57 -60.

Premium Bar/Prep Faucets

KITCHEN

		MODEL NUMBER	LIST PRICE	FINISH/COLOR	CASE QTY
	STO® ONE-HANDLE PULLDOWN BAR FAUCET				
	<ul style="list-style-type: none"> • application: one hole • overall height: 14.63" • connection size: 3/8" • connection type: compression • number of functions: two-function • spray type: aerated stream; powerful cleaning rinse • water usage: 1.5 gpm (5.7 L/min) max. • handle mounting: right only • hose length: 68" 	PREMIUM			
		S62308	426.15	Chrome	3
		S62308BL	532.60	Matte Black	3
		S62308SRS ●	561.15	Spot Resist Stainless	3
	 POWERCLEAN® reflex	DURALOCK® DURALAST®			
	90 DEGREE™ ONE-HANDLE BAR FAUCET				
	<ul style="list-style-type: none"> • application: one hole • overall height: 11.00" • connection size: 3/8" • connection type: compression • spray type: aerated stream • water usage: 1.5 gpm (5.7 L/min) max. • handle mounting: left or right 	PREMIUM			
		S5170	421.75	Chrome	3
			S5170SRS ●	527.15	Spot Resist Stainless
	 DURALAST®				

NOTES

Deck Extension kits available on page 400.

WANT TO ADD WATER FILTRATION OR A SOAP DISPENSER IN THE KITCHEN? SEE pages 57 -60.

- Spot Resist Stainless Finish 
- reflex Self-Retracting Spray Hose
- POWERCLEAN** Power Clean™ Technology
- DURALOCK** Duralock® Quick Connections
- DURALAST** Duralast® Cartridge

- Woodmere®
- Notch®
- Align®
- Brantford®
- Arbor®
- Camerist®
- Chateau®

Bar/Prep Kitchen Faucets

Combining performance and reliability, Moen® bar/prep faucets are tailored to perfection. Available in your choice of unique design options, these functional collections are sure to create a truly polished look.



KITCHEN

		MODEL NUMBER	LIST PRICE	FINISH/COLOR	CASE QTY
WOODMERE® ONE-HANDLE PULLDOWN BAR FAUCET					
	<ul style="list-style-type: none"> • application: one hole • overall height: 13.25" • connection size: 3/8" • connection type: compression • number of functions: two-function • spray type: aerated stream; powerful cleaning rinse • water usage: 1.5 gpm (5.7 L/min) max. • handle mounting: right only • hose length: 68" 	6615SRS ●	516.60	Spot Resist Stainless	3
	 POWERCLEAN reflex DURALOCK® DURALAST®				
NOTCH® ONE-HANDLE PULLDOWN BAR FAUCET					
	<ul style="list-style-type: none"> • application: one or three hole • overall height: 14.52" • connection size: 3/8" • connection type: compression • number of functions: two-function • spray type: powerful cleaning rinse; aerated stream • water usage: 1.5 gpm (5.7 L/min) max. • handle mounting: right only • hose length: 68" 	6124C	382.90	Chrome	3
		6124SRS ●	488.35	Spot Resist Stainless	3
		6124ORB	537.25	Oil Rubbed Bronze	3
		DECKPLATES SOLD SEPARATELY			
		157328	42.90	Chrome	6
	157328SRS ●	49.35	Spot Resist Stainless	6	
	157328ORB	54.30	Oil Rubbed Bronze	6	
 POWERCLEAN reflex DURALOCK® DURALAST®					











Deck Extension kits available on page 400.

WANT TO ADD WATER FILTRATION OR A SOAP DISPENSER IN THE KITCHEN? SEE pages 57 -60.



NOTES

- Spot Resist Stainless Finish 
- POWERCLEAN** Power Clean™ Technology
- reflex** Self-Retracting Spray Hose
- DURALOCK** Duralock® Quick Connections
- DURALAST** Duralast® Cartridge

Bar/Prep Faucets





		MODEL NUMBER	LIST PRICE	FINISH/COLOR	CASE QTY			
 	ALIGN® ONE-HANDLE PULLDOWN BAR FAUCET	<ul style="list-style-type: none"> • application: one or three hole • overall height: 13.75" • connection size: 3/8" • connection type: compression • number of functions: two-function • spray type: aerated stream; powerful cleaning rinse • water usage: 1.5 gpm (5.7 L/min) max. • handle mounting: right only • hose length: 68" 	5965	352.75	Chrome	3		
			5965BL	441.00	Matte Black	3		
			5965SRS ●	454.00	Spot Resist Stainless	3		
		DECKPLATES SOLD SEPARATELY						
		141002	47.95	Chrome	6			
		141002BL	55.05	Matte Black	6			
		141002SRS ●	55.05	Spot Resist Stainless	6			
		 POWER CLEAN™ reflex DURALOCK® DURALAST®						
		 	BRANTFORD® ONE-HANDLE PULLDOWN BAR FAUCET	<ul style="list-style-type: none"> • application: one or three hole • overall height: 14.38" • connection size: 3/8" • connection type: compression • number of functions: two-function • spray type: powerful cleaning rinse; aerated stream • water usage: 1.5 gpm (5.7 L/min) max. • handle mounting: right only • hose length: 68" 	5985	341.25	Chrome	3
					5985SRS ●	437.30	Spot Resist Stainless	3
5985ORB	470.85				Oil Rubbed Bronze	3		
DECKPLATES SOLD SEPARATELY								
141002	47.95			Chrome	6			
141002SRS ●	55.05			Spot Resist Stainless	6			
141002ORB	60.65			Oil Rubbed Bronze	6			
 POWER CLEAN™ reflex DURALOCK® DURALAST®								
 	ARBOR® ONE-HANDLE PULLDOWN BAR FAUCET			<ul style="list-style-type: none"> • application: one or three hole • overall height: 14.38" • connection size: 3/8" • connection type: compression • number of functions: two-function • spray type: aerated stream; powerful cleaning rinse • water usage: 1.5 gpm (5.7 L/min) max. • handle mounting: right only • hose length: 68" 	5995	321.85	Chrome	3
					5995BL	402.30	Matte Black	3
		5995SRS ●	412.30		Spot Resist Stainless	3		
		5995ORB	431.30	Oil Rubbed Bronze	3			
		DECKPLATES SOLD SEPARATELY						
		141002	47.95	Chrome	6			
		141002BL	55.05	Matte Black	6			
		141002SRS ●	55.05	Spot Resist Stainless	6			
		141002ORB	60.65	Oil Rubbed Bronze	6			
		 POWER CLEAN™ reflex DURALOCK® DURALAST®						
	CAMERIST® ONE-HANDLE BAR FAUCET	<ul style="list-style-type: none"> • application: two hole • overall height: 11.00" • connection size: 3/8" • connection type: compression • spray type: aerated stream • water usage: 1.5 gpm (5.7 L/min) max. 	4905	203.55	Chrome	3		
			4905SRS ●	273.70	Spot Resist Stainless	3		
			4905ORB	293.40	Oil Rubbed Bronze	3		
		 DURALOCK® DURALAST®						

NOTES

- Spot Resist Stainless Finish 
-  Power Clean™ Technology
-  Self-Retracting Spray Hose
-  Duralock® Quick Connections
-  Duralast® Cartridge

Deck Extension kits available on page 400.

WANT TO ADD WATER FILTRATION OR A SOAP DISPENSER IN THE KITCHEN? SEE pages 57 -60.

		MODEL NUMBER	LIST PRICE	FINISH/COLOR	CASE QTY
CHATEAU® ONE-HANDLE BAR FAUCET					
	<ul style="list-style-type: none"> • application: two hole • overall height: 10.50" • connection size: 3/8" • connection type: compression • spray type: aerated stream • water usage: 1.5 gpm (5.7 L/min) max. 	4904	178.65	Chrome	3
		4904SRS ●	215.60	Spot Resist Stainless	3
	 DURALOCK® DURALAST®				
TWO-HANDLE BAR FAUCET					
	<ul style="list-style-type: none"> • application: two hole • overall height: 10.50" • connection size: 1/2" • connection type: IPS • spray type: aerated stream • water usage: 1.5 gpm (5.7 L/min) max. 	4903	97.95	Chrome	12
					

KITCHEN

Deck Extension kits available on page 400.

WANT TO ADD WATER FILTRATION OR A SOAP DISPENSER IN THE KITCHEN? SEE pages 57 -60.

NOTES

DURALOCK® Duralock® Quick Connection
DURALAST® Duralast® Cartridge







Integra®

Chateau®



Laundry Faucets

Moen® laundry faucets bring performance, versatility and reliability to work areas with a simple, understated appeal. They are available in traditional and modern styles to coordinate with any décor preference.



		MODEL NUMBER	LIST PRICE	FINISH/COLOR	CASE QTY
INTEGRA®   <ul style="list-style-type: none"> • application: one or three hole • overall height: 10.63" • connection size: 3/8" • connection type: compression • number of functions: two-function • spray type: powerful cleaning rinse; aerated stream • water usage: 1.5 gpm (5.7 L/min) max. • hose length: 59" • deckplate: included  POWER CLEAN™ DURALOCK® DURALAST®	ONE-HANDLE PULLOUT LAUNDRY FAUCET				
		67315C ◆	239.05	Chrome	6
		67315SRS ●◆	337.90	Spot Resist Stainless	6
CHATEAU®  <ul style="list-style-type: none"> • application: two hole • overall height: 6.63" • connection size: 1/2" • connection type: IPS • spray type: aerated stream • water usage: unrestricted 	TWO-HANDLE LAUNDRY FAUCET				
		4975	99.85	Chrome	12
 <ul style="list-style-type: none"> • application: two hole • overall height: 6.63" • connection size: 1/2" • connection type: IPS • spray type: aerated stream • water usage: unrestricted 					
	74998	75.10	Chrome	12	

NOTES

- Spot Resist Stainless Finish 
-  Power Clean™ Technology
- DURALOCK** Duralock® Quick Connections
- DURALAST** Duralast® Cartridge
- ◆ Also available in bulk pack. See page 435.

Deck Extension kits available on page 400.

WANT TO ADD A SOAP DISPENSER IN THE KITCHEN? SEE pages 59 - 60.

Premium Beverage and Filtering Faucets







- Modern
- Traditional
- Transitional

Premium Beverage and Filtering Kitchen Faucets

Having a cold water tap at your kitchen sink is easy and stylish with SIP™ beverage faucets. SIP™ styles feature a high arc rotating spout that provides more convenience at the sink. They are available in coordinating styles for every decorating taste: traditional, transitional or modern.



KITCHEN

		MODEL NUMBER	LIST PRICE	FINISH/COLOR	CASE QTY
	SIP™ MODERN ONE-HANDLE BEVERAGE/FILTRATION FAUCET <ul style="list-style-type: none"> • overall height: 10.88" • water usage: 1.5 gpm (5.7 L/min) max. • S5500: filtration sold separately 	PREMIUM			
		S5530	282.80	Chrome	3
		S5530SRS ●	395.90	Spot Resist Stainless	3
		FILTRATION SOLD SEPARATELY			
	S5500	244.70		6	
	 DURALAST®				
	SIP™ TRADITIONAL ONE-HANDLE BEVERAGE/FILTRATION FAUCET <ul style="list-style-type: none"> • overall height: 10.88" • water usage: 1.5 gpm (5.7 L/min) max. • S5500: filtration sold separately 	PREMIUM			
		S5510	282.80	Chrome	3
		S5510SRS ●	395.90	Spot Resist Stainless	3
		S5510ORB	435.10	Oil Rubbed Bronze	3
	FILTRATION SOLD SEPARATELY				
	S5500	244.70		6	
	 DURALAST®				
	SIP™ TRANSITIONAL ONE-HANDLE BEVERAGE/FILTRATION FAUCET <ul style="list-style-type: none"> • overall height: 10.88" • water usage: 1.5 gpm (5.7 L/min) max. • S5500: filtration sold separately 	PREMIUM			
		S5520	282.80	Chrome	3
		S5520SRS ●	395.90	Spot Resist Stainless	3
		S5520ORB	435.10	Oil Rubbed Bronze	3
	FILTRATION SOLD SEPARATELY				
	S5500	244.70		6	
	 DURALAST®				





Bar/Prep faucets available. See pages 51-55.

NOTES

- Spot Resist Stainless Finish 
- DURALAST®** Duralast® Cartridge

Premium Beverage and Filtering Faucets

KITCHEN

		MODEL NUMBER	LIST PRICE	FINISH/COLOR	CASE QTY
FILTRATION SYSTEM					
	<ul style="list-style-type: none"> • water usage: 0.7 gpm (2.7 L/min) max. • filter: included • application: undercounter • system: dry change • battery: included • use with: S5510, S5520 and S5530 series 	PREMIUM S5500	244.70		6
FILTRATION SYSTEM					
	<ul style="list-style-type: none"> • use with: 77100 series 	9001	97.15		6
FILTRATION SYSTEM					
	<ul style="list-style-type: none"> • includes: replacement battery • use with: F7400, 77200, S5510, S5520, and S5530 series 	9601	54.95		18
	<ul style="list-style-type: none"> • use with: PureTouch® classic series 	601	36.55		12

Premium Soap/Lotion Dispensers





- Modern**
- Traditional**
- Transitional**

Premium Soap/Lotion Dispensers

Accessorize your kitchen with stylish soap/lotion dispensers from Moen. They are available in coordinating styles for every decorating taste: traditional, transitional or modern. All come with tops that lift off for easy refill.







KITCHEN

		MODEL NUMBER	LIST PRICE	FINISH/COLOR	CASE QTY
MODERN SOAP/LOTION DISPENSER					
 <ul style="list-style-type: none"> • overall height: 5.00" • spout reach: 3.50" • max deck thickness: 3-1/2" • bottle size: 18 ounce refillable bottle • hole diameter: 1-1/8" hole 		PREMIUM			
		S3947C	138.15	Chrome	6
		S3947SRS ●	165.85	Spot Resist Stainless	6
TRADITIONAL SOAP/LOTION DISPENSER					
 <ul style="list-style-type: none"> • overall height: 5.00" • spout reach: 3.50" • max deck thickness: 3-1/2" • bottle size: 18 ounce refillable bottle • hole diameter: 1-1/8" hole 		PREMIUM			
		S3945C	138.15	Chrome	6
		S3945SRS ●	165.85	Spot Resist Stainless	6
	S3945ORB	172.65	Oil Rubbed Bronze	6	
TRANSITIONAL SOAP/LOTION DISPENSER					
 <ul style="list-style-type: none"> • overall height: 5.00" • spout reach: 3.50" • max deck thickness: 3-1/2" • bottle size: 18 ounce refillable bottle • hole diameter: 1-1/8" hole 		PREMIUM			
		S3946C	138.15	Chrome	6
		S3946SRS ●	165.85	Spot Resist Stainless	6
	S3946ORB	172.65	Oil Rubbed Bronze	6	
	S3946BL	172.70	Matte Black	6	
 <ul style="list-style-type: none"> • overall height: 5.00" • spout reach: 3.50" • max deck thickness: 3-1/2" • bottle size: 18 ounce refillable bottle • hole diameter: 1-1/8" hole 		PREMIUM			
		S3948C	138.15	Chrome	6
		S3948SRS ●	165.85	Spot Resist Stainless	6
	S3948ORB	172.65	Oil Rubbed Bronze	6	

NOTES

- Spot Resist Stainless Finish 

Soap/Lotion Dispensers, Air Gaps, Hose Management

		MODEL NUMBER	LIST PRICE	FINISH/COLOR	CASE QTY
TRANSITIONAL SOAP/LOTION DISPENSER					
	• overall height: 3.13"	3942	46.80	Chrome	6
	• spout reach: 2.75"	3942BL	58.50	Matte Black	6
	• max deck thickness: 2-1/4"	3942W	58.50	Glacier	6
	• bottle size: 18 ounce refillable bottle	3942SRS ●	63.05	Spot Resist Stainless	6
	• overall height: 2.56"	3944	45.85	Chrome	6
	• spout reach: 3.63"	3944SRS ●	63.05	Spot Resist Stainless	6
	• max deck thickness: 2-1/4"	3944ORB	69.80	Oil Rubbed Bronze	6
	• application: one hole	105895	23.10	Chrome	6
	• hole diameter: one 1 3/8"	105895BL	30.40	Matte Black	6
		105895SRS ●	31.10	Spot Resist Stainless	6
		105895CSL	31.40	Classic Stainless	6
		105895ORB	32.50	Oil Rubbed Bronze	6
PULLOUT/PULLDOWN MANAGEMENT SYSTEM					
	• system: helps prevent hose/weight getting caught under sink	159060	18.80	N/A or Unfinished	6
	• size: can be cut to accommodate different cabinet sizes				
	• compatible with: Moen kitchen pulldowns and pullout single mount skus (excluding Aberdeen™)				

NOTES

WANT TO ADD WATER FILTRATION
IN THE KITCHEN? SEE pages 57 - 58.

● Spot Resist Stainless Finish





SINKS

Sinks

Stainless Steel Sinks and Custom Sink Accessories

1800 Series 30" x 21" Stainless Steel 18 Gauge Double Bowl Sink / G18220
Weymouth® One-Handle High Arc Kitchen Faucet / S72101

Please see [moen.com/consumer-support/warranty](https://www.moen.com/consumer-support/warranty)
for complete product warranty information.

Moen® Stainless Steel Sinks

1600™ Professional Series

Constructed from premium, durable 16-gauge stainless steel, each sink in the 1600™ Professional Series is built to withstand your toughest chores, creative cooking whims and heaviest pots and pans. Exceptional sound-deadening and wear-resistant uniform brushed finish – backed by a limited lifetime warranty – assure the functionality and beauty last.

1800™ Series

High quality construction and extensive selection come together in our 1800™ Series. Strong 18-gauge stainless steel serves as a solid base for a wide array of design options. Exceptional sound-deadening and wear-resistant uniform brushed finish – backed by a limited lifetime warranty – assure the functionality and beauty last.

2000™ Series

The 2000™ Series delivers design and functionality at a value. A variety of configurations and mounting options in quality 20-gauge stainless steel give you choices that fit almost any countertop material – backed by a limited lifetime warranty.

2200™ Series

The 2200™ Series offers 22-gauge stainless steel construction that provides sturdy functionality and most commonly used configurations – backed by a limited lifetime warranty.

SoundSHIELD™

SoundSHIELD™ is a sound-deadening system that offers exceptional noise reduction and quiet dependability.

QuickMount™

QuickMount™ makes installing a Moen drop-in sink faster and easier than ever. The innovative design allows less work under the sink, reduces time spent per install and improves installation flexibility.

SINKS

GUIDELINES FOR ORDERING

The following guidelines will assist you when ordering sinks.

	Description	Gauge	Undermount Options	Drop-In Options	Bar/Prep Options	Bowl Depth	SoundSHIELD™	Warranty†
1600™ Professional Series	Professional	16	✓		✓	10"	✓	Limited Lifetime
1800™ Series	High Quality, Extensive Selection	18	✓	✓	✓	Up to 10"	✓	Limited Lifetime
2000™ Series	Design + Functionality	20	✓	✓	✓	Up to 8"	✓	Limited Lifetime
2200™ Series	Sturdy Value	22		✓	✓	Up to 8"	✓	Limited Lifetime

SKU Number Key

	G	A	1	8	2	3	3	4		
Packaging	Sink	Accessory	Gauge	#Bowls	Random- numeric	# Holes	Any combo from below			
No Entry	Single/STD		16 Gauge	1	Single	0	None	No Entry	3.5" Drain	Drain Size
P	Pallet		18 Gauge	2	Double	1	1 Hole	2	2" Drain	
T	To go- with faucets only		20 Gauge	4	Bar	2	2 Holes	No Entry	Center Drain	Drain Placement
K	Kit- with access		22 Gauge			3	3 Holes	B	Rear Position	
						4	4 Holes	L	Left Rear Position	
								R	Right Rear Position	
								Q	Quickmount Installation Hardware	

† For complete product warranty information see moen.com/consumer-support/warranty









All stainless steel sinks feature SoundSHIELD™, a sound-deadening system that offers exceptional noise reduction and quiet dependability.

1600™ Professional Series Sinks

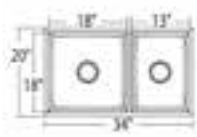
Constructed from premium, durable 16-gauge stainless steel, the 1600™ Professional Series is built to withstand your toughest chores.

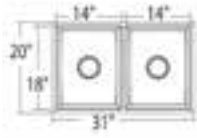
- 16 gauge
- brushed stainless steel finish
- includes mounting brackets
- includes cut-out template where applicable

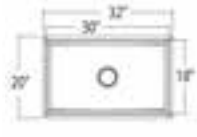

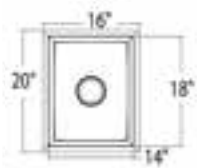
		MODEL NUMBER	DESCRIPTION	LIST PRICE	
1600 SERIES PROFESSIONAL STYLE DOUBLE OFFSET BOWL UNDERMOUNT SINK					
 <ul style="list-style-type: none"> • drain opening size: 3-5/8" • depth size: 10" • minimum cabinet size: 39" • reversible bowl: yes • drain location: center • weight: 41.25 		G16221	double bowl sink	2041.10	
		ACCESSORIES			
		22538	cut-out template	15.80	
		GA768	bottom grid	148.45	
1600 SERIES PROFESSIONAL STYLE DOUBLE EQUAL BOWL UNDERMOUNT SINK					
 <ul style="list-style-type: none"> • drain opening size: 3-5/8" • depth size: 10" • minimum cabinet size: 36" • drain location: center • weight: 39.90 		G16200	double bowl sink	1961.15	
		ACCESSORIES			
		22537	cut-out template	16.40	
		GA763	bottom grid	125.80	
1600 SERIES PROFESSIONAL STYLE SINGLE BOWL UNDERMOUNT SINK					
 <ul style="list-style-type: none"> • drain opening size: 3-5/8" • depth size: 10" • minimum cabinet size: 36" • drain location: center • weight: 35.20 		G16100	single bowl sink	1809.85	
		ACCESSORIES			
		22539	cut-out template	16.40	
		GA760	bottom grid	170.15	
1600 SERIES PROFESSIONAL STYLE BAR/PREP SINK					
 <ul style="list-style-type: none"> • drain opening size: 3-5/8" • depth size: 10" • minimum cabinet size: 24" • drain location: center • weight: 21.85 		G16430	single bowl sink	1070.30	
		ACCESSORIES			
		22540	cut-out template	15.80	
		GA763	bottom grid	125.80	

SINKS



All stainless steel sinks feature SoundSHIELD™, a sound-deadening system that offers exceptional noise reduction and quiet dependability.

1800™ Series Sinks

Constructed with strong, high quality 18-gauge steel, the 1800™ Series provides a solid base for a wide array of design options.











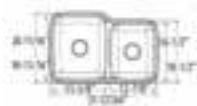

- 18 gauge
- brushed stainless steel finish
- includes mounting brackets
- includes cut-out template where applicable

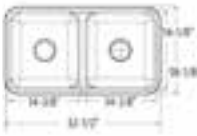

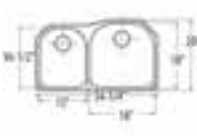
SINKS

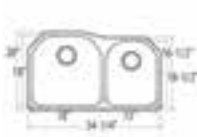
		MODEL NUMBER	DESCRIPTION	LIST PRICE
1800 SERIES PROFESSIONAL STYLE DOUBLE OFFSET BOWL UNDERMOUNT SINK				
	<ul style="list-style-type: none"> • drain opening size: 3-5/8" • depth size: 8-1/2" • minimum cabinet size: 36" • drain location: rear center • weight: 30.51 		G18287 double bowl sink	747.10
			ACCESSORIES	
			22517 cut-out template	16.40
			GA782B bottom grid - right bowl	125.80
			GA785B bottom grid - left bowl	137.25
			GA922 cutting board	111.65
1800 SERIES PROFESSIONAL STYLE DOUBLE EQUAL BOWL UNDERMOUNT SINK				
	<ul style="list-style-type: none"> • drain opening size: 3-5/8" • depth size: 8-1/2" • minimum cabinet size: 33" • drain location: rear center • weight: 28.20 		G18288 double bowl sink	694.70
			ACCESSORIES	
			22518 cut-out template	16.40
			GA782B bottom grid	125.80
			GA922 cutting board	111.65
1800 SERIES PROFESSIONAL STYLE SINGLE BOWL UNDERMOUNT SINK				
	<ul style="list-style-type: none"> • drain opening size: 3-5/8" • depth size: 8-1/2" • minimum cabinet size: 36" • drain location: rear center • weight: 27.35 		G18180 single bowl sink	693.65
			ACCESSORIES	
			22519 cut-out template	16.40
			GA780B bottom grid	166.25
			GA922 cutting board	111.65
	<ul style="list-style-type: none"> • drain opening size: 3-5/8" • depth size: 8-1/2" • minimum cabinet size: 27" • drain location: rear center • weight: 21.00 		G18185 single bowl sink	586.80
			ACCESSORIES	
			22516 cut-out template	16.40
			GA781B bottom grid	148.45
			GA922 cutting board	111.65
1800 SERIES APRON FRONT DOUBLE EQUAL BOWL UNDERMOUNT SINK				
	<ul style="list-style-type: none"> • drain opening size: 3-5/8" • depth size: 9" • minimum cabinet size: 30" • drain location: rear center • weight: 42.20 		G18220 double bowl sink	1048.45
			ACCESSORIES	
			22512 sink template	17.55
			GA772 bottom grid	125.30
			GA922 cutting board	111.65

Drains and accessories sold separately. See pages 78 - 81.

		MODEL NUMBER	DESCRIPTION	LIST PRICE
1800 SERIES APRON FRONT SINGLE BOWL UNDERMOUNT SINK				
 <ul style="list-style-type: none"> • drain opening size: 3-5/8" • depth size: 9" • minimum cabinet size: 30" • drain location: rear center • weight: 38.25 		G18121	single bowl sink	997.80
		ACCESSORIES		
		22512	sink template	17.55
		GA771	bottom grid	163.50
		GA922	cutting board	111.65
1800 SERIES LOW MIDDLE DIVIDE DOUBLE OFFSET BOWL UNDERMOUNT SINK				
 <ul style="list-style-type: none"> • drain opening size: 3-5/8" • depth size: 9" • minimum cabinet size: 36" • drain location: center • weight: 20.30 		G18253	double bowl sink	940.05
		ACCESSORIES		
		22527	template kit	16.40
		GA841	rinse basket	125.30
1800 SERIES LOW MIDDLE DIVIDE DOUBLE EQUAL BOWL UNDERMOUNT SINK				
 <ul style="list-style-type: none"> • drain opening size: 3-5/8" • depth size: 9" • minimum cabinet size: 36" • drain location: center • weight: 19.40 		G18252	double bowl sink	889.95
		ACCESSORIES		
		22526	template kit	16.40
		GA726	bottom grid	70.75
		GA821	rinse basket	92.60
		GA922	cutting board	111.65
1800 SERIES D SHAPE DOUBLE OFFSET BOWL UNDERMOUNT SINK				
 <ul style="list-style-type: none"> • bowl type: D shape • drain opening size: 3-5/8" • depth size: 8", 10" • minimum cabinet size: 36" • drain location: rear center • weight: 21.10 		G18246	double bowl sink	961.70
		ACCESSORIES		
		22523	cut-out template	16.40
		GA746B	bottom grid - left bowl	119.85
		GA748B	bottom grid - right bowl	135.90
		GA841	rinse basket	125.30
		GA944	cutting board	163.20
 <ul style="list-style-type: none"> • bowl type: D shape • drain opening size: 3-5/8" • depth size: 10", 8" • minimum cabinet size: 36" • drain location: rear center • weight: 21.20 		G18264	double bowl sink	961.70
		ACCESSORIES		
		22522	cut-out template	16.40
		GA746B	bottom grid - right bowl	119.85
		GA748B	bottom grid - left bowl	135.90
		GA841	rinse basket	125.30
		GA944	cutting board	163.20
 <ul style="list-style-type: none"> • bowl type: D shape • drain opening size: 3-5/8" • depth size: 6", 10" • minimum cabinet size: 33" • drain location: rear center • weight: 18.70 		G18237	double bowl sink	918.45
		ACCESSORIES		
		22521	cut-out template	16.40
		GA748B	bottom grid	135.90
 <ul style="list-style-type: none"> • bowl type: D shape • drain opening size: 3-5/8" • depth size: 10", 6" • minimum cabinet size: 33" • drain location: rear center • weight: 20.35 		G18273	double bowl sink	918.45
		ACCESSORIES		
		22520	cut-out template	16.40
		GA748B	bottom grid	135.90

Drains and accessories sold separately. See pages 78 - 81.

SINKS









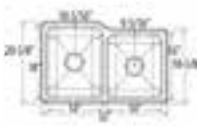

1800™ Series

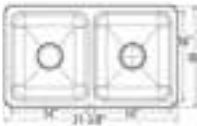
		MODEL NUMBER	DESCRIPTION	LIST PRICE	
1800 SERIES D SHAPE DOUBLE OFFSET BOWL UNDERMOUNT SINK (CONTINUED)					
	<ul style="list-style-type: none"> • bowl type: D shape • drain opening size: 3-5/8" • depth size: 8" • minimum cabinet size: 36" • drain location: rear center • weight: 20.00 		G18265	double bowl sink	649.40
			ACCESSORIES		
			22543	cut-out template	15.80
			GA746B	bottom grid - right bowl	119.85
			GA748B	bottom grid - left bowl	135.90
			GA841	rinse basket	125.30
			GA944	cutting board	163.20
1800 SERIES D SHAPE DOUBLE EQUAL BOWL UNDERMOUNT SINK					
	<ul style="list-style-type: none"> • bowl type: D shape • drain opening size: 3-5/8" • depth size: 10" • minimum cabinet size: 33" • drain location: rear center • weight: 20.40 		G18255	double bowl sink	783.35
			ACCESSORIES		
			22524	cut-out template	15.80
			GA746B	bottom grid	119.85
			GA841	rinse basket	125.30
			GA944	cutting board	163.20
	<ul style="list-style-type: none"> • bowl type: D shape • drain opening size: 3-5/8" • depth size: 7" • minimum cabinet size: 33" • drain location: center drain • weight: 17.55 		G18256	double bowl sink	432.20
			ACCESSORIES		
			22524	cut-out template	15.80
			GA746B	bottom grid	119.85
			GA841	rinse basket	125.30
			GA944	cutting board	163.20
	<ul style="list-style-type: none"> • bowl type: D shape • drain opening size: 3-5/8" • depth size: 6" • minimum cabinet size: 33" • ADA/FHA compliant: yes • drain location: rear center • weight: 20.40 		G18258B	double bowl sink	406.25
			ACCESSORIES		
			22524	cut-out template	15.80
			GA746B	bottom grid	119.85
			ADA/FHA Compliant*		
1800 SERIES D SHAPE SINGLE BOWL UNDERMOUNT SINK					
	<ul style="list-style-type: none"> • bowl type: D shape • drain opening size: 3-5/8" • depth size: 9" • minimum cabinet size: 36" • drain location: rear center • weight: 19.86 		G18165	single bowl sink	929.85
			ACCESSORIES		
			22511	sink template	16.40
			GA749B	bottom grid	152.10
	<ul style="list-style-type: none"> • bowl type: D shape • drain opening size: 3-5/8" • depth size: 7" • minimum cabinet size: 36" • FHA compliant: yes • drain location: rear center • weight: 16.80 		G18163	single bowl sink	716.85
			ACCESSORIES		
			22511	sink template	16.40
			GA749B	bottom grid	152.10
			FHA Compliant**		
	<ul style="list-style-type: none"> • bowl type: D shape • drain opening size: 3-5/8" • depth size: 6" • minimum cabinet size: 36" • ADA/FHA compliant: yes • drain location: rear center • weight: 16.80 		G18161	single bowl sink	673.85
			ACCESSORIES		
			22511	sink template	16.40
			GA749B	bottom grid	152.10
			ADA/FHA Compliant*		
	<ul style="list-style-type: none"> • bowl type: D shape • drain opening size: 3-5/8" • depth size: 8" • minimum cabinet size: 24" • drain location: rear center • weight: 12.92 		G18160	single bowl sink	627.80
			ACCESSORIES		
			22514	sink template	16.40
			GA748B	bottom grid	135.90

Drains and accessories sold separately. See pages 78 - 81.

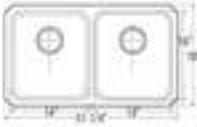
***ADA/FHA Compliant:** Sink compliant to ADA (ICC A117.1) and FHA accessibility specifications when installed to these required standards. See specific product specification sheet for details.

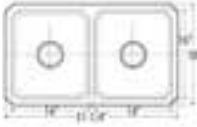
****FHA Compliant:** Sink compliant to FHA accessibility specifications when installed to these required standards. See specific product specification sheet for details.

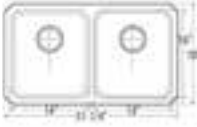
		MODEL NUMBER	DESCRIPTION	LIST PRICE
1800 SERIES DOUBLE OFFSET BOWL UNDERMOUNT SINK				
 <ul style="list-style-type: none"> • drain opening size: 3-5/8" • depth size: 10", 8" • minimum cabinet size: 36" • drain location: center • weight: 21.85 		G18231	double bowl sink	821.20
		ACCESSORIES		
		22509	cut-out template	15.80
		GA726	bottom grid - right bowl	70.75
		GA728	bottom grid - left bowl	95.45
		GA821	rinse basket	92.60
		GA922	cutting board	111.65
1800 SERIES DOUBLE EQUAL BOWL UNDERMOUNT SINK				
 <ul style="list-style-type: none"> • drain opening size: 3-5/8" • depth size: 10", 8" • minimum cabinet size: 36" • reversible bowl: yes • drain location: center • weight: 19.00 		G18242	double bowl sink	826.55
		ACCESSORIES		
		22509	cut-out template	15.80
		GA726	bottom grid	70.75
		GA821	rinse basket	92.60
		GA922	cutting board	111.65
 <ul style="list-style-type: none"> • drain opening size: 3-5/8" • depth size: 9" • minimum cabinet size: 36" • G18212 drain location: center • G18212B drain location: rear center • weight: 20.90 		G18212	double bowl sink	808.25
		ACCESSORIES		
		G18212B	double bowl sink	808.25
		22541	cut-out template	16.40
		GA726	bottom grid - center drain	70.75
		GA821	rinse basket	92.60
		GA922	cutting board	111.65
 <ul style="list-style-type: none"> • drain opening size: 3-5/8" • depth size: 8" • minimum cabinet size: 36" • drain location: center • weight: 18.15 		G18211	double bowl sink	557.40
		ACCESSORIES		
		22541	cut-out template	16.40
		GA726	bottom grid	70.75
		GA821	rinse basket	92.60
		GA922	cutting board	111.65
 <ul style="list-style-type: none"> • drain opening size: 3-5/8" • depth size: 7" • minimum cabinet size: 36" • drain location: center • weight: 18.20 		G18210	double bowl sink	529.50
		ACCESSORIES		
		22541	cut-out template	16.40
		GA726	bottom grid	70.75
		GA821	rinse basket	92.60
		GA922	cutting board	111.65
 <ul style="list-style-type: none"> • drain opening size: 3-5/8" • depth size: 5-1/2" • minimum cabinet size: 36" • ADA/FHA compliant: yes • drain location: rear center • weight: 14.35 		G18215	double bowl sink	304.35
		ACCESSORIES		
		22541	cut-out template	16.40
		GA821	rinse basket	92.60
		GA922	cutting board	111.65









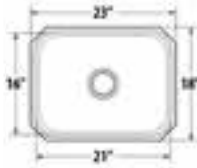

ADA/FHA Compliant*

Drains and accessories sold separately. See pages 78 - 81.

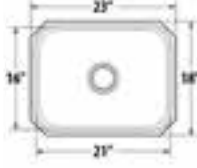
***ADA/FHA** Compliant: Sink compliant to ADA (ICC A117.1) and FHA accessibility specifications when installed to these required standards. See specific product specification sheet for details.

SINKS





1800™ Series

		MODEL NUMBER	DESCRIPTION	LIST PRICE	
1800 SERIES SINGLE BOWL UNDERMOUNT SINK					
 <ul style="list-style-type: none"> • drain opening size: 3-5/8" • depth size: 10" • minimum cabinet size: 36" • drain location: center • weight: 19.95 		G18110	single bowl sink	875.25	
		ACCESSORIES			
		22525	cut-out template	16.40	
		GA719	bottom grid	145.45	
		GA821	rinse basket	92.60	
GA922	cutting board	111.65			
 <ul style="list-style-type: none"> • drain opening size: 3-5/8" • depth size: 10" • minimum cabinet size: 27" • drain location: center • weight: 13.90 		G18190	single bowl sink	582.40	
		ACCESSORIES			
		22507	cut-out template	16.40	
		GA716	bottom grid	100.65	
		GA922	cutting board	111.65	
 <ul style="list-style-type: none"> • drain opening size: 3-5/8" • depth size: 8" • minimum cabinet size: 27" • drain location: center • weight: 13.60 		G18191	single bowl sink	351.15	
		ACCESSORIES			
		22507	cut-out template	16.40	
		GA716	bottom grid	100.65	
		GA922	cutting board	111.65	
 <ul style="list-style-type: none"> • drain opening size: 3-5/8" • depth size: 7" • minimum cabinet size: 27" • G18192 drain location: center • G18192B drain location: rear center • G18192L drain location: rear left • FHA compliant: G18192B and G18192L • weight: 13.75 		G18192	single bowl sink	329.50	
		G18192B	single bowl sink	329.50	
		G18192L	single bowl sink	329.50	
		ACCESSORIES			
		22507	cut-out template	16.40	
GA716	bottom grid - center drain	100.65			
GA922	cutting board	111.65			
FHA Compliant**					
 <ul style="list-style-type: none"> • drain opening size: 3-5/8" • depth size: 5-1/2" • minimum cabinet size: 27" • ADA/FHA compliant: yes • G18195 drain location: rear center • G18195L drain location: rear left • weight: 10.75 		G18195	single bowl sink	307.70	
		G18195L	single bowl sink	307.70	
		ACCESSORIES			
		22507	cut-out template	16.40	
		GA781B	bottom grid - center rear drain	148.45	
GA922	cutting board	111.65			
ADA/FHA Compliant*					
1800 SERIES D SHAPE BAR/PREP UNDERMOUNT SINK					
 <ul style="list-style-type: none"> • bowl type: D shape • drain opening size: 3-5/8" • depth size: 8" • minimum cabinet size: 15" • drain location: rear center • weight: 10.75 		G18461	single bowl sink	426.50	
		ACCESSORIES			
		22514	sink template	16.40	
		GA746B	bottom grid	119.85	
		GA841	rinse basket	125.30	
GA944	cutting board	163.20			

Drains and accessories sold separately. See pages 78 - 81.

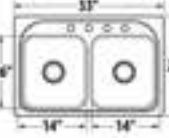

***ADA/FHA Compliant:** Sink compliant to ADA (ICC A117.1) and FHA accessibility specifications when installed to these required standards. See specific product specification sheet for details.

****FHA Compliant:** Sink compliant to FHA accessibility specifications when installed to these required standards. See specific product specification sheet for details.

		MODEL NUMBER	DESCRIPTION	LIST PRICE	
1800 SERIES BAR/PREP UNDERMOUNT SINK					
 <ul style="list-style-type: none"> • drain opening size: 3-5/8" • depth size: 10" • minimum cabinet size: 21" • drain location: center • weight: 10.60 		G18442	single bowl sink	420.35	
		ACCESSORIES			
		22505	cut-out template	16.40	
		GA726	bottom grid	70.75	
		GA821	rinse basket	92.60	
GA922	cutting board	111.65			
 <ul style="list-style-type: none"> • drain opening size: 3-5/8" • depth size: 8" • minimum cabinet size: 24" • drain location: center • weight: 10.50 		G18440	single bowl sink	340.35	
		ACCESSORIES			
		22506	cut-out template	15.80	
		GA728	bottom grid	95.45	
		GA821	rinse basket	92.60	
 <ul style="list-style-type: none"> • drain opening size: 3-5/8" • depth size: 8" • minimum cabinet size: 21" • drain location: center • weight: 13.60 		G18443	single bowl sink	332.30	
		ACCESSORIES			
		22505	cut-out template	16.40	
		GA726	bottom grid	70.75	
		GA821	rinse basket	92.60	
GA922	cutting board	111.65			
 <ul style="list-style-type: none"> • drain opening size: 3-5/8" • depth size: 6" • minimum cabinet size: 15" • drain location: center • weight: 6.00 		G18450	single bowl sink	248.55	
		ACCESSORIES			
		22504	cut-out template	15.80	
1800 SERIES D SHAPE DOUBLE EQUAL BOWL DROP IN SINK					
 <ul style="list-style-type: none"> • bowl type: D shape • drain opening size: 3-5/8" • drop-in with: u channel • QuickMount™ installation hardware: included • depth size: 10" • minimum cabinet size: 36" • drain location: rear center • weight: 22.85 		G182571Q	double bowl one hole sink	775.65	
		G182574Q	double bowl four hole sink	775.65	
		ACCESSORIES			
		GA746B	bottom grid	119.85	
		GA841	rinse basket	125.30	
1800 SERIES DOUBLE EQUAL BOWL DROP IN SINK					
 <ul style="list-style-type: none"> • drain opening size: 3-5/8" • drop-in with: u channel • QuickMount™ installation hardware: included • depth size: 8" • minimum cabinet size: 36" • drain location: center • weight: 20.30 		G182133Q	double bowl three hole sink	392.80	
		G182134Q	double bowl four hole sink	392.80	
		ACCESSORIES			
		GA726	bottom grid	70.75	
		GA821	rinse basket	92.60	
 <ul style="list-style-type: none"> • drain opening size: 3-5/8" • drop-in with: u channel • QuickMount™ installation hardware: included • depth size: 7" • minimum cabinet size: 36" • drain location: center • weight: 20.60 		G182154Q	double bowl four hole sink	374.85	
		ACCESSORIES			
		GA726	bottom grid	70.75	
		GA821	rinse basket	92.60	
		 <ul style="list-style-type: none"> • drain opening size: 3-5/8" • drop-in with: u channel • QuickMount™ installation hardware: included • depth size: 9" • minimum cabinet size: 36" • drain location: center • weight: 23.85 		G182114Q	double bowl four hole sink
ACCESSORIES					
GA726	bottom grid			70.75	
GA821	rinse basket			92.60	

Drains and accessories sold separately. See pages 78 - 81.

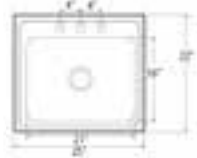
1800™ Series

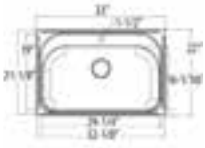
		MODEL NUMBER	DESCRIPTION	LIST PRICE	
1800 SERIES SINGLE BOWL DROP IN SINK					
 <ul style="list-style-type: none"> • drain opening size: 3-5/8" • drop-in with: u channel • QuickMount™ installation hardware: included • depth size: 10" • minimum cabinet size: 27" • drain location: center • weight: 16.80 		G181953Q	single bowl three hole sink	577.75	
		G181954Q	single bowl four hole sink	577.75	
		ACCESSORIES			
		GA716	bottom grid	100.65	
 <ul style="list-style-type: none"> • drain opening size: 3-5/8" • drop-in with: u channel • QuickMount™ installation hardware: included • depth size: 7" • minimum cabinet size: 36" • FHA compliant: yes • drain location: rear center • weight: 20.00 		G181631Q	single bowl one hole sink	522.20	
		ACCESSORIES			
		GA749B	bottom grid	152.10	
		FHA Compliant**			

Drains and accessories sold separately. See pages 78 - 81.

****FHA Compliant:** Sink compliant to FHA accessibility specifications when installed to these required standards. See specific product specification sheet for details.









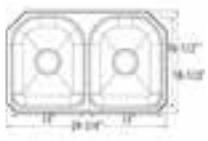

All stainless steel sinks feature SoundSHIELD™, a sound-deadening system that offers exceptional noise reduction and quiet dependability.

2000™ Series Sinks

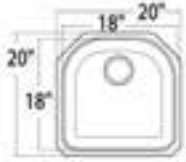
A variety of configurations and mounting options give you choices that fit almost any countertop material.

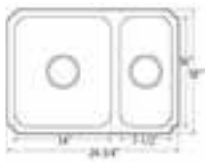
- 20 gauge
- brushed stainless steel finish
- includes mounting brackets
- includes cut-out template where applicable

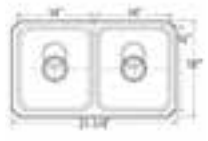

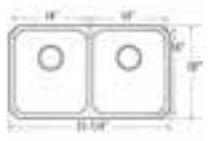







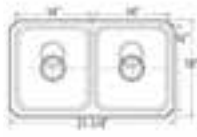

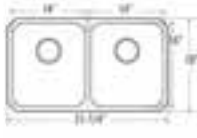
		MODEL NUMBER	DESCRIPTION	LIST PRICE
2000 SERIES D SHAPE DOUBLE EQUAL BOWL UNDERMOUNT SINK				
 <ul style="list-style-type: none"> • bowl type: D shape • drain opening size: 3-5/8" • depth size: 7-1/2" • minimum cabinet size: 36" • drain location: center • weight: 14.85 		G20256	double bowl sink	389.00
		ACCESSORIES		
		22524	cut-out template	15.80
		GA841	rinse basket	125.30
		GA944	cutting board	163.20
2000 SERIES D SHAPE SINGLE BOWL UNDERMOUNT SINK				
 <ul style="list-style-type: none"> • bowl type: D shape • drain opening size: 3-5/8" • depth size: 6-1/2" • minimum cabinet size: 24" • ADA/FHA compliant: yes • drain location: rear center • weight: 9.95 		G20160B	single bowl sink	229.00
		ACCESSORIES		
		22510	cut-out template	16.40
		ADA/FHA Compliant*		
2000 SERIES DOUBLE OFFSET BOWL UNDERMOUNT SINK				
 <ul style="list-style-type: none"> • drain opening size: 3-5/8" • depth size: 7-1/2", 5-1/2" • minimum cabinet size: 27" • reversible bowl: yes • drain location: center • weight: 12.65 		G20273	double bowl sink	359.00
		ACCESSORIES		
		22002	cut-out template	15.80
		GA726	bottom grid	70.75
2000 SERIES DOUBLE EQUAL BOWL UNDERMOUNT SINK				
 <ul style="list-style-type: none"> • drain opening size: 3-5/8" • depth size: 7-1/2" • minimum cabinet size: 36" • G20210 drain location: center • G20210B drain location: rear center • weight: 15.80 		G20210	double bowl sink	299.00
				G20210B
ACCESSORIES				
		22508	cut-out template	16.40
		GA782B	bottom grid - rear drain	125.80
		GA821	rinse basket	92.60
		GA922	cutting board	111.65
 <ul style="list-style-type: none"> • drain opening size: 3-5/8" • depth size: 6-1/2" • minimum cabinet size: 36" • ADA/FHA compliant: yes • drain location: rear center • weight: 18.90 		G20213B	double bowl sink	279.00
		ACCESSORIES		
		22508	cut-out template	16.40
		GA782B	bottom grid	125.80
		GA821	rinse basket	92.60
		GA922	cutting board	111.65
		ADA/FHA Compliant*		

Drains and accessories sold separately. See pages 78 - 81.



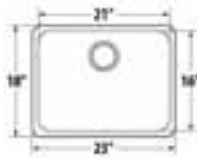



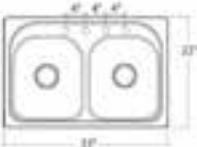

***ADA/FHA Compliant:** Sink compliant to ADA (ICC A117.1) and FHA accessibility specifications when installed to these required standards. See specific product specification sheet for details.

2000™ Series

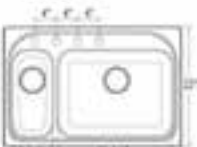
		MODEL NUMBER	DESCRIPTION	LIST PRICE	
2000 SERIES DOUBLE EQUAL BOWL UNDERMOUNT SINK (CONTINUED)					
	<ul style="list-style-type: none"> • drain opening size: 3-5/8" • depth size: 6" • minimum cabinet size: 36" • ADA/FHA compliant: G20214B • G20214 drain location: center • G20214B drain location: rear center • weight: 18.90 		G20214	double bowl sink	269.00
			G20214B	double bowl sink	269.00
ACCESSORIES					
			22508	cut-out template	16.40
			GA782B	bottom grid - rear drain	125.80
			GA821	rinse basket	92.60
			GA922	cutting board	111.65
ADA/FHA Compliant*					
	<ul style="list-style-type: none"> • drain opening size: 3-5/8" • depth size: 5-1/2" • minimum cabinet size: 36" • ADA/FHA compliant: yes • drain location: rear center • weight: 18.08 		G20216B	double bowl sink	259.00
			ACCESSORIES		
			22508	cut-out template	16.40
			GA782B	bottom grid	125.80
			GA821	rinse basket	92.60
			GA922	cutting board	111.65
ADA/FHA Compliant*					
2000 SERIES SINGLE BOWL UNDERMOUNT SINK					
	<ul style="list-style-type: none"> • drain opening size: 3-5/8" • depth size: 7-1/2" • minimum cabinet size: 27" • G20192 drain location: center • G20192B drain location: rear center • weight: 13.10 		G20192	single bowl sink	229.00
			G20192B	single bowl sink	229.00
ACCESSORIES					
			22507	cut-out template	16.40
			GA781B	bottom grid - rear drain	148.45
			GA922	cutting board	111.65
ADA/FHA Compliant*					
	<ul style="list-style-type: none"> • drain opening size: 3-5/8" • depth size: 6-1/2" • minimum cabinet size: 27" • G20193 drain location: center • ADA/FHA Compliant: G20193B • G20193B drain location: rear center • weight: 12.50 		G20193	single bowl sink	219.00
			G20193B	single bowl sink	219.00
ACCESSORIES					
			22507	cut-out template	16.40
			GA781B	bottom grid - rear drain	148.45
			GA922	cutting board	111.65
ADA/FHA Compliant*					
	<ul style="list-style-type: none"> • drain opening size: 3-5/8" • depth size: 5-1/2" • minimum cabinet size: 27" • ADA/FHA compliant: yes • drain location: rear center • weight: 9.40 		G20194B	single bowl sink	199.00
			ACCESSORIES		
			22507	cut-out template	16.40
			GA781B	bottom grid	148.45
			GA922	cutting board	111.65
ADA/FHA Compliant*					
2000 SERIES BAR/PREP UNDERMOUNT SINK					
	<ul style="list-style-type: none"> • drain opening size: 2" • depth size: 5-1/2" • minimum cabinet size: 15" • ADA/FHA compliant: G204502B • G204502 drain location: center • G204502B drain location: rear center • weight: 5.45 		G204502	single bowl sink	169.00
			G204502B	single bowl sink	169.00
ADA/FHA Compliant*					

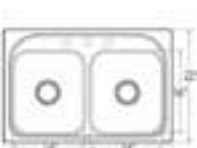
Drains and accessories sold separately. See pages 78 - 81.

***ADA/FHA Compliant:** Sink compliant to ADA (ICC A117.1) and FHA accessibility specifications when installed to these required standards. See specific product specification sheet for details.

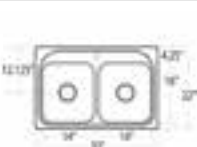
	MODEL NUMBER	DESCRIPTION	LIST PRICE
2000 SERIES D SHAPE DOUBLE EQUAL BOWL DROP IN SINK			
 <ul style="list-style-type: none"> • bowl type: D shape • drain opening size: 3-5/8" • drop-in with: u channel • QuickMount™ installation hardware: included • depth size: 7" • minimum cabinet size: 36" • FHA compliant: yes • drain location: rear center • weight: 16.70 		G202594BQ double bowl four hole sink 344.00	
		ACCESSORIES	
2000 SERIES DOUBLE OFFSET BOWL DROP IN SINK			
 <ul style="list-style-type: none"> • drain opening size: 3-5/8" • drop-in with: u channel • QuickMount™ installation hardware: included • depth size: 5-1/2", 6-1/2" • minimum cabinet size: 27" • ADA/FHA complaint: yes • drain location: rear center • weight: 15.70 		G202852BQ double bowl two hole sink 199.00 G202853BQ double bowl three hole sink 199.00 G202854BQ double bowl four hole sink 199.00 ADA/FHA Compliant*	
		ACCESSORIES	
 <ul style="list-style-type: none"> • drain opening size: 3-5/8" • drop-in with: u channel • QuickMount™ installation hardware: included • depth size: 9", 7" • minimum cabinet size: 36" • drain location: center • weight: 21.05 		G202861Q double bowl one hole sink 239.00 G202864Q double bowl four hole sink 239.00 ACCESSORIES GA922 cutting board 111.65	
		ACCESSORIES	
 <ul style="list-style-type: none"> • drain opening size: 3-5/8" • drop-in with: u channel • QuickMount™ installation hardware: included • depth size: 5-1/2", 8" • minimum cabinet size: 27" • drain location: center • weight: 17.60 		G202721BQ double bowl one hole sink 219.00 ACCESSORIES GA772 bottom grid 125.30 GA821 rinse basket 92.60 FHA Compliant**	
		ACCESSORIES	
2000 SERIES DOUBLE EQUAL BOWL DROP IN SINK			
 <ul style="list-style-type: none"> • drain opening size: 3-5/8" • drop-in with: u channel • QuickMount™ installation hardware: included • depth size: 8" • minimum cabinet size: 36" • G202131Q, G202133Q and G202134Q drain location: center • G202134BQ drain location: center rear • weight: 18.35 		G202131Q double bowl one hole sink 239.00 G202133Q double bowl three hole sink 239.00 G202134BQ double bowl four hole sink 239.00 G202134Q double bowl four hole sink 239.00 ACCESSORIES GA726 bottom grid - center drain 70.75 GA821 rinse basket 92.60	
		ACCESSORIES	

Drains and accessories sold separately. See pages 78 - 81.







***ADA/FHA Compliant:** Sink compliant to ADA (ICC A117.1) and FHA accessibility specifications when installed to these required standards. See specific product specification sheet for details.

****FHA Compliant:** Sink compliant to FHA accessibility specifications when installed to these required standards. See specific product specification sheet for details.

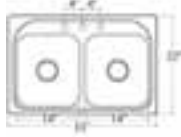

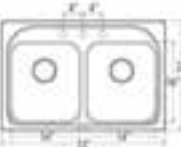
2000™ Series

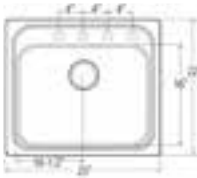

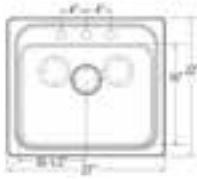



SINKS

		MODEL NUMBER	DESCRIPTION	LIST PRICE
2000 SERIES DOUBLE EQUAL BOWL DROP IN SINK (CONTINUED)				
 <ul style="list-style-type: none"> • drain opening size: 3-5/8" • drop-in with: u channel • QuickMount™ installation hardware: included • depth size: 7" • minimum cabinet size: 36" • FHA compliant: yes • drain location: rear center • weight: 18.15 		G202153BQ	double bowl three hole sink	219.00
		G202154BQ	double bowl four hole sink	219.00
		ACCESSORIES		
		GA821	rinse basket	92.60
		FHA Compliant**		
 <ul style="list-style-type: none"> • drain opening size: 3-5/8" • drop-in with: u channel • QuickMount™ installation hardware: included • depth size: 5-1/2" • minimum cabinet size: 36" • ADA/FHA compliant: yes • drain location: rear center • weight: 15.00 		G202173BQ	double bowl three hole sink	199.00
		G202174BQ	double bowl four hole sink	199.00
		ACCESSORIES		
		GA821	rinse basket	92.60
		ADA/FHA Compliant*		
2000 SERIES SINGLE BOWL DROP IN SINK				
 <ul style="list-style-type: none"> • drain opening size: 3-5/8" • drop-in with: u channel • QuickMount™ installation hardware: included • depth size: 7" • minimum cabinet size: 27" • G201963Q and G201964Q drain location: center • FHA compliant: G201961BQ, G201962BQ, G201963BQ, and G201964BQ • G201961BQ, G201962BQ, G201963BQ and G201964BQ drain location: rear center • weight: 13.15 		G201961BQ	single bowl one hole sink	159.00
		G201962BQ	single bowl two hole sink	159.00
		G201963BQ	single bowl three hole sink	159.00
		G201963Q	single bowl three hole sink	159.00
		G201964BQ	single bowl four hole sink	159.00
		G201964Q	single bowl four hole sink	159.00
ACCESSORIES				
		GA781B	bottom grid - rear drain	148.45
		FHA Compliant**		
 <ul style="list-style-type: none"> • drain opening size: 3-5/8" • drop-in with: u channel • QuickMount™ installation hardware: included • depth size: 5-1/2" • minimum cabinet size: 27" • ADA/FHA installation compatible: yes • G201974BQ drain location: rear center • G201974LQ drain location: rear left • G201974RQ drain location: rear right • ADA/FHA compliant: yes • weight: 11.20 		G201974BQ	single bowl four hole sink	139.00
		G201974LQ	single bowl four hole sink	139.00
		G201974RQ	single bowl four hole sink	139.00
		ADA/FHA Compliant*		

Drains and accessories sold separately. See pages 78 - 81.

***ADA/FHA Compliant:** Sink compliant to ADA (ICC A117.1) and FHA accessibility specifications when installed to these required standards. See specific product specification sheet for details.

****FHA Compliant:** Sink compliant to FHA accessibility specifications when installed to these required standards. See specific product specification sheet for details.

		MODEL NUMBER	DESCRIPTION	LIST PRICE
2000 SERIES BAR/PREP DROP IN SINK				
	<ul style="list-style-type: none"> • drain opening size: 2" • drop-in with: u channel • QuickMount™ installation hardware: included • depth size: 5-1/2" • minimum cabinet size: 15" • ADA/FHA compliant: yes • drain location: rear center • bar faucet included: 4904 • weight: 12.55 	TG2045522BQ	single bowl two hole sink ADA/FHA Compliant*	269.00
	<ul style="list-style-type: none"> • drain opening size: 2" • drop-in with: u channel • QuickMount™ installation hardware: included • depth size: 5-1/2" • minimum cabinet size: 18" • ADA/FHA compliant: yes • drain location: rear center • bar faucet included: 4904 • weight: 12.00 	TG2045622BQ	single bowl two hole sink ADA/FHA Compliant*	269.00
	<ul style="list-style-type: none"> • drain opening size: 3-5/8" • drop-in with: u channel • QuickMount™ installation hardware: included • depth size: 6-1/2" • minimum cabinet size: 18" • ADA/FHA compliant: yes • drain location: rear center • weight: 10.85 	G204571BQ	single bowl one hole sink	219.00
		G204573BQ	single bowl three hole sink	219.00
			ACCESSORIES	
		GA821	rinse basket	92.60
		GA922	cutting board	111.65
			ADA/FHA Compliant*	
	<ul style="list-style-type: none"> • drain opening size: 2" • drop-in with: u channel • QuickMount™ installation hardware: included • depth size: 5-1/2" • minimum cabinet size: 15" • ADA/FHA compliant: yes • drain location: rear center • weight: 7.20 	KG2045522BQ	single bowl two hole sink ADA/FHA Compliant*	119.00
	<ul style="list-style-type: none"> • drain opening size: 2" • drop-in with: u channel • QuickMount™ installation hardware: included • depth size: 5-1/2" • minimum cabinet size: 18" • ADA/FHA compliant: yes • drain location: rear center • weight: 7.10 	KG2045622BQ	single bowl two hole sink ADA/FHA Compliant*	119.00
2000 SERIES DROP IN SINGLE BOWL SINK				
	<ul style="list-style-type: none"> • drain opening size: 3-5/8" • QuickMount™ installation hardware: included • depth size: 5-1/2" • minimum cabinet size: 27" • drain location: center • weight: 10.20 	22132Q	single bowl two hole sink	299.00

Drains and accessories sold separately. See pages 78 - 81.

***ADA/FHA Compliant:** Sink compliant to ADA (ICC A117.1) and FHA accessibility specifications when installed to these required standards. See specific product specification sheet for details.

2200™ Series



All stainless steel sinks feature SoundSHIELD™, a sound-deadening system that offers exceptional noise reduction and quiet dependability.

2200™ Series Sinks

The 2200™ Series offers 22-gauge stainless steel construction that provides sturdy functionality and most commonly used configurations.

- 22 gauge
- brushed stainless steel finish
- includes mounting brackets
- includes cut-out template where applicable









SINKS

		MODEL NUMBER	DESCRIPTION	LIST PRICE
2200 SERIES DOUBLE EQUAL BOWL DROP IN SINK				
	<ul style="list-style-type: none"> • drain opening size: 3-5/8" • drop-in with: u channel • depth size: 8" • minimum cabinet size: 36" • G222133 and G222134 drain location: center • G222133B and G222134B drain location: rear center • weight: 15.60 			
		G222133	double bowl three hole sink	184.00
		G222133B	double bowl three hole sink	184.00
		G222134	double bowl four hole sink	184.00
		G222134B	double bowl four hole sink	184.00
	<ul style="list-style-type: none"> • drain opening size: 3-5/8" • drop-in with: u channel • depth size: 7" • minimum cabinet size: 36" • FHA compliant: yes • drain location: rear center • weight: 16.35 			
		G222153B	double bowl three hole sink	144.00
		G222154B	double bowl four hole sink	144.00
		FHA Compliant**		
	<ul style="list-style-type: none"> • drain opening size: 3-5/8" • drop-in with: u channel • depth size: 6-1/2" • minimum cabinet size: 36" • ADA/FHA compliant: yes • drain location: rear center • weight: 13.15 			
		G222163	double bowl three hole sink	124.00
		G222163B	double bowl three hole sink	124.00
		G222164	double bowl four hole sink	124.00
		G222164B	double bowl four hole sink	124.00
		ADA/FHA Compliant*		
	<ul style="list-style-type: none"> • drain opening size: 3-5/8" • drop-in with: u channel • depth size: 5-1/2" • minimum cabinet size: 36" • ADA/FHA compliant: yes • drain location: rear center • weight: 13.15 			
		G222203B	double bowl three hole sink	114.00
		G222204B	double bowl four hole sink	114.00
		ADA/FHA Compliant*		

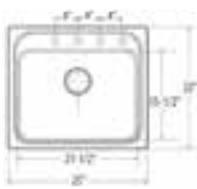
Drains and accessories sold separately. See pages 78 - 81.

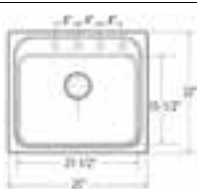
***ADA/FHA** Compliant: Sink compliant to ADA (ICC A117.1) and FHA accessibility specifications when installed to these required standards. See specific product specification sheet for details.

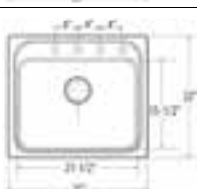
****FHA** Compliant: Sink compliant to FHA accessibility specifications when installed to these required standards. See specific product specification sheet for details.

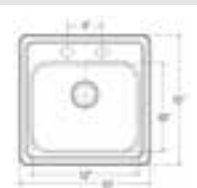
		MODEL NUMBER	DESCRIPTION	LIST PRICE
2200 SERIES SINGLE BOWL DROP IN SINK				
 <ul style="list-style-type: none"> • drain opening size: 3-5/8" • drop-in with: u channel • depth size: 7" • minimum cabinet size: 27" • FHA compliant: yes • drain location: rear center • weight: 11.20 		G221963B	single bowl three hole sink	129.00
		G221964B	single bowl four hole sink	129.00
			FHA Compliant**	
 <ul style="list-style-type: none"> • drain opening size: 3-5/8" • drop-in with: u channel • depth size: 6-1/2" • minimum cabinet size: 27" • ADA/FHA compliant: yes • drain location: rear center • weight: 8.85 		G221983B	single bowl three hole sink	104.00
		G221984B	single bowl four hole sink	104.00
			ADA/FHA Compliant*	
 <ul style="list-style-type: none"> • drain opening size: 3-5/8" • drop-in with: u channel • depth size: 5-1/2" • minimum cabinet size: 27" • ADA/FHA compliant: yes • drain location: rear center • weight: 8.85 		G221203B	single bowl three hole sink	94.00
		G221204B	single bowl four hole sink	94.00
			ADA/FHA Compliant*	
2200 SERIES BAR/PREP DROP IN SINK				
 <ul style="list-style-type: none"> • drain opening size: 2" • drop-in with: u channel • depth size: 5-1/2" • minimum cabinet size: 18" • ADA/FHA compliant: yes • drain location: rear center • weight: 4.60 		G2245622B	single bowl two hole sink	84.00
			ADA/FHA Compliant*	

Drains and accessories sold separately. See pages 78 - 81.

***ADA/FHA Compliant:** Sink compliant to ADA (ICC A117.1) and FHA accessibility specifications when installed to these required standards. See specific product specification sheet for details.

****FHA Compliant:** Sink compliant to FHA accessibility specifications when installed to these required standards. See specific product specification sheet for details.









Custom Sink Accessories

Custom Sink Accessories











Tasks in and around the sink are easier with Moen® custom sink accessories. Available in a variety of sizes for the perfect fit, these accessories protect the sink from tough tasks and are a great complement to Moen® stainless steel sinks.



		MODEL NUMBER	DESCRIPTION	LIST PRICE
D SHAPE REAR DRAIN GRID ACCESSORY				
	<ul style="list-style-type: none"> • features: stainless steel construction • fits bowl size: 29" x 16" D-shaped rear drain 	GA749B	Stainless bottom grid	152.10
	<ul style="list-style-type: none"> • features: stainless steel construction • fits bowl size: 18" x 18" D-shaped rear drain 	GA748B	Stainless bottom grid	135.90
	<ul style="list-style-type: none"> • features: stainless steel construction • fits bowl size: 13" x 16.5" D-shaped rear drain 	GA746B	Stainless bottom grid	119.85
CENTER DRAIN GRID ACCESSORY				
	<ul style="list-style-type: none"> • features: stainless steel construction • fits bowl size: 30" x 18" professional center drain 	GA760	Stainless bottom grid	170.15
	<ul style="list-style-type: none"> • features: stainless steel construction • fits bowl size: 18" x 18" center drain 	GA768	Stainless bottom grid	148.45
	<ul style="list-style-type: none"> • features: stainless steel construction • fits bowl size: 29" x 16" center drain 	GA719	Stainless bottom grid	145.45









Stainless steel construction for all baskets and grids.

Custom Sink Accessories

		MODEL NUMBER	DESCRIPTION	LIST PRICE
CENTER DRAIN GRID ACCESSORY (CONTINUED)				
	<ul style="list-style-type: none"> • features: stainless steel construction • fits bowl size: 13" x 18" professional center drain 	GA763	Stainless bottom grid	125.80
	<ul style="list-style-type: none"> • features: stainless steel construction • fits bowl size: 21" x 16" center drain 	GA716	Stainless bottom grid	100.65
	<ul style="list-style-type: none"> • features: stainless steel construction • fits bowl size: 14" x 18" center drain 	GA728	Stainless bottom grid	95.45
	<ul style="list-style-type: none"> • features: stainless steel construction • fits bowl size: 14" x 16" center drain 	GA726	Stainless bottom grid	70.75
REAR DRAIN GRID ACCESSORY				
	<ul style="list-style-type: none"> • features: stainless steel construction • fits bowl size: 29" x 16" professional rear drain 	GA780B	Stainless bottom grid	166.25
	<ul style="list-style-type: none"> • features: stainless steel construction • fits bowl size: 28" x 16" rear drain 	GA771	Stainless bottom grid	163.50
	<ul style="list-style-type: none"> • features: stainless steel construction • fits bowl size: 20" x 16" professional rear drain 	GA781B	Stainless bottom grid	148.45
	<ul style="list-style-type: none"> • features: stainless steel construction • fits bowl size: 16" x 16" professional rear drain 	GA785B	Stainless bottom grid	137.25
	<ul style="list-style-type: none"> • features: stainless steel construction • fits bowl size: 12.5" x 16" professional rear drain 	GA782B	Stainless bottom grid	125.80
	<ul style="list-style-type: none"> • features: stainless steel construction • fits bowl size: 13.6" x 16.6" rear drain 	GA772	Stainless bottom grid	125.30







Stainless steel construction for all baskets and grids.

Custom Sink Accessories

		MODEL NUMBER	DESCRIPTION	LIST PRICE
D SHAPE RINSE BASKET ACCESSORY				
	<ul style="list-style-type: none"> • features: stainless steel construction • fits bowl size: 13" x 16.5" 	GA841	Stainless rinse basket	125.30
RINSE BASKET ACCESSORY				
	<ul style="list-style-type: none"> • features: stainless steel construction • fits bowl size: 14" x 16" 	GA821	Stainless rinse basket	92.60
D SHAPE CUTTING BOARD ACCESSORY				
	<ul style="list-style-type: none"> • fits bowl size: 13" x 16.5" 	GA944	Natural wood cutting board	163.20
CUTTING BOARD ACCESSORY				
	<ul style="list-style-type: none"> • fits bowl size: 16" front-to-back bowl 	GA922	Natural wood cutting board	111.65
DRAIN ASSEMBLY				
	<ul style="list-style-type: none"> • drop-in basket strainer with drain assembly: 3-1/2" • fits sinks with standard 3-5/8" outlet • includes: lock nut 	22037	Satin stainless steel sink accessory	16.90
	<ul style="list-style-type: none"> • drop-in basket strainer with drain assembly: 3-1/2" • fits sinks with standard 3-5/8" outlet • includes: lock nut 	22036	Stainless composite sink accessories	19.35
	<ul style="list-style-type: none"> • basket strainer with drain assembly: 2" • fits sinks with standard 2" outlet • includes: lock nut 	22174	Stainless stainless steel sink accessory	8.75
SEALTITE DRAIN ASSEMBLY				
	<ul style="list-style-type: none"> • sealtite drain assembly: 2" • fits sinks with standard 2" outlet 	22201	Stainless steel sink accessory	14.50

Stainless steel construction for all baskets and grids.

Custom Sink Accessories

		MODEL NUMBER	DESCRIPTION	LIST PRICE
BASKET STRAINER				
	<ul style="list-style-type: none"> • drop-in basket strainer: 3-1/2" • fits sinks with standard 3 1/2" outlet 	22194	Stainless steel sink accessory	6.10
INSTALLATION CLAMP				
	<ul style="list-style-type: none"> • QuickMount™ installation hardware: 10 pieces • accommodates counter depth up to 1-5/8" • U-channel drop-in installation hardware 	181250	Mounting kit	69.50
	<ul style="list-style-type: none"> • u-channel clamp: 8 pieces • u-channel clamp: 10 pieces • u-channel clamp: 12 pieces 	22684	Stainless steel sink accessory	3.75
		22681	Stainless steel sink accessory	4.55
		22682	Stainless steel sink accessory	5.40
INSTALLATION BRACKET				
	<ul style="list-style-type: none"> • undermount bracket pack: 10 pieces 	22650	Stainless steel sink accessory	12.35
INSTALLATION SCREW				
	<ul style="list-style-type: none"> • u-channel 3" extension screw: 1 piece 	22175	Stainless steel sink accessory	4.20
HOLE COVER				
	<ul style="list-style-type: none"> • hole cover: 1-1/2" • finish: stainless 	22897	Stainless steel sink accessory	1.05

NOTES

Lined writing area with horizontal ruling lines.



GARBAGE DISPOSALS

Garbage Disposals

GX Series, GX PRO Series and Accessories

GX Series 1 HP Garbage Disposal / GXL1000c

Please see moen.com/consumer-support/warranty for complete product warranty information.

GX SERIES Garbage Disposals

		MODEL NUMBER	LIST PRICE	CASE QTY
GX SERIES				
	<ul style="list-style-type: none"> • 1 horsepower, 2800 RPM, continuous feed • dishwasher connection with 1 1/2" drain outlet • 13.00 lbs., 16" height • grind component material: stainless steel • includes pre-installed power cord, removable splash guard, polished stainless steel sink flange with drain stopper, drain elbow and mounting assembly • 10 year limited warranty with in-home service 	GXL1000C	452.00	1
	     			
	<ul style="list-style-type: none"> • 1 horsepower, 2800 RPM, continuous feed • dishwasher connection with 1 1/2" drain outlet • 13.00 lbs., 16" height • grind component material: stainless steel • includes pre-installed power cord, removable splash guard, polished stainless steel sink flange with drain stopper, drain elbow and mounting assembly • 7 year limited warranty with in-home service 	GX100C	372.00	1
	     			
	<ul style="list-style-type: none"> • 3/4 horsepower, 2700 RPM, batch feed • dishwasher connection with 1 1/2" drain outlet • 11.00 lbs., 15-5/8" height • grind component material: galvanized steel • includes pre-installed power cord, removable splash guard, polished stainless steel sink flange with drain stopper, drain elbow and mounting assembly • 8 year limited warranty with in-home service 	GXB75C	319.75	2
	    			
	<ul style="list-style-type: none"> • 3/4 horsepower, 2700 RPM, continuous feed • dishwasher connection with 1 1/2" drain outlet • 12.00 lbs., 14-3/8" height • grind component material: stainless steel • includes pre-installed power cord, removable splash guard, polished stainless steel sink flange with drain stopper, drain elbow and mounting assembly • 6 year limited warranty with in-home service 	GX75C	292.00	2
	     			
	<ul style="list-style-type: none"> • 3/4 horsepower, 2700 RPM, continuous feed • dishwasher connection with 1 1/2" drain outlet • 10.25 lbs., 13-3/8" height • grind component material: galvanized steel • includes pre-installed power cord, removable splash guard, polished stainless steel sink flange with drain stopper, drain elbow and mounting assembly • 5 year limited warranty with in-home service 	GXS75C	238.70	2
	     			

GARBAGE DISPOSALS

NOTES



Universal Xpress Mount™ fits Moen and most existing 3-bolt mounting assemblies



High-speed VORTEX™ motor provides fast, powerful grinding



Continuous feed grinds as long as power is on



Batch Feed Stopper activates disposal for safer operation. No wall switch required



Permanent magnet motor designed to help reduce jamming





















SoundSHIELD™ designed to provide sound deadening insulation



Pre-installed power cord is a savings over other models where cord must be purchased separately

GX SERIES & GX PRO SERIES Garbage Disposals

		MODEL NUMBER	LIST PRICE	CASE QTY
GX SERIES (CONTINUED)				
	<ul style="list-style-type: none"> • 1/2 horsepower, 2600 RPM, continuous feed • dishwasher connection with 1 1/2" drain outlet • 9.25 lbs., 13-3/8" height • grind component material: stainless steel • includes pre-installed power cord, removable splash guard, polished stainless steel sink flange with drain stopper, drain elbow and mounting assembly • 4 year limited warranty with in-home service 	GX50C	172.00	2
	    			
GX PRO SERIES				
	<ul style="list-style-type: none"> • 1/2 horsepower, 2600 RPM, continuous feed • dishwasher connection with 1 1/2" drain outlet • 8.50 lbs., 13-3/8" height • grind component material: galvanized steel • includes pre-installed power cord, removable splash guard, polished stainless steel sink flange with drain stopper, drain elbow and mounting assembly • 3 year limited warranty with in-home service 	GXP50C	133.25	2
	    			
	<ul style="list-style-type: none"> • 1/3 horsepower, 1900 RPM, continuous feed • dishwasher connection with 1 1/2" drain outlet • 7.75 lbs., 13-3/8" height • grind component material: galvanized steel • includes pre-installed power cord, removable splash guard, polished stainless steel sink flange with drain stopper, drain elbow and mounting assembly • 2 year limited warranty with in-home service 	GXP33C	113.25	2
	    			

GARBAGE DISPOSALS

NOTES



Universal Xpress Mount™ fits Moen and most existing 3-bolt mounting assemblies



High-speed VORTEX™ motor provides fast, powerful grinding



Continuous feed grinds as long as power is on



Batch Feed Stopper activates disposal for safer operation. No wall switch required



Permanent magnet motor designed to help reduce jamming









SoundSHIELD™ designed to provide sound deadening insulation









Pre-installed power cord is a savings over other models where cord must be purchased separately

ACCESSORIES Garbage Disposals

		MODEL NUMBER	LIST PRICE	CASE QTY
DISPOSAL AIR SWITCH CONTROLLER				
	<ul style="list-style-type: none"> air tubing size: 1/8" mounting hole size: 1-3/8" air tube length: 10' compatible with all disposals 1 year limited warranty ideal application for island countertops or where electrical switch is unavailable 	ARC-4200	62.50	60
DISPOSAL AIR SWITCH CONTROLLER				
	<ul style="list-style-type: none"> diameter: 1-13/16" use with ARC-4200 color assortment available to match faucet and sink compatible with all disposals 1 year limited warranty 	AS-4201-AL AS-4201-BIS AS-4201-WH AS-4201-BR AS-4201-CH AS-4201-BRB AS-4201-SN	12.50 12.50 12.50 21.00 21.00 31.75 42.00	100 100 100 100 100 100 100
DRAIN STOPPER				
	<ul style="list-style-type: none"> compatible with all Moen disposals & other 3-bolt mounting systems 1 year limited warranty 	1011	15.70	24
DISPOSAL POWER CORD KIT				
	<ul style="list-style-type: none"> compatible with all disposals 1 year limited warranty 	1024	10.25	24
DRAIN ELBOW & GASKET				
	<ul style="list-style-type: none"> compatible with all Moen disposals & other 3-bolt mounting systems 1 year limited warranty 	1026	9.40	6
PLASTIC DRAIN STOPPER				
	<ul style="list-style-type: none"> compatible with all Moen disposals & other 3-bolt mounting systems 1 year limited warranty 	186589	9.30	6

ACCESSORIES Garbage Disposals

		MODEL NUMBER	LIST PRICE	CASE QTY
DISPOSAL UNJAMMING WRENCH				
		<ul style="list-style-type: none"> compatible with all Moen disposals & other 3-bolt mounting systems 1 year limited warranty 	1037	9.00 10
DISHWASHER CONNECTOR KIT				
		<ul style="list-style-type: none"> compatible with all Moen disposals & other 3-bolt mounting systems 1 year limited warranty 	1023	8.40 24
DISHWASHER CONNECTOR KIT				
		<ul style="list-style-type: none"> compatible with all Moen disposals & other 3-bolt mounting systems 1 year limited warranty 	1016	8.15 100



Bath and Shower Collections

BATH

- NEW!** Belfield™ Two-Handle Widespread Bathroom Faucet / T6405
- NEW!** Belfield™ Two-Handle Roman Tub / T9024
- NEW!** Belfield™ Grab Bar / YG6418CH
- NEW!** Belfield™ Hand Towel Bar / YB6486CH
- NEW!** Belfield™ One-Globe Light / YB6461CH

Please see [moen.com/consumer-support/warranty](https://www.moen.com/consumer-support/warranty) for complete product warranty information.

Easily Change Your Style

The Moen® M•PACT® Common Valve system lets you upgrade the style of your faucet or shower as easily as changing a light bulb, saving you time, money and effort.

Little Effort, Big Difference

With an M•PACT compatible fixture, you can upgrade your bath or shower faucets at any time and never touch the plumbing. All changes can be made above the deck or in front of the wall.

- Untwist your current fixture from the top to remove
- Choose any M•PACT style fixture you like
- Lock right into place

Upgrade Anytime

The system is available in a variety of attractive styles and elegant finishes. Change fixtures at any point while decorating, during construction or years down the road.

What Sets Moen Apart?

Our M•PACT Common Valve System allows the homeowner to completely upgrade the style of their lavatory or shower faucet without replacing any of the faucet plumbing.

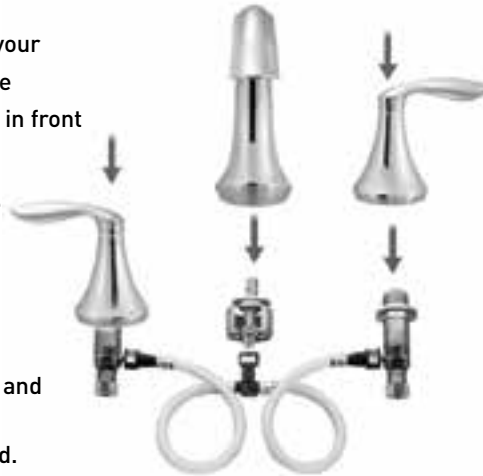

The M•PACT Common Valve System is available in the following applications:

- Widespread lav faucets
- Roman tub faucets
- Wallmount lav faucets
- Tub/shower trim



The M•PACT Common Valve System is compatible with Moen bath and shower faucets featuring this logo.

Save Time With The Pro-Fit® Installation System

The Moen three-step Pro-Fit Installation System is the most innovative, simple way to mount bath accessories. Installation is as easy as 1-2-3.

1. **DRILL IT!** Use the installation mounting template with built-in level.
2. **SCREW IT!** Screw in the pre-attached fastener.
3. **CLICK IT!** Press on the post until it locks into place.

It really is that simple! Plus, we've eliminated the set screw. Designed with input from professional installers, the Pro-Fit Installation System was made for faster installation and fewer call backs. And of course, there's the extra assurance of quality that comes with the Moen brand. *Available on select collections.*

The Pro-Fit System eliminates set screws for faster, more durable mounting. There's even a template with a built-in level.

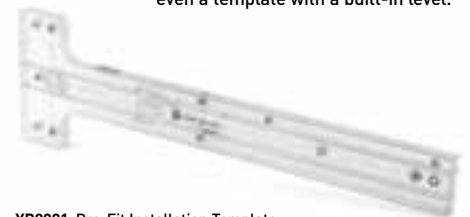

YB8081 Pro-Fit Installation Template



DRILL IT! The innovative template has a built-in level for accurate drilling of pilot holes for both 18" and 24" towel bars or paper holders.



SCREW IT! Single screw mounting system uses pre-attached hollow wall anchor for a fast, solid installation.



CLICK IT! Locking tab clicks to hold the post firmly in place and eliminates the need for a set screw.

Roman Tub Valves.

Versatile. Durable. Built To Perform.

Moen roman tub valve improvements are designed for faster, more secure mounting on a wider variety of tub decks. Plus, an expanded portfolio of connection options makes installation even easier for installers of all skill levels.

Key Features and Improvements

MORE!

Supply Connection Options
Moen also recognizes the increased use of PEX, cold expansion PEX and CPVC supply lines. Plumbers can now order valves designed to work directly with all types of piping — including copper. No other manufacturer offers more options.

NEW!

Dura-Grip® Mounting System
This robust engineered system, where the mounting hardware components work together to prevent the valves and spout from moving after installation, also provides features that work with all types of surfaces (on both fixed and adjustable valves).

IMPROVED!

Standardized Drill Holes
Only one drill bit (1¼") is needed for all spout and handle holes to further speed and simplify installation.

TEST PLUG

All models include a brass test plug for high-pressure testing after rough-in.

Fixed Roman Tub Valve

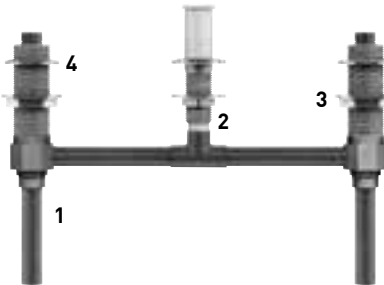

1. Robust, Pre-Soldered Design

Set to standard 10" centers.

2. Dura-Grip Mounting Hardware

Improved design works with all deck materials including wood, fiberglass, tile and stone.

3. Versatile

Fits tub decks from ⅛" to 1⅞" thick.

4. M•PACT® Common Valve System Compatible

Accepts all Moen roman tub trim kits. 

Adjustable Roman Tub Valve

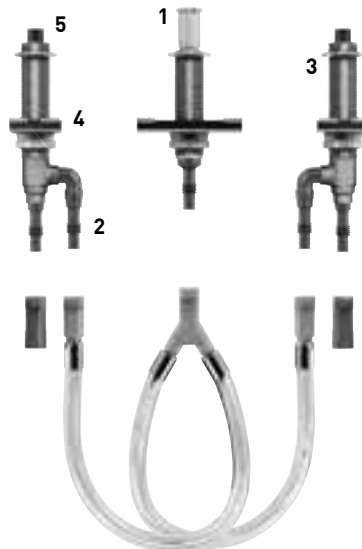

1. No-Cut Adjustable Spout Shank

Loosen an expansion nut, extend and lock in place using the supplied metal tool.

2. Quick-Connect Flexible Hose

Braided PVC tube for easy connections.

3. 3⅜" Rough-In Deck Thickness

Adapts to decks from ⅛" to 2¾" thick — with an additional 1¼" of available adjustability to accommodate finish materials.

4. Dura-Grip Mounting System

Anti-rotation bracket and spout shank assembly provide secure installation to a variety of surfaces both above and below the deck.

5. M•PACT Common Valve System Compatible

Accepts all Moen roman tub trim kits. 















All Moen products are backed by a Limited Lifetime Warranty.

See moen.com/consumer-support/warranty for complete product warranty information.

WEYMOUTH® Bathroom Faucets

All Brushed Nickel and Polished Nickel faucet components feature the LifeShine® Non-Tarnish Finish.

		MODEL NUMBER	LIST PRICE	FINISH/ CONNECTION	CASE QTY
ONE-HANDLE BATHROOM FAUCET					
 <ul style="list-style-type: none"> • application: one hole • supply line length: flexible • connection size: 3/8" • connection type: compression • drain assembly: spring loaded pop-up • drain assembly type: spring loaded pop-up   DURALAST®	PREMIUM	S42107	532.70	Chrome	3
	S42107BN	819.45	Brushed Nickel	3	
	S42107NL	819.45	Polished Nickel	3	
	S42107ORB	884.15	Oil Rubbed Bronze	3	
TWO-HANDLE WIDESPREAD BATHROOM FAUCET					
 <ul style="list-style-type: none"> • application: three hole • center dimensions: 8" - 16" center • drain assembly: metal • drain assembly type: lift rod • valve: sold separately   	PREMIUM	TS42108	565.60	Chrome	3
	TS42108BN	858.15	Brushed Nickel	3	
	TS42108NL	858.15	Polished Nickel	3	
	TS42108ORB	925.90	Oil Rubbed Bronze	3	
 <ul style="list-style-type: none"> • application: three hole • center dimensions: 8" - 16" center • drain assembly: metal • drain assembly type: lift rod • valve: sold separately  	PREMIUM	TS42114	565.60	Chrome	3
	TS42114BN	858.15	Brushed Nickel	3	
	TS42114NL	858.15	Polished Nickel	3	
	TS42114ORB	925.90	Oil Rubbed Bronze	3	
 <ul style="list-style-type: none"> • application: three hole • center dimensions: 8" - 16" center • drain assembly: metal • drain assembly type: lift rod  DURALOCK® DURALAST®	9000 ♦		123.55	1/2" IPS	6
 <ul style="list-style-type: none"> • description: finished handle cap kit • language: english version only 		221672	22.80	Chrome	12
		221672BN	30.30	Brushed Nickel	12
		221672NL	30.30	Polished Nickel	12
		221672ORB	33.50	Oil Rubbed Bronze	12

WEYMOUTH®

HOW TO ORDER A COMPLETE BATHROOM FAUCET

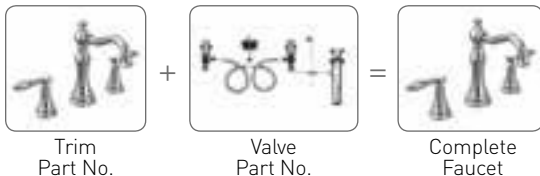











NOTES

- ♦ Also available in bulk pack. See page 435.
 - Ⓜ Moen® **M•PACT®** Common Valve System
 - DURALOCK®** Duralock® Quick Connections
 - DURALAST®** Duralast® Cartridge
- Refer to lavatory waste assemblies on page 403.
Refer to specification sheet for critical dimensions for installation.

WEYMOUTH® Bathroom Faucets

All Brushed Nickel and Polished Nickel faucet components feature the LifeShine® Non-Tarnish Finish.

	MODEL NUMBER	LIST PRICE	FINISH/ CONNECTION	CASE QTY
TWO-HANDLE WALLMOUNT BATHROOM FAUCET				
 <ul style="list-style-type: none"> • application: three hole • center dimensions: 8" center • drain assembly: 140780 sold separately • valve: sold separately   	PREMIUM			
	TS42106	578.70	Chrome	3
	TS42106BN	813.00	Brushed Nickel	3
	TS42106NL	813.00	Polished Nickel	3
	TS42106ORB	877.15	Oil Rubbed Bronze	3
 <ul style="list-style-type: none"> • application: three hole • center dimensions: 8" center • drain assembly: 140780 sold separately • valve: sold separately  	PREMIUM			
	TS42112	578.70	Chrome	3
	TS42112BN	813.00	Brushed Nickel	3
	TS42112NL	813.00	Polished Nickel	3
	TS42112ORB	877.15	Oil Rubbed Bronze	3
 <ul style="list-style-type: none"> • application: three hole • center dimensions: 8" center • drain assembly: 140780 sold separately • includes: mounting brackets 	9700	174.75	1/2" CC	3
 <ul style="list-style-type: none"> • drain assembly: metal • drain assembly type: spring loaded pop-up • drain assembly size: 1-1/4" • drain assembly: 1-1/4" non-overflow 	140780	59.20	Chrome	12
	140780BN	82.60	Brushed Nickel	12
	140780NL	81.90	Polished Nickel	12
	140780ORB	93.30	Oil Rubbed Bronze	12
	 <ul style="list-style-type: none"> • description: finished handle cap kit • language: english version only 	221672	22.80	Chrome
221672BN		30.30	Brushed Nickel	12
221672NL		30.30	Polished Nickel	12
221672ORB		33.50	Oil Rubbed Bronze	12

HOW TO ORDER A COMPLETE BATHROOM FAUCET



NOTES













 Moen® **M•PACT**® Common Valve System

Refer to specification sheet for critical dimensions for installation.



WEYMOUTH® Tub Fillers

All Brushed Nickel faucet components feature the LifeShine® Non-Tarnish Finish.

		MODEL NUMBER	LIST PRICE	FINISH/ CONNECTION	CASE QTY
WALLMOUNT OR FREESTANDING TUB FILLER					
 <ul style="list-style-type: none"> • application: two hole • center dimensions: 8" center • connection size: 3/4" • connection type: male • showerhead type: handshower • handshower functions: one-function • handshower flow rate: 2.0 transitioning to 1.75 gpm • spout reach: 9.00" • valve: sold separately  DURALAST®		PREMIUM			
		S22105	1,665.10	Chrome	1
		S22105BN	2,414.45	Brushed Nickel	1
	NEW!	S22105ORB	2,655.90	Oil Rubbed Bronze	1
 <ul style="list-style-type: none"> • application: two hole • center dimensions: 8" center • connection size: 3/4" • connection type: male • showerhead type: handshower • handshower functions: one-function • handshower flow rate: 2.0 transitioning to 1.75 gpm • spout reach: 9.00" • valve: sold separately  DURALAST®		PREMIUM			
		S22110	1,665.10	Chrome	1
		S22110BN	2,414.45	Brushed Nickel	1
	NEW!	S22110ORB	2,655.90	Oil Rubbed Bronze	1
 <ul style="list-style-type: none"> • description: double riser floor joist mounting kit • application: two hole • center dimensions: 8" center • connection type: npt; CC • quarter turn stops: included 		PREMIUM			
		TS50200	413.65	1/2" NPT, CC	2
 <ul style="list-style-type: none"> • description: double riser concrete mounting kit • application: two hole • center dimensions: 8" center • connection type: npt; CC • quarter turn stops: included 		PREMIUM			
		TS50210	351.55	1/2" NPT, CC	2
 <ul style="list-style-type: none"> • description: floor mount tub filler risers • application: two hole • connection size: 3/4" • connection type: male • requires: floor mounting kit • fits: S22105 and S22110 		PREMIUM			
		TS25105	694.70	Chrome	3
		TS25105BN	1,007.30	Brushed Nickel	3
	NEW!	TS25105ORB	1,108.00	Oil Rubbed Bronze	3
 <ul style="list-style-type: none"> • description: finished handle cap kit • language: english version only 		221672	22.80	Chrome	12
		221672BN	30.30	Brushed Nickel	12
		221672ORB	33.50	Oil Rubbed Bronze	12
 <ul style="list-style-type: none"> • description: finish diverter handle cap kit 		221772	14.65	Chrome	12
		221772BN	19.45	Brushed Nickel	12
	NEW!	221772ORB	21.40	Oil Rubbed Bronze	12

WEYMOUTH®

HOW TO ORDER A COMPLETE FLOORMOUNT TUB FILLER FAUCET

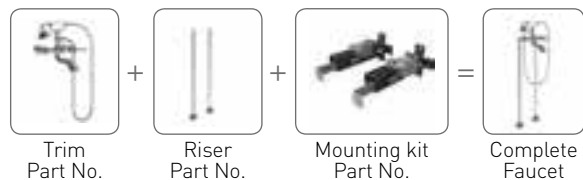







NOTES

 Moen® **M•PACT®** Common Valve System
DURALAST® Duralast® Cartridge

S22105 and S22110 can be installed as a wallmount tub filler.

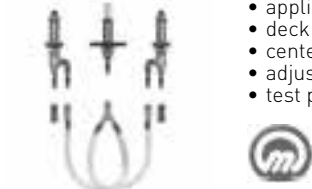
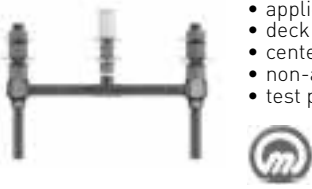
WEYMOUTH® Roman Tub

All Brushed Nickel and Polished Nickel faucet components feature the LifeShine® Non-Tarnish Finish.

	MODEL NUMBER	LIST PRICE	FINISH/ CONNECTION	CASE QTY
TWO-HANDLE ROMAN TUB				
 <ul style="list-style-type: none"> • application: three hole • spout reach: 8.10" • valve: sold separately 	PREMIUM			
	TS22101	779.00	Chrome	3
	TS22101BN	1,102.60	Brushed Nickel	3
	TS22101NL	1,102.60	Polished Nickel	3
	TS22101ORB	1,189.55	Oil Rubbed Bronze	3
 <ul style="list-style-type: none"> • application: three hole • spout reach: 8.10" • valve: sold separately 	PREMIUM			
	TS22103	779.00	Chrome	3
	TS22103BN	1,102.60	Brushed Nickel	3
	TS22103NL	1,102.60	Polished Nickel	3
	TS22103ORB	1,189.55	Oil Rubbed Bronze	3
 <ul style="list-style-type: none"> • application: three hole • deck thickness: 1/8" to 3-3/8" rough-in deck • center dimensions: adjustable • adjustable spout shank: included • test plug: included 	4792	143.70	1/2" CC	6
 <ul style="list-style-type: none"> • application: three hole • deck thickness: 1/8" to 2-3/4" rough-in deck • center dimensions: 10" - 24" center • adjustable spout shank: included • test plug: included 	4793	162.70	1/2" CPVC, Crimp ring PEX	6
	4794	155.15	1/2" Crimp ring PEX, Cold Expansion PEX	6
 <ul style="list-style-type: none"> • application: three hole • deck thickness: 1/8" to 1-7/8" rough-in deck • center dimensions: 10" center • non-adjustable spout shank: included • test plug: included 	4796	135.35	1/2" CC	6
	4797	138.00	1/2" CPVC, Crimp ring PEX	6
	4798	138.00	1/2" Crimp ring PEX, Cold Expansion PEX	6
 <ul style="list-style-type: none"> • description: high flow thermostatic mixing valve for roman tubs • ports: three • ASSE standard 1070: yes • flow rate: 12.0 gpm (45.4 L/min) max. 	104465	173.00	1/2" CC	12
	104466	173.00	1/2" IPS	12
 <ul style="list-style-type: none"> • description: PEX transition fittings (2) and clips • connections: adapts standard 1/2" PEX barb to 1/2" PEX cold expansion 	140715	10.75	1/2" PEX	200
 <ul style="list-style-type: none"> • description: finished handle cap kit • language: english version only 	221672	22.80	Chrome	12
	221672BN	30.30	Brushed Nickel	12
	221672NL	30.30	Polished Nickel	12
	221672ORB	33.50	Oil Rubbed Bronze	12

HOW TO ORDER A COMPLETE ROMAN TUB FAUCET

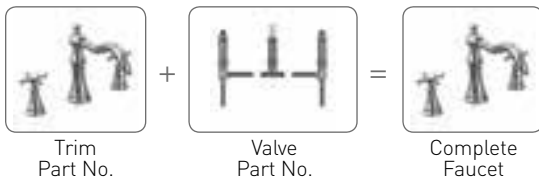

NOTES











 Moen® **M•PACT®** Common Valve System

Thermostatic Mixing Valve service kits, see page 498.

WEYMOUTH®

WEYMOUTH® Roman Tub

All Brushed Nickel and Polished Nickel faucet components feature the LifeShine® Non-Tarnish Finish.

		MODEL NUMBER	LIST PRICE	FINISH/ CONNECTION	CASE QTY
TWO-HANDLE ROMAN TUB WITH HANDSHOWER					
 <ul style="list-style-type: none"> • application: four hole • showerhead type: handshower • handshower flow rate: 2.0 transitioning to 1.75 gpm • spray functions: one-function • spout reach: 8.10" • valve: sold separately 	PREMIUM	TS21102	1,187.65	Chrome	3
	TS21102BN	2,067.35	Brushed Nickel	3	
	TS21102NL	2,067.35	Polished Nickel	3	
	TS21102ORB	2,230.45	Oil Rubbed Bronze	3	
 <ul style="list-style-type: none"> • application: four hole • showerhead type: handshower • handshower flow rate: 2.0 transitioning to 1.75 gpm • spray functions: one-function • spout reach: 8.10" • valve: sold separately 	PREMIUM	TS21104	1,187.65	Chrome	3
	TS21104BN	2,067.35	Brushed Nickel	3	
	TS21104NL	2,067.35	Polished Nickel	3	
	TS21104ORB	2,230.45	Oil Rubbed Bronze	3	
 <ul style="list-style-type: none"> • application: four hole • deck thickness: 1/8" to 2-5/8" rough-in deck • center dimensions: adjustable • non-adjustable spout shank: included • test plug: included 	9792		323.75	1/2" CC	6
 <ul style="list-style-type: none"> • application: four hole • deck thickness: 1/8" to 2-5/8" rough-in deck • center dimensions: 10" - 24" center • non-adjustable spout shank: included • test plug: included 	9793		331.35	1/2" CPVC, Crimp ring PEX	6
 <ul style="list-style-type: none"> • description: high flow thermostatic mixing valve for roman tubs • ports: three • ASSE standard 1070: yes • flow rate: 12.0 gpm (45.4 L/min) max. 	104465		173.00	1/2" CC	12
	104466		173.00	1/2" IPS	12
 <ul style="list-style-type: none"> • description: PEX transition fittings (2) and clips • connections: adapts standard 1/2" PEX barb to 1/2" PEX cold expansion 	140715		10.75	1/2" PEX	200
 <ul style="list-style-type: none"> • description: finished handle cap kit • language: english version only 	221672		22.80	Chrome	12
	221672BN		30.30	Brushed Nickel	12
	221672NL		30.30	Polished Nickel	12
	221672ORB		33.50	Oil Rubbed Bronze	12

WEYMOUTH®

HOW TO ORDER A COMPLETE ROMAN TUB FAUCET

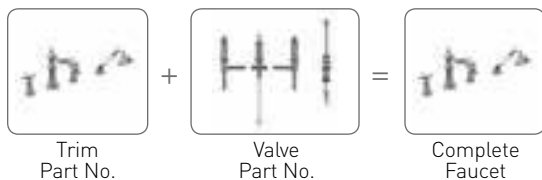





NOTES





 Moen® **M•PACT®** Common Valve System

Thermostatic Mixing Valve service kits, see page 498.

WEYMOUTH® 3/4" Thermostatic Showering

All Brushed Nickel and Polished Nickel faucet components feature the LifeShine® Non-Tarnish Finish.

	MODEL NUMBER	LIST PRICE	FINISH/ CONNECTION	CASE QTY
EXACTTEMP® VALVE ONLY				
 <ul style="list-style-type: none"> description: temperature control valve trim requires: separate volume control valve valve: sold separately 	PREMIUM			
	TS32110	332.05	Chrome	3
	TS32110BN	488.70	Brushed Nickel	3
	TS32110NL	488.70	Polished Nickel	3
	TS32110ORB	527.15	Oil Rubbed Bronze	3
 <ul style="list-style-type: none"> description: thermostatic rough-in valve ports: four adjustable temp limit stop: included check stops: included 	PREMIUM			
	S3371	508.90	3/4" IPS	6
 <ul style="list-style-type: none"> description: finished handle cap kit language: english version only 	221672	22.80	Chrome	12
	221672BN	30.30	Brushed Nickel	12
	221672NL	30.30	Polished Nickel	12
	221672ORB	33.50	Oil Rubbed Bronze	12

EXACTTEMP® VOLUME CONTROL VALVE ONLY				
 <ul style="list-style-type: none"> valve: sold separately 	PREMIUM			
	TS52104	172.35	Chrome	6
	TS52104BN	238.10	Brushed Nickel	6
	TS52104NL	238.10	Polished Nickel	6
	TS52104ORB	256.75	Oil Rubbed Bronze	6
 <ul style="list-style-type: none"> description: volume control rough-in valve includes: volume control 	PREMIUM			
	S3600	129.35	3/4" IPS	12

HOW TO ORDER AN EXACTTEMP® VALVE

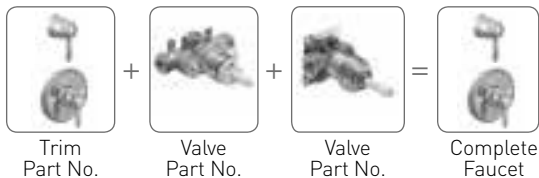









NOTES

 Moen® **M•PACT®** Common Valve System



WEYMOUTH® Transfer Valve Shower Spa Components

All Brushed Nickel and Polished Nickel faucet components feature the LifeShine® Non-Tarnish Finish.

		MODEL NUMBER	LIST PRICE	FINISH/ CONNECTION	CASE QTY
3 INDEPENDENT FUNCTION TRANSFER VALVE ONLY					
 <ul style="list-style-type: none"> • use with 3362 transfer valve • valve: sold separately 		PREMIUM			
		TS32206	249.95	Chrome	12
		TS32206BN	294.70	Brushed Nickel	12
		TS32206NL	294.70	Polished Nickel	12
		TS32206ORB	317.95	Oil Rubbed Bronze	12
 <ul style="list-style-type: none"> • ports: four • type of function: three independent functions • must be used with: Posi-Temp or Moentrol valve 		3362	192.60	1/2" CC	6
	2/3 FUNCTION TRANSFER VALVE ONLY				
 <ul style="list-style-type: none"> • use with 3372 or 3375 transfer valve • valve: sold separately 		PREMIUM			
		TS32205	249.95	Chrome	6
		TS32205BN	294.70	Brushed Nickel	6
		TS32205NL	294.70	Polished Nickel	6
		TS32205ORB	317.95	Oil Rubbed Bronze	6
 <ul style="list-style-type: none"> • type of function: two independent one shared • must be used with: Posi-Temp® or Moentrol® valve 		3372	172.00	1/2" CC	12
	 <ul style="list-style-type: none"> • type of function: two independent functions • must be used with: Posi-Temp® or Moentrol® valve 		3375	172.00	1/2" CC
 <ul style="list-style-type: none"> • description: finished arrow cap kit 			221673	15.45	Chrome
	221673BN	20.60	Brushed Nickel	12	
	221673NL	20.60	Polished Nickel	12	
	221673ORB	22.75	Oil Rubbed Bronze	12	

WEYMOUTH®

HOW TO ORDER A COMPLETE TRANSFER VALVE















NOTES

 Moen® **M•PACT**® Common Valve System
DURALAST Duralast® Cartridge

WEYMOUTH® Moentrol® Showering

All Brushed Nickel and Polished Nickel faucet components feature the LifeShine® Non-Tarnish Finish.

		MODEL NUMBER	LIST PRICE	FINISH/ CONNECTION	CASE QTY
MOENTROL® TUB/SHOWER					
 <ul style="list-style-type: none"> • showerhead type: showerhead sold separately • spout length: 6 3/4" • spout connection type: slip fit • tub spout type: diverter • valve: sold separately 	PREMIUM	TS33103NH	514.00	Chrome	3
	TS33103NHBN	721.15	Brushed Nickel	3	
	TS33103NHNL	721.15	Polished Nickel	3	
	TS33103NHORB	778.05	Oil Rubbed Bronze	3	
 <ul style="list-style-type: none"> • description: pressure balanced valve with volume control • ports: four • adjustable temp limit stop: included • checks: included • includes: volume control 	3510		164.10	1/2" IPS	6
	3520		164.10	1/2" CC	6
 <ul style="list-style-type: none"> • description: pressure balanced valve with volume control • ports: four • adjustable temp limit stop: included • check stops: included • includes: volume control 	3570 ♦		195.50	1/2" CC	6

MOENTROL® SHOWER ONLY					
 <ul style="list-style-type: none"> • showerhead type: showerhead sold separately • valve: sold separately 	PREMIUM	TS33102NH	456.75	Chrome	3
	TS33102NHBN	666.75	Brushed Nickel	3	
	TS33102NHNL	666.75	Polished Nickel	3	
	TS33102NHORB	719.30	Oil Rubbed Bronze	3	
 <ul style="list-style-type: none"> • description: pressure balanced valve with volume control • ports: four • adjustable temp limit stop: included • checks: included • includes: volume control 	3510		164.10	1/2" IPS	6
	3520		164.10	1/2" CC	6
 <ul style="list-style-type: none"> • description: pressure balanced valve with volume control • ports: four • adjustable temp limit stop: included • check stops: included • includes: volume control 	3570 ♦		195.50	1/2" CC	6

HOW TO ORDER A COMPLETE TUB/SHOWER FAUCET









NOTES

 Moen® **M•PACT**® Common Valve System

WEYMOUTH® Moentrol® Showering

All Brushed Nickel and Polished Nickel faucet components feature the LifeShine® Non-Tarnish Finish.

		MODEL NUMBER	LIST PRICE	FINISH/ CONNECTION	CASE QTY
MOENTROL® VALVE ONLY					
 <ul style="list-style-type: none"> valve: sold separately  	PREMIUM				
		TS33101	291.00	Chrome	3
		TS33101BN	410.30	Brushed Nickel	3
		TS33101NL	410.30	Polished Nickel	3
		TS33101ORB	443.10	Oil Rubbed Bronze	3
  <ul style="list-style-type: none"> description: pressure balanced valve with volume control ports: four adjustable temp limit stop: included checks: included includes: volume control 		3510	164.10	1/2" IPS	6
		3520	164.10	1/2" CC	6
  <ul style="list-style-type: none"> description: pressure balanced valve with volume control ports: four adjustable temp limit stop: included check stops: included includes: volume control 		3570 ♦	195.50	1/2" CC	6

WEYMOUTH®

HOW TO ORDER A COMPLETE VALVE















NOTES

Moentrol Moen® M•PACT® Common Valve System

WEYMOUTH® Posi-Temp® Showering

All Brushed Nickel and Polished Nickel faucet components feature the LifeShine® Non-Tarnish Finish.

	MODEL NUMBER	LIST PRICE	FINISH/ CONNECTION	CASE QTY
POSI-TEMP® TUB/SHOWER				
 <ul style="list-style-type: none"> • showerhead functions: two-function • showerhead type: rainshower • showerhead size: 9" diameter spray head • showerhead flow rate: 2.5 gpm (9.5 L/min) max. • spout length: 6 3/4" • spout connection type: slip fit • tub spout type: diverter • valve: sold separately   IMMERSION®	PREMIUM			
	TS32104	638.55	Chrome	3
	TS32104BN	895.85	Brushed Nickel	3
	TS32104NL	895.85	Polished Nickel	3
	TS32104ORB	966.55	Oil Rubbed Bronze	3
 <ul style="list-style-type: none"> • showerhead functions: two-function • showerhead type: eco-performance rainshower • showerhead size: 9" diameter spray head • showerhead flow rate: 2.0 transitioning to 1.75 gpm • spout length: 6 3/4" • spout connection type: slip fit • tub spout type: diverter • valve: sold separately    IMMERSION®	PREMIUM			
	TS32104EP	638.55	Chrome	3
	TS32104EPBN	895.85	Brushed Nickel	3
	TS32104EPNL	895.85	Polished Nickel	3
	TS32104EPORB	966.55	Oil Rubbed Bronze	3
 <ul style="list-style-type: none"> • description: pressure balanced cycling valve • ports: four • adjustable temp limit stop: included 	2510 ♦	119.75	1/2" IPS	6
	2520 ♦	119.75	1/2" CC	6
	2580 ♦	119.75	1/2" Crimp ring PEX	6
 <ul style="list-style-type: none"> • description: pressure balanced cycling valve • ports: four • adjustable temp limit stop: included • quarter turn stops: included 	2570 ♦	145.35	1/2" CC	6
	2590 ♦	145.35	1/2" IPS	6
 <ul style="list-style-type: none"> • description: finished handle cap kit • language: english version only 	221672	22.80	Chrome	12
	221672BN	30.30	Brushed Nickel	12
	221672NL	30.30	Polished Nickel	12
	221672ORB	33.50	Oil Rubbed Bronze	12
 <ul style="list-style-type: none"> • description: finished arrow cap kit 	221673	15.45	Chrome	12
	221673BN	20.60	Brushed Nickel	12
	221673NL	20.60	Polished Nickel	12
	221673ORB	22.75	Oil Rubbed Bronze	12

HOW TO ORDER A COMPLETE TUB/SHOWER FAUCET

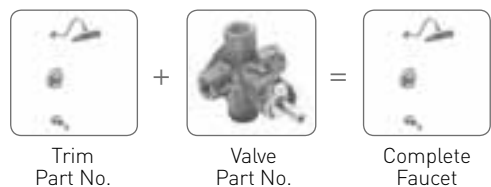















NOTES

- ♦ Also available in bulk pack. See page 435.
- Moeno **M•PACT®** Common Valve System
- IMMERSION®** Immersion® Rainshower

WEYMOUTH®

WEYMOUTH® Posi-Temp® Showering

All Brushed Nickel and Polished Nickel faucet components feature the LifeShine® Non-Tarnish Finish.

		MODEL NUMBER	LIST PRICE	FINISH/ CONNECTION	CASE QTY
POSI-TEMP® SHOWER ONLY					
 <ul style="list-style-type: none"> • showerhead functions: two-function • showerhead type: rainshower • showerhead size: 9" diameter spray head • showerhead flow rate: 2.5 gpm (9.5 L/min) max. • valve: sold separately   	PREMIUM				
	TS32102	523.60	Chrome	3	
	TS32102BN	764.35	Brushed Nickel	3	
	TS32102NL	764.35	Polished Nickel	3	
	TS32102ORB	824.55	Oil Rubbed Bronze	3	
 <ul style="list-style-type: none"> • showerhead functions: two-function • showerhead type: eco-performance rainshower • showerhead size: 9" diameter spray head • showerhead flow rate: 2.0 transitioning to 1.75 gpm • valve: sold separately    	PREMIUM				
	TS32102EP	523.60	Chrome	3	
	TS32102EPBN	764.35	Brushed Nickel	3	
	TS32102EPNL	764.35	Polished Nickel	3	
	TS32102EPORB	824.55	Oil Rubbed Bronze	3	
 <ul style="list-style-type: none"> • description: pressure balanced cycling valve • ports: four • adjustable temp limit stop: included 	2510 ♦	119.75	1/2" IPS	6	
	2520 ♦	119.75	1/2" CC	6	
	2580 ♦	119.75	1/2" Crimp ring PEX	6	
 <ul style="list-style-type: none"> • description: pressure balanced cycling valve • ports: four • adjustable temp limit stop: included • quarter turn stops: included 	2570 ♦	145.35	1/2" CC	6	
	2590 ♦	145.35	1/2" IPS	6	
 <ul style="list-style-type: none"> • description: finished handle cap kit • language: english version only 	221672	22.80	Chrome	12	
	221672BN	30.30	Brushed Nickel	12	
	221672NL	30.30	Polished Nickel	12	
	221672ORB	33.50	Oil Rubbed Bronze	12	
 <ul style="list-style-type: none"> • description: finished arrow cap kit 	221673	15.45	Chrome	12	
	221673BN	20.60	Brushed Nickel	12	
	221673NL	20.60	Polished Nickel	12	
	221673ORB	22.75	Oil Rubbed Bronze	12	

WEYMOUTH®

HOW TO ORDER A COMPLETE SHOWER FAUCET

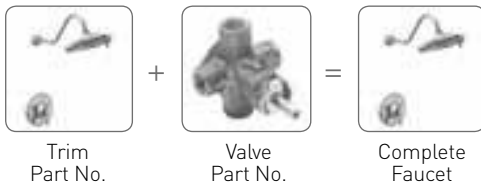









NOTES

- ♦ Also available in bulk pack. See page 435.
- Moeno **M•PACT**® Common Valve System
- IMMERSION** Immersion® Rainshower

WEYMOUTH® Posi-Temp® Showering

All Brushed Nickel and Polished Nickel faucet components feature the LifeShine® Non-Tarnish Finish.

		MODEL NUMBER	LIST PRICE	FINISH/ CONNECTION	CASE QTY
POSI-TEMP® VALVE ONLY					
 <ul style="list-style-type: none"> valve: sold separately 	PREMIUM				
		TS3210	274.60	Chrome	3
		TS3210BN	388.35	Brushed Nickel	3
		TS3210NL	388.35	Polished Nickel	3
		TS3210ORB	419.10	Oil Rubbed Bronze	3
  <ul style="list-style-type: none"> description: pressure balanced cycling valve ports: four adjustable temp limit stop: included 	2510 ◆	119.75	1/2" IPS	6	
	2520 ◆	119.75	1/2" CC	6	
	2580 ◆	119.75	1/2" Crimp ring PEX	6	
  <ul style="list-style-type: none"> description: pressure balanced cycling valve ports: four adjustable temp limit stop: included quarter turn stops: included 	2570 ◆	145.35	1/2" CC	6	
	2590 ◆	145.35	1/2" IPS	6	
 <ul style="list-style-type: none"> description: finished handle cap kit language: english version only 	221672	22.80	Chrome	12	
	221672BN	30.30	Brushed Nickel	12	
	221672NL	30.30	Polished Nickel	12	
	221672ORB	33.50	Oil Rubbed Bronze	12	
 <ul style="list-style-type: none"> description: finished arrow cap kit 	221673	15.45	Chrome	12	
	221673BN	20.60	Brushed Nickel	12	
	221673NL	20.60	Polished Nickel	12	
	221673ORB	22.75	Oil Rubbed Bronze	12	

HOW TO ORDER A COMPLETE VALVE

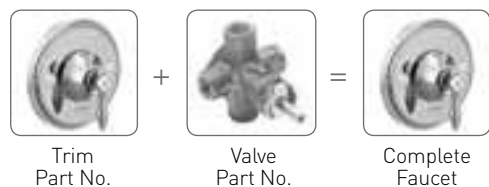

NOTES

- ◆ Also available in bulk pack. See page 435.
- Ⓜ Moen® **M•FACT**® Common Valve System

WEYMOUTH® Perfectly Matched Bath Accessories

Moen® bath accessories CANNOT be combined with Moen faucet parts on a Purchase Order.

Moen makes it easy to coordinate the entire style and look of the bathroom. Our Weymouth® bath accessories perfectly match the style and finish of our Weymouth® faucets. Total coordination of the bath has never been easier.

For more information on ordering Weymouth® bath accessories or other matching Moen® bath accessories, contact Moen Bath Accessory Customer Service at **800-882-0116**, contact your local Moen sales representative, or visit us at **www.moen.com**.

MODEL NUMBER	LIST PRICE EACH	DESCRIPTION	5/8-in. Round Bar	QTY
Chrome (CH)				
YB8401CH	87.10	Tank Lever		24
YB8403CH	79.05	Double Robe Hook		24
YB8405CH	14.60	Drawer Knob		48
YB8407CH	27.25	Drawer Pull		48
^(P) YB8408CH	114.15	Pivoting Paper Holder		6
YB8418CH	128.90	18" Towel Bar		6
YB8424CH	139.10	24" Towel Bar		6
YB8486CH	89.90	Towel Ring		6
Brushed Nickel (BN)				
YB8401BN	99.15	Tank Lever		6
YB8403BN	90.50	Double Robe Hook		24
YB8405BN	16.55	Drawer Knob		48
YB8407BN	29.20	Drawer Pull		48
^(P) YB8408BN	125.15	Pivoting Paper Holder		6
YB8418BN	146.40	18" Towel Bar		6
YB8424BN	157.85	24" Towel Bar		6
YB8486BN	102.60	Towel Ring		6
Polished Nickel (NL)				
YB8401NL	109.05	Tank Lever		24
YB8403NL	99.65	Double Robe Hook		24
YB8405NL	18.15	Drawer Knob		48
YB8407NL	32.05	Drawer Pull		48
^(P) YB8408NL	137.65	Pivoting Paper Holder		6
YB8418NL	161.15	18" Towel Bar		6
YB8424NL	173.60	24" Towel Bar		6
YB8486NL	112.90	Towel Bar		6
Oil Rubbed Bronze (ORB)				
YB8401ORB	109.05	Tank Lever		24
YB8403ORB	99.65	Double Robe Hook		24
YB8405ORB	18.15	Drawer Knob		48
YB8407ORB	32.05	Drawer Pull		48
^(P) YB8408ORB	137.65	Pivoting Paper Holder		6
YB8418ORB	161.15	18" Towel Bar		6
YB8424ORB	173.60	24" Towel Bar		6
YB8486ORB	112.90	Towel Ring		6



YB8401
Tank Lever



YB8403
Double Robe Hook



YB8405
Drawer Knob



YB8407
Drawer Pull



YB8408 ^(P)
Pivoting Paper Holder



YB8418
18" Towel Bar



YB8424
24" Towel Bar



















YB8486
Towel Ring

^(P) Denotes pivoting paper holder

List price is per each (unless otherwise noted). Product can be ordered by case quantity or individually.

ARRIS® Bathroom Faucets

All Brushed Nickel faucet components feature the LifeShine® Non-Tarnish Finish.

	MODEL NUMBER	LIST PRICE	FINISH/ CONNECTION	CASE QTY
ONE-HANDLE BATHROOM FAUCET				
 <ul style="list-style-type: none"> • application: one hole • supply line length: flexible • connection size: 3/8" • connection type: compression • drain assembly type: spring loaded pop-up   DURALAST®	PREMIUM			
	S43001	486.30	Chrome	3
	S43001BN	708.90	Brushed Nickel	3
TWO-HANDLE WIDESPREAD BATHROOM FAUCET				
 <ul style="list-style-type: none"> • application: three hole • center dimensions: 8" - 16" center • drain assembly: metal • drain assembly type: lift rod • valve: sold separately   	PREMIUM			
	TS43002	526.55	Chrome	3
	TS43002BN	814.35	Brushed Nickel	3
 <ul style="list-style-type: none"> • application: three hole • center dimensions: 8" - 16" center • drain assembly: metal • drain assembly type: lift rod  DURALOCK® DURALAST®	9000 ♦	123.55	1/2" IPS	6
TWO-HANDLE WALLMOUNT BATHROOM FAUCET				
 <ul style="list-style-type: none"> • application: three hole • center dimensions: 8" center • drain assembly: 140780 sold separately • valve: sold separately   	PREMIUM			
	TS43003	538.90	Chrome	3
	TS43003BN	812.35	Brushed Nickel	3
 <ul style="list-style-type: none"> • application: three hole • center dimensions: 8" center • drain assembly: 140780 sold separately • includes: mounting brackets 	9700	174.75	1/2" CC	3
 <ul style="list-style-type: none"> • drain assembly: metal • drain assembly type: spring loaded pop-up • drain assembly size: 1-1/4" • drain assembly: 1-1/4" non-overflow 	140780	59.20	Chrome	12
	140780BN	82.60	Brushed Nickel	12



HOW TO ORDER A COMPLETE BATHROOM FAUCET

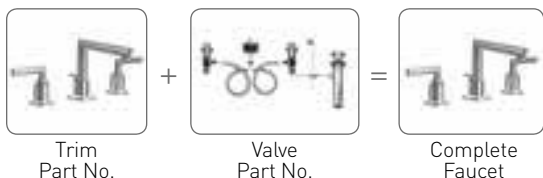







NOTES

- ♦ Also available in bulk pack. See page 435.
- Ⓜ Moen® **M•PACT®** Common Valve System
- DURALOCK®** Duralock® Quick Connections
- DURALAST®** Duralast® Cartridge

Refer to lavatory waste assemblies on page 403.
Refer to specification sheet for critical dimensions for installation.

ARRIS® Tub Fillers

All Brushed Nickel faucet components feature the LifeShine® Non-Tarnish Finish.

		MODEL NUMBER	LIST PRICE	FINISH/ CONNECTION	CASE QTY
WALLMOUNT OR FREESTANDING TUB FILLER					
 <ul style="list-style-type: none"> • application: one hole • showerhead type: handshower • handshower functions: one-function • handshower flow rate: 2.0 transitioning to 1.75 gpm • spout reach: 11.00" • valve: sold separately  	PREMIUM	S93005	1,569.65	Chrome	1
		S93005BN	2,276.00	Brushed Nickel	1
 <ul style="list-style-type: none"> • description: single riser floor joist mounting kit • application: one hole • connection type: npt; CC • quarter turn stops: included 	PREMIUM	TS50100	275.75	1/2" NPT, CC	2
 <ul style="list-style-type: none"> • description: single riser concrete mounting kit • application: one hole • quarter turn stops: included 	PREMIUM	TS50110	234.40	1/2" CC, NPT	2

HOW TO ORDER A COMPLETE FLOORMOUNT TUB FILLER













NOTES

 Moen® **M•PACT®** Common Valve System

ARRIS® Roman Tubs

All Brushed Nickel faucet components feature the LifeShine® Non-Tarnish Finish.

	MODEL NUMBER	LIST PRICE	FINISH/ CONNECTION	CASE QTY
TWO-HANDLE ROMAN TUB				
 <ul style="list-style-type: none"> • application: three hole • spout reach: 8.08" • valve: sold separately 	PREMIUM TS93003	685.80	Chrome	3
	TS93003BN	991.80	Brushed Nickel	3
 <ul style="list-style-type: none"> • application: three hole • deck thickness: 1/8" to 3-3/8" rough-in deck • center dimensions: adjustable • adjustable spout shank: included • test plug: included 	4792	143.70	1/2" CC	6
 <ul style="list-style-type: none"> • application: three hole • deck thickness: 1/8" to 2-3/4" rough-in deck • center dimensions: 10" - 24" center • adjustable spout shank: included • test plug: included 	4793	162.70	1/2" CPVC, Crimp ring PEX	6
	4794	155.15	1/2" Crimp ring PEX, Cold Expansion PEX	6
 <ul style="list-style-type: none"> • application: three hole • deck thickness: 1/8" to 1-7/8" rough-in deck • center dimensions: 10" center • non-adjustable spout shank: included • test plug: included 	4796	135.35	1/2" CC	6
	4797	138.00	1/2" CPVC, Crimp ring PEX	6
	4798	138.00	1/2" Crimp ring PEX, Cold Expansion PEX	6
 <ul style="list-style-type: none"> • description: high flow thermostatic mixing valve for roman tubs • ports: three • ASSE standard 1070: yes • flow rate: 12.0 gpm (45.4 L/min) max. 	104465	173.00	1/2" CC	12
	104466	173.00	1/2" IPS	12
 <ul style="list-style-type: none"> • description: PEX transition fittings (2) and clips • connections: adapts standard 1/2" PEX barb to 1/2" PEX cold expansion 	140715	10.75	1/2" PEX	200

HOW TO ORDER A COMPLETE ROMAN TUB FAUCET

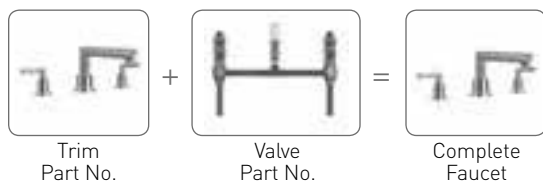









NOTES

 Moen® **M•PACT®** Common Valve System

Thermostatic Mixing Valve service kits, see page 498.

ARRIS® Roman Tubs

All Brushed Nickel faucet components feature the LifeShine® Non-Tarnish Finish.

		MODEL NUMBER	LIST PRICE	FINISH/ CONNECTION	CASE QTY
TWO-HANDLE ROMAN TUB WITH HANDSHOWER					
 <ul style="list-style-type: none"> • application: four hole • showerhead type: handshower • handshower flow rate: 2.0 transitioning to 1.75 gpm • spray functions: one-function • spout reach: 8.08" • valve: sold separately 	PREMIUM	TS93004	1,047.05	Chrome	3
		TS93004BN	1,867.50	Brushed Nickel	3
 <ul style="list-style-type: none"> • application: four hole • deck thickness: 1/8" to 2-5/8" rough-in deck • center dimensions: adjustable • non-adjustable spout shank: included • test plug: included 		9792	323.75	1/2" CC	6
 <ul style="list-style-type: none"> • application: four hole • deck thickness: 1/8" to 2-5/8" rough-in deck • center dimensions: 10" - 24" center • non-adjustable spout shank: included • test plug: included 		9793	331.35	1/2" CPVC, Crimp ring PEX	6
 <ul style="list-style-type: none"> • description: high flow thermostatic mixing valve for roman tubs • ports: three • ASSE standard 1070: yes • flow rate: 12.0 gpm (45.4 L/min) max. 		104465	173.00	1/2" CC	12
		104466	173.00	1/2" IPS	12
 <ul style="list-style-type: none"> • description: PEX transition fittings (2) and clips • connections: adapts standard 1/2" PEX barb to 1/2" PEX cold expansion 		140715	10.75	1/2" PEX	200



HOW TO ORDER A COMPLETE ROMAN TUB FAUCET

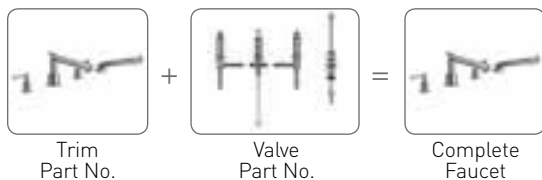











NOTES

 Moen® **M•PACT®** Common Valve System

Thermostatic Mixing Valve service kits, see page 498.

ARRIS® 3/4" Thermostatic Showering

All Brushed Nickel faucet components feature the LifeShine® Non-Tarnish Finish.

	MODEL NUMBER	LIST PRICE	FINISH/ CONNECTION	CASE QTY
EXACTTEMP® VALVE ONLY				
 <ul style="list-style-type: none"> description: temperature control valve trim requires: separate volume control valve valve: sold separately  	PREMIUM			
	TS33002	273.00	Chrome	3
	TS33002BN	409.55	Brushed Nickel	3
 <ul style="list-style-type: none"> description: thermostatic rough-in valve ports: four adjustable temp limit stop: included check stops: included 	PREMIUM			
	S3371	508.90	3/4" IPS	6
EXACTTEMP® VOLUME CONTROL VALVE ONLY				
 <ul style="list-style-type: none"> valve: sold separately  	PREMIUM			
	TS33003	155.95	Chrome	6
	TS33003BN	227.55	Brushed Nickel	6
 <ul style="list-style-type: none"> description: volume control rough-in valve includes: volume control 	PREMIUM			
	S3600		3/4" IPS	12

HOW TO ORDER AN EXACTTEMP® VALVE

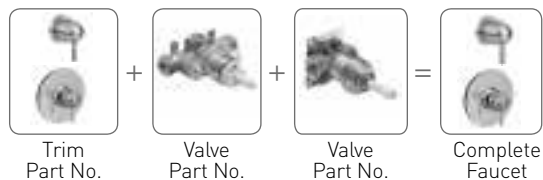

NOTES

 Moen® **M•PACT®** Common Valve System

ARRIS® Transfer Valve Shower Spa Components

All Brushed Nickel faucet components feature the LifeShine® Non-Tarnish Finish.

		MODEL NUMBER	LIST PRICE	FINISH/ CONNECTION	CASE QTY
3 INDEPENDENT FUNCTION TRANSFER VALVE ONLY					
 <ul style="list-style-type: none"> • use with 3362 transfer valve • valve: sold separately 	PREMIUM	TS23006	232.25	Chrome	12
		TS23006BN	287.85	Brushed Nickel	12
 <ul style="list-style-type: none"> • ports: four • type of function: three independent functions • must be used with: Posi-Temp or Moentrol valve 		3362	192.60	1/2" CC	6
2/3 FUNCTION TRANSFER VALVE ONLY					
 <ul style="list-style-type: none"> • use with 3372 or 3375 transfer valve • valve: sold separately 	PREMIUM	TS23005	232.25	Chrome	6
		TS23005BN	287.85	Brushed Nickel	6
 <ul style="list-style-type: none"> • type of function: two independent one shared • must be used with: Posi-Temp® or Moentrol® valve 		3372	172.00	1/2" CC	12
 <ul style="list-style-type: none"> • type of function: two independent functions • must be used with: Posi-Temp® or Moentrol® valve 		3375	172.00	1/2" CC	12

ARRIS®

HOW TO ORDER A COMPLETE VALVE















NOTES

Moentrol® Moen® **M•PACT**® Common Valve System
DURALAST Duralast® Cartridge

ARRIS® Moentrol® Showering

All Brushed Nickel faucet components feature the LifeShine® Non-Tarnish Finish.

		MODEL NUMBER	LIST PRICE	FINISH/ CONNECTION	CASE QTY
MOENTROL® TUB/SHOWER					
 <ul style="list-style-type: none"> • showerhead type: showerhead sold separately • spout length: 6 3/4" • spout connection type: slip fit • tub spout type: diverter • valve: sold separately 	PREMIUM				
		TS32003NH	479.30	Chrome	3
	TS32003NHBN	695.25	Brushed Nickel	3	
 <ul style="list-style-type: none"> • description: pressure balanced valve with volume control • ports: four • adjustable temp limit stop: included • checks: included • includes: volume control 	3510	164.10	1/2" IPS	6	
	3520	164.10	1/2" CC	6	
 <ul style="list-style-type: none"> • description: pressure balanced valve with volume control • ports: four • adjustable temp limit stop: included • check stops: included • includes: volume control 	3570 ♦	195.50	1/2" CC	6	

MOENTROL® SHOWER ONLY					
 <ul style="list-style-type: none"> • showerhead type: showerhead sold separately • valve: sold separately 	PREMIUM				
		TS32002NH	433.85	Chrome	3
	TS32002NHBN	633.60	Brushed Nickel	3	
 <ul style="list-style-type: none"> • description: pressure balanced valve with volume control • ports: four • adjustable temp limit stop: included • checks: included • includes: volume control 	3510	164.10	1/2" IPS	6	
	3520	164.10	1/2" CC	6	
 <ul style="list-style-type: none"> • description: pressure balanced valve with volume control • ports: four • adjustable temp limit stop: included • check stops: included • includes: volume control 	3570 ♦	195.50	1/2" CC	6	

HOW TO ORDER A COMPLETE TUB/SHOWER FAUCET









NOTES

- ♦ Also available in bulk pack. See page 435.
- Ⓜ Moen® **M•PACT**® Common Valve System



ARRIS® Moentrol® Showering

All Brushed Nickel faucet components feature the LifeShine® Non-Tarnish Finish.

		MODEL NUMBER	LIST PRICE	FINISH/ CONNECTION	CASE QTY
MOENTROL® VALVE ONLY					
 <p>NEW!</p> <ul style="list-style-type: none"> valve: sold separately  		PREMIUM			
		TS32001	258.15	Chrome	3
	TS32001BN	384.65	Brushed Nickel	3	
  <ul style="list-style-type: none"> description: pressure balanced valve with volume control ports: four adjustable temp limit stop: included checks: included includes: volume control 	3510	164.10	1/2" IPS	6	
	3520	164.10	1/2" CC	6	
  <ul style="list-style-type: none"> description: pressure balanced valve with volume control ports: four adjustable temp limit stop: included check stops: included includes: volume control 	3570 ♦	195.50	1/2" CC	6	

ARRIS®

HOW TO ORDER A COMPLETE VALVE











NOTES

- ♦ Also available in bulk pack. See page 435.
- Ⓜ Moen® **M•PACT**® Common Valve System

ARRIS® Posi-Temp® Showering

All Brushed Nickel faucet components feature the LifeShine® Non-Tarnish Finish.

		MODEL NUMBER	LIST PRICE	FINISH/ CONNECTION	CASE QTY
POSI-TEMP® TUB/SHOWER					
 <ul style="list-style-type: none"> • showerhead functions: one-function • showerhead type: rainshower • showerhead size: 10" diameter spray head • showerhead flow rate: 2.5 gpm (9.5 L/min) max. • spout length: 6 3/4" • spout connection type: slip fit • tub spout type: diverter • valve: sold separately 		PREMIUM			
		TS22003	595.40	Chrome	3
	TS22003BN	863.65	Brushed Nickel	3	
 <ul style="list-style-type: none"> • showerhead functions: one-function • showerhead type: eco-performance rainshower • showerhead size: 10" diameter spray head • showerhead flow rate: 2.0 transitioning to 1.75 gpm • spout length: 6 3/4" • spout connection type: slip fit • tub spout type: diverter • valve: sold separately 		PREMIUM			
		TS22003EP	595.40	Chrome	3
	TS22003EPBN	863.65	Brushed Nickel	3	
  <ul style="list-style-type: none"> • description: pressure balanced cycling valve • ports: four • adjustable temp limit stop: included 	2510 ♦	119.75	1/2" IPS	6	
	2520 ♦	119.75	1/2" CC	6	
	2580 ♦	119.75	1/2" Crimp ring PEX	6	
  <ul style="list-style-type: none"> • description: pressure balanced cycling valve • ports: four • adjustable temp limit stop: included • quarter turn stops: included 	2570 ♦	145.35	1/2" CC	6	
	2590 ♦	145.35	1/2" IPS	6	

HOW TO ORDER A COMPLETE TUB/SHOWER FAUCET

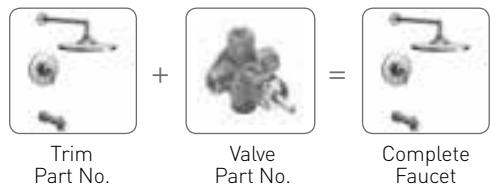











NOTES

- ♦ Also available in bulk pack. See page 435.
-  Moen® **M•PACT®** Common Valve System
-  Immersion® Rainshower

ARRIS® Posi-Temp® Showering

All Brushed Nickel faucet components feature the LifeShine® Non-Tarnish Finish.

		MODEL NUMBER	LIST PRICE	FINISH/ CONNECTION	CASE QTY															
POSI-TEMP® SHOWER ONLY																				
 <ul style="list-style-type: none"> • showerhead functions: one-function • showerhead type: rainshower • showerhead size: 10" diameter spray head • showerhead flow rate: 2.5 gpm (9.5 L/min) max. • valve: sold separately   IMMERSION®	<table border="1"> <thead> <tr> <th colspan="5">PREMIUM</th> </tr> </thead> <tbody> <tr> <td>TS22002</td> <td>497.30</td> <td>Chrome</td> <td></td> <td>3</td> </tr> <tr> <td>TS22002BN</td> <td>726.30</td> <td>Brushed Nickel</td> <td></td> <td>3</td> </tr> </tbody> </table>					PREMIUM					TS22002	497.30	Chrome		3	TS22002BN	726.30	Brushed Nickel		3
	PREMIUM																			
TS22002	497.30	Chrome		3																
TS22002BN	726.30	Brushed Nickel		3																
 <ul style="list-style-type: none"> • showerhead functions: one-function • showerhead type: eco-performance rainshower • showerhead size: 10" diameter spray head • showerhead flow rate: 2.0 transitioning to 1.75 gpm • valve: sold separately    IMMERSION®	<table border="1"> <thead> <tr> <th colspan="5">PREMIUM</th> </tr> </thead> <tbody> <tr> <td>TS22002EP</td> <td>497.30</td> <td>Chrome</td> <td></td> <td>3</td> </tr> <tr> <td>TS22002EPBN</td> <td>726.30</td> <td>Brushed Nickel</td> <td></td> <td>3</td> </tr> </tbody> </table>					PREMIUM					TS22002EP	497.30	Chrome		3	TS22002EPBN	726.30	Brushed Nickel		3
	PREMIUM																			
TS22002EP	497.30	Chrome		3																
TS22002EPBN	726.30	Brushed Nickel		3																
 	<ul style="list-style-type: none"> • description: pressure balanced cycling valve 	2510 ♦	119.75	1/2" IPS	6															
	<ul style="list-style-type: none"> • ports: four 	2520 ♦	119.75	1/2" CC	6															
	<ul style="list-style-type: none"> • adjustable temp limit stop: included 	2580 ♦	119.75	1/2" Crimp ring PEX	6															
 	<ul style="list-style-type: none"> • description: pressure balanced cycling valve 	2570 ♦	145.35	1/2" CC	6															
	<ul style="list-style-type: none"> • ports: four • adjustable temp limit stop: included • quarter turn stops: included 	2590 ♦	145.35	1/2" IPS	6															

ARRIS®

HOW TO ORDER A COMPLETE SHOWER FAUCET

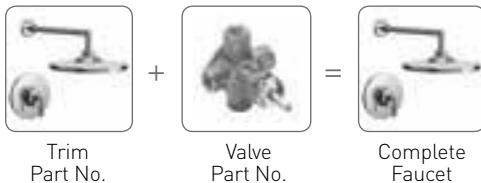







NOTES

- ♦ Also available in bulk pack. See page 435.
- Moën® **M•PACT®** Common Valve System
- IMMERSION®** Immersion® Rainshower

ARRIS® Posi-Temp® Showering

All Brushed Nickel faucet components feature the LifeShine® Non-Tarnish Finish.

		MODEL NUMBER	LIST PRICE	FINISH/ CONNECTION	CASE QTY
POSI-TEMP® VALVE ONLY					
 <ul style="list-style-type: none"> valve: sold separately  		PREMIUM			
		TS22001	255.20	Chrome	3
		TS22001BN	379.50	Brushed Nickel	3
 <ul style="list-style-type: none"> description: pressure balanced cycling valve ports: four adjustable temp limit stop: included 		2510 ◆	119.75	1/2" IPS	6
		2520 ◆	119.75	1/2" CC	6
		2580 ◆	119.75	1/2" Crimp ring PEX	6
 <ul style="list-style-type: none"> description: pressure balanced cycling valve ports: four adjustable temp limit stop: included quarter turn stops: included 		2570 ◆	145.35	1/2" CC	6
		2590 ◆	145.35	1/2" IPS	6

HOW TO ORDER A COMPLETE VALVE



NOTES

- ◆ Also available in bulk pack. See page 435.
- Ⓜ Moen® **M•PACT®** Common Valve System



ARRIS® Perfectly Matched Bath Accessories

Moen® bath accessories CANNOT be combined with Moen® faucet parts on a Purchase Order.

Moen makes it easy to coordinate the entire style and look of the bathroom. Our Arris® bath accessories perfectly match the style and finish of our Arris® faucets. Total coordination of the bath has never been easier.

For more information on ordering Arris® bath accessories or other matching Moen® bath accessories, contact Moen Bath Accessory Customer Service at **800-882-0116**, contact your local Moen sales representative, or visit us at **www.moen.com**.

MODEL NUMBER	LIST PRICE EACH	DESCRIPTION	QTY
1/2-in. Round Bar			
Chrome (CH)			
YB0801CH	76.85	Tank Lever	24
YB0803CH	73.80	Double Robe Hook	24
P YB0808CH	105.05	Pivoting Paper Holder	6
YB0818CH	121.60	18" Towel Bar	6
YB0824CH	131.25	24" Towel Bar	6
YB0886CH	84.90	Towel Ring	6
YB0892CH	211.75	5x Magnifying Mirror	3
Brushed Nickel (BN)			
YB0801BN	93.35	Tank Lever	24
YB0803BN	81.00	Double Robe Hook	24
P YB0808BN	115.55	Pivoting Paper Holder	6
YB0818BN	133.70	18" Towel Bar	6
YB0824BN	144.60	24" Towel Bar	6
YB0886BN	93.25	Towel Ring	6
YB0892BN	242.00	5x Magnifying Mirror	3



YB0801 Tank Lever



YB0803 Double Robe Hook



YB0808 **P** Pivoting Paper Holder



YB0818 18" Towel Bar



YB0824 24" Towel Bar



YB0886 Towel Ring

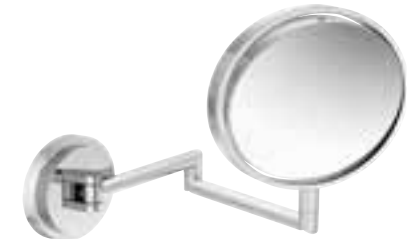

YB0892 Wallmount 5X Magnifying Mirror



YG0824 24" length Designer Grab Bar

GRAB BARS

PERFECTLY MATCHED to Moen® Arris® faucets and bath accessories. ADA-compliant.

SecureMount™ Grab Bars are manufactured with an innovative flange design that makes it easy to connect to the stud at multiple points. Tested to withstand 500 lb. To install grab bars securely without studs, use SecureMount™ Anchors. Sold separately.

MODEL NUMBER	LIST PRICE EACH	DESCRIPTION	QTY
1-1/4" • Chrome (CH)			
YG0812CH	138.45	12" Designer Grab Bar	6
YG0818CH	144.65	18" Designer Grab Bar	6
YG0824CH	151.15	24" Designer Grab Bar	6
YG0836CH	172.10	36" Designer Grab Bar	6
YG0842CH	240.85	42" Designer Grab Bar	6
1-1/4" • Brushed Nickel (BN)			
YG0812BN	149.65	12" Designer Grab Bar	6
YG0818BN	156.80	18" Designer Grab Bar	6
YG0824BN	169.25	24" Designer Grab Bar	6
YG0836BN	190.60	36" Designer Grab Bar	6
YG0842BN	266.75	42" Designer Grab Bar	3











P Denotes pivoting paper holder

Complies with Americans with Disabilities Act (ADA) specifications. SecureMount™ Grab Bars are tested to withstand 500 lb. pull when securely installed per instructions.

List price is per each (unless otherwise noted). Product can be ordered by case quantity or individually.

WATERHILL® Bathroom Faucets

All Brushed Nickel and Polished Nickel faucet components feature the LifeShine® Non-Tarnish Finish.

	MODEL NUMBER	LIST PRICE	FINISH/ CONNECTION	CASE QTY
ONE-HANDLE BATHROOM FAUCET				
 <ul style="list-style-type: none"> • application: one or three hole • supply line length: flexible • connection size: 3/8" • connection type: compression • deckplate: included • drain assembly: metal • drain assembly type: lift rod   DURALAST®	PREMIUM			
	S411	464.50	Chrome	3
	S411BN	711.75	Brushed Nickel	3
	S411NL	711.75	Polished Nickel	3
	S411ORB	767.75	Oil Rubbed Bronze	3
 <ul style="list-style-type: none"> • description: vessel extension kit for s411 series • includes: 3" extensions • includes: grid drain cover • includes: parts to convert to grid drain 	PREMIUM			
	S115	140.25	Chrome	6
	S115BN	231.65	Brushed Nickel	6
	S115NL	231.65	Polished Nickel	6
	S115ORB	254.80	Oil Rubbed Bronze	6
TWO-HANDLE WIDESPREAD BATHROOM FAUCET				
 <ul style="list-style-type: none"> • application: three hole • center dimensions: 8" - 16" center • drain assembly: metal • drain assembly type: lift rod • valve: sold separately   	PREMIUM			
	TS418	547.25	Chrome	3
	TS418BN	830.30	Brushed Nickel	3
	TS418NL	830.30	Polished Nickel	3
	TS418ORB	895.85	Oil Rubbed Bronze	3
  DURALOCK® DURALAST®	9000 ♦	123.55	1/2" IPS	6

HOW TO ORDER A COMPLETE BATHROOM FAUCET

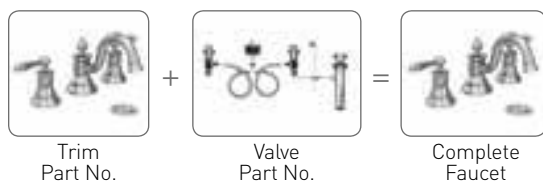









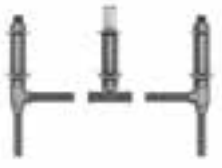

NOTES

- ♦ Also available in bulk pack. See page 435.
- Ⓜ Moen® **M•PACT®** Common Valve System
- DURALOCK®** Duralock® Quick Connections
- DURALAST®** Duralast® Cartridge

Refer to lavatory waste assemblies on page 403
Refer to specification sheet for critical dimensions for installation.

WATERHILL® Roman Tub

All Brushed Nickel and Polished Nickel faucet components feature the LifeShine® Non-Tarnish Finish.

		MODEL NUMBER	LIST PRICE	FINISH/ CONNECTION	CASE QTY																					
TWO-HANDLE ROMAN TUB																										
 <ul style="list-style-type: none"> • application: three hole • spout reach: 8.86" • valve: sold separately 	<table border="1"> <thead> <tr> <th colspan="5">PREMIUM</th> </tr> </thead> <tbody> <tr> <td>TS214</td> <td>712.70</td> <td>Chrome</td> <td>3</td> </tr> <tr> <td>TS214BN</td> <td>1,011.30</td> <td>Brushed Nickel</td> <td>3</td> </tr> <tr> <td>TS214NL</td> <td>1,011.30</td> <td>Polished Nickel</td> <td>3</td> </tr> <tr> <td>TS214ORB</td> <td>1,091.20</td> <td>Oil Rubbed Bronze</td> <td>3</td> </tr> </tbody> </table>					PREMIUM					TS214	712.70	Chrome	3	TS214BN	1,011.30	Brushed Nickel	3	TS214NL	1,011.30	Polished Nickel	3	TS214ORB	1,091.20	Oil Rubbed Bronze	3
	PREMIUM																									
	TS214	712.70	Chrome	3																						
	TS214BN	1,011.30	Brushed Nickel	3																						
	TS214NL	1,011.30	Polished Nickel	3																						
TS214ORB	1,091.20	Oil Rubbed Bronze	3																							
 <ul style="list-style-type: none"> • application: three hole • deck thickness: 1/8" to 3-3/8" rough-in deck • center dimensions: adjustable • adjustable spout shank: included • test plug: included 	4792	143.70	1/2" CC	6																						
 <ul style="list-style-type: none"> • application: three hole • deck thickness: 1/8" to 2-3/4" rough-in deck • center dimensions: 10" - 24" center • adjustable spout shank: included • test plug: included 	4793 4794	162.70 155.15	1/2" CPVC, Crimp ring PEX 1/2" Crimp ring PEX, Cold Expansion PEX	6 6																						
 <ul style="list-style-type: none"> • application: three hole • deck thickness: 1/8" to 1-7/8" rough-in deck • center dimensions: 10" center • non-adjustable spout shank: included • test plug: included 	4796 4797 4798	135.35 138.00 138.00	1/2" CC 1/2" CPVC, Crimp ring PEX 1/2" Crimp ring PEX, Cold Expansion PEX	6 6 6																						
 <ul style="list-style-type: none"> • description: high flow thermostatic mixing valve for roman tubs • ports: three • ASSE standard 1070: yes • flow rate: 12.0 gpm (45.4 L/min) max. 	104465 104466	173.00 173.00	1/2" CC 1/2" IPS	12 12																						
 <ul style="list-style-type: none"> • description: PEX transition fittings (2) and clips • connections: adapts standard 1/2" PEX barb to 1/2" PEX cold expansion 	140715	10.75	1/2" PEX	200																						

WATERHILL®

HOW TO ORDER A COMPLETE ROMAN TUB FAUCET

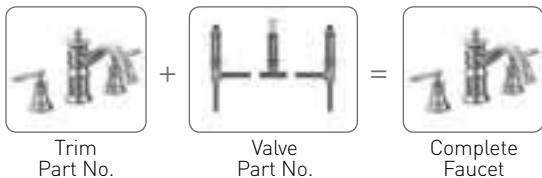









NOTES

 Moen® **M•PACT®** Common Valve System

Thermostatic Mixing Valve service kits, see page 498.

WATERHILL® 3/4" Thermostatic Showering

All Brushed Nickel and Polished Nickel faucet components feature the LifeShine® Non-Tarnish Finish.

	MODEL NUMBER	LIST PRICE	FINISH/ CONNECTION	CASE QTY
EXACTTEMP® VALVE ONLY				
 <ul style="list-style-type: none"> • description: temperature control valve trim • requires: separate volume control valve • valve: sold separately 	PREMIUM			
	TS3110	265.45	Chrome	3
	TS3110BN	390.75	Brushed Nickel	3
	TS3110NL	390.75	Polished Nickel	3
	TS3110ORB	421.60	Oil Rubbed Bronze	3
 <ul style="list-style-type: none"> • description: thermostatic rough-in valve • ports: four • adjustable temp limit stop: included • check stops: included 	PREMIUM			
	S3371	508.90	3/4" IPS	6
EXACTTEMP® VOLUME CONTROL VALVE ONLY				
 <ul style="list-style-type: none"> • valve: sold separately 	PREMIUM			
	TS514	151.70	Chrome	6
	TS514BN	217.10	Brushed Nickel	6
	TS514NL	217.10	Polished Nickel	6
	TS514ORB	234.30	Oil Rubbed Bronze	6
 <ul style="list-style-type: none"> • description: volume control rough-in valve • includes: volume control 	PREMIUM			
	S3600	129.35	3/4" IPS	12

HOW TO ORDER AN EXACTTEMP® VALVE

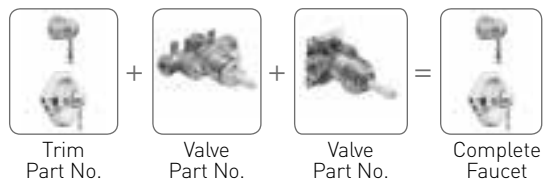







NOTES

 Moen® **M•PACT®** Common Valve System

WATERHILL® Transfer Valve Shower Spa Components

All Brushed Nickel and Polished Nickel faucet components feature the LifeShine® Non-Tarnish Finish.

		MODEL NUMBER	LIST PRICE	FINISH/ CONNECTION	CASE QTY
2/3 FUNCTION TRANSFER VALVE ONLY					
 <ul style="list-style-type: none"> • use with 3372 or 3375 transfer valve • valve: sold separately  	PREMIUM				
	TS325	223.35	Chrome	6	
	TS325BN	271.55	Brushed Nickel	6	
	TS325NL	271.55	Polished Nickel	6	
	TS325ORB	293.00	Oil Rubbed Bronze	6	
	TS325WR	293.00	Wrought Iron	6	
 <ul style="list-style-type: none"> • type of function: two independent one shared • must be used with: Posi-Temp® or Moentrol® valve 	3372	172.00	1/2" CC	12	
	 <ul style="list-style-type: none"> • type of function: two independent functions • must be used with: Posi-Temp® or Moentrol® valve 	3375	172.00	1/2" CC	12



HOW TO ORDER A COMPLETE TRANSFER VALVE

















NOTES

 Moen® **M•PACT®** Common Valve System

WATERHILL® Posi-Temp® Showering

All Brushed Nickel and Polished Nickel faucet components feature the LifeShine® Non-Tarnish Finish.

		MODEL NUMBER	LIST PRICE	FINISH/ CONNECTION	CASE QTY
POSI-TEMP® TUB/SHOWER					
 <ul style="list-style-type: none"> • showerhead functions: one-function • showerhead type: rainshower • showerhead size: 10" diameter spray head • showerhead flow rate: 2.5 gpm (9.5 L/min) max. • spout length: 6 3/4" • spout connection type: slip fit • tub spout type: diverter • valve: sold separately   IMMERSION®	PREMIUM	TS314	579.10	Chrome	3
	TS314BN	824.05	Brushed Nickel	3	
	TS314NL	824.05	Polished Nickel	3	
	TS314ORB	889.00	Oil Rubbed Bronze	3	
 <ul style="list-style-type: none"> • description: pressure balanced cycling valve • ports: four • adjustable temp limit stop: included 		2510 ◆	119.75	1/2" IPS	6
		2520 ◆	119.75	1/2" CC	6
		2580 ◆	119.75	1/2" Crimp ring PEX	6
 <ul style="list-style-type: none"> • description: pressure balanced cycling valve • ports: four • adjustable temp limit stop: included • quarter turn stops: included 		2570 ◆	145.35	1/2" CC	6
		2590 ◆	145.35	1/2" IPS	6

POSI-TEMP® SHOWER ONLY					
 <ul style="list-style-type: none"> • showerhead functions: one-function • showerhead type: rainshower • showerhead size: 10" diameter spray head • showerhead flow rate: 2.5 gpm (9.5 L/min) max. • valve: sold separately   IMMERSION®	PREMIUM	TS312	483.60	Chrome	3
	TS312BN	692.90	Brushed Nickel	3	
	TS312NL	692.90	Polished Nickel	3	
	TS312ORB	747.60	Oil Rubbed Bronze	3	
 <ul style="list-style-type: none"> • description: pressure balanced cycling valve • ports: four • adjustable temp limit stop: included 		2510 ◆	119.75	1/2" IPS	6
		2520 ◆	119.75	1/2" CC	6
		2580 ◆	119.75	1/2" Crimp ring PEX	6
 <ul style="list-style-type: none"> • description: pressure balanced cycling valve • ports: four • adjustable temp limit stop: included • quarter turn stops: included 		2570 ◆	145.35	1/2" CC	6
		2590 ◆	145.35	1/2" IPS	6

HOW TO ORDER A COMPLETE SHOWER FAUCET

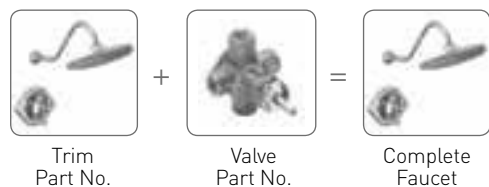







NOTES

- ◆ Also available in bulk pack. See page 435.
- Ⓜ Moen® **M•PACT®** Common Valve System
- IMMERSION®** Immersion® Rainshower



WATERHILL® Posi-Temp® Showering

All Brushed Nickel and Polished Nickel faucet components feature the LifeShine® Non-Tarnish Finish.

		MODEL NUMBER	LIST PRICE	FINISH/ CONNECTION	CASE QTY
POSI-TEMP® VALVE ONLY					
 <ul style="list-style-type: none"> valve: sold separately  	PREMIUM				
		TS310	248.15	Chrome	3
		TS310BN	362.10	Brushed Nickel	3
		TS310NL	362.10	Polished Nickel	3
		TS310ORB	390.70	Oil Rubbed Bronze	3
 <ul style="list-style-type: none"> description: pressure balanced cycling valve ports: four adjustable temp limit stop: included 		2510 ◆	119.75	1/2" IPS	6
		2520 ◆	119.75	1/2" CC	6
		2580 ◆	119.75	1/2" Crimp ring PEX	6
 <ul style="list-style-type: none"> description: pressure balanced cycling valve ports: four adjustable temp limit stop: included quarter turn stops: included 		2570 ◆	145.35	1/2" CC	6
		2590 ◆	145.35	1/2" IPS	6

HOW TO ORDER A COMPLETE VALVE



NOTES

- ◆ Also available in bulk pack. See page 435.
- Ⓜ Moen® **M•PACT**® Common Valve System

WATERHILL® Perfectly Matched Bath Accessories

Moen® bath accessories CANNOT be combined with Moen® faucet parts on a Purchase Order.

Moen makes it easy to coordinate the entire style and look of the bathroom. Our Waterhill® bath accessories perfectly match the style and finish of our Waterhill® faucets. Total coordination of the bath has never been easier.

For more information on ordering Waterhill® bath accessories or other matching Moen® bath accessories, contact Moen Bath Accessory Customer Service at **800-882-0116**, contact your local Moen sales representative, or visit us at **www.moen.com**.

MODEL NUMBER	LIST PRICE EACH	DESCRIPTION	1/2-in. Round Bar	QTY
Chrome (CH)				
YB9801CH	74.20	Tank Lever		3
YB9803CH	73.80	Double Robe Hook		6
YB9805CH	14.60	Drawer Knob		48
YB9807CH	27.25	Drawer Pull		48
P YB9808CH	105.05	Pivoting Paper Holder		6
YB9818CH	121.60	18" Towel Bar		6
YB9824CH	131.25	24" Towel Bar		6
YB9886CH	84.90	Towel Ring		6
Brushed Nickel (BN)				
YB9801BN	93.30	Tank Lever		3
YB9803BN	81.00	Double Robe Hook		24
YB9805BN	16.55	Drawer Knob		48
YB9807BN	29.20	Drawer Pull		48
P YB9808BN	115.55	Pivoting Paper Holder		6
YB9818BN	133.70	18" Towel Bar		6
YB9824BN	144.60	24" Towel Bar		6
YB9886BN	93.25	Towel Ring		6
Polished Nickel (NL)				
YB9801NL	99.30	Tank Lever		3
YB9803NL	89.05	Double Robe Hook		24
P YB9808NL	127.10	Pivoting Paper Holder		6
YB9818NL	147.15	18" Towel Bar		6
YB9824NL	159.00	24" Towel Bar		6
YB9886NL	102.65	Towel Ring		6
Oil Rubbed Bronze (ORB)				
YB9801ORB	99.30	Tank Lever		3
YB9803ORB	89.05	Double Robe Hook		24
YB9805ORB	18.15	Drawer Knob		48
YB9807ORB	32.05	Drawer Pull		48
P YB9808ORB	127.10	Pivoting Paper Holder		6
YB9818ORB	147.15	18" Towel Bar		6
YB9824ORB	159.00	24" Towel Bar		6
YB9886ORB	102.65	Towel Ring		6



YB9801 Tank Lever

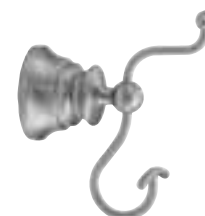

YB9803 Double Robe Hook with Swivel Top



YB9805 Drawer Knob [Available in CH, BN and ORB only]



YB9807 Drawer Pull [Available in CH, BN and ORB only]



YB9808 Pivoting Paper Holder



YB9818 18" Towel Bar



YB9824 24" Towel Bar



YB9886 Towel Ring

P Denotes pivoting paper holder

List price is per each (unless otherwise noted). Product can be ordered by case quantity or individually.



WATERHILL® Perfectly Matched Bath Accessories



LIGHTING

MODEL NUMBER	LIST PRICE EACH	DESCRIPTION	QTY
Chrome (CH)			
YB9861CH	153.50	One Globe Bath Light	2
YB9862CH	214.75	Two Globe Bath Light	2
YB9863CH	266.70	Three Globe Bath Light	2
YB9864CH	341.60	Four Globe Bath Light	2
Brushed Nickel (BN)			
YB9861BN	191.85	One Globe Bath Light	2
YB9862BN	268.50	Two Globe Bath Light	2
YB9863BN	333.55	Three Globe Bath Light	2
YB9864BN	427.00	Four Globe Bath Light	2
Oil Rubbed Bronze (ORB)			
YB9861ORB	191.85	One Globe Bath Light	2
YB9862ORB	268.50	Two Globe Bath Light	2
YB9863ORB	333.50	Three Globe Bath Light	2
YB9864ORB	427.00	Four Globe Bath Light	2
Replacement Globe			
YB9869	28.15	Replacement Globe	3



YB9861
One Globe Light



YB9862
Two Globe Light



YB9863
Three Globe Light



YB9864
Four Globe Light



YB9869
Replacement Globe

WATERHILL®













Bulbs not included.

All Waterhill® lighting fixtures can be mounted facing either upward or downward (rings need to be removed if mounted up). List price is per each (unless otherwise noted). Product can be ordered by case quantity or individually.

90°™ Bathroom Faucets

All Brushed Nickel faucet components feature the LifeShine® Non-Tarnish Finish.

		MODEL NUMBER	LIST PRICE	FINISH/ CONNECTION	CASE QTY
ONE-HANDLE BATHROOM FAUCET					
 <ul style="list-style-type: none"> • application: one or three hole • supply line length: flexible • connection size: 3/8" • connection type: compression • deckplate: sold separately • drain assembly: metal • drain assembly type: lift rod   DURALAST®	PREMIUM	S6700	415.60	Chrome	3
	S6700BN	686.10	Brushed Nickel	3	
	DECKPLATE SOLD SEPARATELY				
	147204	25.80	Chrome	12	
	147204BN	62.45	Brushed Nickel	12	
	 <ul style="list-style-type: none"> • application: one or three hole • supply line length: flexible • connection size: 3/8" • connection type: compression • deckplate: sold separately • drain assembly: metal • drain assembly type: lift rod   DURALAST®	PREMIUM	S6705	519.45	Chrome
S6705BN		857.60	Brushed Nickel	3	
DECKPLATE SOLD SEPARATELY					
147204		25.80	Chrome	12	
147204BN		62.45	Brushed Nickel	12	
 <ul style="list-style-type: none"> • application: one or three hole • supply line length: flexible • connection size: 3/8" • connection type: compression • deckplate: sold separately • drain assembly: 140780 sold separately   DURALAST®		PREMIUM	S6711	581.70	Chrome
	S6711BN	877.05	Brushed Nickel	3	
	DECKPLATE SOLD SEPARATELY				
	147204	25.80	Chrome	12	
	147204BN	62.45	Brushed Nickel	12	
	 <ul style="list-style-type: none"> • description: vessel extension kit • included: parts to convert to grid drain • included: two extensions • fits: S6700, S6705 	147556	135.70	Chrome	6
147556BN		199.05	Brushed Nickel	6	
 <ul style="list-style-type: none"> • drain assembly: metal • drain assembly type: spring loaded pop-up • drain assembly size: 1-1/4" • drain assembly: 1-1/4" non-overflow 	140780	59.20	Chrome	12	
	140780BN	82.60	Brushed Nickel	12	

NOTES

















DURALAST® Duralast® Cartridge

Refer to lavatory waste assemblies on page 403.



90™ Bathroom Faucets

All Brushed Nickel faucet components feature the LifeShine® Non-Tarnish Finish.

	MODEL NUMBER	LIST PRICE	FINISH/ CONNECTION	CASE QTY
TWO-HANDLE WIDESPREAD BATHROOM FAUCET				
 <ul style="list-style-type: none"> • application: three hole • center dimensions: 8" - 16" center • drain assembly: metal • drain assembly type: lift rod • red/blue markings: included • valve: sold separately   	PREMIUM			
	TS6720	372.05	Chrome	3
	TS6720BN	637.45	Brushed Nickel	3
TWO-HANDLE WALLMOUNT BATHROOM FAUCET				
 <ul style="list-style-type: none"> • application: three hole • center dimensions: 8" center • drain assembly: 140780 sold separately • valve: sold separately   	PREMIUM			
	9000 ♦	123.55	1/2" IPS	6
 <ul style="list-style-type: none"> • application: three hole • center dimensions: 8" - 16" center • drain assembly: metal • drain assembly type: lift rod  DURALOCK® DURALAST®				
 <ul style="list-style-type: none"> • application: three hole • center dimensions: 8" center • drain assembly: 140780 sold separately • valve: sold separately   	PREMIUM			
	TS6730	431.50	Chrome	3
	TS6730BN	719.80	Brushed Nickel	3
 <ul style="list-style-type: none"> • application: three hole • center dimensions: 8" center • drain assembly: 140780 sold separately • includes: mounting brackets 	9700	174.75	1/2" CC	3
 <ul style="list-style-type: none"> • drain assembly: metal • drain assembly type: spring loaded pop-up • drain assembly size: 1-1/4" • drain assembly: 1-1/4" non-overflow 	140780	59.20	Chrome	12
	140780BN	82.60	Brushed Nickel	12











HOW TO ORDER A COMPLETE WALLMOUNT FAUCET



NOTES

- ♦ Also available in bulk pack. See page 435.
 - Ⓜ Moen® **M•PACT®** Common Valve System
 - DURALOCK®** Duralock® Quick Connections
 - DURALAST®** Duralast® Cartridge
- Refer to lavatory waste assemblies on page 403.
Refer to specification sheet for critical dimensions for installation.

All Brushed Nickel faucet components feature the LifeShine® Non-Tarnish Finish.

	MODEL NUMBER	LIST PRICE	FINISH/ CONNECTION	CASE QTY
TWO-HANDLE ROMAN TUB				
 <ul style="list-style-type: none"> • application: three hole • spout reach: 7.63" • valve: sold separately 	PREMIUM TS903	510.30	Chrome	3
	TS903BN	726.65	Brushed Nickel	3
 <ul style="list-style-type: none"> • application: three hole • deck thickness: 1/8" to 3-3/8" rough-in deck • center dimensions: adjustable • adjustable spout shank: included • test plug: included 	4792	143.70	1/2" CC	6
 <ul style="list-style-type: none"> • application: three hole • deck thickness: 1/8" to 2-3/4" rough-in deck • center dimensions: 10" - 24" center • adjustable spout shank: included • test plug: included 	4793	162.70	1/2" CPVC, Crimp ring PEX	6
	4794	155.15	1/2" Crimp ring PEX, Cold Expansion PEX	6
 <ul style="list-style-type: none"> • application: three hole • deck thickness: 1/8" to 1-7/8" rough-in deck • center dimensions: 10" center • non-adjustable spout shank: included • test plug: included 	4796	135.35	1/2" CC	6
	4797	138.00	1/2" CPVC, Crimp ring PEX	6
	4798	138.00	1/2" Crimp ring PEX, Cold Expansion PEX	6
 <ul style="list-style-type: none"> • description: high flow thermostatic mixing valve for roman tubs • ports: three • ASSE standard 1070: yes • flow rate: 12.0 gpm (45.4 L/min) max. 	104465	173.00	1/2" CC	12
	104466	173.00	1/2" IPS	12
 <ul style="list-style-type: none"> • description: PEX transition fittings (2) and clips • connections: adapts standard 1/2" PEX barb to 1/2" PEX cold expansion 	140715	10.75	1/2" PEX	200

HOW TO ORDER A COMPLETE ROMAN TUB FAUCET

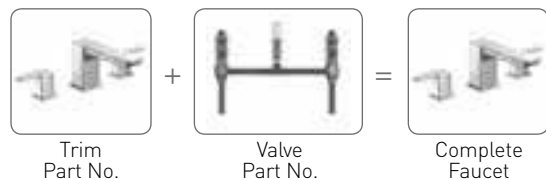









NOTES

 Moen® **M•PACT®** Common Valve System

Thermostatic Mixing Valve service kits, see page 498.

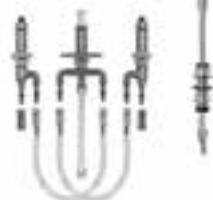
90™ Roman Tubs

All Brushed Nickel faucet components feature the LifeShine® Non-Tarnish Finish.

	MODEL NUMBER	LIST PRICE	FINISH/ CONNECTION	CASE QTY
TWO-HANDLE ROMAN TUB WITH HANDSHOWER				
 <ul style="list-style-type: none"> • application: four hole • showerhead type: handshower • handshower flow rate: 2.0 transitioning to 1.75 gpm • spray functions: one-function • spout reach: 7.63" • valve: sold separately  	PREMIUM TS904	794.80	Chrome	3
	TS904BN	1,333.45	Brushed Nickel	3
 <ul style="list-style-type: none"> • application: four hole • deck thickness: 1/8" to 2-5/8" rough-in deck • center dimensions: adjustable • non-adjustable spout shank: included • test plug: included 	9792	323.75	1/2" CC	6
 <ul style="list-style-type: none"> • application: four hole • deck thickness: 1/8" to 2-5/8" rough-in deck • center dimensions: 10" - 24" center • non-adjustable spout shank: included • test plug: included 	9793	331.35	1/2" CPVC, Crimp ring PEX	6
 <ul style="list-style-type: none"> • description: high flow thermostatic mixing valve for roman tubs • ports: three • ASSE standard 1070: yes • flow rate: 12.0 gpm (45.4 L/min) max. 	104465 104466	173.00	1/2" CC 1/2" IPS	12 12
 <ul style="list-style-type: none"> • description: PEX transition fittings (2) and clips • connections: adapts standard 1/2" PEX barb to 1/2" PEX cold expansion 	140715	10.75	1/2" PEX	200



HOW TO ORDER A COMPLETE ROMAN TUB FAUCET

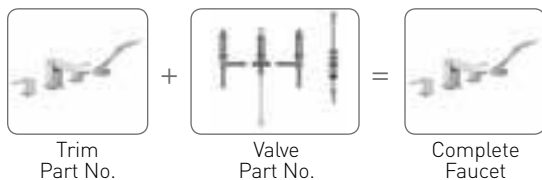









NOTES

 Moen® **M•PACT**® Common Valve System

Thermostatic Mixing Valve service kits, see page 498.

90°™ 3/4" Thermostatic Showering

All Brushed Nickel faucet components feature the LifeShine® Non-Tarnish Finish.

		MODEL NUMBER	LIST PRICE	FINISH/ CONNECTION	CASE QTY	
EXACTTEMP® VALVE ONLY						
 <ul style="list-style-type: none"> description: temperature control valve trim requires: separate volume control valve valve: sold separately 	PREMIUM	TS3100	273.90	Chrome	3	
		TS3100BN	414.35	Brushed Nickel	3	
	EXACTTEMP® VOLUME CONTROL VALVE ONLY					
 <ul style="list-style-type: none"> description: thermostatic rough-in valve ports: four adjustable temp limit stop: included check stops: included 	PREMIUM	S3371	508.90	3/4" IPS	6	
	EXACTTEMP® VOLUME CONTROL VALVE ONLY					
	 <ul style="list-style-type: none"> valve: sold separately 	PREMIUM	TS3300	126.45	Chrome	6
		TS3300BN	168.60	Brushed Nickel	6	
 <ul style="list-style-type: none"> description: volume control rough-in valve includes: volume control 		PREMIUM	S3600	129.35	3/4" IPS	12

HOW TO ORDER AN EXACTTEMP® VALVE

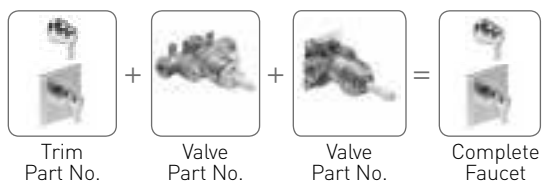

NOTES

 Moen® **M•PACT®** Common Valve System

90™ Transfer Valve Shower Spa Components

All Brushed Nickel faucet components feature the LifeShine® Non-Tarnish Finish.

		MODEL NUMBER	LIST PRICE	FINISH/ CONNECTION	CASE QTY
3 INDEPENDENT FUNCTION TRANSFER VALVE ONLY					
 <ul style="list-style-type: none"> • use with 3362 transfer valve • valve: sold separately 	PREMIUM				
		TS4173	143.05	Chrome	12
	TS4173BN	193.20	Brushed Nickel	12	
2/3 FUNCTION TRANSFER VALVE ONLY					
 <ul style="list-style-type: none"> • use with 3372 or 3375 transfer valve • valve: sold separately 	PREMIUM				
		TS4172	143.05	Chrome	6
	TS4172BN	193.20	Brushed Nickel	6	
 <ul style="list-style-type: none"> • type of function: two independent one shared • must be used with: Posi-Temp® or Moentrol® valve 	3372	172.00	1/2" CC	12	
	 <ul style="list-style-type: none"> • type of function: two independent functions • must be used with: Posi-Temp® or Moentrol® valve 	3375	172.00	1/2" CC	12

HOW TO ORDER A COMPLETE TRANSFER VALVE













NOTES

 Moen® **M•PACT**® Common Valve System
DURALAST Duralast® Cartridge

90™ Moentrol® Tub/Showering



All Brushed Nickel faucet components feature the LifeShine® Non-Tarnish Finish.

		MODEL NUMBER	LIST PRICE	FINISH/ CONNECTION	CASE QTY
MOENTROL® TUB/SHOWER					
 <ul style="list-style-type: none"> • showerhead functions: one-function • showerhead type: rainshower • showerhead size: 6" diameter spray head • showerhead flow rate: 2.5 gpm (9.5 L/min) max. • spout length: 7 1/4" • spout connection type: slip fit • tub spout type: diverter • valve: sold separately   IMMERSION®		PREMIUM			
		TS3713	317.00	Chrome	3
		TS3713BN	721.40	Brushed Nickel	3
 <ul style="list-style-type: none"> • showerhead type: showerhead sold separately • spout length: 7 1/4" • spout connection type: slip fit • tub spout type: diverter • valve: sold separately  		PREMIUM			
		TS3713NH	215.55	Chrome	3
 <ul style="list-style-type: none"> • description: pressure balanced valve with volume control • ports: four • adjustable temp limit stop: included • checks: included • includes: volume control 		3510	164.10	1/2" IPS	6
		3520	164.10	1/2" CC	6
 <ul style="list-style-type: none"> • description: pressure balanced valve with volume control • ports: four • adjustable temp limit stop: included • check stops: included • includes: volume control 		3570 ♦	195.50	1/2" CC	6

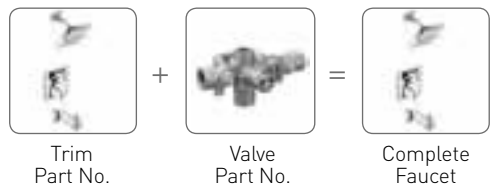
HOW TO ORDER A COMPLETE TUB/SHOWER FAUCET













NOTES

- ♦ Also available in bulk pack. See page 435.
-  Moen® **M•PACT®** Common Valve System
-  Immersion® Rainshower

90™ Moentrol® Tub/Showering

All Brushed Nickel faucet components feature the LifeShine® Non-Tarnish Finish.

		MODEL NUMBER	LIST PRICE	FINISH/ CONNECTION	CASE QTY
MOENTROL® SHOWER ONLY					
 <ul style="list-style-type: none"> • showerhead functions: one-function • showerhead type: rainshower • showerhead size: 6" diameter spray head • showerhead flow rate: 2.5 gpm (9.5 L/min) max. • valve: sold separately 		PREMIUM			
	  IMMERSION®	TS3715	233.50	Chrome	3
		TS3715BN	565.00	Brushed Nickel	3
 <ul style="list-style-type: none"> • showerhead type: showerhead sold separately • valve: sold separately 		PREMIUM			
	 	TS3715NH	158.75	Chrome	3
 <ul style="list-style-type: none"> • description: pressure balanced valve with volume control • ports: four • adjustable temp limit stop: included • checks: included • includes: volume control 		3510	164.10	1/2" IPS	6
		3520	164.10	1/2" CC	6
 <ul style="list-style-type: none"> • description: pressure balanced valve with volume control • ports: four • adjustable temp limit stop: included • check stops: included • includes: volume control 		3570 ♦	195.50	1/2" CC	6
					



HOW TO ORDER A COMPLETE SHOWER FAUCET

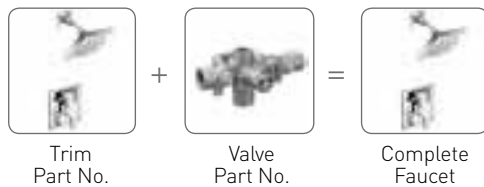







NOTES

- ♦ Also available in bulk pack. See page 435.
-  Moen® **M•PACT®** Common Valve System
-  Immersion® Rainshower

90°™ Moentrol® Tub/Showering

All Brushed Nickel faucet components feature the LifeShine® Non-Tarnish Finish.

		MODEL NUMBER	LIST PRICE	FINISH/ CONNECTION	CASE QTY
MOENTROL® VALVE ONLY					
 <ul style="list-style-type: none"> valve: sold separately  		PREMIUM			
		TS3711	175.05	Chrome	3
		TS3711BN	435.90	Brushed Nickel	3
  <ul style="list-style-type: none"> description: pressure balanced valve with volume control ports: four adjustable temp limit stop: included checks: included includes: volume control 		3510	164.10	1/2" IPS	6
		3520	164.10	1/2" CC	6
  <ul style="list-style-type: none"> description: pressure balanced valve with volume control ports: four adjustable temp limit stop: included check stops: included includes: volume control 		3570 ♦	195.50	1/2" CC	6

HOW TO ORDER A COMPLETE VALVE













NOTES

- ♦ Also available in bulk pack. See page 435.
- Ⓜ Moen® **M•PACT**® Common Valve System

90™ Posi-Temp® Showering

All Brushed Nickel faucet components feature the LifeShine® Non-Tarnish Finish.

		MODEL NUMBER	LIST PRICE	FINISH/ CONNECTION	CASE QTY
POSI-TEMP® TUB/SHOWER					
 <ul style="list-style-type: none"> • showerhead functions: one-function • showerhead type: rainshower • showerhead size: 6" diameter spray head • showerhead flow rate: 2.5 gpm (9.5 L/min) max. • spout length: 7 1/4" • spout connection type: slip fit • tub spout type: diverter • valve: sold separately 	PREMIUM				
		TS2713	275.60	Chrome	3
	TS2713BN	510.60	Brushed Nickel	3	
 <ul style="list-style-type: none"> • showerhead functions: one-function • showerhead type: eco-performance rainshower • showerhead size: 6" diameter spray head • showerhead flow rate: 1.75 gpm (6.65 L/min) max. • spout length: 7 1/4" • spout connection type: slip fit • tub spout type: diverter • valve: sold separately 	PREMIUM				
		TS2713EP	275.60	Chrome	3
	TS2713EPBN	510.60	Brushed Nickel	3	
 <ul style="list-style-type: none"> • showerhead type: showerhead sold separately • spout length: 7 1/4" • spout connection type: slip fit • tub spout type: diverter • valve: sold separately 	PREMIUM				
		TS2713NH	185.55	Chrome	3
	TS2713NHBN	369.95	Brushed Nickel	3	
  <ul style="list-style-type: none"> • description: pressure balanced cycling valve • ports: four • adjustable temp limit stop: included 	2510 ◆	119.75	1/2" IPS	6	
	2520 ◆	119.75	1/2" CC	6	
	2580 ◆	119.75	1/2" Crimp ring PEX	6	
  <ul style="list-style-type: none"> • description: pressure balanced cycling valve • ports: four • adjustable temp limit stop: included • quarter turn stops: included 	2570 ◆	145.35	1/2" CC	6	
	2590 ◆	145.35	1/2" IPS	6	

HOW TO ORDER A COMPLETE TUB/SHOWER FAUCET

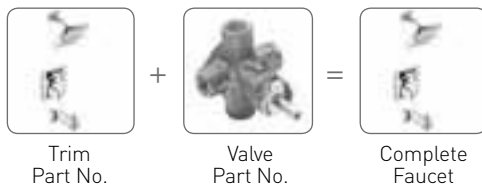











NOTES

- ◆ Also available in bulk pack. See page 435.
- Ⓜ Moen® **M•PACT**® Common Valve System
- IMMERISION® Immersion® Rainshower

90™ Posi-Temp® Showering



All Brushed Nickel faucet components feature the LifeShine® Non-Tarnish Finish.

		MODEL NUMBER	LIST PRICE	FINISH/ CONNECTION	CASE QTY
POSI-TEMP® SHOWER ONLY					
 <ul style="list-style-type: none"> • showerhead functions: one-function • showerhead type: rainshower • showerhead size: 6" diameter spray head • showerhead flow rate: 2.5 gpm (9.5 L/min) max. • valve: sold separately 		PREMIUM			
		TS2712	216.80	Chrome	3
		TS2712BN	401.60	Brushed Nickel	3
					
 <ul style="list-style-type: none"> • showerhead functions: one-function • showerhead type: eco-performance rainshower • showerhead size: 6" diameter spray head • showerhead flow rate: 1.75 gpm (6.65 L/min) max. • valve: sold separately 		PREMIUM			
		TS2712EP	216.80	Chrome	3
		TS2712EPBN	401.60	Brushed Nickel	3
					
 <ul style="list-style-type: none"> • showerhead type: showerhead sold separately • valve: sold separately 		PREMIUM			
		TS2712NH	172.25	Chrome	3
		TS2712NHBN	319.10	Brushed Nickel	3
					
 <ul style="list-style-type: none"> • description: pressure balanced cycling valve • ports: four • adjustable temp limit stop: included 		2510 ♦	119.75	1/2" IPS	6
		2520 ♦	119.75	1/2" CC	6
		2580 ♦	119.75	1/2" Crimp ring PEX	6
					
 <ul style="list-style-type: none"> • description: pressure balanced cycling valve • ports: four • adjustable temp limit stop: included • quarter turn stops: included 		2570 ♦	145.35	1/2" CC	6
		2590 ♦	145.35	1/2" IPS	6
					

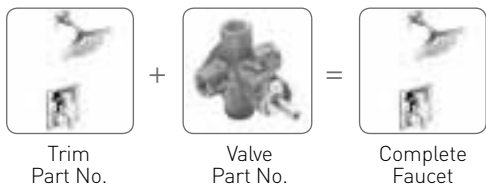
HOW TO ORDER A COMPLETE SHOWER FAUCET







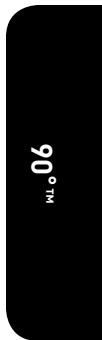

NOTES

- ♦ Also available in bulk pack. See page 435.
-  Moen® **M•PACT**® Common Valve System
-  Immersion® Rainshower



90^o™ Posi-Temp® Showering

All Brushed Nickel faucet components feature the LifeShine® Non-Tarnish Finish.

		MODEL NUMBER	LIST PRICE	FINISH/ CONNECTION	CASE QTY															
POSI-TEMP® VALVE ONLY																				
 <ul style="list-style-type: none"> valve: sold separately  	<table border="1"> <thead> <tr> <th colspan="5">PREMIUM</th> </tr> </thead> <tbody> <tr> <td>TS2711</td> <td>162.55</td> <td>Chrome</td> <td></td> <td>3</td> </tr> <tr> <td>TS2711BN</td> <td>301.00</td> <td>Brushed Nickel</td> <td></td> <td>3</td> </tr> </tbody> </table>					PREMIUM					TS2711	162.55	Chrome		3	TS2711BN	301.00	Brushed Nickel		3
	PREMIUM																			
	TS2711	162.55	Chrome		3															
TS2711BN	301.00	Brushed Nickel		3																
 <ul style="list-style-type: none"> description: pressure balanced cycling valve ports: four adjustable temp limit stop: included 	<table border="1"> <tbody> <tr> <td>2510 ◆</td> <td>119.75</td> <td>1/2" IPS</td> <td></td> <td>6</td> </tr> <tr> <td>2520 ◆</td> <td>119.75</td> <td>1/2" CC</td> <td></td> <td>6</td> </tr> <tr> <td>2580 ◆</td> <td>119.75</td> <td>1/2" Crimp ring PEX</td> <td></td> <td>6</td> </tr> </tbody> </table>	2510 ◆	119.75	1/2" IPS		6	2520 ◆	119.75	1/2" CC		6	2580 ◆	119.75	1/2" Crimp ring PEX		6				
2510 ◆	119.75	1/2" IPS		6																
2520 ◆	119.75	1/2" CC		6																
2580 ◆	119.75	1/2" Crimp ring PEX		6																
 <ul style="list-style-type: none"> description: pressure balanced cycling valve ports: four adjustable temp limit stop: included quarter turn stops: included 	<table border="1"> <tbody> <tr> <td>2570 ◆</td> <td>145.35</td> <td>1/2" CC</td> <td></td> <td>6</td> </tr> <tr> <td>2590 ◆</td> <td>145.35</td> <td>1/2" IPS</td> <td></td> <td>6</td> </tr> </tbody> </table>	2570 ◆	145.35	1/2" CC		6	2590 ◆	145.35	1/2" IPS		6									
2570 ◆	145.35	1/2" CC		6																
2590 ◆	145.35	1/2" IPS		6																



HOW TO ORDER A COMPLETE VALVE



NOTES

- ◆ Also available in bulk pack. See page 435.
- Ⓜ Moen® **M•PACT**® Common Valve System

90™ Perfectly Matched Bath Accessories

Moen® bath accessories CANNOT be combined with Moen® faucet parts on a Purchase Order.

Moen makes it easy to coordinate the entire style and look of the bathroom. Our 90™ bath accessories perfectly match the style and finish of our 90™ faucets. Total coordination of the bath has never been easier.

For more information on ordering 90™ bath accessories or other matching Moen® bath accessories, contact Moen Bath Accessory Customer Service at **800-882-0116**, contact your local Moen sales representative, or visit us at **www.moen.com**.

1-in. Rectangular Bar

MODEL NUMBER	LIST PRICE EACH	DESCRIPTION	QTY
Chrome (CH)			
YB8801CH	59.75	Tank Lever	24
YB8803CH	45.80	Single Robe Hook	24
YB8805CH	12.05	Drawer Knob	48
YB8807CH	24.15	Drawer Pull	48
^(P) YB8808CH	84.25	Pivoting Paper Holder	6
YB8818CH	96.90	18" Towel Bar	6
YB8824CH	100.35	24" Towel Bar	6
YB8886CH	67.70	Hand Towel Bar	6
Brushed Nickel (BN)			
YB8801BN	64.50	Tank Lever	24
YB8803BN	49.50	Single Robe Hook	24
YB8805BN	13.95	Drawer Knob	48
YB8807BN	26.05	Drawer Pull	48
^(P) YB8808BN	90.90	Pivoting Paper Holder	6
YB8818BN	104.65	18" Towel Bar	6
YB8824BN	108.50	24" Towel Bar	6
YB8886BN	73.00	Hand Towel Bar	6

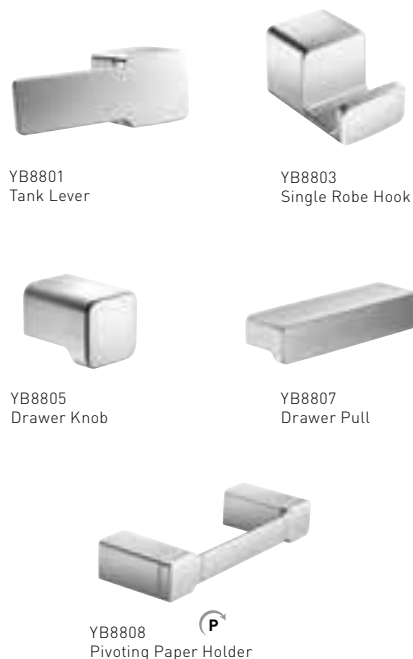

GRAB BARS

PERFECTLY MATCHED to Moen® 90™ faucets and bath accessories. ADA-compliant.

SecureMount™
 SecureMount™ Grab Bars are manufactured with an innovative flange design that makes it easy to connect to the stud at multiple points. Tested to withstand 500lbs. To install grab bars securely without studs, use SecureMount™ Anchors. Sold separately.

MODEL NUMBER	LIST PRICE EACH	DESCRIPTION	QTY
1-1/4" • Chrome (CH)			
YG8812CH	138.45	12" Designer Grab Bar	6
YG8818CH	144.65	18" Designer Grab Bar	6
YG8824CH	151.15	24" Designer Grab Bar	6
YG8836CH	172.10	36" Designer Grab Bar	6
YG8842CH	253.25	42" Designer Grab Bar	6
1-1/4" • Brushed Nickel (BN)			
YG8812BN	149.65	12" Designer Grab Bar	6
YG8818BN	156.80	18" Designer Grab Bar	6
YG8824BN	169.25	24" Designer Grab Bar	6
YG8836BN	190.60	36" Designer Grab Bar	6
YG8842BN	280.00	42" Designer Grab Bar	6

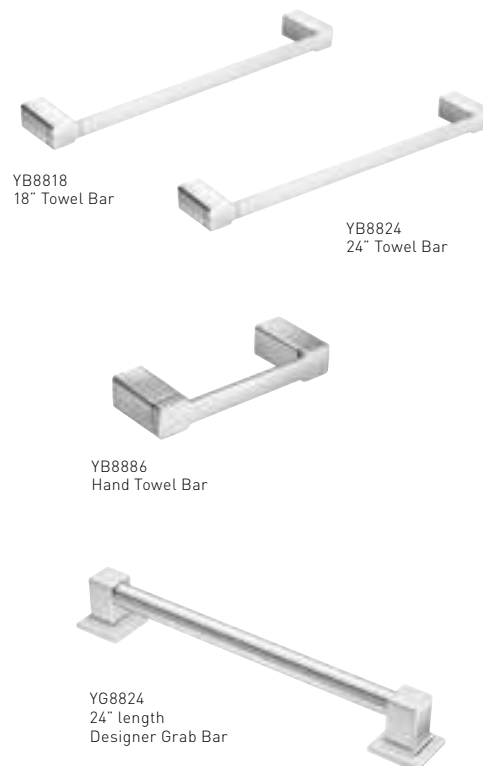

^(P) Denotes pivoting paper holder

 Complies with Americans with Disabilities Act (ADA) specifications. SecureMount™ Grab Bars are tested to withstand 500 lb. pull when securely installed per instructions.

List price is per each (unless otherwise noted). Product can be ordered by case quantity or individually.



LIGHTING

MODEL NUMBER	LIST PRICE EACH	DESCRIPTION	QTY
Chrome (CH)			
YB8861CH	153.50	One Globe Bath Light	2
YB8862CH	214.75	Two Globe Bath Light	2
YB8863CH	266.70	Three Globe Bath Light	2
YB8864CH	341.60	Four Globe Bath Light	2
Brushed Nickel (BN)			
YB8861BN	191.85	One Globe Bath Light	2
YB8862BN	268.50	Two Globe Bath Light	2
YB8863BN	333.55	Three Globe Bath Light	2
YB8864BN	427.00	Four Globe Bath Light	2
Replacement Globe			
YB8869	28.15	Replacement Globe	3



YB8861
One Globe Light

YB8862
Two Globe Light



YB8863
Three Globe Light

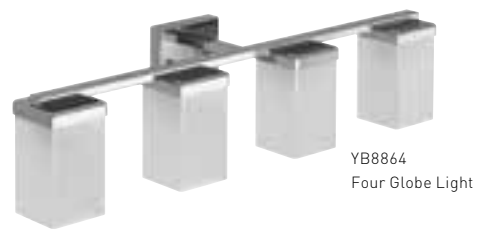

YB8864
Four Globe Light















YB8869
Replacement Globe

90™



Bulbs not included.

All 90™ lighting fixtures can be mounted facing either upward or downward.
List price is per each (unless otherwise noted). Product can be ordered by case quantity or individually.

	MODEL NUMBER	LIST PRICE	FINISH/ CONNECTION	CASE QTY
ONE-HANDLE BATHROOM FAUCET				
 <ul style="list-style-type: none"> • application: one hole • supply line length: flexible • connection size: 3/8" • connection type: compression • drain assembly: metal • drain assembly type: lift rod • red/blue markings: included   DURALAST®	PREMIUM			
	S8000	332.15	Chrome	3
 <ul style="list-style-type: none"> • application: one hole • supply line length: flexible • connection size: 3/8" • connection type: compression • drain assembly: metal • drain assembly type: lift rod • red/blue markings: included   DURALAST®	PREMIUM			
	S8001	321.80	Chrome	3
TWO-HANDLE WIDESPREAD BATHROOM FAUCET				
 <ul style="list-style-type: none"> • application: three hole • center dimensions: 8" - 16" center • drain assembly: metal • drain assembly type: lift rod • red/blue markings: included • valve: sold separately   	PREMIUM			
	TS8002	355.10	Chrome	3
 <ul style="list-style-type: none"> • application: three hole • center dimensions: 8" - 16" center • drain assembly: metal • drain assembly type: lift rod  DURALOCK® DURALAST®	9000 ♦	123.55	1/2" IPS	6

HOW TO ORDER A COMPLETE WIDESPREAD BATHROOM FAUCET

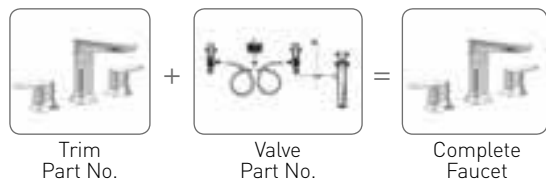











NOTES

- ♦ Also available in bulk pack. See page 435.
- Ⓜ Moen® **M•PACT®** Common Valve System
- DURALOCK®** Duralock® Quick Connections
- DURALAST®** Duralast® Cartridge

Refer to lavatory waste assemblies on page 367.
Refer to specification sheet for critical dimensions for installation.



VIA® Transfer Valve Shower Spa Components

		MODEL NUMBER	LIST PRICE	FINISH/ CONNECTION	CASE QTY
3 INDEPENDENT FUNCTION TRANSFER VALVE ONLY					
 <ul style="list-style-type: none"> • use with 3362 transfer valve • valve: sold separately 	PREMIUM	TS2172	136.45	Chrome	12
 <ul style="list-style-type: none"> • ports: four • type of function: three independent functions • must be used with: Posi-Temp or Moentrol valve 		3362	192.60	1/2" CC	6
2/3 FUNCTION TRANSFER VALVE ONLY					
 <ul style="list-style-type: none"> • use with 3372 or 3375 transfer valve • valve: sold separately 		TS2171	136.45	Chrome	12
 <ul style="list-style-type: none"> • type of function: two independent one shared • must be used with: Posi-Temp® or Moentrol® valve 		3372	172.00	1/2" CC	12
 <ul style="list-style-type: none"> • type of function: two independent functions • must be used with: Posi-Temp® or Moentrol® valve 		3375	172.00	1/2" CC	12

VIA®







HOW TO ORDER A COMPLETE VALVE



NOTES

Moentrol Moen® M•PACT® Common Valve System
 DURALAST® Duralast® Cartridge

VIA® Posi-Temp® Showering

		MODEL NUMBER	LIST PRICE	FINISH/ CONNECTION	CASE QTY
POSI-TEMP® TUB/SHOWER					
	<ul style="list-style-type: none"> • showerhead functions: one-function • showerhead type: rainshower • showerhead size: 6" diameter spray head • showerhead flow rate: 2.5 gpm (9.5 L/min) max. • spout length: 7 1/4" • spout connection type: slip fit • tub spout type: diverter • red/blue markings: included • valve: sold separately 	PREMIUM TS8713	263.05	Chrome	3
					
	<ul style="list-style-type: none"> • showerhead functions: one-function • showerhead type: eco-performance showerhead • showerhead size: 6" diameter spray head • showerhead flow rate: 2.0 transitioning to 1.75 gpm • spout length: 7 1/4" • spout connection type: slip fit • tub spout type: diverter • red/blue markings: included • valve: sold separately 	PREMIUM TS8713EP	263.05	Chrome	3
					
	<ul style="list-style-type: none"> • description: pressure balanced cycling valve • ports: four • adjustable temp limit stop: included 	2510 ◆	119.75	1/2" IPS	6
		2520 ◆	119.75	1/2" CC	6
		2580 ◆	119.75	1/2" Crimp ring PEX	6
	<ul style="list-style-type: none"> • description: pressure balanced cycling valve • ports: four • adjustable temp limit stop: included • quarter turn stops: included 	2570 ◆	145.35	1/2" CC	6
		2590 ◆	145.35	1/2" IPS	6

HOW TO ORDER A COMPLETE TUB/SHOWER FAUCET

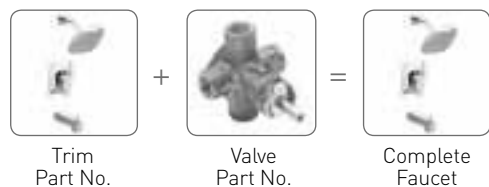











NOTES

- ◆ Also available in bulk pack. See page page 435.
- Moening M•PACT® Common Valve System
- IMMERISION® Immersion® Rainshower



VIA® Posi-Temp® Showering







		MODEL NUMBER	LIST PRICE	FINISH/ CONNECTION	CASE QTY
POSI-TEMP® SHOWER ONLY					
	<ul style="list-style-type: none"> • showerhead functions: one-function • showerhead type: rainshower • showerhead size: 6" diameter spray head • showerhead flow rate: 2.5 gpm (9.5 L/min) max. • red/blue markings: included • valve: sold separately 	PREMIUM TS8712	206.85	Chrome	3
		  IMMERSION®			
	<ul style="list-style-type: none"> • showerhead functions: one-function • showerhead type: eco-performance showerhead • showerhead size: 6" diameter spray head • showerhead flow rate: 2.0 transitioning to 1.75 gpm • red/blue markings: included • valve: sold separately 	PREMIUM TS8712EP	206.85	Chrome	3
		   IMMERSION®			
	<ul style="list-style-type: none"> • description: pressure balanced cycling valve • ports: four • adjustable temp limit stop: included 	2510 ♦	119.75	1/2" IPS	6
		2520 ♦	119.75	1/2" CC	6
		2580 ♦	119.75	1/2" Crimp ring PEX	6
					
	<ul style="list-style-type: none"> • description: pressure balanced cycling valve • ports: four • adjustable temp limit stop: included • quarter turn stops: included 	2570 ♦	145.35	1/2" CC	6
		2590 ♦	145.35	1/2" IPS	6
					

HOW TO ORDER A COMPLETE SHOWER FAUCET



NOTES

- ♦ Also available in bulk pack. See page 435.
-  Moen® **M•PACT®** Common Valve System
-  Immersion® Rainshower

		MODEL NUMBER	LIST PRICE	FINISH/ CONNECTION	CASE QTY
POSI-TEMP® VALVE ONLY					
 <ul style="list-style-type: none"> • red/blue markings: included • valve: sold separately  		PREMIUM			
		TS8711	155.15	Chrome	3
 	• description: pressure balanced cycling valve	2510 ◆	119.75	1/2" IPS	6
	• ports: four	2520 ◆	119.75	1/2" CC	6
	• adjustable temp limit stop: included	2580 ◆	119.75	1/2" Crimp ring PEX	6
 	• description: pressure balanced cycling valve	2570 ◆	145.35	1/2" CC	6
	• ports: four • adjustable temp limit stop: included • quarter turn stops: included	2590 ◆	145.35	1/2" IPS	6

HOW TO ORDER A COMPLETE VALVE



NOTES

- ◆ Also available in bulk pack. See page 435.
- Ⓜ Moen® **M•PACT**® Common Valve System



VIA® Perfectly Matched Bath Accessories

Moen® bath accessories CANNOT be combined with Moen® faucet parts on a Purchase Order.

Moen makes it easy to coordinate the entire style and look of the bathroom. Our Via® bath accessories perfectly match the style and finish of our Via® faucets. Total coordination of the bath has never been easier.

For more information on ordering Our Via® bath accessories or other matching Moen® bath accessories, contact Moen Bath Accessory Customer Service at **800-882-0116**, contact your local Moen sales representative, or visit us at www.moen.com.

MODEL NUMBER	LIST PRICE EACH	DESCRIPTION	QTY
Chrome (CH)			
YB5003CH	43.30	Single Robe Hook	24
^(P) YB5008CH	79.60	Pivoting Paper Holder	6
YB5012CH	86.10	12" Towel Bar	6
YB5018CH	91.60	18" Towel Bar	6
YB5024CH	94.95	24" Towel Bar	6
YB5086CH	64.00	Hand Towel Bar	6



YB5003
Single Robe Hook



YB5008 ^(P)
Pivoting
Paper Holder



YB5086
Hand Towel Bar



YB5012
12" Towel Bar



YB5018
18" Towel Bar













YB5024
24" Towel Bar

^(P) Denotes pivoting paper holder

List price is per each (unless otherwise noted). Product can be ordered by case quantity or individually.

ROTHBURY™ Bathroom Faucets

All Brushed Nickel faucet components feature the LifeShine® Non-Tarnish Finish.

	MODEL NUMBER	LIST PRICE	FINISH/ CONNECTION	CASE QTY
ONE-HANDLE BATHROOM FAUCET				
 <ul style="list-style-type: none"> • application: one or three hole • supply line length: flexible • connection size: 3/8" • connection type: compression • deckplate: included • drain assembly: metal • drain assembly type: spring loaded pop-up   DURALAST®	PREMIUM			
	S6202	415.60	Chrome	3
	S6202BN	686.10	Brushed Nickel	3
	S6202ORB	722.70	Oil Rubbed Bronze	3
 <ul style="list-style-type: none"> • description: vessel extension kit • includes: parts to convert to grid drain • includes: two extensions 	A1616	121.85	Chrome	6
	A1616BN	174.50	Brushed Nickel	6
	A1616ORB	192.05	Oil Rubbed Bronze	6
	TWO-HANDLE WIDESPREAD BATHROOM FAUCET			
 <ul style="list-style-type: none"> • application: three hole • center dimensions: 8" - 16" center • drain assembly: metal • drain assembly type: lift rod • valve: sold separately   	PREMIUM			
	TS6205	372.05	Chrome	3
	TS6205BN	637.45	Brushed Nickel	3
	TS6205ORB	671.55	Oil Rubbed Bronze	3
 <ul style="list-style-type: none"> • application: three hole • center dimensions: 8" - 16" center • drain assembly: metal • drain assembly type: lift rod  DURALOCK® DURALAST®	9000 ♦	123.55	1/2" IPS	6

HOW TO ORDER A COMPLETE BATHROOM FAUCET









NOTES

- ♦ Also available in bulk pack. See page 435.
 - Moën® **M•PACT®** Common Valve System
 - DURALOCK®** Duralock® Quick Connections
 - DURALAST®** Duralast® Cartridge
- Refer to lavatory waste assemblies on page 403.
Refer to specification sheet for critical dimensions for installation..

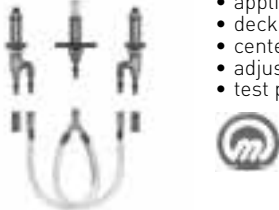

ROTHBURY™ Roman Tubs

All Brushed Nickel faucet components feature the LifeShine® Non-Tarnish Finish.

		MODEL NUMBER	LIST PRICE	FINISH/ CONNECTION	CASE QTY
TWO-HANDLE ROMAN TUB					
 <ul style="list-style-type: none"> • application: three hole • spout reach: 8.14" • valve: sold separately 	PREMIUM				
		TS923	535.85	Chrome	3
		TS923BN	763.00	Brushed Nickel	3
		TS923ORB	803.60	Oil Rubbed Bronze	3
 <ul style="list-style-type: none"> • application: three hole • deck thickness: 1/8" to 3-3/8" rough-in deck • center dimensions: adjustable • adjustable spout shank: included • test plug: included 		4792	143.70	1/2" CC	6
 <ul style="list-style-type: none"> • application: three hole • deck thickness: 1/8" to 2-3/4" rough-in deck • center dimensions: 10" - 24" center • adjustable spout shank: included • test plug: included 		4793 4794	162.70 155.15	1/2" CPVC, Crimp ring PEX 1/2" Crimp ring PEX, Cold Expansion PEX	6 6
 <ul style="list-style-type: none"> • application: three hole • deck thickness: 1/8" to 1-7/8" rough-in deck • center dimensions: 10" center • non-adjustable spout shank: included • test plug: included 		4796 4797 4798	135.35 138.00 138.00	1/2" CC 1/2" CPVC, Crimp ring PEX 1/2" Crimp ring PEX, Cold Expansion PEX	6 6 6
 <ul style="list-style-type: none"> • description: high flow thermostatic mixing valve for roman tubs • ports: three • ASSE standard 1070: yes • flow rate: 12.0 gpm (45.4 L/min) max. 		104465 104466	173.00 173.00	1/2" CC 1/2" IPS	12 12
 <ul style="list-style-type: none"> • description: PEX transition fittings (2) and clips • connections: adapts standard 1/2" PEX barb to 1/2" PEX cold expansion 		140715	10.75	1/2" PEX	200

ROTHBURY™

HOW TO ORDER A COMPLETE ROMAN TUB FAUCET

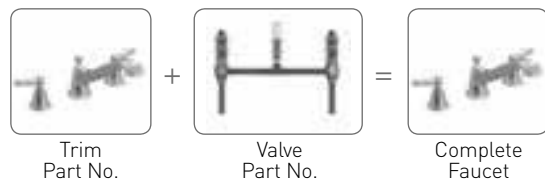









NOTES

 Moen® **M•PACT®** Common Valve System

Thermostatic Mixing Valve service kits, see page 498.

ROTHBURY™ Roman Tubs

All Brushed Nickel faucet components feature the LifeShine® Non-Tarnish Finish.

	MODEL NUMBER	LIST PRICE	FINISH/ CONNECTION	CASE QTY
TWO-HANDLE ROMAN TUB WITH HANDSHOWER				
 <ul style="list-style-type: none"> • application: four hole • showerhead type: handshower • handshower flow rate: 2.0 transitioning to 1.75 gpm • spray functions: one-function • spout reach: 8.14" • valve: sold separately 	PREMIUM			
	TS925	834.50	Chrome	3
	TS925BN	1,400.20	Brushed Nickel	3
	TS925ORB	1,474.85	Oil Rubbed Bronze	3
 <ul style="list-style-type: none"> • application: four hole • deck thickness: 1/8" to 2-5/8" rough-in deck • center dimensions: adjustable • non-adjustable spout shank: included • test plug: included 	9792	323.75	1/2" CC	6
 <ul style="list-style-type: none"> • application: four hole • deck thickness: 1/8" to 2-5/8" rough-in deck • center dimensions: 10" - 24" center • non-adjustable spout shank: included • test plug: included 	9793	331.35	1/2" CPVC, Crimp ring PEX	6
 <ul style="list-style-type: none"> • description: high flow thermostatic mixing valve for roman tubs • ports: three • ASSE standard 1070: yes • flow rate: 12.0 gpm (45.4 L/min) max. 	104465	173.00	1/2" CC	12
	104466	173.00	1/2" IPS	12
 <ul style="list-style-type: none"> • description: PEX transition fittings (2) and clips • connections: adapts standard 1/2" PEX barb to 1/2" PEX cold expansion 	140715	10.75	1/2" PEX	200

HOW TO ORDER A COMPLETE ROMAN TUB FAUCET

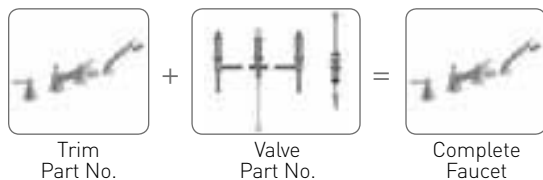











NOTES

 Moen® **M•PACT®** Common Valve System

Thermostatic Mixing Valve service kits, see page 498.

ROTHBURY™ 3/4" Thermostatic Showering

All Brushed Nickel faucet components feature the LifeShine® Non-Tarnish Finish.

		MODEL NUMBER	LIST PRICE	FINISH/ CONNECTION	CASE QTY
EXACTTEMP® VALVE ONLY					
 <ul style="list-style-type: none"> description: temperature control valve trim requires: separate volume control valve valve: sold separately  	PREMIUM				
	TS3760	273.90	Chrome	3	
	TS3760BN	414.35	Brushed Nickel	3	
	TS3760ORB	436.50	Oil Rubbed Bronze	3	
 <ul style="list-style-type: none"> description: thermostatic rough-in valve ports: four adjustable temp limit stop: included check stops: included 	PREMIUM	S3371	508.90	3/4" IPS	6
	EXACTTEMP® VOLUME CONTROL VALVE ONLY				
 <ul style="list-style-type: none"> valve: sold separately  	PREMIUM				
	TS3820	126.45	Chrome	6	
	TS3820BN	168.60	Brushed Nickel	6	
	TS3820ORB	177.60	Oil Rubbed Bronze	6	
 <ul style="list-style-type: none"> description: volume control rough-in valve includes: volume control 	PREMIUM	S3600	129.35	3/4" IPS	12

ROTHBURY™

HOW TO ORDER AN EXACTTEMP VALVE

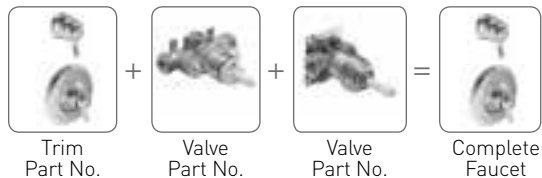







NOTES

- ◆ Also available in bulk pack. See page 435.
- Ⓜ Moen® **M•PACT®** Common Valve System

ROTHBURY™ Moentrol® Transfer Valve Shower Spa Components

All Brushed Nickel faucet components feature the LifeShine® Non-Tarnish Finish.

		MODEL NUMBER	LIST PRICE	FINISH/ CONNECTION	CASE QTY
2/3 FUNCTION TRANSFER VALVE ONLY					
 <ul style="list-style-type: none"> • use with 3372 or 3375 transfer valve • valve: sold separately  	PREMIUM				
	TS5205	153.60	Chrome	6	
	TS5205BN	205.35	Brushed Nickel	6	
	TS5205ORB	216.35	Oil Rubbed Bronze	6	
  <ul style="list-style-type: none"> • type of function: two independent one shared • must be used with: Posi-Temp® or Moentrol® valve 	3372	172.00	1/2" CC	12	
	  <ul style="list-style-type: none"> • type of function: two independent functions • must be used with: Posi-Temp® or Moentrol® valve 	3375	172.00	1/2" CC	12

HOW TO ORDER A COMPLETE TRANSFER VALVE









NOTES

 Moen® **M•PACT**® Common Valve System
DURALAST® Duralast® Cartridge



ROTHBURY™ Transfer Valve Shower Spa Components

All Brushed Nickel faucet components feature the LifeShine® Non-Tarnish Finish.

		MODEL NUMBER	LIST PRICE	FINISH/ CONNECTION	CASE QTY
MOENTROL® WITH TRANSFER VALVE					
 <ul style="list-style-type: none"> • showerhead type: showerhead sold separately • valve: sold separately  	PREMIUM	TS4211	234.30	Chrome	3
		TS4211BN	320.80	Brushed Nickel	3
		TS4211ORB	337.90	Oil Rubbed Bronze	3
 <ul style="list-style-type: none"> • ports: four; two outlets • adjustable temp limit stop: included • check stops: included • type of function: two independent one shared • includes: volume control • not recommended: for tub spout application 		3320	275.85	1/2" IPS inlets/cc outlets	6
		3330	275.85	1/2" CC	6
 <ul style="list-style-type: none"> • ports: four; two outlets • adjustable temp limit stop: included • check stops: included • type of function: two independent functions • includes: volume control • not recommended: for tub spout application 		3350	275.85	1/2" CC	6

HOW TO ORDER A COMPLETE MOENTROL WITH TRANSFER VALVE















NOTES

 Moen® **M•PACT®** Common Valve System

ROTHBURY™ Moentrol® Tub/Showering

All Brushed Nickel faucet components feature the LifeShine® Non-Tarnish Finish.

MOENTROL® TUB/SHOWER		MODEL NUMBER	LIST PRICE	FINISH/ CONNECTION	CASE QTY
 <ul style="list-style-type: none"> • showerhead functions: one-function • showerhead type: standard • showerhead size: 6-1/2" diameter spray head • showerhead flow rate: 2.5 gpm (9.5 L/min) max. • spout length: 7 5/8" • spout connection type: slip fit • tub spout type: diverter • valve: sold separately 	PREMIUM				
	TS3213	332.85	Chrome	3	
	TS3213BN	757.50	Brushed Nickel	3	
	TS3213ORB	797.90	Oil Rubbed Bronze	3	
 <ul style="list-style-type: none"> • description: pressure balanced valve with volume control • ports: four • adjustable temp limit stop: included • checks: included • includes: volume control 	3510	164.10	1/2" IPS	6	
	3520	164.10	1/2" CC	6	
 <ul style="list-style-type: none"> • description: pressure balanced valve with volume control • ports: four • adjustable temp limit stop: included • check stops: included • includes: volume control 	3570 ♦	195.50	1/2" CC	6	

MOENTROL® SHOWER ONLY		MODEL NUMBER	LIST PRICE	FINISH/ CONNECTION	CASE QTY
 <ul style="list-style-type: none"> • showerhead functions: one-function • showerhead type: standard • showerhead size: 6-1/2" diameter spray head • showerhead flow rate: 2.5 gpm (9.5 L/min) max. • valve: sold separately 	PREMIUM				
	TS3212	245.25	Chrome	3	
	TS3212BN	593.10	Brushed Nickel	3	
	TS3212ORB	624.80	Oil Rubbed Bronze	3	
 <ul style="list-style-type: none"> • description: pressure balanced valve with volume control • ports: four • adjustable temp limit stop: included • checks: included • includes: volume control 	3510	164.10	1/2" IPS	6	
	3520	164.10	1/2" CC	6	
 <ul style="list-style-type: none"> • description: pressure balanced valve with volume control • ports: four • adjustable temp limit stop: included • check stops: included • includes: volume control 	3570 ♦	195.50	1/2" CC	6	

HOW TO ORDER A COMPLETE TUB/SHOWER FAUCET

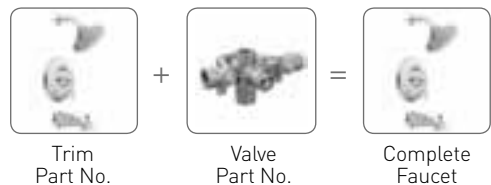







NOTES

- ♦ Also available in bulk pack. See page 435.
- Ⓜ Moen® **M•PACT**® Common Valve System



ROTHBURY™ Moentrol® Tub/Showering

All Brushed Nickel faucet components feature the LifeShine® Non-Tarnish Finish.

		MODEL NUMBER	LIST PRICE	FINISH/ CONNECTION	CASE QTY
MOENTROL® VALVE ONLY					
 <ul style="list-style-type: none"> valve: sold separately  	PREMIUM				
		TS3211	183.75	Chrome	3
		TS3211BN	457.70	Brushed Nickel	3
		TS3211ORB	482.15	Oil Rubbed Bronze	3
 	<ul style="list-style-type: none"> description: pressure balanced valve with volume control ports: four adjustable temp limit stop: included checks: included includes: volume control 	3510	164.10	1/2" IPS	6
		3520	164.10	1/2" CC	6
 	<ul style="list-style-type: none"> description: pressure balanced valve with volume control ports: four adjustable temp limit stop: included check stops: included includes: volume control 	3570 ♦	195.50	1/2" CC	6

HOW TO ORDER A COMPLETE VALVE











NOTES

- ♦ Also available in bulk pack. See page 435.
- Ⓜ Moen® **M•PACT®** Common Valve System

ROTHBURY™ Posi-Temp® Showering

All Brushed Nickel faucet components feature the LifeShine® Non-Tarnish Finish.

		MODEL NUMBER	LIST PRICE	FINISH/ CONNECTION	CASE QTY
POSI-TEMP® TUB/SHOWER					
	<ul style="list-style-type: none"> • showerhead functions: one-function • showerhead type: standard • showerhead size: 6-1/2" diameter spray head • showerhead flow rate: 2.5 gpm (9.5 L/min) max. • spout length: 7 5/8" • spout connection type: slip fit • tub spout type: diverter • valve: sold separately 	PREMIUM			
		TS2213	289.40	Chrome	3
		TS2213BN	536.20	Brushed Nickel	3
		TS2213ORB	564.85	Oil Rubbed Bronze	3
					
	<ul style="list-style-type: none"> • showerhead functions: one-function • showerhead type: eco-performance showerhead • showerhead size: 6-1/2" diameter spray head • showerhead flow rate: 2.0 transitioning to 1.75 gpm • spout length: 7 5/8" • spout connection type: slip fit • tub spout type: diverter • valve: sold separately 	PREMIUM			
		TS2213EP	289.40	Chrome	3
		TS2213EPBN	536.20	Brushed Nickel	3
		TS2213EPORB	564.85	Oil Rubbed Bronze	3
					
	<ul style="list-style-type: none"> • description: pressure balanced cycling valve • ports: four • adjustable temp limit stop: included 	2510 ♦	119.75	1/2" IPS	6
		2520 ♦	119.75	1/2" CC	6
		2580 ♦	119.75	1/2" Crimp ring PEX	6
					
	<ul style="list-style-type: none"> • description: pressure balanced cycling valve • ports: four • adjustable temp limit stop: included • quarter turn stops: included 	2570 ♦	145.35	1/2" CC	6
		2590 ♦	145.35	1/2" IPS	6
					

HOW TO ORDER A COMPLETE TUB/SHOWER FAUCET

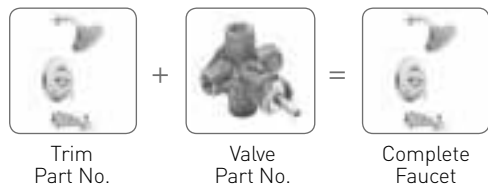









NOTES

- ♦ Also available in bulk pack. See page 435.
- Ⓜ Moen® **M•PACT**® Common Valve System

ROTHBURY™ Posi-Temp® Showering

All Brushed Nickel faucet components feature the LifeShine® Non-Tarnish Finish.

		MODEL NUMBER	LIST PRICE	FINISH/ CONNECTION	CASE QTY
POSI-TEMP® SHOWER ONLY					
 <ul style="list-style-type: none"> • showerhead functions: one-function • showerhead type: standard • showerhead size: 6-1/2" diameter spray head • showerhead flow rate: 2.5 gpm (9.5 L/min) max. • valve: sold separately 	PREMIUM	TS2212	227.55	Chrome	3
		TS2212BN	421.75	Brushed Nickel	3
		TS2212ORB	444.10	Oil Rubbed Bronze	3
 <ul style="list-style-type: none"> • showerhead functions: one-function • showerhead type: eco-performance showerhead • showerhead size: 6-1/2" diameter spray head • showerhead flow rate: 2.0 transitioning to 1.75 gpm • valve: sold separately 	PREMIUM	TS2212EP	227.55	Chrome	3
		TS2212EPBN	421.75	Brushed Nickel	3
		TS2212EPORB	444.10	Oil Rubbed Bronze	3
 <ul style="list-style-type: none"> • description: pressure balanced cycling valve • ports: four • adjustable temp limit stop: included 		2510 ♦	119.75	1/2" IPS	6
		2520 ♦	119.75	1/2" CC	6
		2580 ♦	119.75	1/2" Crimp ring PEX	6
 <ul style="list-style-type: none"> • description: pressure balanced cycling valve • ports: four • adjustable temp limit stop: included • quarter turn stops: included 		2570 ♦	145.35	1/2" CC	6
		2590 ♦	145.35	1/2" IPS	6

ROTHBURY™

HOW TO ORDER A COMPLETE SHOWER FAUCET

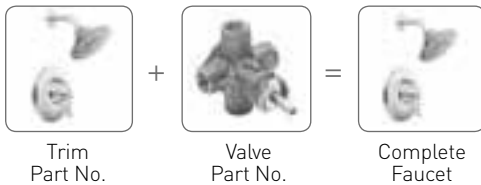







NOTES

- ♦ Also available in bulk pack. See page 435.
- Ⓜ Moen® **M•PACT**® Common Valve System

ROTHBURY™ Posi-Temp® Showering

All Brushed Nickel faucet components feature the LifeShine® Non-Tarnish Finish.

		MODEL NUMBER	LIST PRICE	FINISH/ CONNECTION	CASE QTY
POSI-TEMP® VALVE ONLY					
 <ul style="list-style-type: none"> valve: sold separately  		PREMIUM			
		TS2211	170.70	Chrome	3
		TS2211BN	316.00	Brushed Nickel	3
		TS2211ORB	332.90	Oil Rubbed Bronze	3
  <ul style="list-style-type: none"> description: pressure balanced cycling valve ports: four adjustable temp limit stop: included 		2510 ♦	119.75	1/2" IPS	6
		2520 ♦	119.75	1/2" CC	6
		2580 ♦	119.75	1/2" Crimp ring PEX	6
  <ul style="list-style-type: none"> description: pressure balanced cycling valve ports: four adjustable temp limit stop: included quarter turn stops: included 		2570 ♦	145.35	1/2" CC	6
		2590 ♦	145.35	1/2" IPS	6

HOW TO ORDER A COMPLETE VALVE



NOTES

- ♦ Also available in bulk pack. See page 435.
- Ⓜ Moen® **M•PACT**® Common Valve System



ROTHBURY™ Perfectly Matched Bath Accessories

Moen® bath accessories CANNOT be combined with Moen® faucet parts on a Purchase Order.

Moen makes it easy to coordinate the entire style and look of the bathroom. Our Rothbury™ bath accessories perfectly match the style and finish of our Rothbury™ faucets. Total coordination of the bath has never been easier.

For more information on ordering Rothbury™ bath accessories or other matching Moen® bath accessories, contact Moen Bath Accessory Customer Service at **800-882-0116**, contact your local Moen sales representative, or visit us at **www.moen.com**.

MODEL NUMBER	LIST PRICE EACH	DESCRIPTION	QTY
Chrome (CH)			
YB8201CH	59.75	Tank Lever	24
YB8203CH	45.80	Double Robe Hook	24
YB8205CH	12.05	Drawer Knob	48
YB8207CH	24.15	Drawer Pull	48
(P) YB8208CH	84.25	Pivoting Paper Holder	6
YB8218CH	96.90	18" Towel Bar	6
YB8224CH	100.35	24" Towel Bar	6
YB8286CH	67.70	Hand Towel Bar	6
Brushed Nickel (BN)			
YB8201BN	64.50	Tank Lever	24
YB8203BN	49.50	Double Robe Hook	24
YB8205BN	13.95	Drawer Knob	48
YB8207BN	26.05	Drawer Pull	48
(P) YB8208BN	90.90	Pivoting Paper Holder	6
YB8218BN	104.65	18" Towel Bar	6
YB8224BN	108.50	24" Towel Bar	6
YB8286BN	73.00	Hand Towel Bar	6
Oil Rubbed Bronze (ORB)			
YB8201ORB	70.90	Tank Lever	24
YB8203ORB	54.45	Double Robe Hook	24
YB8205ORB	15.25	Drawer Knob	48
YB8207ORB	28.40	Drawer Pull	48
(P) YB8208ORB	100.00	Pivoting Paper Holder	6
YB8218ORB	115.10	18" Towel Bar	6
YB8224ORB	119.35	24" Towel Bar	6
YB8286ORB	80.35	Hand Towel Bar	6



YB8201
Tank Lever



YB8203
Double Robe Hook



YB8205
Drawer Knob



YB8207
Drawer Pull

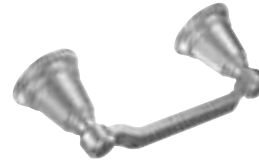

YB8208 (P)
Pivoting Paper Holder



YB8218
18" Towel Bar



YB8224
24" Towel Bar



YB8286
Hand Towel Bar

ROTHBURY™ Perfectly Matched Bath Accessories



LIGHTING

MODEL NUMBER	LIST PRICE EACH	DESCRIPTION	QTY
Chrome (CH)			
YB8261CH	153.50	One Globe Bath Light	2
YB8262CH	214.80	Two Globe Bath Light	2
YB8263CH	266.70	Three Globe Bath Light	2
Brushed Nickel (BN)			
YB8261BN	191.85	One Globe Bath Light	2
YB8262BN	268.50	Two Globe Bath Light	2
YB8263BN	333.50	Three Globe Bath Light	2
Oil Rubbed Bronze (ORB)			
YB8261ORB	191.85	One Globe Bath Light	2
YB8262ORB	268.50	Two Globe Bath Light	2
YB8263ORB	333.50	Three Globe Bath Light	2
Replacement Globe			
YB8269	28.15	Replacement Globe	3



YB8261
One Globe Light



YB8262
Two Globe Light



YB8263
Three Globe Light



YB8269
Replacement Globe















Bulbs not included.

All Rothbury™ lighting fixtures can be mounted facing either upward or downward (rings need to be removed if mounted up).
List price is per each (unless otherwise noted). Product can be ordered by case quantity or individually.



ICON™ Bathroom Faucets

All Brushed Nickel faucet components feature the LifeShine® Non-Tarnish Finish.

	MODEL NUMBER	LIST PRICE	FINISH/ CONNECTION	CASE QTY
ONE-HANDLE BATHROOM FAUCET				
 <ul style="list-style-type: none"> • application: one or three hole • supply line length: flexible • connection size: 3/8" • connection type: compression • deckplate: included • drain assembly: metal • drain assembly type: lift rod   DURALAST®	PREMIUM			
	S6500	361.80	Chrome	3
	S6500BN	597.40	Brushed Nickel	3
 <ul style="list-style-type: none"> • description: vessel extension kit • includes: parts to convert to grid drain • includes: two 2.5" extensions 	A1717	135.35	Chrome	6
	A1717BN	193.95	Brushed Nickel	6
TWO-HANDLE CENTERSET BATHROOM FAUCET				
 <ul style="list-style-type: none"> • application: three hole • center dimensions: 4" center • connection size: 1/2" • connection type: IPS • drain assembly: metal • drain assembly type: lift rod  	PREMIUM			
	S6510	297.70	Chrome	3
	S6510BN	451.80	Brushed Nickel	3
TWO-HANDLE WIDESPREAD BATHROOM FAUCET				
 <ul style="list-style-type: none"> • application: three hole • center dimensions: 8" - 16" center • drain assembly: metal • drain assembly type: lift rod • valve: sold separately   	PREMIUM			
	TS6520	311.05	Chrome	3
	TS6520BN	532.85	Brushed Nickel	3
 <ul style="list-style-type: none"> • application: three hole • center dimensions: 8" - 16" center • drain assembly: metal • drain assembly type: lift rod  DURALOCK® DURALAST®	9000 ♦	123.55	1/2" IPS	6

HOW TO ORDER A COMPLETE BATHROOM TUB FAUCET

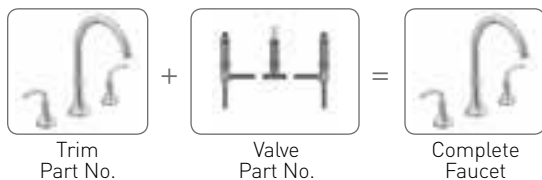











NOTES

- ♦ Also available in bulk pack. See page 435.
 - Ⓜ Moen® **M•PACT®** Common Valve System
 - DURALOCK®** Duralock® Quick Connections
 - DURALAST®** Duralast® Cartridge
- Refer to lavatory waste assemblies on page 403.
Refer to specification sheet for critical dimensions for installation.

ICON™ Roman Tubs

All Brushed Nickel faucet components feature the LifeShine® Non-Tarnish Finish.

	MODEL NUMBER	LIST PRICE	FINISH/ CONNECTION	CASE QTY
TWO-HANDLE ROMAN TUB				
 <ul style="list-style-type: none"> • application: three hole • spout reach: 7.88" • valve: sold separately 	PREMIUM TS963	434.75	Chrome	3
	TS963BN	619.00	Brushed Nickel	3
 <ul style="list-style-type: none"> • application: three hole • deck thickness: 1/8" to 3-3/8" rough-in deck • center dimensions: adjustable • adjustable spout shank: included • test plug: included 	4792	143.70	1/2" CC	6
 <ul style="list-style-type: none"> • application: three hole • deck thickness: 1/8" to 2-3/4" rough-in deck • center dimensions: 10" - 24" center • adjustable spout shank: included • test plug: included 	4793	162.70	1/2" CPVC, Crimp ring PEX	6
	4794	155.15	1/2" Crimp ring PEX, Cold Expansion PEX	6
 <ul style="list-style-type: none"> • application: three hole • deck thickness: 1/8" to 1-7/8" rough-in deck • center dimensions: 10" center • non-adjustable spout shank: included • test plug: included 	4796	135.35	1/2" CC	6
	4797	138.00	1/2" CPVC, Crimp ring PEX	6
	4798	138.00	1/2" Crimp ring PEX, Cold Expansion PEX	6
 <ul style="list-style-type: none"> • description: high flow thermostatic mixing valve for roman tubs • ports: three • ASSE standard 1070: yes • flow rate: 12.0 gpm (45.4 L/min) max. 	104465	173.00	1/2" CC	12
	104466	173.00	1/2" IPS	12
 <ul style="list-style-type: none"> • description: PEX transition fittings (2) and clips • connections: adapts standard 1/2" PEX barb to 1/2" PEX cold expansion 	140715	10.75	1/2" PEX	200

HOW TO ORDER A COMPLETE ROMAN TUB FAUCET

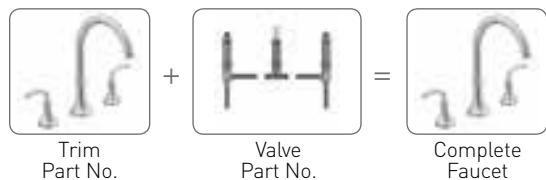









NOTES

 Moen® **M•PACT**® Common Valve System

Thermostatic Mixing Valve service kits, see page 498.

ICON™ Roman Tubs

All Brushed Nickel faucet components feature the LifeShine® Non-Tarnish Finish.

		MODEL NUMBER	LIST PRICE	FINISH/ CONNECTION	CASE QTY
TWO-HANDLE ROMAN TUB WITH HANDSHOWER					
 <ul style="list-style-type: none"> • application: four hole • showerhead type: handshower • handshower flow rate: 2.0 transitioning to 1.75 gpm • spray functions: one-function • spout reach: 7.88" • valve: sold separately 	PREMIUM				
		TS964	677.25	Chrome	3
		TS964BN	1,136.20	Brushed Nickel	3
 <ul style="list-style-type: none"> • application: four hole • deck thickness: 1/8" to 2-5/8" rough-in deck • center dimensions: adjustable • non-adjustable spout shank: included • test plug: included 		9792	323.75	1/2" CC	6
 <ul style="list-style-type: none"> • application: four hole • deck thickness: 1/8" to 2-5/8" rough-in deck • center dimensions: 10" - 24" center • non-adjustable spout shank: included • test plug: included 		9793	331.35	1/2" CPVC, Crimp ring PEX	6
 <ul style="list-style-type: none"> • description: high flow thermostatic mixing valve for roman tubs • ports: three • ASSE standard 1070: yes • flow rate: 12.0 gpm (45.4 L/min) max. 		104465	173.00	1/2" CC	12
		104466	173.00	1/2" IPS	12
 <ul style="list-style-type: none"> • description: PEX transition fittings (2) and clips • connections: adapts standard 1/2" PEX barb to 1/2" PEX cold expansion 		140715	10.75	1/2" PEX	200

ICON™

HOW TO ORDER A COMPLETE ROMAN TUB FAUCET

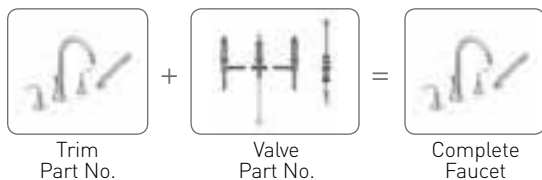





NOTES





 Moen® **M•PACT®** Common Valve System

Thermostatic Mixing Valve service kits, see page 498.

ICON™ 3/4" Thermostatic Showering

All Brushed Nickel faucet components feature the LifeShine® Non-Tarnish Finish.

	MODEL NUMBER	LIST PRICE	FINISH/ CONNECTION	CASE QTY
EXACTTEMP® VALVE ONLY				
 <ul style="list-style-type: none"> description: temperature control valve trim requires: separate volume control valve valve: sold separately 	PREMIUM			
	TS3900	273.90	Chrome	3
	TS3900BN	414.35	Brushed Nickel	3
 <ul style="list-style-type: none"> description: thermostatic rough-in valve ports: four adjustable temp limit stop: included check stops: included 	PREMIUM			
	S3371	508.90	3/4" IPS	6

EXACTTEMP® VOLUME CONTROL VALVE ONLY				
 <ul style="list-style-type: none"> valve: sold separately 	PREMIUM			
	TS3200	126.45	Chrome	6
	TS3200BN	168.60	Brushed Nickel	6
 <ul style="list-style-type: none"> description: volume control rough-in valve includes: volume control 	PREMIUM			
	S3600	129.35	3/4" IPS	12

HOW TO ORDER AN EXACTTEMP VALVE

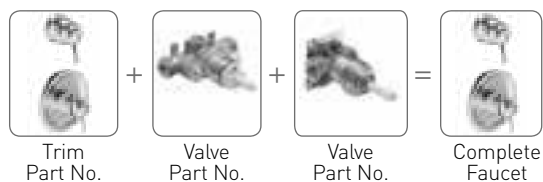







NOTES

Moën® **M•PACT®** Common Valve System

ICON™ Moentrol® Transfer Valve Shower Spa Components

All Brushed Nickel faucet components feature the LifeShine® Non-Tarnish Finish.

		MODEL NUMBER	LIST PRICE	FINISH/ CONNECTION	CASE QTY
MOENTROL® WITH TRANSFER VALVE					
 <ul style="list-style-type: none"> showerhead type: showerhead sold separately valve: sold separately  	PREMIUM	TS4112	190.15	Chrome	3
		TS4112BN	260.35	Brushed Nickel	3
 		3320	275.85	1/2" IPS inlets/cc outlets	6
		3330	275.85	1/2" CC	6
 		3350	275.85	1/2" CC	6

HOW TO ORDER A COMPLETE MOENTROL WITH TRANSFER VALVE

















NOTES

 Moen® **M•PACT®** Common Valve System

ICON™ Moentrol® Showering

All Brushed Nickel faucet components feature the LifeShine® Non-Tarnish Finish.

		MODEL NUMBER	LIST PRICE	FINISH/ CONNECTION	CASE QTY
MOENTROL® TUB/SHOWER					
 <ul style="list-style-type: none"> • showerhead functions: one-function • showerhead type: standard • showerhead size: 5-7/8" diameter spray head • showerhead flow rate: 2.5 gpm (9.5 L/min) max. • spout length: 7 1/4" • spout connection type: slip fit • tub spout type: diverter • valve: sold separately  		PREMIUM			
		TS2156	265.60	Chrome	3
		TS2156BN	577.25	Brushed Nickel	3
 <ul style="list-style-type: none"> • description: pressure balanced valve with volume control • ports: four • adjustable temp limit stop: included • checks: included • includes: volume control 		3510	164.10	1/2" IPS	6
		3520	164.10	1/2" CC	6
 <ul style="list-style-type: none"> • description: pressure balanced valve with volume control • ports: four • adjustable temp limit stop: included • check stops: included • includes: volume control 		3570 ♦	195.50	1/2" CC	6

MOENTROL® SHOWER ONLY					
 <ul style="list-style-type: none"> • showerhead functions: one-function • showerhead type: standard • showerhead size: 5-7/8" diameter spray head • showerhead flow rate: 2.5 gpm (9.5 L/min) max. • valve: sold separately  		PREMIUM			
		TS2155	195.70	Chrome	3
	TS2155BN	451.95	Brushed Nickel	3	
 <ul style="list-style-type: none"> • description: pressure balanced valve with volume control • ports: four • adjustable temp limit stop: included • checks: included • includes: volume control 		3510	164.10	1/2" IPS	6
		3520	164.10	1/2" CC	6
 <ul style="list-style-type: none"> • description: pressure balanced valve with volume control • ports: four • adjustable temp limit stop: included • check stops: included • includes: volume control 		3570 ♦	195.50	1/2" CC	6

HOW TO ORDER A COMPLETE TUB/SHOWER FAUCET

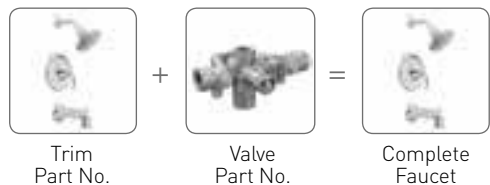







NOTES

- ♦ Also available in bulk pack. See page 435.
- Ⓜ Moen® **M•FACT**® Common Valve System



ICON™ Moentrol® Showering

All Brushed Nickel faucet components feature the LifeShine® Non-Tarnish Finish.

		MODEL NUMBER	LIST PRICE	FINISH/ CONNECTION	CASE QTY
MOENTROL® VALVE ONLY					
 <ul style="list-style-type: none"> valve: sold separately  	PREMIUM				
	TS2154	146.70	Chrome	3	
	TS2154BN	348.70	Brushed Nickel	3	
 	<ul style="list-style-type: none"> description: pressure balanced valve with volume control ports: four adjustable temp limit stop: included checks: included includes: volume control 	3510	164.10	1/2" IPS	6
		3520	164.10	1/2" CC	6
 	<ul style="list-style-type: none"> description: pressure balanced valve with volume control ports: four adjustable temp limit stop: included check stops: included includes: volume control 	3570 ♦	195.50	1/2" CC	6

HOW TO ORDER A COMPLETE VALVE

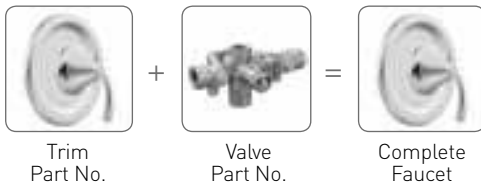









NOTES

- ♦ Also available in bulk pack. See page 435.
- Ⓜ Moen® **M•PACT**® Common Valve System

ICON™ Posi-Temp® Showering

All Brushed Nickel faucet components feature the LifeShine® Non-Tarnish Finish.

		MODEL NUMBER	LIST PRICE	FINISH/ CONNECTION	CASE QTY
POSI-TEMP® TUB/SHOWER					
 <ul style="list-style-type: none"> • showerhead functions: one-function • showerhead type: standard • showerhead size: 5-7/8" diameter spray head • showerhead flow rate: 2.5 gpm (9.5 L/min) max. • spout length: 7 1/4" • spout connection type: slip fit • tub spout type: diverter • valve: sold separately 	PREMIUM	TS2143	234.95	Chrome	3
		TS2143BN	435.10	Brushed Nickel	3
 <ul style="list-style-type: none"> • showerhead functions: one-function • showerhead type: eco-performance showerhead • showerhead size: 5-7/8" diameter spray head • showerhead flow rate: 1.75 gpm (6.65 L/min) max. • spout length: 7 1/4" • spout connection type: slip fit • tub spout type: diverter • valve: sold separately 	PREMIUM	TS2143EP	234.95	Chrome	3
		TS2143EPBN	435.10	Brushed Nickel	3
 		2510 ◆	119.75	1/2" IPS	6
		2520 ◆	119.75	1/2" CC	6
		2580 ◆	119.75	1/2" Crimp ring PEX	6
 		2570 ◆	145.35	1/2" CC	6
		2590 ◆	145.35	1/2" IPS	6

HOW TO ORDER A COMPLETE TUB/SHOWER FAUCET

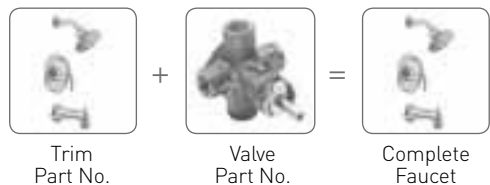









NOTES

- ◆ Also available in bulk pack. See page 435.
- Ⓜ Moen® **M•FACT**® Common Valve System



ICON™ Posi-Temp® Showering

All Brushed Nickel faucet components feature the LifeShine® Non-Tarnish Finish.

		MODEL NUMBER	LIST PRICE	FINISH/ CONNECTION	CASE QTY
POSI-TEMP® SHOWER ONLY					
 <ul style="list-style-type: none"> • showerhead functions: one-function • showerhead type: standard • showerhead size: 5-7/8" diameter spray head • showerhead flow rate: 2.5 gpm (9.5 L/min) max. • valve: sold separately 	PREMIUM	TS2142	184.65	Chrome	3
		TS2142BN	342.20	Brushed Nickel	3
 <ul style="list-style-type: none"> • showerhead functions: one-function • showerhead type: eco-performance showerhead • showerhead size: 5-7/8" diameter spray head • showerhead flow rate: 1.75 gpm (6.65 L/min) max. • valve: sold separately 	PREMIUM	TS2142EP	184.65	Chrome	3
		TS2142EPBN	342.20	Brushed Nickel	3
  <ul style="list-style-type: none"> • description: pressure balanced cycling valve • ports: four • adjustable temp limit stop: included 		2510 ♦	119.75	1/2" IPS	6
		2520 ♦	119.75	1/2" CC	6
		2580 ♦	119.75	1/2" Crimp ring PEX	6
  <ul style="list-style-type: none"> • description: pressure balanced cycling valve • ports: four • adjustable temp limit stop: included • quarter turn stops: included 		2570 ♦	145.35	1/2" CC	6
		2590 ♦	145.35	1/2" IPS	6

ICON™

HOW TO ORDER A COMPLETE SHOWER FAUCET

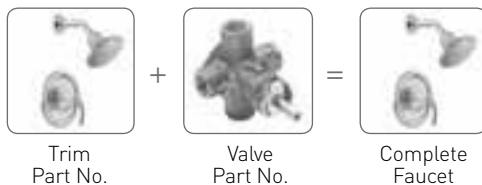







NOTES

- ♦ Also available in bulk pack. See page 435.
- Ⓜ Moen® **M•PACT**® Common Valve System

ICON™ Posi-Temp® Showering

All Brushed Nickel faucet components feature the LifeShine® Non-Tarnish Finish.

		MODEL NUMBER	LIST PRICE	FINISH/ CONNECTION	CASE QTY
POSI-TEMP® VALVE ONLY					
 <ul style="list-style-type: none"> valve: sold separately  		PREMIUM			
		TS2141	138.45	Chrome	3
		TS2141BN	256.45	Brushed Nickel	3
  <ul style="list-style-type: none"> description: pressure balanced cycling valve ports: four adjustable temp limit stop: included 		2510 ♦	119.75	1/2" IPS	6
		2520 ♦	119.75	1/2" CC	6
		2580 ♦	119.75	1/2" Crimp ring PEX	6
  <ul style="list-style-type: none"> description: pressure balanced cycling valve ports: four adjustable temp limit stop: included quarter turn stops: included 		2570 ♦	145.35	1/2" CC	6
		2590 ♦	145.35	1/2" IPS	6

HOW TO ORDER A COMPLETE VALVE

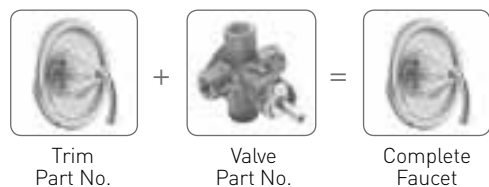

NOTES

- ♦ Also available in bulk pack. See page 435.
- Ⓜ Moen® **M•PACT**® Common Valve System



Moen® bath accessories CANNOT be combined with Moen® faucet parts on a Purchase Order.

Moen makes it easy to coordinate the entire style and look of the bathroom. Our Icon™ bath accessories perfectly match the style and finish of our Icon™ faucets. Total coordination of the bath has never been easier.

For more information on ordering Icon™ bath accessories or other matching Moen® bath accessories, contact Moen Bath Accessory Customer Service at **800-882-0116**, contact your local Moen sales representative, or visit us at **www.moen.com**.

1/2-in. Round Bar

MODEL NUMBER	LIST PRICE EACH	DESCRIPTION	QTY
Chrome (CH)			
YB5801CH	42.95	Tank Lever	24
YB5803CH	33.05	Double Robe Hook	24
YB5805CH	10.20	Drawer Knob	144
YB5807CH	20.30	Drawer Pull	48
^(P) YB5808CH	60.50	Pivoting Paper Holder	6
YB5818CH	70.10	18" Towel Bar	6
YB5822CH	94.00	24" Double Towel Bar	6
YB5824CH	72.40	24" Towel Bar	6
YB5886CH	49.30	Towel Ring	6
YB5890CH	93.10	Vanity Shelf	6
Brushed Nickel (BN)			
YB5801BN	46.60	Tank Lever	6
YB5803BN	35.75	Double Robe Hook	24
YB5805BN	13.35	Drawer Knob	144
YB5807BN	24.75	Drawer Pull	144
^(P) YB5808BN	65.65	Pivoting Paper Holder	6
YB5818BN	75.55	18" Towel Bar	6
YB5822BN	99.30	24" Double Towel Bar	6
YB5824BN	78.40	24" Towel Bar	6
YB5886BN	52.80	Towel Ring	6
YB5890BN	98.35	Vanity Shelf	6



YB5801
Tank Lever



YB5803
Double Robe Hook



YB5805
Drawer Knob



YB5807
Drawer Pull

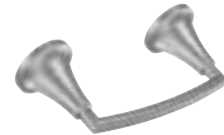

YB5808 ^(P)
Pivoting Paper Holder



YB5818
18" Towel Bar



YB5822
24" Double Towel Bar



YB5824
24" Towel Bar



YB5886
Towel Ring



YB8081
Pro-Fit® Installation Mounting Template (See page 90 for more information about the Pro-Fit® Installation System.)













YB5890
Vanity Shelf

^(P) Denotes pivoting paper holder

List price is per each (unless otherwise noted). Product can be ordered by case quantity or individually.

WYNFORD® Bathroom Faucets

All Brushed Nickel and Polished Nickel faucet components feature the LifeShine® Non-Tarnish Finish.

		MODEL NUMBER	LIST PRICE	FINISH/ CONNECTION	CASE QTY
ONE-HANDLE BATHROOM FAUCET					
 <ul style="list-style-type: none"> • application: one or three hole • supply line length: flexible • connection size: 3/8" • connection type: compression • deckplate: included • drain assembly: metal • drain assembly type: lift rod   DURALAST®		4500	258.85	Chrome	3
		4500BN	385.55	Brushed Nickel	3
		4500NL	385.55	Polished Nickel	3
		4500ORB	424.15	Oil Rubbed Bronze	3
 <ul style="list-style-type: none"> • application: one hole • supply line length: flexible • connection size: 3/8" • connection type: compression • drain assembly: 140780 sold separately   DURALAST®		4507	383.25	Chrome	3
		4507BN	560.25	Brushed Nickel	3
		4507ORB	616.25	Oil Rubbed Bronze	3
 <ul style="list-style-type: none"> • drain assembly: metal • drain assembly type: spring loaded pop-up • drain assembly size: 1-1/4" • drain assembly: 1-1/4" non-overflow 		140780	59.20	Chrome	12
		140780BN	82.60	Brushed Nickel	12
		140780ORB	93.30	Oil Rubbed Bronze	12
TWO-HANDLE CENTERSET BATHROOM FAUCET					
 <ul style="list-style-type: none"> • application: three hole • center dimensions: 4" center • connection size: 1/2" • connection type: IPS • drain assembly: metal • drain assembly type: lift rod  		4505	246.60	Chrome	3
		4505BN	367.25	Brushed Nickel	3
		4505NL	367.25	Polished Nickel	3
		4505ORB	404.00	Oil Rubbed Bronze	3









NOTES

DURALAST® Duralast® Cartridge

Refer to lavatory waste assemblies on page 403.

WYNFORD® Bathroom Faucets

All Brushed Nickel and Polished Nickel faucet components feature the LifeShine® Non-Tarnish Finish.

	MODEL NUMBER	LIST PRICE	FINISH/ CONNECTION	CASE QTY
TWO-HANDLE WIDESPREAD BATHROOM FAUCET				
 <ul style="list-style-type: none"> • application: three hole • center dimensions: 8" - 16" center • drain assembly: metal • drain assembly type: lift rod • valve: sold separately   	T4520	257.60	Chrome	3
	T4520BN	432.95	Brushed Nickel	3
	T4520NL	432.95	Polished Nickel	3
	T4520ORB	476.20	Oil Rubbed Bronze	3
 <ul style="list-style-type: none"> • application: three hole • center dimensions: 8" - 16" center • drain assembly: metal • drain assembly type: lift rod • valve: sold separately  	T4524	262.70	Chrome	3
	T4524BN	441.55	Brushed Nickel	3
	T4524NL	441.55	Polished Nickel	3
	T4524ORB	485.75	Oil Rubbed Bronze	3
 <ul style="list-style-type: none"> • application: three hole • center dimensions: 8" - 16" center • drain assembly: metal • drain assembly type: lift rod  DURALOCK® DURALAST®	9000 ♦	123.55	1/2" IPS	6

WYNFORD®

HOW TO ORDER A COMPLETE BATHROOM FAUCET

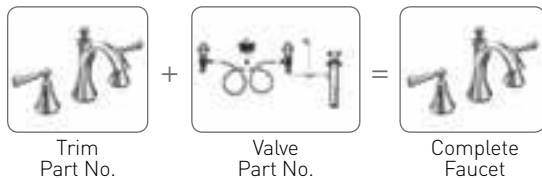











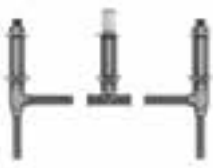

NOTES

- ♦ Also available in bulk pack. See page 435.
- Moën® **M•PACT®** Common Valve System
- DURALOCK®** Duralock® Quick Connections
- DURALAST®** Duralast® Cartridge

Refer to specification sheet for critical dimensions for installation.

WYNFORD® Roman Tub

All Brushed Nickel and Polished Nickel faucet components feature the LifeShine® Non-Tarnish Finish.

	MODEL NUMBER	LIST PRICE	FINISH/ CONNECTION	CASE QTY
TWO-HANDLE ROMAN TUB				
 <ul style="list-style-type: none"> • application: three hole • spout reach: 7.50" • valve: sold separately 	T653	364.55	Chrome	3
	T653BN	509.45	Brushed Nickel	3
	T653NL	509.45	Polished Nickel	3
	T653ORB	560.35	Oil Rubbed Bronze	3
 <ul style="list-style-type: none"> • application: three hole • spout reach: 7.50" • valve: sold separately 	T657	371.80	Chrome	3
	T657BN	519.60	Brushed Nickel	3
	T657NL	519.60	Polished Nickel	3
	T657ORB	571.55	Oil Rubbed Bronze	3
 <ul style="list-style-type: none"> • application: three hole • deck thickness: 1/8" to 3-3/8" rough-in deck • center dimensions: adjustable • adjustable spout shank: included • test plug: included 	4792	143.70	1/2" CC	6
 <ul style="list-style-type: none"> • application: three hole • deck thickness: 1/8" to 2-3/4" rough-in deck • center dimensions: 10" - 24" center • adjustable spout shank: included • test plug: included 	4793	162.70	1/2" CPVC, Crimp ring PEX	6
	4794	155.15	1/2" Crimp ring PEX, Cold Expansion PEX	6
 <ul style="list-style-type: none"> • application: three hole • deck thickness: 1/8" to 1-7/8" rough-in deck • center dimensions: 10" center • non-adjustable spout shank: included • test plug: included 	4796	135.35	1/2" CC	6
	4797	138.00	1/2" CPVC, Crimp ring PEX	6
	4798	138.00	1/2" Crimp ring PEX, Cold Expansion PEX	6
 <ul style="list-style-type: none"> • description: high flow thermostatic mixing valve for roman tubs • ports: three • ASSE standard 1070; yes • flow rate: 12.0 gpm (45.4 L/min) max. 	104465	173.00	1/2" CC	12
	104466	173.00	1/2" IPS	12
 <ul style="list-style-type: none"> • description: PEX transition fittings (2) and clips • connections: adapts standard 1/2" PEX barb to 1/2" PEX cold expansion 	140715	10.75	1/2" PEX	200

HOW TO ORDER A COMPLETE ROMAN TUB FAUCET

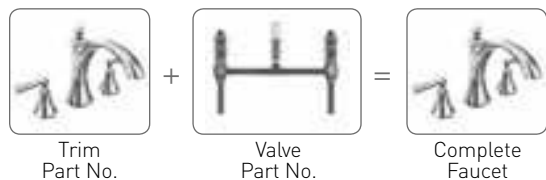

NOTES











 Moen® **M•PACT**® Common Valve System

Thermostatic Mixing Valve service kits, see page 498.



WYNFORD® Roman Tubs

All Brushed Nickel and Polished Nickel faucet components feature the LifeShine® Non-Tarnish Finish.

	MODEL NUMBER	LIST PRICE	FINISH/ CONNECTION	CASE QTY
TWO-HANDLE ROMAN TUB WITH HANDSHOWER				
 <ul style="list-style-type: none"> • application: four hole • showerhead type: handshower • handshower flow rate: 2.0 transitioning to 1.75 gpm • spray functions: one-function • spout reach: 7.50" • valve: sold separately 	T654	567.90	Chrome	3
	T654BN	934.80	Brushed Nickel	3
	T654NL	934.80	Polished Nickel	3
	T654ORB	1,028.25	Oil Rubbed Bronze	3
 <ul style="list-style-type: none"> • application: four hole • showerhead type: handshower • handshower flow rate: 2.0 transitioning to 1.75 gpm • spray functions: one-function • spout reach: 7.50" • valve: sold separately 	T658	579.30	Chrome	3
	T658BN	953.50	Brushed Nickel	3
	T658ORB	1,048.80	Oil Rubbed Bronze	3
 <ul style="list-style-type: none"> • application: four hole • deck thickness: 1/8" to 2-5/8" rough-in deck • center dimensions: adjustable • non-adjustable spout shank: included • test plug: included 	9792	323.75	1/2" CC	6
 <ul style="list-style-type: none"> • application: four hole • deck thickness: 1/8" to 2-5/8" rough-in deck • center dimensions: 10" - 24" center • non-adjustable spout shank: included • test plug: included 	9793	331.35	1/2" CPVC, Crimp ring PEX	6
 <ul style="list-style-type: none"> • description: high flow thermostatic mixing valve for roman tubs • ports: three • ASSE standard 1070: yes • flow rate: 12.0 gpm (45.4 L/min) max. 	104465	173.00	1/2" CC	12
	104466	173.00	1/2" IPS	12
 <ul style="list-style-type: none"> • description: PEX transition fittings (2) and clips • connections: adapts standard 1/2" PEX barb to 1/2" PEX cold expansion 	140715	10.75	1/2" PEX	200

WYNFORD®

HOW TO ORDER A COMPLETE ROMAN TUB FAUCET

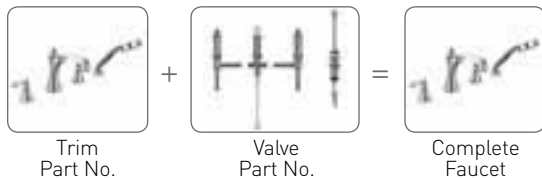

NOTES

 Moen® **M•PACT®** Common Valve System

Thermostatic Mixing Valve service kits, see page 498.

WYNFORD® Transfer Valve Shower Spa Components

All Brushed Nickel and Polished Nickel faucet components feature the LifeShine® Non-Tarnish Finish.

	MODEL NUMBER	LIST PRICE	FINISH/ CONNECTION	CASE QTY
3 INDEPENDENT FUNCTION TRANSFER VALVE ONLY				
 <ul style="list-style-type: none"> • use with 3362 transfer valve • valve: sold separately 	T4512	106.50	Chrome	12
	T4512BN	143.10	Brushed Nickel	12
	T4512NL	143.10	Polished Nickel	12
	T4512ORB	157.40	Oil Rubbed Bronze	12
2/3 FUNCTION TRANSFER VALVE ONLY				
 <ul style="list-style-type: none"> • use with 3372 or 3375 transfer valve • valve: sold separately 	T4511	106.50	Chrome	12
	T4511BN	143.10	Brushed Nickel	12
	T4511NL	143.10	Polished Nickel	12
	T4511ORB	157.40	Oil Rubbed Bronze	12
 	3372	172.00	1/2" CC	12
	<ul style="list-style-type: none"> • type of function: two independent one shared • must be used with: Posi-Temp® or Moentrol® valve 			
 	3375	172.00	1/2" CC	12
	<ul style="list-style-type: none"> • type of function: two independent functions • must be used with: Posi-Temp® or Moentrol® valve 			

HOW TO ORDER A COMPLETE VALVE

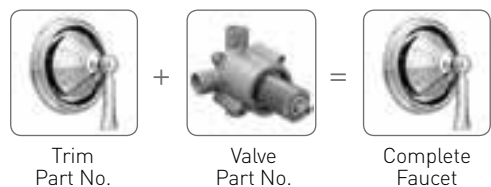









NOTES

 Moen® **M•PACT**® Common Valve System
DURALAST® Duralast® Cartridge



WYNFORD® Moentrol® Showering

All Brushed Nickel and Polished Nickel faucet components feature the LifeShine® Non-Tarnish Finish.

		MODEL NUMBER	LIST PRICE	FINISH/ CONNECTION	CASE QTY
MOENTROL® TUB/SHOWER					
	<ul style="list-style-type: none"> • showerhead functions: one-function • showerhead type: rainshower • showerhead size: 7" diameter spray head • showerhead flow rate: 2.5 gpm (9.5 L/min) max. • spout length: 7-15/16" • spout connection type: slip fit • tub spout type: diverter • valve: sold separately 	T5503	249.05	Chrome	3
		T5503BN	484.80	Brushed Nickel	3
		T5503NL	484.80	Polished Nickel	3
		T5503ORB	533.25	Oil Rubbed Bronze	3
					
	<ul style="list-style-type: none"> • showerhead type: showerhead sold separately • spout length: 7-15/16" • spout connection type: slip fit • tub spout type: diverter • valve: sold separately 	T5503NH	168.55	Chrome	3
		T5503NHBN	340.50	Brushed Nickel	3
		T5503NHORB	374.55	Oil Rubbed Bronze	3
					
	<ul style="list-style-type: none"> • description: pressure balanced valve with volume control • ports: four • adjustable temp limit stop: included • checks: included • includes: volume control 	3510	164.10	1/2" IPS	6
		3520	164.10	1/2" CC	6
					
	<ul style="list-style-type: none"> • description: pressure balanced valve with volume control • ports: four • adjustable temp limit stop: included • check stops: included • includes: volume control 	3570 ♦	195.50	1/2" CC	6
					

HOW TO ORDER A COMPLETE TUB/SHOWER FAUCET

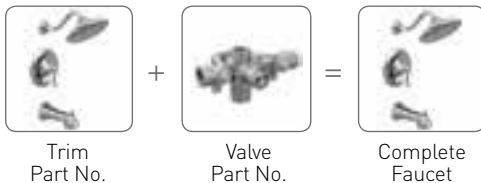

















NOTES

- ♦ Also available in bulk pack. See page 435.
- Ⓜ Moen® **M•PACT**® Common Valve System

WYNFORD® Moentrol® Showering

All Brushed Nickel and Polished Nickel faucet components feature the LifeShine® Non-Tarnish Finish.

		MODEL NUMBER	LIST PRICE	FINISH/ CONNECTION	CASE QTY
MOENTROL® SHOWER ONLY					
 <ul style="list-style-type: none"> • showerhead functions: one-function • showerhead type: rainshower • showerhead size: 7" diameter spray head • showerhead flow rate: 2.5 gpm (9.5 L/min) max. • valve: sold separately  		T5502	183.50	Chrome	3
		T5502BN	379.70	Brushed Nickel	3
		T5502NL	379.70	Polished Nickel	3
		T5502ORB	417.65	Oil Rubbed Bronze	3
 <ul style="list-style-type: none"> • showerhead type: showerhead sold separately • valve: sold separately  		T5502NH	143.85	Chrome	3
		T5502NHBN	297.25	Brushed Nickel	3
		T5502NHORB	326.95	Oil Rubbed Bronze	3
 <ul style="list-style-type: none"> • description: pressure balanced valve with volume control • ports: four • adjustable temp limit stop: included • checks: included • includes: volume control 		3510	164.10	1/2" IPS	6
		3520	164.10	1/2" CC	6
 <ul style="list-style-type: none"> • description: pressure balanced valve with volume control • ports: four • adjustable temp limit stop: included • check stops: included • includes: volume control 		3570 ♦	195.50	1/2" CC	6
MOENTROL® VALVE ONLY					
 <ul style="list-style-type: none"> • valve: sold separately  		T5501	137.50	Chrome	3
		T5501BN	292.90	Brushed Nickel	3
		T5501NL	292.90	Polished Nickel	3
		T5501ORB	322.25	Oil Rubbed Bronze	3
 <ul style="list-style-type: none"> • description: pressure balanced valve with volume control • ports: four • adjustable temp limit stop: included • checks: included • includes: volume control 		3510	164.10	1/2" IPS	6
		3520	164.10	1/2" CC	6
 <ul style="list-style-type: none"> • description: pressure balanced valve with volume control • ports: four • adjustable temp limit stop: included • check stops: included • includes: volume control 		3570 ♦	195.50	1/2" CC	6

HOW TO ORDER A COMPLETE SHOWER FAUCET

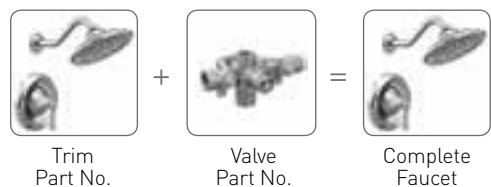











NOTES

- ♦ Also available in bulk pack. See page 435.
- Ⓜ Moen® **M•PACT**® Common Valve System

WYNFORD® Posi-Temp® Showering

All Brushed Nickel and Polished Nickel faucet components feature the LifeShine® Non-Tarnish Finish.

		MODEL NUMBER	LIST PRICE	FINISH/ CONNECTION	CASE QTY
POSI-TEMP® TUB/SHOWER					
	<ul style="list-style-type: none"> • showerhead functions: one-function • showerhead type: standard • showerhead size: 5-7/8" diameter spray head • showerhead flow rate: 2.5 gpm (9.5 L/min) max. • spout length: 7-15/16" • spout connection type: slip fit • tub spout type: diverter • valve: sold separately 	T4503	196.90	Chrome	3
		T4503BN	357.90	Brushed Nickel	3
		T4503NL	357.90	Polished Nickel	3
		T4503ORB	393.85	Oil Rubbed Bronze	3
	<ul style="list-style-type: none"> • showerhead functions: one-function • showerhead type: eco-performance showerhead • showerhead size: 5-7/8" diameter spray head • showerhead flow rate: 1.75 gpm (6.65 L/min) max. • spout length: 7-15/16" • spout connection type: slip fit • tub spout type: diverter • valve: sold separately 	T4503EP	196.90	Chrome	3
		T4503EPBN	357.90	Brushed Nickel	3
		T4503EPORB	393.85	Oil Rubbed Bronze	3
	<ul style="list-style-type: none"> • showerhead type: showerhead sold separately • spout length: 7-15/16" • spout connection type: slip fit • tub spout type: diverter • valve: sold separately 	T4503NH	132.60	Chrome	3
		T4503NHBN	259.35	Brushed Nickel	3
	<ul style="list-style-type: none"> • description: pressure balanced cycling valve • ports: four • adjustable temp limit stop: included 	2510 ♦	119.75	1/2" IPS	6
		2520 ♦	119.75	1/2" CC	6
		2580 ♦	119.75	1/2" Crimp ring PEX	6
	<ul style="list-style-type: none"> • description: pressure balanced cycling valve • ports: four • adjustable temp limit stop: included • quarter turn stops: included 	2570 ♦	145.35	1/2" CC	6
		2590 ♦	145.35	1/2" IPS	6

WYNFORD®

HOW TO ORDER A COMPLETE TUB/SHOWER FAUCET

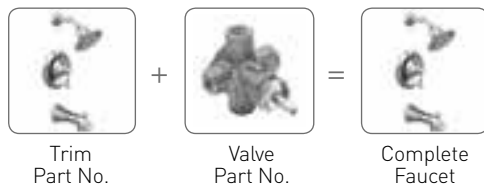















NOTES

- ♦ Also available in bulk pack. See page 435.
- Ⓜ Moen® **M•PACT**® Common Valve System

WYNFORD® Posi-Temp® Showering

All Brushed Nickel and Polished Nickel faucet components feature the LifeShine® Non-Tarnish Finish.

	MODEL NUMBER	LIST PRICE	FINISH/ CONNECTION	CASE QTY
POSI-TEMP® SHOWER ONLY				
 <ul style="list-style-type: none"> • showerhead functions: one-function • showerhead type: standard • showerhead size: 5-7/8" diameter spray head • showerhead flow rate: 2.5 gpm (9.5 L/min) max. • valve: sold separately  	T4502	154.80	Chrome	3
	T4502BN	281.55	Brushed Nickel	3
	T4502NL	281.55	Polished Nickel	3
	T4502ORB	309.65	Oil Rubbed Bronze	3
 <ul style="list-style-type: none"> • showerhead functions: one-function • showerhead type: eco-performance showerhead • showerhead size: 5-7/8" diameter spray head • showerhead flow rate: 1.75 gpm (6.65 L/min) max. • valve: sold separately   	T4502EP	154.80	Chrome	3
	T4502EPBN	281.55	Brushed Nickel	3
	T4502EPORB	309.65	Oil Rubbed Bronze	3
 <ul style="list-style-type: none"> • showerhead type: showerhead sold separately • valve: sold separately  	T4502NH	123.15	Chrome	3
	T4502NHBN	223.65	Brushed Nickel	3
 <ul style="list-style-type: none"> • description: pressure balanced cycling valve • ports: four • adjustable temp limit stop: included 	2510 ♦	119.75	1/2" IPS	6
	2520 ♦	119.75	1/2" CC	6
	2580 ♦	119.75	1/2" Crimp ring PEX	6
 <ul style="list-style-type: none"> • description: pressure balanced cycling valve • ports: four • adjustable temp limit stop: included • quarter turn stops: included 	2570 ♦	145.35	1/2" CC	6
	2590 ♦	145.35	1/2" IPS	6

HOW TO ORDER A COMPLETE SHOWER FAUCET

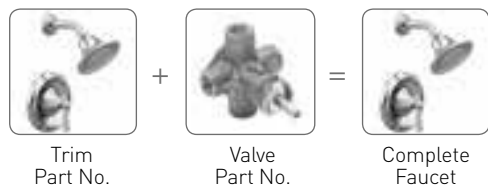













NOTES

- ♦ Also available in bulk pack. See page 435.
- Ⓜ Moen® **M•PACT**® Common Valve System

WYNFORD® Posi-Temp® Showering, Bidets

All Brushed Nickel and Polished Nickel faucet components feature the LifeShine® Non-Tarnish Finish.

		MODEL NUMBER	LIST PRICE	FINISH/ CONNECTION	CASE QTY
POSI-TEMP® VALVE ONLY					
 <ul style="list-style-type: none"> valve: sold separately  		T4501	116.15	Chrome	3
		T4501BN	210.90	Brushed Nickel	3
		T4501NL	210.90	Polished Nickel	3
		T4501ORB	232.05	Oil Rubbed Bronze	3
 <ul style="list-style-type: none"> description: pressure balanced cycling valve ports: four adjustable temp limit stop: included 		2510 ♦	119.75	1/2" IPS	6
		2520 ♦	119.75	1/2" CC	6
		2580 ♦	119.75	1/2" Crimp ring PEX	6
 <ul style="list-style-type: none"> description: pressure balanced cycling valve ports: four adjustable temp limit stop: included quarter turn stops: included 		2570 ♦	145.35	1/2" CC	6
		2590 ♦	145.35	1/2" IPS	6
TWO-HANDLE BIDET					
 <ul style="list-style-type: none"> center dimensions: 8" - 16" center valve: sold separately  		T5245	401.50	Chrome	3
		T5245BN	549.85	Brushed Nickel	3
		T5245ORB	604.80	Oil Rubbed Bronze	3
 <ul style="list-style-type: none"> application: three hole center dimensions: 8" - 16" center 		9265	254.45	1/2" IPS	6
					

WYNFORD®

HOW TO ORDER A COMPLETE VALVE



HOW TO ORDER A COMPLETE BIDET FAUCET

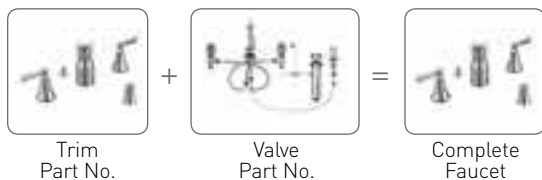

NOTES

- ♦ Also available in bulk pack. See page 435.
- Ⓜ Moen® **M•PACT**® Common Valve System
- DURALOCK** Duralock™ Quick Connections
- DURALAST** Duralast® Cartridge

WYNFORD® Perfectly Matched Bath Accessories

Moen® bath accessories CANNOT be combined with Moen® faucet parts on a Purchase Order.

Moen makes it easy to coordinate the entire style and look of the bathroom. Our Wynford® bath accessories perfectly match the style and finish of our Wynford® faucets. Total coordination of the bath has never been easier.

For more information on ordering Wynford® bath accessories or other matching Moen® bath accessories, contact Moen Bath Accessory Customer Service at **800-882-0116**, contact your local Moen sales representative, or visit us at www.moen.com.

3/4-in. x 3/8-in. Oval Bar

MODEL NUMBER	LIST PRICE EACH	DESCRIPTION	QTY
Chrome (CH)			
YB5201CH	32.50	Tank Lever	24
YB5203CH	24.95	Double Robe Hook	24
(P) YB5208CH	45.65	Pivoting Paper Holder	6
YB5218CH	53.00	18" Towel Bar	6
YB5222CH	70.95	24" Double Towel Bar	6
YB5224CH	54.65	24" Towel Bar	6
YB5275CH	113.05	Shower Basket	6
YB5286CH	37.20	Towel Ring	6
Brushed Nickel (BN)			
YB5201BN	35.85	Tank Lever	6
YB5203BN	27.50	Double Robe Hook	24
(P) YB5208BN	50.50	Pivoting Paper Holder	6
YB5218BN	58.25	18" Towel Bar	6
YB5222BN	76.45	24" Double Towel Bar	6
YB5224BN	60.30	24" Towel Bar	6
YB5275BN	129.35	Shower Basket	6
YB5286BN	40.70	Towel Ring	6
Polished Nickel (NL)			
YB5201NL	39.40	Tank Lever	24
YB5203NL	30.25	Double Robe Hook	24
(P) YB5208NL	55.60	Pivoting Paper Holder	6
YB5218NL	64.05	18" Towel Bar	6
YB5222NL	84.20	24" Double Towel Bar	6
YB5224NL	66.40	24" Towel Bar	6
YB5286NL	44.75	Towel Ring	6
Oil Rubbed Bronze (ORB)			
YB5201ORB	39.40	Tank Lever	24
YB5203ORB	30.25	Double Robe Hook	24
(P) YB5208ORB	55.60	Pivoting Paper Holder	6
YB5218ORB	64.05	18" Towel Bar	6
YB5222ORB	84.20	24" Double Towel Bar	6
YB5224ORB	66.40	24" Towel Bar	6
YB5286ORB	44.75	Towel Ring	6
Old World Bronze (OWB)			
YB5275OWB	140.25	Shower Basket	6



YB5201
Tank Lever

YB5203
Double Robe Hook



YB5208 **(P)**
Pivoting Paper Holder

YB5218
18" Towel Bar



YB5222
24" Double Towel Bar



YB5224
24" Towel Bar

YB5286
Towel Ring

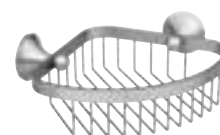

YB5275
Corner Shower Basket
[Available in CH, BN and OWB]

















(P) Denotes pivoting paper holder

List price is per each (unless otherwise noted). Product can be ordered by case quantity or individually.



ALIGN® Bathroom Faucets

All Brushed Nickel faucet components feature the LifeShine® Non-Tarnish Finish.

		MODEL NUMBER	LIST PRICE	FINISH/ CONNECTION	CASE QTY	
ONE-HANDLE BATHROOM FAUCET						
	<ul style="list-style-type: none"> • application: one or three hole • supply line length: flexible • connection size: 3/8" • connection type: compression • deckplate: included • drain assembly: metal • drain assembly type: lift rod • red/blue markings: included 	6190	258.85	Chrome	3	
		6190BN	385.55	Brushed Nickel	3	
		6190BL	424.15	Matte Black	3	
		  DURALAST®				
	<ul style="list-style-type: none"> • application: one or three hole • supply line length: flexible • connection size: 3/8" • connection type: compression • deckplate: sold separately • drain assembly: metal • drain assembly type: lift rod • red/blue markings: included 	6191	251.95	Chrome	3	
		6191BN	378.70	Brushed Nickel	3	
		6191BL	416.60	Matte Black	3	
		DECKPLATE SOLD SEPARATELY				
		172666	16.15	Chrome	20	
172666BN	20.05	Brushed Nickel	20			
172666BL	28.25	Matte Black	20			
  DURALAST®						
	<ul style="list-style-type: none"> • application: one or three hole • supply line length: flexible • connection size: 3/8" • connection type: compression • deckplate: sold separately • drain assembly: 140780 sold separately • red/blue markings: included 	6192	383.25	Chrome	3	
		6192BN	560.25	Brushed Nickel	3	
		DECKPLATE SOLD SEPARATELY				
		172666	16.15	Chrome	20	
172666BN	20.05	Brushed Nickel	20			
  DURALAST®						
	<ul style="list-style-type: none"> • drain assembly: metal • drain assembly type: spring loaded pop-up • drain assembly size: 1-1/4" • drain assembly: 1-1/4" non-overflow 	140780	59.20	Chrome	12	
		140780BN	82.60	Brushed Nickel	12	
TWO-HANDLE WIDESPREAD BATHROOM FAUCET						
	<ul style="list-style-type: none"> • application: three hole • center dimensions: 8" - 16" center • drain assembly: metal • drain assembly type: lift rod • valve: sold separately 	T6193	257.60	Chrome	3	
		T6193BN	432.95	Brushed Nickel	3	
		T6193BL	476.20	Matte Black	3	
  						
	<ul style="list-style-type: none"> • application: three hole • center dimensions: 8" - 16" center • drain assembly: metal • drain assembly type: lift rod 	9000 ♦	123.55	1/2" IPS	6	
		 DURALOCK® DURALAST®				

ALIGN®











NOTES

- ♦ Also available in bulk pack. See page 435.
- Ⓜ Moen® **M•PACT®** Common Valve System
- DURALOCK® Duralock® Quick Connections
- DURALAST® Duralast® Cartridge

Refer to lavatory waste assemblies on page 403.

ALIGN® Roman Tubs

All Brushed Nickel faucet components feature the LifeShine® Non-Tarnish Finish.

	MODEL NUMBER	LIST PRICE	FINISH/ CONNECTION	CASE QTY	
TWO-HANDLE ROMAN TUB					
 <ul style="list-style-type: none"> • application: three hole • spout reach: 7.90" • valve: sold separately 	T393 T393BN NEW! T393BL Finish, Ships Q1	364.55 509.45 539.85	Chrome Brushed Nickel Matte Black	3 3 3	
	 <ul style="list-style-type: none"> • application: three hole • deck thickness: 1/8" to 3-3/8" rough-in deck • center dimensions: adjustable • adjustable spout shank: included • test plug: included 	4792	143.70	1/2" CC	6
	 <ul style="list-style-type: none"> • application: three hole • deck thickness: 1/8" to 2-3/4" rough-in deck • center dimensions: 10" - 24" center • adjustable spout shank: included • test plug: included 	4793 4794	162.70 155.15	1/2" CPVC, Crimp ring PEX 1/2" Crimp ring PEX, Cold Expansion PEX	6 6
 <ul style="list-style-type: none"> • application: three hole • deck thickness: 1/8" to 1-7/8" rough-in deck • center dimensions: 10" center • non-adjustable spout shank: included • test plug: included 	4796 4797 4798	135.35 138.00 138.00	1/2" CC 1/2" CPVC, Crimp ring PEX 1/2" Crimp ring PEX, Cold Expansion PEX	6 6 6	
 <ul style="list-style-type: none"> • description: high flow thermostatic mixing valve for roman tubs • ports: three • ASSE standard 1070: yes • flow rate: 12.0 gpm (45.4 L/min) max. 	104465 104466	173.00 173.00	1/2" CC 1/2" IPS	12 12	
 <ul style="list-style-type: none"> • description: PEX transition fittings (2) and clips • connections: adapts standard 1/2" PEX barb to 1/2" PEX cold expansion 	140715	10.75	1/2" PEX	200	

HOW TO ORDER A COMPLETE ROMAN TUB FAUCET

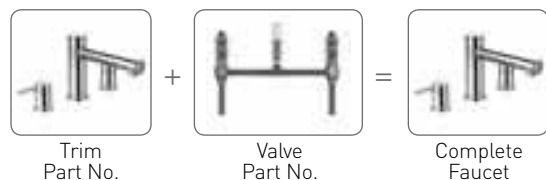









NOTES

 Moen® **M•PACT**® Common Valve System

Thermostatic Mixing Valve service kits, see page 498.

ALIGN® Roman Tubs

All Brushed Nickel faucet components feature the LifeShine® Non-Tarnish Finish.

	MODEL NUMBER	LIST PRICE	FINISH/ CONNECTION	CASE QTY
TWO-HANDLE ROMAN TUB WITH HANDSHOWER				
 <ul style="list-style-type: none"> • application: four hole • showerhead type: handshower • handshower flow rate: 2.0 transitioning to 1.75 gpm • spray functions: one-function • spout reach: 7.90" • valve: sold separately 	T394	567.90	Chrome	3
	T394BN	934.80	Brushed Nickel	3
 <ul style="list-style-type: none"> • application: four hole • deck thickness: 1/8" to 2-5/8" rough-in deck • center dimensions: adjustable • non-adjustable spout shank: included • test plug: included 	9792	323.75	1/2" CC	6
 <ul style="list-style-type: none"> • application: four hole • deck thickness: 1/8" to 2-5/8" rough-in deck • center dimensions: 10" - 24" center • non-adjustable spout shank: included • test plug: included 	9793	331.35	1/2" CPVC, Crimp ring PEX	6
 <ul style="list-style-type: none"> • description: high flow thermostatic mixing valve for roman tubs • ports: three • ASSE standard 1070: yes • flow rate: 12.0 gpm (45.4 L/min) max. 	104465	173.00	1/2" CC	12
	104466	173.00	1/2" IPS	12
 <ul style="list-style-type: none"> • description: PEX transition fittings (2) and clips • connections: adapts standard 1/2" PEX barb to 1/2" PEX cold expansion 	140715	10.75	1/2" PEX	200



HOW TO ORDER A COMPLETE ROMAN TUB FAUCET

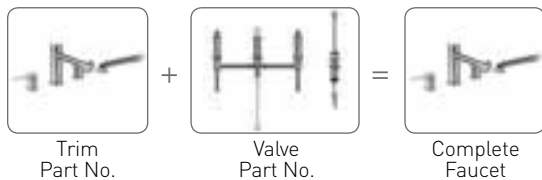











NOTES

 Moen® **M•PACT®** Common Valve System

Thermostatic Mixing Valve service kits, see page 498.

ALIGN® Transfer Valve Shower Spa Components

All Brushed Nickel faucet components feature the LifeShine® Non-Tarnish Finish.

	MODEL NUMBER	LIST PRICE	FINISH/ CONNECTION	CASE QTY
3 INDEPENDENT FUNCTION TRANSFER VALVE ONLY				
 <ul style="list-style-type: none"> • use with 3362 transfer valve • valve: sold separately 	T4192	106.50	Chrome	12
	NEW T4192BN	143.10	Brushed Nickel	12
	NEW T4192BL	157.40	Matte Black	12
 <ul style="list-style-type: none"> • ports: four • type of function: three independent function • must be used with: Posi-Temp® or Moentrol® valve 	3362	192.60	1/2" CC	6
2/3 FUNCTION TRANSFER VALVE ONLY				
 <ul style="list-style-type: none"> • use with 3372 or 3375 transfer valve • valve: sold separately 	T4191	106.50	Chrome	12
	T4191BN	143.10	Brushed Nickel	12
	T4191BL	157.40	Matte Black	12
 <ul style="list-style-type: none"> • type of function: two independent one shared • must be used with: Posi-Temp® or Moentrol® valve 	3372	172.00	1/2" CC	12
 <ul style="list-style-type: none"> • type of function: two independent functions • must be used with: Posi-Temp® or Moentrol® valve 	3375	172.00	1/2" CC	12

HOW TO ORDER A COMPLETE VALVE











NOTES

 Moen® **M•PACT®** Common Valve System
DURALAST® Duralast® Cartridge

ALIGN® Moentrol® Showering

All Brushed Nickel faucet components feature the LifeShine® Non-Tarnish Finish.

		MODEL NUMBER	LIST PRICE	FINISH/ CONNECTION	CASE QTY
MOENTROL® TUB/SHOWER					
	<ul style="list-style-type: none"> • showerhead functions: one-function • showerhead type: rainshower • showerhead size: 7" diameter spray head • showerhead flow rate: 2.5 gpm (9.5 L/min) max. • spout length: 7" • spout connection type: slip fit • tub spout type: diverter • valve: sold separately 	T3293	249.05	Chrome	3
		T3293BN	484.80	Brushed Nickel	3
	IMMERSION®				
	<ul style="list-style-type: none"> • showerhead type: showerhead sold separately • spout length: 5 1/2" • spout connection type: slip fit • tub spout type: diverter • valve: sold separately 	T3293NH	168.55	Chrome	3
		SFT3293NH	177.85	Chrome	3
		T3293NHBN	340.50	Brushed Nickel	3
					
	<ul style="list-style-type: none"> • description: pressure balanced valve with volume control • ports: four • adjustable temp limit stop: included • checks: included • includes: volume control 	3510	164.10	1/2" IPS	6
		3520	164.10	1/2" CC	6
					
	<ul style="list-style-type: none"> • description: pressure balanced valve with volume control • ports: four • adjustable temp limit stop: included • check stops: included • includes: volume control 	3570 ♦	195.50	1/2" CC	6
					

ALIGN®

HOW TO ORDER A COMPLETE TUB/SHOWER FAUCET

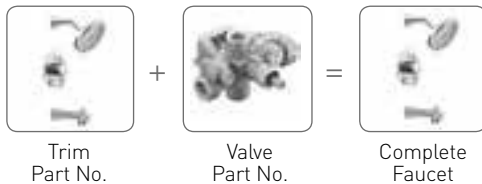

















NOTES

- ♦ Also available in bulk pack. See page 435.
- Ⓜ Moen® **M•PACT®** Common Valve System
- IMMERSION®** Immersion® Rainshower

ALIGN® Moentrol® Showering

All Brushed Nickel faucet components feature the LifeShine® Non-Tarnish Finish.

		MODEL NUMBER	LIST PRICE	FINISH/ CONNECTION	CASE QTY
MOENTROL® SHOWER ONLY					
 <ul style="list-style-type: none"> • showerhead functions: one-function • showerhead type: rainshower • showerhead size: 7" diameter spray head • showerhead flow rate: 2.5 gpm (9.5 L/min) max. • valve: sold separately 		T3292	183.50	Chrome	3
		T3292BN	379.70	Brushed Nickel	3
		  IMMERSION®			
 <ul style="list-style-type: none"> • showerhead type: showerhead sold separately • valve: sold separately 		T3292NH	140.70	Chrome	3
		T3292NHBN	297.25	Brushed Nickel	3
		 			
 <ul style="list-style-type: none"> • description: pressure balanced valve with volume control • ports: four • adjustable temp limit stop: included • checks: included • includes: volume control 		3510	164.10	1/2" IPS	6
		3520	164.10	1/2" CC	6
					
 <ul style="list-style-type: none"> • description: pressure balanced valve with volume control • ports: four • adjustable temp limit stop: included • check stops: included • includes: volume control 		3570 ♦	195.50	1/2" CC	6
					

MOENTROL® VALVE ONLY					
 <ul style="list-style-type: none"> • valve: sold separately 		T3291	137.50	Chrome	3
		T3291BN	292.90	Brushed Nickel	3
		 			
 <ul style="list-style-type: none"> • description: pressure balanced valve with volume control • ports: four • adjustable temp limit stop: included • checks: included • includes: volume control 		3510	164.10	1/2" IPS	6
		3520	164.10	1/2" CC	6
					
 <ul style="list-style-type: none"> • description: pressure balanced valve with volume control • ports: four • adjustable temp limit stop: included • check stops: included • includes: volume control 		3570 ♦	195.50	1/2" CC	6
					

HOW TO ORDER A COMPLETE SHOWER FAUCET

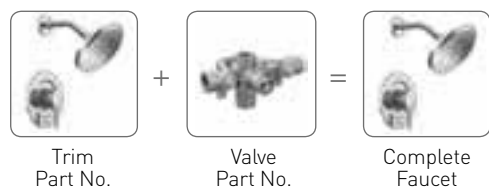

HOW TO ORDER A COMPLETE VALVE













NOTES

- ♦ Also available in bulk pack. See page 435.
- Moentrol icon Moen® **M•PACT®** Common Valve System
- IMMERSION® Immersion® Rainshower



ALIGN® Posi-Temp® Showering

All Brushed Nickel faucet components feature the LifeShine® Non-Tarnish Finish.

		MODEL NUMBER	LIST PRICE	FINISH/ CONNECTION	CASE QTY
POSI-TEMP® TUB/SHOWER					
	<ul style="list-style-type: none"> • showerhead functions: one-function • showerhead type: standard • showerhead size: 3-5/8" diameter spray head • showerhead flow rate: 2.5 gpm (9.5 L/min) max. • spout length: 7-3/8" • spout connection type: slip fit • tub spout type: diverter • red/blue markings: included • valve: sold separately 	T2193	196.90	Chrome	3
		T2193BN	357.90	Brushed Nickel	3
		NEW T2193BL	393.70	Matte Black	3
		Finish, Ships Q1			
					
	<ul style="list-style-type: none"> • showerhead functions: one-function • showerhead type: eco-performance showerhead • showerhead size: 3-5/8" diameter spray head • showerhead flow rate: 1.75 gpm (6.65 L/min) max. • spout length: 7-3/8" • spout connection type: slip fit • tub spout type: diverter • red/blue markings: included • valve: sold separately 	T2193EP	196.90	Chrome	3
		T2193EPBN	357.90	Brushed Nickel	3
		NEW T2193EPBL	393.70	Matte Black	3
		Finish, Ships Q1			
					
	<ul style="list-style-type: none"> • showerhead type: showerhead sold separately • spout length: 7-3/8" • spout connection type: slip fit • tub spout type: diverter • red/blue markings: included • valve: sold separately 	T2193NH	132.60	Chrome	3
		T2193NHBN	259.35	Brushed Nickel	3
		NEW T2193NHBL	285.30	Matte Black	3
					
	<ul style="list-style-type: none"> • description: pressure balanced cycling valve • ports: four • adjustable temp limit stop: included 	2510 ♦	119.75	1/2" IPS	6
		2520 ♦	119.75	1/2" CC	6
		2580 ♦	119.75	1/2" Crimp ring PEX	6
					
	<ul style="list-style-type: none"> • description: pressure balanced cycling valve • ports: four • adjustable temp limit stop: included • quarter turn stops: included 	2570 ♦	145.35	1/2" CC	6
		2590 ♦	145.35	1/2" IPS	6
					

ALIGN®

HOW TO ORDER A COMPLETE TUB/SHOWER FAUCET

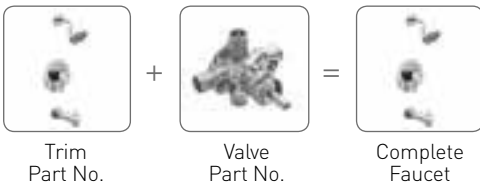













NOTES

- ♦ Also available in bulk pack. See page 435.
- Ⓜ Moen® **M•PACT**® Common Valve System

ALIGN® Posi-Temp® Showering

All Brushed Nickel faucet components feature the LifeShine® Non-Tarnish Finish.

	MODEL NUMBER	LIST PRICE	FINISH/ CONNECTION	CASE QTY	
POSI-TEMP® SHOWER ONLY					
 <ul style="list-style-type: none"> • showerhead functions: one-function • showerhead type: standard • showerhead size: 3-5/8" diameter spray head • showerhead flow rate: 2.5 gpm (9.5 L/min) max. • red/blue markings: included • valve: sold separately 	T2192 T2192BN  T2192BL Finish, Ships Q1	154.80 281.55 309.75	Chrome Brushed Nickel Matte Black	3 3 3	
	 <ul style="list-style-type: none"> • showerhead functions: one-function • showerhead type: eco-performance showerhead • showerhead size: 3-5/8" diameter spray head • showerhead flow rate: 1.75 gpm (6.65 L/min) max. • red/blue markings: included • valve: sold separately  	T2192EP T2192EPBN  T2192EPBL Finish, Ships Q1	154.80 281.55 309.75	Chrome Brushed Nickel Matte Black	3 3 3
		<ul style="list-style-type: none"> • showerhead type: showerhead sold separately • red/blue markings: included • valve: sold separately 	T2192NH T2192NHBN T2192NHBL	123.15 223.65 246.00	Chrome Brushed Nickel Matte Black
 <ul style="list-style-type: none"> • description: pressure balanced cycling valve • ports: four • adjustable temp limit stop: included 		2510 ♦ 2520 ♦ 2580 ♦	119.75 119.75 119.75	1/2" IPS 1/2" CC 1/2" Crimp ring PEX	6 6 6
	 <ul style="list-style-type: none"> • description: pressure balanced cycling valve • ports: four • adjustable temp limit stop: included • quarter turn stops: included 	2570 ♦ 2590 ♦	145.35 145.35	1/2" CC 1/2" IPS	6 6

HOW TO ORDER A COMPLETE SHOWER FAUCET















NOTES

- ♦ Also available in bulk pack. See page 435.
- Ⓜ Moen® **M•PACT**® Common Valve System

ALIGN® Posi-Temp® Showering, Bidets

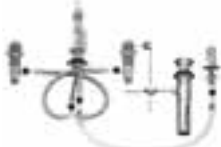
All Brushed Nickel faucet components feature the LifeShine® Non-Tarnish Finish.

	MODEL NUMBER	LIST PRICE	FINISH/ CONNECTION	CASE QTY
POSI-TEMP® VALVE ONLY				
 <ul style="list-style-type: none"> • red/blue markings: included • valve: sold separately  	T2191	116.15	Chrome	3
	T2191BN	210.90	Brushed Nickel	3
	T2191BL	232.05	Matte Black	3
 <ul style="list-style-type: none"> • description: pressure balanced cycling valve • ports: four • adjustable temp limit stop: included 	2510 ♦	119.75	1/2" IPS	6
	2520 ♦	119.75	1/2" CC	6
	2580 ♦	119.75	1/2" Crimp ring PEX	6
 <ul style="list-style-type: none"> • description: pressure balanced cycling valve • ports: four • adjustable temp limit stop: included • quarter turn stops: included 	2570 ♦	145.35	1/2" CC	6
	2590 ♦	145.35	1/2" IPS	6
TWO-HANDLE BIDET				
 <ul style="list-style-type: none"> • center dimensions: 8" - 16" center • valve: sold separately  	T5191	401.50	Chrome	3
	T5191BN	549.85	Brushed Nickel	3
 <ul style="list-style-type: none"> • application: three hole • center dimensions: 8" - 16" center  DURALOCK® DURALAST®	9265	254.45	1/2" IPS	6

ALIGN®

HOW TO ORDER A COMPLETE VALVE



HOW TO ORDER A COMPLETE BIDET FAUCET

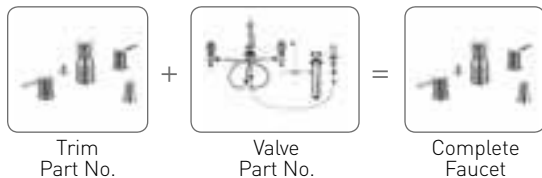

NOTES

- ♦ Also available in bulk pack. See page 435.
- Ⓜ Moen® **M•PACT®** Common Valve System
- DURALOCK: Duralock® Quick Connections
- DURALAST: Duralast® Cartridge

ALIGN® Perfectly Matched Bath Accessories

Moen® bath accessories CANNOT be combined with Moen® faucet parts on a Purchase Order.

Moen makes it easy to coordinate the entire style and look of the bathroom. Our Align® bath accessories perfectly match the style and finish of our Align® faucets. Total coordination of the bath has never been easier.

For more information on ordering Align® bath accessories or other matching Moen® bath accessories, contact Moen Bath Accessory Customer Service at **800-882-0116**, contact your local Moen sales representative, or visit us at **www.moen.com**.

MODEL NUMBER	LIST PRICE EACH	DESCRIPTION	5/8-in. Round Bar QTY
Chrome (CH)			
YB0402CH	45.25	Double Robe Hook	24
YB0403CH	24.95	Single Robe Hook	24
P YB0408CH	45.65	Pivoting Paper Holder	6
YB0409CH	38.85	Single-Post Paper Holder	6
YB0418CH	53.00	18" Towel Bar	6
YB0424CH	54.65	24" Towel Bar	6
YB0486CH	37.20	Hand Towel Bar	6
Brushed Nickel (BN)			
YB0402BN	51.45	Double Robe Hook	24
YB0403BN	27.50	Single Robe Hook	24
P YB0408BN	50.50	Pivoting Paper Holder	6
YB0409BN	42.75	Single-Post Paper Holder	6
YB0418BN	58.25	18" Towel Bar	6
YB0424BN	60.30	24" Towel Bar	6
YB0486BN	40.70	Hand Towel Bar	6
Matte Black			
YB0402BL	56.55	Double Robe Hook	24
YB0403BL	30.25	Single Robe Hook	24
P YB0408BL	55.55	Pivoting Paper Holder	6
YB0409BL	47.00	Single-Post Paper Holder	6
YB0418BL	64.05	18" Towel Bar	6
YB0424BL	66.35	24" Towel Bar	6
YB0486BL	44.75	Hand Towel Bar	6



YB0402 Swiveling Double Robe Hook



YB0403 Single Robe Hook



YB0408 **P** Pivoting Paper Holder



YB0409 Single-Post Paper Holder



YB0418 18" Towel Bar



YB0424 24" Towel Bar



YB0486 Hand Towel Bar

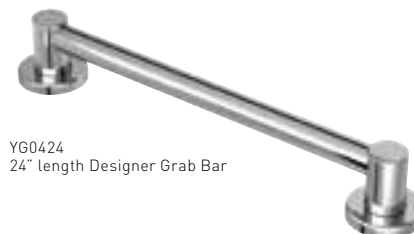

YB0424 24" length Designer Grab Bar

GRAB BARS

PERFECTLY MATCHED to Moen® Align® faucets and bath accessories. ADA-compliant.



SecureMount™ Grab Bars are manufactured with an innovative flange design that makes it easy to connect to the stud at multiple points.

To install grab bars securely without studs, use SecureMount™ Anchors. Sold separately.

MODEL NUMBER	LIST PRICE EACH	DESCRIPTION	QTY
1-1/4" • Chrome (CH)			
YG0412CH	88.85	12" Designer Grab Bar	6
YG0418CH	92.85	18" Designer Grab Bar	6
YG0424CH	96.95	24" Designer Grab Bar	6
YG0436CH	110.40	36" Designer Grab Bar	6
YG0442CH	162.00	42" Designer Grab Bar	6
1-1/4" • Brushed Nickel (BN)			
YG0412BN	107.40	12" Designer Grab Bar	6
YG0418BN	112.60	18" Designer Grab Bar	6
YG0424BN	121.50	24" Designer Grab Bar	6
YG0436BN	136.75	36" Designer Grab Bar	6
YG0442BN	202.50	42" Designer Grab Bar	6

P Denotes pivoting paper holder















Complies with Americans with Disabilities Act (ADA) specifications. SecureMount™ Grab Bars are tested to withstand 500 lb. pull when securely installed per instructions.

List price is per each (unless otherwise noted). Product can be ordered by case quantity or individually.



VOSS™ Bathroom Faucets

All Brushed Nickel faucet components feature the LifeShine® Non-Tarnish Finish.

	MODEL NUMBER	LIST PRICE	FINISH/ CONNECTION	CASE QTY
ONE-HANDLE BATHROOM FAUCET				
 <ul style="list-style-type: none"> • application: one or three hole • supply line length: flexible • connection size: 3/8" • connection type: compression • deckplate: included • drain assembly: metal • drain assembly type: lift rod   DURALAST™	6903	258.85	Chrome	3
	6903BN	385.55	Brushed Nickel	3
	6903ORB	424.15	Oil Rubbed Bronze	3
TWO-HANDLE CENTERSET BATHROOM FAUCET				
 <ul style="list-style-type: none"> • application: three hole • center dimensions: 4" center • connection size: 1/2" • connection type: IPS • drain assembly: metal • drain assembly type: lift rod  	6901	246.60	Chrome	3
	6901BN	367.25	Brushed Nickel	3
	6901ORB	404.00	Oil Rubbed Bronze	3
TWO-HANDLE WIDESPREAD BATHROOM FAUCET				
 <ul style="list-style-type: none"> • application: three hole • center dimensions: 8" - 16" center • drain assembly: metal • drain assembly type: lift rod • valve: sold separately   	T6905	257.60	Chrome	3
	T6905BN	432.95	Brushed Nickel	3
	T6905ORB	476.20	Oil Rubbed Bronze	3
  DURALOCK™ DURALAST™	9000 ♦	123.55	1/2" IPS	6



HOW TO ORDER A COMPLETE BATHROOM FAUCET

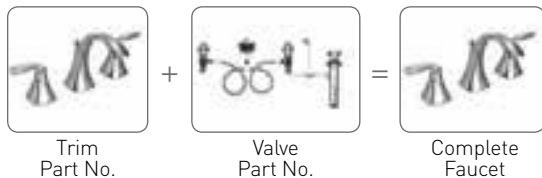







NOTES

- ♦ Also available in bulk pack. See page 435.
- Ⓜ Moen® **M•PACT**® Common Valve System
- DURALOCK** Duralock® Quick Connections
- DURALAST** Duralast® Cartridge

Refer to lavatory waste assemblies on page 403.
Refer to specification sheet for critical dimensions for installation.

VOSS™ Bathroom Faucets

All Brushed Nickel faucet components feature the LifeShine® Non-Tarnish Finish.

	MODEL NUMBER	LIST PRICE	FINISH/ CONNECTION	CASE QTY
TWO-HANDLE WALLMOUNT BATHROOM FAUCET				
 <ul style="list-style-type: none"> • application: three hole • center dimensions: 8" center • drain assembly: 140780 sold separately • valve: sold separately   	T6906	293.70	Chrome	3
	T6906BN	478.25	Brushed Nickel	3
	T6906ORB	526.20	Oil Rubbed Bronze	3
 <ul style="list-style-type: none"> • application: three hole • center dimensions: 8" center • drain assembly: 140780 sold separately • includes: mounting brackets 	9700	174.75	1/2" CC	3
 <ul style="list-style-type: none"> • drain assembly: metal • drain assembly type: spring loaded pop-up • drain assembly size: 1-1/4" • drain assembly: 1-1/4" non-overflow 	140780	59.20	Chrome	12
	140780BN	82.60	Brushed Nickel	12
	140780ORB	93.30	Oil Rubbed Bronze	12

HOW TO ORDER A COMPLETE BATHROOM FAUCET









NOTES

 Moen® **M•PACT**® Common Valve System

Refer to specification sheet for critical dimensions for installation.

VOSS™ Tub Filler Faucets

All Brushed Nickel faucet components feature the LifeShine® Non-Tarnish Finish.

	MODEL NUMBER	LIST PRICE	FINISH/ CONNECTION	CASE QTY
FREESTANDING TUB FILLER				
 <p>NEW! Ships Q2</p> <ul style="list-style-type: none"> • application: one hole • showerhead type: handshower • handshower functions: one-function • handshower flow rate: 1.75 gpm (6.65 L/min) max. • spout reach: 9.75" • valve: sold separately   <p>DURALAST®</p>	695	1,500.00	Chrome	1
	695BN	1,950.00	Brushed Nickel	1
	695ORB	2,145.00	Oil Rubbed Bronze	1
 <ul style="list-style-type: none"> • description: single riser floor joist mounting kit • application: one hole • quarter turn stops: included 	PREMIUM TS50100	275.75	1/2" NPT, CC	2
 <ul style="list-style-type: none"> • description: single riser concrete mounting kit • application: one hole • quarter turn stops: included 	PREMIUM TS50110	234.40	1/2" CC, NPT	2

VOSS™

HOW TO ORDER A COMPLETE TUB FILLER













NOTES

 Moen® **M•PACT®** Common Valve System
DURALAST® Duralast® Cartridge

Refer to specification sheet for critical dimensions for installation.

VOSS™ Roman Tubs

All Brushed Nickel faucet components feature the LifeShine® Non-Tarnish Finish.

	MODEL NUMBER	LIST PRICE	FINISH/ CONNECTION	CASE QTY
TWO-HANDLE ROMAN TUB				
 <ul style="list-style-type: none"> • application: three hole • spout reach: 8.25" • valve: sold separately 	T693	364.55	Chrome	3
	T693BN	509.45	Brushed Nickel	3
	T693ORB	560.35	Oil Rubbed Bronze	3
 <ul style="list-style-type: none"> • application: three hole • deck thickness: 1/8" to 3-3/8" rough-in deck • center dimensions: adjustable • adjustable spout shank: included • test plug: included 	4792	143.70	1/2" CC	6
 <ul style="list-style-type: none"> • application: three hole • deck thickness: 1/8" to 2-3/4" rough-in deck • center dimensions: 10" - 24" center • adjustable spout shank: included • test plug: included 	4793	162.70	1/2" CPVC, Crimp ring PEX	6
	4794	155.15	1/2" Crimp ring PEX, Cold Expansion PEX	6
 <ul style="list-style-type: none"> • application: three hole • deck thickness: 1/8" to 1-7/8" rough-in deck • center dimensions: 10" center • non-adjustable spout shank: included • test plug: included 	4796	135.35	1/2" CC	6
	4797	138.00	1/2" CPVC, Crimp ring PEX	6
	4798	138.00	1/2" Crimp ring PEX, Cold Expansion PEX	6
 <ul style="list-style-type: none"> • description: high flow thermostatic mixing valve for roman tubs • ports: three • ASSE standard 1070: yes • flow rate: 12.0 gpm (45.4 L/min) max. 	104465	173.00	1/2" CC	12
	104466	173.00	1/2" IPS	12
 <ul style="list-style-type: none"> • description: PEX transition fittings (2) and clips • connections: adapts standard 1/2" PEX barb to 1/2" PEX cold expansion 	140715	10.75	1/2" PEX	200

HOW TO ORDER A COMPLETE ROMAN TUB FAUCET

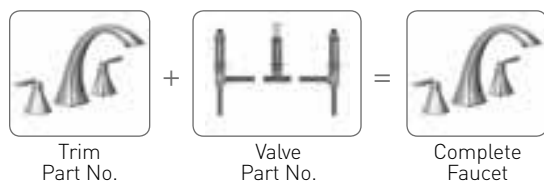







NOTES

 Moen® **M•PACT**® Common Valve System

Thermostatic Mixing Valve service kits, see page 498.

VOSS™ Roman Tubs

All Brushed Nickel faucet components feature the LifeShine® Non-Tarnish Finish.

	MODEL NUMBER	LIST PRICE	FINISH/ CONNECTION	CASE QTY
TWO-HANDLE ROMAN TUB WITH HANDSHOWER				
 <ul style="list-style-type: none"> • application: four hole • showerhead type: handshower • handshower flow rate: 2.0 transitioning to 1.75 gpm • spray functions: one-function • spout reach: 8.25" • valve: sold separately  	T694	567.90	Chrome	3
	T694BN	934.80	Brushed Nickel	3
	T694ORB	1,028.25	Oil Rubbed Bronze	3
 <ul style="list-style-type: none"> • application: four hole • deck thickness: 1/8" to 2-5/8" rough-in deck • center dimensions: adjustable • non-adjustable spout shank: included • test plug: included 	9792	323.75	1/2" CC	6
	9793	331.35	1/2" CPVC, Crimp ring PEX	6
 <ul style="list-style-type: none"> • description: high flow thermostatic mixing valve for roman tubs • ports: three • ASSE standard 1070: yes • flow rate: 12.0 gpm (45.4 L/min) max. 	104465	173.00	1/2" CC	12
	104466	173.00	1/2" IPS	12
 <ul style="list-style-type: none"> • description: PEX transition fittings (2) and clips • connections: adapts standard 1/2" PEX barb to 1/2" PEX cold expansion 	140715	10.75	1/2" PEX	200



HOW TO ORDER A COMPLETE ROMAN TUB FAUCET

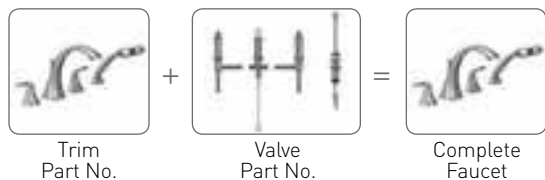

NOTES

 Moen® **M•PACT**® Common Valve System

Thermostatic Mixing Valve service kits, see page 498.

VOSS™ Transfer Valve Shower Spa Components

All Brushed Nickel faucet components feature the LifeShine® Non-Tarnish Finish.

	MODEL NUMBER	LIST PRICE	FINISH/ CONNECTION	CASE QTY
3 INDEPENDENT FUNCTION TRANSFER VALVE ONLY				
 <ul style="list-style-type: none"> • use with 3362 transfer valve • valve: sold separately 	T4612	106.50	Chrome	12
	T4612BN	143.10	Brushed Nickel	12
	T4612ORB	157.40	Oil Rubbed Bronze	12
2/3 FUNCTION TRANSFER VALVE ONLY				
 <ul style="list-style-type: none"> • use with 3372 or 3375 transfer valve • valve: sold separately 	T4611	106.50	Chrome	12
	T4611BN	143.10	Brushed Nickel	12
	T4611ORB	157.40	Oil Rubbed Bronze	12
 <ul style="list-style-type: none"> • type of function: two independent one shared • must be used with: Posi-Temp® or Moentrol® valve 	3372	172.00	1/2" CC	12
	 <ul style="list-style-type: none"> • type of function: two independent functions • must be used with: Posi-Temp® or Moentrol® valve 	3375	172.00	1/2" CC

HOW TO ORDER A COMPLETE TRANSFER VALVE

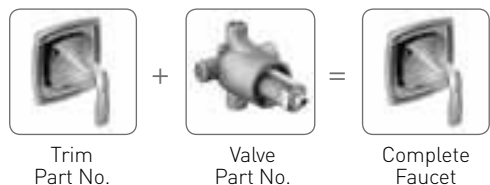









NOTES

Moën® **M•PACT**® Common Valve System
 DURALAST™ Duralast® Cartridge



VOSS™ Moentrol® Showering

All Brushed Nickel faucet components feature the LifeShine® Non-Tarnish Finish.

		MODEL NUMBER	LIST PRICE	FINISH/ CONNECTION	CASE QTY
MOENTROL® TUB/SHOWER					
	<ul style="list-style-type: none"> • showerhead functions: one-function • showerhead type: rainshower • showerhead size: 6" diameter spray head • showerhead flow rate: 2.5 gpm (9.5 L/min) max. • spout length: 7-15/16" • spout connection type: slip fit • tub spout type: diverter • valve: sold separately 	T3693	249.05	Chrome	3
		T3693BN	484.80	Brushed Nickel	3
		T3693ORB	533.25	Oil Rubbed Bronze	3
					
	<ul style="list-style-type: none"> • showerhead type: showerhead sold separately • spout length: 7-15/16" • spout connection type: slip fit • tub spout type: diverter • valve: sold separately 	T3693NH	168.55	Chrome	3
		T3693NHBN	340.50	Brushed Nickel	3
					
	<ul style="list-style-type: none"> • description: pressure balanced valve with volume control • ports: four • adjustable temp limit stop: included • checks: included • includes: volume control 	3510	164.10	1/2" IPS	6
		3520	164.10	1/2" CC	6
					
	<ul style="list-style-type: none"> • description: pressure balanced valve with volume control • ports: four • adjustable temp limit stop: included • check stops: included • includes: volume control 	3570 ♦	195.50	1/2" CC	6
					



HOW TO ORDER A COMPLETE TUB/SHOWER FAUCET

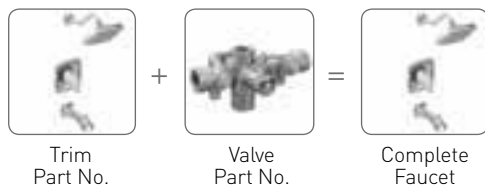











NOTES

- ♦ Also available in bulk pack. See page 435.
- Moentrol® M•PACT® Common Valve System
- IMMERSION® Immersion® Rainshower

VOSS™ Moentrol® Showering

All Brushed Nickel faucet components feature the LifeShine® Non-Tarnish Finish.

		MODEL NUMBER	LIST PRICE	FINISH/ CONNECTION	CASE QTY
MOENTROL® SHOWER ONLY					
 <ul style="list-style-type: none"> • showerhead functions: one-function • showerhead type: rainshower • showerhead size: 6" diameter spray head • showerhead flow rate: 2.5 gpm (9.5 L/min) max. • valve: sold separately 		T3692	183.50	Chrome	3
		T3692BN	379.70	Brushed Nickel	3
		T3692ORB	417.65	Oil Rubbed Bronze	3
					
 <ul style="list-style-type: none"> • showerhead type: showerhead sold separately • valve: sold separately 		T3692NH	140.70	Chrome	3
		T3692NHBN	297.25	Brushed Nickel	3
					
 <ul style="list-style-type: none"> • description: pressure balanced valve with volume control • ports: four • adjustable temp limit stop: included • checks: included • includes: volume control 		3510	164.10	1/2" IPS	6
		3520	164.10	1/2" CC	6
					
 <ul style="list-style-type: none"> • description: pressure balanced valve with volume control • ports: four • adjustable temp limit stop: included • check stops: included • includes: volume control 		3570 ♦	195.50	1/2" CC	6
					
MOENTROL® VALVE ONLY					
 <ul style="list-style-type: none"> • valve: sold separately 		T3691	137.50	Chrome	3
		T3691BN	292.90	Brushed Nickel	3
		T3691ORB	322.25	Oil Rubbed Bronze	3
					
 <ul style="list-style-type: none"> • description: pressure balanced valve with volume control • ports: four • adjustable temp limit stop: included • checks: included • includes: volume control 		3510	164.10	1/2" IPS	6
		3520	164.10	1/2" CC	6
					
 <ul style="list-style-type: none"> • description: pressure balanced valve with volume control • ports: four • adjustable temp limit stop: included • check stops: included • includes: volume control 		3570 ♦	195.50	1/2" CC	6
					

HOW TO ORDER A COMPLETE SHOWER FAUCET

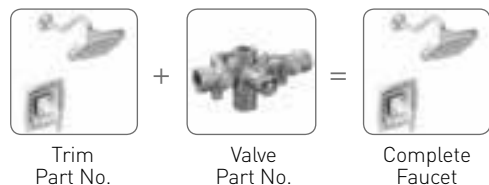











NOTES

- ♦ Also available in bulk pack. See page 435.
- Ⓜ Moen® **M•PACT**® Common Valve System



VOSS™ Posi-Temp® Showering

All Brushed Nickel faucet components feature the LifeShine® Non-Tarnish Finish.

		MODEL NUMBER	LIST PRICE	FINISH/ CONNECTION	CASE QTY
POSI-TEMP® TUB/SHOWER					
	<ul style="list-style-type: none"> • showerhead functions: one-function • showerhead type: standard • showerhead size: 4-1/16" diameter spray head • showerhead flow rate: 2.5 gpm (9.5 L/min) max. • spout length: 7-3/4" • spout connection type: slip fit • tub spout type: diverter • valve: sold separately 	T2693	196.90	Chrome	3
		T2693BN	357.90	Brushed Nickel	3
		T2693ORB	393.85	Oil Rubbed Bronze	3
	<ul style="list-style-type: none"> • showerhead functions: one-function • showerhead type: eco-performance showerhead • showerhead size: 4-1/16" diameter spray head • showerhead flow rate: 1.75 gpm (6.65 L/min) max. • spout length: 7-3/4" • spout connection type: slip fit • tub spout type: diverter • valve: sold separately 	T2693EP	196.90	Chrome	3
		T2693EPBN	357.90	Brushed Nickel	3
		T2693EPORB	393.85	Oil Rubbed Bronze	3
	<ul style="list-style-type: none"> • showerhead type: showerhead sold separately • spout length: 7-3/4" • spout connection type: slip fit • tub spout type: diverter • valve: sold separately 	T2693NH	132.60	Chrome	3
		T2693NHBN	259.35	Brushed Nickel	3
		T2693NHORB	285.30	Oil Rubbed Bronze	3
	<ul style="list-style-type: none"> • description: pressure balanced cycling valve • ports: four • adjustable temp limit stop: included 	2510 ♦	119.75	1/2" IPS	6
		2520 ♦	119.75	1/2" CC	6
		2580 ♦	119.75	1/2" Crimp ring PEX	6
	<ul style="list-style-type: none"> • description: pressure balanced cycling valve • ports: four • adjustable temp limit stop: included • quarter turn stops: included 	2570 ♦	145.35	1/2" CC	6
		2590 ♦	145.35	1/2" IPS	6

VOSS™

HOW TO ORDER A COMPLETE TUB/SHOWER FAUCET

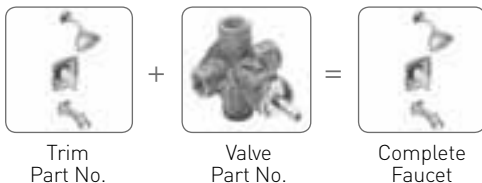











NOTES

- ♦ Also available in bulk pack. See page 435.
- Ⓜ Moen® **M•PACT**® Common Valve System

VOSS™ Posi-Temp® Showering

All Brushed Nickel faucet components feature the LifeShine® Non-Tarnish Finish.

	MODEL NUMBER	LIST PRICE	FINISH/ CONNECTION	CASE QTY
POSI-TEMP® SHOWER ONLY				
 <ul style="list-style-type: none"> • showerhead functions: one-function • showerhead type: standard • showerhead size: 4-1/16" diameter spray head • showerhead flow rate: 2.5 gpm (9.5 L/min) max. • valve: sold separately 	T2692	154.80	Chrome	3
	T2692BN	281.55	Brushed Nickel	3
	T2692ORB	309.65	Oil Rubbed Bronze	3
 <ul style="list-style-type: none"> • showerhead functions: one-function • showerhead type: eco-performance showerhead • showerhead size: 4-1/16" diameter spray head • showerhead flow rate: 1.75 gpm (6.65 L/min) max. • valve: sold separately 	T2692EP	154.80	Chrome	3
	T2692EPBN	281.55	Brushed Nickel	3
	T2692EPORB	309.65	Oil Rubbed Bronze	3
 <ul style="list-style-type: none"> • showerhead type: showerhead sold separately • valve: sold separately 	T2692NH	123.15	Chrome	3
	T2692NHBN	223.65	Brushed Nickel	3
	T2692NHORB	246.00	Oil Rubbed Bronze	3
 <ul style="list-style-type: none"> • description: pressure balanced cycling valve • ports: four • adjustable temp limit stop: included 	2510 ♦	119.75	1/2" IPS	6
	2520 ♦	119.75	1/2" CC	6
	2580 ♦	119.75	1/2" Crimp ring PEX	6
 <ul style="list-style-type: none"> • description: pressure balanced cycling valve • ports: four • adjustable temp limit stop: included • quarter turn stops: included 	2570 ♦	145.35	1/2" CC	6
	2590 ♦	145.35	1/2" IPS	6

HOW TO ORDER A COMPLETE SHOWER FAUCET

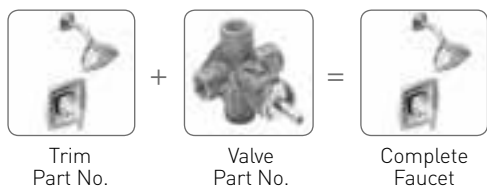













NOTES

- ♦ Also available in bulk pack. See page 435..
- Ⓜ Moen® **M•PACT**® Common Valve System

VOSS™ Posi-Temp® Showering, Bidets

All Brushed Nickel faucet components feature the LifeShine® Non-Tarnish Finish.

		MODEL NUMBER	LIST PRICE	FINISH/ CONNECTION	CASE QTY
POSI-TEMP® VALVE ONLY					
 <ul style="list-style-type: none"> • valve: sold separately  		T2691	116.15	Chrome	3
		T2691BN	210.90	Brushed Nickel	3
		T2691ORB	232.05	Oil Rubbed Bronze	3
 	<ul style="list-style-type: none"> • description: pressure balanced cycling valve • ports: four • adjustable temp limit stop: included 	2510 ♦	119.75	1/2" IPS	6
		2520 ♦	119.75	1/2" CC	6
		2580 ♦	119.75	1/2" Crimp ring PEX	6
 	<ul style="list-style-type: none"> • description: pressure balanced cycling valve • ports: four • adjustable temp limit stop: included • quarter turn stops: included 	2570 ♦	145.35	1/2" CC	6
		2590 ♦	145.35	1/2" IPS	6
TWO-HANDLE BIDET					
  	<ul style="list-style-type: none"> • center dimensions: 8" - 16" center • valve: sold separately 	T5269	401.50	Chrome	3
		T5269BN	549.85	Brushed Nickel	3
		T5269ORB	604.80	Oil Rubbed Bronze	3
 	<ul style="list-style-type: none"> • application: three hole • center dimensions: 8" - 16" center 	9265	254.45	1/2" IPS	6
		DURALOCK® DURALAST®			

VOSS™

HOW TO ORDER A COMPLETE VALVE



HOW TO ORDER A COMPLETE BIDET FAUCET

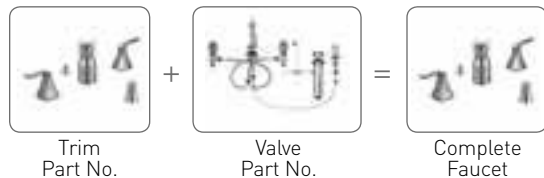

NOTES

- ♦ Also available in bulk pack. See page 435.
- Ⓜ Moen® **M•PACT®** Common Valve System
- DURALOCK: Duralock™ Quick Connections
- DURALAST: Duralast® Cartridge

VOSS™ Perfectly Matched Bath Accessories

Moen® bath accessories CANNOT be combined with Moen® faucet parts on a Purchase Order.

Moen makes it easy to coordinate the entire style and look of the bathroom. Our Voss™ bath accessories perfectly match the style and finish of our Voss™ faucets. Total coordination of the bath has never been easier.

For more information on ordering Voss™ bath accessories or other matching Moen® bath accessories, contact Moen Bath Accessory Customer Service at **800-882-0116**, contact your local Moen sales representative, or visit us at **www.moen.com**.

MODEL NUMBER	LIST PRICE EACH	DESCRIPTION	Rectangular Bar QTY
Chrome (CH)			
YB5101CH	32.50	Tank Lever	24
YB5103CH	24.95	Double Robe Hook	24
P YB5108CH	45.65	Pivoting Paper Holder	6
YB5118CH	53.00	18" Towel Bar	6
YB5124CH	54.65	24" Towel Bar	6
YB5170CH	35.55	Hair Dryer Holder	6
YB5186CH	37.20	Towel Ring	6
Brushed Nickel (BN)			
YB5101BN	35.85	Tank Lever	24
YB5103BN	27.50	Double Robe Hook	24
P YB5108BN	50.50	Pivoting Paper Holder	6
YB5118BN	58.25	18" Towel Bar	6
YB5124BN	60.30	24" Towel Bar	6
YB5170BN	38.15	Hair Dryer Holder	6
YB5186BN	40.70	Towel Ring	6
Oil Rubbed Bronze (ORB)			
YB5101ORB	39.40	Tank Lever	24
YB5103ORB	30.25	Double Robe Hook	24
P YB5108ORB	55.60	Pivoting Paper Holder	6
YB5118ORB	64.05	18" Towel Bar	6
YB5124ORB	66.40	24" Towel Bar	6
YB5170ORB	44.00	Hair Dryer Holder	6
YB5186ORB	44.75	Towel Ring	6



GRAB BARS

PERFECTLY MATCHED to Moen® Voss™ faucets and bath accessories. ADA-compliant.



SecureMount™ Grab Bars are manufactured with an innovative flange design that makes it easy to connect to the stud at multiple points.

To install grab bars securely without studs, use SecureMount™ Anchors. Sold separately.

MODEL NUMBER	LIST PRICE EACH	DESCRIPTION	QTY
1-1/4" • Chrome (CH)			
YG5112CH	88.85	12" Designer Grab Bar	6
YG5118CH	92.85	18" Designer Grab Bar	6
YG5124CH	96.95	24" Designer Grab Bar	6
1-1/4" • Brushed Nickel (BN)			
YG5112BN	107.40	12" Designer Grab Bar	6
YG5118BN	112.60	18" Designer Grab Bar	6
YG5124BN	121.50	24" Designer Grab Bar	6
1-1/4" • Oil Rubbed Bronze (ORB)			
YG5112ORB	118.10	12" Designer Grab Bar	6
YG5118ORB	123.90	18" Designer Grab Bar	6
YG5124ORB	133.70	24" Designer Grab Bar	6



YB5186 Towel Ring



YG5124 24" length Designer Grab Bar

P Denotes pivoting paper holder



Complies with Americans with Disabilities Act (ADA) specifications. SecureMount™ Grab Bars are tested to withstand 500 lb. pull when securely installed per instructions.

List price is per each (unless otherwise noted). Product can be ordered by case quantity or individually.

VOSS™ Perfectly Matched Bath Accessories



LIGHTING

MODEL NUMBER	LIST PRICE EACH	DESCRIPTION	QTY
Chrome (CH)			
YB5161CH	127.35	One Globe Bath Light	2
YB5162CH	178.20	Two Globe Bath Light	2
YB5163CH	221.30	Three Globe Bath Light	2
YB5164CH	283.45	Four Globe Bath Light	2
Brushed Nickel (BN)			
YB5161BN	159.25	One Globe Bath Light	2
YB5162BN	222.75	Two Globe Bath Light	2
YB5163BN	276.70	Three Globe Bath Light	2
YB5164BN	354.25	Four Globe Bath Light	2
Oil Rubbed Bronze (ORB)			
YB5161ORB	159.25	One Globe Bath Light	2
YB5162ORB	222.75	Two Globe Bath Light	2
YB5163ORB	276.70	Three Globe Bath Light	2
YB5164ORB	354.25	Four Globe Bath Light	2
Replacement Globe			
YB5169	23.35	Replacement Globe	3



YB5161
One Globe Light



YB5162
Two Globe Light



YB5163
Three Globe Light



YB5164
Four Globe Light



YB5169
Replacement Globe

VOSS™















Bulbs not included.

All Voss™ lighting fixtures can be mounted facing either upward or downward.
List price is per each (unless otherwise noted). Product can be ordered by case quantity or individually.

BELFIELD™ Bathroom Faucets

All Brushed Nickel faucet components feature the LifeShine® Non-Tarnish Finish.

	MODEL NUMBER	LIST PRICE	FINISH/ CONNECTION	CASE QTY
ONE-HANDLE BATHROOM FAUCET				
 <ul style="list-style-type: none"> • application: one or three hole • supply line length: flexible • connection size: 3/8" • connection type: compression • deckplate: included • drain assembly: metal • drain assembly type: lift rod   DURALAST®	6402	255.05	Chrome	3
	6402BN	357.35	Brushed Nickel	3
	6402ORB	382.80	Oil Rubbed Bronze	3
TWO-HANDLE CENTERSET BATHROOM FAUCET				
 <ul style="list-style-type: none"> • application: three hole • center dimensions: 4" center • connection size: 1/2" • connection type: IPS • drain assembly: metal • drain assembly type: lift rod  	6401	253.55	Chrome	3
	6401BN	354.95	Brushed Nickel	3
	6401ORB	380.25	Oil Rubbed Bronze	3
TWO-HANDLE WIDESPREAD BATHROOM FAUCET				
 <ul style="list-style-type: none"> • application: three hole • center dimensions: 8" - 16" center • drain assembly: metal • drain assembly type: lift rod • valve: sold separately   	T6405	265.90	Chrome	3
	T6405BN	414.50	Brushed Nickel	3
	T6405ORB	451.60	Oil Rubbed Bronze	3
 <ul style="list-style-type: none"> • application: three hole • center dimensions: 8" - 16" center • drain assembly: metal • drain assembly type: lift rod  DURALOCK® DURALAST®	9000 ♦	123.55	1/2" IPS	6



HOW TO ORDER A COMPLETE BATHROOM FAUCET

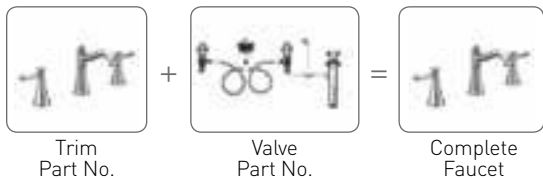











NOTES

- ♦ Also available in bulk pack. See page 435.
- Ⓜ Moen® **M•PACT®** Common Valve System
- DURALOCK®** Duralock® Quick Connections
- DURALAST®** Duralast® Cartridge

Refer to lavatory waste assemblies on page 403.
Refer to specification sheet for critical dimensions for installation.

BELFIELD™ Roman Tub

All Brushed Nickel faucet components feature the LifeShine® Non-Tarnish Finish.

	MODEL NUMBER	LIST PRICE	FINISH/ CONNECTION	CASE QTY
TWO-HANDLE ROMAN TUB				
 <ul style="list-style-type: none"> • application: three hole • spout reach: 7.50" • valve: sold separately 	T9023	328.40	Chrome	3
	T9023BN	461.50	Brushed Nickel	3
	T9023ORB	501.15	Oil Rubbed Bronze	3
 <ul style="list-style-type: none"> • application: three hole • deck thickness: 1/8" to 3-3/8" rough-in deck • center dimensions: adjustable • adjustable spout shank: included • test plug: included 	4792	143.70	1/2" CC	6
 <ul style="list-style-type: none"> • application: three hole • deck thickness: 1/8" to 2-3/4" rough-in deck • center dimensions: 10" - 24" center • adjustable spout shank: included • test plug: included 	4793	162.70	1/2" CPVC, Crimp ring PEX	6
	4794	155.15	1/2" Crimp ring PEX, Cold Expansion PEX	6
 <ul style="list-style-type: none"> • application: three hole • deck thickness: 1/8" to 1-7/8" rough-in deck • center dimensions: 10" center • non-adjustable spout shank: included • test plug: included 	4796	135.35	1/2" CC	6
	4797	138.00	1/2" CPVC, Crimp ring PEX	6
	4798	138.00	1/2" Crimp ring PEX, Cold Expansion PEX	6
 <ul style="list-style-type: none"> • description: high flow thermostatic mixing valve for roman tubs • ports: three • ASSE standard 1070: yes • flow rate: 12.0 gpm (45.4 L/min) max. 	104465	173.00	1/2" CC	12
	104466	173.00	1/2" IPS	12
 <ul style="list-style-type: none"> • description: PEX transition fittings [2] and clips • connections: adapts standard 1/2" PEX barb to 1/2" PEX cold expansion 	140715	10.75	1/2" PEX	200

BELFIELD™

HOW TO ORDER A COMPLETE ROMAN TUB FAUCET

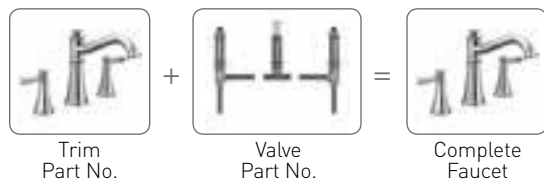









NOTES

 Moen® **M•PACT**® Common Valve System

Thermostatic Mixing Valve service kits, see page 498.

BELFIELD™ Roman Tubs

All Brushed Nickel faucet components feature the LifeShine® Non-Tarnish Finish.

	MODEL NUMBER	LIST PRICE	FINISH/ CONNECTION	CASE QTY	
TWO-HANDLE ROMAN TUB WITH HANDSHOWER					
 <ul style="list-style-type: none"> • application: four hole • showerhead type: handshower • handshower flow rate: 2.0 transitioning to 1.75 gpm • spray functions: one-function • spout reach: 7.50" • valve: sold separately  	T9024 T9024BN T9024ORB	446.35 628.55 674.10	Chrome Brushed Nickel Oil Rubbed Bronze	3 3 3	
	 <ul style="list-style-type: none"> • application: four hole • deck thickness: 1/8" to 2-5/8" rough-in deck • center dimensions: adjustable • non-adjustable spout shank: included • test plug: included 	9792	323.75	1/2" CC	6
	 <ul style="list-style-type: none"> • application: four hole • deck thickness: 1/8" to 2-5/8" rough-in deck • center dimensions: 10" - 24" center • non-adjustable spout shank: included • test plug: included 	9793	331.35	1/2" CPVC, Crimp ring PEX	6
 <ul style="list-style-type: none"> • description: high flow thermostatic mixing valve for roman tubs • ports: three • ASSE standard 1070: yes • flow rate: 12.0 gpm (45.4 L/min) max. 	104465 104466	173.00 173.00	1/2" CC 1/2" IPS	12 12	
 <ul style="list-style-type: none"> • description: PEX transition fittings (2) and clips • connections: adapts standard 1/2" PEX barb to 1/2" PEX cold expansion 	140715	10.75	1/2" PEX	200	

HOW TO ORDER A COMPLETE ROMAN TUB FAUCET

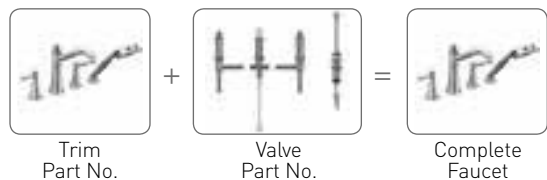







NOTES

 Moen® **M•PACT**® Common Valve System

Thermostatic Mixing Valve service kits, see page 498.

BELFIELD™ Transfer Valve Shower Spa Components

All Brushed Nickel faucet components feature the LifeShine® Non-Tarnish Finish.

	MODEL NUMBER	LIST PRICE	FINISH/ CONNECTION	CASE QTY
2/3 FUNCTION TRANSFER VALVE ONLY				
 <ul style="list-style-type: none"> • use with 3372 or 3375 transfer valve • valve: sold separately  	T4301	102.60	Chrome	12
	T4301BN	137.85	Brushed Nickel	12
	T4301ORB	151.65	Oil Rubbed Bronze	12
  <ul style="list-style-type: none"> • type of function: two independent one shared • must be used with: Posi-Temp® or Moentrol® valve 	3372	172.00	1/2" CC	12
  <ul style="list-style-type: none"> • type of function: two independent functions • must be used with: Posi-Temp® or Moentrol® valve 	3375	172.00	1/2" CC	12

BELFIELD™

HOW TO ORDER A COMPLETE TRANSFER VALVE

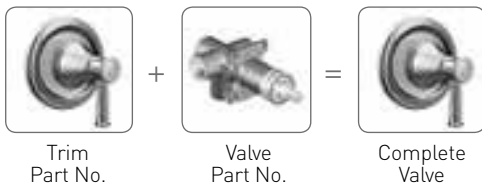









NOTES

 Moen® **M•PACT**® Common Valve System
DURALAST™ Duralast® Cartridge

BELFIELD™ Moentrol® Showering

All Brushed Nickel faucet components feature the LifeShine® Non-Tarnish Finish.

	MODEL NUMBER	LIST PRICE	FINISH/ CONNECTION	CASE QTY
MOENTROL® TUB/SHOWER				
 <ul style="list-style-type: none"> • showerhead type: showerhead sold separately • spout length: 7-3/4" • spout connection type: slip fit • tub spout type: diverter • valve: sold separately 	T3313NH	153.75	Chrome	3
	T3313NHBN	324.80	Brushed Nickel	3
	T3313NHORB	357.20	Oil Rubbed Bronze	3
  				
 <ul style="list-style-type: none"> • description: pressure balanced valve with volume control • ports: four • adjustable temp limit stop: included • checks: included • includes: volume control 	3510	164.10	1/2" IPS	6
	3520	164.10	1/2" CC	6
 <ul style="list-style-type: none"> • description: pressure balanced valve with volume control • ports: four • adjustable temp limit stop: included • check stops: included • includes: volume control 	3570 ♦	195.50	1/2" CC	6

HOW TO ORDER A COMPLETE TUB/SHOWER FAUCET

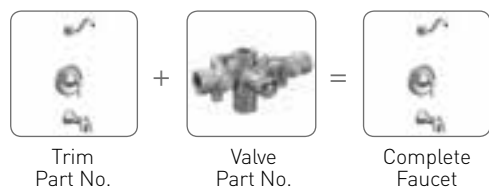









NOTES







- ♦ Also available in bulk pack. See page 435.
- Ⓜ Moen® **M•PACT**® Common Valve System



BELFIELD™ Moentrol® Showering

All Brushed Nickel faucet components feature the LifeShine® Non-Tarnish Finish.

		MODEL NUMBER	LIST PRICE	FINISH/ CONNECTION	CASE QTY
MOENTROL® SHOWER ONLY					
 <ul style="list-style-type: none"> • showerhead type: showerhead sold separately • valve: sold separately 		T3312NH	124.10	Chrome	3
		T3312NHBN	267.05	Brushed Nickel	3
		T3312NHORB	293.50	Oil Rubbed Bronze	3
  					
 <ul style="list-style-type: none"> • description: pressure balanced valve with volume control • ports: four • adjustable temp limit stop: included • checks: included • includes: volume control 		3510	164.10	1/2" IPS	6
		3520	164.10	1/2" CC	6
 <ul style="list-style-type: none"> • description: pressure balanced valve with volume control • ports: four • adjustable temp limit stop: included • check stops: included • includes: volume control 		3570 ♦	195.50	1/2" CC	6

MOENTROL® VALVE ONLY					
 <ul style="list-style-type: none"> • valve: sold separately  		T3311	118.50	Chrome	3
		T3311BN	276.50	Brushed Nickel	3
		T3311ORB	304.15	Oil Rubbed Bronze	3
 <ul style="list-style-type: none"> • description: pressure balanced valve with volume control • ports: four • adjustable temp limit stop: included • checks: included • includes: volume control 		3510	164.10	1/2" IPS	6
		3520	164.10	1/2" CC	6
 <ul style="list-style-type: none"> • description: pressure balanced valve with volume control • ports: four • adjustable temp limit stop: included • check stops: included • includes: volume control 		3570 ♦	195.50	1/2" CC	6

HOW TO ORDER A COMPLETE SHOWER FAUCET

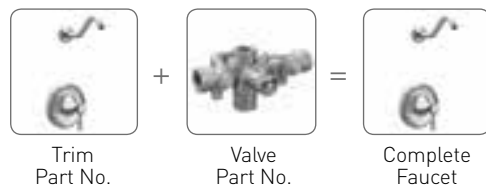











NOTES

- ♦ Also available in bulk pack. See page 435.
- Ⓜ Moen® **M•PACT**® Common Valve System

BELFIELD™ Posi-Temp® Showering

All Brushed Nickel faucet components feature the LifeShine® Non-Tarnish Finish.

	MODEL NUMBER	LIST PRICE	FINISH/ CONNECTION	CASE QTY	
POSI-TEMP® TUB/SHOWER					
 <ul style="list-style-type: none"> • showerhead functions: one-function • showerhead type: standard • showerhead size: 7" diameter spray head • showerhead flow rate: 2.5 gpm (9.5 L/min) max. • spout length: 7-3/4" • spout connection type: slip fit • tub spout type: diverter • valve: sold separately 	T2313 T2313BN T2313ORB	189.70 344.80 379.45	Chrome Brushed Nickel Oil Rubbed Bronze	4 4 4	
	 <ul style="list-style-type: none"> • showerhead functions: one-function • showerhead type: standard • showerhead size: 7" diameter spray head • showerhead flow rate: 1.75 gpm (6.65 L/min) max. • spout length: 7-3/4" • spout connection type: slip fit • tub spout type: diverter • valve: sold separately 	T2313EP T2313EPBN T2313EPORB	189.70 344.80 379.45	Chrome Brushed Nickel Oil Rubbed Bronze	4 4 4
		 <ul style="list-style-type: none"> • showerhead type: showerhead sold separately • spout length: 7-3/4" • spout connection type: slip fit • tub spout type: diverter • valve: sold separately 	T2313NH T2313NHBN T2313NHORB	127.75 249.85 274.85	Chrome Brushed Nickel Oil Rubbed Bronze
 <ul style="list-style-type: none"> • description: pressure balanced cycling valve • ports: four • adjustable temp limit stop: included 			2510 ♦ 2520 ♦ 2580 ♦	119.75 119.75 119.75	1/2" IPS 1/2" CC 1/2" Crimp ring PEX
	 <ul style="list-style-type: none"> • description: pressure balanced cycling valve • ports: four • adjustable temp limit stop: included • quarter turn stops: included 		2570 ♦ 2590 ♦	145.35 145.35	1/2" CC 1/2" IPS

HOW TO ORDER A COMPLETE TUB/SHOWER FAUCET

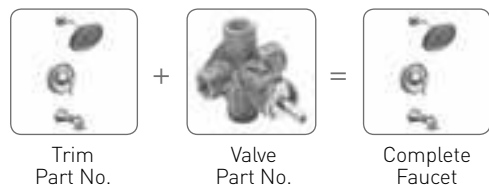















NOTES

- ♦ Also available in bulk pack. See page 435.
- Ⓜ Moen® **M•PACT**® Common Valve System



BELFIELD™ Posi-Temp® Showering

All Brushed Nickel faucet components feature the LifeShine® Non-Tarnish Finish.

		MODEL NUMBER	LIST PRICE	FINISH/ CONNECTION	CASE QTY
POSI-TEMP® SHOWER ONLY					
 <ul style="list-style-type: none"> • showerhead functions: one-function • showerhead type: standard • showerhead size: 7" diameter spray head • showerhead flow rate: 2.5 gpm (9.5 L/min) max. • valve: sold separately 	  IMMERSION	T2312	149.15	Chrome	4
		T2312BN	271.25	Brushed Nickel	4
		T2312ORB	298.30	Oil Rubbed Bronze	4
 <ul style="list-style-type: none"> • showerhead functions: one-function • showerhead type: standard • showerhead size: 7" diameter spray head • showerhead flow rate: 1.75 gpm (6.65 L/min) max. • valve: sold separately 	   IMMERSION	T2312EP	149.15	Chrome	4
		T2312EPBN	271.25	Brushed Nickel	4
		T2312EPORB	298.30	Oil Rubbed Bronze	4
 <ul style="list-style-type: none"> • showerhead type: showerhead sold separately • valve: sold separately 	 	T2312NH	118.65	Chrome	3
		T2312NHBN	215.45	Brushed Nickel	3
		T2312NHORB	236.55	Oil Rubbed Bronze	3
 <ul style="list-style-type: none"> • description: pressure balanced cycling valve • ports: four • adjustable temp limit stop: included 		2510 ♦	119.75	1/2" IPS	6
		2520 ♦	119.75	1/2" CC	6
		2580 ♦	119.75	1/2" Crimp ring PEX	6
 <ul style="list-style-type: none"> • description: pressure balanced cycling valve • ports: four • adjustable temp limit stop: included • quarter turn stops: included 		2570 ♦	145.35	1/2" CC	6
		2590 ♦	145.35	1/2" IPS	6

BELFIELD™

HOW TO ORDER A COMPLETE SHOWER FAUCET

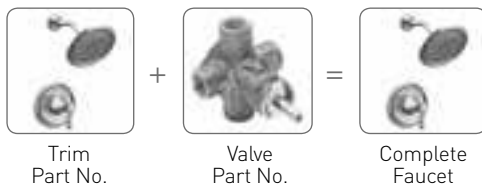







NOTES

- ♦ Also available in bulk pack. See page 435.
-  Moen® **M•PACT**® Common Valve System
-  Immersion® Rainshower

BELFIELD™ Posi-Temp® Showering

All Brushed Nickel faucet components feature the LifeShine® Non-Tarnish Finish.

		MODEL NUMBER	LIST PRICE	FINISH/ CONNECTION	CASE QTY
POSI-TEMP® VALVE ONLY					
 <ul style="list-style-type: none"> • valve: sold separately  		T2311	111.90	Chrome	3
		T2311BN	203.20	Brushed Nickel	3
		T2311ORB	223.55	Oil Rubbed Bronze	3
  <ul style="list-style-type: none"> • description: pressure balanced cycling valve • ports: four • adjustable temp limit stop: included 		2510 ♦	119.75	1/2" IPS	6
		2520 ♦	119.75	1/2" CC	6
		2580 ♦	119.75	1/2" Crimp ring PEX	6
  <ul style="list-style-type: none"> • description: pressure balanced cycling valve • ports: four • adjustable temp limit stop: included • quarter turn stops: included 		2570 ♦	145.35	1/2" CC	6
		2590 ♦	145.35	1/2" IPS	6

HOW TO ORDER A COMPLETE VALVE



NOTES

- ♦ Also available in bulk pack. See page 435.
- Ⓜ Moen® **M•PACT**® Common Valve System

BELFIELD™ Perfectly Matched Bath Accessories

Moen® bath accessories CANNOT be combined with Moen® faucet parts on a Purchase Order.

Moen makes it easy to coordinate the entire style and look of the bathroom. Our Belfield™ bath accessories perfectly match the style and finish of our Belfield™ faucets. Total coordination of the bath has never been easier.

For more information on ordering Belfield™ bath accessories or other matching Moen® bath accessories, contact Moen Bath Accessory Customer Service at **800-882-0116**, contact your local Moen sales representative, or visit us at www.moen.com.

MODEL NUMBER	LIST PRICE EACH	DESCRIPTION	5/8-in Round Bar QTY
Chrome (CH)			
YB6401CH	31.30	Tank Lever	24
YB6403CH	24.05	Double Robe Hook	24
(P) YB6408CH	44.00	Pivoting Paper Holder	6
YB6418CH	51.05	18" Towel Bar	6
YB6422CH	68.35	24" Double Towel Bar	6
YB6424CH	52.65	24" Towel Bar	6
YB6486CH	35.85	Hand Towel Bar	6
Brushed Nickel (BN)			
YB6401BN	34.55	Tank Lever	24
YB6403BN	26.50	Double Robe Hook	24
(P) YB6408BN	48.65	Pivoting Paper Holder	6
YB6418BN	56.10	18" Towel Bar	6
YB6422BN	73.65	24" Double Towel Bar	6
YB6424BN	58.10	24" Towel Bar	6
YB6486BN	39.20	Hand Towel Bar	6
Oil Rubbed Bronze (ORB)			
YB6401ORB	37.95	Tank Lever	24
YB6403ORB	29.15	Double Robe Hook	24
(P) YB6408ORB	53.55	Pivoting Paper Holder	6
YB6418ORB	61.70	18" Towel Bar	6
YB6422ORB	81.10	24" Double Towel Bar	6
YB6424ORB	63.95	24" Towel Bar	6
YB6486ORB	43.10	Hand Towel Bar	6



GRAB BARS

PERFECTLY MATCHED to Moen® BELFIELD™ faucets and bath accessories. ADA-compliant.



SecureMount™ Grab Bars are manufactured with an innovative flange design that makes it easy to connect to the stud at multiple points.

To install grab bars securely without studs, use SecureMount™ Anchors. Sold separately.

MODEL NUMBER	LIST PRICE EACH	DESCRIPTION	QTY
1-1/4" • Chrome (CH)			
YG6412CH	85.60	12" Designer Grab Bar	6
YG6418CH	89.45	18" Designer Grab Bar	6
YG6424CH	93.40	24" Designer Grab Bar	6
1-1/4" • Brushed Nickel (BN)			
YG6412BN	103.45	12" Designer Grab Bar	6
YG6418BN	108.50	18" Designer Grab Bar	6
YG6424BN	117.05	24" Designer Grab Bar	6
1-1/4" • Oil Rubbed Bronze (ORB)			
YG6412ORB	113.80	12" Designer Grab Bar	6
YG6418ORB	119.35	18" Designer Grab Bar	6
YG6424ORB	128.80	24" Designer Grab Bar	6



NEW! YG6424 24" length Grab Bar

(P) Denotes pivoting paper holder

 Complies with Americans with Disabilities Act (ADA) specifications. SecureMount™ Grab Bars are tested to withstand 500 lb. pull when securely installed per instructions.

List price is per each (unless otherwise noted). Product can be ordered by case quantity or individually.

BELFIELD™ Perfectly Matched Bath Accessories



LIGHTING

MODEL NUMBER	LIST PRICE EACH	DESCRIPTION	QTY
Chrome (CH)			
YB6461CH	122.70	One Globe Bath Light	1
YB6462CH	171.70	Two Globe Bath Light	1
YB6463CH	213.20	Three Globe Bath Light	1
YB6464CH	273.05	Four Globe Bath Light	1
Brushed Nickel (BN)			
YB6461BN	153.40	One Globe Bath Light	1
YB6462BN	214.60	Two Globe Bath Light	1
YB6463BN	266.55	Three Globe Bath Light	1
YB6464BN	341.30	Four Globe Bath Light	1
Oil Rubbed Bronze (ORB)			
YB6461ORB	153.40	One Globe Bath Light	1
YB6462ORB	214.60	Two Globe Bath Light	1
YB6463ORB	266.55	Three Globe Bath Light	1
YB6464ORB	341.30	Four Globe Bath Light	1
Replacement Globe			
YB6469	22.50	Replacement Globe	3



NEW! YB6461 One Globe Light

NEW! YB6462 Two Globe Light



NEW! YB6463 Three Globe Light



NEW! YB6464 Four Globe Light

NEW! YB6469 Replacement Globe













Bulbs not included.

All BELFIELD™ lighting fixtures can be mounted facing either upward or downward. List price is per each (unless otherwise noted). Product can be ordered by case quantity or individually.



KINGSLEY® Bathroom Faucets

All Brushed Nickel and Polished Brass faucet components feature the LifeShine® Non-Tarnish Finish.

	MODEL NUMBER	LIST PRICE	FINISH/ CONNECTION	CASE QTY
ONE-HANDLE BATHROOM FAUCET				
 <ul style="list-style-type: none"> • application: one or three hole • supply line length: flexible • connection size: 3/8" • connection type: compression • deckplate: included • drain assembly: metal • drain assembly type: lift rod   DURALAST®	6102	258.85	Chrome	3
	6102BN	385.55	Brushed Nickel	3
	6102ORB	424.15	Oil Rubbed Bronze	3
	6102WR	424.15	Wrought Iron	3
	6102P	431.75	Polished Brass	3
 <ul style="list-style-type: none"> • description: vessel extension kit • includes: parts to convert to grid drain • includes: two extensions 	A1616	121.85	Chrome	6
	A1616BN	174.50	Brushed Nickel	6
	A1616ORB	192.05	Oil Rubbed Bronze	6
	A1616P	195.45	Polished Brass	6
	A1616WR	192.05	Wrought Iron	6
TWO-HANDLE CENTERSET BATHROOM FAUCET				
 <ul style="list-style-type: none"> • application: three hole • center dimensions: 4" center • connection size: 1/2" • connection type: IPS • drain assembly: metal • drain assembly type: lift rod  	6101	246.60	Chrome	6
	6101BN	367.25	Brushed Nickel	6
	6101ORB	404.00	Oil Rubbed Bronze	6
 <ul style="list-style-type: none"> • application: three hole • center dimensions: 4" center • connection size: 1/2" • connection type: IPS • drain assembly: metal • drain assembly type: lift rod  	6121	283.55	Chrome	3
	6121BN	422.25	Brushed Nickel	3
	6121ORB	464.55	Oil Rubbed Bronze	3
	6121WR	464.55	Wrought Iron	3
	6121P	473.00	Polished Brass	3

















NOTES

DURALAST® Duralast® Cartridge

Refer to lavatory waste assemblies on page 403.

KINGSLEY® Bathroom Faucets

All Brushed Nickel and Polished Brass faucet components feature the LifeShine® Non-Tarnish Finish.

	MODEL NUMBER	LIST PRICE	FINISH/ CONNECTION	CASE QTY
TWO-HANDLE WIDESPREAD BATHROOM FAUCET				
 <ul style="list-style-type: none"> • application: three hole • center dimensions: 8" - 16" center • drain assembly: metal • drain assembly type: lift rod • valve: sold separately   	T6105	257.60	Chrome	3
	T6105BN	432.95	Brushed Nickel	3
	T6105ORB	476.20	Oil Rubbed Bronze	3
 <ul style="list-style-type: none"> • application: three hole • center dimensions: 8" - 16" center • drain assembly: metal • drain assembly type: lift rod • valve: sold separately   	T6125	296.20	Chrome	3
	T6125BN	497.75	Brushed Nickel	3
	T6125ORB	547.60	Oil Rubbed Bronze	3
	T6125WR	547.60	Wrought Iron	3
	T6125P	560.45	Polished Brass	3
 <ul style="list-style-type: none"> • application: three hole • center dimensions: 8" - 16" center • drain assembly: metal • drain assembly type: lift rod  DURALOCK® DURALAST®	9000 ♦	123.55	1/2" IPS	6
TWO-HANDLE WALLMOUNT BATHROOM FAUCET				
 <ul style="list-style-type: none"> • application: three hole • center dimensions: 8" center • drain assembly: 140780 sold separately • valve: sold separately   	T6107	293.70	Chrome	3
	T6107BN	478.25	Brushed Nickel	3
	T6107ORB	526.20	Oil Rubbed Bronze	3
 <ul style="list-style-type: none"> • application: three hole • center dimensions: 8" center • drain assembly: 140780 sold separately • includes: mounting brackets 	9700	174.75	1/2" CC	3
 <ul style="list-style-type: none"> • drain assembly: metal • drain assembly type: spring loaded pop-up • drain assembly size: 1-1/4" • drain assembly: 1-1/4" non-overflow 	140780	59.20	Chrome	12
	140780BN	82.60	Brushed Nickel	12
	140780ORB	93.30	Oil Rubbed Bronze	12

HOW TO ORDER A COMPLETE BATHROOM FAUCET

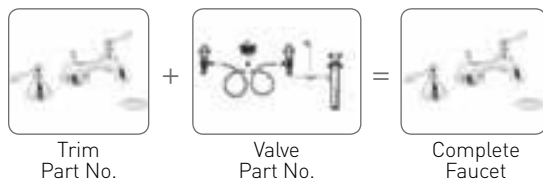

NOTES











- ♦ Also available in bulk pack. See page 435.
- Ⓜ Moen® **M•PACT®** Common Valve System
- DURALOCK** Duralock® Quick Connections
- DURALAST** Duralast® Cartridge

Refer to specification sheet for critical dimensions for installation.



KINGSLEY® Roman Tub

All Brushed Nickel and Polished Brass faucet components feature the LifeShine® Non-Tarnish Finish.

	MODEL NUMBER	LIST PRICE	FINISH/ CONNECTION	CASE QTY
TWO-HANDLE ROMAN TUB				
 <ul style="list-style-type: none"> • application: three hole • spout reach: 9.00" • valve: sold separately 	T920	419.25	Chrome	3
	T920BN	585.75	Brushed Nickel	3
	T920P	640.45	Polished Brass	3
	T920ORB	644.30	Oil Rubbed Bronze	3
	T920WR	644.30	Wrought Iron	3
 <ul style="list-style-type: none"> • application: three hole • deck thickness: 1/8" to 3-3/8" rough-in deck • center dimensions: adjustable • adjustable spout shank: included • test plug: included 	4792	143.70	1/2" CC	6
 <ul style="list-style-type: none"> • application: three hole • deck thickness: 1/8" to 2-3/4" rough-in deck • center dimensions: 10" - 24" center • adjustable spout shank: included • test plug: included 	4793 4794	162.70 155.15	1/2" CPVC, Crimp ring PEX 1/2" Crimp ring PEX, Cold Expansion PEX	6 6
 <ul style="list-style-type: none"> • application: three hole • deck thickness: 1/8" to 1-7/8" rough-in deck • center dimensions: 10" center • non-adjustable spout shank: included • test plug: included 	4796 4797 4798	135.35 138.00 138.00	1/2" CC 1/2" CPVC, Crimp ring PEX 1/2" Crimp ring PEX, Cold Expansion PEX	6 6 6
 <ul style="list-style-type: none"> • description: high flow thermostatic mixing valve for roman tubs • ports: three • ASSE standard 1070: yes • flow rate: 12.0 gpm (45.4 L/min) max. 	104465 104466	173.00 173.00	1/2" CC 1/2" IPS	12 12
 <ul style="list-style-type: none"> • description: PEX transition fittings (2) and clips • connections: adapts standard 1/2" PEX barb to 1/2" PEX cold expansion 	140715	10.75	1/2" PEX	200

KINGSLEY®

HOW TO ORDER A COMPLETE ROMAN TUB FAUCET

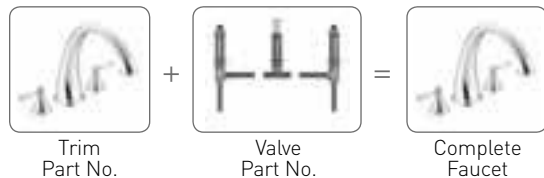









NOTES

 Moen® **M•PACT®** Common Valve System

Thermostatic Mixing Valve service kits, see page 498.

KINGSLEY® Roman Tubs

All Brushed Nickel faucet components feature the LifeShine® Non-Tarnish Finish.

	MODEL NUMBER	LIST PRICE	FINISH/ CONNECTION	CASE QTY
TWO-HANDLE ROMAN TUB WITH HANDSHOWER				
 <ul style="list-style-type: none"> • application: four hole • showerhead type: handshower • handshower flow rate: 2.0 transitioning to 1.75 gpm • spray functions: one-function • spout reach: 9.00" • valve: sold separately 	T922	653.10	Chrome	3
	T922BN	1,075.00	Brushed Nickel	3
	T922ORB	1,182.50	Oil Rubbed Bronze	3
 <ul style="list-style-type: none"> • application: four hole • deck thickness: 1/8" to 2-5/8" rough-in deck • center dimensions: adjustable • non-adjustable spout shank: included • test plug: included 	9792	323.75	1/2" CC	6
 <ul style="list-style-type: none"> • application: four hole • deck thickness: 1/8" to 2-5/8" rough-in deck • center dimensions: 10" - 24" center • non-adjustable spout shank: included • test plug: included 	9793	331.35	1/2" CPVC, Crimp ring PEX	6
 <ul style="list-style-type: none"> • description: high flow thermostatic mixing valve for roman tubs • ports: three • ASSE standard 1070: yes • flow rate: 12.0 gpm (45.4 L/min) max. 	104465	173.00	1/2" CC	12
	104466	173.00	1/2" IPS	12
 <ul style="list-style-type: none"> • description: PEX transition fittings [2] and clips • connections: adapts standard 1/2" PEX barb to 1/2" PEX cold expansion 	140715	10.75	1/2" PEX	200

HOW TO ORDER A COMPLETE ROMAN TUB FAUCET

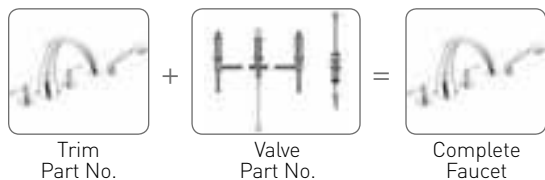















NOTES

 Moen® **M•PACT**® Common Valve System

Thermostatic Mixing Valve service kits, see page 498.

KINGSLEY® Transfer Valve/Moentrol® Transfer Valve Shower Spa Components

		MODEL NUMBER	LIST PRICE	FINISH/ CONNECTION	CASE QTY
2/3 FUNCTION TRANSFER VALVE ONLY					
 <ul style="list-style-type: none"> • use with 3372 or 3375 transfer valve • valve: sold separately  		T4311	106.50	Chrome	6
		T4311BN	143.10	Brushed Nickel	6
		T4311ORB	157.40	Oil Rubbed Bronze	6
 <ul style="list-style-type: none"> • type of function: two independent one shared • must be used with: Posi-Temp® or Moentrol® valve 		3372	172.00	1/2" CC	12
	 <ul style="list-style-type: none"> • type of function: two independent functions • must be used with: Posi-Temp® or Moentrol® valve 		3375	172.00	1/2" CC

MOENTROL® WITH TRANSFER VALVE					
 <ul style="list-style-type: none"> • showerhead type: showerhead sold separately • valve: sold separately  		T4111	159.40	Chrome	3
		T4111BN	214.10	Brushed Nickel	3
		T4111ORB	235.50	Oil Rubbed Bronze	3
		T4111P	236.45	Polished Brass	3
 <ul style="list-style-type: none"> • ports: four; two outlets • adjustable temp limit stop: included • check stops: included • type of function: two independent one shared • includes: volume control • not recommended: for tub spout application 		3320	275.85	1/2" IPS inlets/cc outlets	6
		3330	275.85	1/2" CC	6
 <ul style="list-style-type: none"> • ports: four; two outlets • adjustable temp limit stop: included • check stops: included • type of function: two independent functions • includes: volume control • not recommended: for tub spout application 		3350	275.85	1/2" CC	6

HOW TO ORDER A COMPLETE TRANSFER VALVE



HOW TO ORDER A COMPLETE MOENTROL® WITH TRANSFER VALVE











NOTES

Moentrol® M•FACT® Common Valve System

KINGSLEY® Moentrol® Showering

All Brushed Nickel and Polished Brass faucet components feature the LifeShine® Non-Tarnish Finish.

		MODEL NUMBER	LIST PRICE	FINISH/ CONNECTION	CASE QTY
MOENTROL® TUB/SHOWER					
	<ul style="list-style-type: none"> • showerhead functions: one-function • showerhead type: standard • showerhead size: 4-3/8" diameter spray head • showerhead flow rate: 2.5 gpm (9.5 L/min) max. • spout length: 5-1/2" • spout connection type: slip fit • tub spout type: diverter • valve: sold separately 	T3113	222.70	Chrome	3
		T3113BN	474.95	Brushed Nickel	3
		T3113ORB	522.30	Oil Rubbed Bronze	3
		T3113P	551.80	Polished Brass	3
					
	<ul style="list-style-type: none"> • showerhead type: showerhead sold separately • spout length: 5-1/2" • spout connection type: slip fit • tub spout type: diverter • valve: sold separately 	T3113NH	150.70	Chrome	3
		T3113NHBN	333.55	Brushed Nickel	3
		T3113NHORB	366.80	Oil Rubbed Bronze	3
					
	<ul style="list-style-type: none"> • description: pressure balanced valve with volume control • ports: four • adjustable temp limit stop: included • checks: included • includes: volume control 	3510	164.10	1/2" IPS	6
		3520	164.10	1/2" CC	6
					
	<ul style="list-style-type: none"> • description: pressure balanced valve with volume control • ports: four • adjustable temp limit stop: included • check stops: included • includes: volume control 	3570 ♦	195.50	1/2" CC	6
					

HOW TO ORDER A COMPLETE TUB/SHOWER FAUCET

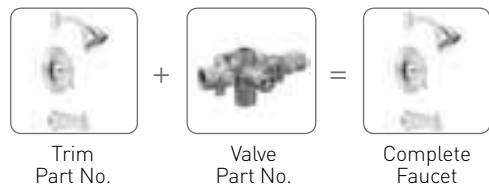











NOTES

- ♦ Also available in bulk pack. See page 435.
- Ⓜ Moen® **M•PACT**® Common Valve System

KINGSLEY® Moentrol® Showering

All Brushed Nickel and Polished Brass faucet components feature the LifeShine® Non-Tarnish Finish.

		MODEL NUMBER	LIST PRICE	FINISH/ CONNECTION	CASE QTY
MOENTROL® SHOWER ONLY					
 <ul style="list-style-type: none"> • showerhead functions: one-function • showerhead type: standard • showerhead size: 4-3/8" diameter spray head • showerhead flow rate: 2.5 gpm (9.5 L/min) max. • valve: sold separately  		T3112	164.15	Chrome	3
		T3112BN	371.85	Brushed Nickel	3
		T3112ORB	409.10	Oil Rubbed Bronze	3
		T3112P	432.20	Polished Brass	3
 <ul style="list-style-type: none"> • showerhead type: showerhead sold separately • valve: sold separately  		T3112NH	125.85	Chrome	3
		T3112NHBN	291.10	Brushed Nickel	3
		T3112NHORB	320.35	Oil Rubbed Bronze	3
 <ul style="list-style-type: none"> • description: pressure balanced valve with volume control • ports: four • adjustable temp limit stop: included • checks: included • includes: volume control 		3510	164.10	1/2" IPS	6
		3520	164.10	1/2" CC	6
 <ul style="list-style-type: none"> • description: pressure balanced valve with volume control • ports: four • adjustable temp limit stop: included • check stops: included • includes: volume control 		3570 ♦	195.50	1/2" CC	6

HOW TO ORDER A COMPLETE TUB/SHOWER FAUCET

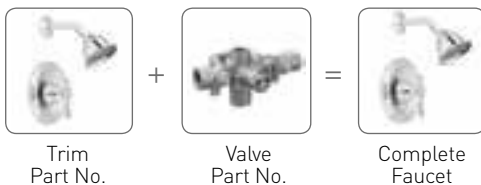







NOTES

- ♦ Also available in bulk pack. See page 435.
- Ⓜ Moen® **M•PACT**® Common Valve System

KINGSLEY® Moentrol® Showering

All Brushed Nickel and Polished Brass faucet components feature the LifeShine® Non-Tarnish Finish.

		MODEL NUMBER	LIST PRICE	FINISH/ CONNECTION	CASE QTY
MOENTROL® VALVE ONLY					
 <ul style="list-style-type: none"> • valve: sold separately  		T3111	123.00	Chrome	3
		T3111BN	287.00	Brushed Nickel	3
		T3111ORB	315.70	Oil Rubbed Bronze	3
		T3111P	333.45	Polished Brass	3
 <ul style="list-style-type: none"> • description: pressure balanced valve with volume control • ports: four • adjustable temp limit stop: included • checks: included • includes: volume control 		3510	164.10	1/2" IPS	6
		3520	164.10	1/2" CC	6
 <ul style="list-style-type: none"> • description: pressure balanced valve with volume control • ports: four • adjustable temp limit stop: included • check stops: included • includes: volume control 		3570 ♦	195.50	1/2" CC	6

HOW TO ORDER A COMPLETE VALVE

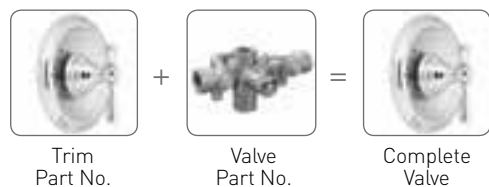











NOTES

- ♦ Also available in bulk pack. See page 435.
- Ⓜ Moen® **M•PACT**® Common Valve System

KINGSLEY® Posi-Temp® Showering

All Brushed Nickel and Polished Brass faucet components feature the LifeShine® Non-Tarnish Finish.

		MODEL NUMBER	LIST PRICE	FINISH/ CONNECTION	CASE QTY
POSI-TEMP® TUB/SHOWER					
	<ul style="list-style-type: none"> • showerhead functions: one-function • showerhead type: standard • showerhead size: 4-3/8" diameter spray head • showerhead flow rate: 2.5 gpm (9.5 L/min) max. • spout length: 5-1/2" • spout connection type: slip fit • tub spout type: diverter • valve: sold separately 	T2113	196.90	Chrome	3
		T2113BN	357.90	Brushed Nickel	3
		T2113ORB	393.85	Oil Rubbed Bronze	3
		T2113WR	393.85	Wrought Iron	3
		T2113P	487.15	Polished Brass	3
	<ul style="list-style-type: none"> • showerhead functions: one-function • showerhead type: eco-performance showerhead • showerhead size: 4-3/8" diameter spray head • showerhead flow rate: 1.75 gpm (6.65 L/min) max. • spout length: 5-1/2" • spout connection type: slip fit • tub spout type: diverter • valve: sold separately 	T2113EP	196.90	Chrome	3
		T2113EPBN	357.90	Brushed Nickel	3
		T2113EPORB	393.85	Oil Rubbed Bronze	3
		T2113EPP	487.15	Polished Brass	3
	<ul style="list-style-type: none"> • showerhead type: showerhead sold separately • spout length: 5-1/2" • spout connection type: slip fit • tub spout type: diverter • valve: sold separately 	T2113NH	132.60	Chrome	3
		T2113NHBN	259.35	Brushed Nickel	3
		T2113NHORB	285.30	Oil Rubbed Bronze	3
	<ul style="list-style-type: none"> • description: pressure balanced cycling valve • ports: four • adjustable temp limit stop: included 	2510 ♦	119.75	1/2" IPS	6
		2520 ♦	119.75	1/2" CC	6
		2580 ♦	119.75	1/2" Crimp ring PEX	6
	<ul style="list-style-type: none"> • description: pressure balanced cycling valve • ports: four • adjustable temp limit stop: included • quarter turn stops: included 	2570 ♦	145.35	1/2" CC	6
		2590 ♦	145.35	1/2" IPS	6

KINGSLEY®

HOW TO ORDER A COMPLETE TUB/SHOWER FAUCET

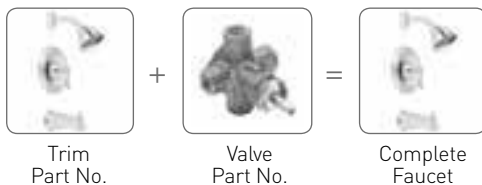











NOTES

- ♦ Also available in bulk pack. See page 435.
- Ⓜ Moen® **M•PACT**® Common Valve System

KINGSLEY® Posi-Temp® Showering

All Brushed Nickel and Polished Brass faucet components feature the LifeShine® Non-Tarnish Finish.

		MODEL NUMBER	LIST PRICE	FINISH/ CONNECTION	CASE QTY
POSI-TEMP® SHOWER ONLY					
 <ul style="list-style-type: none"> • showerhead functions: one-function • showerhead type: standard • showerhead size: 4-3/8" diameter spray head • showerhead flow rate: 2.5 gpm (9.5 L/min) max. • valve: sold separately 		T2112	154.80	Chrome	3
		T2112BN	281.55	Brushed Nickel	3
		T2112ORB	309.65	Oil Rubbed Bronze	3
		T2112WR	309.65	Wrought Iron	3
		T2112P	394.65	Polished Brass	3
 <ul style="list-style-type: none"> • showerhead functions: one-function • showerhead type: eco-performance showerhead • showerhead size: 4-3/8" diameter spray head • showerhead flow rate: 1.75 gpm (6.65 L/min) max. • valve: sold separately 		T2112EP	154.80	Chrome	3
		T2112EPBN	281.55	Brushed Nickel	3
		T2112EPORB	309.65	Oil Rubbed Bronze	3
		T2112EPP	394.65	Polished Brass	3
 <ul style="list-style-type: none"> • showerhead type: showerhead sold separately • valve: sold separately 		T2112NH	123.15	Chrome	3
		T2112NHBN	223.65	Brushed Nickel	3
		T2112NHORB	246.00	Oil Rubbed Bronze	3
 <ul style="list-style-type: none"> • description: pressure balanced cycling valve • ports: four • adjustable temp limit stop: included 		2510 ♦	119.75	1/2" IPS	6
		2520 ♦	119.75	1/2" CC	6
		2580 ♦	119.75	1/2" Crimp ring PEX	6
 <ul style="list-style-type: none"> • description: pressure balanced cycling valve • ports: four • adjustable temp limit stop: included • quarter turn stops: included 		2570 ♦	145.35	1/2" CC	6
		2590 ♦	145.35	1/2" IPS	6

HOW TO ORDER A COMPLETE SHOWER FAUCET

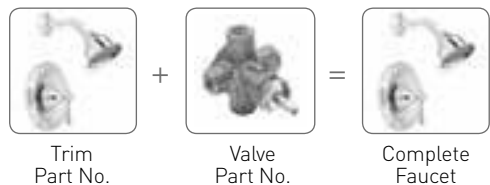













NOTES

- ♦ Also available in bulk pack. See page 435.
- Ⓜ Moen® **M•PACT**® Common Valve System

KINGSLEY® Posi-Temp® Showering, Bidets

All Brushed Nickel and Polished Brass faucet components feature the LifeShine® Non-Tarnish Finish.

		MODEL NUMBER	LIST PRICE	FINISH/ CONNECTION	CASE QTY
POSI-TEMP® VALVE ONLY					
 <ul style="list-style-type: none"> valve: sold separately  		T2111	116.15	Chrome	3
		T2111BN	210.90	Brushed Nickel	3
		T2111ORB	232.05	Oil Rubbed Bronze	3
		T2111WR	232.05	Wrought Iron	3
		T2111P	313.75	Polished Brass	3
 <ul style="list-style-type: none"> description: pressure balanced cycling valve ports: four adjustable temp limit stop: included 		2510 ♦	119.75	1/2" IPS	6
		2520 ♦	119.75	1/2" CC	6
		2580 ♦	119.75	1/2" Crimp ring PEX	6
 <ul style="list-style-type: none"> description: pressure balanced cycling valve ports: four adjustable temp limit stop: included quarter turn stops: included 		2570 ♦	145.35	1/2" CC	6
		2590 ♦	145.35	1/2" IPS	6
TWO-HANDLE BIDET					
 <ul style="list-style-type: none"> center dimensions: 8" - 16" center valve: sold separately  		T5210	401.50	Chrome	3
		T5210BN	549.85	Brushed Nickel	3
		T5210ORB	604.80	Oil Rubbed Bronze	3
 <ul style="list-style-type: none"> application: three hole center dimensions: 8" - 16" center  DURALOCK® DURALAST®		9265	254.45	1/2" IPS	6

HOW TO ORDER A COMPLETE VALVE

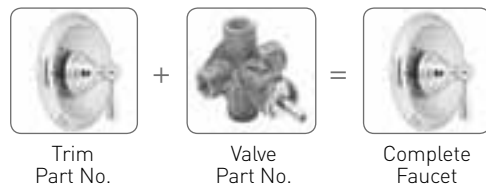

HOW TO ORDER A COMPLETE BIDET FAUCET

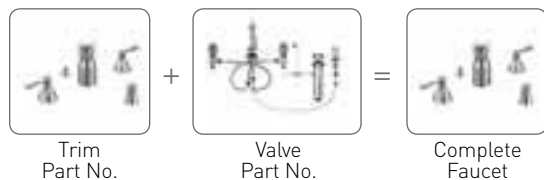

NOTES

- ♦ Also available in bulk pack. See page 435.
- Ⓜ Moen® **M•PACT®** Common Valve System
- DURALOCK** Duralock® Quick Connections
- DURALAST** Duralast® Cartridge

KINGSLEY® Perfectly Matched Bath Accessories

Moen® bath accessories CANNOT be combined with Moen® faucet parts on a Purchase Order.

Moen makes it easy to coordinate the entire style and look of the bathroom. Our Kingsley® bath accessories perfectly match the style and finish of our Kingsley® faucets. Total coordination of the bath has never been easier.

For more information on ordering Kingsley® bath accessories or other matching Moen® bath accessories, contact Moen Bath Accessory Customer Service at **800-882-0116**, contact your local Moen sales representative, or visit us at www.moen.com.

MODEL NUMBER	LIST PRICE EACH	DESCRIPTION	QTY
5/8-in. Round Bar			
Chrome (CH)			
YB5401CH	32.50	Tank Lever	24
YB5403CH	24.95	Double Robe Hook	6
YB5405CH	7.70	Drawer Knob	48
YB5407CH	15.35	Drawer Pull	48
(P) YB5408CH	45.65	Pivoting Paper Holder	6
YB5418CH	53.00	18" Towel Bar	6
YB5422CH	70.95	24" Double Towel Bar	6
YB5424CH	54.65	24" Towel Bar	6
YB5486CH	37.20	Towel Ring	6
YB5490CH	70.40	Vanity Shelf	3
YB5494CH	177.50	Towel Shelf	2
Brushed Nickel (BN)			
YB5401BN	35.85	Tank Lever	24
YB5403BN	27.50	Double Robe Hook	24
YB5405BN	9.70	Drawer Knob	48
YB5407BN	19.10	Drawer Pull	48
(P) YB5408BN	50.50	Pivoting Paper Holder	6
YB5418BN	58.25	18" Towel Bar	6
YB5422BN	76.45	24" Double Towel Bar	6
YB5424BN	60.30	24" Towel Bar	6
YB5486BN	40.70	Towel Ring	6
YB5490BN	75.70	Vanity Shelf	3
YB5494BN	195.65	Towel Shelf	2
Oil Rubbed Bronze (ORB)			
YB5401ORB	39.40	Tank Lever	24
YB5403ORB	30.25	Double Robe Hook	24
YB5405ORB	10.30	Drawer Knob	48
YB5407ORB	20.80	Drawer Pull	48
(P) YB5408ORB	55.60	Pivoting Paper Holder	6
YB5418ORB	64.05	18" Towel Bar	6
YB5422ORB	84.20	24" Double Towel Bar	6
YB5424ORB	66.40	24" Towel Bar	6
YB5486ORB	44.75	Towel Ring	6
YB5490ORB	83.35	Vanity Shelf	3
YB5494ORB	215.25	Towel Shelf	2
Wrought Iron (WR)			
YB5401WR	39.40	Tank Lever	24
YB5403WR	30.25	Double Robe Hook	24
(P) YB5408WR	55.60	Pivoting Paper Holder	6
YB5418WR	64.05	18" Towel Bar	6
YB5422WR	84.20	24" Double Towel Bar	6
YB5424WR	66.40	24" Towel Bar	6
YB5486WR	44.75	Towel Ring	6
YB5490WR	83.35	Vanity Shelf	3
Polished Brass (PB)			
YB5401PB	30.15	Tank Lever	24
YB5403PB	23.20	Double Robe Hook	24
(P) YB5408PB	42.40	Pivoting Paper Holder	6
YB5418PB	52.15	18" Towel Bar	6
YB5422PB	68.45	24" Double Towel Bar	6
YB5424PB	50.45	24" Towel Bar	6
YB5486PB	34.50	Towel Ring	6

(P) Denotes pivoting paper holder

List price is per each (unless otherwise noted). Product can be ordered by case quantity or individually.

KINGSLEY® Perfectly Matched Bath Accessories



YB5401
Tank Lever



YB5403
Double Robe Hook



YB5405
Drawer Knob
(Available in BN, CH and ORB only)



YB5407
Drawer Pull
(Available in BN, CH and ORB only)



YB5408 ^(P)
Pivoting Paper Holder



YB5418
18" Towel Bar



YB5422
24" Double Towel Bar



YB5424
24" Towel Bar



YB5486
Towel Ring



YB5490
Vanity Shelf
(Not available in PB)



YB5494
Towel Shelf
(Available in BN, CH and ORB only)

GRAB BARS

PERFECTLY MATCHED to Moen® Kingsley® faucets and bath accessories. ADA-compliant.

SecureMount™



SecureMount™ Grab Bars are manufactured with an innovative flange design that makes it easy to connect to the stud at multiple points.

To install grab bars securely without studs, use SecureMount™ Anchors. Sold separately.

MODEL NUMBER	LIST PRICE EACH	DESCRIPTION	QTY
--------------	-----------------	-------------	-----

1-1/4" • Chrome (CH)

YG5412CH	88.85	12" Designer Grab Bar	3
YG5418CH	92.85	18" Designer Grab Bar	3
YG5424CH	96.95	24" Designer Grab Bar	3
YG5430CH	103.75	30" Designer Grab Bar	3
YG5436CH	110.40	36" Designer Grab Bar	3
YG5442CH	162.00	42" Designer Grab Bar	3

1-1/4" • Brushed Nickel (BN)

YG5412BN	107.40	12" Designer Grab Bar	3
YG5418BN	112.60	18" Designer Grab Bar	3
YG5424BN	121.50	24" Designer Grab Bar	3
YG5430BN	126.55	30" Designer Grab Bar	3
YG5436BN	136.75	36" Designer Grab Bar	3
YG5442BN	202.50	42" Designer Grab Bar	3

1-1/4" • Oil Rubbed Bronze (ORB)

YG5412ORB	118.10	12" Designer Grab Bar	3
YG5418ORB	123.90	18" Designer Grab Bar	3
YG5424ORB	133.70	24" Designer Grab Bar	3

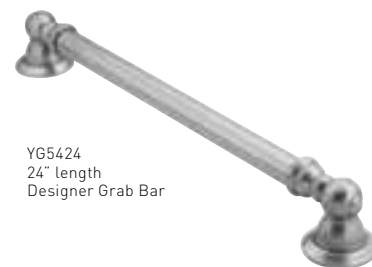

YG5424
24" length
Designer Grab Bar

KINGSLEY®



^(P) Denotes pivoting paper holder







 Complies with Americans with Disabilities Act (ADA) specifications. SecureMount™ Grab Bars are tested to withstand 500 lb. pull when securely installed per instructions.

List price is per each (unless otherwise noted). Product can be ordered by case quantity or individually.

RIZON® Bathroom Faucets

All Brushed Nickel faucet components feature the LifeShine® Non-Tarnish Finish.

		MODEL NUMBER	LIST PRICE	FINISH/ CONNECTION	CASE QTY
ONE-HANDLE BATHROOM FAUCET					
 <ul style="list-style-type: none"> • application: one or three hole • supply line length: flexible • connection size: 3/8" • connection type: compression • deckplate: sold separately • drain assembly: metal • drain assembly type: lift rod • red/blue markings: included   DURALAST®	6900	258.85	Chrome	3	
	6900BN	385.55	Brushed Nickel	3	
	DECKPLATE SOLD SEPARATELY				
	165006	23.60	Chrome	20	
	165006BN	44.35	Brushed Nickel	20	

TWO-HANDLE WIDESPREAD BATHROOM FAUCET					
 <ul style="list-style-type: none"> • application: three hole • center dimensions: 8" - 16" center • drain assembly: metal • drain assembly type: lift rod • red/blue markings: included • valve: sold separately   	T6920	257.60	Chrome	3	
	T6920BN	432.95	Brushed Nickel	3	
 <ul style="list-style-type: none"> • application: three hole • center dimensions: 8" - 16" center • drain assembly: metal • drain assembly type: lift rod  DURALOCK® DURALAST®	9000 ♦	123.55	1/2" IPS	6	

HOW TO ORDER A COMPLETE BATHROOM FAUCET

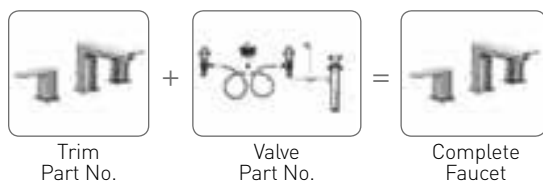











NOTES

- ♦ Also available in bulk pack. See page 435.
- Ⓜ Moen® **M•PACT®** Common Valve System
- DURALOCK®** Duralock® Quick Connections
- DURALAST®** Duralast® Cartridge

Refer to lavatory waste assemblies on page 403.
Refer to specification sheet for critical dimensions for installation.

RIZON® Roman Tub

All Brushed Nickel faucet components feature the LifeShine® Non-Tarnish Finish.

	MODEL NUMBER	LIST PRICE	FINISH/ CONNECTION	CASE QTY
TWO-HANDLE ROMAN TUB				
 <ul style="list-style-type: none"> • application: three hole • spout reach: 7.68" • valve: sold separately 	T935	364.55	Chrome	3
	T935BN	509.45	Brushed Nickel	3
 <ul style="list-style-type: none"> • application: three hole • deck thickness: 1/8" to 3-3/8" rough-in deck • center dimensions: adjustable • adjustable spout shank: included • test plug: included 	4792	143.70	1/2" CC	6
 <ul style="list-style-type: none"> • application: three hole • deck thickness: 1/8" to 2-3/4" rough-in deck • center dimensions: 10" - 24" center • adjustable spout shank: included • test plug: included 	4793	162.70	1/2" CPVC, Crimp ring PEX	6
	4794	155.15	1/2" Crimp ring PEX, Cold Expansion PEX	6
 <ul style="list-style-type: none"> • application: three hole • deck thickness: 1/8" to 1-7/8" rough-in deck • center dimensions: 10" center • non-adjustable spout shank: included • test plug: included 	4796	135.35	1/2" CC	6
	4797	138.00	1/2" CPVC, Crimp ring PEX	6
	4798	138.00	1/2" Crimp ring PEX, Cold Expansion PEX	6
 <ul style="list-style-type: none"> • description: high flow thermostatic mixing valve for roman tubs • ports: three • ASSE standard 1070: yes • flow rate: 12.0 gpm (45.4 L/min) max. 	104465	173.00	1/2" CC	12
	104466	173.00	1/2" IPS	12
 <ul style="list-style-type: none"> • description: PEX transition fittings (2) and clips • connections: adapts standard 1/2" PEX barb to 1/2" PEX cold expansion 	140715	10.75	1/2" PEX	200

RIZON®



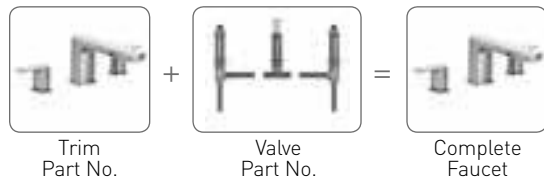





HOW TO ORDER A COMPLETE ROMAN TUB FAUCET



NOTES

 Moen® **M•PACT**® Common Valve System

Thermostatic Mixing Valve service kits, see page 498.

	MODEL NUMBER	LIST PRICE	FINISH/ CONNECTION	CASE QTY
TWO-HANDLE ROMAN TUB WITH HANDSHOWER				
 <ul style="list-style-type: none"> • application: four hole • showerhead type: handshower • handshower flow rate: 2.0 transitioning to 1.75 gpm • spray functions: one-function • spout reach: 7.68" • valve: sold separately 	T936	567.90	Chrome	3
 <ul style="list-style-type: none"> • application: four hole • deck thickness: 1/8" to 2-5/8" rough-in deck • center dimensions: adjustable • non-adjustable spout shank: included • test plug: included 	9792	323.75	1/2" CC	6
 <ul style="list-style-type: none"> • application: four hole • deck thickness: 1/8" to 2-5/8" rough-in deck • center dimensions: 10" - 24" center • non-adjustable spout shank: included • test plug: included 	9793	331.35	1/2" CPVC, Crimp ring PEX	6
 <ul style="list-style-type: none"> • description: high flow thermostatic mixing valve for roman tubs • ports: three • ASSE standard 1070: yes • flow rate: 12.0 gpm (45.4 L/min) max. 	104465 104466	173.00 173.00	1/2" CC 1/2" IPS	12 12
 <ul style="list-style-type: none"> • description: PEX transition fittings (2) and clips • connections: adapts standard 1/2" PEX barb to 1/2" PEX cold expansion 	140715	10.75	1/2" PEX	200

HOW TO ORDER A COMPLETE ROMAN TUB FAUCET

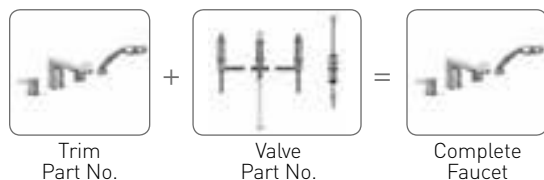

NOTES

 Moen® **M•PACT®** Common Valve System

Thermostatic Mixing Valve service kits, see page 498.

RIZON® Transfer Valve Shower Spa Components

All Brushed Nickel faucet components feature the LifeShine® Non-Tarnish Finish.

		MODEL NUMBER	LIST PRICE	FINISH/ CONNECTION	CASE QTY
3 INDEPENDENT FUNCTION TRANSFER VALVE ONLY					
 <ul style="list-style-type: none"> • use with 3362 transfer valve • valve: sold separately 		T2082	106.50	Chrome	12
		T2082BN	143.10	Brushed Nickel	12
 <ul style="list-style-type: none"> • ports: four • type of function: three independent function • must be used with: Posi-Temp® or Moentrol® valve 		3362	192.60	1/2" CC	6
2/3 FUNCTION TRANSFER VALVE ONLY					
 <ul style="list-style-type: none"> • use with 3372 or 3375 transfer valve • valve: sold separately 		T2081	106.50	Chrome	12
		T2081BN	143.10	Brushed Nickel	12
 <ul style="list-style-type: none"> • type of function: two independent one shared • must be used with: Posi-Temp® or Moentrol® valve 		3372	172.00	1/2" CC	12
 <ul style="list-style-type: none"> • type of function: two independent functions • must be used with: Posi-Temp® or Moentrol® valve 		3375	172.00	1/2" CC	12

RIZON®

HOW TO ORDER A COMPLETE TRANSFER VALVE

















NOTES

-  Moen® **M•PACT**® Common Valve System
- DURALAST** Duralast® Cartridge

RIZON® Posi-Temp® Showering

All Brushed Nickel faucet components feature the LifeShine® Non-Tarnish Finish.

		MODEL NUMBER	LIST PRICE	FINISH/ CONNECTION	CASE QTY
POSI-TEMP® TUB/SHOWER					
	<ul style="list-style-type: none"> • showerhead functions: one-function • showerhead type: standard • showerhead size: 3.75" diameter spray head • showerhead flow rate: 2.5 gpm (9.5 L/min) max. • spout length: 7" • spout connection type: slip fit • tub spout type: diverter • red/blue markings: included • valve: sold separately  	T2813	196.90	Chrome	3
		T2813BN	357.90	Brushed Nickel	3
	<ul style="list-style-type: none"> • showerhead functions: one-function • showerhead type: eco-performance showerhead • showerhead size: 3.75" diameter spray head • showerhead flow rate: 1.75 gpm (6.65 L/min) max. • spout length: 7" • spout connection type: slip fit • tub spout type: diverter • red/blue markings: included • valve: sold separately   	T2813EP	196.90	Chrome	3
		T2813EPBN	357.90	Brushed Nickel	3
	<ul style="list-style-type: none"> • showerhead type: showerhead sold separately • spout length: 7" • spout connection type: slip fit • tub spout type: diverter • red/blue markings: included • valve: sold separately  	T2813NH	132.60	Chrome	3
		T2813NHBN	259.35	Brushed Nickel	3
		2510 ♦	119.75	1/2" IPS	6
		2520 ♦	119.75	1/2" CC	6
		2580 ♦	119.75	1/2" Crimp ring PEX	6
		2570 ♦	145.35	1/2" CC	6
		2590 ♦	145.35	1/2" IPS	6

HOW TO ORDER A COMPLETE TUB/SHOWER FAUCET

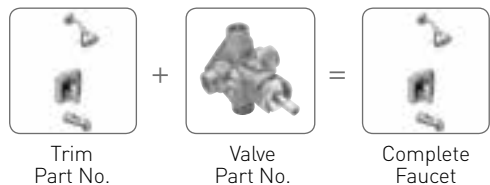











NOTES

- ♦ Also available in bulk pack. See page 435.
- Ⓜ Moen® **M•PACT**® Common Valve System

RIZON® Posi-Temp® Showering

All Brushed Nickel faucet components feature the LifeShine® Non-Tarnish Finish.

		MODEL NUMBER	LIST PRICE	FINISH/ CONNECTION	CASE QTY
POSI-TEMP® SHOWER ONLY					
	<ul style="list-style-type: none"> • showerhead functions: one-function • showerhead type: standard • showerhead size: 3.75" diameter spray head • showerhead flow rate: 2.5 gpm (9.5 L/min) max. • red/blue markings: included • valve: sold separately 	T2812	154.80	Chrome	3
		T2812BN	281.55	Brushed Nickel	3
	<ul style="list-style-type: none"> • showerhead functions: one-function • showerhead type: eco-performance showerhead • showerhead size: 3.75" diameter spray head • showerhead flow rate: 1.75 gpm (6.65 L/min) max. • red/blue markings: included • valve: sold separately 	T2812EP	154.80	Chrome	3
		T2812EPBN	281.55	Brushed Nickel	3
	<ul style="list-style-type: none"> • showerhead type: showerhead sold separately • red/blue markings: included • valve: sold separately 	T2812NH	123.15	Chrome	3
		T2812NHBN	223.65	Brushed Nickel	3
		2510 ♦	119.75	1/2" IPS	6
		2520 ♦	119.75	1/2" CC	6
		2580 ♦	119.75	1/2" Crimp ring PEX	6
		2570 ♦	145.35	1/2" CC	6
		2590 ♦	145.35	1/2" IPS	6

HOW TO ORDER A COMPLETE SHOWER FAUCET

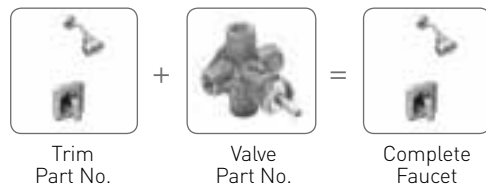







NOTES

- ♦ Also available in bulk pack. See page 435.
- Ⓜ Moen® **M•PACT**® Common Valve System

RIZON® Posi-Temp® Showering

All Brushed Nickel faucet components feature the LifeShine® Non-Tarnish Finish.

		MODEL NUMBER	LIST PRICE	FINISH/ CONNECTION	CASE QTY
POSI-TEMP® VALVE ONLY					
 <ul style="list-style-type: none"> • red/blue markings: included • valve: sold separately  		T2811	116.15	Chrome	3
		T2811BN	210.90	Brushed Nickel	3
 		2510 ♦	119.75	1/2" IPS	6
		2520 ♦	119.75	1/2" CC	6
		2580 ♦	119.75	1/2" Crimp ring PEX	6
 		2570 ♦	145.35	1/2" CC	6
		2590 ♦	145.35	1/2" IPS	6

HOW TO ORDER A COMPLETE VALVE











NOTES

- ♦ Also available in bulk pack. See page 435.
- Ⓜ Moen® **M•PACT**® Common Valve System



DARTMOOR™ Bathroom Faucets

All Brushed Nickel faucet components feature the LifeShine® Non-Tarnish Finish.

	MODEL NUMBER	LIST PRICE	FINISH/ CONNECTION	CASE QTY
TWO-HANDLE CENTERSET BATHROOM FAUCET				
 <ul style="list-style-type: none"> • application: three hole • center dimensions: 4" center • connection size: 1/2" • connection type: IPS • drain assembly: metal • drain assembly type: lift rod   DURALAST®	6802 ♦	166.70	Chrome	3
	6802BN	226.45	Brushed Nickel	3
	6802ORB	249.10	Oil Rubbed Bronze	3
TWO-HANDLE WIDESPREAD BATHROOM FAUCET				
 <ul style="list-style-type: none"> • application: three hole • center dimensions: 8" - 16" center • drain assembly: metal • drain assembly type: lift rod • valve: sold separately   	T6805	164.70	Chrome	3
	T6805BN	246.90	Brushed Nickel	3
	T6805ORB	271.50	Oil Rubbed Bronze	3
 <ul style="list-style-type: none"> • application: three hole • center dimensions: 8" - 16" center • drain assembly: metal • drain assembly type: lift rod  DURALOCK® DURALAST®	9000 ♦	123.55	1/2" IPS	6

DARTMOOR™

HOW TO ORDER A COMPLETE BATHROOM FAUCET

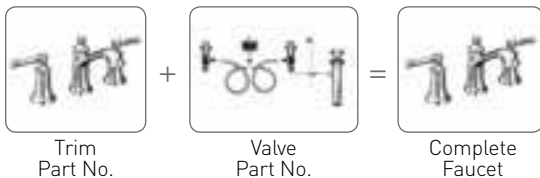







NOTES

- ♦ Also available in bulk pack. See page 435.
- Ⓜ Moen® **M•PACT®** Common Valve System
- DURALOCK®** Duralock® Quick Connections
- DURALAST®** Duralast® Cartridge

Refer to specification sheet for critical dimensions for installation.

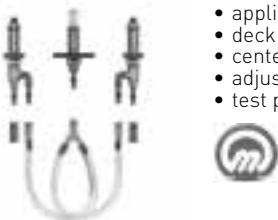
DARTMOOR™ Roman Tubs

All Brushed Nickel faucet components feature the LifeShine® Non-Tarnish Finish.

	MODEL NUMBER	LIST PRICE	FINISH/ CONNECTION	CASE QTY
TWO-HANDLE ROMAN TUB				
 <ul style="list-style-type: none"> • application: three hole • spout reach: 7.64" • valve: sold separately 	T683 T683BN T683ORB	268.80 402.15 442.45	Chrome Brushed Nickel Oil Rubbed Bronze	3 3 3
 <ul style="list-style-type: none"> • application: three hole • deck thickness: 1/8" to 3-3/8" rough-in deck • center dimensions: adjustable • adjustable spout shank: included • test plug: included 	4792	143.70	1/2" CC	6
 <ul style="list-style-type: none"> • application: three hole • deck thickness: 1/8" to 2-3/4" rough-in deck • center dimensions: 10" - 24" center • adjustable spout shank: included • test plug: included 	4793 4794	162.70 155.15	1/2" CPVC, Crimp ring PEX 1/2" Crimp ring PEX, Cold Expansion PEX	6 6
 <ul style="list-style-type: none"> • application: three hole • deck thickness: 1/8" to 1-7/8" rough-in deck • center dimensions: 10" center • non-adjustable spout shank: included • test plug: included 	4796 4797 4798	135.35 138.00 138.00	1/2" CC 1/2" CPVC, Crimp ring PEX 1/2" Crimp ring PEX, Cold Expansion PEX	6 6 6
 <ul style="list-style-type: none"> • description: high flow thermostatic mixing valve for roman tubs • ports: three • ASSE standard 1070: yes • flow rate: 12.0 gpm (45.4 L/min) max. 	104465 104466	173.00 173.00	1/2" CC 1/2" IPS	12 12
 <ul style="list-style-type: none"> • description: PEX transition fittings (2) and clips • connections: adapts standard 1/2" PEX barb to 1/2" PEX cold expansion 	140715	10.75	1/2" PEX	200

HOW TO ORDER A COMPLETE ROMAN TUB FAUCET

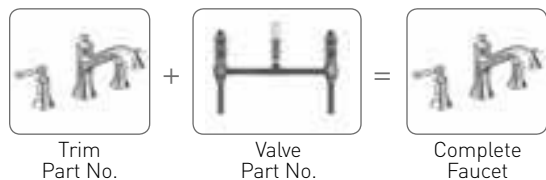





NOTES

 Moen® **M•PACT**® Common Valve System

Thermostatic Mixing Valve service kits, see page 498.

DARTMOOR™ Transfer Valve Shower Spa Components

All Brushed Nickel faucet components feature the LifeShine® Non-Tarnish Finish.

		MODEL NUMBER	LIST PRICE	FINISH/ CONNECTION	CASE QTY
2/3 FUNCTION TRANSFER VALVE ONLY					
 <ul style="list-style-type: none"> • use with 3372 or 3375 transfer valve • valve: sold separately  		T2031	90.50	Chrome	12
		T2031BN	121.60	Brushed Nickel	12
		T2031ORB	133.80	Oil Rubbed Bronze	12
 	<ul style="list-style-type: none"> • type of function: two independent one shared • must be used with: Posi-Temp® or Moentrol® valve 	3372	172.00	1/2" CC	12
	<ul style="list-style-type: none"> • type of function: two independent functions • must be used with: Posi-Temp® or Moentrol® valve 	3375	172.00	1/2" CC	12

DARTMOOR™

HOW TO ORDER A COMPLETE TRANSFER VALVE

















NOTES

 Moen® **M•PACT®** Common Valve System

DARTMOOR™ Posi-Temp® Showering

All Brushed Nickel faucet components feature the LifeShine® Non-Tarnish Finish.

	MODEL NUMBER	LIST PRICE	FINISH/ CONNECTION	CASE QTY	
POSI-TEMP® TUB/SHOWER					
 <ul style="list-style-type: none"> • showerhead functions: one-function • showerhead type: eco-performance rainshower • showerhead size: 8" diameter spray head • showerhead flow rate: 2.0 transitioning to 1.75 gpm • spout length: 7" • spout connection type: slip fit • tub spout type: diverter • valve: sold separately   	T2283EP T2283EPBN T2283EPORB	143.90 241.20 261.15	Chrome Brushed Nickel Oil Rubbed Bronze	4 4 4	
	 <ul style="list-style-type: none"> • showerhead functions: one-function • showerhead type: standard • showerhead size: 4" diameter spray head • showerhead flow rate: 2.5 gpm (9.5 L/min) max. • spout length: 7" • spout connection type: slip fit • tub spout type: diverter • valve: sold separately  	T2183 ♦ T2183BN T2183ORB	89.80 204.00 224.40	Chrome Brushed Nickel Oil Rubbed Bronze	3 3 3
		 <ul style="list-style-type: none"> • showerhead functions: one-function • showerhead type: eco-performance showerhead • showerhead size: 4" diameter spray head • showerhead flow rate: 1.75 gpm (6.65 L/min) max. • spout length: 7" • spout connection type: slip fit • tub spout type: diverter • valve: sold separately   	T2183EP T2183EPBN T2183EPORB	89.80 204.00 224.40	Chrome Brushed Nickel Oil Rubbed Bronze
 <ul style="list-style-type: none"> • description: pressure balanced cycling valve • ports: four • adjustable temp limit stop: included 			2510 ♦ 2520 ♦ 2580 ♦	119.75 119.75 119.75	1/2" IPS 1/2" CC 1/2" Crimp ring PEX
	 <ul style="list-style-type: none"> • description: pressure balanced cycling valve • ports: four • adjustable temp limit stop: included • quarter turn stops: included 		2570 ♦ 2590 ♦	145.35 145.35	1/2" CC 1/2" IPS

HOW TO ORDER A COMPLETE TUB/SHOWER FAUCET

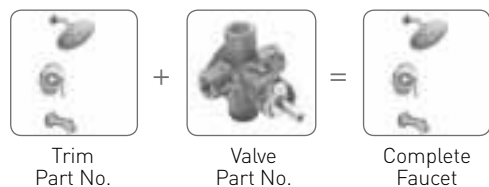















NOTES

- ♦ Also available in bulk pack. See page 435.
- Ⓜ Moen® **M•PACT**® Common Valve System

DARTMOOR™ Posi-Temp® Showering

All Brushed Nickel faucet components feature the LifeShine® Non-Tarnish Finish.

		MODEL NUMBER	LIST PRICE	FINISH/ CONNECTION	CASE QTY
POSI-TEMP® SHOWER ONLY					
 <ul style="list-style-type: none"> • showerhead functions: one-function • showerhead type: eco-performance rainshower • showerhead size: 8" diameter spray head • showerhead flow rate: 2.0 transitioning to 1.75 gpm • valve: sold separately   		T2282EP	111.85	Chrome	4
		T2282EPBN	192.90	Brushed Nickel	4
		T2282EPORB	207.95	Oil Rubbed Bronze	4
 <ul style="list-style-type: none"> • showerhead functions: one-function • showerhead type: standard • showerhead size: 4" diameter spray head • showerhead flow rate: 2.5 gpm (9.5 L/min) max. • valve: sold separately  		T2182 ♦	59.60	Chrome	3
		T2182BN	154.65	Brushed Nickel	3
		T2182ORB	170.10	Oil Rubbed Bronze	3
 <ul style="list-style-type: none"> • showerhead functions: one-function • showerhead type: eco-performance showerhead • showerhead size: 4" diameter spray head • showerhead flow rate: 1.75 gpm (6.65 L/min) max. • valve: sold separately   		T2182EP	59.60	Chrome	3
		T2182EPBN	154.65	Brushed Nickel	3
		T2182EPORB	170.10	Oil Rubbed Bronze	3
 <ul style="list-style-type: none"> • description: pressure balanced cycling valve • ports: four • adjustable temp limit stop: included 		2510 ♦	119.75	1/2" IPS	6
		2520 ♦	119.75	1/2" CC	6
		2580 ♦	119.75	1/2" Crimp ring PEX	6
 <ul style="list-style-type: none"> • description: pressure balanced cycling valve • ports: four • adjustable temp limit stop: included • quarter turn stops: included 		2570 ♦	145.35	1/2" CC	6
		2590 ♦	145.35	1/2" IPS	6

DARTMOOR™

HOW TO ORDER A COMPLETE SHOWER FAUCET

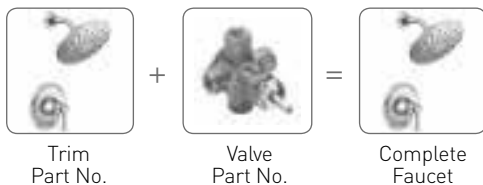







NOTES

- ♦ Also available in bulk pack. See page 435.
- Ⓜ Moen® **M•PACT**® Common Valve System

DARTMOOR™ Posi-Temp® Showering

All Brushed Nickel faucet components feature the LifeShine® Non-Tarnish Finish.

		MODEL NUMBER	LIST PRICE	FINISH/ CONNECTION	CASE QTY
POSI-TEMP® VALVE ONLY					
 <ul style="list-style-type: none"> • valve: sold separately  		T2181	44.35	Chrome	3
		T2181BN	125.15	Brushed Nickel	3
		T2181ORB	137.65	Oil Rubbed Bronze	3
 		2510 ♦	119.75	1/2" IPS	6
		2520 ♦	119.75	1/2" CC	6
		2580 ♦	119.75	1/2" Crimp ring PEX	6
 		2570 ♦	145.35	1/2" CC	6
		2590 ♦	145.35	1/2" IPS	6

HOW TO ORDER A COMPLETE VALVE



NOTES

- ♦ Also available in bulk pack. See page 435.
- Ⓜ Moen® **M•PACT**® Common Valve System

Moen® bath accessories CANNOT be combined with Moen® faucet parts on a Purchase Order.

Moen makes it easy to coordinate the entire style and look of the bathroom. Our Dartmoor™ bath accessories perfectly match the style and finish of our Dartmoor™ faucets. Total coordination of the bath has never been easier.

For more information on ordering Dartmoor™ bath accessories or other matching Moen® bath accessories, contact Moen Bath Accessory Customer Service at **800-882-0116**, contact your local Moen sales representative, or visit us at **www.moen.com**.

MODEL NUMBER	LIST PRICE EACH	DESCRIPTION	QTY
Chrome (CH)			
YB2101CH	19.20	Tank Lever	24
YB2103CH	13.65	Double Robe Hook	24
YB2108CH	24.40	Paper Holder	6
YB2118CH	29.95	18" Towel Bar	6
YB2124CH	31.55	24" Towel Bar	6
YB2186CH	18.65	Towel Ring	6
Brushed Nickel (BN)			
YB2101BN	29.45	Tank Lever	24
YB2103BN	20.80	Double Robe Hook	24
YB2108BN	37.45	Paper Holder	6
YB2118BN	46.00	18" Towel Bar	6
YB2124BN	48.35	24" Towel Bar	6
YB2186BN	28.40	Towel Ring	6
Oil Rubbed Bronze (ORB)			
YB2101ORB	32.35	Tank Lever	24
YB2103ORB	22.90	Double Robe Hook	24
YB2108ORB	41.15	Paper Holder	6
YB2118ORB	50.60	18" Towel Bar	6
YB2124ORB	53.20	24" Towel Bar	6
YB2186ORB	31.35	Towel Ring	6



YB2101 Tank Lever



YB2103 Double Robe Hook



YB2108 Paper Holder



YB2118 18" Towel Bar



YB2124 24" Towel Bar



YB2186 Towel Ring











YB8081 Pro-Fit® Installation Mounting Template (See page 90 for more information about the Pro-Fit® Installation System.)

DARTMOOR™

GLYDE™ Bathroom Faucets

All Brushed Nickel faucet components feature the LifeShine® Non-Tarnish Finish.

	MODEL NUMBER	LIST PRICE	FINISH/ CONNECTION	CASE QTY
TWO-HANDLE CENTERSET BATHROOM FAUCET				
 <ul style="list-style-type: none"> • application: three hole • center dimensions: 4" center • connection size: 1/2" • connection type: IPS • drain assembly: metal • drain assembly type: lift rod   DURALAST®	6172 ♦ 6172BN	166.70 226.45	Chrome Brushed Nickel	3 3
	TWO-HANDLE WIDESPREAD BATHROOM FAUCET			
 <ul style="list-style-type: none"> • application: three hole • center dimensions: 8" - 16" center • drain assembly: metal • drain assembly type: lift rod • valve: sold separately   	T6173 T6173BN	164.70 246.90	Chrome Brushed Nickel	3 3
	 <ul style="list-style-type: none"> • application: three hole • center dimensions: 8" - 16" center • drain assembly: metal • drain assembly type: lift rod  DURALOCK® DURALAST®	9000 ♦	123.55	1/2" IPS

HOW TO ORDER A COMPLETE BATHROOM FAUCET

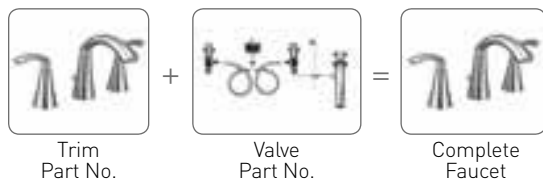

NOTES









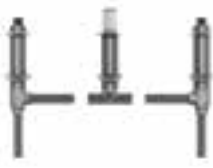

- ♦ Also available in bulk pack. See page 435.
- Ⓜ Moen® **M•PACT®** Common Valve System
- DURALOCK®** Duralock® Quick Connections
- DURALAST®** Duralast® Cartridge

Refer to lavatory waste assemblies on page 403.
 Refer to specification sheet for critical dimensions for installation.



GLYDE™ Roman Tubs

All Brushed Nickel faucet components feature the LifeShine® Non-Tarnish Finish.

	MODEL NUMBER	LIST PRICE	FINISH/ CONNECTION	CASE QTY
TWO-HANDLE ROMAN TUB				
 <ul style="list-style-type: none"> • application: three hole • spout reach: 7.65" • valve: sold separately 	T373	268.80	Chrome	3
	T373BN	402.15	Brushed Nickel	3
 <ul style="list-style-type: none"> • application: three hole • deck thickness: 1/8" to 3-3/8" rough-in deck • center dimensions: adjustable • adjustable spout shank: included • test plug: included 	4792	143.70	1/2" CC	6
 <ul style="list-style-type: none"> • application: three hole • deck thickness: 1/8" to 2-3/4" rough-in deck • center dimensions: 10" - 24" center • adjustable spout shank: included • test plug: included 	4793	162.70	1/2" CPVC, Crimp ring PEX	6
	4794	155.15	1/2" Crimp ring PEX, Cold Expansion PEX	6
 <ul style="list-style-type: none"> • application: three hole • deck thickness: 1/8" to 1-7/8" rough-in deck • center dimensions: 10" center • non-adjustable spout shank: included • test plug: included 	4796	135.35	1/2" CC	6
	4797	138.00	1/2" CPVC, Crimp ring PEX	6
	4798	138.00	1/2" Crimp ring PEX, Cold Expansion PEX	6
 <ul style="list-style-type: none"> • description: high flow thermostatic mixing valve for roman tubs • ports: three • ASSE standard 1070: yes • flow rate: 12.0 gpm (45.4 L/min) max. 	104465	173.00	1/2" CC	12
	104466	173.00	1/2" IPS	12
 <ul style="list-style-type: none"> • description: PEX transition fittings (2) and clips • connections: adapts standard 1/2" PEX barb to 1/2" PEX cold expansion 	140715	10.75	1/2" PEX	200

GLYDE™

HOW TO ORDER A COMPLETE ROMAN TUB FAUCET

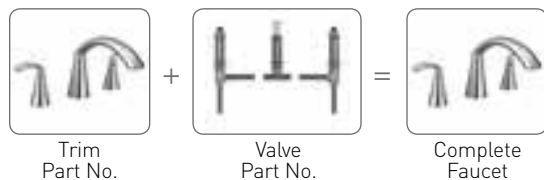





NOTES

 Moen® **M•PACT**® Common Valve System

Thermostatic Mixing Valve service kits, see page 498.

GLYDE™ Transfer Valve Shower Spa Components

All Brushed Nickel faucet components feature the LifeShine® Non-Tarnish Finish.

		MODEL NUMBER	LIST PRICE	FINISH/ CONNECTION	CASE QTY
2/3 FUNCTION TRANSFER VALVE ONLY					
 <ul style="list-style-type: none"> • use with 3372 or 3375 transfer valve • valve: sold separately  		T2721	90.50	Chrome	6
		T2721BN	121.60	Brushed Nickel	6
 	<ul style="list-style-type: none"> • type of function: two independent one shared • must be used with: Posi-Temp® or Moentrol® valve 	3372	172.00	1/2" CC	12
	<ul style="list-style-type: none"> • type of function: two independent functions • must be used with: Posi-Temp® or Moentrol® valve 	3375	172.00	1/2" CC	12

HOW TO ORDER A COMPLETE TRANSFER VALVE

















NOTES

 Moen® **M•PACT®** Common Valve System

GLYDE™ Posi-Temp® Showering

All Brushed Nickel faucet components feature the LifeShine® Non-Tarnish Finish.

		MODEL NUMBER	LIST PRICE	FINISH/ CONNECTION	CASE QTY
POSI-TEMP® TUB/SHOWER					
	<ul style="list-style-type: none"> • showerhead functions: one-function • showerhead type: eco-performance rainshower • showerhead size: 8" diameter spray head • showerhead flow rate: 2.0 transitioning to 1.75 gpm • spout length: 7" • spout connection type: slip fit • tub spout type: diverter • valve: sold separately   	T2843EP	143.90	Chrome	4
		T2843EPBN	241.20	Brushed Nickel	4
	<ul style="list-style-type: none"> • showerhead functions: one-function • showerhead type: standard • showerhead size: 3-3/4" diameter spray head • showerhead flow rate: 2.5 gpm (9.5 L/min) max. • spout length: 7" • spout connection type: slip fit • tub spout type: diverter • valve: sold separately  	T2743 ♦	89.80	Chrome	3
		T2743BN	204.00	Brushed Nickel	3
	<ul style="list-style-type: none"> • showerhead functions: one-function • showerhead type: eco-performance showerhead • showerhead size: 3-3/4" diameter spray head • showerhead flow rate: 1.75 gpm (6.65 L/min) max. • spout length: 7" • spout connection type: slip fit • tub spout type: diverter • valve: sold separately   	T2743EP	89.80	Chrome	3
		T2743EPBN	204.00	Brushed Nickel	3
		2510 ♦	119.75	1/2" IPS	6
		2520 ♦	119.75	1/2" CC	6
		2580 ♦	119.75	1/2" Crimp ring PEX	6
		2570 ♦	145.35	1/2" CC	6
		2590 ♦	145.35	1/2" IPS	6



HOW TO ORDER A COMPLETE TUB/SHOWER FAUCET

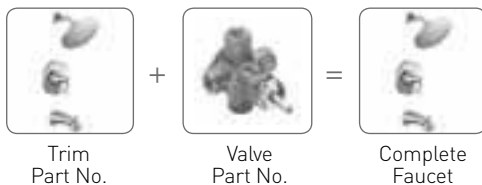















NOTES

- ♦ Also available in bulk pack. See page 435.
- Ⓜ Moen® **M•PACT®** Common Valve System

GLYDE™ Posi-Temp® Showering

All Brushed Nickel faucet components feature the LifeShine® Non-Tarnish Finish.

	MODEL NUMBER	LIST PRICE	FINISH/ CONNECTION	CASE QTY	
POSI-TEMP® SHOWER ONLY					
 <ul style="list-style-type: none"> • showerhead functions: one-function • showerhead type: eco-performance rainshower • showerhead size: 8" diameter spray head • showerhead flow rate: 2.0 transitioning to 1.75 gpm • valve: sold separately   	T2842EP T2842EPBN	111.85 192.90	Chrome Brushed Nickel	4 4	
	 <ul style="list-style-type: none"> • showerhead functions: one-function • showerhead type: standard • showerhead size: 3-3/4" diameter spray head • showerhead flow rate: 2.5 gpm (9.5 L/min) max. • valve: sold separately  	T2742 ♦ T2742BN	59.60 154.65	Chrome Brushed Nickel	3 3
 <ul style="list-style-type: none"> • showerhead functions: one-function • showerhead type: eco-performance showerhead • showerhead size: 3-3/4" diameter spray head • showerhead flow rate: 1.75 gpm (6.65 L/min) max. • valve: sold separately   		T2742EP T2742EPBN	59.60 154.65	Chrome Brushed Nickel	3 3
	 	2510 ♦ 2520 ♦ 2580 ♦	119.75 119.75 119.75	1/2" IPS 1/2" CC 1/2" Crimp ring PEX	6 6 6
 		2570 ♦ 2590 ♦	145.35 145.35	1/2" CC 1/2" IPS	6 6

HOW TO ORDER A COMPLETE SHOWER FAUCET

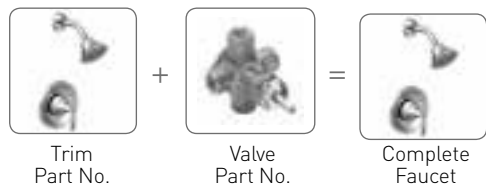







NOTES

- ♦ Also available in bulk pack. See page 435.
- Ⓜ Moen® **M•PACT**® Common Valve System



GLYDE™ Posi-Temp® Showering

All Brushed Nickel faucet components feature the LifeShine® Non-Tarnish Finish.

		MODEL NUMBER	LIST PRICE	FINISH/ CONNECTION	CASE QTY
POSI-TEMP® VALVE ONLY					
 <ul style="list-style-type: none"> valve: sold separately  		T2741	44.35	Chrome	3
		T2741BN	125.15	Brushed Nickel	3
 		2510 ♦	119.75	1/2" IPS	6
		2520 ♦	119.75	1/2" CC	6
		2580 ♦	119.75	1/2" Crimp ring PEX	6
 		2570 ♦	145.35	1/2" CC	6
		2590 ♦	145.35	1/2" IPS	6

GLYDE™

HOW TO ORDER A COMPLETE VALVE



NOTES

- ♦ Also available in bulk pack. See page 435.
- Ⓜ Moen® **M•PACT**® Common Valve System

GLYDE™ Perfectly Matched Bath Accessories

Moen® bath accessories **CANNOT** be combined with Moen® faucet parts on a Purchase Order.

Moen makes it easy to coordinate the entire style and look of the bathroom. Our Glyde™ bath accessories perfectly match the style and finish of our Glyde™ faucets. Total coordination of the bath has never been easier.

For more information on ordering Glyde™ bath accessories or other matching Moen® bath accessories, contact Moen Bath Accessory Customer Service at **800-882-0116**, contact your local Moen sales representative, or visit us at **www.moen.com**.

MODEL NUMBER	LIST PRICE EACH	DESCRIPTION	QTY
Chrome (CH)			
YB2303CH	14.35	Double Robe Hook	24
YB2308CH	24.40	Paper Holder	6
YB2318CH	29.95	18" Towel Bar	6
YB2324CH	31.55	24" Towel Bar	6
YB2386CH	18.65	Towel Ring	6
Brushed Nickel (BN)			
YB2303BN	21.90	Double Robe Hook	24
YB2308BN	37.45	Paper Holder	6
YB2318BN	46.00	18" Towel Bar	6
YB2324BN	48.35	24" Towel Bar	6
YB2386BN	28.40	Towel Ring	6



YB2303
Double Robe Hook



YB2308
Paper Holder



YB2386
Towel Ring



YB2318
18" Towel Bar

















YB2324
24" Towel Bar



YB8081
Pro-Fit® Installation Mounting Template [See page 90 for more information about the Pro-Fit® Installation System.]

VICHY™ Bathroom Faucets, Posi-Temp® Showering

		MODEL NUMBER	LIST PRICE	FINISH/ CONNECTION	CASE QTY
ONE-HANDLE BATHROOM FAUCET					
 <ul style="list-style-type: none"> • application: one hole • center dimensions: 4" center • supply line length: flexible • connection size: 3/8" • connection type: compression • deckplate: sold separately • drain assembly: metal • drain assembly type: lift rod • red/blue markings: included   DURALAST®		6710	211.45	Chrome	3
			172666	16.15	Chrome
POSI-TEMP® TUB/SHOWER					
 <ul style="list-style-type: none"> • showerhead functions: one-function • showerhead type: eco-performance showerhead • showerhead size: 3.75" diameter spray head • showerhead flow rate: 1.75 gpm (6.65 L/min) max. • spout length: 6" • spout connection type: slip fit • tub spout type: diverter • red/blue markings: included • valve: sold separately   		T2663EP	87.85	Chrome	3
 <ul style="list-style-type: none"> • showerhead type: showerhead sold separately • spout length: 6" • spout connection type: slip fit • tub spout type: diverter • red/blue markings: included • valve: sold separately  		T2663NH	75.25	Chrome	3
 		2510 ♦	119.75	1/2" IPS	6
		2520 ♦	119.75	1/2" CC	6
		2580 ♦	119.75	1/2" Crimp ring PEX	6
 		2570 ♦	145.35	1/2" CC	6
		2590 ♦	145.35	1/2" IPS	6

HOW TO ORDER A COMPLETE TUB/SHOWER FAUCET

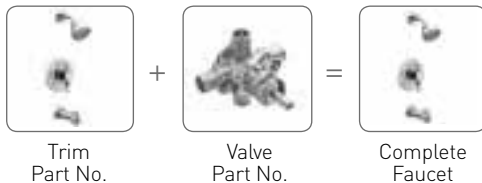















NOTES

- ♦ Also available in bulk pack. See page 435.
 - Ⓜ Moen® **M•PACT®** Common Valve System
- DURALAST®** Duralast® Cartridge

Refer to lavatory waste assemblies on page 403.

VICHY™ Posi-Temp® Showering

		MODEL NUMBER	LIST PRICE	FINISH/ CONNECTION	CASE QTY
POSI-TEMP® SHOWER ONLY					
	<ul style="list-style-type: none"> • showerhead functions: one-function • showerhead type: eco-performance showerhead • showerhead size: 3.75" diameter spray head • showerhead flow rate: 1.75 gpm (6.65 L/min) max. • red/blue markings: included • valve: sold separately 	T2662EP	58.35	Chrome	3
					
	<ul style="list-style-type: none"> • showerhead type: showerhead sold separately • red/blue markings: included • valve: sold separately 	T2662NH	55.50	Chrome	3
					
	<ul style="list-style-type: none"> • description: pressure balanced cycling valve 	2510 ◆	119.75	1/2" IPS	6
	<ul style="list-style-type: none"> • ports: four 	2520 ◆	119.75	1/2" CC	6
	<ul style="list-style-type: none"> • adjustable temp limit stop: included 	2580 ◆	119.75	1/2" Crimp ring PEX	6
					
	<ul style="list-style-type: none"> • description: pressure balanced cycling valve 	2570 ◆	145.35	1/2" CC	6
	<ul style="list-style-type: none"> • ports: four 	2590 ◆	145.35	1/2" IPS	6
	<ul style="list-style-type: none"> • adjustable temp limit stop: included • quarter turn stops: included 				
					
POSI-TEMP® VALVE ONLY					
	<ul style="list-style-type: none"> • red/blue markings: included • valve: sold separately 	T2661	53.65	Chrome	3
					
	<ul style="list-style-type: none"> • description: pressure balanced cycling valve 	2510 ◆	119.75	1/2" IPS	6
	<ul style="list-style-type: none"> • ports: four 	2520 ◆	119.75	1/2" CC	6
	<ul style="list-style-type: none"> • adjustable temp limit stop: included 	2580 ◆	119.75	1/2" Crimp ring PEX	6
					
	<ul style="list-style-type: none"> • description: pressure balanced cycling valve 	2570 ◆	145.35	1/2" CC	6
	<ul style="list-style-type: none"> • ports: four 	2590 ◆	145.35	1/2" IPS	6
	<ul style="list-style-type: none"> • adjustable temp limit stop: included • quarter turn stops: included 				
					

HOW TO ORDER A COMPLETE SHOWER FAUCET















NOTES

- ◆ Also available in bulk pack. See page 435.
- Ⓜ Moen® **M•PACT**® Common Valve System



BRANTFORD® Bathroom Faucets

All Brushed Nickel faucet components feature the LifeShine® Non-Tarnish Finish.

	MODEL NUMBER	LIST PRICE	FINISH/ CONNECTION	CASE QTY
ONE-HANDLE BATHROOM FAUCET				
 <ul style="list-style-type: none"> • application: one or three hole • supply line length: flexible • connection size: 3/8" • connection type: compression • deckplate: included • drain assembly: metal • drain assembly type: lift rod   DURALAST®	6600 ♦	231.55	Chrome	3
	6600BN	302.95	Brushed Nickel	3
	6600ORB	333.25	Oil Rubbed Bronze	3
 <ul style="list-style-type: none"> • description: vessel extension kit • includes: parts to convert to grid drain • includes: two 2.5" extensions 	A1717	135.35	Chrome	6
	A1717BN	193.95	Brushed Nickel	6
	A1717ORB	210.70	Oil Rubbed Bronze	6
TWO-HANDLE CENTERSET BATHROOM FAUCET				
 <ul style="list-style-type: none"> • application: three hole • center dimensions: 4" center • connection size: 1/2" • connection type: IPS • drain assembly: metal • drain assembly type: lift rod   DURALAST®	6610 ♦	166.70	Chrome	6
	6610BN	226.45	Brushed Nickel	6
	6610ORB	249.10	Oil Rubbed Bronze	6
TWO-HANDLE WIDESPREAD BATHROOM FAUCET				
 <ul style="list-style-type: none"> • application: three hole • center dimensions: 8" - 16" center • drain assembly: metal • drain assembly type: lift rod • valve: sold separately   	T6620	164.70	Chrome	3
	T6620BN	246.90	Brushed Nickel	3
	T6620ORB	271.50	Oil Rubbed Bronze	3
 <ul style="list-style-type: none"> • application: three hole • center dimensions: 8" - 16" center • drain assembly: metal • drain assembly type: lift rod  DURALOCK® DURALAST®	9000 ♦	123.55	1/2" IPS	6

BRANTFORD®

HOW TO ORDER A COMPLETE BATHROOM FAUCET

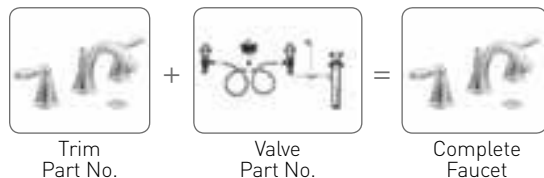











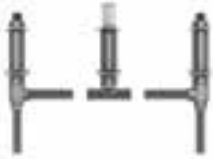

NOTES

- ♦ Also available in bulk pack. See page 435.
- Ⓜ Moen® **M•PACT®** Common Valve System
- DURALAST® Duralock® Quick Connections
- DURALAST® Duralast® Cartridge

Refer to lavatory waste assemblies on page 403.
Refer to specification sheet for critical dimensions for installation.

BRANTFORD® Roman Tubs

All Brushed Nickel faucet components feature the LifeShine® Non-Tarnish Finish.

	MODEL NUMBER	LIST PRICE	FINISH/ CONNECTION	CASE QTY
TWO-HANDLE ROMAN TUB				
 <ul style="list-style-type: none"> • for garden tub application • application: three hole • spout reach: 6.50" • valve: sold separately 	T4943	202.85	Chrome	3
	T4943BN	264.75	Brushed Nickel	3
	T4943ORB	291.15	Oil Rubbed Bronze	3
 <ul style="list-style-type: none"> • application: three hole • spout reach: 8.13" • valve: sold separately 	T933	268.80	Chrome	3
	T933BN	402.15	Brushed Nickel	3
	T933ORB	442.45	Oil Rubbed Bronze	3
 <ul style="list-style-type: none"> • application: three hole • deck thickness: 1/8" to 3-3/8" rough-in deck • center dimensions: adjustable • adjustable spout shank: included • test plug: included 	4792	143.70	1/2" CC	6
 <ul style="list-style-type: none"> • application: three hole • deck thickness: 1/8" to 2-3/4" rough-in deck • center dimensions: 10" - 24" center • adjustable spout shank: included • test plug: included 	4793	162.70	1/2" CPVC, Crimp ring PEX	6
	4794	155.15	1/2" Crimp ring PEX, Cold Expansion PEX	6
 <ul style="list-style-type: none"> • application: three hole • deck thickness: 1/8" to 1-7/8" rough-in deck • center dimensions: 10" center • non-adjustable spout shank: included • test plug: included 	4796	135.35	1/2" CC	6
	4797	138.00	1/2" CPVC, Crimp ring PEX	6
	4798	138.00	1/2" Crimp ring PEX, Cold Expansion PEX	6
 <ul style="list-style-type: none"> • description: high flow thermostatic mixing valve for roman tubs • ports: three • ASSE standard 1070: yes • flow rate: 12.0 gpm (45.4 L/min) max. 	104465	173.00	1/2" CC	12
	104466	173.00	1/2" IPS	12
 <ul style="list-style-type: none"> • description: PEX transition fittings (2) and clips • connections: adapts standard 1/2" PEX barb to 1/2" PEX cold expansion 	140715	10.75	1/2" PEX	200

HOW TO ORDER A COMPLETE ROMAN TUB FAUCET

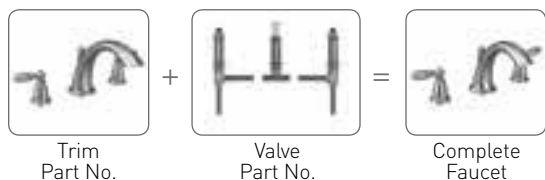









NOTES

 Moen® **M•PACT**® Common Valve System

Thermostatic Mixing Valve service kits, see page 498.

BRANTFORD® Roman Tubs

All Brushed Nickel faucet components feature the LifeShine® Non-Tarnish Finish.

	MODEL NUMBER	LIST PRICE	FINISH/ CONNECTION	CASE QTY
TWO-HANDLE ROMAN TUB WITH HANDSHOWER				
 <ul style="list-style-type: none"> • application: four hole • showerhead type: handshower • handshower flow rate: 2.0 transitioning to 1.75 gpm • spray functions: one-function • spout reach: 8.13" • valve: sold separately 	T924	422.05	Chrome	3
	T924BN	534.65	Brushed Nickel	3
	T924ORB	588.15	Oil Rubbed Bronze	3
 <ul style="list-style-type: none"> • application: four hole • deck thickness: 1/8" to 2-5/8" rough-in deck • center dimensions: adjustable • non-adjustable spout shank: included • test plug: included 	9792	323.75	1/2" CC	6
 <ul style="list-style-type: none"> • application: four hole • deck thickness: 1/8" to 2-5/8" rough-in deck • center dimensions: 10" - 24" center • non-adjustable spout shank: included • test plug: included 	9793	331.35	1/2" CPVC, Crimp ring PEX	6
 <ul style="list-style-type: none"> • description: high flow thermostatic mixing valve for roman tubs • ports: three • ASSE standard 1070: yes • flow rate: 12.0 gpm (45.4 L/min) max. 	104465 104466	173.00 173.00	1/2" CC 1/2" IPS	12 12
 <ul style="list-style-type: none"> • description: PEX transition fittings (2) and clips • connections: adapts standard 1/2" PEX barb to 1/2" PEX cold expansion 	140715	10.75	1/2" PEX	200



HOW TO ORDER A COMPLETE ROMAN TUB FAUCET

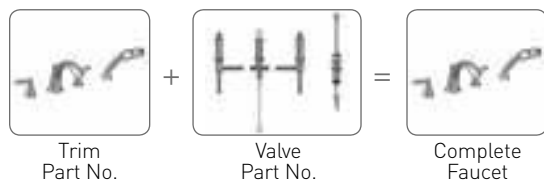







NOTES

 Moen® **M•PACT**® Common Valve System

Thermostatic Mixing Valve service kits, see page 498.

BRANTFORD® Posi-Temp® Showering/Transfer Valve Trim

All Brushed Nickel faucet components feature the LifeShine® Non-Tarnish Finish.

	MODEL NUMBER	LIST PRICE	FINISH/ CONNECTION	CASE QTY
2/3 FUNCTION TRANSFER VALVE ONLY				
 <ul style="list-style-type: none"> • use with 3372 or 3375 transfer valve • valve: sold separately  	T2021	90.50	Chrome	12
	T2021BN	121.60	Brushed Nickel	12
	T2021ORB	133.80	Oil Rubbed Bronze	12
  <ul style="list-style-type: none"> • type of function: two independent one shared • must be used with: Posi-Temp® or Moentrol® valve 	3372	172.00	1/2" CC	12
	  <ul style="list-style-type: none"> • type of function: two independent functions • must be used with: Posi-Temp® or Moentrol® valve 	3375	172.00	1/2" CC

HOW TO ORDER A COMPLETE TRANSFER VALVE

























NOTES

 Moen® **M•PACT**® Common Valve System



BRANTFORD® Posi-Temp® Showering

All Brushed Nickel faucet components feature the LifeShine® Non-Tarnish Finish.

		MODEL NUMBER	LIST PRICE	FINISH/ CONNECTION	CASE QTY
POSI-TEMP® TUB/SHOWER					
	<ul style="list-style-type: none"> • showerhead functions: one-function • showerhead type: eco-performance rainshower • showerhead size: 8" diameter spray head • showerhead flow rate: 2.0 transitioning to 1.75 gpm • spout length: 6-1/2" • spout connection type: slip fit • tub spout type: diverter • valve: sold separately 	T2253EP	143.90	Chrome	4
		T2253EPBN	241.20	Brushed Nickel	4
		T2253EPORB	261.15	Oil Rubbed Bronze	4
		  			
	<ul style="list-style-type: none"> • showerhead functions: one-function • showerhead type: standard • showerhead size: 3-1/2" diameter spray head • showerhead flow rate: 2.5 gpm (9.5 L/min) max. • spout length: 6-1/2" • spout connection type: slip fit • tub spout type: diverter • valve: sold separately 	T2153 ♦	104.65	Chrome	3
		T2153BN	204.00	Brushed Nickel	3
		T2153ORB	224.40	Oil Rubbed Bronze	3
		 			
	<ul style="list-style-type: none"> • showerhead functions: one-function • showerhead type: standard • showerhead size: 3-1/2" diameter spray head • showerhead flow rate: 1.75 gpm (6.65 L/min) max. • spout length: 6-1/2" • spout connection type: slip fit • tub spout type: diverter • used to replace: 2 or 3 hole shower valve • valve: sold separately 	T2157EP	128.35	Chrome	3
		T2157EPBN	236.00	Brushed Nickel	3
		T2157EPORB	261.15	Oil Rubbed Bronze	3
		  			
	<ul style="list-style-type: none"> • showerhead functions: one-function • showerhead type: eco-performance showerhead • showerhead size: 3-1/2" diameter spray head • showerhead flow rate: 1.75 gpm (6.65 L/min) max. • spout length: 6-1/2" • spout connection type: slip fit • tub spout type: diverter • valve: sold separately 	T62153EP ♦♦	89.80	Chrome	12
		T2153EPBN	204.00	Brushed Nickel	3
		T2153EPORB	224.40	Oil Rubbed Bronze	3
		  			
	<ul style="list-style-type: none"> • showerhead type: showerhead sold separately • spout length: 6-1/2" • spout connection type: slip fit • tub spout type: diverter • chrome sold in case qty only: no single pack • valve: sold separately 	T62153NH ♦♦	76.90	Chrome	12
		T2153NHBN	156.25	Brushed Nickel	3
		T2153NHORB	167.20	Oil Rubbed Bronze	3
		 			
	<ul style="list-style-type: none"> • description: pressure balanced cycling valve • ports: four • adjustable temp limit stop: included 	2510 ♦	119.75	1/2" IPS	6
		2520 ♦	119.75	1/2" CC	6
		2580 ♦	119.75	1/2" Crimp ring PEX	6
					
	<ul style="list-style-type: none"> • description: pressure balanced cycling valve • ports: four • adjustable temp limit stop: included • quarter turn stops: included 	2570 ♦	145.35	1/2" CC	6
		2590 ♦	145.35	1/2" IPS	6
					

BRANTFORD®

HOW TO ORDER A COMPLETE TUB/SHOWER FAUCET

























NOTES

- ♦ Also available in bulk pack. See page 435.
- ♦♦ Available in bulk pack only. See page 435.
-  Moen® **M•PACT**® Common Valve System

BRANTFORD® Posi-Temp® Showering

All Brushed Nickel faucet components feature the LifeShine® Non-Tarnish Finish.

	MODEL NUMBER	LIST PRICE	FINISH/ CONNECTION	CASE QTY
POSI-TEMP® SHOWER ONLY				
 <ul style="list-style-type: none"> • showerhead functions: one-function • showerhead type: eco-performance rainshower • showerhead size: 8" diameter spray head • showerhead flow rate: 2.0 transitioning to 1.75 gpm • valve: sold separately 	T2252EP	111.85	Chrome	4
	T2252EPBN	192.90	Brushed Nickel	4
	T2252EPORB	207.95	Oil Rubbed Bronze	4
   				
 <ul style="list-style-type: none"> • showerhead functions: one-function • showerhead type: standard • showerhead size: 3-1/2" diameter spray head • showerhead flow rate: 2.5 gpm (9.5 L/min) max. • valve: sold separately 	T2152	71.85	Chrome	3
	T2152BN	154.65	Brushed Nickel	3
	T2152ORB	170.10	Oil Rubbed Bronze	3
  				
 <ul style="list-style-type: none"> • showerhead functions: one-function • showerhead type: eco-performance showerhead • showerhead size: 3-1/2" diameter spray head • showerhead flow rate: 1.75 gpm (6.65 L/min) max. • chrome sold in case qty only: no single pack • valve: sold separately 	T62152EP ♦♦	59.60	Chrome	12
	T2152EPBN	154.65	Brushed Nickel	3
	T2152EPORB	170.10	Oil Rubbed Bronze	3
   				
 <ul style="list-style-type: none"> • showerhead type: showerhead sold separately • chrome sold in case qty only: no single pack • valve: sold separately 	T62152NH ♦♦	56.65	Chrome	12
	T2152NHBN	132.60	Brushed Nickel	3
	T2152NHORB	145.85	Oil Rubbed Bronze	3
  				
 <ul style="list-style-type: none"> • description: pressure balanced cycling valve • ports: four • adjustable temp limit stop: included 	2510 ♦	119.75	1/2" IPS	6
	2520 ♦	119.75	1/2" CC	6
	2580 ♦	119.75	1/2" Crimp ring PEX	6
				
 <ul style="list-style-type: none"> • description: pressure balanced cycling valve • ports: four • adjustable temp limit stop: included • quarter turn stops: included 	2570 ♦	145.35	1/2" CC	6
	2590 ♦	145.35	1/2" IPS	6
				

HOW TO ORDER A COMPLETE SHOWER FAUCET















NOTES

- ♦ Also available in bulk pack. See page 435.
- ♦♦ Available in bulk pack only. See page 435.
- Ⓜ Moen® **M•PACT**® Common Valve System

BRANTFORD® Posi-Temp® Showering, Bidets

All Brushed Nickel faucet components feature the LifeShine® Non-Tarnish Finish.

		MODEL NUMBER	LIST PRICE	FINISH/ CONNECTION	CASE QTY
POSI-TEMP® VALVE ONLY					
 <ul style="list-style-type: none"> valve: sold separately  		T2151 ♦	54.80	Chrome	3
		T2151BN	125.15	Brushed Nickel	3
		T2151ORB	137.65	Oil Rubbed Bronze	3
  <ul style="list-style-type: none"> description: pressure balanced cycling valve ports: four adjustable temp limit stop: included 		2510 ♦	119.75	1/2" IPS	6
		2520 ♦	119.75	1/2" CC	6
		2580 ♦	119.75	1/2" Crimp ring PEX	6
  <ul style="list-style-type: none"> description: pressure balanced cycling valve ports: four adjustable temp limit stop: included quarter turn stops: included 		2570 ♦	145.35	1/2" CC	6
		2590 ♦	145.35	1/2" IPS	6
TWO-HANDLE BIDET					
   <ul style="list-style-type: none"> center dimensions: 8" - 16" center valve: sold separately 		T5225	366.95	Chrome	3
		T5225BN	443.10	Brushed Nickel	3
		T5225ORB	487.40	Oil Rubbed Bronze	3
  <ul style="list-style-type: none"> application: three hole center dimensions: 8" - 16" center 		9265	254.45	1/2" IPS	6
					

BRANTFORD®

HOW TO ORDER A COMPLETE VALVE



HOW TO ORDER A COMPLETE BIDET FAUCET

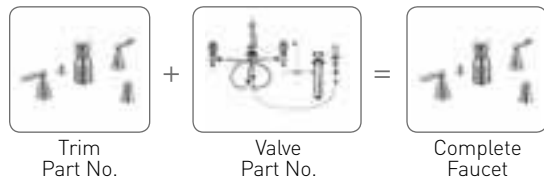

NOTES

- ♦ Also available in bulk pack. See page 435.
- Ⓜ Moen® **M•PACT**® Common Valve System
- DURALOCK: Duralock® Quick Connections
- DURALAST: Duralast® Cartridge



See page 90 for details.

BRANTFORD® Perfectly Matched Bath Accessories

Moen® bath accessories CANNOT be combined with Moen® faucet parts on a Purchase Order.

Moen makes it easy to coordinate the entire style and look of the bathroom. Our Brantford® bath accessories perfectly match the style and finish of our Brantford® faucets. Total coordination of the bath has never been easier.

For more information on ordering Brantford® bath accessories or other matching Moen® bath accessories, contact Moen Bath Accessory Customer Service at **800-882-0116**, contact your local Moen sales representative, or visit us at **www.moen.com**.

MODEL NUMBER	LIST PRICE EACH	DESCRIPTION	QTY
5/8-in. Round Bar			
Chrome (CH)			
YB2201CH	19.20	Tank Lever	6
YB2203CH	13.65	Double Robe Hook	24
YB2208CH	24.40	Paper Holder	6
YB2218CH	29.95	18" Towel Bar	6
YB2224CH	31.55	24" Towel Bar	6
YB2286CH	18.65	Towel Ring	6
Brushed Nickel (BN)			
YB2201BN	29.45	Tank Lever	6
YB2203BN	20.80	Double Robe Hook	24
YB2208BN	37.45	Paper Holder	6
YB2218BN	46.00	18" Towel Bar	6
YB2224BN	48.35	24" Towel Bar	6
YB2286BN	28.40	Towel Ring	6
Oil Rubbed Bronze (ORB)			
YB2201ORB	32.35	Tank Lever	6
YB2203ORB	22.90	Double Robe Hook	24
YB2208ORB	41.15	Paper Holder	6
YB2218ORB	50.60	18" Towel Bar	6
YB2224ORB	53.20	24" Towel Bar	6
YB2286ORB	31.35	Towel Ring	6



YB2201 Tank Lever

YB2203 Double Robe Hook



YB2208 Paper Holder

YB2218 18" Towel Bar



YB2224 24" Towel Bar

YB2286 Towel Ring

GRAB BARS

PERFECTLY MATCHED to Moen® Brantford® faucets and bath accessories. ADA-compliant.



SecureMount™ Grab Bars are manufactured with an innovative flange design that makes it easy to connect to the stud at multiple points.

To install grab bars securely without studs, use SecureMount™ Anchors. Sold separately.

MODEL NUMBER	LIST PRICE EACH	DESCRIPTION	QTY
1-1/4" • Chrome (CH)			
YG2212CH	80.50	12" Designer Grab Bar	6
YG2218CH	85.10	18" Designer Grab Bar	6
YG2224CH	89.10	24" Designer Grab Bar	6
1-1/4" • Brushed Nickel (BN)			
YG2212BN	98.20	12" Designer Grab Bar	6
YG2218BN	103.15	18" Designer Grab Bar	6
YG2224BN	111.70	24" Designer Grab Bar	6
1-1/4" • Oil Rubbed Bronze (ORB)			
YG2212ORB	107.30	12" Designer Grab Bar	6
YG2218ORB	112.85	18" Designer Grab Bar	6
YG2224ORB	124.50	24" Designer Grab Bar	6



YG2224 24" length Designer Grab Bar



YB8081 Pro-Fit® Installation Mounting Template (See page 90 for more information about the Pro-Fit® Installation System.)



Complies with Americans with Disabilities Act (ADA) specifications. SecureMount™ Grab Bars are tested to withstand 500 lb. pull when securely installed per instructions.

List price is per each (unless otherwise noted). Product can be ordered by case quantity or individually.

BRANTFORD®



LIGHTING

MODEL NUMBER	LIST PRICE EACH	DESCRIPTION	QTY
Chrome (CH)			
YB2261CH	108.10	One Globe Bath Light	2
YB2262CH	151.30	Two Globe Bath Light	2
YB2263CH	187.90	Three Globe Bath Light	2
YB2264CH	240.65	Four Globe Bath Light	2
Brushed Nickel (BN)			
YB2261BN	135.10	One Globe Bath Light	2
YB2262BN	189.20	Two Globe Bath Light	2
YB2263BN	234.90	Three Globe Bath Light	2
YB2264BN	300.75	Four Globe Bath Light	2
Oil Rubbed Bronze (ORB)			
YB2261ORB	135.10	One Globe Bath Light	2
YB2262ORB	189.20	Two Globe Bath Light	2
YB2263ORB	234.90	Three Globe Bath Light	2
YB2264ORB	300.75	Four Globe Bath Light	2
Replacement Globe			
YB2269	20.20	Replacement Globe	3



YB2261
One Globe Light

YB2262
Two Globe Light



YB2263
Three Globe Light



YB2264
Four Globe Light

YB2269
Replacement Globe

BRANTFORD®















Bulbs not included.

All Brantford® lighting fixtures can be mounted with globes either facing upward or downward.
List price is per each (unless otherwise noted). Product can be ordered by case quantity or individually.

EVA® Bathroom Faucets

All Brushed Nickel faucet components feature the LifeShine® Non-Tarnish Finish.

	MODEL NUMBER	LIST PRICE	FINISH/ CONNECTION	CASE QTY
ONE-HANDLE BATHROOM FAUCET				
 <ul style="list-style-type: none"> • application: one or three hole • supply line length: flexible • connection size: 3/8" • connection type: compression • deckplate: included • drain assembly: metal • drain assembly type: lift rod   DURALAST®	6400	231.55	Chrome	3
	6400BN	302.95	Brushed Nickel	3
	6400ORB	333.25	Oil Rubbed Bronze	3
 <ul style="list-style-type: none"> • description: vessel extension kit • includes: parts to convert to grid drain • includes: two 2.5" extensions 	A1717	135.35	Chrome	6
	A1717BN	193.95	Brushed Nickel	6
	A1717ORB	210.70	Oil Rubbed Bronze	6
TWO-HANDLE CENTERSET BATHROOM FAUCET				
 <ul style="list-style-type: none"> • application: three hole • center dimensions: 4" center • connection size: 1/2" • connection type: IPS • drain assembly: metal • drain assembly type: lift rod   DURALAST®	6410 ♦	166.70	Chrome	6
	6410BN	226.45	Brushed Nickel	6
	6410ORB	249.10	Oil Rubbed Bronze	6
TWO-HANDLE WIDESPREAD BATHROOM FAUCET				
 <ul style="list-style-type: none"> • application: three hole • center dimensions: 8" - 16" center • drain assembly: metal • drain assembly type: lift rod • valve: sold separately   	T6420	164.70	Chrome	3
	T6420BN	246.90	Brushed Nickel	3
	T6420ORB	271.50	Oil Rubbed Bronze	3
 <ul style="list-style-type: none"> • application: three hole • center dimensions: 8" - 16" center • drain assembly: metal • drain assembly type: lift rod  DURALOCK® DURALAST®	9000 ♦	123.55	1/2" IPS	6

HOW TO ORDER A COMPLETE BATHROOM FAUCET

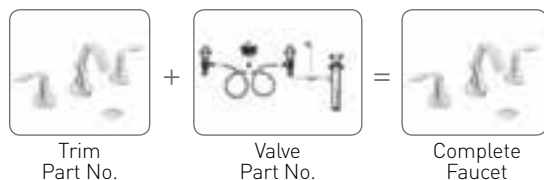

NOTES









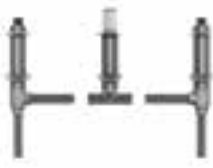

- ♦ Also available in bulk pack. See page 435.
- Ⓜ Moen® **M•PACT®** Common Valve System
- DURALAST®** Duralock® Quick Connections
- DURALAST®** Duralast® Cartridge

Refer to lavatory waste assemblies on page 403.
Refer to specification sheet for critical dimensions for installation.



EVA® Roman Tub

All Brushed Nickel faucet components feature the LifeShine® Non-Tarnish Finish.

	MODEL NUMBER	LIST PRICE	FINISH/ CONNECTION	CASE QTY
TWO-HANDLE ROMAN TUB				
 <ul style="list-style-type: none"> • application: three hole • spout reach: 7.67" • valve: sold separately 	T943	268.80	Chrome	3
	T943BN	402.15	Brushed Nickel	3
	T943ORB	442.45	Oil Rubbed Bronze	3
 <ul style="list-style-type: none"> • application: three hole • deck thickness: 1/8" to 3-3/8" rough-in deck • center dimensions: adjustable • adjustable spout shank: included • test plug: included 	4792	143.70	1/2" CC	6
 <ul style="list-style-type: none"> • application: three hole • deck thickness: 1/8" to 2-3/4" rough-in deck • center dimensions: 10" - 24" center • adjustable spout shank: included • test plug: included 	4793	162.70	1/2" CPVC, Crimp ring PEX	6
	4794	155.15	1/2" Crimp ring PEX, Cold Expansion PEX	6
 <ul style="list-style-type: none"> • application: three hole • deck thickness: 1/8" to 1-7/8" rough-in deck • center dimensions: 10" center • non-adjustable spout shank: included • test plug: included 	4796	135.35	1/2" CC	6
	4797	138.00	1/2" CPVC, Crimp ring PEX	6
	4798	138.00	1/2" Crimp ring PEX, Cold Expansion PEX	6
 <ul style="list-style-type: none"> • description: high flow thermostatic mixing valve for roman tubs • ports: three • ASSE standard 1070: yes • flow rate: 12.0 gpm (45.4 L/min) max. 	104465	173.00	1/2" CC	12
	104466	173.00	1/2" IPS	12
 <ul style="list-style-type: none"> • description: PEX transition fittings (2) and clips • connections: adapts standard 1/2" PEX barb to 1/2" PEX cold expansion 	140715	10.75	1/2" PEX	200



HOW TO ORDER A COMPLETE ROMAN TUB FAUCET

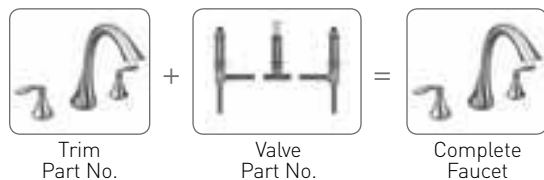









NOTES

 Moen® **M•PACT**® Common Valve System

Thermostatic Mixing Valve service kits, see page 498.

All Brushed Nickel faucet components feature the LifeShine® Non-Tarnish Finish.

	MODEL NUMBER	LIST PRICE	FINISH/ CONNECTION	CASE QTY
TWO-HANDLE ROMAN TUB WITH HANDSHOWER				
 <ul style="list-style-type: none"> • application: four hole • showerhead type: handshower • handshower flow rate: 2.0 transitioning to 1.75 gpm • spray functions: one-function • spout reach: 7.67" • valve: sold separately 	T944	422.05	Chrome	3
	T944BN	534.65	Brushed Nickel	3
	T944ORB	588.15	Oil Rubbed Bronze	3
 <ul style="list-style-type: none"> • application: four hole • deck thickness: 1/8" to 2-5/8" rough-in deck • center dimensions: adjustable • non-adjustable spout shank: included • test plug: included 	9792	323.75	1/2" CC	6
 <ul style="list-style-type: none"> • application: four hole • deck thickness: 1/8" to 2-5/8" rough-in deck • center dimensions: 10" - 24" center • non-adjustable spout shank: included • test plug: included 	9793	331.35	1/2" CPVC, Crimp ring PEX	6
 <ul style="list-style-type: none"> • description: high flow thermostatic mixing valve for roman tubs • ports: three • ASSE standard 1070: yes • flow rate: 12.0 gpm (45.4 L/min) max. 	104465	173.00	1/2" CC	12
	104466	173.00	1/2" IPS	12
 <ul style="list-style-type: none"> • description: PEX transition fittings (2) and clips • connections: adapts standard 1/2" PEX barb to 1/2" PEX cold expansion 	140715	10.75	1/2" PEX	200

HOW TO ORDER A COMPLETE ROMAN TUB FAUCET

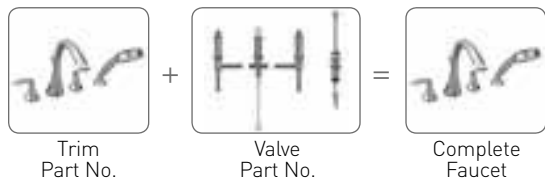







NOTES

 Moen® **M•PACT®** Common Valve System

Thermostatic Mixing Valve service kits, see page 498.

EVA® Transfer Valve Shower Spa Components

All Brushed Nickel faucet components feature the LifeShine® Non-Tarnish Finish.

		MODEL NUMBER	LIST PRICE	FINISH/ CONNECTION	CASE QTY
2/3 FUNCTION TRANSFER VALVE ONLY					
 <ul style="list-style-type: none"> • use with 3372 or 3375 transfer valve • valve: sold separately  		T2011	90.50	Chrome	12
		T2011BN	121.60	Brushed Nickel	12
		T2011ORB	133.80	Oil Rubbed Bronze	12
  <ul style="list-style-type: none"> • type of function: two independent one shared • must be used with: Posi-Temp® or Moentrol® valve 		3372	172.00	1/2" CC	12
	  <ul style="list-style-type: none"> • type of function: two independent functions • must be used with: Posi-Temp® or Moentrol® valve 		3375	172.00	1/2" CC

HOW TO ORDER A COMPLETE TRANSFER VALVE

























NOTES

 Moen® **M•PACT®** Common Valve System

Refer to specification sheet for critical dimensions for installation.

EVA® Posi-Temp® Showering

All Brushed Nickel faucet components feature the LifeShine® Non-Tarnish Finish.

		MODEL NUMBER	LIST PRICE	FINISH/ CONNECTION	CASE QTY
POSI-TEMP® TUB/SHOWER					
	<ul style="list-style-type: none"> • showerhead functions: one-function • showerhead type: standard • showerhead size: 8" diameter spray head • showerhead flow rate: 2.0 transitioning to 1.75 gpm • spout length: 7" • spout connection type: slip fit • tub spout type: diverter • valve: sold separately 	T2233EP	143.90	Chrome	4
		T2233EPBN	241.20	Brushed Nickel	4
		T2233EPORB	261.15	Oil Rubbed Bronze	4
		  			
	<ul style="list-style-type: none"> • showerhead functions: one-function • showerhead type: standard • showerhead size: 3-1/2" diameter spray head • showerhead flow rate: 2.5 gpm (9.5 L/min) max. • spout length: 7" • spout connection type: slip fit • tub spout type: diverter • valve: sold separately 	T2133 ♦	104.65	Chrome	3
		T2133BN	204.00	Brushed Nickel	3
		T2133ORB	224.40	Oil Rubbed Bronze	3
		 			
	<ul style="list-style-type: none"> • showerhead functions: one-function • showerhead type: standard • showerhead size: 3-1/2" diameter spray head • showerhead flow rate: 1.75 gpm (6.65 L/min) max. • spout length: 7" • spout connection type: slip fit • tub spout type: diverter • used to replace: 2 or 3 hole shower valve • valve: sold separately 	T2137EP	128.35	Chrome	3
		T2137EPBN	236.00	Brushed Nickel	3
		T2137EPORB	261.15	Oil Rubbed Bronze	3
		  			
	<ul style="list-style-type: none"> • showerhead functions: one-function • showerhead type: eco-performance showerhead • showerhead size: 3-1/2" diameter spray head • showerhead flow rate: 1.75 gpm (6.65 L/min) max. • spout length: 7" • spout connection type: slip fit • tub spout type: diverter • chrome sold in case qty only: no single pack • valve: sold separately 	T62133EP ♦♦	89.80	Chrome	12
		T2133EPBN	204.00	Brushed Nickel	3
		T2133EPORB	224.40	Oil Rubbed Bronze	3
		  			
	<ul style="list-style-type: none"> • showerhead type: showerhead sold separately • spout length: 7" • spout connection type: slip fit • tub spout type: diverter • chrome sold in case qty only: no single pack • valve: sold separately 	T62133NH ♦♦	76.90	Chrome	12
		T2133NHBN	156.25	Brushed Nickel	3
		T2133NHORB	167.20	Oil Rubbed Bronze	3
		 			
	<ul style="list-style-type: none"> • description: pressure balanced cycling valve • ports: four • adjustable temp limit stop: included 	2510 ♦	119.75	1/2" IPS	6
		2520 ♦	119.75	1/2" CC	6
		2580 ♦	119.75	1/2" Crimp ring PEX	6
					
	<ul style="list-style-type: none"> • description: pressure balanced cycling valve • ports: four • adjustable temp limit stop: included • quarter turn stops: included 	2570 ♦	145.35	1/2" CC	6
		2590 ♦	145.35	1/2" IPS	6
					

HOW TO ORDER A COMPLETE TUB/SHOWER FAUCET





















NOTES

- ♦ Also available in bulk pack. See page 435.
- ♦♦ Available in bulk pack only. See page 435.
-  Moen® **M•PACT**® Common Valve System

EVA® Posi-Temp® Showering

All Brushed Nickel faucet components feature the LifeShine® Non-Tarnish Finish.

		MODEL NUMBER	LIST PRICE	FINISH/ CONNECTION	CASE QTY
POSI-TEMP® SHOWER ONLY					
	<ul style="list-style-type: none"> • showerhead functions: one-function • showerhead type: rainshower • showerhead size: 8" diameter spray head • showerhead flow rate: 2.0 transitioning to 1.75 gpm • valve: sold separately 	T2232EP	111.85	Chrome	4
		T2232EPBN	192.90	Brushed Nickel	4
		T2232EPORB	207.95	Oil Rubbed Bronze	4
	  				
	<ul style="list-style-type: none"> • showerhead functions: one-function • showerhead type: standard • showerhead size: 3-1/2" diameter spray head • showerhead flow rate: 2.5 gpm (9.5 L/min) max. • valve: sold separately 	T2132 ♦	71.85	Chrome	3
		T2132BN	154.65	Brushed Nickel	3
		T2132ORB	170.10	Oil Rubbed Bronze	3
	 				
	<ul style="list-style-type: none"> • showerhead functions: one-function • showerhead type: eco-performance showerhead • showerhead size: 3-1/2" diameter spray head • showerhead flow rate: 1.75 gpm (6.65 L/min) max. • chrome sold in case qty only: no single pack • valve: sold separately 	T62132EP ♦♦	59.60	Chrome	12
		T2132EPBN	154.65	Brushed Nickel	3
		T2132EPORB	170.10	Oil Rubbed Bronze	3
	  				
	<ul style="list-style-type: none"> • showerhead type: showerhead sold separately • chrome sold in case qty only: no single pack • valve: sold separately 	T62132NH ♦♦	56.65	Chrome	12
		T2132NHBN	132.60	Brushed Nickel	3
		T2132NHORB	145.85	Oil Rubbed Bronze	3
	 				
	<ul style="list-style-type: none"> • description: pressure balanced cycling valve • ports: four • adjustable temp limit stop: included 	2510 ♦	119.75	1/2" IPS	6
		2520 ♦	119.75	1/2" CC	6
		2580 ♦	119.75	1/2" Crimp ring PEX	6
					
	<ul style="list-style-type: none"> • description: pressure balanced cycling valve • ports: four • adjustable temp limit stop: included • quarter turn stops: included 	2570 ♦	145.35	1/2" CC	6
		2590 ♦	145.35	1/2" IPS	6
					

EVA®

HOW TO ORDER A COMPLETE SHOWER FAUCET















NOTES

- ♦ Also available in bulk pack. See page 435.
- ♦♦ Available in bulk pack only. See page 435.
- Ⓜ Moen® **M•PACT**® Common Valve System

EVA® Posi-Temp® Showering, Bidets

All Brushed Nickel faucet components feature the LifeShine® Non-Tarnish Finish.

		MODEL NUMBER	LIST PRICE	FINISH/ CONNECTION	CASE QTY
POSI-TEMP® VALVE ONLY					
 <ul style="list-style-type: none"> valve: sold separately  		T2131 ♦	54.80	Chrome	3
		T2131BN	125.15	Brushed Nickel	3
		T2131ORB	137.65	Oil Rubbed Bronze	3
 <ul style="list-style-type: none"> description: pressure balanced cycling valve ports: four adjustable temp limit stop: included 		2510 ♦	119.75	1/2" IPS	6
		2520 ♦	119.75	1/2" CC	6
		2580 ♦	119.75	1/2" Crimp ring PEX	6
 <ul style="list-style-type: none"> description: pressure balanced cycling valve ports: four adjustable temp limit stop: included quarter turn stops: included 		2570 ♦	145.35	1/2" CC	6
		2590 ♦	145.35	1/2" IPS	6
TWO-HANDLE BIDET					
 <ul style="list-style-type: none"> center dimensions: 8" - 16" center valve: sold separately  		T5220	366.95	Chrome	3
		T5220BN	443.10	Brushed Nickel	3
		T5220ORB	487.40	Oil Rubbed Bronze	3
 <ul style="list-style-type: none"> application: three hole center dimensions: 8" - 16" center 		9265	254.45	1/2" IPS	6
					

HOW TO ORDER A COMPLETE VALVE



HOW TO ORDER A COMPLETE BIDET FAUCET

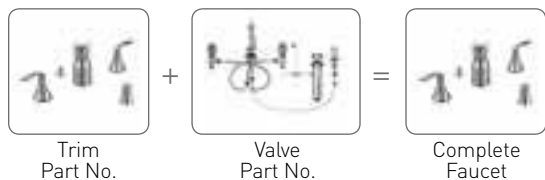

NOTES

- ♦ Also available in bulk pack. See page 435.
- Ⓜ Moen® **M•PACT**® Common Valve System
- DURALAST® Duralock® Quick Connections
- DURALAST® Duralast® Cartridge



EVA® Perfectly Matched Bath Accessories

Moen® bath accessories CANNOT be combined with Moen® faucet parts on a Purchase Order

Moen makes it easy to coordinate the entire style and look of the bathroom. Our Eva® bath accessories perfectly match the style and finish of our Eva® faucets. Total coordination of the bath has never been easier.

For more information on ordering Eva® bath accessories or other matching Moen® bath accessories, contact Moen Bath Accessory Customer Service at **800-882-0116**, contact your local Moen sales representative, or visit us at **www.moen.com**.

MODEL NUMBER	LIST PRICE EACH	DESCRIPTION	QTY
<i>3/4-in. Elliptical Bar</i>			
Chrome (CH)			
YB2801CH	19.20	Tank Lever	6
YB2803CH	13.65	Single Robe Hook	24
YB2808CH	24.40	Paper Holder	6
YB2818CH	29.95	18" Towel Bar	6
YB2824CH	31.55	24" Towel Bar	6
YB2886CH	18.65	Towel Ring	6
YB2894CH	152.70	Towel Shelf	2

Brushed Nickel (BN)			
YB2801BN	29.45	Tank Lever	6
YB2803BN	20.80	Single Robe Hook	24
YB2808BN	37.45	Paper Holder	6
YB2818BN	46.00	18" Towel Bar	6
YB2824BN	48.35	24" Towel Bar	6
YB2886BN	28.40	Towel Ring	6
YB2894BN	167.50	Towel Shelf	2

Oil Rubbed Bronze (ORB)			
YB2801ORB	32.35	Tank Lever	6
YB2803ORB	22.90	Single Robe Hook	24
YB2808ORB	41.15	Paper Holder	6
YB2818ORB	50.60	18" Towel Bar	6
YB2824ORB	53.20	24" Towel Bar	6
YB2886ORB	31.35	Towel Ring	6
YB2894ORB	184.25	Towel Shelf	2

GRAB BARS

PERFECTLY MATCHED to Moen® Eva® faucets and bath accessories. ADA-compliant.

SecureMount™ SecureMount™ Grab Bars are manufactured with an innovative flange design that makes it easy to connect to the stud at multiple points.
To install grab bars securely without studs, use SecureMount™ Anchors. Sold separately.

MODEL NUMBER	LIST PRICE EACH	DESCRIPTION	QTY
1-1/4" • Chrome (CH)			
YG2812CH	80.50	12" Designer Grab Bar	6
YG2818CH	85.10	18" Designer Grab Bar	6
YG2824CH	89.10	24" Designer Grab Bar	6
1-1/4" • Brushed Nickel (BN)			
YG2812BN	98.20	12" Designer Grab Bar	6
YG2818BN	103.15	18" Designer Grab Bar	6
YG2824BN	111.70	24" Designer Grab Bar	6
1-1/4" • Oil Rubbed Bronze (ORB)			
YG2812ORB	107.30	12" Designer Grab Bar	6
YG2818ORB	112.85	18" Designer Grab Bar	6
YG2824ORB	124.50	24" Designer Grab Bar	6



YB2801 Tank Lever



YB2803 Single Robe Hook



YB2808 Paper Holder



YB2824 24" Towel Bar



YB2886 Towel Ring



YB2818 18" Towel Bar



YB2894 Towel Shelf
[Does not work with Pro-Fit® Installation]



YG2824 24" length Designer Grab Bar



YB8081 Pro-Fit® Installation Mounting Template [See page 90 for more information about the Pro-Fit® Installation System.]

Complies with Americans with Disabilities Act (ADA) specifications. SecureMount™ Grab Bars are tested to withstand 500 lb. pull when securely installed per instructions.

List price is per each (unless otherwise noted). Product can be ordered by case quantity or individually.



LIGHTING

MODEL NUMBER	LIST PRICE EACH	DESCRIPTION	QTY
Chrome (CH)			
YB2861CH	108.10	One Globe Bath Light	2
YB2862CH	151.30	Two Globe Bath Light	2
YB2863CH	187.90	Three Globe Bath Light	2
YB2864CH	240.65	Four Globe Bath Light	2
Brushed Nickel (BN)			
YB2861BN	135.10	One Globe Bath Light	2
YB2862BN	189.20	Two Globe Bath Light	2
YB2863BN	234.90	Three Globe Bath Light	2
YB2864BN	300.75	Four Globe Bath Light	2
Oil Rubbed Bronze (ORB)			
YB2861ORB	135.10	One Globe Bath Light	2
YB2862ORB	189.20	Two Globe Bath Light	2
YB2863ORB	234.90	Three Globe Bath Light	2
YB2864ORB	300.75	Four Globe Bath Light	2
Replacement Globe			
YB2869	20.20	Replacement Globe	3



YB2861
One Globe Light

YB2862
Two Globe Light



YB2863
Three Globe Light



YB2864
Four Globe Light

YB2869
Replacement Globe













Bulbs not included.

All Eva™ lighting fixtures can be mounted with globes either facing upward or downward. List price is per each (unless otherwise noted). Product can be ordered by case quantity or individually.



METHOD™ Bathroom Faucets

All Brushed Nickel faucet components feature the LifeShine® Non-Tarnish Finish.

	MODEL NUMBER	LIST PRICE	FINISH/ CONNECTION	CASE QTY
ONE-HANDLE BATHROOM FAUCET				
 <ul style="list-style-type: none"> • application: one or three hole • supply line length: flexible • connection size: 3/8" • connection type: compression • deckplate: included • drain assembly: metal • drain assembly type: lift rod   DURALAST®	6810 ♦ 6810BN	231.55 302.95	Chrome Brushed Nickel	3 3
	 <ul style="list-style-type: none"> • description: vessel extension kit • includes: parts to convert to grid drain 	A2020 A2020BN	134.10 192.10	Chrome Brushed Nickel
TWO-HANDLE WIDESPREAD BATHROOM FAUCET				
 <ul style="list-style-type: none"> • application: three hole • center dimensions: 8" - 16" center • drain assembly: metal • drain assembly type: lift rod • valve: sold separately   	T6820 T6820BN	164.70 246.90	Chrome Brushed Nickel	3 3
	 <ul style="list-style-type: none"> • application: three hole • center dimensions: 8" - 16" center • drain assembly: metal • drain assembly type: lift rod  DURALOCK® DURALAST®	9000 ♦	123.55	1/2" IPS

METHOD™

HOW TO ORDER A COMPLETE BATHROOM FAUCET

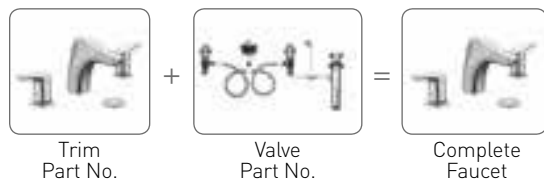











NOTES

- ♦ Also available in bulk pack. See page 435.
- Ⓜ Moen® **M•PACT®** Common Valve System
- DURALOCK®** Duralock® Quick Connections
- DURALAST®** Duralast® Cartridge

Refer to lavatory waste assemblies on page 403.
Refer to specification sheet for critical dimensions for installation.

METHOD™ Roman Tubs

All Brushed Nickel faucet components feature the LifeShine® Non-Tarnish Finish.

	MODEL NUMBER	LIST PRICE	FINISH/ CONNECTION	CASE QTY
TWO-HANDLE ROMAN TUB				
 <ul style="list-style-type: none"> • application: three hole • spout reach: 7.50" • valve: sold separately 	T986 T986BN	268.80 402.15	Chrome Brushed Nickel	3 3
 <ul style="list-style-type: none"> • application: three hole • deck thickness: 1/8" to 3-3/8" rough-in deck • center dimensions: adjustable • adjustable spout shank: included • test plug: included 	4792	143.70	1/2" CC	6
 <ul style="list-style-type: none"> • application: three hole • deck thickness: 1/8" to 2-3/4" rough-in deck • center dimensions: 10" - 24" center • adjustable spout shank: included • test plug: included 	4793 4794	162.70 155.15	1/2" CPVC, Crimp ring PEX 1/2" Crimp ring PEX, Cold Expansion PEX	6 6
 <ul style="list-style-type: none"> • application: three hole • deck thickness: 1/8" to 1-7/8" rough-in deck • center dimensions: 10" center • non-adjustable spout shank: included • test plug: included 	4796 4797 4798	135.35 138.00 138.00	1/2" CC 1/2" CPVC, Crimp ring PEX 1/2" Crimp ring PEX, Cold Expansion PEX	6 6 6
 <ul style="list-style-type: none"> • description: high flow thermostatic mixing valve for roman tubs • ports: three • ASSE standard 1070: yes • flow rate: 12.0 gpm (45.4 L/min) max. 	104465 104466	173.00 173.00	1/2" CC 1/2" IPS	12 12
 <ul style="list-style-type: none"> • description: PEX transition fittings (2) and clips • connections: adapts standard 1/2" PEX barb to 1/2" PEX cold expansion 	140715	10.75	1/2" PEX	200

HOW TO ORDER A COMPLETE ROMAN TUB FAUCET

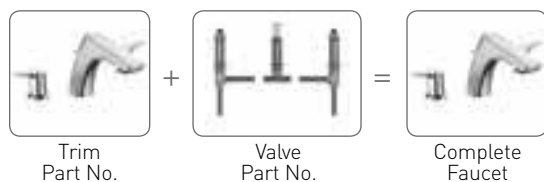

NOTES









 Moen® **M•PACT**® Common Valve System

Thermostatic Mixing Valve service kits, see page 498.

METHOD™

METHOD™ Roman Tubs

All Brushed Nickel faucet components feature the LifeShine® Non-Tarnish Finish.

	MODEL NUMBER	LIST PRICE	FINISH/ CONNECTION	CASE QTY
TWO-HANDLE ROMAN TUB WITH HANDSHOWER				
 <ul style="list-style-type: none"> • application: four hole • showerhead type: handshower • handshower flow rate: 2.0 transitioning to 1.75 gpm • spray functions: one-function • spout reach: 7.50" • valve: sold separately 	T987	422.05	Chrome	3
	T987BN	534.65	Brushed Nickel	3
 <ul style="list-style-type: none"> • application: four hole • deck thickness: 1/8" to 2-5/8" rough-in deck • center dimensions: adjustable • non-adjustable spout shank: included • test plug: included 	9792	323.75	1/2" CC	6
 <ul style="list-style-type: none"> • application: four hole • deck thickness: 1/8" to 2-5/8" rough-in deck • center dimensions: 10" - 24" center • non-adjustable spout shank: included • test plug: included 	9793	331.35	1/2" CPVC, Crimp ring PEX	6
 <ul style="list-style-type: none"> • description: high flow thermostatic mixing valve for roman tubs • ports: three • ASSE standard 1070: yes • flow rate: 12.0 gpm (45.4 L/min) max. 	104465	173.00	1/2" CC	12
	104466	173.00	1/2" IPS	12
 <ul style="list-style-type: none"> • description: PEX transition fittings (2) and clips • connections: adapts standard 1/2" PEX barb to 1/2" PEX cold expansion 	140715	10.75	1/2" PEX	200

METHOD™

HOW TO ORDER A COMPLETE ROMAN TUB FAUCET

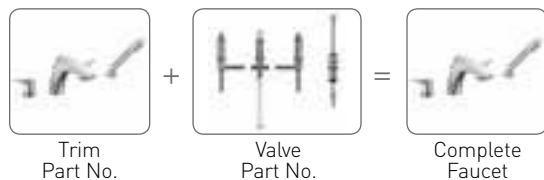











NOTES

 Moen® **M•PACT**® Common Valve System

Thermostatic Mixing Valve service kits, see page 498.

METHOD™ Posi-Temp® Showering

All Brushed Nickel faucet components feature the LifeShine® Non-Tarnish Finish.

		MODEL NUMBER	LIST PRICE	FINISH/ CONNECTION	CASE QTY
POSI-TEMP® TUB/SHOWER					
 <ul style="list-style-type: none"> • showerhead functions: one-function • showerhead type: standard • showerhead size: 2-1/2" diameter spray head • showerhead flow rate: 2.5 gpm (9.5 L/min) max. • spout length: 5-7/8" • spout connection type: slip fit • tub spout type: diverter • red/blue markings: included • valve: sold separately 		T2803 ◆	104.65	Chrome	3
			T2803BN	204.00	Brushed Nickel
 <ul style="list-style-type: none"> • showerhead functions: one-function • showerhead type: eco-performance showerhead • showerhead size: 2-1/2" diameter spray head • showerhead flow rate: 1.75 gpm (6.65 L/min) max. • spout length: 5-7/8" • spout connection type: slip fit • tub spout type: diverter • red/blue markings: included • valve: sold separately 		T62803EP ◆◆	89.80	Chrome	12
			T2803EPBN	204.00	Brushed Nickel
 <ul style="list-style-type: none"> • showerhead type: showerhead sold separately • spout length: 5-7/8" • spout connection type: slip fit • tub spout type: diverter • red/blue markings: included • valve: sold separately 		T2803NH ◆	76.55	Chrome	3
			T2803NHBN	156.25	Brushed Nickel
 		2510 ◆	119.75	1/2" IPS	6
		2520 ◆	119.75	1/2" CC	6
		2580 ◆	119.75	1/2" Crimp ring PEX	6
 		2570 ◆	145.35	1/2" CC	6
		2590 ◆	145.35	1/2" IPS	6

HOW TO ORDER A COMPLETE TUB/SHOWER FAUCET

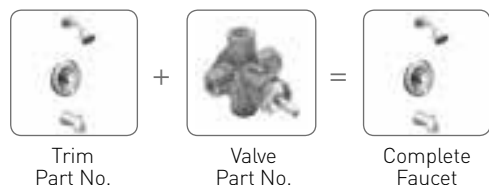





NOTES

- ◆ Also available in bulk pack. See page 435.
- ◆◆ Available in bulk pack only. See page 435.
- Ⓜ Moen® **M•PACT**® Common Valve System



METHOD™ Posi-Temp® Showering

All Brushed Nickel faucet components feature the LifeShine® Non-Tarnish Finish.

		MODEL NUMBER	LIST PRICE	FINISH/ CONNECTION	CASE QTY
POSI-TEMP® SHOWER ONLY					
	<ul style="list-style-type: none"> • showerhead functions: one-function • showerhead type: standard • showerhead size: 2-1/2" diameter spray head • showerhead flow rate: 2.5 gpm (9.5 L/min) max. • red/blue markings: included • valve: sold separately 	T2802 ◆	71.85	Chrome	3
		T2802BN	154.65	Brushed Nickel	3
	<ul style="list-style-type: none"> • showerhead functions: one-function • showerhead type: eco-performance showerhead • showerhead size: 2-1/2" diameter spray head • showerhead flow rate: 1.75 gpm (6.65 L/min) max. • red/blue markings: included • valve: sold separately 	T62802EP ◆◆	59.60	Chrome	12
		T2802EPBN	154.65	Brushed Nickel	3
	<ul style="list-style-type: none"> • showerhead type: showerhead sold separately • red/blue markings: included • valve: sold separately 	T2802NH ◆	61.30	Chrome	3
		T2802NHBN	132.60	Brushed Nickel	3
	<ul style="list-style-type: none"> • description: pressure balanced cycling valve • ports: four • adjustable temp limit stop: included 	2510 ◆	119.75	1/2" IPS	6
		2520 ◆	119.75	1/2" CC	6
		2580 ◆	119.75	1/2" Crimp ring PEX	6
	<ul style="list-style-type: none"> • description: pressure balanced cycling valve • ports: four • adjustable temp limit stop: included • quarter turn stops: included 	2570 ◆	145.35	1/2" CC	6
		2590 ◆	145.35	1/2" IPS	6

METHOD™

HOW TO ORDER A COMPLETE SHOWER FAUCET

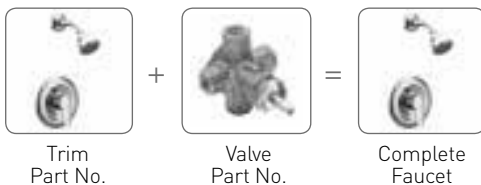







NOTES

- ◆ Also available in bulk pack. See page 435.
- ◆◆ Available in bulk pack only. See page 435.
- Ⓜ Moen® **M•PACT**® Common Valve System

METHOD™ Posi-Temp® Showering

All Brushed Nickel faucet components feature the LifeShine® Non-Tarnish Finish.

		MODEL NUMBER	LIST PRICE	FINISH/ CONNECTION	CASE QTY
POSI-TEMP® VALVE ONLY					
 <ul style="list-style-type: none"> • red/blue markings: included • valve: sold separately  		T2801	54.80	Chrome	3
		T2801BN	125.15	Brushed Nickel	3
 		2510 ♦	119.75	1/2" IPS	6
		2520 ♦	119.75	1/2" CC	6
		2580 ♦	119.75	1/2" Crimp ring PEX	6
 		2570 ♦	145.35	1/2" CC	6
		2590 ♦	145.35	1/2" IPS	6

HOW TO ORDER A COMPLETE VALVE



NOTES

- ♦ Also available in bulk pack. See page 435.
- Ⓜ Moen® **M•PACT**® Common Valve System



METHOD™ Perfectly Matched Bath Accessories

Moen® bath accessories CANNOT be combined with Moen® faucet parts on a Purchase Order.

Moen makes it easy to coordinate the entire style and look of the bathroom. Our Method™ bath accessories perfectly match the style and finish of our Method™ faucets. Total coordination of the bath has never been easier.

For more information on ordering Method™ bath accessories or other matching Moen® bath accessories, contact Moen Bath Accessory Customer Service at **800-882-0116**, contact your local Moen sales representative, or visit us at **www.moen.com**.

MODEL NUMBER	LIST PRICE EACH	DESCRIPTION	QTY
D-Shaped Bar			
Chrome (CH)			
YB2401CH	19.20	Tank Lever	24
YB2403CH	13.65	Double Robe Hook	24
P YB2408CH	24.40	Pivoting Paper Holder	6
YB2418CH	29.95	18" Towel Bar	6
YB2422CH	55.60	18" Double Towel Bar	6
YB2424CH	31.55	24" Towel Bar	6
YB2486CH	18.65	9" Hand Towel Bar	6
Brushed Nickel (BN)			
YB2401BN	29.45	Tank Lever	6
YB2403BN	20.80	Double Robe Hook	24
P YB2408BN	37.45	Pivoting Paper Holder	6
YB2418BN	46.00	18" Towel Bar	6
YB2422BN	70.75	18" Double Towel Bar	6
YB2424BN	48.35	24" Towel Bar	6
YB2486BN	28.40	9" Hand Towel Bar	6



YB2401 Tank Lever



YB2403 Double Robe Hook



P YB2408 Pivoting Paper Holder



YB2422 18" Double Towel Bar
[Does not work with Pro-Fit® Installation]



YB2423 24" Double Towel Bar
[Does not work with Pro-Fit® Installation]



YB2418 18" Towel Bar



YB2424 24" Towel Bar



YB2486 9" Hand Towel Bar















P Denotes pivoting paper holder

List price is per each (unless otherwise noted). Product can be ordered by case quantity or individually.

METHOD™

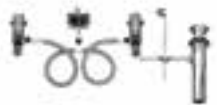
GIBSON™ Bathroom Faucets

	MODEL NUMBER	LIST PRICE	FINISH/ CONNECTION	CASE QTY
ONE-HANDLE BATHROOM FAUCET				
 <ul style="list-style-type: none"> • application: one to three hole • supply line length: flexible • connection size: 3/8" • connection type: compression • deckplate: included • drain assembly: metal • drain assembly type: lift rod • red/blue markings: included   DURALAST®	6145	174.70	Chrome	3
TWO-HANDLE CENTERSET BATHROOM FAUCET				
 <ul style="list-style-type: none"> • application: three hole • connection size: 1/2" • connection type: IPS • drain assembly: metal • drain assembly type: lift rod  	6150	147.05	Chrome	3
TWO-HANDLE WIDESPREAD BATHROOM FAUCET				
 <ul style="list-style-type: none"> • application: three hole • center dimensions: 8" - 16" center • drain assembly: metal • drain assembly type: lift rod • red/blue markings: included • valve: sold separately   	T6142	161.15	Chrome	3
 <ul style="list-style-type: none"> • application: three hole • center dimensions: 8" - 16" center • drain assembly: metal • drain assembly type: lift rod  DURALOCK® DURALAST®	9000 ♦	123.55	1/2" IPS	6

HOW TO ORDER A COMPLETE BATHROOM FAUCET

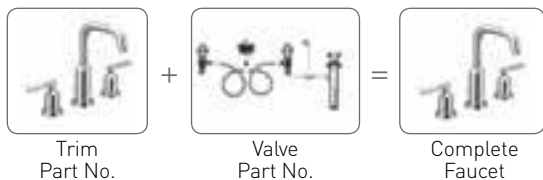







NOTES

- ♦ Also available in bulk pack. See page 435.
- Ⓜ Moen® **M•PACT®** Common Valve System
- DURALOCK®** Duralock® Quick Connections
- DURALAST®** Duralast® Cartridge

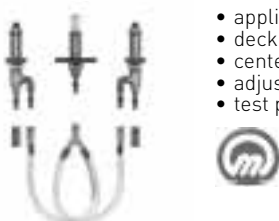
Refer to lavatory waste assemblies on page 403.
Refer to specification sheet for critical dimensions for installation.

GIBSON™ Roman Tubs

	MODEL NUMBER	LIST PRICE	FINISH/ CONNECTION	CASE QTY
TWO-HANDLE ROMAN TUB				
 <ul style="list-style-type: none"> • application: three hole • spout reach: 7.63" • valve: sold separately 	T961	263.10	Chrome	3
 <ul style="list-style-type: none"> • application: three hole • deck thickness: 1/8" to 3-3/8" rough-in deck • center dimensions: adjustable • adjustable spout shank: included • test plug: included 	4792	143.70	1/2" CC	6
 <ul style="list-style-type: none"> • application: three hole • deck thickness: 1/8" to 2-3/4" rough-in deck • center dimensions: 10" - 24" center • adjustable spout shank: included • test plug: included 	4793 4794	162.70 155.15	1/2" CPVC, Crimp ring PEX 1/2" Crimp ring PEX, Cold Expansion PEX	6 6
 <ul style="list-style-type: none"> • application: three hole • deck thickness: 1/8" to 1-7/8" rough-in deck • center dimensions: 10" center • non-adjustable spout shank: included • test plug: included 	4796 4797 4798	135.35 138.00 138.00	1/2" CC 1/2" CPVC, Crimp ring PEX 1/2" Crimp ring PEX, Cold Expansion PEX	6 6 6
 <ul style="list-style-type: none"> • description: high flow thermostatic mixing valve for roman tubs • ports: three • ASSE standard 1070: yes • flow rate: 12.0 gpm (45.4 L/min) max. 	104465 104466	173.00 173.00	1/2" CC 1/2" IPS	12 12
 <ul style="list-style-type: none"> • description: PEX transition fittings (2) and clips • connections: adapts standard 1/2" PEX barb to 1/2" PEX cold expansion 	140715	10.75	1/2" PEX	200



HOW TO ORDER A COMPLETE ROMAN TUB FAUCET

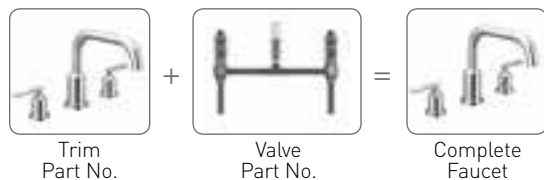

NOTES

 Moen® **M•PACT®** Common Valve System

Thermostatic Mixing Valve service kits, see page 498.

GIBSON™ Transfer Valve Shower Spa Components

		MODEL NUMBER	LIST PRICE	FINISH/ CONNECTION	CASE QTY
3 INDEPENDENT FUNCTION TRANSFER VALVE ONLY					
 <ul style="list-style-type: none"> • use with 3362 transfer valve • valve: sold separately 		T2922	90.50	Chrome	12
 <ul style="list-style-type: none"> • ports: four • type of function: three independent function • must be used with: Posi-Temp® or Moentrol® valve 		3362	192.60	1/2" CC	6
2/3 FUNCTION TRANSFER VALVE ONLY					
 <ul style="list-style-type: none"> • use with 3372 or 3375 transfer valve • valve: sold separately 		T2921	90.50	Chrome	12
 <ul style="list-style-type: none"> • type of function: two independent one shared • must be used with: Posi-Temp® or Moentrol® valve 		3372	172.00	1/2" CC	12
 <ul style="list-style-type: none"> • type of function: two independent functions • must be used with: Posi-Temp® or Moentrol® valve 		3375	172.00	1/2" CC	12

HOW TO ORDER A COMPLETE TRANSFER VALVE

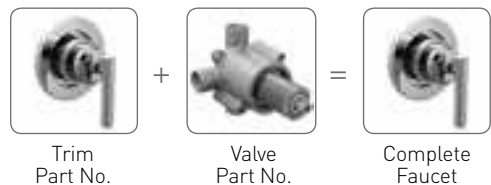















NOTES

 Moen® **M•PACT**® Common Valve System
DURALAST® Duralast® Cartridge



GIBSON™ Posi-Temp® Showering

		MODEL NUMBER	LIST PRICE	FINISH/ CONNECTION	CASE QTY
POSI-TEMP® TUB/SHOWER					
 <ul style="list-style-type: none"> • showerhead functions: one-function • showerhead type: eco-performance showerhead • showerhead size: 8" diameter spray head • showerhead flow rate: 2.0 transitioning to 1.75 gpm • spout length: 6-1/2" • spout connection type: slip fit • tub spout type: diverter • red/blue markings: included • valve: sold separately   		T3003EP	129.40	Chrome	4
 <ul style="list-style-type: none"> • showerhead functions: one-function • showerhead type: eco-performance showerhead • showerhead size: 3.6" diameter spray head • showerhead flow rate: 1.75 gpm (6.65 L/min) max. • spout length: 6-1/2" • spout connection type: slip fit • tub spout type: diverter • red/blue markings: included • valve: sold separately   		T2903EP	87.85	Chrome	3
 <ul style="list-style-type: none"> • showerhead type: showerhead sold separately • spout length: 6-1/2" • spout connection type: slip fit • tub spout type: diverter • red/blue markings: included • valve: sold separately  		T2903NH	75.25	Chrome	3
 <ul style="list-style-type: none"> • description: pressure balanced cycling valve • ports: four • adjustable temp limit stop: included 		2510 ◆	119.75	1/2" IPS	6
		2520 ◆	119.75	1/2" CC	6
		2580 ◆	119.75	1/2" Crimp ring PEX	6
 <ul style="list-style-type: none"> • description: pressure balanced cycling valve • ports: four • adjustable temp limit stop: included • quarter turn stops: included 		2570 ◆	145.35	1/2" CC	6
		2590 ◆	145.35	1/2" IPS	6















HOW TO ORDER A COMPLETE TUB/SHOWER FAUCET



NOTES

- ◆ Also available in bulk pack. See page 435.
- Ⓜ Moen® **M•PACT**® Common Valve System

GIBSON™ Posi-Temp® Showering

	MODEL NUMBER	LIST PRICE	FINISH/ CONNECTION	CASE QTY
POSI-TEMP® SHOWER ONLY				
 <ul style="list-style-type: none"> • showerhead functions: one-function • showerhead type: eco-performance showerhead • showerhead size: 8" diameter spray head • showerhead flow rate: 2.0 transitioning to 1.75 gpm • red/blue markings: included • valve: sold separately   	T3002EP	99.85	Chrome	4
 <ul style="list-style-type: none"> • showerhead functions: one-function • showerhead type: standard • showerhead size: 3.6" diameter spray head • showerhead flow rate: 1.75 gpm (6.65 L/min) max. • red/blue markings: included • valve: sold separately   	T2902EP	58.35	Chrome	3
 <ul style="list-style-type: none"> • showerhead type: showerhead sold separately • red/blue markings: included • valve: sold separately  	T2902NH	55.50	Chrome	3
 <ul style="list-style-type: none"> • description: pressure balanced cycling valve • ports: four • adjustable temp limit stop: included 	2510 ♦ 2520 ♦ 2580 ♦	119.75 119.75 119.75	1/2" IPS 1/2" CC 1/2" Crimp ring PEX	6 6 6
 <ul style="list-style-type: none"> • description: pressure balanced cycling valve • ports: four • adjustable temp limit stop: included • quarter turn stops: included 	2570 ♦ 2590 ♦	145.35 145.35	1/2" CC 1/2" IPS	6 6

HOW TO ORDER A COMPLETE SHOWER FAUCET









NOTES

- ♦ Also available in bulk pack. See page 435.
- Ⓜ Moen® **M•PACT**® Common Valve System



GIBSON™ Posi-Temp® Showering

		MODEL NUMBER	LIST PRICE	FINISH/ CONNECTION	CASE QTY
POSI-TEMP® VALVE ONLY					
 <ul style="list-style-type: none"> • red/blue markings: included • valve: sold separately  		T2901	53.65	Chrome	3
 	<ul style="list-style-type: none"> • description: pressure balanced cycling valve 	2510 ◆	119.75	1/2" IPS	6
	<ul style="list-style-type: none"> • ports: four 	2520 ◆	119.75	1/2" CC	6
	<ul style="list-style-type: none"> • adjustable temp limit stop: included 	2580 ◆	119.75	1/2" Crimp ring PEX	6
 	<ul style="list-style-type: none"> • description: pressure balanced cycling valve 	2570 ◆	145.35	1/2" CC	6
	<ul style="list-style-type: none"> • ports: four • adjustable temp limit stop: included • quarter turn stops: included 	2590 ◆	145.35	1/2" IPS	6

GIBSON™

















HOW TO ORDER A COMPLETE VALVE



NOTES

- ◆ Also available in bulk pack. See page 435.
- Ⓜ Moen® **M•PACT**® Common Valve System

GENTA™ Bathroom Faucets, Transfer Valve Shower Spa Components

	MODEL NUMBER	LIST PRICE	FINISH/ CONNECTION	CASE QTY
ONE-HANDLE BATHROOM FAUCET				
 <ul style="list-style-type: none"> • application: one or three hole • supply line length: flexible • connection size: 3/8" • connection type: compression • deckplate: included • drain assembly: metal • drain assembly type: lift rod • red/blue markings: included   DURALAST®	6702	174.70	Chrome	3
3 INDEPENDENT FUNCTION TRANSFER VALVE ONLY				
 <p>NEW!</p> <ul style="list-style-type: none"> • use with 3362 transfer valve • valve: sold separately  	T2402	90.50	Chrome	12
 <ul style="list-style-type: none"> • ports: four • type of function: three independent function • must be used with: Posi-Temp® or Moentrol® valve  	3362	192.60	1/2" CC	6
2/3 FUNCTION TRANSFER VALVE ONLY				
 <ul style="list-style-type: none"> • use with 3372 or 3375 transfer valve • valve: sold separately  	T2401	90.50	Chrome	12
 <ul style="list-style-type: none"> • type of function: two independent one shared • must be used with: Posi-Temp® or Moentrol® valve 	3372	172.00	1/2" CC	12
 <ul style="list-style-type: none"> • type of function: two independent functions • must be used with: Posi-Temp® or Moentrol® valve 	3375	172.00	1/2" CC	12

HOW TO ORDER A COMPLETE VALVE

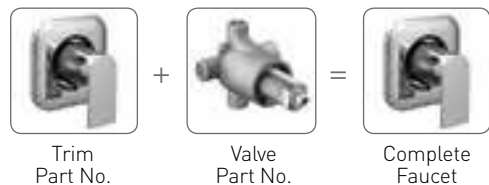













NOTES

 Moen® **M•PACT®** Common Valve System
DURALAST® Duralast® Cartridge

Refer to lavatory waste assemblies on page 403.



GENTA™ Posi-Temp® Showering

		MODEL NUMBER	LIST PRICE	FINISH/ CONNECTION	CASE QTY
POSI-TEMP® TUB/SHOWER					
 <ul style="list-style-type: none"> • showerhead functions: three-function • showerhead type: eco-performance showerhead • showerhead size: 3-3/4" diameter spray head • showerhead flow rate: 2.0 transitioning to 1.75 gpm • red/blue markings: included • valve: sold separately   		T2473EP	87.85	Chrome	3
 <ul style="list-style-type: none"> • showerhead type: showerhead sold separately • red/blue markings: included • valve: sold separately   		T2473NH	75.25	Chrome	3
  <ul style="list-style-type: none"> • description: pressure balanced cycling valve • ports: four • adjustable temp limit stop: included 		2510 ◆	119.75	1/2" IPS	6
		2520 ◆	119.75	1/2" CC	6
		2580 ◆	119.75	1/2" Crimp ring PEX	6
  <ul style="list-style-type: none"> • description: pressure balanced cycling valve • ports: four • adjustable temp limit stop: included • quarter turn stops: included 		2570 ◆	145.35	1/2" CC	6
		2590 ◆	145.35	1/2" IPS	6

GENTA™



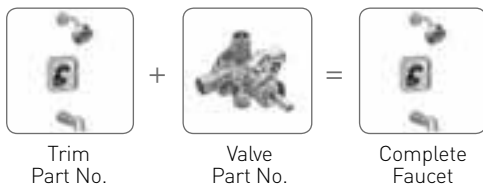









HOW TO ORDER A COMPLETE TUB/SHOWER FAUCET



NOTES

- ◆ Also available in bulk pack. See page 435.
- Ⓜ Moen® **M•PACT®** Common Valve System

GENTA™ Posi-Temp® Showering

	MODEL NUMBER	LIST PRICE	FINISH/ CONNECTION	CASE QTY
POSI-TEMP® SHOWER ONLY				
 <ul style="list-style-type: none"> • showerhead functions: three-function • showerhead type: eco-performance showerhead • showerhead size: 3-3/4" diameter spray head • showerhead flow rate: 2.0 transitioning to 1.75 gpm • red/blue markings: included • valve: sold separately   	T2472EP	58.35	Chrome	3
 <ul style="list-style-type: none"> • showerhead type: showerhead sold separately • red/blue markings: included • valve: sold separately   	T2472NH	55.50	Chrome	3
 <ul style="list-style-type: none"> • description: pressure balanced cycling valve • ports: four • adjustable temp limit stop: included 	2510 ♦ 2520 ♦ 2580 ♦	119.75 119.75 119.75	1/2" IPS 1/2" CC 1/2" Crimp ring PEX	6 6 6
 <ul style="list-style-type: none"> • description: pressure balanced cycling valve • ports: four • adjustable temp limit stop: included • quarter turn stops: included 	2570 ♦ 2590 ♦	145.35 145.35	1/2" CC 1/2" IPS	6 6



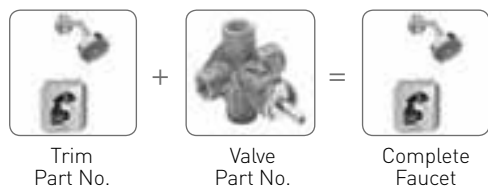



HOW TO ORDER A COMPLETE SHOWER FAUCET



NOTES

- ♦ Also available in bulk pack. See page 435.
- Ⓜ Moen® **M•PACT**® Common Valve System

GENTA™ Posi-Temp® Showering

		MODEL NUMBER	LIST PRICE	FINISH/ CONNECTION	CASE QTY
POSI-TEMP® VALVE ONLY					
 <ul style="list-style-type: none"> • red/blue markings: included • valve: sold separately  		T2471	53.65	Chrome	3
 	<ul style="list-style-type: none"> • description: pressure balanced cycling valve 	2510 ◆	119.75	1/2" IPS	6
	<ul style="list-style-type: none"> • ports: four 	2520 ◆	119.75	1/2" CC	6
	<ul style="list-style-type: none"> • adjustable temp limit stop: included 	2580 ◆	119.75	1/2" Crimp ring PEX	6
 	<ul style="list-style-type: none"> • description: pressure balanced cycling valve 	2570 ◆	145.35	1/2" CC	6
	<ul style="list-style-type: none"> • ports: four • adjustable temp limit stop: included • quarter turn stops: included 	2590 ◆	145.35	1/2" IPS	6



HOW TO ORDER A COMPLETE VALVE

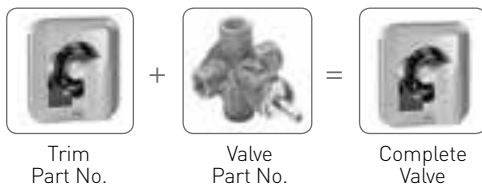

NOTES

- ◆ Also available in bulk pack. See page 435.
- Ⓜ Moen® **M•PACT®** Common Valve System

GENTA™ Perfectly Matched Bath Accessories

Moen® bath accessories CANNOT be combined with Moen® faucet parts on a Purchase Order.

Moen makes it easy to coordinate the entire style and look of the bathroom. Our Genta™ bath accessories perfectly match the style and finish of our Genta™ faucets.

Total coordination of the bath has never been easier.

For more information on ordering Genta™ bath accessories or other matching Moen® bath accessories, contact Moen Bath Accessory Customer Service at **800-882-0116**, contact your local Moen sales representative, or visit us at **www.moen.com**.

MODEL NUMBER	LIST PRICE EACH	DESCRIPTION	QTY
Chrome (CH)			
BH3803CH	22.10	Single Robe Hook	12
(P) BH3808CH	39.80	Pivoting Paper Holder	3
BH3818CH	40.10	18" Towel Bar	3
BH3824CH	41.50	24" Towel Bar	3
BH3886CH	30.40	Hand Towel Bar	3



BH3803
Single Robe Hook



(P) BH3808
Pivoting Paper Holder



BH3818
18" Towel Bar



BH3824
24" Towel Bar



BH3886
Hand Towel Bar















(P) Denotes pivoting paper holder

List price is per each (unless otherwise noted). Product can be ordered by case quantity or individually.



CHATEAU® Bathroom Faucets

All Polished Brass faucet components feature the LifeShine® Non-Tarnish Finish.

		MODEL NUMBER	LIST PRICE	FINISH/ CONNECTION	CASE QTY
ONE-HANDLE BATHROOM FAUCET					
	<ul style="list-style-type: none"> • application: three hole • center dimensions: 4" center • connection size: 1/2" • connection type: IPS • drain assembly: drain not included 	L4601 ♦	133.60	Chrome	12
	  DURALAST®				
	<ul style="list-style-type: none"> • application: three hole • center dimensions: 4" center • connection size: 1/2" • connection type: IPS • drain assembly: drain not included • red/blue markings: included 	L4605	133.60	Chrome	12
	  DURALAST®				
	<ul style="list-style-type: none"> • application: three hole • center dimensions: 4" center • connection size: 1/2" • connection type: IPS • drain assembly: metal • drain assembly type: lift rod 	L4621 ♦ L4621BC L4621P ♦	165.00 198.00 279.25	Chrome Brushed Chrome Polished Brass	12 12 12
	  DURALAST®				
	<ul style="list-style-type: none"> • application: three hole • center dimensions: 4" center • supply line length: 16" • connection size: 3/8" • connection type: compression • drain assembly: metal • drain assembly type: lift rod 	L4625 L4631BC	165.00 198.00	Chrome Brushed Chrome	6 6
	  DURALAST®				
	<ul style="list-style-type: none"> • application: three hole • center dimensions: 4" center • connection size: 1/2" • connection type: IPS • drain assembly: metal • drain assembly type: lift rod • red/blue markings: included 	L4635 ♦	165.00	Chrome	12
	  DURALAST®				

CHATEAU®









NOTES

♦ Also available in bulk pack. See page 435.

DURALAST® Duralast® Cartridge

Refer to lavatory waste assemblies on page 403.

CHATEAU® Bathroom Faucets

	MODEL NUMBER	LIST PRICE	FINISH/ CONNECTION	CASE QTY
TWO-HANDLE CENTERSET BATHROOM FAUCET				
 <ul style="list-style-type: none"> • application: three hole • center dimensions: 4" center • connection size: 1/2" • connection type: IPS • drain assembly: metal • drain assembly type: lift rod   DURALAST®	4925 ♦	151.80	Chrome	12
	4925BC	193.95	Brushed Chrome	12
TWO-HANDLE WIDESPREAD BATHROOM FAUCET				
 <ul style="list-style-type: none"> • application: three hole • center dimensions: 8" - 16" center • connection size: 1/2" • connection type: IPS • drain assembly: metal • drain assembly type: lift rod • includes: 9000 valve   DURALOCK®	4945	265.85	Chrome	6
	 <ul style="list-style-type: none"> • application: three hole • center dimensions: 8" - 16" center • connection size: 1/2" • connection type: IPS • drain assembly: metal • drain assembly type: lift rod • includes: 9000 valve  DURALOCK®	4962	245.90	Chrome









NOTES

♦ Also available in bulk pack. See page 435.

DURALOCK® Duralock® Quick Connections

Refer to specification sheet for critical dimensions for installation.

CHATEAU® Roman Tubs

		MODEL NUMBER	LIST PRICE	FINISH/ CONNECTION	CASE QTY
TWO-HANDLE GARDEN TUB					
	<ul style="list-style-type: none"> • for garden tub application • application: three hole • connection size: 1/2" • connection type: IPS • spout reach: 7.00" • includes: valve • center dimensions: 8" - 16" center 	4902	185.90	Chrome	6
TWO-HANDLE ROMAN TUB					
	<ul style="list-style-type: none"> • for garden tub application • application: three hole • spout reach: 7.00" • valve: sold separately 	T994	159.05	Chrome	6
	<ul style="list-style-type: none"> • application: three hole • spout reach: 9.00" • valve: sold separately 	T990 T990BC	257.95 318.45	Chrome Brushed Chrome	6 6
	<ul style="list-style-type: none"> • application: three hole • spout reach: 9.00" • valve: sold separately 	T999	200.95	Chrome	6
	<ul style="list-style-type: none"> • application: three hole • deck thickness: 1/8" to 3-3/8" rough-in deck • center dimensions: adjustable • adjustable spout shank: included • test plug: included 	4792	143.70	1/2" CC	6
	<ul style="list-style-type: none"> • application: three hole • deck thickness: 1/8" to 2-3/4" rough-in deck • center dimensions: 10" - 24" center • adjustable spout shank: included • test plug: included 	4793 4794	162.70 155.15	1/2" CPVC, Crimp ring PEX 1/2" Crimp ring PEX, Cold Expansion PEX	6 6
	<ul style="list-style-type: none"> • application: three hole • deck thickness: 1/8" to 1-7/8" rough-in deck • center dimensions: 10" center • non-adjustable spout shank: included • test plug: included 	4796 4797 4798	135.35 138.00 138.00	1/2" CC 1/2" CPVC, Crimp ring PEX 1/2" Crimp ring PEX, Cold Expansion PEX	6 6 6
	<ul style="list-style-type: none"> • description: high flow thermostatic mixing valve for roman tubs • ports: three • ASSE standard 1070: yes • flow rate: 12.0 gpm (45.4 L/min) max. 	104465 104466	173.00 173.00	1/2" CC 1/2" IPS	12 12
	<ul style="list-style-type: none"> • description: PEX transition fittings (2) and clips • connections: adapts standard 1/2" PEX barb to 1/2" PEX cold expansion 	140715	10.75	1/2" PEX	200

CHATEAU®



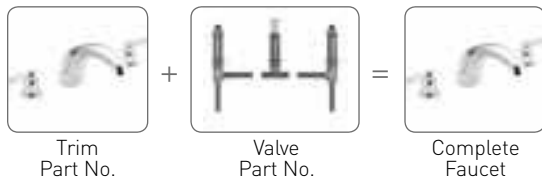





HOW TO ORDER A COMPLETE ROMAN TUB FAUCET

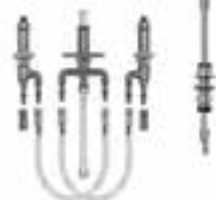

NOTES

 Moen® **M•PACT®** Common Valve System

Thermostatic Mixing Valve service kits, see page 498.

	MODEL NUMBER	LIST PRICE	FINISH/ CONNECTION	CASE QTY
TWO-HANDLE ROMAN TUB WITH HANDSHOWER				
 <ul style="list-style-type: none"> • application: four hole • showerhead type: handshower • handshower flow rate: 2.0 transitioning to 1.75 gpm • spray functions: one-function • spout reach: 9.00" • valve: sold separately  	T991	383.65	Chrome	6
 <ul style="list-style-type: none"> • application: four hole • deck thickness: 1/8" to 2-5/8" rough-in deck • center dimensions: adjustable • non-adjustable spout shank: included • test plug: included 	9792	323.75	1/2" CC	6
 <ul style="list-style-type: none"> • application: four hole • deck thickness: 1/8" to 2-5/8" rough-in deck • center dimensions: 10" - 24" center • non-adjustable spout shank: included • test plug: included 	9793	331.35	1/2" CPVC, Crimp ring PEX	6
 <ul style="list-style-type: none"> • description: high flow thermostatic mixing valve for roman tubs • ports: three • ASSE standard 1070: yes • flow rate: 12.0 gpm (45.4 L/min) max. 	104465 104466	173.00 173.00	1/2" CC 1/2" IPS	12 12
 <ul style="list-style-type: none"> • description: PEX transition fittings (2) and clips • connections: adapts standard 1/2" PEX barb to 1/2" PEX cold expansion 	140715	10.75	1/2" PEX	200

HOW TO ORDER A COMPLETE ROMAN TUB FAUCET

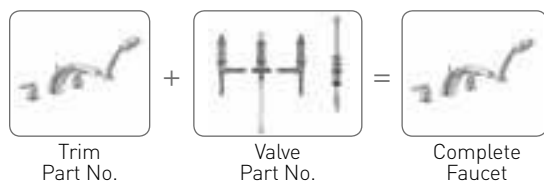















NOTES











 Moen® **M•PACT®** Common Valve System

Thermostatic Mixing Valve service kits, see page 498.

CHATEAU® Posi-Temp® Showering

		MODEL NUMBER	LIST PRICE	FINISH/ CONNECTION	CASE QTY
POSI-TEMP® TUB/SHOWER WITH VALVE					
	<ul style="list-style-type: none"> • ports: four • connection size: 1/2" • connection type: CC • showerhead functions: one-function • showerhead type: standard • showerhead size: 2-1/2" diameter spray head • showerhead flow rate: 2.5 gpm (9.5 L/min) max. • spout length: 5-1/2" • spout connection type: slip fit • tub spout type: diverter • red/blue markings: included • adjustable temp limit stop: included 	2353 	174.80	Chrome	12
	<ul style="list-style-type: none"> • ports: four • connection size: 1/2" • connection type: CC • showerhead functions: one-function • showerhead type: standard • showerhead size: 2-1/2" diameter spray head • showerhead flow rate: 2.5 gpm (9.5 L/min) max. • spout length: 5-1/2" • spout connection type: slip fit • tub spout type: diverter • red/blue markings: included • adjustable temp limit stop: included • quarter turn stops: included 	2363 	199.70	Chrome	12
	<ul style="list-style-type: none"> • ports: four • connection size: 1/2" • connection type: CC • showerhead functions: one-function • showerhead type: standard • showerhead size: 2-1/2" diameter spray head • showerhead flow rate: 2.5 gpm (9.5 L/min) max. • spout length: 5-1/2" • spout connection type: slip fit • tub spout type: diverter • red/blue markings: included • adjustable temp limit stop: included 	L2353 	174.80	Chrome	6
	<ul style="list-style-type: none"> • ports: four • connection size: 1/2" • connection type: CC • showerhead functions: one-function • showerhead type: eco-performance showerhead • showerhead size: 2-1/2" diameter spray head • showerhead flow rate: 1.75 gpm (6.65 L/min) max. • spout length: 5-1/2" • spout connection type: slip fit • tub spout type: diverter • red/blue markings: included • adjustable temp limit stop: included 	L2353EP  	174.80	Chrome	6
	<ul style="list-style-type: none"> • ports: four • connection size: 1/2" • connection type: CC • showerhead functions: one-function • showerhead type: standard • showerhead size: 2-1/2" diameter spray head • showerhead flow rate: 2.5 gpm (9.5 L/min) max. • spout length: 5-1/2" • spout connection type: slip fit • tub spout type: diverter • red/blue markings: included • adjustable temp limit stop: included • quarter turn stops: included 	L2363 	199.70	Chrome	6
	<ul style="list-style-type: none"> • ports: four • connection size: 1/2" • connection type: CC • showerhead functions: one-function • showerhead type: eco-performance showerhead • showerhead size: 2-1/2" diameter spray head • showerhead flow rate: 1.75 gpm (6.65 L/min) max. • spout length: 5-1/2" • spout connection type: slip fit • tub spout type: diverter • adjustable temp limit stop: included • quarter turn stops: included 	L2369EP  	238.60	Chrome	3

CHATEAU® Posi-Temp® Showering

		MODEL NUMBER	LIST PRICE	FINISH/ CONNECTION	CASE QTY
POSI-TEMP® TUB/SHOWER					
	<ul style="list-style-type: none"> • showerhead functions: one-function • showerhead type: standard • showerhead size: 2-1/2" diameter spray head • showerhead flow rate: 2.5 gpm (9.5 L/min) max. • spout length: 5-1/2" • spout connection type: slip fit • tub spout type: diverter • red/blue markings: included • valve: sold separately 	TL183 ♦♦	61.70	Chrome	12
					
	<ul style="list-style-type: none"> • showerhead functions: one-function • showerhead type: eco-performance showerhead • showerhead size: 2-1/2" diameter spray head • showerhead flow rate: 1.75 gpm (6.65 L/min) max. • spout length: 5-1/2" • spout connection type: slip fit • tub spout type: diverter • red/blue markings: included • valve: sold separately 	TL183EP ♦♦ TL183EPBC ♦	61.70 95.40	Chrome Brushed Chrome	12 12
					
	<ul style="list-style-type: none"> • showerhead functions: one-function • showerhead type: eco-performance showerhead • showerhead size: 2-1/2" diameter spray head • showerhead flow rate: 1.75 gpm (6.65 L/min) max. • spout length: 5-1/2" • spout connection type: slip fit • tub spout type: diverter • used to replace: 2 or 3 hole shower valve • valve: sold separately 	TL2369EP	97.55	Chrome	6
					
	<ul style="list-style-type: none"> • description: pressure balanced cycling valve • ports: four • adjustable temp limit stop: included 	2510 ♦ 2520 ♦ 2580 ♦	119.75 119.75 119.75	1/2" IPS 1/2" CC 1/2" Crimp ring PEX	6 6 6
					
	<ul style="list-style-type: none"> • description: pressure balanced cycling valve • ports: four • adjustable temp limit stop: included • quarter turn stops: included 	2570 ♦ 2590 ♦	145.35 145.35	1/2" CC 1/2" IPS	6 6
					

HOW TO ORDER A COMPLETE TUB/SHOWER FAUCET







NOTES











- ♦ Also available in bulk pack. See page 435.
- ♦♦ Available in bulk pack only. See page 435.
-  Moen® **M•PACT**® Common Valve System

Thermostatic Mixing Valve service kits, see page 498.

CHATEAU® Posi-Temp® Showering

		MODEL NUMBER	LIST PRICE	FINISH/ CONNECTION	CASE QTY
POSI-TEMP® SHOWER ONLY					
	<ul style="list-style-type: none"> • ports: four • connection size: 1/2" • connection type: CC • showerhead functions: one-function • showerhead type: standard • showerhead size: 2-1/2" diameter spray head • showerhead flow rate: 2.5 gpm (9.5 L/min) max. • red/blue markings: included • adjustable temp limit stop: included 	2352	152.95	Chrome	12
	<ul style="list-style-type: none"> • ports: four • connection size: 1/2" • connection type: CC • showerhead functions: one-function • showerhead type: standard • showerhead size: 2-1/2" diameter spray head • showerhead flow rate: 2.5 gpm (9.5 L/min) max. • red/blue markings: included • adjustable temp limit stop: included 	L2352	152.95	Chrome	6
	<ul style="list-style-type: none"> • ports: four • connection size: 1/2" • connection type: CC • showerhead functions: one-function • showerhead type: eco-performance showerhead • showerhead size: 2-1/2" diameter spray head • showerhead flow rate: 1.75 gpm (6.65 L/min) max. • red/blue markings: included • adjustable temp limit stop: included 	L2352EP	152.95	Chrome	6
	<ul style="list-style-type: none"> • ports: four • connection size: 1/2" • connection type: CC • showerhead functions: one-function • showerhead type: standard • showerhead size: 2-1/2" diameter spray head • showerhead flow rate: 2.5 gpm (9.5 L/min) max. • red/blue markings: included • adjustable temp limit stop: included • quarter turn stops: included 	L2362	177.80	Chrome	6
	<ul style="list-style-type: none"> • ports: four • connection size: 1/2" • connection type: CC • showerhead functions: one-function • showerhead type: eco-performance showerhead • showerhead size: 2-1/2" diameter spray head • showerhead flow rate: 1.75 gpm (6.65 L/min) max. • red/blue markings: included • adjustable temp limit stop: included • quarter turn stops: included • used to replace: 2 or 3 hole shower valve 	L2368EP	221.15	Chrome	3

CHATEAU® Posi-Temp® Showering

	MODEL NUMBER	LIST PRICE	FINISH/ CONNECTION	CASE QTY
POSI-TEMP® SHOWER ONLY				
 <ul style="list-style-type: none"> • showerhead functions: one-function • showerhead type: standard • showerhead size: 2-1/2" diameter spray head • showerhead flow rate: 2.5 gpm (9.5 L/min) max. • red/blue markings: included • valve: sold separately 	TL182 ♦♦	38.05	Chrome	12
 <ul style="list-style-type: none"> • showerhead functions: one-function • showerhead type: eco-performance showerhead • showerhead size: 2-1/2" diameter spray head • showerhead flow rate: 1.75 gpm (6.65 L/min) max. • red/blue markings: included • valve: sold separately 	TL182EP ♦♦ TL182EPBC ♦	38.05 71.30	Chrome Brushed Chrome	12 12
 <ul style="list-style-type: none"> • showerhead functions: one-function • showerhead type: eco-performance showerhead • showerhead size: 2-1/2" diameter spray head • showerhead flow rate: 1.75 gpm (6.65 L/min) max. • used to replace: 2 or 3 hole shower valve • valve: sold separately 	TL2368EP	80.15	Chrome	6
 <ul style="list-style-type: none"> • description: pressure balanced cycling valve • ports: four • adjustable temp limit stop: included 	2510 ♦ 2520 ♦ 2580 ♦	119.75 119.75 119.75	1/2" IPS 1/2" CC 1/2" Crimp ring PEX	6 6 6
 <ul style="list-style-type: none"> • description: pressure balanced cycling valve • ports: four • adjustable temp limit stop: included • quarter turn stops: included 	2570 ♦ 2590 ♦	145.35 145.35	1/2" CC 1/2" IPS	6 6

HOW TO ORDER A COMPLETE SHOWER FAUCET



NOTES

- ♦ Also available in bulk pack. See page 435.
- ♦♦ Available in bulk pack only. See page 435.
- Ⓜ Moen® **M•PACT**® Common Valve System



CHATEAU® Posi-Temp® Showering

		MODEL NUMBER	LIST PRICE	FINISH/ CONNECTION	CASE QTY
POSI-TEMP® VALVE TRIM WITH VALVE					
	<ul style="list-style-type: none"> • ports: four • connection size: 1/2" • connection type: CC • showerhead type: showerhead sold separately • red/blue markings: included • adjustable temp limit stop: included • quarter turn stops: included 	L2361	166.60	Chrome	6
					
POSI-TEMP® VALVE TRIM ONLY					
	<ul style="list-style-type: none"> • red/blue markings: included • valve: sold separately 	T181 ♦♦	34.55	Chrome	12
					
	<ul style="list-style-type: none"> • red/blue markings: included • valve: sold separately 	TL181 ♦♦	34.55	Chrome	12
	 				
	<ul style="list-style-type: none"> • description: pressure balanced cycling valve • ports: four • adjustable temp limit stop: included 	2510 ♦	119.75	1/2" IPS	6
		2520 ♦	119.75	1/2" CC	6
		2580 ♦	119.75	1/2" Crimp ring PEX	6
	<ul style="list-style-type: none"> • description: pressure balanced cycling valve • ports: four • adjustable temp limit stop: included • quarter turn stops: included 	2570 ♦	145.35	1/2" CC	6
		2590 ♦	145.35	1/2" IPS	6











CHATEAU®

HOW TO ORDER A COMPLETE VALVE



NOTES

- ♦ Also available in bulk pack. See page 435.
- ♦♦ Available in bulk pack only. See page 435.
-  Moen® **M•PACT®** Common Valve System

	MODEL NUMBER	LIST PRICE	FINISH/ CONNECTION	CASE QTY
THREE-HANDLE NON-PRESSURE BALANCED TUB/SHOWER				
 <ul style="list-style-type: none"> • ports: four • connection size: 1/2" • connection type: CC; IPS • showerhead functions: one-function • showerhead type: eco-performance showerhead • showerhead size: 2-1/2" diameter spray head • showerhead flow rate: 1.75 gpm (6.65 L/min) max. • spout length: 5-1/2" • spout connection type: IPS • tub spout type: non diverter 	2995EP	200.65	Chrome	6
TWO-HANDLE NON-PRESSURE BALANCED TUB/SHOWER				
 <ul style="list-style-type: none"> • ports: four • connection size: 1/2" • connection type: CC • showerhead functions: one-function • showerhead type: eco-performance showerhead • showerhead size: 2-1/2" diameter spray head • showerhead flow rate: 1.75 gpm (6.65 L/min) max. • spout length: 5-1/2" • spout connection type: slip fit • tub spout type: diverter 	2919EP	171.45	Chrome	6
 <ul style="list-style-type: none"> • ports: four • connection size: 1/2" • connection type: IPS • showerhead functions: one-function • showerhead type: eco-performance showerhead • showerhead size: 2-1/2" diameter spray head • showerhead flow rate: 1.75 gpm (6.65 L/min) max. • spout length: 5-1/2" • spout connection type: IPS • tub spout type: diverter 	2982EP	171.45	Chrome	6
TWO-HANDLE BIDET				
 <ul style="list-style-type: none"> • center dimensions: 8" - 16" center • valve: sold separately 	TL5265	226.40	Chrome	3
 <ul style="list-style-type: none"> • application: three hole • center dimensions: 8" - 16" center  DURALOCK® DURALAST®	9265	254.45	1/2" IPS	6

HOW TO ORDER A COMPLETE BIDET FAUCET

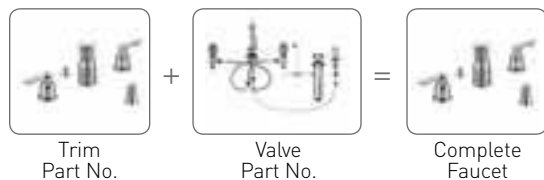

NOTES

- Moën® **M•PACT®** Common Valve System
- DURALOCK®** Duralock® Quick Connections
- DURALAST®** Duralast® Cartridge



Moen® bath accessories CANNOT be combined with Moen® faucet parts on a Purchase Order.

Moen makes it easy to coordinate the entire style and look of the bathroom. Our Mason® bath accessories perfectly match the style and finish of our Chateau® faucets. Total coordination of the bath has never been easier.

For more information on ordering Mason® bath accessories or other matching Moen® bath accessories, contact Moen Bath Accessory Customer Service at **800-882-0116**, contact your local Moen sales representative, or visit us at www.moen.com.

MODEL NUMBER	LIST PRICE EACH	DESCRIPTION	QTY
5/8-in. Round Bar			
Chrome (CH)			
YB8000CH	4.40	Mounting Posts	50
YB8003CH	3.85	Double Robe Hook	50
YB8086CH	7.25	Towel Ring	50
YB8088CH	8.00	Double Paper Holder	25
YB8094CH	3.65	24" Towel Bar Only	50
YB8098CH	3.15	18" Towel Bar Only	50
YB8099CH	1.55	Paper Holder - Roller Only	50
Brushed Chrome (CH)			
YB8000BC	5.60	Mounting Posts	50
YB8003BC	4.90	Double Robe Hook	50
YB8086BC	9.60	Towel Ring	50
YB8094BC	4.70	24" Towel Bar Only	50
YB8098BC	4.00	18" Towel Bar Only	50
YB8099BC	2.65	Paper Holder - Roller Only	50
Satin Nickel			
YB8000SN	7.25	Mounting Posts	50
YB8003SN	5.05	Double Robe Hook	50
YB8086SN	10.40	Towel Ring	50
YB8088SN	13.00	Double Paper Holder	25
YB8094SN	6.05	24" Towel Bar Only	50
YB8098SN	4.80	18" Towel Bar Only	50
YB8099SN	2.30	Paper Holder - Roller Only	50
Old World Bronze			
YB8000OWB	9.40	Mounting Posts	50
YB8003OWB	5.70	Double Robe Hook	50
YB8086OWB	11.10	Towel Ring	50
YB8094OWB	7.45	24" Towel Bar Only	50
YB8098OWB	5.60	18" Towel Bar Only	50
YB8099OWB	1.95	Paper Holder - Roller Only	50
N/A or Unfinished			
YB8081	10.90	30" Pro-Fit Installation Kit	25



YB8003
Double Robe Hook



YB8099
Paper Holder (Roller only)
+
YB8000
Mounting Posts (Pair)



YB8098
18" Towel Bar (Bar only)
+
YB8000
Mounting Posts (Pair)



YB8094
24" Towel Bar (Bar only)
+
YB8000
Mounting Posts (Pair)



YB8086
Towel Ring



YB8088
Double Paper Holder
[3 Mounting Posts, rollers not included]
[Available in CH and SN only]



YB8081
Pro-Fit® Installation Mounting Template [See page 90 for more information about the Pro-Fit® Installation System.]



Custom Showering Options

How-To-Order Spa Shower and Showering Components

U by Moen™ Shower Controller / TS3302TB
Handheld Shower / 3669EPBN
Please see moen.com/consumer-support/warranty
for complete product warranty information.

we are all *connected* these days.



And now, so are our showers.

An invigorating morning blast. A soothing post-workout shower. No matter what your ideal shower, U by Moen™ can be customized to match your preferences and voice activated through compatible Amazon Alexa devices.

With U by Moen, we've forever transformed showering to create a personalized showering experience.



Wi-Fi connected shower controller allows you to change water temperature with pinpoint accuracy or outlets for a more customized shower.



Customize every aspect of your shower and **start, stop and pause it remotely** with the U by Moen smartphone app.



With U by Moen, you can ask **Amazon Alexa to remotely activate your shower** with the sound of your voice. Simply say: Alexa, tell Moen to start preset "Morning Shower."

Compatible with Amazon Alexa.



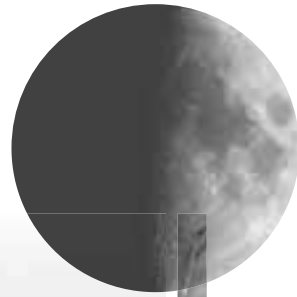

awaken





Velocity® Chrome Two-Function
8" Diameter Spray Head
Rainshower S6320

finding your
sanctuary
should be simple.

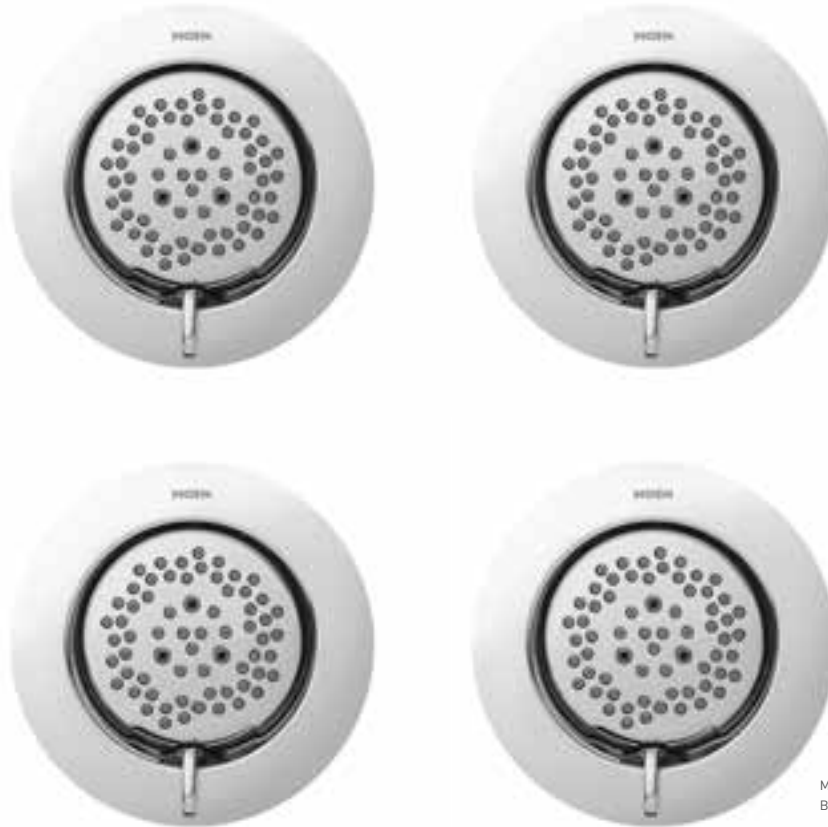

Mosaic™ Chrome
Body Spray TS1422

That's why we're handling it.



Immersion® rainshower technology provides optimal water pressure and excellent coverage for an unparalleled rainshower experience. A unique self-pressurizing system channels water to keep flow consistent and coverage maximized. Let it rain, and let go of everything but pure relaxation. Add body sprays for an all-over spa-like experience.



U by Moen™ Shower Options

Moen has all the components necessary for you to build a custom shower spa. And, we're making it easy for you to pull together the sku numbers you need. Charts of common shower spa configurations are included so that all the components can be ordered. The charts below illustrate one layout and option of showering components. Refer to pages 302 - 377 in the Custom Showering section to choose from our wide array of showering products, styles and finishes to meet your preference. For additional assistance, call your Moen Sales Representative.



U BY MOEN™ SHOWER SPA WITH SHOWERHEAD, HANDSHOWER & FLUSHMOUNT BODY SPRAYS



U by Moen™ four outlet system.

U by Moen four-outlet controller	U by Moen four-outlet valve	Rainshower	Shower arm & flange	Multi-function body spray* & Quantity	Body spray rough-in & Quantity	Four-function handheld shower with slide bar	Drop ell
TS3304TB	S3104	S6310	S122	TS1422 x 4	S1300 x 4	3667EP	A725

* Option: Round single function body spray TS1322

Optional	Product
Battery backup (black)	179573

U BY MOEN™ SHOWER SPA WITH SHOWERHEAD, HANDSHOWER & EXPOSED BODY SPRAYS



U by Moen™ four outlet system.

U by Moen four-outlet controller	U by Moen four-outlet valve	Rainshower	Shower arm & flange	Single function body spray & Quantity	Four-function handheld shower with slide bar	Drop ell
TS3304TB	S3104	S6310	S122	A501 x 4	3667EP	A725

Optional	Product
Battery backup (black)	179573

U by Moen™ Shower Configurations

CUSTOM SHOWERING

U BY MOEN™ SHOWER SPA WITH SHOWERHEAD & FLUSHMOUNT BODY SPRAYS



U by Moen™ two outlet system.

U by Moen two outlet controller	U by Moen two outlet valve	Rainshower	Shower arm & flange	Multi-function body spray* & Quantity	Body spray rough-in & Quantity
TS3302TB	S3102	S6310	S122	TS1422 x 3	S1300 x 3

* Option: Round single function body spray TS1322

Optional	Product
Battery backup (black)	179573

U BY MOEN™ SHOWER SPA WITH SHOWERHEAD & HANDSHOWER



U by Moen™ two outlet system.

U by Moen two outlet controller	U by Moen two outlet valve	Rainshower	Shower arm & flange	Handshower	Drop ell
TS3302TB	S3102	S6310	S122	3667EP	A725

U by Moen™ Shower Configurations

Must order Rough-In-Valve and Trim Pack separately.

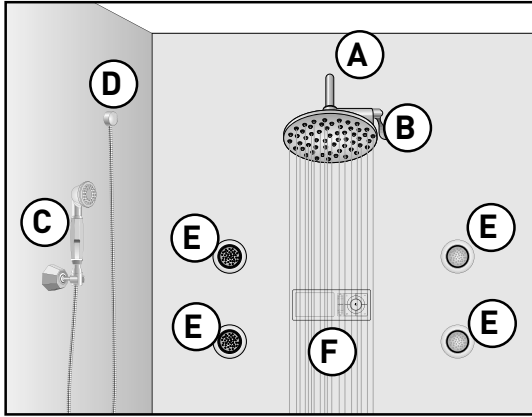
**U by Moen™****SHOWER SPA CONFIGURATION-OPTION A** SKU#**TO ORDER...**

A. (1) Shower Arm & Flange	S113	See page 351
B. (1) Showerhead	S1311	See page 339
C. (1) Hand Shower	3861EP	See page 357
D. (1) Drop Ell	A725	See page 365
E. (4) Rough-in Body Spray Valves (behind the wall, not shown)	S1300	See page 368
E. (4) Body Spray Trims	TS1322*	See page 368
F. (1) Valve (behind the wall, not shown)	S3104	See page 305
F. (1) Controller	TS3304TB	See page 305

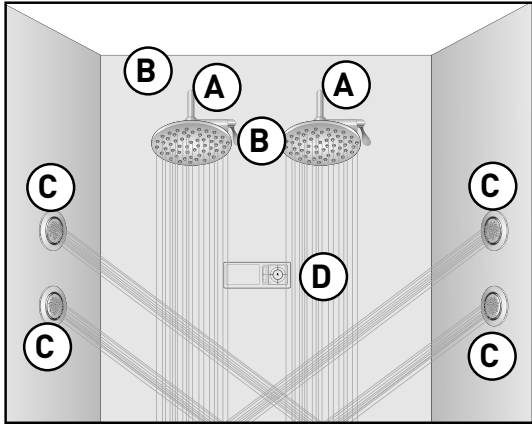
**U by Moen™****SHOWER SPA CONFIGURATION-OPTION B** SKU#**TO ORDER...**

A. (2) Shower Arms & Flanges	S113	See page 351
B. (2) Showerheads	S1311	See page 339
C. (4) Rough-in Body Spray Valves (behind the wall, not shown)	S1300	See page 368
C. (4) Body Spray Trims	TS1322*	See page 368
D. (1) Valve (behind the wall, not shown)	S3104	See page 305
D. (1) Controller	TS3304TB	See page 305

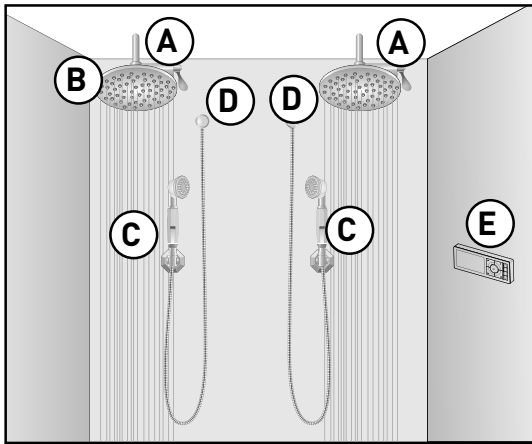





**U by Moen™****SHOWER SPA CONFIGURATION-OPTION C** SKU#**TO ORDER...**

A. (2) Shower Arm	226651	See page 351
A. (2) Shower Arm Flanges	AT2199	See page 353
B. (2) Showerheads	S1311	See page 339
C. (2) Hand Showers	3861EP	See page 357
D. (2) Drop Ells	A725	See page 365
E. (1) Valve (behind the wall, not shown)	S3104	See page 305
E. (1) Controller	TS3304TB	See page 305

*TS1422 Multi-Function body sprays may also be used.

U by Moen™ Shower Configurations

CUSTOM SHOWERING

		MODEL NUMBER	LIST PRICE	FINISH/ CONNECTION	CASE QTY
 <p>U BY MOEN™ 4-OUTLET CONTROLLER</p> <ul style="list-style-type: none"> description: wifi connected, app driven shower controller compatible with Amazon Alexa showerhead type: showerhead sold separately smart phone app: available for Apple iOS and Android OS features: precise temperature control features: remote activation via smart phone app features: warm-up and pause mode features: optional shower timer presets: two on controller, 12 in total with smart phone app valve sold separately 	PREMIUM	TS3304TB	700.00	Terra Beige (TB)	3
	 <p>U BY MOEN™ 4-OUTLET VALVE</p> <ul style="list-style-type: none"> description: digital thermostatic shower valve ports: four outlets features: precise temperature control ports: four outlets connection size: 3/4" inlets & 1/2" outlets installation: fits standard 2x4 wall includes: 30 foot data cable 	PREMIUM	S3104	1,500.00	3/4" CC
179573		65.00	N/A or Unfinished	6	
 <p>U BY MOEN™ 2-OUTLET CONTROLLER</p> <ul style="list-style-type: none"> description: wifi connected, app driven shower controller compatible with Amazon Alexa showerhead type: showerhead sold separately smart phone app: available for Apple iOS and Android OS features: precise temperature control features: remote activation via smart phone app features: warm-up and pause mode features: optional shower timer presets: two on controller, 12 in total with smart phone app valve sold separately 	PREMIUM	TS3302TB	440.00	Terra Beige (TB)	3
	 <p>U BY MOEN™ 2-OUTLET VALVE</p> <ul style="list-style-type: none"> description: digital thermostatic shower valve ports: two outlets features: precise temperature control connection size: 1/2" inlets & 1/2" outlets installation: fits standard 2x4 wall includes: 30 foot data cable 	PREMIUM	S3102	700.00	1/2" CC
179573		65.00	N/A or Unfinished	6	

Valve	Flow Rate @ 20 PSI	Flow Rate @ 40 PSI	Flow Rate @ 60 PSI	Used with 2- or 3-Function Transfer	Maximum Components
U by Moen™ S3104	9.0	13.0	16.0	No	4 Components: Any combination of Showerheads, Handshowers and Bodysprays (4 Max)
U by Moen™ S3102	6.0	8.5	10.0	No	Showerhead, Handshower or Showerhead, 2 Bodysprays

3/4" THERMOSTATIC SHOWERING**ExactTemp® 3/4" Thermostatic Valve and Showering**

Moen has all the components necessary for you to build a custom shower spa. And, we're making it easy for you to pull together the sku numbers you need. Charts of common shower spa configurations are included so that all the components can be ordered. The charts below illustrate one layout and option of showering components. Refer to pages 302 - 377 in the Custom Showering section to choose from our wide array of showering products, styles and finishes to meet your preference. For additional assistance, call your Moen Sales Representative.

**EXACTTEMP® SHOWER SPA WITH SHOWERHEAD, HANDSHOWER & FLUSHMOUNT BODY SPRAYS**

Weymouth® suite shown.

Suite	ExactTemp valve only trim	ExactTemp valve	Volume control trim & Quantity	Volume control valve & Quantity	Showerhead	Shower arm & flange	Multi-function Body Spray* & Quantity	Body spray rough-in	Handheld shower with slide bar	Drop ell
Weymouth®	TS32110	S3371	TS52104 x 3	S3600 x 3	S1311	S113	TS1422 x 4	S1300 x 4	S12107EP	A725
Arris®	TS33002	S3371	TS33003 x 3	S3600 x 3	S112	S110	TS1422 x 4	S1300 x 4	3887EP	A725
Waterhill®	TS3110	S3371	TS514 x 3	S3600 x 3	S112	S113	TS1422 x 4	S1300 x 4	S12107EP	A725
90 °™	TS3100	S3371	TS3300 x 3	S3600 x 3	S6340	S122	TS1420 x 4	S1300 x 4	S3880EP	A721
Rothbury™	TS3760	S3371	TS3820 x 3	S3600 x 3	S6335	S122	TS1422 x 4	S1300 x 4	3869EP	A725
Icon™	TS3900	S3371	TS3200 x 3	S3600 x 3	S6312	S122	TS1422 x 4	S1300 x 4	3887EP	A725
Moen®	TS3411	S3371	TS3600 x 3	S3600 x 3	S6310	S122	TS1422 x 4	S1300 x 4	3667EP	A725

* Option: Round single function body spray TS1322

* Option: Square single function body spray TS1320

ExactTemp® 3/4" Thermostatic Showering Configurations

Must order Rough-In-Valve and Trim Pack separately.

CUSTOM SHOWERING

EXACTTEMP® SHOWER SPA WITH SHOWERHEAD, HANDSHOWER & EXPOSED MOUNT BODY SPRAYS



Weymouth® suite shown.

Suite	ExactTemp valve only trim	ExactTemp valve	Volume control trim & Quantity	Volume control valve & Quantity	Showerhead	Shower arm & flange	Single function body spray & Quantity	Handheld shower with slide bar	Drop ell
Weymouth®	TS32110	S3371	TS52104 x 3	S3600 x 3	S1311	S113	A501 x 4	S12107EP	A725
Arris®	TS33002	S3371	TS33003 x 3	S3600 x 3	S112	S110	A501 x 4	3887EP	A725
Waterhill®	TS3110	S3371	TS514 x 3	S3600 x 3	S112	S113	A501 x 4	S12107EP	A725
90 °TM	TS3100	S3371	TS3300 x 3	S3600 x 3	S6340	S122	A501 x 4	S3880EP	A721
Rothbury™	TS3760	S3371	TS3820 x 3	S3600 x 3	S6335	S122	A501 x 4	3869EP	A725
Icon™	TS3900	S3371	TS3200 x 3	S3600 x 3	S6312	S122	A501 x 4	3887EP	A725
Moen®	TS3411	S3371	TS3600 x 3	S3600 x 3	S6310	S122	A501 x 4	3667EP	A725

* Option: Round single function body spray TS1322

* Option: Square single function body spray TS1320

EXACTTEMP® SHOWER SPA WITH SHOWERHEAD & HANDSHOWER



Rothbury™ suite shown.

Suite	ExactTemp valve only trim	ExactTemp valve	Volume control trim & Quantity	Volume control valve & Quantity	Showerhead	Shower arm & flange	Handheld shower with slide bar	Drop ell
Weymouth®	TS32110	S3371	TS52104 x 2	S3600 x 2	S1311	S113	S12107EP	A725
Arris®	TS33002	S3371	TS33003 x 2	S3600 x 2	S112	S110	3887EP	A725
Waterhill®	TS3110	S3371	TS514 x 2	S3600 x 2	S112	S113	S12107EP	A725
90 °TM	TS3100	S3371	TS3300 x 2	S3600 x 2	S6340	S122	S3880EP	A721
Rothbury™	TS3760	S3371	TS3820 x 2	S3600 x 2	S6335	S122	3869EP	A725
Icon™	TS3900	S3371	TS3200 x 2	S3600 x 2	S6312	S122	3887EP	A725
Moen®	TS3411	S3371	TS3600 x 2	S3600 x 2	S6310	S122	3667EP	A725

* Option: Round single function body spray TS1322

* Option: Square single function body spray TS1320

ExactTemp® 3/4" Thermostatic Showering Configurations

Must order Rough-In-Valve and Trim Pack separately.

All Brushed Nickel faucet components feature the Lifeshine® Non-Tarnish Finish.

Thermostatic — Dials in a pinpoint temperature that automatically adjusts to fluctuations in the water supply for a consistent shower, day after day.

Style — Select from a variety of ExactTemp® 3/4" thermostatic trim and individual volume control styles to fulfill your dream shower.

ExactTemp® offers complete design flexibility. Add up to four different types of spray outlets on up to three walls.

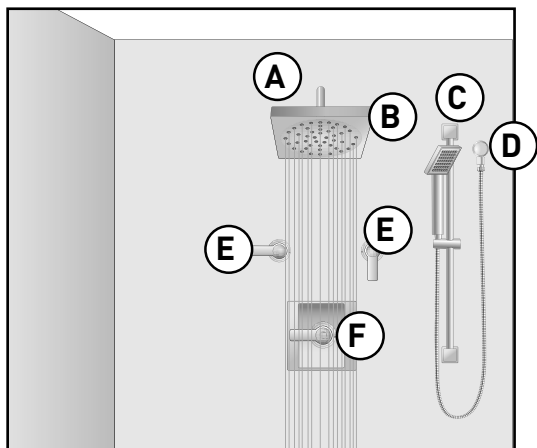

ExactTemp® 3/4" THERMOSTATIC

SHOWER SPA CONFIGURATION-OPTION A

	SKU#	TO ORDER...
A. (1) Shower Arm & Flange	S133	See page 352
B. (1) Showerhead	S6340	See page 341
C. (1) Hand Shower	S3879EP	See page 354
D. (1) Drop Ell	A721	See page 365
E. (2) Volume Control Valves (behind the wall, not shown)	S3600	See page 309
E. (2) Volume Control Trims	TS3300	See page 311
F. (1) ExactTemp® Valve (behind the wall, not shown)	S3371	See page 309
F. (1) ExactTemp® Trim	TS3100	See page 311

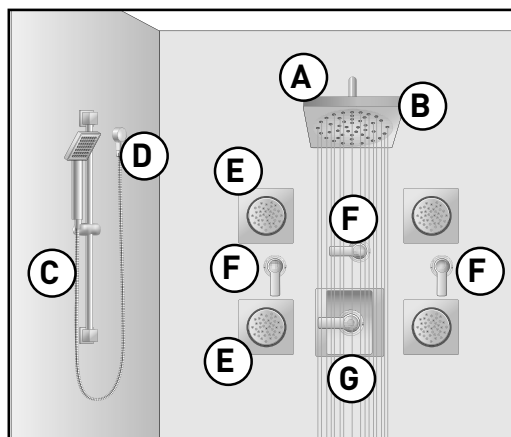

ExactTemp® 3/4" THERMOSTATIC

SHOWER SPA CONFIGURATION-OPTION B

	SKU#	TO ORDER...
A. (1) Shower Arm & Flange	S133	See page 352
B. (1) Showerhead	S6340	See page 341
C. (1) Hand Shower	S3879EP	See page 354
D. (1) Drop Ell	A721	See page 365
E. (4) Rough-in Body Spray Valves (behind the wall, not shown)	S1300	See page 368
E. (4) Body Spray Trims*	TS1320	See page 368
F. (3) Volume Control Valves (behind the wall, not shown)	S3600	See page 309
F. (3) Volume Control Trims	TS3300	See page 311
G. (1) ExactTemp® Valve (behind the wall, not shown)	S3371	See page 309
G. (1) ExactTemp® Trim	TS3100	See page 311

*TS1422 Multi-Function body sprays may also be used.

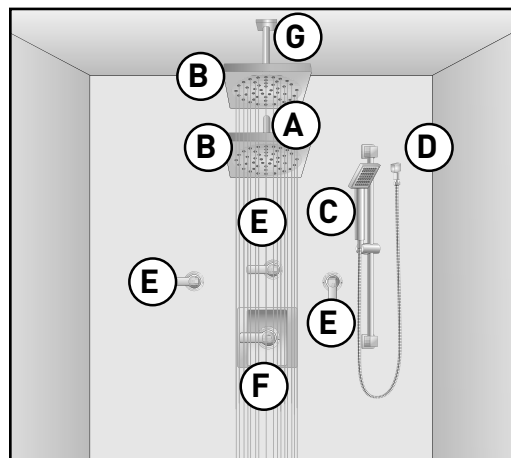

ExactTemp® 3/4" THERMOSTATIC













SHOWER SPA CONFIGURATION-OPTION C

	SKU#	TO ORDER...
A. (1) Shower Arm & Flange	S133	See page 352
B. (2) Showerheads	S6340	See page 341
C. (1) Hand Shower	S3879EP	See page 354
D. (1) Drop Ell	A721	See page 365
E. (3) Volume Control Valves (behind the wall, not shown)	S3600	See page 309
E. (3) Volume Control Trims	TS3300	See page 311
F. (1) ExactTemp® Valve (behind the wall, not shown)	S3371	See page 309
F. (1) ExactTemp® Trim	TS3100	See page 311
G. (1) Shower Arm	226651	See page 351
G. (1) Shower Arm Flange	147572	See page 353

ExactTemp® 3/4" Thermostatic Showering Configurations

Must order Rough-In-Valve and Trim Pack separately.
All Brushed Nickel faucet components feature the Lifeshine® Non-Tarnish Finish.

CUSTOM SHOWERING

		MODEL NUMBER	LIST PRICE	FINISH/ CONNECTION	CASE QTY
 	EXACTTEMP® SHOWER ONLY				
	<ul style="list-style-type: none"> • showerhead functions: one-function • showerhead type: rainshower • showerhead size: 7" diameter spray head • showerhead flow rate: 2.5 gpm (9.5 L/min) max. • requires: separate volume control valve • valve: sold separately 	PREMIUM			
		TS3400	426.05	Chrome	3
		TS3400BN	724.05	Brushed Nickel	3
		TS3400ORB	760.15	Oil Rubbed Bronze	3
	  IMMERSION®				
 	TUB/SHOWER VALVE				
	<ul style="list-style-type: none"> • description: thermostatic rough-in valve • ports: four • adjustable temp limit stop: included • check stops: included 	PREMIUM			
		S3371	508.90	3/4" IPS	6
 	TUB/SHOWER VALVE				
	<ul style="list-style-type: none"> • description: volume control rough-in valve • includes: volume control 	PREMIUM			
		S3600	129.35	3/4" IPS	12
 	TWIN ELL				
	<ul style="list-style-type: none"> • description: twin ell • usage: with tub/shower installations where needed 	128284	25.65	1/2" x 1/2" x 3/4" IPS	12

Diverter tub spout options on page 369 - 373.
Showering extension kits available on page 400.
Matching tub and shower drains available. See page 377.

Valve	Flow Rate through shower port (GPM) @ 20 PSI	Flow Rate through shower port (GPM) @ 40 PSI	Flow Rate through shower port (GPM) @ 60 PSI	Used with 2- or 3-Function Transfer	Maximum Components
3/4" ExactTemp S3371	11.4	15.7	18.0	No	4 Components: Any combination of Showerheads, Handshowers and Bodysprays (4 Max)

HOW TO ORDER A COMPLETE TUB/SHOWER FAUCET







NOTES

-  Moen® **M•PACT®** Common Valve System
-  Immersion® Rainshower

ExactTemp® 3/4" Thermostatic Showering Configurations

Must order Rough-In-Valve and Trim Pack separately.

All Brushed Nickel and Polished Nickel faucet components feature the Lifeshine® Non-Tarnish Finish.

		MODEL NUMBER	LIST PRICE	FINISH/ CONNECTION	CASE QTY
	EXACTTEMP® VALVE ONLY • description: temperature control valve trim • requires: separate volume control valve • valve: sold separately  	PREMIUM			
		TS32110	332.05	Chrome	3
		TS32110BN	488.70	Brushed Nickel	3
		TS32110NL	488.70	Polished Nickel	3
		TS32110ORB	527.15	Oil Rubbed Bronze	3
	EXACTTEMP® VOLUME CONTROL VALVE ONLY • valve: sold separately  	PREMIUM			
		TS52104	172.35	Chrome	6
		TS52104BN	238.10	Brushed Nickel	6
		TS52104NL	238.10	Polished Nickel	6
		TS52104ORB	256.75	Oil Rubbed Bronze	6
	EXACTTEMP® VALVE ONLY • description: temperature control valve trim • requires: separate volume control valve • valve: sold separately  	PREMIUM			
		TS33002	273.00	Chrome	3
		TS33002BN	409.55	Brushed Nickel	3
	EXACTTEMP® VOLUME CONTROL VALVE ONLY • valve: sold separately  	PREMIUM			
		TS33003	155.95	Chrome	6
		TS33003BN	227.55	Brushed Nickel	6
	EXACTTEMP® VALVE ONLY • description: temperature control valve trim • requires: separate volume control valve • valve: sold separately  	PREMIUM			
		TS3110	265.45	Chrome	3
		TS3110BN	390.75	Brushed Nickel	3
		TS3110NL	390.75	Polished Nickel	3
		TS3110ORB	421.60	Oil Rubbed Bronze	3
	EXACTTEMP® VOLUME CONTROL VALVE ONLY • valve: sold separately  	PREMIUM			
		TS514	151.70	Chrome	6
		TS514BN	217.10	Brushed Nickel	6
		TS514NL	217.10	Polished Nickel	6
		TS514ORB	234.30	Oil Rubbed Bronze	6

HOW TO ORDER A COMPLETE FAUCET

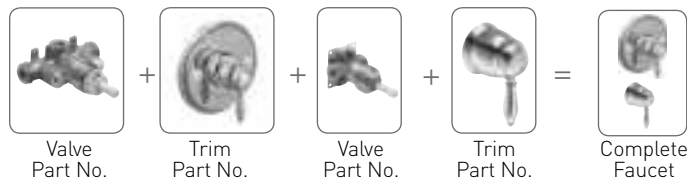

NOTES

 Moen® **M•PACT®** Common Valve System

ExactTemp® 3/4" Thermostatic Showering Configurations

Must order Rough-In-Valve and Trim Pack separately.
All Brushed Nickel faucet components feature the Lifeshine® Non-Tarnish Finish.

CUSTOM SHOWERING

		MODEL NUMBER	LIST PRICE	FINISH/ CONNECTION	CASE QTY
	EXACTTEMP® VALVE ONLY • description: temperature control valve trim • requires: separate volume control valve • valve: sold separately	PREMIUM			
		TS3100	273.90	Chrome	3
		TS3100BN	414.35	Brushed Nickel	3
		 			
	EXACTTEMP® VOLUME CONTROL VALVE ONLY • valve: sold separately	PREMIUM			
		TS3300	126.45	Chrome	6
		TS3300BN	168.60	Brushed Nickel	6
		 			
	EXACTTEMP® VALVE ONLY • description: temperature control valve trim • requires: separate volume control valve • valve: sold separately	PREMIUM			
		TS3760	273.90	Chrome	3
		TS3760BN	414.35	Brushed Nickel	3
		TS37600RB	436.50	Oil Rubbed Bronze	3
 					
	EXACTTEMP® VOLUME CONTROL VALVE ONLY • valve: sold separately	PREMIUM			
		TS3820	126.45	Chrome	6
		TS3820BN	168.60	Brushed Nickel	6
		TS38200RB	177.60	Oil Rubbed Bronze	6
 					
	EXACTTEMP® VALVE ONLY • description: temperature control valve trim • requires: separate volume control valve • valve: sold separately	PREMIUM			
		TS3900	273.90	Chrome	3
		TS3900BN	414.35	Brushed Nickel	3
		 			
	EXACTTEMP® VOLUME CONTROL VALVE ONLY • valve: sold separately	PREMIUM			
		TS3200	126.45	Chrome	6
		TS3200BN	168.60	Brushed Nickel	6
		 			
	EXACTTEMP® VALVE ONLY • description: temperature control valve trim • requires: separate volume control valve • valve: sold separately	PREMIUM			
		TS3411	204.90	Chrome	3
		TS3411BN	321.90	Brushed Nickel	3
		TS34110RB	338.10	Oil Rubbed Bronze	3
 					
	EXACTTEMP® VOLUME CONTROL VALVE ONLY • valve: sold separately	PREMIUM			
		TS3600	105.80	Chrome	6
		TS3600BN	188.25	Brushed Nickel	6
		TS36000RB	197.75	Oil Rubbed Bronze	6
 					

NOTES

 Moen® M•PACT® Common Valve System

MOENTROL® Multi-Function Showering Options

Moen has all the components necessary for you to build a custom shower spa. And, we're making it easy for you to pull together the sku numbers you need. Charts of common shower spa configurations are included so that all the components can be ordered. The charts below illustrate one layout and option of showering components. Refer to pages 302 - 377 in the Custom Showering section to choose from our wide array of showering products, styles and finishes to meet your preference. For additional assistance, call your Moen Sales Representative.



Moentrol® with Integrated Transfer Valve Shower Spa Options

MOENTROL® SHOWER SHOWERHEAD & HANDSHOWER



Rothbury™ suite shown.

Suite	Three-function Moentrol valve only trim	* Three-function Moentrol valve	Showerhead	Shower arm	Shower arm flange	Handshower with slide bar	Drop ell
Rothbury™	TS4211	3330	S6335	123815	AT2199	3869EP	A725
Icon™	TS4112	3330	S6312	123815	AT2199	3887EP	A725
Kingsley®	TS4111	3330	6302	123815	AT2199	3667EP	A725

* 3330 - 2 independent + 1 shared function.

* 3350 - 2 independent functions.

MOENTROL® SHOWER SHOWERHEAD & BODYSPRAYS



Rothbury™ suite shown.

Suite	Three-function Moentrol valve only trim	* Three-function Moentrol valve	Showerhead	Shower arm	Shower arm flange	Body sprays & Quantity
Rothbury™	TS4211	3330	S6335	123815	AT2199	A501 x 2
Icon™	TS4112	3330	S6312	123815	AT2199	A501 x 2
Kingsley®	TS4111	3330	6302	123815	AT2199	A501 x 2

* 3330 - 2 independent + 1 shared function.

* 3350 - 2 independent functions.

With Moentrol, creating your ideal shower is easy. This valve offers you volume and temperature control, which means you can adjust temperature and flow to your desired level without the worries of hot or cold surges.

Moentrol® Multi-Function Showering Options

Moentrol with built-in transfer valves allows the user to add a hand shower or body spray to showerhead to create an affordable, custom, multiple-outlet shower experience.

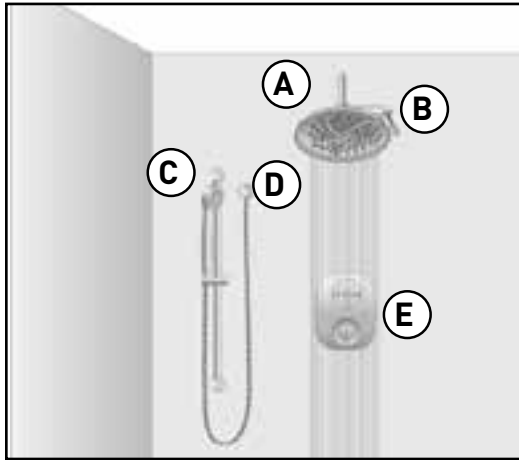

MOENTROL® MULTI-FUNCTION SHOWER SPA CONFIGURATION-OPTION A

	SKU#	TO ORDER...
A. (1) Shower Arm & Flange	S113	See page 351
B. (1) Showerhead	S1311	See page 339
C. (1) Hand Shower	3667EP	See page 355
D. (1) Drop Ell	A725	See page 365
E. (1) Moentrol® MF Valve (behind the wall, not shown)	3330	See page 314
E. (1) Moentrol® MF Trim	TS4211	See page 314

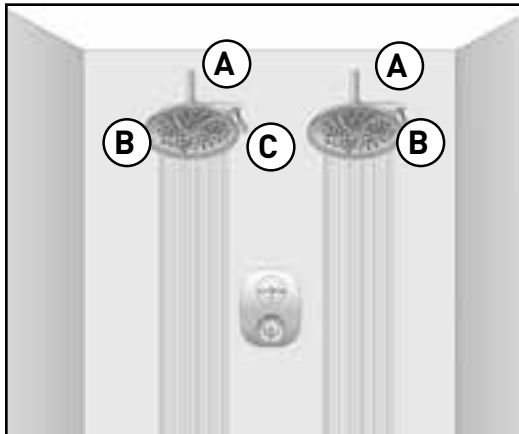

MOENTROL® MULTI-FUNCTION SHOWER SPA CONFIGURATION-OPTION B

	SKU#	TO ORDER...
A. (2) Shower Arms & Flanges	S113	See page 351
B. (2) Showerheads	S1311	See page 339
C. (1) Moentrol® MF Valve	3330	See page 314
C. (1) Moentrol® MF Trim	TS4211	See page 314

Moentrol® with Integrated Transfer Valve Shower Spa Options (continued)

MOENTROL® SHOWER SHOWERHEAD & TUB SPOUT



Rothbury™ suite shown.



Suite	Three-function Moentrol valve only trim	Two-function Moentrol valve	Showerhead	Shower arm	Shower arm flange	Non-diverter tub spout
Rothbury™	TS4211	3350	S6335	123815	AT2199	S3860
Icon™	TS4112	3350	S6312	123815	AT2199	S3842
Kingsley®	TS4111	3350	6302	123815	AT2199	3829



* 3330 - 2 independent + 1 shared function.

* 3350 - 2 independent functions.

Moentrol® Multi-Function Showering Options



All Brushed Nickel and Polished Brass faucet components feature the Lifeshine® Non-Tarnish Finish.



		MODEL NUMBER	LIST PRICE	FINISH/ CONNECTION	CASE QTY
M-PACT®	MOENTROL® WITH TRANSFER VALVE	• ports: four; two outlets	3320	275.85 1/2" IPS inlets/cc outlets	6
		• adjustable temp limit stop: included	3330	275.85 1/2" CC	6
		• check stops: included			
		• type of function: two independent one shared			
		• includes: volume control			
		• not recommended: for tub spout application			
					



M-PACT®	MOENTROL® WITH TRANSFER VALVE	• ports: four; two outlets	3350	275.85 1/2" CC	6
		• adjustable temp limit stop: included			
		• check stops: included			
		• type of function: two independent functions			
		• includes: volume control			
		• not recommended: for tub spout application			
					

Valve	Flow Rate through shower port (GPM) @ 20 PSI	Flow Rate through shower port (GPM) @ 40 PSI	Flow Rate through shower port (GPM) @ 60 PSI	Used with 2- or 3-Function Transfer	Maximum Components
3-Function Moentrol 3320, 3330, 3350	*3.0	*4.2	*5.2	No	Showerhead, Handshower or Showerhead, 2 Bodysprays

*3-Function Moentrol flow is the total flow when used in the shared mode

ROTHBURY™	MOENTROL® WITH TRANSFER VALVE	PREMIUM				
		• showerhead type: showerhead sold separately	TS4211	234.30	Chrome	3
	• valve sold separately	TS4211BN	320.80	Brushed Nickel	3	
			TS4211ORB	337.90	Oil Rubbed Bronze	3

ICON™	MOENTROL® WITH TRANSFER VALVE	PREMIUM			
		• showerhead type: showerhead sold separately	TS4112	190.15	Chrome
	• valve sold separately	TS4112BN	260.35	Brushed Nickel	3
					

KINGSLEY®	MOENTROL® WITH TRANSFER VALVE	• showerhead type: showerhead sold separately	T4111	159.40	Chrome	3
		• valve sold separately	T4111BN	214.10	Brushed Nickel	3
			T4111ORB	235.50	Oil Rubbed Bronze	3
			T4111P	236.45	Polished Brass	3

MOEN®	TWIN ELL			
	• description: twin ell	128284	25.65	1/2" x 1/2" x 3/4" IPS
	• usage: with tub/shower installations where needed			

HOW TO ORDER MOENTROL SHOWER WITH TRANSFER VALVE

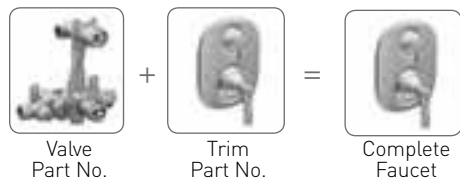

NOTES

 Moen® **M•PACT®** Common Valve System

Moentrol® Shower Spa with Annex™ Shower Rail Showering Components

Moен has all the components necessary for you to build a custom shower spa. And, we're making it easy for you to pull together the sku numbers you need. Charts of common shower spa configurations are included so that all the components can be ordered. The charts below illustrate one layout and option of showering components. Refer to pages 302 - 377 in the Custom Showering section to choose from our wide array of showering products, styles and finishes to meet your preference. For additional assistance, call your Moen Sales Representative.



MOENTROL® SHOWER SPA WITH ANNEX™ SHOWER RAIL



Rothbury™ suite shown.

Suite	Moentrol valve only trim	Showerhead	Shower arm (optional)	Moentrol valve	Annex shower rail	Handshower
Weymouth®	TS33001	S1311EP	S113	3570	TS3661NH	154305
Arris®	TS32001	S112EP	S110	3570	TS3661NH	155891
90 °™	TS3711	S6340EP		3570	TS3661NH	189575
Rothbury	TS3211	S6335EP		3570	TS3661NH	164927
Icon™	TS2154	S6312EP		3570	TS3661NH	155891
Wynford®	T5501	S6310EP	161951	3570	TS3661NH	164927
Align®	T3291	S176EP		3570	TS3661NH	155981
Voss™	T3691	S6365EP	161951	3570	TS3661NH	189318
Belfield™	T3311	S6310EP		3570	TS3661NH	164927
Kingsley®	T3111	6302EP		3570	TS3661NH	164927

MOENTROL® AND STANDARD Transfer Valve Showering Components

Moen has all the components necessary for you to build a custom shower spa. And, we're making it easy for you to pull together the sku numbers you need. Charts of common shower spa configurations are included so that all the components can be ordered. The charts below illustrate one layout and option of showering components. Refer to pages 302 - 377 in the Custom Showering section to choose from our wide array of showering products, styles and finishes to meet your preference. For additional assistance, call your Moen Sales Representative.



MOENTROL® SHOWERHEAD & TUB SPOUT



Rothbury™ suite shown.

Suite	Moentrol shower only trim	Showerhead	Moentrol valve	Transfer valve trim	Two-function transfer valve	Non-diverter tub spout
Weymouth®	TS33102NH	S1311	3570	TS32205	3375	S12105
Arris®	TS32002NH	S112	3570	TS23005	3375	S16900
90 °™	TS3715		3570	TS4172	3375	S3898
Rothbury	TS3212		3570	TS5205	3375	S3860
Icon™	TS2155		3570	T4171	3375	S3842
Wynford®	T5502		3570	T4511	3375	195386
Align®	T3292		3570	T4191	3375	3892
Voss™	T3692		3570	T4611	3375	191956
Belfield™	T3312NH	S6310	3570	T4301	3375	3858
Kingsley®	T3112		3570	T4311	3375	3829

Moentrol® with Transfer Valve Showering Options

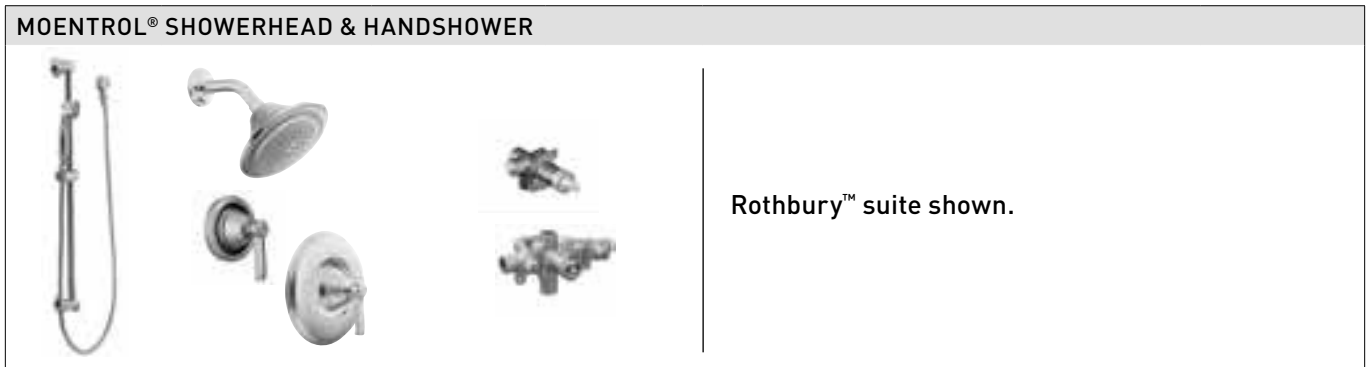

Suite	Moentrol shower only trim	Showerhead	Moentrol valve	Transfer valve trim	* Three-function transfer valve	Handshower with slide bar	Drop ell
Weymouth®	TS33102NH	S1311	3570	TS32205	3372	S12107EP	A725
Arris®	TS32002NH	S112	3570	TS23005	3372	3887EP	A725
90 °™	TS3715		3570	TS4172	3372	S3880EP	A721
Rothbury	TS3212		3570	TS5205	3372	3869EP	A725
Icon™	TS2155		3570	T4171	3372	3887EP	A725
Wynford®	T5502		3570	T4511	3372	3667EP	A725
Align®	T3292		3570	T4191	3372	3887EP	A725
Voss™	T3692		3570	T4611	3372	3988EP	A721
Belfield™	T3312NH	S6310	3570	T4301	3372	3667EP	A725
Kingsley®	T3112		3570	T4311	3372	3869EP	A725

* 3372 has 2 distinct functions + 1 shared function.
 * 3375 has 2 distinct functions

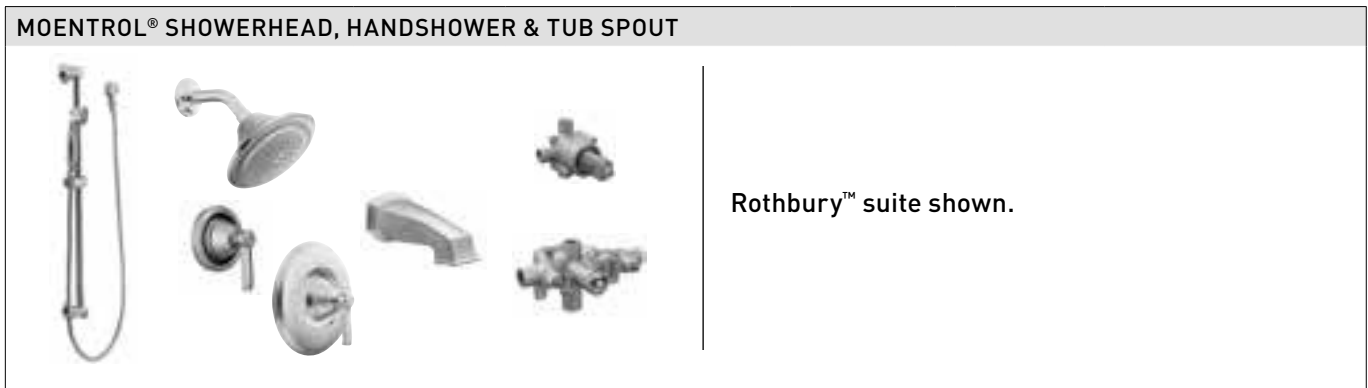

Suite	Moentrol shower only trim	Showerhead	Moentrol valve	Transfer valve trim	Three-function transfer valve	Handshower with slide bar	Drop ell	Non-diverter tub spout
Weymouth®	TS33102NH	S1311	3570	TS32205	3362	S12107EP	A725	S12105
Arris®	TS32002NH	S112	3570	TS23005	3362	3887EP	A725	S16900
90 °™	TS3715		3570	TS4172	3362	S3880EP	A721	S3898
Rothbury	TS3212		3570	TS5205	3362	3869EP	A725	S3860
Icon™	TS2155		3570	T4171	3362	3887EP	A725	S3842
Wynford®	T5502		3570	T4511	3362	3667EP	A725	195386
Align®	T3292		3570	T4191	3362	3887EP	A725	3892
Voss™	T3692		3570	T4611	3362	3988EP	A721	191956
Belfield™	T3312NH	S6310	3570	T4301	3362	3667EP	A725	3858
Kingsley®	T3112		3570	T4311	3362	3869EP	A725	3829

Moentrol® with Transfer Valve Showering Options

Use the three-function or two-function transfer valve with a Moentrol® or Posi-Temp® mixing valve to customize your shower by including hand showers, showerheads, or body sprays in addition to your tub/shower combo.

Now available in six matching trim suite styles or the neutral style that works well with any trim suite of your choice to add flexibility.

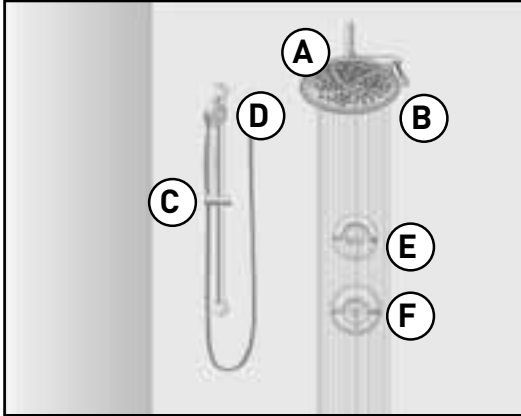

MOENTROL® AND TRANSFER VALVE

SHOWER SPA CONFIGURATION-OPTION A	SKU#	TO ORDER...
A. (1) Shower Arm & Flange	S113	See page 351
B. (1) Showerhead	S1311	See page 339
C. (1) Hand Shower with Slidebar	3667EP	See page 355
D. (1) Drop Ell	A725	See page 365
E. (1) Transfer Valve	3372	See page 319
(1) Transfer Valve Trim	TS5205	See page 321
F. (1) Moentrol® Valve	3520	See page 319
(1) Moentrol® Valve Trim	TS3211	See page 323

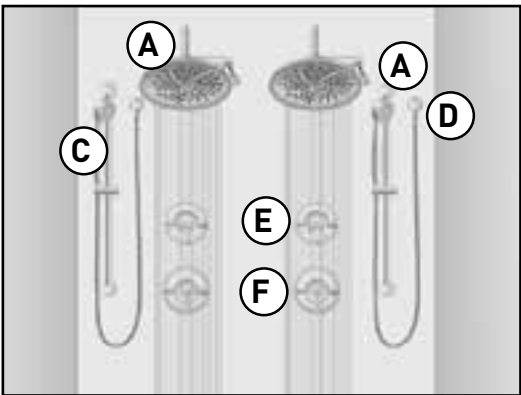













MOENTROL® AND TRANSFER VALVE

SHOWER SPA CONFIGURATION-OPTION A	SKU#	TO ORDER...
A. (2) Shower Arms & Flanges	S113	See page 351
B. (2) Showerheads	S1311	See page 339
C. (2) Hand Showers	3667EP	See page 355
D. (2) Drop Ells	A725	See page 365
E. (2) Transfer Valves	3372	See page 319
(2) Transfer Valve Trims	TS5205	See page 321
F. (2) Moentrol® Valves	3520	See page 319
(2) Moentrol® Valve Trims	TS3211	See page 323

Moentrol® Valve Showering Components

Must order Rough-In-Valve and Trim Pack separately.

CUSTOM SHOWERING

		MODEL NUMBER	LIST PRICE	FINISH/ CONNECTION	CASE QTY
M-PACT®	MOENTROL® VALVE ONLY				
	<ul style="list-style-type: none"> description: pressure balanced valve with volume control ports: four adjustable temp limit stop: included checks: included includes: volume control 	3520	164.10	1/2" CC	6
		3510	164.10	1/2" IPS	6
	 				
M-PACT®	MOENTROL® VALVE ONLY				
	<ul style="list-style-type: none"> description: pressure balanced valve with volume control ports: four adjustable temp limit stop: included check stops: included includes: volume control 	3570 ♦	195.50	1/2" CC	6
	 				
MOEN®	3 INDEPENDENT FUNCTION TRANSFER VALVE ONLY				
	<ul style="list-style-type: none"> ports: four type of function: three independent function must be used with: Posi-Temp® or Moentrol® valve 	3362	192.60	1/2" CC	6
					
MOEN®	2/3 FUNCTION TRANSFER VALVE ONLY				
	<ul style="list-style-type: none"> type of function: two independent one shared must be used with: Posi-Temp® or Moentrol® valve 	3372	172.00	1/2" CC	12
					
MOEN®	2 FUNCTION TRANSFER VALVE ONLY				
	<ul style="list-style-type: none"> type of function: two independent functions must be used with: Posi-Temp® or Moentrol® valve 	3375	172.00	1/2" CC	12
					
MOEN®	TWIN ELL				
	<ul style="list-style-type: none"> description: twin ell usage: with tub/shower installations where needed 	128284	25.65	1/2" x 1/2" x 3/4" IPS	12

Valve	Flow Rate through shower port (GPM) @ 20 PSI	Flow Rate through shower port (GPM) @ 40 PSI	Flow Rate through shower port (GPM) @ 60 PSI	Used with 2- or 3-Function Transfer	Maximum Components
Moentrol® 3520, 3510, 3570	3.5	5.0	6.3	Yes	Showerhead, Handshower or Showerhead, 2 Bodysprays

Use 3362, 3372 or 3375 in conjunction with either a Posi-Temp® or Moentrol® shower valve.

NOTES

♦ Also available in bulk pack. See page 435.

 Moen® **M-PACT®** Common Valve System

Transfer Valve Showering Components

Must order Rough-In-Valve and Trim Pack separately.

All Brushed Nickel and Polished Nickel faucet components feature the Lifeshine® Non-Tarnish Finish.

		MODEL NUMBER	LIST PRICE	FINISH/ CONNECTION	CASE QTY	
ANNEX™ 	SHOWER RAIL <ul style="list-style-type: none"> • connection size: 1/2" • connection type: IPS • showerhead type: showerhead sold separately • handshower type: handshower sold separately • type of function: two independent functions • hose length: 59" 	PREMIUM				
			TS3661NH	461.90	Chrome	3
			NEW! TS3661NHBN	729.70	Brushed Nickel	3
			NEW! TS3661NHBL	769.95	Matte Black	3
			NEW! TS3661NHORB	769.95	Oil Rubbed Bronze	3
WEYMOUTH® 	3 INDEPENDENT FUNCTION TRANSFER VALVE ONLY <ul style="list-style-type: none"> • use with 3362 transfer valve • valve: sold separately 	PREMIUM				
			TS32206	249.95	Chrome	12
			TS32206BN	294.70	Brushed Nickel	12
			TS32206NL	294.70	Polished Nickel	12
			TS32206ORB	317.95	Oil Rubbed Bronze	12
ARRIS® 	3 INDEPENDENT FUNCTION TRANSFER VALVE ONLY <ul style="list-style-type: none"> • use with 3362 transfer valve • valve: sold separately 	PREMIUM				
			TS23006	232.25	Chrome	12
			TS23006BN	287.85	Brushed Nickel	12
90 DEGREE™ 	3 INDEPENDENT FUNCTION TRANSFER VALVE ONLY <ul style="list-style-type: none"> • use with 3362 transfer valve • valve: sold separately 	PREMIUM				
			TS4173	143.05	Chrome	12
			TS4173BN	193.20	Brushed Nickel	12
VIA® 	3 INDEPENDENT FUNCTION TRANSFER VALVE ONLY <ul style="list-style-type: none"> • use with 3362 transfer valve • valve: sold separately 	PREMIUM				
			TS2172	136.45	Chrome	12
WYNFORD® 	3 INDEPENDENT FUNCTION TRANSFER VALVE ONLY <ul style="list-style-type: none"> • use with 3362 transfer valve • valve: sold separately 	PREMIUM				
			T4512	106.50	Chrome	12
			T4512BN	143.10	Brushed Nickel	12
			T4512NL	143.10	Polished Nickel	12
			T4512ORB	157.40	Oil Rubbed Bronze	12
ALIGN® 	3 INDEPENDENT FUNCTION TRANSFER VALVE ONLY <ul style="list-style-type: none"> • use with 3362 transfer valve • valve: sold separately 	PREMIUM				
			T4192	106.50	Chrome	12
			NEW! T4192BN	143.10	Brushed Nickel	12
			NEW! T4192BL	157.40	Matte Black	12

NOTES

 Moen® **M•PACT®** Common Valve System

Transfer Valve Showering Components

Must order Rough-In-Valve and Trim Pack separately.
All Brushed Nickel and Polished Nickel faucet components feature the Lifeshine® Non-Tarnish Finish.

CUSTOM SHOWERING

		MODEL NUMBER	LIST PRICE	FINISH/ CONNECTION	CASE QTY
VOSS™ 3 INDEPENDENT FUNCTION TRANSFER VALVE ONLY					
 <ul style="list-style-type: none"> • use with 3362 transfer valve • valve: sold separately 		T4612	106.50	Chrome	12
		T4612BN	143.10	Brushed Nickel	12
		T4612ORB	157.40	Oil Rubbed Bronze	12
WEYMOUTH® 2/3 FUNCTION TRANSFER VALVE ONLY					
 <ul style="list-style-type: none"> • use with 3372 or 3375 transfer valve • valve: sold separately 		PREMIUM			
		TS32205	249.95	Chrome	6
		TS32205BN	294.70	Brushed Nickel	6
		TS32205NL	294.70	Polished Nickel	6
		TS32205ORB	317.95	Oil Rubbed Bronze	6
ARRIS® 2/3 FUNCTION TRANSFER VALVE ONLY					
 <ul style="list-style-type: none"> • use with 3372 or 3375 transfer valve • valve: sold separately 		PREMIUM			
		TS23005	232.25	Chrome	6
		TS23005BN	287.85	Brushed Nickel	6
90 DEGREE™ 2/3 FUNCTION TRANSFER VALVE ONLY					
 <ul style="list-style-type: none"> • use with 3372 or 3375 transfer valve • valve: sold separately 		PREMIUM			
		TS4172	143.05	Chrome	6
		TS4172BN	193.20	Brushed Nickel	6
VIA® 2/3 FUNCTION TRANSFER VALVE ONLY					
 <ul style="list-style-type: none"> • use with 3372 or 3375 transfer valve • valve: sold separately 		PREMIUM			
		TS2171	136.45	Chrome	12
ROTHBURY™ 2/3 FUNCTION TRANSFER VALVE ONLY					
 <ul style="list-style-type: none"> • use with 3372 or 3375 transfer valve • valve: sold separately 		PREMIUM			
		TS5205	153.60	Chrome	6
		TS5205BN	205.35	Brushed Nickel	6
		TS5205ORB	216.35	Oil Rubbed Bronze	6
ALIGN® 2/3 FUNCTION TRANSFER VALVE ONLY					
 <ul style="list-style-type: none"> • use with 3372 or 3375 transfer valve • valve: sold separately 		T4191	106.50	Chrome	12
		T4191BN	143.10	Brushed Nickel	12
		T4191BL	157.40	Matte Black	12

HOW TO ORDER MOENTROL SHOWER WITH TRANSFER VALVE

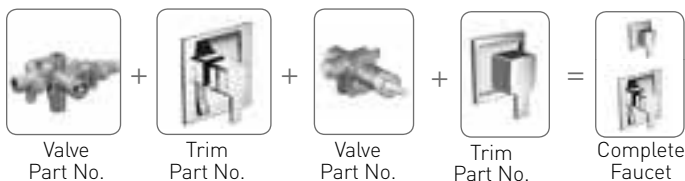















NOTES

 Moen® **M•PACT®** Common Valve System

Transfer Valve Showering Components

Must order Rough-In-Valve and Trim Pack separately.
All Brushed Nickel faucet components feature the Lifeshine® Non-Tarnish Finish.

		MODEL NUMBER	LIST PRICE	FINISH/ CONNECTION	CASE QTY
WYNFORD® 2/3 FUNCTION TRANSFER VALVE ONLY					
  	<ul style="list-style-type: none"> • use with 3372 or 3375 transfer valve • valve: sold separately 	T4511	106.50	Chrome	12
		T4511BN	143.10	Brushed Nickel	12
		T4511NL	143.10	Polished Nickel	12
		T4511ORB	157.40	Oil Rubbed Bronze	12
VOSS™ 2/3 FUNCTION TRANSFER VALVE ONLY					
  	<ul style="list-style-type: none"> • use with 3372 or 3375 transfer valve • valve: sold separately 	T4611	106.50	Chrome	12
		T4611BN	143.10	Brushed Nickel	12
		T4611ORB	157.40	Oil Rubbed Bronze	12
BELFIELD™ 2/3 FUNCTION TRANSFER VALVE ONLY					
  	<ul style="list-style-type: none"> • use with 3372 or 3375 transfer valve • valve: sold separately 	T4301	102.60	Chrome	12
		T4301BN	137.85	Brushed Nickel	12
		T4301ORB	151.65	Oil Rubbed Bronze	12
KINGSLEY® 2/3 FUNCTION TRANSFER VALVE ONLY					
  	<ul style="list-style-type: none"> • use with 3372 or 3375 transfer valve • valve: sold separately 	T4311	106.50	Chrome	6
		T4311BN	143.10	Brushed Nickel	6
		T4311ORB	157.40	Oil Rubbed Bronze	6
MOEN® 2/3 FUNCTION TRANSFER VALVE ONLY					
  	<ul style="list-style-type: none"> • use with 3372 or 3375 transfer valve • valve: sold separately 	T4171	105.80	Chrome	6
		T4171BN	142.25	Brushed Nickel	6
		T4171ORB	156.50	Oil Rubbed Bronze	6

HOW TO ORDER MOENTROL SHOWER WITH TRANSFER VALVE

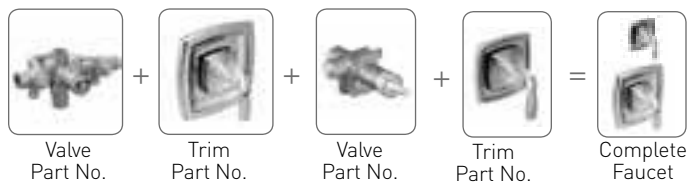



NOTES

 Moen® **M•PACT®** Common Valve System

Moentrol® Valve Showering Components

Must order Rough-In-Valve and Trim Pack separately.
All Brushed Nickel and Polished Nickel faucet components feature the Lifeshine® Non-Tarnish Finish.

CUSTOM SHOWERING

		MODEL NUMBER	LIST PRICE	FINISH/ CONNECTION	CASE QTY	
WEYMOUTH® 	MOENTROL® VALVE ONLY					
	• valve: sold separately					
			PREMIUM			
			TS33101	291.00	Chrome	3
			TS33101BN	410.30	Brushed Nickel	3
ARRIS® 	MOENTROL® VALVE ONLY					
	• valve: sold separately					
			PREMIUM			
			TS32001	258.15	Chrome	3
			TS32001BN	384.65	Brushed Nickel	3
90 DEGREE™ 	MOENTROL® VALVE ONLY					
	• valve: sold separately					
			PREMIUM			
			TS3711	175.05	Chrome	3
			TS3711BN	435.90	Brushed Nickel	3
ROTHBURY™ 	MOENTROL® VALVE ONLY					
	• valve: sold separately					
			PREMIUM			
			TS3211	183.75	Chrome	3
			TS3211BN	457.70	Brushed Nickel	3
ICON® 	MOENTROL® VALVE ONLY					
	• valve: sold separately					
			PREMIUM			
			TS2154	146.70	Chrome	3
			TS2154BN	348.70	Brushed Nickel	3
WYNFORD® 	MOENTROL® VALVE ONLY					
	• valve: sold separately					
			PREMIUM			
			T5501	137.50	Chrome	3
			T5501BN	292.90	Brushed Nickel	3

HOW TO ORDER MOENTROL SHOWER WITH TRANSFER VALVE

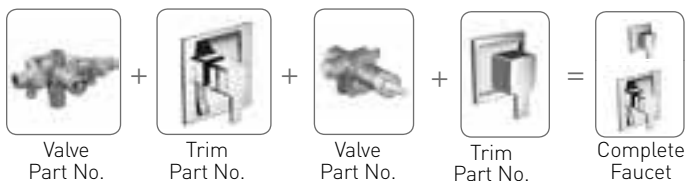





NOTES

 Moen® **M•PACT®** Common Valve System

Moentrol® Valve Showering Components

Must order Rough-In-Valve and Trim Pack separately.

All Brushed Nickel and Polished Brass faucet components feature the Lifeshine® Non-Tarnish Finish.

		MODEL NUMBER	LIST PRICE	FINISH/ CONNECTION	CASE QTY
	MOENTROL® VALVE ONLY • valve: sold separately	T3291	137.50	Chrome	3
		T3291BN	292.90	Brushed Nickel	3
	MOENTROL® VALVE ONLY • valve: sold separately	T3691	137.50	Chrome	3
		T3691BN	292.90	Brushed Nickel	3
		T3691ORB	322.25	Oil Rubbed Bronze	3
	MOENTROL® VALVE ONLY • valve: sold separately	T3311	118.50	Chrome	3
		T3311BN	276.50	Brushed Nickel	3
		T3311ORB	304.15	Oil Rubbed Bronze	3
	MOENTROL® VALVE ONLY • valve: sold separately	T3111	123.00	Chrome	3
		T3111BN	287.00	Brushed Nickel	3
		T3111ORB	315.70	Oil Rubbed Bronze	3
		T3111P	333.45	Polished Brass	3

NOTES

 Moen® **M•PACT®** Common Valve System

POSI-TEMP® Shower Spa with Annex™ Shower Rail Showering Components

Moen has all the components necessary for you to build a custom shower spa. And, we're making it easy for you to pull together the sku numbers you need. Charts of common shower spa configurations are included so that all the components can be ordered. The charts below illustrate one layout and option of showering components. Refer to pages 302 - 377 in the Custom Showering section to choose from our wide array of showering products, styles and finishes to meet your preference. For additional assistance, call your Moen Sales Representative.



POSI-TEMP® SHOWER SPA WITH ANNEX™ SHOWER RAIL



Rothbury™ suite shown.

Suite	Posi-Temp valve only trim	Showerhead	Shower arm (optional)	Posi-Temp valve	Annex shower rail	Handshower
Weymouth®	TS3210	S1311EP	S113	2520	TS3661NH	154305
Arris®	TS22001	S112EP	S110	2520	TS3661NH	155891
Waterhil®	TS310	S112EP	S113	2520	TS3661NH	176015
90 °™	TS2711	S6340EP		2520	TS3661NH	189575
Via®	TS8711	S6365EP		2520	TS3661NH	189318
Rothbury™	TS2211	S6335EP		2520	TS3661NH	164927
Icon™	TS2141	S6312EP		2520	TS3661NH	155891
Wynford®	T4501	S6310EP	161951	2520	TS3661NH	164927
Align®	T2191	S176EP		2520	TS3661NH	155981
Voss™	T2691	S6365EP	161951	2520	TS3661NH	189318
Belfield™	T2311	S6310EP		2520	TS3661NH	164927
Kingsley®	T2111	6302EP		2520	TS3661NH	164927
Rizon®	T2811	6345		2520	TS3661NH	189318
Dartmoor™	T2181	6345		2520	TS3661NH	164927
Glyde™	T2741	6345		2520	TS3661NH	155981
Vichy™	T2661	6345		2520	TS3661NH	164928
Brantford®	T2151	6345		2520	TS3661NH	164927
Eva®	T2131	6345		2520	TS3661NH	164928
Method™	T2801	6345		2520	TS3661NH	164928
Gibson™	T2901	6345		2520	TS3661NH	164928
Genta™	T2471	6345		2520	TS3661NH	189318
Chateau®	TL181	6345		2520	TS3661NH	164928

Posi-Temp® with Transfer Valve Showering Options

POSI-TEMP® AND STANDARD Transfer Valve Showering Components

Moen has all the components necessary for you to build a custom shower spa. And, we're making it easy for you to pull together the sku numbers you need. Charts of common shower spa configurations are included so that all the components can be ordered. The charts below illustrate one layout and option of showering components. Refer to pages 302 - 377 in the Custom Showering section to choose from our wide array of showering products, styles and finishes to meet your preference. For additional assistance, call your Moen Sales Representative.



POSI-TEMP® SHOWERHEAD HANDSHOWER & TUB SPOUT



Weymouth® suite shown.

Suite	Posi-Temp shower only trim	Posi-Temp valve	Transfer valve trim	Three-function transfer valve	Handshower with slide bar	Drop ell	Non-diverter tub spout
Weymouth®	TS32102	2520	TS32206	3362	S12107EP	A725	S12105
Arris®	TS22002	2520	TS23006	3362	3887EP	A725	S16900
90 °™	TS2712	2520	TS4173	3362	S3880EP	A721	S3898
Via®	TS8712	2520	TS2172	3362	3988EP	A721	S3901
Wynford®	T4502	2520	T4512	3362	3667EP	A725	195386
Align®	T2192	2520	T4192	3362	3887EP	A725	3892
Voss™	T2692	2520	T4612	3362	3988EP	A721	191956
Rizon®	T2812	2520	T2082	3362	3988EP	A721	3829
Gibson™	T3002EP	2520	T2922	3362	3669EP	A725	3892
Genta™	T2472EP	2520	T2402	3362	3988EP	A721	3829

Posi-Temp® with Transfer Valve Showering Options

CUSTOM SHOWERING

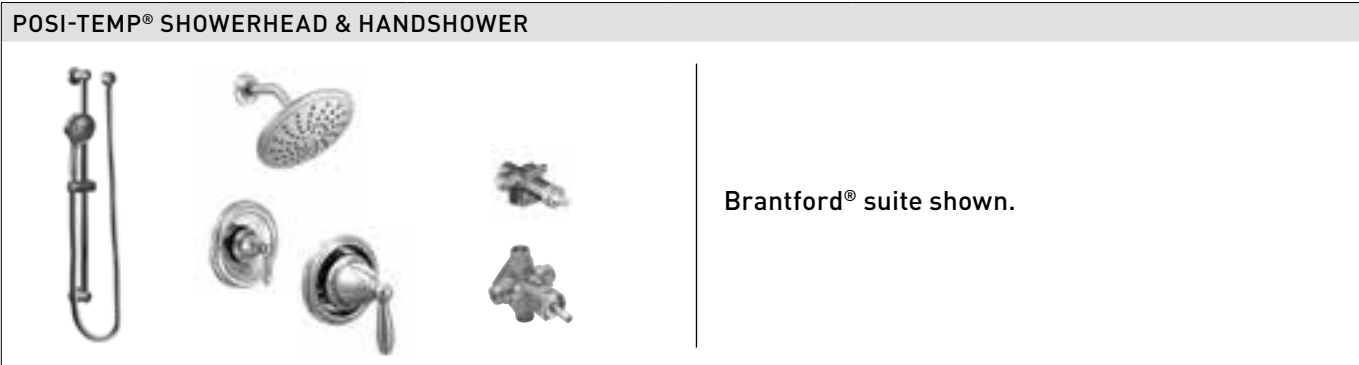

Suite	Posi-Temp shower only trim	Posi-Temp valve	Transfer valve trim	* Three-function transfer valve	Handshower with slide bar	Drop ell
Weymouth®	TS32102	2520	TS32205	3372	S12107EP	A725
Arris®	TS22002	2520	TS23005	3372	3887EP	A725
Waterhill®	TS312	2520	TS325	3372	3869EP	A725
90 °™	TS2712	2520	TS4172	3372	S3880EP	A721
Via®	TS8712	2520	TS2171	3372	3988EP	A721
Rothbury™	TS2212	2520	TS5205	3372	3869EP	A725
Icon™	TS2142	2520	T4171	3372	3887EP	A725
Wynford®	T4502	2520	T4511	3372	3667EP	A725
Align®	T2192	2520	T4191	3372	3887EP	A725
Voss™	T2692	2520	T4611	3372	3988EP	A721
Belfield™	T2312	2520	T4301	3372	3667EP	A725
Kingsley®	T2112	2520	T4311	3372	3869EP	A725
Rizon®	T2812	2520	T2081	3372	3988EP	A721
Dartmoor™	T2282EP	2520	T2031	3372	3667EP	A725
Glyde™	T2842EP	2520	T2721	3372	3887EP	A725
Vichy™	T2662EP	2520	T4171	3372	3669EP	A725
Brantford®	T2252EP	2520	T2021	3372	3667EP	A725
Eva®	T2232EP	2520	T2011	3372	3669EP	A725
Method™	T2802	2520	T4171	3372	3669EP	A725
Gibson™	T3002EP	2520	T2921	3372	3669EP	A725
Genta™	T2472EP	2520	T2401	3372	3988EP	A721
Chateau®	TL182	2520	T4171	3372	3669EP	A725

* 3372 has 2 distinct functions + 1 shared function.
 * 3375 has 2 distinct functions

Posi-Temp® with Transfer Valve Showering Options

Use the three-function or two-function transfer valve with a Moentrol® or Posi-Temp® mixing valve to customize your shower by including hand showers, showerheads, or body sprays in addition to your tub/shower combo.

Now available in six matching trim suite styles or the neutral style that works well with any trim suite of your choice to add flexibility.

POSI-TEMP® SHOWERHEAD & TUB SPOUT



Weymouth® suite shown.

Suite	Posi-Temp shower only trim	Posi-Temp valve	Transfer valve trim	Two-function transfer valve	Non-diverter tub spout
Weymouth®	TS32102	2520	TS32205	3375	S12105
Arris®	TS22002	2520	TS23005	3375	S16900
Waterhill®	TS312	2520	TS325	3375	3858
90 °™	TS2712	2520	TS4172	3375	S3898
Via®	TS8712	2520	TS2171	3375	S3901
Rothbury™	TS2212	2520	TS5205	3375	S3860
Icon™	TS2142	2520	T4171	3375	S3842
Wynford®	T4502	2520	T4511	3375	195386
Align®	T2192	2520	T4191	3375	3892
Voss™	T2692	2520	T4611	3375	191956
Belfield™	T2312	2520	T4301	3375	3858
Kingsley®	T2112	2520	T4311	3375	3829
Rizon®	T2812	2520	T2081	3375	3829
Dartmoor™	T2282EP	2520	T2031	3375	3858
Glyde™	T2842EP	2520	T2721	3375	3829
Vichy™	T2662EP	2520	T4171	3375	3892
Brantford®	T2252EP	2520	T2021	3375	3858
Eva®	T2232EP	2520	T2011	3375	3829
Method™	T2802	2520	T4171	3375	3829
Gibson™	T3002EP	2520	T2921	3375	3892
Genta™	T2472EP	2520	T2401	3375	3829
Chateau®	TL182	2520	T4171	3375	3829

Posi-Temp® with Transfer Valve Showering Options

Use the three-function or two-function transfer valve with a Moentrol® or Posi-Temp® mixing valve to customize your shower by including hand showers, showerheads, or body sprays in addition to your tub/shower combo.

Now available in six matching trim suite styles or the neutral style that works well with any trim suite of your choice to add flexibility.

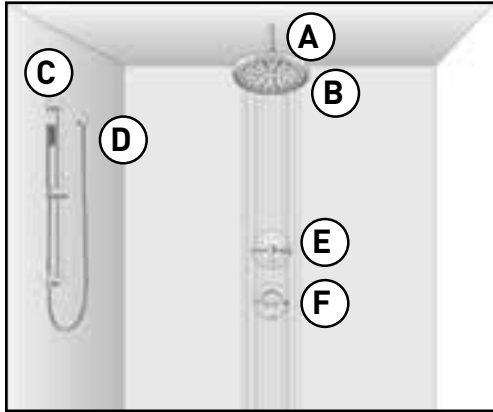

POSI-TEMP AND TRANSFER VALVE

SHOWER SPA CONFIGURATION-OPTION A

	SKU#	TO ORDER...
A. (1) Shower Arm	226651	See page 351
A. (1) Flange	AT2199	See page 353
B. (1) Showerhead	S6310	See page 341
C. (1) Hand Shower	3887EP	See page 356
D. (1) Drop Ell	A725	See page 365
E. (1) Transfer Valve (behind wall not shown)	3375	See page 319
E. (1) Transfer Valve Trim	TS5205	See page 321
F. (1) Posi-Temp® Valve (behind wall not shown)	2520	See page 330
F. (1) Posi-Temp® Valve Trim	TS2211	See page 335

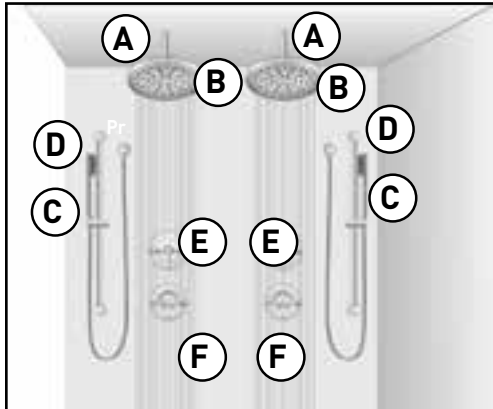













POSI-TEMP AND TRANSFER VALVE

SHOWER SPA CONFIGURATION-OPTION B

	SKU#	TO ORDER...
A. (2) Shower Arms	226651	See page 351
A. (2) Flanges	AT2199	See page 353
B. (2) Showerheads	S6310	See page 341
C. (2) Hand Showers	3887EP	See page 356
D. (2) Drop Ells	A725	See page 365
E. (2) Transfer Valves (behind wall not shown)	3375	See page 319
E. (2) Transfer Valve Trims	TS5205	See page 321
F. (2) Posi-Temp® Valves (behind wall not shown)	2520	See page 330
F. (2) Posi-Temp® Valve Trims	TS2211	See page 335

Posi-Temp® Valve Showering Components

Must order Rough-In-Valve and Trim Pack separately.

		MODEL NUMBER	LIST PRICE	FINISH/ CONNECTION	CASE QTY
M-PACT®	3 INDEPENDENT FUNCTION TRANSFER VALVE ONLY				
	• description: pressure balanced cycling valve	2520 ♦	119.75	1/2" CC	6
	• ports: four	2510 ♦	119.75	1/2" IPS	6
	• adjustable temp limit stop: included				
	 				
M-PACT®	2/3 FUNCTION TRANSFER VALVE ONLY				
	• description: pressure balanced cycling valve	2590 ♦	145.35	1/2" IPS	6
	• ports: four	2580 ♦	119.75	1/2" Crimp ring PEX	6
	• adjustable temp limit stop: included	2570 ♦	145.35	1/2" CC	6
	• quarter turn stops: included				
	 				
MOEN®	3 INDEPENDENT FUNCTION TRANSFER VALVE ONLY				
	• ports: four	3362	192.60	1/2" CC	6
	• type of function: three independent function				
	• must be used with: Posi-Temp® or Moentrol® valve				
					
MOEN®	2/3 FUNCTION TRANSFER VALVE ONLY				
	• type of function: two independent one shared	3372	172.00	1/2" CC	12
	• must be used with: Posi-Temp® or Moentrol® valve				
					
MOEN®	2 FUNCTION TRANSFER VALVE ONLY				
	• type of function: two independent functions	3375	172.00	1/2" CC	12
	• must be used with: Posi-Temp® or Moentrol® valve				
					
MOEN®	TWIN ELL				
	• description: twin ell	128284	25.65	1/2" x 1/2" x 3/4" IPS	12
	• usage: with tub/shower installations where needed				

Valve	Flow Rate through shower port (GPM) @ 20 PSI	Flow Rate through shower port (GPM) @ 40 PSI	Flow Rate through shower port (GPM) @ 60 PSI	Used with 2- or 3-Function Transfer	Maximum Components
Posi-Temp® 2520, 2510, 2570	2.1	3.2	4.0	Yes	Showerhead, Handshower

Use 3362, 3372 or 3375 in conjunction with either a Posi-Temp® or Moentrol® shower valve.

HOW TO ORDER POSI-TEMP SHOWER WITH TRANSFER VALVE

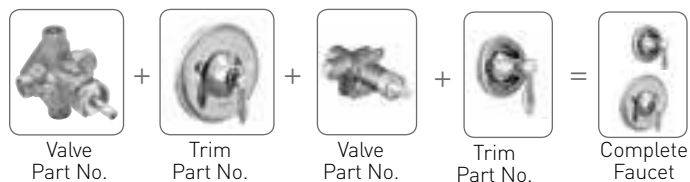

NOTES

- ♦ Also available in bulk pack. See page 435.
- Ⓜ Moen® **M•PACT**® Common Valve System

Transfer Valve Showering Components

Must order Rough-In-Valve and Trim Pack separately.
All Brushed Nickel and Polished Nickel faucet components feature the Lifeshine® Non-Tarnish Finish.

		MODEL NUMBER	LIST PRICE	FINISH/ CONNECTION	CASE QTY	
ANNEX™ SHOWER RAIL						
	<ul style="list-style-type: none"> • connection size: 1/2" • connection type: IPS • showerhead type: showerhead sold separately • handshower type: handshower sold separately • type of function: two independent functions • hose length: 59" 	PREMIUM				
			TS3661NH	461.90	Chrome	3
		NEW!	TS3661NHBN	729.70	Brushed Nickel	3
		NEW!	TS3661NHBL	769.95	Matte Black	3
		NEW!	TS3661NHORB	769.95	Oil Rubbed Bronze	3
WEYMOUTH® 3 INDEPENDENT FUNCTION TRANSFER VALVE ONLY						
	<ul style="list-style-type: none"> • use with 3362 transfer valve • valve: sold separately 	PREMIUM				
			TS32206	249.95	Chrome	12
		 	TS32206BN	294.70	Brushed Nickel	12
			TS32206NL	294.70	Polished Nickel	12
			TS32206ORB	317.95	Oil Rubbed Bronze	12
ARRIS® 3 INDEPENDENT FUNCTION TRANSFER VALVE ONLY						
	<ul style="list-style-type: none"> • use with 3362 transfer valve • valve: sold separately 	PREMIUM				
			TS23006	232.25	Chrome	12
		 	TS23006BN	287.85	Brushed Nickel	12
90 DEGREE™ 3 INDEPENDENT FUNCTION TRANSFER VALVE ONLY						
	<ul style="list-style-type: none"> • use with 3362 transfer valve • valve: sold separately 	PREMIUM				
			TS4173	143.05	Chrome	12
		 	TS4173BN	193.20	Brushed Nickel	12
VIA® 3 INDEPENDENT FUNCTION TRANSFER VALVE ONLY						
	<ul style="list-style-type: none"> • use with 3362 transfer valve • valve: sold separately 	PREMIUM				
			TS2172	136.45	Chrome	12
		 				
WYNFORD® 3 INDEPENDENT FUNCTION TRANSFER VALVE ONLY						
	<ul style="list-style-type: none"> • use with 3362 transfer valve • valve: sold separately 	PREMIUM				
			T4512	106.50	Chrome	12
		 	T4512BN	143.10	Brushed Nickel	12
			T4512NL	143.10	Polished Nickel	12
			T4512ORB	157.40	Oil Rubbed Bronze	12
ALIGN® 3 INDEPENDENT FUNCTION TRANSFER VALVE ONLY						
	<ul style="list-style-type: none"> • use with 3362 transfer valve • valve: sold separately 	PREMIUM				
			T4192	106.50	Chrome	12
		 	NEW! T4192BN	143.10	Brushed Nickel	12
			NEW! T4192BL	157.40	Matte Black	12

NOTES

 Moen® **M•PACT®** Common Valve System

Transfer Valve Showering Components

Must order Rough-In-Valve and Trim Pack separately.









All Brushed Nickel and Polished Nickel faucet components feature the Lifeshine® Non-Tarnish Finish.

		MODEL NUMBER	LIST PRICE	FINISH/ CONNECTION	CASE QTY
VOSS™ 	3 INDEPENDENT FUNCTION TRANSFER VALVE ONLY <ul style="list-style-type: none"> • use with 3362 transfer valve • valve: sold separately  	T4612	106.50	Chrome	12
		T4612BN	143.10	Brushed Nickel	12
		T4612ORB	157.40	Oil Rubbed Bronze	12
RIZON® 	3 INDEPENDENT FUNCTION TRANSFER VALVE ONLY <ul style="list-style-type: none"> • use with 3362 transfer valve • valve: sold separately  	T2082	106.50	Chrome	12
		T2082BN	143.10	Brushed Nickel	12
GIBSON™ 	3 INDEPENDENT FUNCTION TRANSFER VALVE ONLY <ul style="list-style-type: none"> • use with 3362 transfer valve • valve: sold separately  	T2922	90.50	Chrome	12
GENTA™ 	3 INDEPENDENT FUNCTION TRANSFER VALVE ONLY <ul style="list-style-type: none"> • use with 3362 transfer valve • valve: sold separately  	T2402	90.50	Chrome	12
WEYMOUTH® 	2/3 FUNCTION TRANSFER VALVE <ul style="list-style-type: none"> • use with 3372 or 3375 transfer valve • valve: sold separately  	PREMIUM			
		TS32205	249.95	Chrome	6
		TS32205BN	294.70	Brushed Nickel	6
		TS32205NL	294.70	Polished Nickel	6
		TS32205ORB	317.95	Oil Rubbed Bronze	6
ARRIS® 	2/3 FUNCTION TRANSFER VALVE <ul style="list-style-type: none"> • use with 3372 or 3375 transfer valve • valve: sold separately  	PREMIUM			
		TS23005	232.25	Chrome	6
		TS23005BN	287.85	Brushed Nickel	6
WATERHILL® 	2/3 FUNCTION TRANSFER VALVE <ul style="list-style-type: none"> • use with 3372 or 3375 transfer valve • valve: sold separately  	PREMIUM			
		TS325	223.35	Chrome	6
		TS325BN	271.55	Brushed Nickel	6
		TS325NL	271.55	Polished Nickel	6
		TS325ORB	293.00	Oil Rubbed Bronze	6
TS325WR	293.00	Wrought Iron	6		
90 DEGREE™ 	2/3 FUNCTION TRANSFER VALVE <ul style="list-style-type: none"> • use with 3372 or 3375 transfer valve • valve: sold separately  	PREMIUM			
		TS4172	143.05	Chrome	6
		TS4172BN	193.20	Brushed Nickel	6
		NOTES			

Transfer Valve Showering Components

Must order Rough-In-Valve and Trim Pack separately.
All Brushed Nickel and Polished Nickel faucet components feature the Lifeshine® Non-Tarnish Finish.

CUSTOM SHOWERING

		MODEL NUMBER	LIST PRICE	FINISH/ CONNECTION	CASE QTY
VIA® 	2/3 FUNCTION TRANSFER VALVE • use with 3372 or 3375 transfer valve • valve: sold separately  	PREMIUM			
		TS2171	136.45	Chrome	12
ROTHBURY® 	2/3 FUNCTION TRANSFER VALVE • use with 3372 or 3375 transfer valve • valve: sold separately  	PREMIUM			
		TS5205	153.60	Chrome	6
		TS5205BN	205.35	Brushed Nickel	6
		TS5205ORB	216.35	Oil Rubbed Bronze	6
WYNFORD® 	2/3 FUNCTION TRANSFER VALVE • use with 3372 or 3375 transfer valve • valve: sold separately  	T4511	106.50	Chrome	12
		T4511BN	143.10	Brushed Nickel	12
		T4511NL	143.10	Polished Nickel	12
		T4511ORB	157.40	Oil Rubbed Bronze	12
ALIGN® 	2/3 FUNCTION TRANSFER VALVE • use with 3372 or 3375 transfer valve • valve: sold separately  	T4191	106.50	Chrome	12
		T4191BN	143.10	Brushed Nickel	12
		T4191BL	157.40	Matte Black	12
VOSS™ 	2/3 FUNCTION TRANSFER VALVE • use with 3372 or 3375 transfer valve • valve: sold separately  	T4611	106.50	Chrome	12
		T4611BN	143.10	Brushed Nickel	12
		T4611ORB	157.40	Oil Rubbed Bronze	12
BELFIELD™ 	2/3 FUNCTION TRANSFER VALVE • use with 3372 or 3375 transfer valve • valve: sold separately  	T4301	102.60	Chrome	12
		T4301BN	137.85	Brushed Nickel	12
		T4301ORB	151.65	Oil Rubbed Bronze	12
KINGSLEY® 	2/3 FUNCTION TRANSFER VALVE • use with 3372 or 3375 transfer valve • valve: sold separately  	T4311	106.50	Chrome	6
		T4311BN	143.10	Brushed Nickel	6
		T4311ORB	157.40	Oil Rubbed Bronze	6
RIZON® 	2/3 FUNCTION TRANSFER VALVE • use with 3372 or 3375 transfer valve • valve: sold separately  	T2081	106.50	Chrome	12
		T2081BN	143.10	Brushed Nickel	12

NOTES

 Moen® **M•PACT®** Common Valve System

Transfer Valve Showering Components

Must order Rough-In-Valve and Trim Pack separately.

All Brushed Nickel faucet components feature the Lifeshine® Non-Tarnish Finish.

		MODEL NUMBER	LIST PRICE	FINISH/ CONNECTION	CASE QTY
DARTMOOR™ 	2/3 FUNCTION TRANSFER VALVE <ul style="list-style-type: none"> • use with 3372 or 3375 transfer valve • valve: sold separately  	T2031	90.50	Chrome	12
		T2031BN	121.60	Brushed Nickel	12
		T2031ORB	133.80	Oil Rubbed Bronze	12
		NEW!			
GLYDE™ 	2/3 FUNCTION TRANSFER VALVE <ul style="list-style-type: none"> • use with 3372 or 3375 transfer valve • valve: sold separately  	T2721	90.50	Chrome	6
		T2721BN	121.60	Brushed Nickel	6
		NEW!			
BRANTFORD® 	2/3 FUNCTION TRANSFER VALVE <ul style="list-style-type: none"> • use with 3372 or 3375 transfer valve • valve: sold separately  	T2021	90.50	Chrome	12
		T2021BN	121.60	Brushed Nickel	12
		T2021ORB	133.80	Oil Rubbed Bronze	12
		NEW!			
EVA® 	2/3 FUNCTION TRANSFER VALVE <ul style="list-style-type: none"> • use with 3372 or 3375 transfer valve • valve: sold separately  	T2011	90.50	Chrome	12
		T2011BN	121.60	Brushed Nickel	12
		T2011ORB	133.80	Oil Rubbed Bronze	12
		NEW!			
GIBSON™ 	2/3 FUNCTION TRANSFER VALVE <ul style="list-style-type: none"> • use with 3372 or 3375 transfer valve • valve: sold separately  	T2921	90.50	Chrome	12
		NEW!			
GENTA™ 	2/3 FUNCTION TRANSFER VALVE <ul style="list-style-type: none"> • use with 3372 or 3375 transfer valve • valve: sold separately  	T2401	90.50	Chrome	12
		NEW!			
MOEN® 	2/3 FUNCTION TRANSFER VALVE <ul style="list-style-type: none"> • use with 3372 or 3375 transfer valve • valve: sold separately  	T4171	105.80	Chrome	6
		T4171BN	142.25	Brushed Nickel	6
		T4171ORB	156.50	Oil Rubbed Bronze	6
		NEW!			

NOTES



















 Moen® **M•PACT®** Common Valve System

Posi-Temp® Transfer Valve Showering Components

Must order Rough-In-Valve and Trim Pack separately.

All Brushed Nickel and Polished Nickel faucet components feature the Lifeshine® Non-Tarnish Finish.

CUSTOM SHOWERING

		MODEL NUMBER	LIST PRICE	FINISH/ CONNECTION	CASE QTY
WEYMOUTH® 	POSI-TEMP® VALVE ONLY • valve: sold separately  	PREMIUM			
		TS3210	274.60	Chrome	3
		TS3210BN	388.35	Brushed Nickel	3
		TS3210NL	388.35	Polished Nickel	3
		TS3210ORB	419.10	Oil Rubbed Bronze	3
ARRIS® 	POSI-TEMP® VALVE ONLY • valve: sold separately  	PREMIUM			
		TS22001	255.20	Chrome	3
		TS22001BN	379.50	Brushed Nickel	3
WATERHILL® 	POSI-TEMP® VALVE ONLY • valve: sold separately  	PREMIUM			
		TS310	248.15	Chrome	3
		TS310BN	362.10	Brushed Nickel	3
		TS310NL	362.10	Polished Nickel	3
		TS310ORB	390.70	Oil Rubbed Bronze	3
90 DEGREE™ 	POSI-TEMP® VALVE ONLY • valve: sold separately  	PREMIUM			
		TS2711	162.55	Chrome	3
		TS2711BN	301.00	Brushed Nickel	3
VIA® 	POSI-TEMP® VALVE ONLY • red/blue markings: included • valve: sold separately  	PREMIUM			
		TS8711	155.15	Chrome	3
ROTHBURY™ 	POSI-TEMP® VALVE ONLY • valve: sold separately  	PREMIUM			
		TS2211	170.70	Chrome	3
		TS2211BN	316.00	Brushed Nickel	3
		TS2211ORB	332.90	Oil Rubbed Bronze	3

Use 3372 or 3375 in conjunction with either a Posi-Temp® or Moentrol® shower valve.

HOW TO ORDER POSI-TEMP SHOWER WITH TRANSFER VALVE

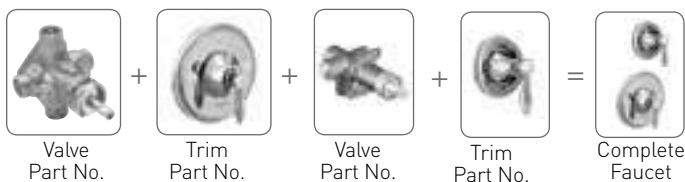

NOTES

 Moen® **M•PACT®** Common Valve System

Posi-Temp® Valve Showering Components

Must order Rough-In-Valve and Trim Pack separately.

All Brushed Nickel, Polished Nickel and Polished Brass faucet components feature the Lifeshine® Non-Tarnish Finish.

		MODEL NUMBER	LIST PRICE	FINISH/ CONNECTION	CASE QTY
	POSI-TEMP® VALVE ONLY • valve: sold separately  	PREMIUM			
		TS2141	138.45	Chrome	3
		TS2141BN	256.45	Brushed Nickel	3
	POSI-TEMP® VALVE ONLY • valve: sold separately  	T4501	116.15	Chrome	3
		T4501BN	210.90	Brushed Nickel	3
		T4501NL	210.90	Polished Nickel	3
		T4501ORB	232.05	Oil Rubbed Bronze	3
	POSI-TEMP® VALVE ONLY • red/blue markings: included • valve: sold separately  	T2191	116.15	Chrome	3
		T2191BN	210.90	Brushed Nickel	3
		T2191BL	232.05	Matte Black	3
	POSI-TEMP® VALVE ONLY • valve: sold separately  	T2691	116.15	Chrome	3
		T2691BN	210.90	Brushed Nickel	3
		T2691ORB	232.05	Oil Rubbed Bronze	3
	POSI-TEMP® VALVE ONLY • valve: sold separately  	T2311	111.90	Chrome	3
		T2311BN	203.20	Brushed Nickel	3
		T2311ORB	223.55	Oil Rubbed Bronze	3
	POSI-TEMP® VALVE ONLY • valve: sold separately  	T2111	116.15	Chrome	3
		T2111BN	210.90	Brushed Nickel	3
		T2111ORB	232.05	Oil Rubbed Bronze	3
		T2111WR	232.05	Wrought Iron	3
		T2111P	313.75	Polished Brass	3

HOW TO ORDER POSI-TEMP SHOWER WITH TRANSFER VALVE

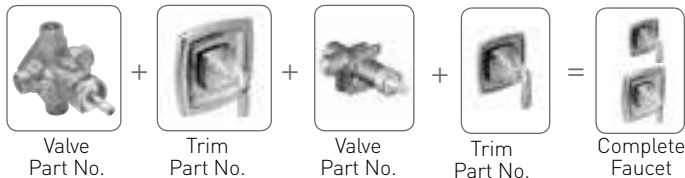

















NOTES

 Moen® **M•PACT®** Common Valve System

Posi-Temp® Valve Showering Components

Must order Rough-In-Valve and Trim Pack separately.
All Brushed Nickel faucet components feature the Lifeshine® Non-Tarnish Finish.

CUSTOM SHOWERING

		MODEL NUMBER	LIST PRICE	FINISH/ CONNECTION	CASE QTY
RIZON® 	POSI-TEMP® VALVE ONLY • red/blue markings: included • valve: sold separately  	T2811	116.15	Chrome	3
		T2811BN	210.90	Brushed Nickel	3
DARTMOOR™ 	POSI-TEMP® VALVE ONLY • valve: sold separately  	T2181	44.35	Chrome	3
		T2181BN	125.15	Brushed Nickel	3
		T2181ORB	137.65	Oil Rubbed Bronze	3
GLYDE™ 	POSI-TEMP® VALVE ONLY • valve: sold separately  	T2741	44.35	Chrome	3
		T2741BN	125.15	Brushed Nickel	3
VICHY™ 	POSI-TEMP® VALVE ONLY • red/blue markings: included • valve: sold separately  	T2661	53.65	Chrome	3
BRANTFORD® 	POSI-TEMP® VALVE ONLY • valve: sold separately  	T2151	54.80	Chrome	3
		T2151BN	125.15	Brushed Nickel	3
		T2151ORB	137.65	Oil Rubbed Bronze	3
EVA® 	POSI-TEMP® VALVE ONLY • valve: sold separately  	T2131	54.80	Chrome	3
		T2131BN	125.15	Brushed Nickel	3
		T2131ORB	137.65	Oil Rubbed Bronze	3

HOW TO ORDER POSI-TEMP SHOWER WITH TRANSFER VALVE

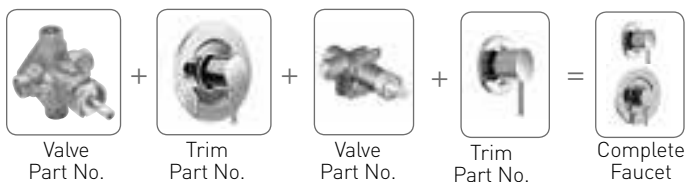













NOTES

 Moen® **M•PACT®** Common Valve System

Posi-Temp® Valve Showering Components

Must order Rough-In-Valve and Trim Pack separately.
All Brushed Nickel faucet components feature the Lifeshine® Non-Tarnish Finish.

METHOD™	POSI-TEMP® VALVE ONLY	MODEL NUMBER	LIST PRICE	FINISH/ CONNECTION	CASE QTY
	<ul style="list-style-type: none"> • red/blue markings: included • valve: sold separately  	T2801	54.80	Chrome	3
		T2801BN	125.15	Brushed Nickel	3
	<ul style="list-style-type: none"> • red/blue markings: included • valve: sold separately  	T2901	53.65	Chrome	3
	<ul style="list-style-type: none"> • red/blue markings: included • valve: sold separately  	T2471	53.65	Chrome	3
	<ul style="list-style-type: none"> • red/blue markings: included • valve: sold separately  	TL181	34.55	Chrome	12

HOW TO ORDER POSI-TEMP SHOWER WITH TRANSFER VALVE

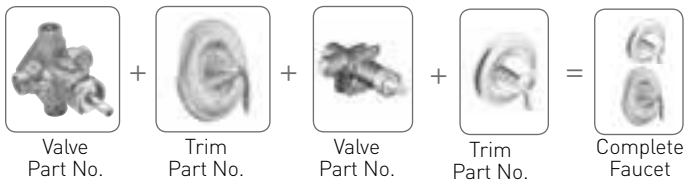

NOTES

 Moen® **M•PACT®** Common Valve System

Showerheads

All Brushed Nickel and Polished Nickel faucet components feature the Lifeshine® Non-Tarnish Finish.

CUSTOM SHOWERING

1.5 GPM SHOWERING OPTIONS				
MODEL NUMBER	DESCRIPTION	LIST PRICE	FINISH/CONNECTION	CASE QTY.
S6340EP15	Rainshower	167.55	Chrome	3
S6340EP15BN	Rainshower	230.40	Brushed Nickel	3
S6335EP15	Fixed Showerhead	131.35	Chrome	6
6302EP15	Fixed Showerhead	85.70	Chrome	12
6399EP15	Fixed Showerhead	84.70	Chrome	12
6399EP15BL	Fixed Showerhead	145.50	Matte Black	12
6313	Fixed Showerhead	47.40	Chrome	12
6313BN	Fixed Showerhead	72.60	Brushed Nickel	12
6313ORB	Fixed Showerhead	79.85	Oil Rubbed Bronze	12
6300EP15	Fixed Showerhead	33.20	Chrome	12
157276EP15	Handheld Shower	58.70	Chrome	6
157276EP15BN	Handheld Shower	85.15	Brushed Nickel	6
157276EP15ORB	Handheld Shower	93.70	Oil Rubbed Bronze	6

MODEL NUMBER	LIST PRICE	FINISH/CONNECTION	CASE QTY
--------------	------------	-------------------	----------

RAINSHOWER



- connection size: 1/2"
- connection type: IPS
- showerhead functions: two-function
- showerhead type: rainshower
- showerhead size: 9" diameter spray head
- type of function: concentrated rinse; full spray
- flow rate: 2.5 gpm (9.5 L/min) max.

PREMIUM			
MODEL NUMBER	LIST PRICE	FINISH/CONNECTION	CASE QTY
S1311	402.70	Chrome	3
S1311BN	549.65	Brushed Nickel	3
S1311NL	549.65	Polished Nickel	3
S1311ORB	604.55	Oil Rubbed Bronze	3

IMMERSION



- connection size: 1/2"
- connection type: IPS
- showerhead functions: two-function
- showerhead type: eco-performance rainshower
- showerhead size: 9" diameter spray head
- type of function: full spray; concentrated rinse
- flow rate: 2.0 transitioning to 1.75 gpm

PREMIUM			
MODEL NUMBER	LIST PRICE	FINISH/CONNECTION	CASE QTY
S1311EP	402.70	Chrome	3
S1311EPBN	549.65	Brushed Nickel	3
S1311EPNL	549.65	Polished Nickel	3
S1311EPORB	604.55	Oil Rubbed Bronze	3



IMMERSION



- connection size: 1/2"
- connection type: IPS
- showerhead functions: one-function
- showerhead type: rainshower
- showerhead size: 10" diameter spray head
- type of function: full spray
- flow rate: 2.5 gpm (9.5 L/min) max.

PREMIUM			
MODEL NUMBER	LIST PRICE	FINISH/CONNECTION	CASE QTY
S112	377.50	Chrome	3
S112BN	511.10	Brushed Nickel	3
S112NL	562.20	Polished Nickel	3
S112ORB	562.20	Oil Rubbed Bronze	3
S112WR	562.20	Wrought Iron	3

IMMERSION



- connection size: 1/2"
- connection type: IPS
- showerhead functions: one-function
- showerhead type: eco-performance rainshower
- showerhead size: 10" diameter spray head
- type of function: full spray
- flow rate: 2.0 transitioning to 1.75 gpm

PREMIUM			
MODEL NUMBER	LIST PRICE	FINISH/CONNECTION	CASE QTY
S112EP	377.50	Chrome	3
S112EPBN	511.10	Brushed Nickel	3
S112EPNL	562.20	Polished Nickel	3
S112EPORB	562.20	Oil Rubbed Bronze	3









IMMERSION

NOTES

IMMERSION Immersion® Rainshower

Showerheads

All Brushed Nickel faucet components feature the Lifeshine® Non-Tarnish Finish.

		MODEL NUMBER	LIST PRICE	FINISH/ CONNECTION	CASE QTY
RAINSHOWER (CONTINUED)					
	<ul style="list-style-type: none"> • connection size: 1/2" • connection type: IPS • showerhead functions: two-function • showerhead type: rainshower • showerhead size: 8" diameter spray head • type of function: full spray; concentrated rinse • flow rate: 2.5 gpm (9.5 L/min) max. 	PREMIUM			
		S6320	262.50	Chrome	3
		S6320BN	412.45	Brushed Nickel	3
		S6320ORB	453.70	Oil Rubbed Bronze	3
IMMERISION					
	<ul style="list-style-type: none"> • connection size: 1/2" • connection type: IPS • showerhead functions: two-function • showerhead type: eco-performance rainshower • showerhead size: 8" diameter spray head • type of function: full spray; concentrated rinse • flow rate: 2.0 transitioning to 1.75 gpm 	PREMIUM			
		S6320EP	262.50	Chrome	3
		S6320EPBN	412.45	Brushed Nickel	3
		S6320EPORB	453.70	Oil Rubbed Bronze	3
IMMERISION					
	<ul style="list-style-type: none"> • connection size: 1/2" • connection type: IPS • showerhead functions: two-function • showerhead type: rainshower • showerhead size: 8-1/2" diameter spray head • type of function: full rainshower; concentrated rinse; combination • flow rate: 2.5 gpm (9.5 L/min) max. 	PREMIUM			
		S6345	262.50	Chrome	3
		S6345BN	412.45	Brushed Nickel	3
IMMERISION					
	<ul style="list-style-type: none"> • connection size: 1/2" • connection type: IPS • showerhead functions: two-function • showerhead type: eco-performance rainshower • showerhead size: 8-1/2" diameter spray head • type of function: full rainshower; concentrated rinse; combination • flow rate: 2.0 transitioning to 1.75 gpm 	PREMIUM			
		S6345EP	262.50	Chrome	3
		S6345EPBN	412.45	Brushed Nickel	3
IMMERISION					
	<ul style="list-style-type: none"> • connection size: 1/2" • connection type: IPS • showerhead functions: one-function • showerhead type: rainshower • showerhead size: 8" diameter spray head • type of function: full spray • flow rate: 2.5 gpm (9.5 L/min) max. 	PREMIUM			
		S6360	243.90	Chrome	3
		S6360BN	365.90	Brushed Nickel	3
		S6360ORB	403.10	Oil Rubbed Bronze	3
IMMERISION					
	<ul style="list-style-type: none"> • connection size: 1/2" • connection type: IPS • showerhead functions: one-function • showerhead type: eco-performance rainshower • showerhead size: 8" diameter spray head • type of function: full spray; full rainshower • flow rate: 2.0 transitioning to 1.75 gpm 	PREMIUM			
		S6360EP	243.90	Chrome	3
		S6360EPBN	365.90	Brushed Nickel	3
		S6360EPORB	403.10	Oil Rubbed Bronze	3
IMMERISION					







NOTES

IMMERISION Immersion® Rainshower

Showerheads

All Brushed Nickel and Polished Nickel faucet components feature the Lifeshine® Non-Tarnish Finish.

RAINSHOWER (CONTINUED)



















	MODEL NUMBER	LIST PRICE	FINISH/ CONNECTION	CASE QTY
 <ul style="list-style-type: none"> • connection size: 1/2" • connection type: IPS • showerhead functions: one-function • showerhead type: rainshower • showerhead size: 7" diameter spray head • type of function: full spray • flow rate: 2.5 gpm (9.5 L/min) max. <p>IMMERSION</p>	PREMIUM			
	S156	167.55	Chrome	3
 <ul style="list-style-type: none"> • connection size: 1/2" • connection type: IPS • showerhead functions: one-function • showerhead type: rainshower • showerhead size: 7" diameter spray head • type of function: full spray • flow rate: 2.5 gpm (9.5 L/min) max. <p>IMMERSION</p>	PREMIUM			
	S176	167.55	Chrome	3
	S176BN	230.40	Brushed Nickel	3
	NEW! S176BL	241.85	Matte Black	3
 <ul style="list-style-type: none"> • connection size: 1/2" • connection type: IPS • showerhead functions: one-function • showerhead type: eco-performance rainshower • showerhead size: 7" diameter spray head • type of function: full spray • flow rate: 2.0 transitioning to 1.75 gpm <p>IMMERSION</p>	PREMIUM			
	S176EP	167.55	Chrome	3
	S176EPBN	230.40	Brushed Nickel	3
	S176EPBL	241.85	Matte Black	3
 <ul style="list-style-type: none"> • connection size: 1/2" • connection type: IPS • showerhead functions: one-function • showerhead type: rainshower • showerhead size: 7" diameter spray head • type of function: full rainshower • flow rate: 2.5 gpm (9.5 L/min) max. <p>IMMERSION</p>	PREMIUM			
	S6310	167.55	Chrome	3
	S6310NL	219.40	Polished Nickel	3
	S6310BN	230.40	Brushed Nickel	3
	S6310ORB	241.85	Oil Rubbed Bronze	3
	S6310WR	241.85	Wrought Iron	3
 <ul style="list-style-type: none"> • connection size: 1/2" • connection type: IPS • showerhead functions: one-function • showerhead type: eco-performance rainshower • showerhead size: 7" diameter spray head • type of function: full spray • flow rate: 2.0 transitioning to 1.75 gpm <p>IMMERSION</p>	PREMIUM			
	S6310EP	167.55	Chrome	3
	S6310EPNL	219.40	Polished Nickel	3
	S6310EPBN	230.40	Brushed Nickel	3
	S6310EPORB	241.85	Oil Rubbed Bronze	3
	S6310EPWR	241.85	Wrought Iron	1
 <ul style="list-style-type: none"> • connection size: 1/2" • connection type: IPS • showerhead functions: one-function • showerhead type: rainshower • showerhead size: 6" diameter spray head • type of function: full spray • flow rate: 2.5 gpm (9.5 L/min) max. <p>IMMERSION</p>	PREMIUM			
	S6340	167.55	Chrome	3
	S6340BN	230.40	Brushed Nickel	3

NOTES

IMMERSION Immersion® Rainshower

Showerheads

All Brushed Nickel faucet components feature the Lifeshine® Non-Tarnish Finish.

		MODEL NUMBER	LIST PRICE	FINISH/ CONNECTION	CASE QTY	
RAINSHOWER (CONTINUED)						
 <ul style="list-style-type: none"> • connection size: 1/2" • connection type: IPS • showerhead functions: one-function • showerhead type: eco-performance rainshower • showerhead size: 6" diameter spray head • type of function: full spray • flow rate: 1.75 gpm (6.65 L/min) max. 	 <small>Certified by IAPMO R&T</small>		PREMIUM			
			S6340EP	167.55	Chrome	3
			S6340EPBN	230.40	Brushed Nickel	3
 <ul style="list-style-type: none"> • connection size: 1/2" • connection type: IPS • showerhead functions: one-function • showerhead type: eco-performance rainshower • showerhead size: 6" diameter spray head • type of function: full spray • flow rate: 1.5 gpm (5.7 L/min) max. 	 <small>Certified by IAPMO R&T</small>		PREMIUM			
			S6340EP15	167.55	Chrome	3
			S6340EP15BN	230.40	Brushed Nickel	3
 <ul style="list-style-type: none"> • connection size: 1/2" • connection type: IPS • showerhead functions: one-function • showerhead type: rainshower • showerhead size: 6" diameter spray head • type of function: full spray • flow rate: 2.5 gpm (9.5 L/min) max. 	 <small>Certified by IAPMO R&T</small>		PREMIUM			
			S6365	167.55	Chrome	3
			S6365BN	230.40	Brushed Nickel	3
		S6365ORB	241.85	Oil Rubbed Bronze	3	
 <ul style="list-style-type: none"> • connection size: 1/2" • connection type: IPS • showerhead functions: one-function • showerhead type: eco-performance rainshower • showerhead size: 6" diameter spray head • type of function: full spray • flow rate: 2.0 transitioning to 1.75 gpm 	 <small>Certified by IAPMO R&T</small>		PREMIUM			
			S6365EP	167.55	Chrome	3
			S6365EPBN	230.40	Brushed Nickel	3
		S6365EPORB	241.85	Oil Rubbed Bronze	3	
 <ul style="list-style-type: none"> • connection size: 1/2" • connection type: IPS • showerhead functions: one-function • showerhead type: eco-performance rainshower • showerhead size: 8" diameter spray head • type of function: full rainshower • flow rate: 2.0 gpm (7.6 L/min) max. 	 <small>Certified by IAPMO R&T</small>		6345	82.00	Chrome	3
			6345BN	92.40	Brushed Nickel	3
			6345ORB	102.75	Oil Rubbed Bronze	3
 <ul style="list-style-type: none"> • connection size: 1/2" • connection type: IPS • showerhead functions: one-function • showerhead type: eco-performance rainshower • showerhead size: 8" diameter spray head • type of function: full rainshower • flow rate: 1.75 gpm (6.65 L/min) max. 	 <small>Certified by IAPMO R&T</small>		6345EP	82.00	Chrome	1
			6345EPBN	92.40	Brushed Nickel	1
			6345EPORB	102.75	Oil Rubbed Bronze	1

NOTES

IMMERISION Immersion® Rainshower

Showerheads

All Brushed Nickel and Polished Nickel faucet components feature the Lifeshine® Non-Tarnish Finish.

		MODEL NUMBER	LIST PRICE	FINISH/ CONNECTION	CASE QTY
FIXED SHOWER HEAD					
	<ul style="list-style-type: none"> • connection size: 1/2" • connection type: IPS • showerhead functions: one-function • showerhead type: standard • showerhead size: 6-1/2" diameter spray head • type of function: full spray • flow rate: 2.5 gpm (9.5 L/min) max. 	PREMIUM			
		S6335	131.35	Chrome	6
		S6335BN	178.85	Brushed Nickel	6
		S6335ORB	196.65	Oil Rubbed Bronze	6
	<ul style="list-style-type: none"> • connection size: 1/2" • connection type: IPS • showerhead functions: one-function • showerhead type: eco-performance showerhead • showerhead size: 6-1/2" diameter spray head • type of function: full spray • flow rate: 2.0 transitioning to 1.75 gpm 	PREMIUM			
		S6335EP	131.35	Chrome	6
		S6335EPBN	178.85	Brushed Nickel	6
		S6335EPORB	196.65	Oil Rubbed Bronze	6
					
	<ul style="list-style-type: none"> • connection size: 1/2" • connection type: IPS • showerhead functions: one-function • showerhead type: standard • showerhead size: 6-1/2" diameter spray head • type of function: full spray • flow rate: 1.5 gpm (5.7 L/min) max. 	PREMIUM			
		S6335EP15	131.35	Chrome	6
					
	<ul style="list-style-type: none"> • connection size: 1/2" • connection type: IPS • showerhead functions: one-function • showerhead type: standard • showerhead size: 5-7/8" diameter spray head • type of function: full spray • flow rate: 2.5 gpm (9.5 L/min) max. 	PREMIUM			
		S6312	109.00	Chrome	12
		S6312BN	129.55	Brushed Nickel	12
		S6312NL	129.55	Polished Nickel	12
S6312ORB	142.45	Oil Rubbed Bronze	12		
	<ul style="list-style-type: none"> • connection size: 1/2" • connection type: IPS • showerhead functions: one-function • showerhead type: eco-performance showerhead • showerhead size: 5-7/8" diameter spray head • type of function: full spray • flow rate: 1.75 gpm (6.65 L/min) max. 	PREMIUM			
		S6312EP	109.00	Chrome	12
		S6312EPBN	129.55	Brushed Nickel	12
		S6312EPNL	129.55	Polished Nickel	6
S6312EPORB	142.45	Oil Rubbed Bronze	6		
					

Showerheads











All Brushed Nickel faucet components feature the Lifeshine® Non-Tarnish Finish.

		MODEL NUMBER	LIST PRICE	FINISH/ CONNECTION	CASE QTY
FIXED SHOWER HEAD (CONTINUED)					
	<ul style="list-style-type: none"> • connection size: 1/2" • connection type: IPS • showerhead functions: three-function • showerhead type: eco-performance showerhead • showerhead size: 4" diameter spray head • type of function: full spray; concentrated rinse; combination • flow rate: 1.75 gpm (6.65 L/min) max. 	3233EP	99.15	Chrome	12
		3233EPBN	168.25	Brushed Nickel	12
	<ul style="list-style-type: none"> • connection size: 1/2" • connection type: IPS • showerhead functions: four-function • showerhead type: standard • showerhead size: 4-3/8" diameter spray head • type of function: targeted massage; invigorating spray; full spray; combination • flow rate: 2.5 gpm (9.5 L/min) max. 	3638	99.15	Chrome	12
		3638BN	168.25	Brushed Nickel	12
		3638ORB	185.15	Oil Rubbed Bronze	12
	<ul style="list-style-type: none"> • connection size: 1/2" • connection type: IPS • showerhead functions: four-function • showerhead type: eco-performance showerhead • showerhead size: 4-3/8" diameter spray head • type of function: targeted massage; invigorating spray; full spray; combination • flow rate: 2.0 transitioning to 1.75 gpm 	3638EP	99.15	Chrome	12
		3638EPBN	168.25	Brushed Nickel	12
	<ul style="list-style-type: none"> • connection size: 1/2" • connection type: IPS • showerhead functions: five-function • showerhead type: standard • showerhead size: 4" diameter spray head • type of function: energizing spray; invigorating spray; refreshing spray; relaxing spray; targeted massage • flow rate: 2.5 gpm (9.5 L/min) max. 	3855	99.15	Chrome	12
		3855EP	99.15	Chrome	12
	<ul style="list-style-type: none"> • connection size: 1/2" • connection type: IPS • showerhead functions: five-function • showerhead type: eco-performance showerhead • showerhead size: 4" diameter spray head • type of function: targeted massage; relaxing spray; refreshing spray; invigorating spray; energizing spray • flow rate: 2.0 transitioning to 1.75 gpm 	3855	99.15	Chrome	12
		3855EP	99.15	Chrome	12

















Showerheads

All Brushed Nickel and Polished Brass faucet components feature the Lifeshine® Non-Tarnish Finish.

		MODEL NUMBER	LIST PRICE	FINISH/ CONNECTION	CASE QTY
FIXED SHOWER HEAD (CONTINUED)					
 <ul style="list-style-type: none"> • connection size: 1/2" • connection type: IPS • showerhead functions: one-function • showerhead type: standard • showerhead size: 4-3/8" diameter spray head • type of function: full spray • flow rate: 2.5 gpm (9.5 L/min) max. 		6302	85.70	Chrome	12
		6302BN	133.85	Brushed Nickel	12
		6302ORB	147.25	Oil Rubbed Bronze	12
		6302WR	147.25	Wrought Iron	12
		6302P	149.25	Polished Brass	12
 <ul style="list-style-type: none"> • connection size: 1/2" • connection type: IPS • showerhead functions: one-function • showerhead type: eco-performance showerhead • showerhead size: 4-3/8" diameter spray head • type of function: full spray • flow rate: 1.75 gpm (6.65 L/min) max.  		6302EP	85.70	Chrome	12
		6302EPBN	133.85	Brushed Nickel	12
		6302EPORB	147.25	Oil Rubbed Bronze	12
		6302EPP	149.25	Polished Brass	12
 <ul style="list-style-type: none"> • connection size: 1/2" • connection type: IPS • showerhead functions: one-function • showerhead type: eco-performance showerhead • showerhead size: 4-3/8" diameter spray head • type of function: full spray • flow rate: 1.5 gpm (5.7 L/min) max.  		6302EP15	85.70	Chrome	12
 <ul style="list-style-type: none"> • connection size: 1/2" • connection type: IPS • showerhead functions: one-function • showerhead type: standard • showerhead size: 4-3/8" diameter spray head • type of function: full spray • flow rate: 2.5 gpm (9.5 L/min) max. • carded packaging: yes 		CL6302	85.70	Chrome	12
		CL6302BN	133.85	Brushed Nickel	12
 <ul style="list-style-type: none"> • connection size: 1/2" • connection type: IPS • showerhead functions: one-function • showerhead type: eco-performance showerhead • showerhead size: 4-3/8" diameter spray head • type of function: full spray • flow rate: 1.75 gpm (6.65 L/min) max. • carded packaging: yes  		CL6302EP	85.70	Chrome	12
		CL6302EPBN	133.85	Brushed Nickel	12







Showerheads

All Brushed Nickel faucet components feature the Lifeshine® Non-Tarnish Finish.

		MODEL NUMBER	LIST PRICE	FINISH/ CONNECTION	CASE QTY
FIXED SHOWER HEAD (CONTINUED)					
	<ul style="list-style-type: none"> • connection size: 1/2" • connection type: IPS • showerhead functions: one-function • showerhead type: standard • showerhead size: 3.75" diameter spray head • type of function: full spray • flow rate: 2.5 gpm (9.5 L/min) max. 	6322	84.70	Chrome	12
		NEW! 6322BN	132.25	Brushed Nickel	1
	<ul style="list-style-type: none"> • connection size: 1/2" • connection type: IPS • showerhead functions: one-function • showerhead type: eco-performance showerhead • showerhead size: 3.75" diameter spray head • type of function: full spray • flow rate: 1.75 gpm (6.65 L/min) max. 	6322EP	84.70	Chrome	12
		NEW! 6322EPBN	132.25	Brushed Nickel	1
	 				
		Certified by IAPMO R&T			
	<ul style="list-style-type: none"> • connection size: 1/2" • connection type: IPS • showerhead functions: one-function • showerhead type: standard • showerhead size: 4-1/16" diameter spray head • type of function: full spray • flow rate: 2.5 gpm (9.5 L/min) max. 	6325	84.70	Chrome	12
		6325BN	132.25	Brushed Nickel	12
		6325ORB	145.55	Oil Rubbed Bronze	12
	<ul style="list-style-type: none"> • connection size: 1/2" • connection type: IPS • showerhead functions: one-function • showerhead type: eco-performance showerhead • showerhead size: 4-1/16" diameter spray head • type of function: full spray • flow rate: 1.75 gpm (6.65 L/min) max. 	6325EP	84.70	Chrome	12
		6325EPBN	132.25	Brushed Nickel	12
		6325EPORB	145.55	Oil Rubbed Bronze	12
	 				
		Certified by IAPMO R&T			
	<ul style="list-style-type: none"> • connection size: 1/2" • connection type: IPS • showerhead functions: one-function • showerhead type: standard • showerhead size: 3-5/8" diameter spray head • type of function: full spray • flow rate: 2.5 gpm (9.5 L/min) max. 	6399	84.70	Chrome	12
		6399BN	132.25	Brushed Nickel	12
		6399BL	145.50	Matte Black	12
	<ul style="list-style-type: none"> • connection size: 1/2" • connection type: IPS • showerhead functions: one-function • showerhead type: eco-performance showerhead • showerhead size: 3-5/8" diameter spray head • type of function: full spray • flow rate: 1.75 gpm (6.65 L/min) max. 	6399EP	84.70	Chrome	12
		6399EPBN	132.25	Brushed Nickel	12
		6399EPBL	145.50	Matte Black	12
	 				
		Certified by IAPMO R&T			











Showerheads

All Brushed Nickel faucet components feature the Lifeshine® Non-Tarnish Finish.

		MODEL NUMBER	LIST PRICE	FINISH/ CONNECTION	CASE QTY
FIXED SHOWER HEAD (CONTINUED)					
 <ul style="list-style-type: none"> • connection size: 1/2" • connection type: IPS • showerhead functions: one-function • showerhead type: eco-performance showerhead • showerhead size: 3-5/8" diameter spray head • type of function: full spray • flow rate: 1.5 gpm (5.7 L/min) max.  	<ul style="list-style-type: none"> • connection size: 1/2" • connection type: IPS • showerhead functions: one-function • showerhead type: standard • showerhead size: 3-3/4" diameter spray head • type of function: full spray • flow rate: 2.5 gpm (9.5 L/min) max. 	<p>6399EP15</p> <p>6399EP15BL</p>	<p>84.70</p> <p>145.50</p>	<p>Chrome</p> <p>Matte Black</p>	<p>12</p> <p>12</p>
		<ul style="list-style-type: none"> • connection size: 1/2" • connection type: IPS • showerhead functions: one-function • showerhead type: standard • showerhead size: 3.75" diameter spray head • type of function: full spray • flow rate: 1.75 gpm (6.65 L/min) max. 	<p>6370</p> <p>6370BN</p>	<p>50.85</p> <p>77.85</p>	<p>Chrome</p> <p>Brushed Nickel</p>
	<ul style="list-style-type: none"> • connection size: 1/2" • connection type: IPS • showerhead functions: one-function • showerhead type: standard • showerhead size: 4" diameter spray head • type of function: full spray • flow rate: 2.5 gpm (9.5 L/min) max. 	<p>6370EP</p> <p>6370EPBN</p>	<p>50.85</p> <p>77.85</p>	<p>Chrome</p> <p>Brushed Nickel</p>	<p>1</p> <p>1</p>
	<ul style="list-style-type: none"> • connection size: 1/2" • connection type: IPS • showerhead functions: one-function • showerhead type: standard • showerhead size: 4" diameter spray head • type of function: full spray • flow rate: 2.5 gpm (9.5 L/min) max. 	<p>6371</p> <p>6371BN</p> <p>6371ORB</p>	<p>50.85</p> <p>77.85</p> <p>85.70</p>	<p>Chrome</p> <p>Brushed Nickel</p> <p>Oil Rubbed Bronze</p>	<p>12</p> <p>12</p> <p>12</p>
	<ul style="list-style-type: none"> • connection size: 1/2" • connection type: IPS • showerhead functions: one-function • showerhead type: standard • showerhead size: 4" diameter spray head • type of function: full spray • flow rate: 1.75 gpm (6.65 L/min) max. 	<p>6371EP</p> <p>6371EPBN</p> <p>6371EPORB</p>	<p>50.85</p> <p>77.85</p> <p>85.70</p>	<p>Chrome</p> <p>Brushed Nickel</p> <p>Oil Rubbed Bronze</p>	<p>1</p> <p>1</p> <p>1</p>









Showerheads

All Brushed Nickel faucet components feature the Lifeshine® Non-Tarnish Finish.

		MODEL NUMBER	LIST PRICE	FINISH/ CONNECTION	CASE QTY
FIXED SHOWER HEAD (CONTINUED)					
	<ul style="list-style-type: none"> • connection size: 1/2" • connection type: IPS • showerhead functions: five-function • showerhead type: standard • showerhead size: 4" diameter spray head • type of function: energizing spray; targeted massage; relaxing spray; refreshing spray; invigorating spray • flow rate: 2.5 gpm (9.5 L/min) max. • carded packaging: yes 	CL26500	50.45	Chrome	12
		CL26500BN	82.35	Brushed Nickel	12
	<ul style="list-style-type: none"> • connection size: 1/2" • connection type: IPS • showerhead functions: five-function • showerhead type: eco-performance showerhead • showerhead size: 4" diameter spray head • type of function: invigorating spray; refreshing spray; relaxing spray; energizing spray; targeted massage • flow rate: 2.0 transitioning to 1.75 gpm • carded packaging: yes 	CL26500EP	50.45	Chrome	12
		CL26500EPBN	82.35	Brushed Nickel	12
	 				
	<ul style="list-style-type: none"> • connection size: 1/2" • connection type: IPS • showerhead functions: one-function • showerhead type: standard • showerhead size: 3-1/2" diameter spray head • type of function: full spray • flow rate: 2.5 gpm (9.5 L/min) max. 	6303	47.40	Chrome	12
		6303BN	72.60	Brushed Nickel	12
		6303ORB	79.85	Oil Rubbed Bronze	12
	<ul style="list-style-type: none"> • connection size: 1/2" • connection type: IPS • showerhead functions: one-function • showerhead type: eco-performance showerhead • showerhead size: 3-1/2" diameter spray head • type of function: full spray • flow rate: 1.75 gpm (6.65 L/min) max. 	6303EP	47.40	Chrome	12
		6303EPBN	72.60	Brushed Nickel	12
		6303EPORB	79.85	Oil Rubbed Bronze	12
	 				
	<ul style="list-style-type: none"> • connection size: 1/2" • connection type: IPS • showerhead functions: one-function • showerhead type: eco-performance showerhead • showerhead size: 3-1/2" diameter spray head • type of function: full spray • flow rate: 1.5 gpm (5.7 L/min) max. 	6313	47.40	Chrome	12
		6313BN	72.60	Brushed Nickel	12
		6313ORB	79.85	Oil Rubbed Bronze	12
	 				











Showerheads

All Brushed Nickel faucet components feature the Lifeshine® Non-Tarnish Finish.

		MODEL NUMBER	LIST PRICE	FINISH/ CONNECTION	CASE QTY
FIXED SHOWER HEAD (CONTINUED)					
 <ul style="list-style-type: none"> • connection size: 1/2" • connection type: IPS • showerhead functions: one-function • showerhead type: standard • showerhead size: 3-1/2" diameter spray head • type of function: full spray • flow rate: 2.5 gpm (9.5 L/min) max. • carded packaging: yes 		CL6303	47.40	Chrome	12
		CL6303BN	72.60	Brushed Nickel	12
 <ul style="list-style-type: none"> • connection size: 1/2" • connection type: IPS • showerhead functions: one-function • showerhead type: standard • showerhead size: 3-1/2" diameter spray head • type of function: full spray • flow rate: 1.75 gpm (6.65 L/min) max. • carded packaging: yes 		CL6303EP	47.40	Chrome	12
	 	CL6303EPBN	72.60	Brushed Nickel	12
 <ul style="list-style-type: none"> • connection size: 1/2" • connection type: IPS • showerhead functions: four-function • showerhead type: standard • showerhead size: 3" diameter spray head • type of function: refreshing spray; invigorating spray; full spray; energizing massage • flow rate: 2.5 gpm (9.5 L/min) max. 		23026	39.95	Chrome	4
 <ul style="list-style-type: none"> • connection size: 1/2" • connection type: IPS • showerhead functions: one-function • showerhead type: standard • showerhead size: 2-1/2" diameter spray head • type of function: full spray • flow rate: 2.5 gpm (9.5 L/min) max. 		6304	38.65	Chrome	12
 <ul style="list-style-type: none"> • connection size: 1/2" • connection type: IPS • showerhead functions: one-function • showerhead type: eco-performance showerhead • showerhead size: 2-1/2" diameter spray head • type of function: full spray • flow rate: 1.75 gpm (6.65 L/min) max. 		6304EP	38.65	Chrome	12
 					









Showerheads

All Brushed Nickel and Polished Brass faucet components feature the Lifeshine® Non-Tarnish Finish.

		MODEL NUMBER	LIST PRICE	FINISH/ CONNECTION	CASE QTY
FIXED SHOWER HEAD (CONTINUED)					
	<ul style="list-style-type: none"> • connection size: 1/2" • connection type: IPS • showerhead functions: three-function • showerhead type: eco-performance showerhead • showerhead size: 3.75" diameter spray head • type of function: targeted massage; refreshing spray; full spray • flow rate: 2.0 transitioning to 1.75 gpm 	20001	34.95	Chrome	3
	  <p>WaterSense Meets EPA Criteria Certified by IAPMO R&T</p>				
	<ul style="list-style-type: none"> • connection size: 1/2" • connection type: IPS • showerhead functions: one-function • showerhead type: standard • showerhead size: 2-1/2" diameter spray head • type of function: full spray • flow rate: 2.5 gpm (9.5 L/min) max. 	6300	33.20	Chrome	12
		6300BN	50.75	Brushed Nickel	12
		6300P	59.20	Polished Brass	12
	<ul style="list-style-type: none"> • connection size: 1/2" • connection type: IPS • showerhead functions: one-function • showerhead type: eco-performance showerhead • showerhead size: 2-1/2" diameter spray head • type of function: full spray • flow rate: 1.75 gpm (6.65 L/min) max. 	6300EP	33.20	Chrome	12
		6300EPBC	38.85	Brushed Chrome	12
		6300EPBN	50.75	Brushed Nickel	12
	  <p>WaterSense Meets EPA Criteria Certified by IAPMO R&T</p>				
	<ul style="list-style-type: none"> • connection size: 1/2" • connection type: IPS • showerhead functions: one-function • showerhead type: eco-performance showerhead • showerhead size: 2-1/2" diameter spray head • type of function: full spray • flow rate: 1.5 gpm (5.7 L/min) max. 	6300EP15	33.20	Chrome	12
	  <p>WaterSense Meets EPA Criteria Certified by IAPMO R&T</p>				







Shower Arms and Flanges

All Brushed Nickel and Polished Nickel faucet components feature the Lifeshine® Non-Tarnish Finish.

SHOWER ARM + FLANGE		MODEL NUMBER	LIST PRICE	FINISH/ CONNECTION	CASE QTY
 <p>NEW! Ships Q1</p> <ul style="list-style-type: none"> • connection size: 1/2" • connection type: IPS • length: 18" 		336651	63.10	Chrome	6
		336651BN	122.70	Brushed Nickel	6
		336651NL	122.70	Polished Nickel	6
		336651BL	134.85	Matte Black	6
		336651ORB	134.85	Oil Rubbed Bronze	6
 <ul style="list-style-type: none"> • connection size: 1/2" • connection type: IPS • length: 12" 		226651	42.10	Chrome	6
		226651BN	81.80	Brushed Nickel	6
		226651NL	81.80	Polished Nickel	6
		226651ORB	89.90	Oil Rubbed Bronze	6
		226651WR	89.90	Wrought Iron	6
 <ul style="list-style-type: none"> • connection size: 1/2" • connection type: IPS • length: 6" 		116651	13.65	Chrome	6
		116651BN	23.10	Brushed Nickel	6
		116651NL	23.10	Polished Nickel	6
		116651ORB	30.00	Oil Rubbed Bronze	6
		116651WR	30.00	Wrought Iron	6
 <ul style="list-style-type: none"> • connection size: 1/2" • connection type: IPS • length: 14" 		PREMIUM			
		S110	110.40	Chrome	6
		S110BN	133.65	Brushed Nickel	6
		NEW! S110BL	147.00	Matte Black	6
 <ul style="list-style-type: none"> • connection size: 1/2" • connection type: IPS • length: 14" 		PREMIUM			
		S113	110.40	Chrome	3
		S113BN	133.65	Brushed Nickel	3
		S113NL	133.65	Polished Nickel	3
		S113ORB	147.00	Oil Rubbed Bronze	3
	S113WR	147.00	Wrought Iron	3	
 <ul style="list-style-type: none"> • connection size: 1/2" • connection type: IPS • length: 8" 		161951	91.50	Chrome	12
		161951BN	123.75	Brushed Nickel	12
		161951ORB	136.15	Oil Rubbed Bronze	12
 <ul style="list-style-type: none"> • connection size: 1/2" • connection type: IPS • length: 16" 		151380	69.80	Chrome	6
		151380BN	118.70	Brushed Nickel	6
		151380ORB	130.50	Oil Rubbed Bronze	6
 <ul style="list-style-type: none"> • connection size: 1/2" • connection type: IPS • length: 8" 		PREMIUM			
		S122	42.35	Chrome	6
		S122BN	87.60	Brushed Nickel	6
	S122ORB	96.40	Oil Rubbed Bronze	6	

Shower Arms and Flanges







All Brushed Nickel, Polished Nickel and Polished Brass faucet components feature the Lifeshine® Non-Tarnish Finish.

		MODEL NUMBER	LIST PRICE	FINISH/ CONNECTION	CASE QTY
SHOWER ARM + FLANGE (CONTINUED)					
	<ul style="list-style-type: none"> • connection size: 1/2" • connection type: IPS • length: 8" 	PREMIUM			
		S133	42.35	Chrome	6
		S133BN	87.60	Brushed Nickel	6
	<ul style="list-style-type: none"> • connection size: 1/2" • connection type: IPS • length: 6" 	PREMIUM			
		S177	42.25	Chrome	6
		S177BN	87.60	Brushed Nickel	6
	<ul style="list-style-type: none"> • connection size: 1/2" • connection type: IPS • length: 8" 	CL123815	34.45	Chrome	12
		CL123815BN	64.90	Brushed Nickel	12
	<ul style="list-style-type: none"> • connection size: 1/2" • connection type: IPS • length: 6" 	CL10154	27.40	Chrome	12
		CL10154BN	55.55	Brushed Nickel	12
	<ul style="list-style-type: none"> • connection size: 1/2" • connection type: IPS • length: 8" 	123815	26.90	Chrome	12
		123815BN	44.75	Brushed Nickel	12
		123815BL	49.20	Matte Black	12
		123815ORB	49.20	Oil Rubbed Bronze	12
	<ul style="list-style-type: none"> • connection size: 1/2" • connection type: IPS • length: 6" 	10154	19.75	Chrome	20
		10154CBN	19.15	Classic Brushed Nickel	20
		10154SLP	31.45	Brushed Platinum	20
		10154BRB	31.80	Mediterranean Bronze	20
		10154BN	35.45	Brushed Nickel	20
		10154NL	35.45	Polished Nickel	1
		10154P	37.60	Polished Brass	1
		10154ORB	39.00	Oil Rubbed Bronze	20
10154WR	39.00	Wrought Iron	20		

Shower Arms and Flanges

All Brushed Nickel, Polished Nickel and Polished Brass faucet components feature the Lifeshine® Non-Tarnish Finish.

CUSTOM SHOWERING

		MODEL NUMBER	LIST PRICE	FINISH/ CONNECTION	CASE QTY
SHOWER ARM + FLANGE (CONTINUED)					
	<ul style="list-style-type: none"> tub and shower accent kit 	AT2099	16.10	Chrome	12
		AT2099BN	40.90	Brushed Nickel	12
		AT2099P	43.30	Polished Brass	12
		AT2099ORB	44.95	Oil Rubbed Bronze	12
	<ul style="list-style-type: none"> shower arm flange 	179834	13.85	Chrome	20
	<ul style="list-style-type: none"> shower arm flange 	147572	11.00	Chrome	12
		147572BN	16.10	Brushed Nickel	12
	<ul style="list-style-type: none"> shower arm flange 	164745	10.90	Chrome	20
		164745BN	16.00	Brushed Nickel	20
		164745ORB	20.75	Oil Rubbed Bronze	20
	<ul style="list-style-type: none"> shower arm flange 	137488BL	7.55	Matte Black	12
		137488	7.65	Chrome	12
		137488BN	19.95	Brushed Nickel	12
	<ul style="list-style-type: none"> shower arm flange 	AT2199	7.65	Chrome	48
		AT2199SLP	14.40	Brushed Platinum	48
		AT2199BN	20.10	Brushed Nickel	48
		AT2199NL	20.10	Polished Nickel	48
		AT2199P	21.30	Polished Brass	48
		AT2199ORB	22.15	Oil Rubbed Bronze	48
AT2199WR	22.15	Wrought Iron	12		

Handheld Showers

All Brushed Nickel and Polished Nickel faucet components feature the Lifeshine® Non-Tarnish Finish.

SHOWER RAIL



- connection size: 1/2"
- connection type: IPS
- showerhead type: showerhead sold separately
- handshower type: handshower sold separately
- type of function: two independent functions
- hose length: 59"

MODEL NUMBER	LIST PRICE	FINISH/ CONNECTION	CASE QTY
--------------	------------	--------------------	----------

PREMIUM			
TS3661NH	461.90	Chrome	3
NEW TS3661NHBN	729.70	Brushed Nickel	3
NEW TS3661NHBL	769.95	Matte Black	3
NEW TS3661NHORB	769.95	Oil Rubbed Bronze	3

HANDHELD



- showerhead functions: one-function
- showerhead type: eco-performance handshower
- showerhead size: 3-3/8" diameter spray head
- type of function: full spray
- flow rate: 2.0 transitioning to 1.75 gpm
- slide bar length: 30"
- hose length: 69"
- double check valve: included
- slide bar: not to be used as a grab bar
- drop ell: sold separately
- use secure mount anchor: to meet hand grip requirements

PREMIUM			
S12107EP	469.45	Chrome	6
S12107EPBN	663.80	Brushed Nickel	6
S12107EPNL	663.80	Polished Nickel	6
S12107EPORB	730.15	Oil Rubbed Bronze	6

SECUREMOUNT ANCHORS SOLD SEPARATELY

A750	29.50	N/A or Unfinished	24
-------------	-------	-------------------	----



- showerhead functions: four-function
- showerhead type: eco-performance handshower
- showerhead size: 3-3/4" diameter spray head
- type of function: drench; soothe; immerse; shine
- flow rate: 2.0 transitioning to 1.75 gpm
- slide bar length: 30"
- hose length: 69"
- double check valve: included
- slide bar: not to be used as a grab bar
- drop ell: sold separately
- use secure mount anchor: to meet hand grip requirements

PREMIUM			
S3870EP	323.10	Chrome	6
S3870EPBN	647.95	Brushed Nickel	6
S3870EPORB	713.40	Oil Rubbed Bronze	6

SECUREMOUNT ANCHORS SOLD SEPARATELY

A750	29.50	N/A or Unfinished	24
-------------	-------	-------------------	----



- showerhead functions: one-function
- showerhead type: eco-performance handshower
- showerhead size: 3" diameter spray head
- type of function: full spray
- flow rate: 2.0 transitioning to 1.75 gpm
- slide bar length: 30"
- hose length: 69"
- double check valve: included
- slide bar: not to be used as a grab bar
- drop ell: sold separately
- use secure mount anchor: to meet hand grip requirements

PREMIUM			
S3879EP	285.20	Chrome	6
S3879EPBN	572.20	Brushed Nickel	6









SECUREMOUNT ANCHORS SOLD SEPARATELY

A750	29.50	N/A or Unfinished	24
-------------	-------	-------------------	----















Handheld Showers

All Brushed Nickel faucet components feature the Lifeshine® Non-Tarnish Finish.

HANDHELD (CONTINUED)		MODEL NUMBER	LIST PRICE	FINISH/ CONNECTION	CASE QTY	
 <ul style="list-style-type: none"> • showerhead functions: one-function • showerhead type: eco-performance handshower • showerhead size: 2" diameter spray head • type of function: full spray • flow rate: 2.0 transitioning to 1.75 gpm • slide bar length: 30" • hose length: 69" • double check valve: included • slide bar: not to be used as a grab bar • drop ell: sold separately • use secure mount anchor: to meet hand grip requirements 	 	3869EP	277.15	Chrome	6	
		3869EPBN	550.45	Brushed Nickel	6	
		3869EPORB	605.50	Oil Rubbed Bronze	6	
		3869EPWR	611.60	Wrought Iron	6	
		SECUREMOUNT ANCHORS SOLD SEPARATELY				
		A750	29.50	N/A or Unfinished	24	
 <ul style="list-style-type: none"> • showerhead functions: four-function • showerhead type: eco-performance handshower • showerhead size: 4-3/8" diameter spray head • type of function: combination; full spray; invigorating spray; targeted massage • flow rate: 2.0 transitioning to 1.75 gpm • slide bar length: 30" • hose length: 69" • double check valve: included • slide bar: not to be used as a grab bar • drop ell: sold separately • use secure mount anchor: to meet hand grip requirements 	 	3667EP	267.80	Chrome	6	
		3667EPBN	529.55	Brushed Nickel	6	
		3667EPORB	582.45	Oil Rubbed Bronze	6	
		SECUREMOUNT ANCHORS SOLD SEPARATELY				
				A750	29.50	N/A or Unfinished
 <ul style="list-style-type: none"> • showerhead functions: four-function • showerhead type: eco-performance handshower • showerhead size: 4" diameter spray head • type of function: combination; full spray; invigorating spray; targeted massage • flow rate: 2.0 transitioning to 1.75 gpm • slide bar length: 30" • hose length: 69" • double check valve: included • slide bar: not to be used as a grab bar • drop ell: sold separately • use secure mount anchor: to meet hand grip requirements 	 	3669EP	267.80	Chrome	6	
		3669EPBN	529.55	Brushed Nickel	6	
		3669EPORB	582.45	Oil Rubbed Bronze	6	
		SECUREMOUNT ANCHORS SOLD SEPARATELY				
				A750	29.50	N/A or Unfinished

Handheld Showers

All Brushed Nickel faucet components feature the Lifeshine® Non-Tarnish Finish.

		MODEL NUMBER	LIST PRICE	FINISH/ CONNECTION	CASE QTY	
HANDHELD (CONTINUED)						
	<ul style="list-style-type: none"> • showerhead functions: one-function • showerhead type: eco-performance handshower • showerhead size: 1-1/8" diameter spray head • type of function: full spray • flow rate: 2.0 transitioning to 1.75 gpm • slide bar length: 30" • hose length: 69" • double check valve: included • slide bar: not to be used as a grab bar • drop ell: sold separately • use secure mount anchor: to meet hand grip requirements 	3887EP	248.75	Chrome	6	
		3887EPBN	494.25	Brushed Nickel	6	
		3887EPBL	543.65	Matte Black	6	
		SECUREMOUNT ANCHORS SOLD SEPARATELY				
		A750	29.50	N/A or Unfinished	24	
		 				
NEW! Ships Q2		<ul style="list-style-type: none"> • showerhead functions: one-function • showerhead type: handshower • showerhead size: 1-1/8" diameter spray head • type of function: full spray • flow rate: 1.75 gpm (6.65 L/min) max. • slide bar length: 30" • hose length: 69" • double check valve: included • slide bar: not to be used as a grab bar • drop ell: sold separately • use secure mount anchor: to meet hand grip requirements 	3988EP	248.75	Chrome	6
3988EPBN			494.25	Brushed Nickel	6	
3988EPSRN ●			494.25	Spot Resist Brushed Nickel	6	
3988EPBRB			543.65	Mediterranean Bronze	6	
3988EPORB			543.65	Oil Rubbed Bronze	6	
	SECUREMOUNT ANCHORS SOLD SEPARATELY					
A750	29.50	N/A or Unfinished	24			
		 				
	<ul style="list-style-type: none"> • showerhead functions: three-function • showerhead type: eco-performance handshower • showerhead size: 4" diameter spray head • type of function: full spray; concentrated rinse; combination • flow rate: 1.75 gpm (6.65 L/min) max. • slide bar length: 30" • hose length: 69" • double check valve: included • slide bar: not to be used as a grab bar • drop ell: sold separately • use secure mount anchor: to meet hand grip requirements 	3863EP	244.25	Chrome	6	
		3863EPBN	507.05	Brushed Nickel	6	
		SECUREMOUNT ANCHORS SOLD SEPARATELY				
		A750	29.50	N/A or Unfinished	24	
				 		
	<ul style="list-style-type: none"> • showerhead functions: one-function • showerhead type: eco-performance handshower • showerhead size: 4-1/4" diameter spray head • type of function: full spray • flow rate: 2.0 transitioning to 1.75 gpm • slide bar length: 24" • hose length: 59" • double check valve: included • slide bar: not to be used as a grab bar • drop ell: sold separately • use secure mount anchor: to meet hand grip requirements 	3668EP	224.20	Chrome	6	
		3668EPBN	324.50	Brushed Nickel	6	
		3668EPORB	356.65	Oil Rubbed Bronze	6	
		SECUREMOUNT ANCHORS SOLD SEPARATELY				
		A750	29.50	N/A or Unfinished	24	
		 				





NOTES

- Spot Resist Stainless Finish 

Handheld Showers

All Brushed Nickel and Polished Nickel faucet components feature the Lifeshine® Non-Tarnish Finish.

CUSTOM SHOWERING

HANDHELD (CONTINUED)		MODEL NUMBER	LIST PRICE	FINISH/ CONNECTION	CASE QTY
 <ul style="list-style-type: none"> • showerhead functions: one-function • showerhead type: eco-performance showerhead • showerhead size: 4" diameter spray head • type of function: full spray • flow rate: 2.0 transitioning to 1.75 gpm • slide bar length: 24" • hose length: 59" • double check valve: included • slide bar: not to be used as a grab bar • drop ell: sold separately • use secure mount anchor: to meet hand grip requirements 		3868EP	224.20	Chrome	6
		3868EPBN	324.50	Brushed Nickel	6
		3868EPORB	356.65	Oil Rubbed Bronze	6
	SECUREMOUNT ANCHORS SOLD SEPARATELY				
		A750	29.50	N/A or Unfinished	24
 <ul style="list-style-type: none"> • showerhead functions: five-function • showerhead type: eco-performance handshower • showerhead size: 4-3/8" diameter spray head • type of function: downpour; rinse; massage; relaxing massage; full spray • flow rate: 1.75 gpm (6.65 L/min) max. • slide bar length: 30" • hose length: 69" • double check valve: included • slide bar: not to be used as a grab bar • drop ell: sold separately • use secure mount anchor: to meet hand grip requirements 		Ships Q1 3558EP	220.00	Chrome	6
		Ships Q1 3558EPBN	297.00	Brushed Nickel	6
		Ships Q1 3558EPORB	326.70	Oil Rubbed Bronze	6
		Ships Q2 3558EPBL	326.70	Matte Black	6
	DROP ELL SOLD SEPARATELY				
	A725	49.40	Chrome	12	
 <ul style="list-style-type: none"> • showerhead functions: four-function • showerhead type: eco-performance handshower • showerhead size: 4-3/8" diameter spray head • type of function: targeted massage; invigorating spray; full spray; combination • flow rate: 2.0 gpm (7.6 L/min) max. • hose length: 69" • double check valve: included • drop ell: sold separately 		3636EP	254.10	Chrome	6
		3636EPBN	483.65	Brushed Nickel	6
		3636EPORB	532.00	Oil Rubbed Bronze	6
 <ul style="list-style-type: none"> • showerhead functions: one-function • showerhead type: eco-performance showerhead • showerhead size: 2" diameter spray head • type of function: full spray • flow rate: 2.0 transitioning to 1.75 gpm • hose length: 69" • wall bracket: included • double check valve: included • drop ell: sold separately 		3861EP	244.35	Chrome	6
		3861EPBN	497.60	Brushed Nickel	6
		3861EPNL	497.60	Polished Nickel	6
		3861EPORB	548.90	Oil Rubbed Bronze	6



Handheld Showers

All Brushed Nickel faucet components feature the Lifeshine® Non-Tarnish Finish.

CUSTOM SHOWERING

HANDHELD (CONTINUED)



- showerhead functions: one-function
- showerhead type: eco-performance handshower
- showerhead size: 1-1/8" diameter spray head
- type of function: full spray
- flow rate: 2.0 transitioning to 1.75 gpm
- hose length: 69"
- wall bracket: included
- double check valve: included
- drop ell: sold separately



MODEL NUMBER	LIST PRICE	FINISH/ CONNECTION	CASE QTY
--------------	------------	--------------------	----------

PREMIUM			
S11705EP	232.35	Chrome	6
S11705EPBN	336.80	Brushed Nickel	6



- showerhead functions: one-function
- showerhead type: eco-performance handshower
- showerhead size: 4" diameter spray head
- type of function: full spray
- flow rate: 2.0 transitioning to 1.75 gpm
- hose length: 59"
- wall bracket: included
- double check valve: included
- drop ell: sold separately











3865EP	182.90	Chrome	6
3865EPBN	265.45	Brushed Nickel	6
3865EPORB	292.10	Oil Rubbed Bronze	6

Handheld Showers





All Brushed Nickel and Polished Nickel faucet components feature the Lifeshine® Non-Tarnish Finish.

CUSTOM SHOWERING

		MODEL NUMBER	LIST PRICE	FINISH/ CONNECTION	CASE QTY
HANDHELD (CONTINUED)					
	<ul style="list-style-type: none"> • showerhead functions: six-function • showerhead type: eco-performance handshower • showerhead size: 5.5" diameter spray head • type of function: wide coverage; downpour; rinse; massage; relaxing massage; invigorating spray • flow rate: 1.75 gpm (6.65 L/min) max. • double check valve: included • includes: magnetix docking system 	3662EP	180.00	Chrome	6
		3662EPBN	244.00	Brushed Nickel	6
		3662EPORB	307.00	Oil Rubbed Bronze	6
		 			
	<ul style="list-style-type: none"> • showerhead functions: six-function • showerhead type: eco-performance handshower • showerhead size: 5" diameter spray head • type of function: soothing massage; downpour; wide coverage; rinse; massage; relaxing massage • flow rate: 1.75 gpm (6.65 L/min) max. • double check valve: included • includes: magnetix docking system 	187054	120.00	Chrome	1
		187054BN	150.00	Brushed Nickel	1
		187054ORB	170.00	Oil Rubbed Bronze	1
	<ul style="list-style-type: none"> • showerhead functions: one-function • showerhead type: eco-performance handshower • showerhead size: 3-3/8" diameter spray head • type of function: full spray • flow rate: 2.0 transitioning to 1.75 gpm • double check valve: included 	154305	126.60	Chrome	6
		154305BN	183.50	Brushed Nickel	6
		154305NL	194.90	Polished Nickel	6
	<ul style="list-style-type: none"> • showerhead functions: three-function • showerhead type: eco-performance handshower • showerhead size: 4" diameter spray head • type of function: full spray; concentrated rinse; combination • flow rate: 1.75 gpm (6.65 L/min) max. • double check valve: included 	147913	124.25	Chrome	6
		147913BN	183.90	Brushed Nickel	6
		160042	90.30	Chrome	6
	<ul style="list-style-type: none"> • showerhead functions: four-function • showerhead type: eco-performance handshower • showerhead size: 3-3/4" diameter spray head • type of function: targeted massage; invigorating spray; full spray; combination • flow rate: 2.0 transitioning to 1.75 gpm • double check valve: included 	160042BN	131.00	Brushed Nickel	6
		160042ORB	144.05	Oil Rubbed Bronze	6
		147547	84.90	Chrome	6
	<ul style="list-style-type: none"> • showerhead functions: one-function • showerhead type: eco-performance handshower • showerhead size: 3" diameter spray head • type of function: full spray • flow rate: 1.75 gpm (6.65 L/min) max. • double check valve: included 	147547BN	124.55	Brushed Nickel	6
		147547	84.90	Chrome	6

















Handheld Showers

All Brushed Nickel faucet and Polished Brass components feature the Lifeshine® Non-Tarnish Finish.

		MODEL NUMBER	LIST PRICE	FINISH/ CONNECTION	CASE QTY
HANDHELD (CONTINUED)					
	<ul style="list-style-type: none"> • showerhead functions: one-function • showerhead type: eco-performance handshower • showerhead size: 3" diameter spray head • type of function: full spray • flow rate: 2.0 transitioning to 1.75 gpm • double check valve: included 	176257	84.90	Chrome	6
		176257BN	124.55	Brushed Nickel	6
	<ul style="list-style-type: none"> • showerhead functions: one-function • showerhead type: eco-performance handshower • showerhead size: 2" diameter spray head • type of function: full spray • flow rate: 2.0 transitioning to 1.75 gpm • double check valve: included 	176015	75.35	Chrome	12
		176015BN	109.20	Brushed Nickel	12
		176015ORB	120.20	Oil Rubbed Bronze	12
		176015P	148.35	Polished Brass	12
		176015WR	152.60	Wrought Iron	12
	<ul style="list-style-type: none"> • showerhead functions: four-function • showerhead type: eco-performance handshower • showerhead size: 4-3/64" diameter spray head • type of function: targeted massage; invigorating spray; full spray; combination • flow rate: 2.0 transitioning to 1.75 gpm • double check valve: included 	164928	70.10	Chrome	6
		164928BN	101.60	Brushed Nickel	6
		164928ORB	111.80	Oil Rubbed Bronze	6
	<ul style="list-style-type: none"> • showerhead functions: four-function • showerhead type: eco-performance handshower • showerhead size: 4-3/64" diameter spray head • type of function: targeted massage; invigorating spray; full spray; combination • flow rate: 2.0 transitioning to 1.75 gpm • double check valve: included • carded packaging: yes 	CL164928	70.10	Chrome	6
		CL164928BN	101.60	Brushed Nickel	6
	<ul style="list-style-type: none"> • showerhead functions: four-function • showerhead type: eco-performance handshower • showerhead size: 4-3/8" diameter spray head • type of function: targeted massage; invigorating spray; full spray; combination • flow rate: 2.0 transitioning to 1.75 gpm • double check valve: included 	164927	68.40	Chrome	6
		164927BN	99.10	Brushed Nickel	6
		164927ORB	111.80	Oil Rubbed Bronze	6

Handheld Showers

All Brushed Nickel faucet components feature the Lifeshine® Non-Tarnish Finish.







HANDHELD (CONTINUED)		MODEL NUMBER	LIST PRICE	FINISH/ CONNECTION	CASE QTY
 <ul style="list-style-type: none"> • showerhead functions: six-function • showerhead type: eco-performance handshower • showerhead size: 3.5" diameter spray head • type of function: relaxing massage; massage; rinse; wide coverage; downpour; soothing massage • flow rate: 2.0 transitioning to 1.75 gpm • includes: magnetix docking system • double check valve: included • arm and flange sold separately 	 	26100EP 26100EPSRN ●	59.95 73.30	Chrome Spot Resist Brushed Nickel	2 2
	 	P26100EP	59.95	Chrome	12
 <ul style="list-style-type: none"> • showerhead functions: six-function • showerhead type: eco-performance handshower • showerhead size: 3.5" diameter spray head • type of function: relaxing massage; soothe; relaxing spray; massaging rinse; full spray • flow rate: 2.0 transitioning to 1.75 gpm • double check valve: included • arm and flange sold separately 	 	155747 155747BN 155747ORB	58.70 85.15 93.70	Chrome Brushed Nickel Oil Rubbed Bronze	6 6 6
		165212 165212BN	58.70 85.15	Chrome Brushed Nickel	12 12
		155891 155891BN 155891BL	58.70 85.15 93.70	Chrome Brushed Nickel Matte Black	6 6 6
 <ul style="list-style-type: none"> • showerhead functions: one-function • showerhead type: eco-performance handshower • showerhead size: 4-3/64" diameter spray head • type of function: full spray • flow rate: 2.0 transitioning to 1.75 gpm • double check valve: included 	 	157276 157276BN 157276ORB	58.70 85.15 93.70	Chrome Brushed Nickel Oil Rubbed Bronze	6 6 6
	 	157276 157276BN 157276ORB	58.70 85.15 93.70	Chrome Brushed Nickel Oil Rubbed Bronze	6 6 6
		157276 157276BN 157276ORB	58.70 85.15 93.70	Chrome Brushed Nickel Oil Rubbed Bronze	6 6 6

NOTES

● Spot Resist Stainless Finish 

Handheld Showers

All Brushed Nickel and Polished Nickel faucet components feature the Lifeshine® Non-Tarnish Finish.

		MODEL NUMBER	LIST PRICE	FINISH/ CONNECTION	CASE QTY
HANDHELD (CONTINUED)					
	<ul style="list-style-type: none"> • showerhead functions: one-function • showerhead type: eco-performance handshower • showerhead size: 4-3/64" diameter spray head • type of function: full spray • flow rate: 1.5 gpm (5.7 L/min) max. • double check valve: included 	157276EP15	58.70	Chrome	6
		157276EP15BN	85.15	Brushed Nickel	6
		157276EP15ORB	93.70	Oil Rubbed Bronze	6
	<ul style="list-style-type: none"> • showerhead functions: one-function • showerhead type: eco-performance handshower • showerhead size: 4-3/64" diameter spray head • type of function: full spray • flow rate: 2.0 transitioning to 1.75 gpm • double check valve: included 	164929	58.70	Chrome	6
		164929NL	84.90	Polished Nickel	6
		164929BN	85.15	Brushed Nickel	6
		164929ORB	93.70	Oil Rubbed Bronze	6
	<ul style="list-style-type: none"> • showerhead functions: one-function • showerhead type: eco-performance handshower • showerhead size: 4-3/64" diameter spray head • type of function: full spray • flow rate: 2.0 transitioning to 1.75 gpm • double check valve: included • carded packaging: yes 	CL155747	58.70	Chrome	6
		CL155747BN	85.15	Brushed Nickel	6
 <p>NEW! Ships Q2</p>	<ul style="list-style-type: none"> • showerhead functions: one-function • showerhead type: eco-performance handshower • showerhead size: 1-1/8" diameter spray head • type of function: full spray • flow rate: 1.75 gpm (6.65 L/min) max. • double check valve: included 	189318	58.70	Chrome	6
		189318BN	85.15	Brushed Nickel	6
		189318SRN ●	85.15	Spot Resist Brushed Nickel	6
		189318ORB	93.70	Oil Rubbed Bronze	6
		189318BRB	93.70	Mediterranean Bronze	6
 <p>NEW!</p>	<ul style="list-style-type: none"> • showerhead functions: five-function • showerhead type: eco-performance handshower • showerhead size: 4-3/8" diameter spray head • type of function: downpour; rinse; massage; relaxing massage; full spray • flow rate: 1.75 gpm (6.65 L/min) max. • double check valve: included 	Ships Q1 189315	55.00	Chrome	6
		Ships Q1 189315BN	74.25	Brushed Nickel	6
		Ships Q1 189315ORB	81.70	Oil Rubbed Bronze	6
		Ships Q2 189315BL	81.70	Matte Black	6
	<ul style="list-style-type: none"> • showerhead functions: five-function • showerhead type: eco-performance handshower • showerhead size: 4" diameter spray head • type of function: targeted massage; relaxing spray; refreshing spray; invigorating spray; energizing spray • flow rate: 2.0 transitioning to 1.75 gpm • double check valve: included 	180238	47.90	Chrome	6





NOTES

- Spot Resist Stainless Finish **SPOT RESIST**

CL Prefix: Indicates carded product for peg hook merchandising.

Handheld Showers

All Brushed Nickel, Polished Nickel and Polished Brass faucet components feature the Lifeshine® Non-Tarnish Finish.





HANDHELD (CONTINUED)		MODEL NUMBER	LIST PRICE	FINISH/ CONNECTION	CASE QTY	
	<ul style="list-style-type: none"> length: 30" slide bar: not to be used as a grab bar use secure mount anchor: to meet handgrip requirement 	154296	257.80	Chrome	6	
		154296BN	283.55	Brushed Nickel	6	
		154296NL	311.90	Polished Nickel	6	
		154296ORB	311.90	Oil Rubbed Bronze	6	
		SECUREMOUNT ANCHORS SOLD SEPARATELY				
		A750	29.50	N/A or Unfinished	24	
	<ul style="list-style-type: none"> length: 24" slide bar: not to be used as a grab bar use secure mount anchor: to meet handgrip requirement 	155746	183.05	Chrome	6	
		155746BN	265.40	Brushed Nickel	6	
		155746ORB	291.95	Oil Rubbed Bronze	6	
		SECUREMOUNT ANCHORS SOLD SEPARATELY				
				A750	29.50	N/A or Unfinished
	<ul style="list-style-type: none"> length: 30" slide bar: not to be used as a grab bar use secure mount anchor: to meet handgrip requirement 	A742	159.60	Chrome	6	
		A742SRN ●	231.55	Spot Resist Brushed Nickel	6	
		A742BN	231.55	Brushed Nickel	6	
		A742BRB	254.70	Mediterranean Bronze	6	
		A742ORB	254.70	Oil Rubbed Bronze	6	
		SECUREMOUNT ANCHORS SOLD SEPARATELY				
		A750	29.50	N/A or Unfinished	24	
	<ul style="list-style-type: none"> length: 30" slide bar: not to be used as a grab bar use secure mount anchor: to meet handgrip requirement 	A735	147.60	Chrome	6	
		A735CP	169.70	Chrome/Polished Brass	6	
		A735BN	214.00	Brushed Nickel	6	
		A735ORB	227.15	Oil Rubbed Bronze	6	
		A735P	227.15	Polished Brass	6	
		A735WR	227.15	Wrought Iron	6	
		SECUREMOUNT ANCHORS SOLD SEPARATELY				
		A750	29.50	N/A or Unfinished	24	

NOTES

- Spot Resist Stainless Finish **SPOT RESIST**

Showering Accessories

All Brushed Nickel, Polished Nickel and Polished Brass faucet components feature the Lifeshine® Non-Tarnish Finish.

		MODEL NUMBER	LIST PRICE	FINISH/ CONNECTION	CASE QTY
HOSE					
	<ul style="list-style-type: none"> • connection size: 1/2" • connection type: IPS • hose length: 80" 	A780	111.50	Chrome	20
	<ul style="list-style-type: none"> • connection size: 1/2" • connection type: IPS • hose length: 69" • use brown (br) for oil rubbed bronze (orb)-; mediterranean bronze (brb) • use satine (st) for brushed nickel (bn) 	A726 A726WR A726NL A726P A726ST A726BR A726SRN ●	94.55 107.65 168.80 168.80 168.80 174.95 168.80	Chrome Wrought Iron Polished Nickel Polished Brass Satine Brown Spot Resist Brushed Nickel	12 6 24 24 24 12 12
	<ul style="list-style-type: none"> • connection size: 1/2" • connection type: IPS • hose length: 59" • use brown (br) for oil rubbed bronze (orb) 	155748 155748BN 155748BL 155748BR	35.00 50.85 75.00 75.00	Chrome Brushed Nickel Matte Black Brown	8 8 8 8
	<ul style="list-style-type: none"> • connection size: 1/2" • connection type: IPS • hose length: 59" 	CL155748 CL155748BN	35.00 50.85	Chrome Brushed Nickel	12 12

NOTES







- Spot Resist Stainless Finish **SPOT RESIST**

CL Prefix: Indicates carded product for peg hook merchandising.

Showering Accessories

All Brushed Nickel, Polished Nickel and Polished Brass faucet components feature the Lifeshine® Non-Tarnish Finish.

CUSTOM SHOWERING





		MODEL NUMBER	LIST PRICE	FINISH/ CONNECTION	CASE QTY
TWIN ELL					
 <ul style="list-style-type: none"> • description: twin ell • connection size: 1/2" x 1/2" x 3/4" • connection type: IPS • usage: with tub/shower installations where needed 		128284	25.65	N/A or Unfinished	12
	<hr/>				
DROP ELL					
 <ul style="list-style-type: none"> • connection size: 1/2" • connection type: IPS • integral handshower cradle: included 		A755	126.30	Chrome	12
		A755BN	183.15	Brushed Nickel	12
		A755ORB	201.50	Oil Rubbed Bronze	12
<hr/>					
 <ul style="list-style-type: none"> • description: drop ell • connection size: 1/2" • connection type: IPS 		A721	63.15	Chrome	12
		A721BN	89.05	Brushed Nickel	12
		A721SRN ●	89.05	Spot Resist Brushed Nickel	12
		A721BRB	97.95	Mediterranean Bronze	12
		A721ORB	97.95	Oil Rubbed Bronze	12
<hr/>					
 <ul style="list-style-type: none"> • description: drop ell • connection size: 1/2" • connection type: IPS 		A725	49.40	Chrome	12
		A725CBN	69.75	Classic Brushed Nickel	12
		A725BN	69.90	Brushed Nickel	12
		A725NL	69.90	Polished Nickel	12
		A725P	69.90	Polished Brass	12
		A725ORB	76.90	Oil Rubbed Bronze	12
		A725WR	76.90	Wrought Iron	12

NOTES

- Spot Resist Stainless Finish 

Showering Accessories

All Brushed Nickel, Polished Nickel and Polished Brass faucet components feature the Lifeshine® Non-Tarnish Finish.

		MODEL NUMBER	LIST PRICE	FINISH/ CONNECTION	CASE QTY
GRAB BARS					
	<ul style="list-style-type: none"> description: secure mount anchors use secure mount anchor: to meet handgrip requirement 	A750	29.50	N/A or Unfinished	24
WALL BRACKET					
	<ul style="list-style-type: none"> integral handshower cradle: included metal construction: yes 	114348	81.60	Chrome	12
		114348NL	94.80	Polished Nickel	12
		114348BN	118.30	Chrome	12
		114348ORB	130.10	Oil Rubbed Bronze	12
		114348WR	130.10	Wrought Iron	12
	<ul style="list-style-type: none"> integral handshower cradle: included 	A730	48.30	Chrome	12
		A730P	112.00	Polished Brass	12
		A730ST	112.00	Satine	12
	<ul style="list-style-type: none"> integral handshower cradle: included 	155694	22.65	Chrome	12
		155694BN	32.70	Brushed Nickel	12
		155694ORB	36.10	Oil Rubbed Bronze	12
	<ul style="list-style-type: none"> integral handshower cradle: included 	CL155694	22.65	Chrome	12
		CL155694BN	32.70	Brushed Nickel	12
VACUUM BREAKER					
	<ul style="list-style-type: none"> connection size: 1/2" connection type: IPS 	A714	39.65	Chrome	24
		A714ST	57.55	Satine	24
		A714ORB	63.30	Oil Rubbed Bronze	12
		A714WR	63.30	Wrought Iron	12











Showering Accessories

All Brushed Nickel and Polished Brass faucet components feature the Lifeshine® Non-Tarnish Finish.

		MODEL NUMBER	LIST PRICE	FINISH/ CONNECTION	CASE QTY
SHOWER ARM CRADLE/DIVERTER					
 <ul style="list-style-type: none"> • connection size: 1/2" • connection type: IPS • type of function: two independent one shared • integral handshower cradle: included • metal construction • carded packaging: yes 		CL707	106.45	Chrome	12
		CL707BN	154.30	Brushed Nickel	12
		CL707ORB	169.80	Oil Rubbed Bronze	12
 <ul style="list-style-type: none"> • connection size: 1/2" • connection type: IPS • type of function: two independent one shared • metal construction • carded packaging: yes 		CL703	78.40	Chrome	12
		CL703BN	113.70	Brushed Nickel	12
		CL703ORB	125.10	Oil Rubbed Bronze	12
 <ul style="list-style-type: none"> • connection size: 1/2" • connection type: IPS • type of function: two discrete • metal construction 		A720	70.50	Chrome	12
		A720P	84.55	Polished Brass	12
		A720BN	95.75	Brushed Nickel	12
		A720ORB	105.30	Oil Rubbed Bronze	12
SHOWER ARM CRADLE/DIVERTER					
 <ul style="list-style-type: none"> • connection size: 1/2" • connection type: IPS • integral handshower cradle: included • metal construction: yes 		A701	46.00	Chrome	12
		A701BN	66.60	Brushed Nickel	12
		A701ORB	73.25	Oil Rubbed Bronze	12
 <ul style="list-style-type: none"> • connection size: 1/2" • connection type: IPS • integral handshower cradle: included • metal construction: yes 		CLA701	46.00	Chrome	12
		CLA701BN	66.60	Brushed Nickel	12

Body Sprays

All Brushed Nickel, Polished Nickel and Polished Brass faucet components feature the Lifeshine® Non-Tarnish Finish.







		MODEL NUMBER	LIST PRICE	FINISH/ CONNECTION	CASE QTY
BODY SPRAYS					
 <ul style="list-style-type: none"> showerhead functions: two-function showerhead type: standard showerhead size: 3-1/4" diameter spray head type of function: targeted massage; full spray flow rate: 2.0 gpm (7.6 L/min) max. 1" extension kit available: 155656 	PREMIUM				
		TS1420	199.15	Chrome	6
		TS1420BN	269.90	Brushed Nickel	6
		TS1420NL	269.90	Polished Nickel	6
		TS1420ORB	297.00	Oil Rubbed Bronze	6
 <ul style="list-style-type: none"> spray functions: two-function showerhead type: standard showerhead size: 3-1/4" diameter spray head flow rate: 2.0 gpm (7.6 L/min) max. 1" extension kit available: 155656 valve: sold separately 	PREMIUM				
		TS1422	199.15	Chrome	6
		TS1422BN	269.90	Brushed Nickel	6
		TS1422NL	269.90	Polished Nickel	6
		TS1422ORB	297.00	Oil Rubbed Bronze	6
 <ul style="list-style-type: none"> spray functions: one-function showerhead type: standard showerhead size: 3-1/4" diameter spray head flow rate: 2.0 gpm (7.6 L/min) max. 1" extension kit available: 155656 valve: sold separately 	PREMIUM				
		TS1320	128.75	Chrome	6
		TS1320BN	181.45	Brushed Nickel	6
		TS1320NL	181.45	Polished Nickel	6
		TS1320ORB	204.80	Oil Rubbed Bronze	6
 <ul style="list-style-type: none"> spray functions: one-function showerhead type: standard showerhead size: 3-1/4" diameter spray head flow rate: 2.0 gpm (7.6 L/min) max. 1" extension kit available: 155656 valve: sold separately 	PREMIUM				
		TS1322	128.75	Chrome	6
		TS1322BN	181.45	Brushed Nickel	6
		TS1322NL	181.45	Polished Nickel	6
		TS1322ORB	204.80	Oil Rubbed Bronze	6
BODY SPRAY ROUGH IN					
  <ul style="list-style-type: none"> installation: fits standard 2x4 wall 	PREMIUM				
		S1300	87.80	1/2" CC, IPS	6
BODY SPRAY					
  <ul style="list-style-type: none"> connection size: 1/2" connection type: IPS spray functions: one-function showerhead size: 2" diameter spray head 		A501	91.70	Chrome	12
		A501BN	114.65	Brushed Nickel	12
		A501NL	114.65	Polished Nickel	12
		A501P	114.65	Polished Brass	12
		A501ORB	126.10	Oil Rubbed Bronze	12
		A501WR	126.10	Wrought Iron	12

NOTES

 Moen® **M•PACT**® Common Valve System
 Immersion® Rainshower





Diverter Tub Spouts

All Brushed Nickel and Polished Nickel faucet components feature the Lifeshine® Non-Tarnish Finish.

		MODEL NUMBER	LIST PRICE	FINISH/ CONNECTION	CASE QTY
DIVERTING TUB SPOUT					
 <ul style="list-style-type: none"> • connection size: 1/2" • connection type: slip fit • spout length: 6 3/4" • tub spout type: diverter 		PREMIUM			
		S12104	146.05	Chrome	6
		S12104BN	231.30	Brushed Nickel	6
		S12104NL	233.60	Polished Nickel	6
		S12104ORB	254.40	Oil Rubbed Bronze	6
 <ul style="list-style-type: none"> • connection size: 1/2" • connection type: slip fit • spout length: 7 1/4" • tub spout type: diverter 		PREMIUM			
		S3896	95.30	Chrome	6
		S3896BN	138.20	Brushed Nickel	6
 <ul style="list-style-type: none"> • connection size: 1/2" • connection type: slip fit • spout length: 6 3/4" • tub spout type: diverter 		PREMIUM			
		S114	128.95	Chrome	6
		S114BN	211.05	Brushed Nickel	6
		S114NL	211.05	Polished Nickel	6
		S114ORB	232.05	Oil Rubbed Bronze	6
 <ul style="list-style-type: none"> • connection size: 1/2" • connection type: slip fit • spout length: 7 1/8" • tub spout type: diverter 		PREMIUM			
		S3900	128.45	Chrome	6
 <ul style="list-style-type: none"> • connection size: 1/2" • connection type: IPS • spout length: 7 1/4" • tub spout type: diverter 		PREMIUM			
		S3894	99.55	Chrome	6
 <ul style="list-style-type: none"> • connection size: 1/2" • connection type: slip fit • spout length: 7 5/8" • tub spout type: diverter 		PREMIUM			
		S3859	95.30	Chrome	6
		S3859BN	138.20	Brushed Nickel	6
		S3859ORB	151.90	Oil Rubbed Bronze	6







Diverter Tub Spouts

All Brushed Nickel faucet components feature the Lifeshine® Non-Tarnish Finish.

		MODEL NUMBER	LIST PRICE	FINISH/ CONNECTION	CASE QTY
DIVERTING TUB SPOUT (CONTINUED)					
	<ul style="list-style-type: none"> • connection size: 1/2" • connection type: slip fit • spout length: 7 1/4" • tub spout type: diverter 	PREMIUM			
		S3840	79.75	Chrome	6
		S3840BN	123.55	Brushed Nickel	6
	<ul style="list-style-type: none"> • connection size: 1/2" • connection type: slip fit • spout length: 7 1/8" • tub spout type: diverter 	165914	137.15	Chrome	6
		165914BN	232.60	Brushed Nickel	6
	<ul style="list-style-type: none"> • connection size: 1/2" • connection type: slip fit • spout length: 7 3/4" • tub spout type: diverter 	185820	93.25	Chrome	6
		185820BN	111.25	Brushed Nickel	6
		185820ORB	121.15	Oil Rubbed Bronze	6
	<ul style="list-style-type: none"> • connection size: 1/2" • connection type: IPS • spout length: 5 1/2" • tub spout type: diverter 	3809BN	92.10	Brushed Nickel	12
	<ul style="list-style-type: none"> • connection size: 1/2" • connection type: slip fit • spout length: 6" • tub spout type: diverter 	179791	86.55	Chrome	6
		179791BN	110.10	Brushed Nickel	6
	<ul style="list-style-type: none"> • connection size: 1/2" • connection type: IPS • spout length: 7 1/4" • tub spout type: diverter 	3814	74.65	Chrome	6
		3814BN	108.25	Brushed Nickel	6
		3814ORB	119.10	Oil Rubbed Bronze	6
	<ul style="list-style-type: none"> • connection size: 1/2" • connection type: slip fit • spout length: 7 1/4" • tub spout type: diverter 	3857	73.20	Chrome	6
		3857BN	106.25	Brushed Nickel	6
		3857ORB	116.90	Oil Rubbed Bronze	6

Diverter Tub Spouts

All Brushed Nickel, Polished Nickel and Polished Brass faucet components feature the Lifeshine® Non-Tarnish Finish.

		MODEL NUMBER	LIST PRICE	FINISH/ CONNECTION	CASE QTY
DIVERTING TUB SPOUT (CONTINUED)					
	<ul style="list-style-type: none"> • connection size: 1/2" • connection type: IPS • spout length: 5" • tub spout type: diverter 	3806	72.90	Chrome	12
		3806W	109.35	Glacier	12
	<ul style="list-style-type: none"> • connection size: 1/2" • connection type: slip fit • spout length: 5" • tub spout type: diverter 	3807	72.90	Chrome	12
		3807CP	77.30	Chrome/Polished Brass	12
		3807BN	101.85	Brushed Nickel	12
	<ul style="list-style-type: none"> • connection size: 1/2" • connection type: slip fit • spout length: 7 3/8" • tub spout type: non diverter 	3737	72.75	Chrome	6
		3737BN	105.55	Brushed Nickel	6
		3737ORB	116.15	Oil Rubbed Bronze	6
	<ul style="list-style-type: none"> • connection size: 1/2" • connection type: slip fit • spout length: 7 3/4" • tub spout type: diverter 	161955	72.05	Chrome	6
		161955BN	111.70	Brushed Nickel	6
		161955ORB	122.90	Oil Rubbed Bronze	6
	<ul style="list-style-type: none"> • connection size: 1/2" • connection type: slip fit • spout length: 7 15/16" • tub spout type: diverter 	175385	71.65	Chrome	6
		175385BN	111.20	Brushed Nickel	6
		175385NL	111.20	Polished Nickel	6
		175385ORB	122.20	Oil Rubbed Bronze	6
	<ul style="list-style-type: none"> • connection size: 1/2" • connection type: slip fit • spout length: 7 1/8" • tub spout type: diverter 	172656	68.30	Chrome	6
		172656BN	108.25	Brushed Nickel	6
		172656BL	119.10	Matte Black	6
	<ul style="list-style-type: none"> • connection size: 1/2" • connection type: IPS • spout length: 7 1/8" • tub spout type: diverter 	172657	68.30	Chrome	6
		172657BN	108.25	Brushed Nickel	6







Diverter Tub Spouts

All Brushed Nickel and Polished Brass faucet components feature the Lifeshine® Non-Tarnish Finish.

		MODEL NUMBER	LIST PRICE	FINISH/ CONNECTION	CASE QTY
DIVERTING TUB SPOUT (CONTINUED)					
	<ul style="list-style-type: none"> • connection size: 1/2" • connection type: CC • spout length: 6 1/2" • tub spout type: diverter 	3890	66.95	Chrome	12
		3890BN	97.15	Brushed Nickel	12
	<ul style="list-style-type: none"> • connection size: 1/2" • connection type: slip fit • spout length: 5 1/2" • tub spout type: diverter 	3808	66.45	Chrome	12
		3808BN	96.10	Brushed Nickel	12
		3808P	102.90	Polished Brass	12
		3808ORB	105.80	Oil Rubbed Bronze	12
		3808WR	105.80	Wrought Iron	12
	<ul style="list-style-type: none"> • connection size: 1/2" • connection type: IPS • spout length: 5 1/2" • tub spout type: diverter 	3800	60.30	Chrome	12
	<ul style="list-style-type: none"> • connection size: 1/2" • connection type: slip fit • spout length: 5 1/2" • tub spout type: diverter 	3801	60.30	Chrome	12
	<ul style="list-style-type: none"> • connection size: 1/2" • connection type: slip fit • spout length: 5 7/8" • tub spout type: diverter 	152027	59.45	Chrome	12
		152027BN	88.55	Brushed Nickel	12
	<ul style="list-style-type: none"> • connection size: 1/2" • connection type: slip fit • spout length: 6 1/2" • tub spout type: diverter 	3972	55.20	Chrome	12
		3972BN	85.60	Brushed Nickel	12
	<ul style="list-style-type: none"> • connection size: 1/2" • connection type: IPS • spout length: 7" • tub spout type: diverter 	3830	53.50	Chrome	12
		3830P	123.10	Polished Brass	12

Diverter Tub Spouts

All Brushed Nickel faucet components feature the Lifeshine® Non-Tarnish Finish.











DIVERTING TUB SPOUT (CONTINUED)		MODEL NUMBER	LIST PRICE	FINISH/ CONNECTION	CASE QTY
	<ul style="list-style-type: none"> • connection size: 1/2" • connection type: IPS • spout length: 5 1/2" • tub spout type: diverter 	3911	53.35	Chrome	12
	<ul style="list-style-type: none"> • connection size: 1/2" • connection type: slip fit • spout length: 5 1/2" • tub spout type: diverter 	3960	53.35	Chrome	12
	<ul style="list-style-type: none"> • connection size: 1/2" • connection type: slip fit • spout length: 7" • tub spout type: diverter 	3853	53.15	Chrome	12
		3853SRN ●	74.40	Spot Resist Brushed Nickel	12
		3853BRB	81.85	Mediterranean Bronze	12
		3853BN	110.35	Brushed Nickel	12
3853ORB	121.35	Oil Rubbed Bronze	12		
	<ul style="list-style-type: none"> • connection size: 1/2" • connection type: slip fit • spout length: 7" • tub spout type: diverter 	3839	52.00	Chrome	12
		3839BN	75.40	Brushed Nickel	1
	<ul style="list-style-type: none"> • connection size: 1/2" • connection type: IPS • spout length: 5 1/2" • tub spout type: diverter 	3926	50.45	Chrome	12
	<ul style="list-style-type: none"> • connection size: 1/2" • connection type: slip fit • spout length: 5 1/2" • tub spout type: diverter 	3931	50.45	Chrome	12
		3929BC	83.60	Brushed Chrome	12

NOTES

● Spot Resist Stainless Finish 







Non-Diverter Tub Spouts

All Brushed Nickel and Polished Nickel faucet components feature the Lifeshine® Non-Tarnish Finish.

		MODEL NUMBER	LIST PRICE	FINISH/ CONNECTION	CASE QTY
NON-DIVERTING TUB SPOUT					
	<ul style="list-style-type: none"> • connection size: 1/2" • connection type: slip fit • spout length: 6 3/4" • tub spout type: non diverter 	PREMIUM			
		S12105	131.45	Chrome	6
		S12105BN	190.65	Brushed Nickel	6
		S12105NL	190.65	Polished Nickel	6
		S12105ORB	209.70	Oil Rubbed Bronze	6
	<ul style="list-style-type: none"> • connection size: 1/2" • connection type: slip fit • spout length: 7 1/8" • tub spout type: non diverter 	S16900	123.45	Chrome	1
		S16900BN	209.35	Brushed Nickel	1
	<ul style="list-style-type: none"> • connection size: 1/2" • connection type: slip fit • spout length: 7 1/8" • tub spout type: non diverter 	PREMIUM			
	<ul style="list-style-type: none"> • connection size: 1/2" • connection type: slip fit • spout length: 7 5/8" • tub spout type: non diverter 	PREMIUM			
	<ul style="list-style-type: none"> • connection size: 1/2" • connection type: slip fit • spout length: 7 1/4" • tub spout type: non diverter 	S3860	93.75	Chrome	6
		S3860BN	136.00	Brushed Nickel	6
		S3860ORB	149.45	Oil Rubbed Bronze	6
	<ul style="list-style-type: none"> • connection size: 1/2" • connection type: slip fit • spout length: 7 1/4" • tub spout type: non diverter 	PREMIUM			
		S3898	93.75	Chrome	6
	<ul style="list-style-type: none"> • connection size: 1/2" • connection type: slip fit • spout length: 7 3/4" • tub spout type: non diverter 	S3898BN	136.00	Brushed Nickel	6
		3858	65.70	Chrome	6
		3858BN	95.40	Brushed Nickel	6
	<ul style="list-style-type: none"> • connection size: 1/2" • connection type: slip fit • spout length: 7 1/4" • tub spout type: non diverter 	3858ORB	104.95	Oil Rubbed Bronze	6
		PREMIUM			
		191956	64.80	Chrome	6
	<ul style="list-style-type: none"> • connection size: 1/2" • connection type: slip fit • spout length: 7 3/4" • tub spout type: non diverter 	191956BN	94.00	Brushed Nickel	6
		191956ORB	103.40	Oil Rubbed Bronze	6
		PREMIUM			
	<ul style="list-style-type: none"> • connection size: 1/2" • connection type: slip fit • spout length: 7 15/16" • tub spout type: non diverter 	195386	64.50	Chrome	6
		195386BN	93.50	Brushed Nickel	6
		195386NL	93.50	Polished Nickel	6
		195386ORB	102.85	Oil Rubbed Bronze	6







Non-Diverter Tub Spouts

All Brushed Nickel faucet components feature the Lifeshine® Non-Tarnish Finish.

		MODEL NUMBER	LIST PRICE	FINISH/ CONNECTION	CASE QTY
NON-DIVERTING TUB SPOUT (CONTINUED)					
 <ul style="list-style-type: none"> • connection size: 1/2" • connection type: slip fit • spout length: 7 1/4" • tub spout type: non diverter 		PREMIUM			
		S3842	64.20	Chrome	6
		S3842BN	99.40	Brushed Nickel	6
 <ul style="list-style-type: none"> • connection size: 1/2" • connection type: slip fit • spout length: 6 1/2" • tub spout type: non diverter 		3892	54.60	Chrome	12
		3892BN	84.45	Brushed Nickel	12
		3892BL	92.90	Matte Black	6
 <ul style="list-style-type: none"> • connection size: 1/2" • connection type: slip fit • spout length: 5 1/2" • tub spout type: non diverter 		3959	51.95	Chrome	12
 <ul style="list-style-type: none"> • connection size: 1/2" • connection type: IPS • spout length: 7" • tub spout type: non diverter 		3828	44.65	Chrome	12
 <ul style="list-style-type: none"> • connection size: 1/2" • connection type: slip fit • spout length: 7" • tub spout type: non diverter 		3829	44.65	Chrome	12
		3829BC	74.00	Brushed Chrome	12
		3829BN	102.55	Brushed Nickel	12
		3829ORB	112.85	Oil Rubbed Bronze	12
 <ul style="list-style-type: none"> • connection size: 1/2" • connection type: IPS • spout length: 5" • tub spout type: non diverter 		3804	22.65	Chrome	12
 <ul style="list-style-type: none"> • connection size: 1/2" • connection type: slip fit • spout length: 5" • tub spout type: non diverter 		3805	22.65	Chrome	12

Bath Tub Drains



All Brushed Nickel, Polished Nickel and Polished Brass faucet components feature the Lifeshine® Non-Tarnish Finish.

		MODEL NUMBER	LIST PRICE	FINISH/ CONNECTION	CASE QTY
TUB DRAINS					
	<ul style="list-style-type: none"> • top & bottom ells: schedule 40 abs • thread size: 1-1/2" 	140680	12.80	N/A or Unfinished	12
	<ul style="list-style-type: none"> • top & bottom ells: schedule 40 pvc • thread size: 1-1/2" 	140690	14.40	N/A or Unfinished	12
	<ul style="list-style-type: none"> • conversion bar kit • converts 2-hole top ell to accommodate 1-hole face plate 	142538	5.15	N/A or Unfinished	180
	<ul style="list-style-type: none"> • connection size: 1 1/2" • connection type: threaded shoe • tubing type: 17 gauge brass • fits tubs: 24" • type of tee: cast brass 	90480 90480BN 90480ORB	138.75 218.75 231.25	Chrome Brushed Nickel Oil Rubbed Bronze	8 8 8
	<ul style="list-style-type: none"> • connection size: 1 1/2" • connection type: threaded shoe • tubing type: 20 gauge brass • fits tubs: 14 - 16" • type of tee: cast brass 	90410 90410BN 90410ORB	122.70 196.40 216.00	Chrome Brushed Nickel Oil Rubbed Bronze	10 10 10
	<ul style="list-style-type: none"> • connection size: 1 1/2" • connection type: threaded shoe • tubing type: white pvc • fits tubs: 14 - 16" 	90530	47.65	Chrome	10
	<ul style="list-style-type: none"> • connection size: 1 1/2" • connection type: male IPS; threaded shoe 	T90331 T90331BN T90331NL T90331ORB T90331P T90331WR	32.45 102.30 102.30 112.55 112.55 112.55	Chrome Brushed Nickel Polished Nickel Oil Rubbed Bronze Polished Brass Wrought Iron	12 12 12 12 12 12

NOTES

Bath Tub Drains

All Brushed Nickel and Polished Brass faucet components feature the Lifeshine® Non-Tarnish Finish.

SHOWER DRAINS		MODEL NUMBER	LIST PRICE	FINISH/ CONNECTION	CASE QTY
 <ul style="list-style-type: none"> • drain size: mounts on 2-5/8" centers 		101664BN	35.75	Brushed Nickel	12
		101664P	35.75	Polished Brass	1
		101664ORB	39.35	Oil Rubbed Bronze	12
		101664WR	39.35	Wrought Iron	12
 <ul style="list-style-type: none"> • drain size: mounts on 3-3/8" centers 		102763BN	35.75	Brushed Nickel	12
		102763P	35.75	Polished Brass	1
		102763ORB	39.35	Oil Rubbed Bronze	12
		102763WR	39.35	Wrought Iron	12
 <ul style="list-style-type: none"> • drain size: fits in 3" diameter drains 		101663P	26.25	Polished Brass	12
		101663BN	28.75	Brushed Nickel	12
		101663ORB	31.65	Oil Rubbed Bronze	12
		101663WR	31.65	Wrought Iron	12

Coordinating Bath Accessories

Kyvos™ Double Robe Hook / BP3703BN
Kyvos™ Paper Holder / BP3708BN
Kyvos™ 18" Towel Bar / BP3718BN
Kyvos™ Towel Ring / BP3786BN

Please see [moen.com/consumer-support/warranty](https://www.moen.com/consumer-support/warranty)
for complete product warranty information.

SAGE® Coordinating Bath Accessories

Moen® bath accessories CANNOT be combined with Moen® faucet parts on a Purchase Order.

Moen makes it easy to coordinate the entire style and look of the bathroom. Our Sage® bath accessories coordinate with most traditional faucet styles.

Bath accessory part numbers are included in the MF36 for reference purposes only.

For more information on ordering Sage® bath accessories or other Moen® bath accessories, contact Moen Bath Accessory Customer Service at **800-882-0116**, contact your local Moen sales representative, or visit us at www.moen.com.

MODEL NUMBER	LIST PRICE EACH	DESCRIPTION	QTY
Chrome (CH)			
DN6801CH	18.70	Tank Lever	3
DN6803CH	11.00	Single Robe Hook	3
DN6808CH	21.10	Paper Holder	3
DN6818CH	24.65	18" Towel Bar	3
DN6824CH	26.70	24" Towel Bar	3
DN6886CH	17.40	Towel Ring	3
Brushed Nickel (BN)			
DN6801BN	28.40	Tank Lever	12
DN6803BN	19.45	Single Robe Hook	12
DN6808BN	30.35	Paper Holder	3
DN6818BN	35.85	18" Towel Bar	3
DN6822BN	59.15	24" Double Towel Bar	3
DN6824BN	38.90	24" Towel Bar	3
DN6850BN	57.85	Freestanding Paper Holder	2
DN6886BN	27.15	Towel Ring	3
DN6890BN	58.60	Vanity Shelf	3
DN6892BN	111.65	Mirror	3
Oil Rubbed Bronze (ORB)			
DN6801ORB	32.70	Tank Lever	12
DN6803ORB	19.70	Single Robe Hook	24
DN6808ORB	33.55	Paper Holder	3
DN6818ORB	37.25	18" Towel Bar	3
DN6824ORB	40.50	24" Towel Bar	3
DN6886ORB	27.45	Towel Ring	3



DN6801
Tank Lever



DN6803
Single Robe Hook



DN6808
Paper Holder



DN6818
18" Towel Bar



DN6822
24" Double Towel Bar



DN6824
24" Towel Bar



DN6850
Freestanding Paper Holder



DN6886
Towel Ring



DN6890
Vanity Shelf



DN6892
Mirror

ISO™ Coordinating Bath Accessories

Moen® bath accessories CANNOT be combined with Moen® faucet parts on a Purchase Order.

Moen makes it easy to coordinate the entire style and look of the bathroom. Our Iso™ bath accessories coordinate with most modern faucet styles.

Bath accessory part numbers are included in the MF36 for reference purposes only.

For more information on ordering Iso™ bath accessories or other Moen® bath accessories, contact Moen Bath Accessory Customer Service at **800-882-0116**, contact your local Moen sales representative, or visit us at **www.moen.com**.

MODEL NUMBER	LIST PRICE EACH	DESCRIPTION	QTY
Chrome (CH)			
DN0703CH	18.65	Single Robe Hook	12
DN0705CH	8.05	Drawer Knob	48
DN0707CH	16.00	Drawer Pull	48
P DN0708CH	39.60	Pivoting Paper Holder	3
DN0709CH	33.75	Single-Post Paper Holder	3
DN0718CH	36.45	18" Towel Bar	3
DN0722CH	59.45	24" Double Towel Bar	3
DN0724CH	39.60	24" Towel Bar	3
DN0786CH	25.75	Towel Ring	3
DN0790CH	66.55	Vanity Shelf	3
P DN0792CH	96.15	Mirror	3
DN0794CH	155.85	Towel Shelf	2
Brushed Nickel (BN)			
DN0703BN	20.95	Single Robe Hook	24
DN0705BN	9.35	Drawer Knob	144
DN0707BN	17.25	Drawer Pull	144
P DN0708BN	44.60	Pivoting Paper Holder	3
DN0709BN	37.70	Single-Post Paper Holder	3
DN0718BN	40.95	18" Towel Bar	3
DN0722BN	66.75	24" Double Towel Bar	3
DN0724BN	44.60	24" Towel Bar	3
DN0786BN	28.95	Towel Ring	3
DN0790BN	74.90	Vanity Shelf	3
P DN0792BN	108.25	Mirror	3
DN0794BN	168.50	Towel Shelf	2



DN0703
Single Robe Hook



DN0705
Drawer Knob



DN0707
Drawer Pull



P DN0708
Pivoting Paper Holder



DN0709
Single-Post Paper Holder



DN0718
18" Towel Bar



DN0722
24" Double Towel Bar



DN0724
24" Towel Bar



DN0786
Towel Ring



DN0790
Vanity Shelf

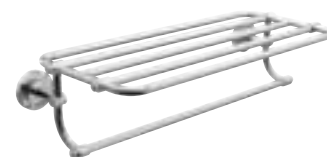

DN0794
Towel Shelf



P DN0792
Mirror with Pivoting Decorative Hardware

P Denotes pivoting paper holder/mirror

List price is per each (unless otherwise noted). Product can be ordered by case quantity or individually.

COORDINATING ACCESSORIES

ISO™ Coordinating Bath Accessories

COORDINATING ACCESSORIES

LIGHTING

MODEL NUMBER	LIST PRICE EACH	DESCRIPTION	QTY
Chrome (CH)			
DN0761CH	107.80	One Globe Bath Light	2
DN0762CH	153.85	Two Globe Bath Light	2
DN0763CH	188.70	Three Globe Bath Light	2
DN0764CH	241.75	Four Globe Bath Light	2
Brushed Nickel (BN)			
DN0761BN	135.75	One Globe Bath Light	2
DN0762BN	190.05	Two Globe Bath Light	2
DN0763BN	236.00	Three Globe Bath Light	2
DN0764BN	302.15	Four Globe Bath Light	2
Replacement Globe			
DN0769	19.90	Replacement Globe	3



Bulbs not included.

All lighting fixtures can be mounted facing either upward or downward.

List price is per each (unless otherwise noted). Product can be ordered by case quantity or individually.



DN0762
Two-Globe Light

DN0761
One-Globe Light

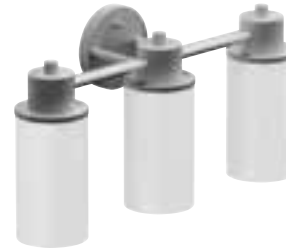

DN0763
Three-Globe Light



DN0764
Four-Globe Light



DN0769
Replacement
Globe

GRAB BARS



SecureMount™ Grab Bars are manufactured with an innovative flange design that makes it easy to connect to the stud at multiple points.

To install grab bars securely without studs, use SecureMount™ Anchors. Sold separately.

Poly-bagged

MODEL NUMBER	LIST PRICE EACH	DESCRIPTION	QTY
1-1/4" • Chrome (CH)			
YG0712CH	62.00	12" Designer Grab Bar	6
YG0718CH	65.40	18" Designer Grab Bar	6
YG0724CH	68.75	24" Designer Grab Bar	6
YG0736CH	78.30	36" Designer Grab Bar	6
YG0742CH	115.10	42" Designer Grab Bar	6
1-1/4" • Brushed Nickel (BN)			
YG0712BN	69.50	12" Designer Grab Bar	6
YG0718BN	73.20	18" Designer Grab Bar	6
YG0724BN	76.95	24" Designer Grab Bar	6
YG0736BN	87.65	36" Designer Grab Bar	6
YG0742BN	129.70	42" Designer Grab Bar	6



YG0724
1-1/4" Diameter x 24" length



Complies with Americans with Disabilities Act (ADA) specifications. SecureMount™ Grab Bars are tested to withstand 500 lb. pull when securely installed per instructions.

List price is per each (unless otherwise noted). Product can be ordered by case quantity or individually.

RETREAT® Coordinating Bath Accessories

Moen® bath accessories CANNOT be combined with Moen® faucet parts on a Purchase Order.

Moen makes it easy to coordinate the entire style and look of the bathroom. Our Retreat® bath accessories coordinate with most transitional faucet styles.

Bath accessory part numbers are included in the MF36 for reference purposes only.

For more information on ordering Retreat® bath accessories or other Moen® bath accessories, contact Moen Bath Accessory Customer Service at **800-882-0116**, contact your local Moen sales representative, or visit us at **www.moen.com**.

MODEL NUMBER	LIST PRICE EACH	DESCRIPTION	QTY
Chrome (CH)			
DN8303CH	14.05	Single Robe Hook	24
P DN8308CH	26.90	Pivoting Paper Holder	3
DN8318CH	27.50	18" Towel Bar	3
DN8322CH	45.45	24" Double Towel Bar	3
DN8324CH	29.80	24" Towel Bar	3
DN8386CH	19.45	Towel Ring	3
DN8390CH	50.80	Vanity Shelf	3
Brushed Nickel (BN)			
DN8303BN	15.70	Single Robe Hook	24
P DN8308BN	30.00	Pivoting Paper Holder	3
DN8318BN	30.75	18" Towel Bar	3
DN8322BN	50.80	24" Double Towel Bar	3
DN8324BN	33.35	24" Towel Bar	3
DN8386BN	21.70	Towel Ring	3
DN8390BN	56.65	Vanity Shelf	3



DN8303
Single Robe Hook



P DN8308
Pivoting Paper Holder



DN8318
18" Towel Bar



DN8322
24" Double Towel Bar



DN8324
24" Towel Bar



DN8386
Towel Ring



DN8390
Vanity Shelf

COORDINATING ACCESSORIES

P Denotes pivoting paper holder/mirror

List price is per each (unless otherwise noted). Product can be ordered by case quantity or individually.

KYVOS™ Coordinating Bath Accessories

Moen® bath accessories CANNOT be combined with Moen® faucet parts on a Purchase Order.

Moen makes it easy to coordinate the entire style and look of the bathroom. Kyvos™ bath accessories have definitive angles that bring a super-modern Art Deco influence to this contemporary collection.

Bath accessory part numbers are included in the MF36 for reference purposes only.

For more information on ordering Kyvos™ bath accessories or other Moen® bath accessories, contact Moen Bath Accessory Customer Service at **800-882-0116**, contact your local Moen sales representative, or visit us at www.moen.com.

MODEL NUMBER	LIST PRICE EACH	DESCRIPTION	QTY
Chrome (CH)			
BP3703CH	23.00	Double Robe Hook	24
BP3708CH	31.80	Paper Holder	6
BP3718CH	45.10	18" Towel Bar	6
BP3724CH	47.10	24" Towel Bar	6
BP3786CH	33.80	Towel Ring	6
Brushed Nickel (BN)			
BP3703BN	25.90	Double Robe Hook	24
BP3708BN	35.75	Paper Holder	6
BP3718BN	50.65	18" Towel Bar	6
BP3724BN	55.10	24" Towel Bar	6
BP3786BN	38.00	Towel Ring	6



BP3703
Double Robe Hook



BP3708
Paper Holder



BP3718
18" Towel Bar



BP3724
24" Towel Bar



BP3786
Towel Ring

MOEN® Coordinating Bath Accessories

Moen® bath accessories CANNOT be combined with Moen® faucet parts on a Purchase Order.

Moen makes it easy to coordinate the entire style and look of the bathroom. Our shower rods perfectly coordinate with style and finish of our faucets. Total coordination of the bath has never been easier.

Bath accessory part numbers are included in the MF36 for reference purposes only.

For more information on ordering bath accessories, contact Moen Bath Accessory Customer Service at **800-882-0116**, contact your local Moen® sales representative, or visit us at www.moen.com.

CURVED SHOWER RODS AC

MODEL NUMBER	LIST PRICE EACH	DESCRIPTION	QTY
Chrome (CH)			
CSR2160CH	48.90	Adjustable Curved Shower Rod	10
CSR2164CH	48.90	Adjustable Curved Shower Rod	10
CSR2165CH	38.70	5' Curved Shower Rod	10
DN2141CH	66.40	Adjustable Curved Shower Rod	2
Brushed Nickel (BN)			
CSR2160BN	53.80	Adjustable Curved Shower Rod	10
CSR2164BN	53.80	Adjustable Curved Shower Rod	10
CSR2165BN	41.40	5' Curved Shower Rod	10
DN2141BN	72.35	Adjustable Curved Shower Rod	2
Old World Bronze (OWB)			
CSR2160OWB	61.55	Adjustable Curved Shower Rod	10
CSR2164OWB	61.55	Adjustable Curved Shower Rod	10
CSR2165OWB	49.75	5' Curved Shower Rod	10
DN2141OWB	84.25	Adjustable Curved Shower Rod	2



TENSION RODS

MODEL NUMBER	LIST PRICE EACH	DESCRIPTION	QTY
Chrome (CH)			
TR1000CH	33.25	Tension Rod	3
Brushed Nickel (BN)			
TR1000BN	33.25	Tension Rod	3
Old World Bronze (OWB)			
TR1000OWB	33.25	Tension Rod	3

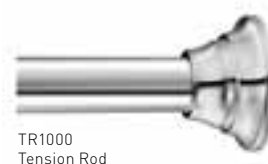

SHOWER RINGS

MODEL NUMBER	LIST PRICE EACH	DESCRIPTION	QTY
Chrome (CH)			
SR2100CH	11.95	Shower Curtain Rings	25
Brushed Nickel (BN)			
SR2100BN	13.70	Shower Curtain Rings	25
Old World Bronze (OWB)			
SR2100OWB	13.90	Shower Curtain Rings	25



List price is per each (unless otherwise noted). Product can be ordered by case quantity or individually.

COORDINATING ACCESSORIES

The SecureMount™ System

Install Grab Bars Anywhere on the Wall!

SecureMount Grab Bars and SecureMount Anchors make it possible to quickly and easily install a grab bar with or without studs.

COORDINATING ACCESSORIES

Did you know:

- 16" grab bars can mount directly into studs because the standard stud size is 16" on center.
- 18", 24", 36", and 42" grab bars will often need an anchoring system when mounted into drywall, as an alternative to stud or wood block installation.

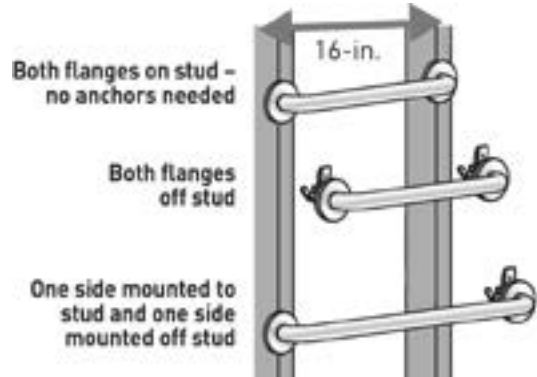

The SecureMount System—Easy, Secure Install ... Anywhere on the Wall!™



SecureMount Grab Bars

The unique flange makes it easy to connect to the stud at multiple points, at any angle!

SecureMount Anchors

Precision engineered for optimal bracing behind the wall, SecureMount Anchors allow for easy grab bar installation — with no studs required — anywhere on the wall.

SecureMount System

The SecureMount System is the ultimate in easy, secure grab bar installation. Plus it provides stylish designs and choices in finishes and features.

SecureMount Anchors Are Versatile.

Installs anywhere on the wall and can be used with all Moen and virtually all other grab bars. Mount securely to a variety of substrates*:

- 1/2" Drywall
- 1/2" Drywall with tile
- 1/2" Drywall with marble
- 1/8" Fiberglass tub surround
- 1/4" Fiberglass tub surround
- 5/8" Drywall
- 5/8" Drywall with tile
- 5/8" Drywall with marble

*Including multiple layers up to 1 1/2" thick

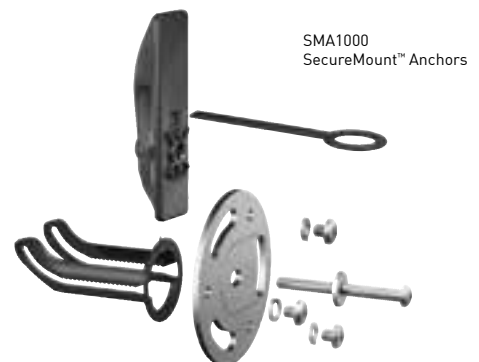

Moen® bath accessories CANNOT be combined with Moen® faucet parts on a Purchase Order.

Moen makes it easy to coordinate the entire style and look of the bathroom. Our bath accessories coordinate with the style and finish of our faucets. Total coordination of the bath has never been easier.

For more information on ordering Moen bath accessories, contact Moen Bath Accessory Customer Service at **800-882-0116**, contact your local Moen sales representative, or visit us at **www.moen.com**.

GRAB BARS WITH ACCESSORIES



SecureMount™ Grab Bars are manufactured with an innovative flange design that makes it easy to connect to the stud at multiple points.

To install grab bars securely without studs, use SecureMount™ Anchors.

MODEL NUMBER	LIST PRICE EACH	DESCRIPTION	QTY
Chrome (CH)			
LR2350DCH	57.00	24" Grab Bar With Towel Bar	3
LR2352DCH	57.00	8" Grab Bar With Paper Holder	3
LR2354DCH	57.00	9" Grab Bar With Corner Shelf	3
LR2356DCH	57.00	16" Grab Bar With Shelf	3
Brushed Nickel (BN)			
LR2350DBN	59.25	24" Grab Bar With Towel Bar	3
LR2352DBN	59.25	8" Grab Bar With Paper Holder	3
LR2354DBN	59.25	9" Grab Bar With Corner Shelf	3
R2356DBN	59.25	16" Grab Bar With Shelf	3
Old World Bronze (OWB)			
LR2350DOWB	62.85	24" Grab Bar With Towel Bar	3
LR2352DOWB	62.85	8" Grab Bar With Paper Holder	3
LR2354DOWB	62.85	9" Grab Bar With Corner Shelf	3
R2356DOWB	62.85	16" Grab Bar With Shelf	3



LR2350D
24" Grab Bar With Towel Bar



LR2352D
8" Grab Bar With Paper Holder



LR2354D
9" Grab Bar With Corner Shelf



LR2356D
16" Grab Bar With Shelf

COORDINATING ACCESSORIES

SECUREMOUNT™

MODEL NUMBER	LIST PRICE EACH	DESCRIPTION	QTY
Chrome (CH)			
SMA1000CH	31.20	SecureMount Anchors and Plates - 1 Pair	24
SMA1001CH	27.70	SecureMount Anchors and Plates - 10 Pairs	10
Oil Rubbed Bronze (ORB)			
SMA1000OWB	31.20	SecureMount Anchors and Plates - 1 Pair	24
Unfinished			
A750	29.50	Securemount Anchors only	24



SMA1000 & SMA1001
SecureMount™ Anchor

For more information on how to properly install, see page 326.

Complies with Americans with Disabilities Act (ADA) specifications. SecureMount™ Grab Bars are tested to withstand 500 lb. pull when securely installed per instructions.

List price is per each (unless otherwise noted). Product can be ordered by case quantity or individually.

COORDINATING ACCESSORIES



Moen® bath accessories CANNOT be combined with Moen® faucet parts on a Purchase Order.

For more information on ordering bath safety furniture or other matching bath accessories, contact Moen Bath Accessory Customer Service at **800-882-0116**, contact your local Moen sales representative, or visit us at **www.moen.com**.

BATH SAFETY FURNITURE

MODEL NUMBER	LIST PRICE EACH	DESCRIPTION	QTY
Old World Bronze (OWB)			
DN7110WB	439.40	Teak Folding Shower Seat	2
Glacier			
DN7025	50.85	Shower Seat	2
DN7065	124.50	Transfer Bench	1
Stainless			
DN7110	378.80	Teak Folding Shower Seat	2



DN7025 Adjustable Shower Seat



DN7110 Teak Folding Shower Seat



DN7065 Tool-Free Transfer Bench



GENUINE PARTS









Moen Genuine Replacement Parts

Moen Genuine Parts Display

Please see moen.com/consumer-support/warranty for complete product warranty information.

Merchandising Solutions

All Brushed Nickel faucet components feature the LifeShine® Non-Tarnish Finish.

		MODEL NUMBER	LIST PRICE	DESCRIPTION	CASE QTY
CARDED PARTS – SHOWERING					
	<ul style="list-style-type: none"> • 6" shower arm and flange • connection size: 1/2" • connection type: IPS 	CL10154	27.40	Chrome	12
		CL10154BN	55.55	Brushed Nickel	12
	<ul style="list-style-type: none"> • 8" shower arm and flange • connection size: 1/2" • connection type: IPS 	CL123815	34.45	Chrome	12
		CL123815BN	64.90	Brushed Nickel	12
	<ul style="list-style-type: none"> • handshower wall bracket • integral handshower cradle: included • pivots to adjust angle of handshower 	CL155694	22.65	Chrome	12
		CL155694BN	32.70	Brushed Nickel	12
	<ul style="list-style-type: none"> • handshower hose • connection size: 1/2" • connection type: IPS • hose length: 59" • metal construction: yes 	CL155748	35.00	Chrome	12
		CL155748BN	50.85	Brushed Nickel	12
	<ul style="list-style-type: none"> • replacement handshower • showerhead functions: one-function • showerhead type: eco-performance handshower • showerhead size: 4-3/64" diameter spray head • type of function: full spray • flow rate: transitioning to 1.75 gpm (6.65 L/min) max • double check valve: included 	CL155747	58.70	Chrome	6
		CL155747BN	85.15	Brushed Nickel	6
	<ul style="list-style-type: none"> • replacement handshower • showerhead functions: four-function • showerhead type: eco-performance handshower • showerhead size: 4-3/64" diameter spray head • type of function: combination; full spray; invigorating spray; targeted massage • flow rate: transitioning to 1.75 gpm (6.65 L/min) max • double check valve: included 	CL164928	70.10	Chrome	6
		CL164928BN	101.60	Brushed Nickel	6
	<ul style="list-style-type: none"> • showerhead functions: five-function • showerhead connection size: 1/2" • connection type: IPS • showerhead type: standard • showerhead size: 4" diameter spray head • type of function: energizing spray; invigorating spray; refreshing spray; relaxing spray; targeted, massage • flow rate: 2.5 gpm (9.5 L/min) max • EP flow rate: 2.0 transitioning to 1.75 gpm 	CL26500	50.45	Chrome	12
		CL26500BN	82.35	Brushed Nickel	12
		CL26500EP	50.45	Chrome	12
		CL26500EPBN	82.35	Brushed Nickel	12
	<ul style="list-style-type: none"> • showerhead functions: one-function • connection size: 1/2" • connection type: IPS • showerhead type: standard • showerhead size: 4-3/8" diameter spray head • type of function: full spray • flow rate: 2.5 gpm (9.5 L/min) max • EP flow rate: 2.0 transitioning to 1.75 gpm 	CL6302	85.70	Chrome	12
		CL6302BN	133.85	Brushed Nickel	12
		CL6302EP	85.70	Chrome	12
		CL6302EPBN	133.85	Brushed Nickel	12









GENUINE PARTS

For a complete listing of replacement parts, see page 405 - 434.

CL Prefix: Indicates carded product for peg hook merchandising.

Merchandising Solutions

All Brushed Nickel faucet components feature the LifeShine® Non-Tarnish Finish.







		MODEL NUMBER	LIST PRICE	DESCRIPTION	CASE QTY
CARDED PARTS – SHOWERING (CONTINUED)					
	• showerhead functions: one-function	CL6303	47.40	Chrome	12
	• connection size: 1/2"	CL6303BN	72.60	Brushed Nickel	12
	• connection type: IPS	CL6303EP	47.40	Chrome	12
	• showerhead type: standard	CL6303EPBN	72.60	Brushed Nickel	12
	• showerhead size: 3-1/2" diameter spray head				
	• type of function: full spray				
	• flow rate: 2.5 gpm (9.5 L/min) max				
	• EP flow rate: 2.0 transitioning to 1.75 gpm				
	• shower arm diverter	CL703	78.40	Chrome	12
	• connection size: 1/2"	CL703BN	113.70	Brushed Nickel	12
	• connection type: IPS	CL703ORB	125.10	Oil Rubbed Bronze	12
	• type of function: two independent 1 shared				
	• metal construction				
	• shower arm diverter	CL707	106.45	Chrome	12
	• connection size: 1/2"	CL707BN	154.30	Brushed Nickel	12
	• connection type: IPS	CL707ORB	169.80	Oil Rubbed Bronze	12
	• type of function: two independent 1 shared				
	• integral handshower cradle: included				
	• metal construction				
	• pivots to adjust angle of handshower				
	• shower arm cradle	CLA701	46.00	Chrome	12
	• connection size: 1/2"	CLA701BN	66.60	Brushed Nickel	12
	• connection type: IPS				
	• integral handshower cradle: included				
	• metal construction: yes				
	• pivots to adjust angle of handshower				
CARDED PARTS – MOEN® GENUINE REPLACEMENT CARTRIDGES					
	1200® cartridge Single-handle replacement cartridge, brass	1200	44.95	Carded	36
	1225® cartridge Single-handle replacement cartridge	1225	29.20	Carded	36
	1224® cartridge Two-handle replacement cartridge (hot or cold)	1224	15.20	Carded	36
	1248™ cartridge Two-handle replacement cartridge for high flow roman tubs (hot or cold)	1248	15.20	Carded	144
	1234® cartridge Two-handle Duralast® cartridge for two-handle lavatory and kitchen faucets (hot or cold)	1234	14.70	Carded	18

GENUINE PARTS







For a complete listing of replacement parts, see page 405 - 434.

CL Prefix: Indicates carded product for peg hook merchandising.







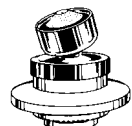



Merchandising Solutions

		MODEL NUMBER	LIST PRICE	DESCRIPTION	CASE QTY
CARDED PARTS - CARTRIDGES (CONTINUED)					
	1258® cartridge Two-handle Duralast® cartridge for two-handle roman tub faucets (hot or cold)	1258	14.70	Carded	18
	1222® cartridge Single-handle replacement cartridge, Posi-Temp®	1222	77.45	Carded	18
	1255® cartridge Single-handle Duralast® cartridge • includes plastic retaining nut	1255	29.95	Carded	72
	Cartridge repair kit for 1222/1222B Posi-Temp® single-handle tub/shower	98040	15.65	Carded	18
	Retainer clips for 1200 and 1225 single-handle cartridges	96365	8.55	Carded	36
	Cartridge puller for 1200, 1222 & 1225 single-handle cartridges	104421	50.65	Carded	36
	Spout o-ring kit Order in multiples of 12	96778 117	9.00 6.00	Carded Bulk (12 pcs)	36 72







For a complete listing of replacement parts, see page 405 - 434.

		MODEL NUMBER	LIST PRICE	DESCRIPTION	CASE QTY
CARDED PARTS – HANDLES					
	Handle kit, Chateau® single-handle lav, clear knob with cap	96782	28.95	Carded	18
	Handle kit, Chateau® single-handle tub/shower, clear knob with cap	98039	28.95	Carded	18
	Handle cap, Chateau® single-handle lav and non-pressure-balancing shower	98032	11.00	Carded	18
	Handle kit, Posi-Temp® single-handle tub/shower with cap	100710	21.45	Carded	18
	Handle kit, Chateau® two-handle lav, kitchen, and tub/shower, clear handles with caps, quantity 2	98026	32.50	Carded	12
	Handle caps, Touch Control two-handle lav, kitchen, bar, and tub/shower	101205	10.75	Carded	18
CARDED PARTS – AERATORS					
	Aerator, 2.2 gpm, male thread	3919	14.15	Chrome (Carded)	18
	Aerator, 2.2 gpm, female thread	3924	14.15	Chrome (Carded)	18
	Aerator, Swing-n-Spray®, 2.2 gpm	20200	50.10	Chrome (Carded)	18









For a complete listing of replacement parts, see page 405 - 434.

		MODEL NUMBER	LIST PRICE	DESCRIPTION	CASE QTY
MOEN® GENUINE REPLACEMENT CARTRIDGES					
	1200® cartridge	1200	44.95	Carded	36
	Single-handle replacement cartridge, brass	1200B	44.95	Bulk (12 pcs.)	144
	1225® cartridge	1225	29.20	Carded	36
	Single-handle replacement cartridge	1225B	29.20	Bulk (12 pcs.)	144
	1224® cartridge	1224	15.20	Carded	36
	Two-handle replacement cartridge (hot or cold)	1224B	15.20	Bulk (12 pcs.)	144
	Two-handle replacement cartridge (hot or cold), order in multiples of 12	14891	17.85	-	60
	Two-handle replacement cartridge, for 4997 valve prior to 6/00				
	1248™ cartridge	1248	15.20	Carded	18
	Two-handle replacement cartridge for high flow Roman tubs, order in multiples of 12	1248B	15.20	Bulk (12 pcs.)	144
	1234® cartridge	1234	14.70	Carded	18
	Two-handle Duralast® cartridge for two-handle lavatory and kitchen faucets				
	1258® cartridge	1258	14.70	Carded	18
	Two-handle Duralast® cartridge for two-handle roman tub faucets				
	1222® cartridge	1222	77.45	Carded	18
	Single-handle replacement cartridge, Posi-Temp®	1222B	77.45	Bulk (6 pcs.)	72
	Single-handle replacement cartridge, Posi-Temp®, order in multiples of 6				
	• repair kit 96988				
	Brass Posi-Temp® cartridge	1222HD	93.95	-	18
	• single-handle replacement cartridge				
	• graphite composite pressure-balancing spool design				
	1255® cartridge	1255	29.95	Carded	72
	Single-handle Duralast® cartridge				
	• includes plastic retaining nut				











For a complete listing of replacement parts, see page 405 - 434.

		MODEL NUMBER	LIST PRICE	DESCRIPTION	CASE QTY
CARTRIDGE REPAIR KIT					
	Cartridge repair kit for 1222/1222B Posi-Temp® single-handle tub/shower	98040	15.65	Carded	18
		96988	17.60	-	100
	Moen® silicone oil for Posi-Temp® balancing spools	140676	5.50	-	96
	Moen® silicone grease for cartridges and o-rings	99915	0.20	-	2500
CARTRIDGE RETAINER CLIPS					
	Retainer clips for 1200 and 1225 single-handle cartridges	96365	8.55	Carded	36
		96914	5.85	-	500
	Retainer clips for Posi-Temp® single-handle tub/shower	96914	5.85	-	500
TOOLS					
	Cartridge puller for 1200, 1222 & 1225 single-handle cartridges	104421	50.65	Carded	36
		14272	6.35	-	150
	Cartridge retainer removal tool for 1224, 1234, 1248 & 1258 two-handle cartridge	14272	6.35	-	150
O-RING KIT					
	Spout o-ring kit	96778	9.00	Carded	36
	Order in multiples of 12	117	6.00	Bulk (12 pcs)	72

For a complete listing of replacement parts, see page 405 - 434.

		MODEL NUMBER	LIST PRICE	DESCRIPTION	CASE QTY
REPLACEMENT HANDLES AND CAPS					
	Handle kit, Chateau® single-handle lav, clear knob with cap	96782	28.95	Carded	18
		96791	28.95	-	1
	Handle kit, Chateau® single-handle tub/shower, clear knob with cap	98039	28.95	Carded	18
		96797	28.95	-	150
	Handle kit, Chateau® single-handle lav with Duralast™	150627	28.95	-	50
	Handle cap kit, Chateau® single-handle lav and non-pressure-balancing shower	98032	11.00	Carded	18
		91751	11.00	-	1,000
	Handle kit, Posi-Temp® single-handle tub/shower with cap	100710	21.45	Carded	18
	Handle kit, less cap , Posi-Temp® single-handle tub/shower	94514	11.40	-	150
	Handle kit, Chateau® two-handle lav, kitchen, and tub/shower, clear handles with caps, quantity 2	98026	32.50	Carded	12
	Lever handle cap, Chateau® single-handle kitchen	96790	28.95	Chrome	1
	Handle caps, Chateau® two-handle lav, kitchen, bar, and tub/shower	13382	10.75	-	300
	Handle caps, Touch Control two-handle lav, kitchen, bar, and tub/shower	101205	10.75	Carded	18

For a complete listing of replacement parts, see page 405 - 434.





		MODEL NUMBER	LIST PRICE	DESCRIPTION	CASE QTY
ECO-PERFORMANCE AERATOR INSERTS					
	Aerator flow restrictor, 1.5 gpm • aerated flow • fits Chateau®, Castleby®, Villeta® Eva®, Brantford™, Level™, Monticello®, Kingsley®, Waterhill® and Vestige® lavatory or kitchen faucets	116711	6.90	-	500
	Aerator flow restrictor, 1.0 gpm • aerated flow • fits Chateau®, Castleby®, Villeta®, Eva®, Brantford™, Level™, Monticello®, Kingsley®, Waterhill® and Vestige® lavatory or kitchen faucets	216721	6.95	-	100
	Aerator flow restrictor, 1.5 gpm • laminar flow • for use on all Icon™ and Divine™ lavatory faucets	316711	6.95	-	200
	Aerator flow restrictor, 0.5 gpm • laminar flow • for use on Arris®, Align®, Gibson™ and Icon™ lavatory faucets	175083	6.95	-	50
	Aerator flow restrictor, 1.0 gpm • laminar flow • for use on Arris®, Align® and Icon™ lavatory faucets	175084	6.95	-	50
	Aerator flow restrictor, 1.5 gpm • laminar flow • for use on Felicity®, Savvy™, Organic™, Waterhill® and Tres Chic™ lavatory faucets	416711	6.95	-	200
	Aerator flow restrictor, 0.5 gpm • rosetta spray • fits Chateau®, Castleby®, Villeta®, Eva®, Brantford™, Level™, Monticello®, Kingsley®, and Vestige® lavatory or kitchen faucets	516711	6.95	-	500
	Aerator flow restrictor, 0.5 gpm • vandal proof • fits Chateau® lavs • removal tool included	52016	19.70	-	24
	Aerator flow restrictor, 1.5 gpm • aerated flow • fits Weymouth® lavatory faucets	154289	7.20	-	20
	Aerator Jr., 0.5 gpm • aerated flow • fits Rothbury™ wall mount, Eva®, Brantford™, Danika™, Zarina™ and Method™ single-handle, and Method™ lavatory faucets	154364	6.95	-	100

For a complete listing of replacement parts, see page 405 - 434.

		MODEL NUMBER	LIST PRICE	DESCRIPTION	CASE QTY
ECO-PERFORMANCE AERATOR INSERTS (CONTINUED)					
	Aerator flow restrictor, 1.0 gpm • aerated flow • fits Rothbury™ wall mount, Eva®, Brantford™, Danika™ and Zarina™ single-handle, and Method™ lavatory faucets	163847	10.45	-	100
	Aerator flow restrictor, 1.5 gpm • aerated flow • fits Rothbury™ wall mount, Eva® and Brantford™ single-handle, and Method™ lavatory faucets	143326	12.30	-	100
	Aerator flow restrictor, 0.5 gpm • aerated flow • fits Rothbury™ single-handle, two-handle and widespreads, and Voss™ lavatory faucets	165018	6.95	-	12
	Aerator flow restrictor, 1.5 gpm • aerated flow • fits Rothbury™ single-handle, two-handle and widespreads, and Voss™ lavatory faucets	137401	13.30	-	12
	Aerator flow restrictor, 1.0 gpm • aerated flow • fits Rothbury™ single-handle, two-handle and widespreads, Rizon®, Glyde™, Dartmoor™ and Voss™ lavatory faucets	316721	10.45	-	100
AERATORS					
	Aerator, 2.2 gpm, male thread	3919	14.15	Chrome (Carded)	18
	Aerator, 2.2 gpm, female thread	3924	14.15	Chrome (Carded)	18
SWIVEL-SPRAY AERATORS					
	Aerator, Swing-n-Spray®, 2.2 gpm	20200	50.10	Chrome (Carded)	18
PULLOUT/PULLDOWN HOSE MANAGEMENT SYSTEM					
	Pullout/pulldown hose management system • system helps prevent hose and weight from getting caught on under sink obstructions • easy to install • ships fully assembled • sleeve can be cut to accommodate different cabinet sizes • compatible with all Moen® kitchen pulldown and pullout single-handle sidemount SKUs (excludes Aberdeen)	159060	18.80	Chrome	6







For a complete listing of replacement parts, see page 405 - 434.

All Brushed Nickel, Polished Brass and Polished Nickel faucet components feature the LifeShine® Non-Tarnish Finish.

		MODEL NUMBER	LIST PRICE	DESCRIPTION	CASE QTY
SIDE SPRAY SERVICE AND ADAPTER KITS					
	Side spray plug service kit • plug hose outlet to eliminate quick connect system kitchen side spray	143530	8.95	-	144
	Side spray adapter kit • for faucets with external threads • converts side spray outlet to quick-connect	168665	27.30	-	50
	Side spray adapter kit • for faucets with internal threads • converts side spray outlet to quick-connect	168666	17.40	-	50
DRAIN PLUG & SEAT					
	Lavatory drain plug and threaded seat assembly	10709	43.15	Chrome	20
	• non-metallic	10709BC	17.55	Brushed Chrome	20
	• works with metal drain body 10790 only	10709BN	39.25	Brushed Nickel	20
		10709NL	43.15	Polished Nickel	20
		10709ORB	43.25	Oil Rubbed Bronze	20
		10709WR	43.25	Wrought Iron	20
	99596	35.40	Polished Brass	1	





For a complete listing of replacement parts, see page 405 - 434.

All Brushed Nickel, Polished Brass and Polished Nickel faucet components feature the LifeShine® Non-Tarnish Finish.

		MODEL NUMBER	LIST PRICE	DESCRIPTION	CASE QTY
EXTENSION KITS					
	Thick deck extension kit for widespread valve bodies, model 9000/69000	175709	107.80	-	1
	Thick deck extension kit for valves with 1/2" threaded mounting shanks	100818	33.80	-	20
HANDLE EXTENSION KITS					
	1" handle extension kit, Posi-Temp® single-handle tub/shower	96945	36.35	Chrome	100
		96945BN	52.05	Brushed Nickel	9
		96858	51.95	Polished Brass	1
		96945WR	57.25	Wrought Iron*	9
		96955	44.20	Chrome	1
	2" handle extension kit, Posi-Temp® single-handle tub/shower				
	2" handle extension kit to correct deep rough-in	96868	63.80	Polished Brass	1
	<i>*Wrought iron can be used with Oil Rubbed Bronze finish</i>				
	1" handle extension kit, Moentrol® single-handle tub/shower	137347	38.35	Chrome	9
		137347NL	45.50	Polished Nickel	9
		137347P	61.10	Polished Brass	9
		137347BN	62.40	Brushed Nickel	9
		137347WR	68.65	Wrought Iron*	9
	<i>*Wrought iron can be used with Oil Rubbed Bronze finish</i>				
	1" handle extension kit, Legend® & Chateau® single-handle tub/shower	10399	35.90	Chrome	36
	Roman tub stem extension • adapts to all 3-hole roman tub valves	106378	19.05	Chrome	1





For a complete listing of replacement parts, see page 405 - 434.

All Brushed Nickel, Polished Brass and Polished Nickel faucet components feature the LifeShine® Non-Tarnish Finish.

	MODEL NUMBER	LIST PRICE	DESCRIPTION	CASE QTY	
ADJUSTABLE TEMPERATURE LIMIT STOPS					
	Moentrol®				
	Stop tube with adjustable temperature limit stop	10066	24.60	Chrome	125
	Moentrol® single-handle tub/shower	10066BN	34.80	Brushed Nickel	20
		10066WR	38.40	Wrought Iron*	20
		10066P	43.80	Polished Brass	1
	10066NL	35.40	Polished Nickel	20	
<i>*Wrought Iron can be used with Oil Rubbed Bronze finish</i>					
	Posi-Temp®				
	Adjustable temperature limit stop, Posi-Temp®	96987	9.55	Chrome	20
		96987BN	13.45	Brushed Nickel	20
		96987NL	13.55	Polished Nickel	20
		96987WR	14.80	Wrought Iron*	20
	15972	18.95	Polished Brass	1	
<i>*Wrought Iron can be used with Oil Rubbed Bronze finish</i>					
	Temperature limit stop kit, Posi-Temp® single-handle tub/shower	106479	4.60	-	1
	Push-button diverter plug	101100	30.80	-	1
	Moentrol® Adapter for standard 1H tub/shower valves to use Moentrol® trim • attaches to standard valves to fit today's Moentrol® trim	145058	17.80	-	50





For a complete listing of replacement parts, see page 405 - 434.

All Polished Brass and Brushed Nickel faucet components feature the LifeShine® Non-Tarnish Finish.

		MODEL NUMBER	LIST PRICE	DESCRIPTION	CASE QTY
COVER PLATES FOR THE BATH					
	Remodeling cover plate, for two- and three-handle tub/showers • fits all single-handle tub/showers with 7" escutcheon	1920	62.00	Chrome	6
		1920BN	90.00	Brushed Nickel	6
		1920ORB	110.45	Oil Rubbed Bronze	6
		1920P	114.20	Polished Brass	6
	Remodel cover plate • Fits Posi-Temp® valves	178755	69.15	Chrome	8
		178755BN	100.30	Brushed Nickel	8
		178755ORB	106.55	Oil Rubbed Bronze	8
	Moenique service kit, single-handle tub/shower with 3960 tub spout • Handle not included	14292	212.70	Chrome	1
LAVATORY CONVERSION KIT - KNOB TO LEVER HANDLE					
	Handle conversion kit, knob to lever, Chateau® single-handle lav - Models prior to April 2003	100679	58.15	Chrome	12
TUB/SHOWER CONVERSION KITS - KNOB TO LEVER HANDLE					
	Lever handle kit, Chateau® and Moentrol® single-handle tub/shower	100224	19.70	Chrome	1

For a complete listing of replacement parts, see page 405 - 434.

All Brushed Nickel, Polished Brass and Polished Nickel faucet components feature the LifeShine® Non-Tarnish Finish.

		MODEL NUMBER	LIST PRICE	DESCRIPTION	CASE QTY
LAVATORY WASTE ASSEMBLIES					
	Lavatory drain assembly • all metal	10790	103.45	Chrome	12
	Lavatory drain assembly • spring loaded push button • with overflow	131553 131553BN 131553NL 131553ORB	66.75 99.95 99.95 112.45	Chrome Brushed Nickel Polished Nickel Oil Rubbed Bronze	12 12 12 12
	Lavatory drain assembly • ideal for vessel sinks • spring loaded push button • without overflow	140780 140780BN 140780NL 140780ORB 140780P	59.20 82.60 81.90 93.30 114.00	Chrome Brushed Nickel Polished Nickel Oil Rubbed Bronze Polished Brass	12 12 12 12 12
	Grid drain without overflow	123816 123816BN 123816ORB	46.90 74.00 72.25	Chrome Brushed Nickel Oil Rubbed Bronze	12 12 12
	Lavatory drain assembly, non-metallic Lavatory drain assembly, non-metallic plug, metal seat Lavatory drain assembly, non-metallic plug, metal seat	14526 96497 96107	12.65 19.85 17.55	Chrome Chrome Chrome (Carded)	1 1 18

For a complete listing of replacement parts, see page 405 - 434.

GENUINE PARTS

Moen Genuine Parts

Listed in numerical order

Part Number	List Price	Finish	Description	Part Number	List Price	Finish	Description
117	6.00	N/A or Unfinished	O-ring kit	1411P	32.75	Polished Brass	Escutcheon
150	63.80	Chrome	Escutcheon	1411WR	32.75	Wrought Iron	Escutcheon
162	97.55	Chrome	Escutcheon	1417	50.90	Chrome	Roman tub hand shower elbow
162BN	135.40	Brushed Nickel	Escutcheon extension kit	1417BN	72.40	Brushed Nickel	Roman tub hand shower elbow
162ORB	148.95	Oil Rubbed Bronze	Escutcheon adjuster kit	1417NL	104.80	Polished Nickel	Roman tub hand shower elbow
163BN	15.00	Brushed Nickel	Escutcheon screws	1417ORB	79.70	Oil Rubbed Bronze	Roman tub hand shower elbow
163PM	12.55	Platinum	Escutcheon screws	1417P	91.90	Polished Brass	Roman tub hand shower elbow
163W	11.30	Glacier	Escutcheon screws	1417WR	79.70	Wrought Iron	Roman tub hand shower elbow
163WR	16.50	Wrought Iron	Escutcheon screws	1423	102.25	N/A or Unfinished	Balancing spool
171	56.75	Chrome	Escutcheon	1512	8.70	Chrome	Plug button kit
221	54.10	Chrome	Escutcheon	1512BC	10.15	Brushed Chrome	Plug button kit
441	56.90	Chrome	Escutcheon	1512BN	12.20	Brushed Nickel	Plug button kit
601	36.55	N/A or Unfinished	MicroTech 600 replacement filter, for PureTouch® Classic, quantity 1	1512NL	13.45	Polished Nickel	Plug button kit
739	116.50	Chrome	Spout kit	1512ORB	13.45	Oil Rubbed Bronze	Plug button kit
785	19.20	N/A or Unfinished	Hardware kit	1512P	13.45	Polished Brass	Plug button kit
883	3.85	N/A or Unfinished	Retainer clip, lavatory & tub/shower	1512WR	13.45	Wrought Iron	Plug button kit
1011	15.70	Polished Stainless	Polished Stainless Drain Stopper	1694	62.50	Chrome	Collar & nut kit
1016	8.15	Polished Stainless	Removable Splash Guard	1694W	90.50	Glacier	Collar & nut kit
1017	16.75	Polished Stainless	Sink flange	1700W	16.00	Glacier	Aerator
1023	8.40	N/A or Unfinished	Dishwasher Connector Kit	1824	19.95	Polished Stainless	Mounting assembly
1024	10.25	N/A or Unfinished	Disposal Power Cord Kit	1826W	49.10	Glacier	Drain plug & seat
1026	9.40	N/A or Unfinished	Drain Elbow & Gasket	1862	45.40	N/A or Unfinished	Hose & spray
1037	9.00	N/A or Unfinished	Disposal Unjamming Wrench	1883	16.30	N/A or Unfinished	Retainer clip
1185	10.70	Chrome	Drain seat	1918	11.90	Chrome	Handle cap, 7385 & 87810 series
1193BN	61.45	Brushed Nickel	Diverter trim ring	1918S	18.40	Sand	Handle cap kit
1193NL	65.45	Polished Nickel	Diverter trim ring	1918V	18.40	Ivory	Handle cap kit
1193WR	67.65	Wrought Iron	Diverter trim ring	1918W	18.40	Glacier	Handle cap kit
1198	48.25	N/A or Unfinished	Push button diverter	1920	62.00	Chrome	Remodeling cover plate
1200	44.95	N/A or Unfinished	1 handle replacement cartridge, brass	1920BN	90.00	Brushed Nickel	Remodeling cover plate, for two- and three-handle tub/showers
1200B	44.95	N/A or Unfinished	Cartridge	1920ORB	110.45	Oil Rubbed Bronze	Deck plate
1207	7.20	Chrome	Stop tube kit	1920P	114.20	Polished Brass	Remodeling cover plate
1222	77.45	N/A or Unfinished	Cartridge	1921	72.95	Chrome	Handle kit
1222B	77.45	N/A or Unfinished	1 handle replacement cartridge, Posi-Temp	1921S	82.70	Sand	Handle kit
1222HD	93.95	N/A	BRASS POSI-TEMP CARTRIDGE	1921V	78.00	Ivory	Handle kit
1224	15.20	N/A or Unfinished	2 handle replacement cartridge (hot or cold)	1921W	78.00	Glacier	Handle kit
1224B	15.20	N/A or Unfinished	2 handle replacement cartridge (hot or cold)	1931	91.95	Chrome	Spout receptor kit
1225	29.20	N/A or Unfinished	1 handle replacement cartridge	1931S	106.00	Sand	Spout receptor kit
1225B	29.20	N/A or Unfinished	1 handle replacement cartridge	1931V	106.00	Ivory	Spout receptor kit
1234	14.70	N/A or Unfinished	Cartridge	1931W	106.00	Glacier	Spout receptor kit
1248	15.20	N/A or Unfinished	2 handle replacement cartridge, high flow Roman tub for 4999 valve	1933	24.40	Chrome	Escutcheon
1248B	15.20	N/A or Unfinished	Cartridge	1933S	27.60	Sand	Escutcheon
1255	29.95	N/A or Unfinished	Cartridge	1933SL	26.90	Stainless	Escutcheon
1258	14.70	N/A or Unfinished	Cartridge	1933V	27.60	Ivory	Escutcheon
1306	23.85	Chrome	Handle cover	1933W	27.60	Glacier	Escutcheon
1371	98.50	N/A or Unfinished	Valve body	1935	27.25	Chrome	Escutcheon
1373	103.30	N/A or Unfinished	Valve body	1935W	39.55	Glacier	Escutcheon
1394	47.90	Chrome	Extension kit	1972W	18.40	Glacier	Handle cover
1411	21.30	Chrome	Escutcheon	2011	17.20	Chrome	Lift rod kit
1411BC	24.55	Brushed Chrome	Escutcheon	2011P	26.45	Polished Brass	Lift rod kit
1411BN	24.55	Brushed Nickel	Escutcheon	2021	103.80	Chrome	Handle kit
1411NL	32.75	Polished Nickel	Escutcheon	2060	120.90	N/A or Unfinished	Cartridge
1411ORB	32.75	Oil Rubbed Bronze	Escutcheon	2186	14.25	Chrome	Stream straightener
				2186BN	20.55	Brushed Nickel	Stream straightener
				2186P	15.45	Polished Brass	Stream straightener
				2186WR	22.75	Wrought Iron	Stream straightener
				2187	20.55	Chrome	Spout escutcheon
				2187BN	38.65	Brushed Nickel	Spout escutcheon
				2187P	40.15	Polished Brass	Spout escutcheon

Moen Genuine Parts

Listed in numerical order

Part Number	List Price	Finish	Description	Part Number	List Price	Finish	Description
2197BN	317.15	Brushed Nickel	Roman tub spout kit	11896	13.30	N/A or Unfinished	Flow restrictor kit
2198	14.20	Chrome	Handle escutcheon	11926	36.45	N/A or Unfinished	Hardware kit
2198CSL	21.80	Classic Stainless	Escutcheon	11977	4.45	Chrome	Plug button, Traditional handle
2198P	22.70	Polished Brass	Handle escutcheon				
2198SL	21.80	Stainless	Handle escutcheon	11985	6.35	N/A or Unfinished	Pivot rod, 50/50 drain assembly
3737BN	105.55	Brushed Nickel	Brushed nickel diverter spouts	11997	4.65	N/A or Unfinished	Hardware kit
3919	14.55	Chrome	Aerator, 2.2 gpm, male thread	12314	20.30	Chrome	Drain plug
				12318	42.55	N/A or Unfinished	Check stop
3919BN	20.50	Brushed Nickel	Aerator	12343	8.80	Chrome	Stem extension kit
3919CSL	20.50	Classic Stainless	Aerator kit	12539	9.45	N/A or Unfinished	Escutcheon nut
3919ORB	22.65	Oil Rubbed Bronze	Aerator	12541	6.50	N/A or Unfinished	Gasket
3919P	36.35	Polished Brass	Aerator	12550	14.70	N/A or Unfinished	Hardware kit
3919SLP	18.05	Chrome	Aerator	12570	16.10	N/A or Unfinished	Hardware kit
3919W	33.55	Glacier	Aerator	12573	7.40	N/A or Unfinished	Bushing
3919WR	22.65	Wrought Iron	Aerator	12574	9.55	N/A or Unfinished	Plaster ground
3924	14.55	Chrome	Aerator	12639	11.25	N/A or Unfinished	Stop valve
3924P	36.35	Polished Brass	Aerator	12648	3.50	N/A or Unfinished	Screw kit
3971	24.50	Chrome	Diverter tub spout	12689	15.45	N/A or Unfinished	Pivot rod
3971BN	35.50	Brushed Nickel	Diverter tub spout	12694	8.30	Chrome	Lift rod kit
4000	11.65	N/A or Unfinished	Cartridge	12694BC	12.50	Brushed Chrome	Lift rod kit
9001	97.15	N/A or Unfinished	MicroTech 9000 replacement filter for PureTouch AquaSuite, quantity 1	12694BN	19.90	Brushed Nickel	Lift rod kit
				12694CBN	19.20	Classic Brushed Nickel	Lift rod kit
9601	54.95	N/A or Unfinished	ChoiceFlo 9600 replacement filter for Chateau with ChoiceFlo, Sip, and AquaSuite Series 9600/9602/9500/9502	12715	36.45	N/A or Unfinished	Hardware kit
				12884	126.15	Chrome	Spout kit
				13291	52.55	Chrome	Handle kit
				13323	54.10	Chrome	Escutcheon
				13382	10.75	N/A or Unfinished	Handle insert kit
9602	54.95	N/A or Unfinished	ChoiceFlo 9600 replacement filter for Chateau with ChoiceFlo, Sip, and AquaSuite Series 9600/9602/9500/9502	13393	52.05	Chrome	Handle kit
				13401	11.45	N/A or Unfinished	Cartridge nut
				13409	22.00	Chrome	Spout cap kit
				13411	90.10	Chrome	Spout kit
				13462	8.75	N/A or Unfinished	Handle adapter kit
				13463	11.30	N/A or Unfinished	Stem extension, Boutique & Chateau widespread Roman tub
10048	17.25	N/A or Unfinished	Liquid dispenser bottle				
10066	24.60	Chrome	Stop tube kit	13499	38.15	Chrome	Handle kit
10066BN	34.80	Brushed Nickel	Stop tube kit	13499CBN	59.60	Classic Brushed Nickel	Handle kit
10066NL	35.40	Polished Nickel	Stop tube kit				
10066P	43.80	Polished Brass	Stop tube kit	13577	29.55	N/A or Unfinished	Ground joint union & nut
10066WR	38.40	Wrought Iron	Stop tube kit	13678	8.80	N/A or Unfinished	Hardware kit
10089	10.10	Chrome	Stop tube, Legend & Chateau 1 handle tub/shower, knob handle	13769	32.60	Chrome	Escutcheon
				13774	12.50	Chrome	Wall tube
10099	4.10	N/A or Unfinished	Diverter kit	13797	15.45	N/A or Unfinished	Cartridge nut
10116	4.20	Chrome	Plug button kit	13805	18.55	N/A or Unfinished	Hardware kit
10154BRB	31.80	Mediterranean Bronze	Shower arm	13903	4.45	N/A or Unfinished	Set screw kit
10154ORB	39.00	Oil Rubbed Bronze	Oil Rubbed Bronze 6" shower arm	13979	32.55	N/A or Unfinished	Ground joints
				14187	18.70	N/A or Unfinished	Garter spring only
10399	35.90	Chrome	Handle extension kit	14272	6.35	N/A or Unfinished	Cartridge retainer removal tool, 2 handle cartridge
10510	24.60	Chrome	Stop tube kit				
10644	16.10	N/A or Unfinished	Diverter tub spout repair kit	14289	11.25	N/A or Unfinished	Handle screw
10709	12.55	Chrome	Drain plug & seat	14290	68.00	Chrome	Handle kit
10709BC	17.55	Brushed Chrome	Drain plug & seat	14291	7.40	N/A or Unfinished	Spout and handle insert
10709BN	39.25	Brushed Nickel	Drain plug & seat	14292	212.70	N/A or Unfinished	Spout kit
10709CBN	16.05	Classic Brushed Nickel	Drain plug & seat	14349	21.45	Chrome	Escutcheon
				14373	16.70	N/A or Unfinished	Hose kit
10709NL	43.15	Polished Nickel	Drain plug	14526	12.65	Chrome	Lavatory drain assembly
10709ORB	43.25	Oil Rubbed Bronze	Drain plug & seat	14582	33.40	Chrome	Spout escutcheon
10709PM	22.00	Platinum	Drain plug & seat	14582BN	52.15	Brushed Nickel	Spout escutcheon
10709ST	39.55	Satine	Drain plug & seat	14666	100.15	Chrome	Handle hub
10709WR	43.25	Wrought Iron	Drain plug & seat	14671	100.15	Chrome	Handle hub
10790	103.45	Chrome	Lavatory drain assembly	14699	7.35	N/A or Unfinished	Retainer pivot nut, 1 handle kitchen, lever handle
10927	40.45	Chrome	Handle kit				
11751	130.30	Chrome	Spout kit				
11854	10.80	N/A or Unfinished	Handle screw	14732	26.85	Chrome	Handle kit

Moen Genuine Parts

Listed in numerical order

Part Number	List Price	Finish	Description	Part Number	List Price	Finish	Description
14834CBN	83.45	Classic Brushed Nickel	Handle kit	59016	30.55	Chrome	Escutcheon & gasket kit
14855	10.70	N/A or Unfinished	Hose kit	59017	46.70	Chrome	Handle escutcheon
14891	17.85	N/A or Unfinished	Cartridge	59018	51.85	Chrome	Escutcheon & gasket kit
14913	13.75	Chrome	Stream straightener	59019	58.90	Chrome	Handle kit
14913BN	19.45	Brushed Nickel	Aerator	59021	88.95	Chrome	Diverter tub spout
14913BRB	16.45	Mediterranean Bronze	Aerator	59022	82.20	Chrome	Non diverting tub spout
14913ORB	21.50	Oil Rubbed Bronze	Stream straightener	59023	16.10	N/A or Unfinished	Diverter tub spout repair kit
14913WR	21.50	Wrought Iron	Stream straightener	59024	76.85	Chrome	Waste assembly
14949	4.20	N/A or Unfinished	Gasket	59025	46.90	N/A or Unfinished	Hardware kit
14960	16.65	N/A or Unfinished	Diverter kit	59027	35.75	Chrome	Handle kit
14986	7.05	N/A or Unfinished	Cartridge nut	59029	5.30	Chrome	Set screw kit
15234	52.70	Chrome	Spout kit	59030	5.10	N/A or Unfinished	O-ring kit
15528	10.50	Chrome	Escutcheon screws, 1 handle tub/shower, quantity 2	59031	42.30	Chrome	Lavatory drain assembly
15972	18.95	Polished Brass	Stop tube kit	59033	15.35	Chrome	Lift rod kit
15973P	80.05	Polished Brass	Spout escutcheon	59034	148.15	Chrome	Spout kit
16015	6.10	N/A or Unfinished	Pivot rod seat	59035	146.10	Chrome	Spout kit
16090	34.50	Chrome	Escutcheon, Chateau 1 handle tub/shower	59036	71.50	Chrome	Handle kit
16098	111.60	Polished Brass	Escutcheon	59037	4.60	Chrome	Plug button kit
16331	43.95	N/A or Unfinished	Hardware kit	59899	69.85	Chrome	Spray nozzle
20200	50.10	N/A or Unfinished	Aerator	90274	14.15	N/A or Unfinished	Adapters, widespread wing handle, quantity 2
22188	29.90	N/A or Unfinished	Screw kit	90276	3.85	N/A or Unfinished	Handle adapter kit
22511	16.40	N/A or Unfinished	Sink template	90410BN	196.40	Brushed Nickel	Brushed nickel line list items
22512	17.55	N/A or Unfinished	Sink template	90462	28.90	Chrome	Face plate kit
22514	16.40	N/A or Unfinished	Sink template	90467	14.55	Chrome	Grid drain cover
22515	17.55	N/A or Unfinished	Sink template	90471	22.95	Chrome	Face plate kit
22617	2.20	N/A or Unfinished	Service kit	90478	9.70	Chrome	Screw kit
28974	564.60	N/A or Unfinished	Tool box	90478BN	34.35	Brushed Nickel	Screw kit
28984	127.80	N/A or Unfinished	Tool box	90478NL	13.45	Polished Nickel	Screw kit
52016	19.70	Chrome	Aerator 0.5 gpm insert 8200 Series	90478ORB	37.85	Oil Rubbed Bronze	Screw kit
52016F03	18.15	Chrome	AERATOR .35GPM VANDAL RESISTANT CHR	90478P	14.55	Polished Brass	Screw kit
52016F05	18.15	Chrome	AERATOR .5GPM VANDAL RESISTANT CHR	90481	14.30	N/A or Unfinished	Gasket
52016F10	18.15	N/A or Unfinished	Aerator	90483	24.15	N/A or Unfinished	Tub drain assembly
52016F15	18.15	Chrome	AERATOR 1.5GPM VANDAL RESISTANT CHR	91110	57.75	Chrome	Handle extension kit
52016F22	18.15	Chrome	AERATOR 2.2GPM VANDAL RESISTANT CHR	91192	28.60	N/A or Unfinished	Diverter kit for single handle kitchen faucets
52018F12	18.15	Black	Aerator	91194	86.30	Chrome	Spout kit
52018F22	10.40	N/A or Unfinished	Aerator	91244	27.85	N/A or Unfinished	Handle kit
52618	13.15	Chrome	AERATOR MALE THREAD .035 GPM VP CHR	91751	11.00	N/A or Unfinished	Knob insert kit, Chateau 1 handle lav, non-pressure balancing shower, white & chrome insert
59001	36.30	Chrome	Handle kit	91992	63.40	Chrome	Spout kit
59002	29.75	N/A or Unfinished	Cartridge repair kit	92183	57.55	Chrome	Escutcheon
59003	14.80	N/A or Unfinished	Temperature limit stop kit	92309	21.00	N/A or Unfinished	Pivot nut
59004	23.65	Chrome	Handle elbows	92451	7.25	N/A or Unfinished	Grommets & o-rings for 1225 cartridge
59005	4.30	N/A or Unfinished	Aerator removal tool	92455	7.95	N/A or Unfinished	Extension kit
59006	61.30	Chrome	Waste assembly	93248	62.55	Polished Brass	Escutcheon
59007	24.05	N/A or Unfinished	Mounting hardware	93944	31.15	Chrome	Handle hub kit
59008	37.30	Chrome	Handle kit	93959	13.35	N/A or Unfinished	Hardware kit for 7100/7400/7600 series kitchen
59009	6.00	N/A or Unfinished	Hot/cold indicator kit	93960	15.35	N/A or Unfinished	Pivot nut
59010	72.25	Chrome	Handle hub kit	93964	22.80	N/A or Unfinished	Support plate with gasket
59011	25.15	N/A or Unfinished	Hardware kit	93970	8.65	Chrome	Handle insert kit
59012	170.50	Chrome	Spout kit	93971	68.20	Chrome	Handle kit
59013	170.50	Chrome	Spout kit	93973	74.40	Chrome	Spout kit
59014	171.65	Chrome	Spout kit	93980	29.40	N/A or Unfinished	Handle mechanism kit
59015	171.65	Chrome	Spout kit	93988	87.50	Chrome	Spout kit
				93988V	114.30	Ivory	Spout kit
				93988W	110.20	Glacier	Spout kit
				93989	69.80	Chrome	Handle kit
				93989V	79.85	Ivory	Handle kit

Moen Genuine Parts

Listed in numerical order

Part Number	List Price	Finish	Description	Part Number	List Price	Finish	Description
93989W	79.85	Glacier	Handle kit	96804	9.10	N/A or Unfinished	Hardware kit, 1 handle lav knob
93990	13.45	Chrome	Dome	96806	9.10	N/A or Unfinished	Hardware kit, 1 handle tub/shower knob
93990V	15.50	Ivory	Dome	96858	51.95	Polished Brass	Handle extension kit
93990W	15.50	Glacier	Dome	96868	63.80	Polished Brass	Handle extension kit
93995	50.85	Chrome	Escutcheon	96884	29.00	N/A or Unfinished	Handle insert kit
94146	10.00	N/A or Unfinished	Cartridge nut	96885	46.80	Chrome	Escutcheon
94435	36.35	Chrome	Escutcheon	96914	5.85	N/A or Unfinished	Retainer clip, Posi-Temp 1 handle tub/shower
94435P	50.40	Polished Brass	Escutcheon	96945	36.35	Chrome	Handle extension kit
94435SL	47.65	Stainless	Escutcheon	96945BN	52.05	Brushed Nickel	Handle extension kit
94435V	50.40	Ivory	Escutcheon	96945WR	57.25	Wrought Iron	Handle extension kit
94435W	50.40	Glacier	Escutcheon	96955	44.20	Chrome	Handle extension kit
94514	11.40	N/A or Unfinished	Handle kit	96987	9.55	Chrome	Stop tube, Posi-Temp 1 handle tub/shower
94543	26.75	N/A or Unfinished	Stem extension, Chateau 3 handle tub/shower diverter knob	96987BN	13.45	Brushed Nickel	Stop tube kit
94740	32.00	Chrome	Handle kit	96987NL	13.55	Polished Nickel	Stop tube kit
94746	10.00	N/A or Unfinished	Handle adapter kit	96987WR	14.80	Wrought Iron	Stop tube kit
94750	13.75	Chrome	Handle collar	96988	17.60	N/A or Unfinished	Cartridge repair kit, Posi-Temp 1 handle tub/shower
94770	5.65	Chrome	Plug button & set screw	97273	5.55	N/A or Unfinished	Hot/cold indicator kit
94773	23.70	N/A or Unfinished	Stem extension kit	97274	4.70	N/A or Unfinished	Red & blue washer kit, Monticello lever handle
94786	4.20	N/A or Unfinished	Handle adapter kit	97344	12.30	N/A or Unfinished	Stem extension kit, Monticello 2 handle tub/shower, quantity 2
94791	4.55	N/A or Unfinished	Handle screw	97361	9.10	Chrome	Handle escutcheon
94794	39.80	N/A or Unfinished	Hardware kit	97362	14.10	Polished Brass	Handle escutcheon
94831	70.25	N/A or Unfinished	Diverter kit	97371	6.55	N/A or Unfinished	Handle adapter kit
94854	47.90	N/A or Unfinished	Cartridge	97372BN	82.25	Brushed Nickel	Handle insert kit
94873	19.00	N/A or Unfinished	Check valve kit, OneTouch	97476SL	17.55	Stainless	Aerator
94986	52.10	Chrome	Escutcheon	97476V	37.00	Ivory	Aerator
94988	113.20	Polished Brass	Escutcheon	97479	19.85	N/A or Unfinished	Stem extension kit
94996	4.20	N/A or Unfinished	O-ring kit	97491	55.20	Chrome	Escutcheon
94998	51.35	N/A or Unfinished	Hose kit	97491BN	75.85	Brushed Nickel	Escutcheon
95602	36.45	Chrome	Handle hub kit	97491ORB	83.40	Oil Rubbed Bronze	Escutcheon
95603	50.65	Polished Brass	Handle hub kit	97491WR	83.40	Wrought Iron	Escutcheon
95606	25.20	Chrome	Handle hub kit	97492	116.50	Polished Brass	Escutcheon
95606PM	29.00	Platinum	Handle hub kit	97535	4.55	N/A or Unfinished	Cartridge nut
95606ST	38.85	Satine	Handle hub kit	97540	62.85	Chrome	Spout kit
95607	38.85	Polished Brass	Handle hub kit	97544	2.60	N/A or Unfinished	O-ring kit
95612	36.45	Chrome	Handle hub kit	97547	37.70	Chrome	Handle escutcheon
95612P	50.65	Polished Brass	Handle hub kit	97548	42.15	Polished Brass	Handle escutcheon
95626	36.45	Chrome	Handle hub kit	97556	22.70	N/A or Unfinished	Handle adapter kit, Monticello centerset, mini widespread, & Roman tub, hot and cold
95626BN	52.90	Brushed Nickel	Handle kit	97564	4.50	N/A or Unfinished	Gasket
95626ORB	56.10	Oil Rubbed Bronze	Handle kit	97565	55.20	N/A or Unfinished	Hardware kit
95626P	56.10	Polished Brass	Handle kit	97577	55.20	Chrome	Escutcheon
96107	17.55	Chrome	Lavatory drain assembly, non-metallic plug, metal seat	97577BN	75.85	Brushed Nickel	Escutcheon
96217	46.65	Chrome	Wall tube	97577ORB	83.40	Oil Rubbed Bronze	Escutcheon
96365	8.55	N/A or Unfinished	Retainer clips for 1200 and 1225 single handle cartridges	97577WR	83.40	Wrought Iron	Escutcheon
96469	72.90	Chrome	Dispenser pump and head assemb	97578	116.50	Polished Brass	Escutcheon
96497	19.85	Chrome	Lavatory drain assembly, non-metallic plug, metal seat	97582	55.20	Chrome	Escutcheon
96519	21.65	N/A or Unfinished	Diverter kit	97800	7.20	N/A or Unfinished	Plaster ground
96706	7.20	Chrome	Stop tube kit	97996	8.95	N/A or Unfinished	Escutcheon decal
96778	9.00	N/A or Unfinished	Spout o-ring kit	98026	32.50	N/A or Unfinished	Handle kit
96782	28.95	N/A or Unfinished	Handle kit	98032	11.00	N/A or Unfinished	Handle insert kit
96790	28.95	Chrome	Handle kit	98035	27.10	N/A or Unfinished	Handle kit
96791	28.95	N/A or Unfinished	Handle kit	98036	11.40	N/A or Unfinished	Handle insert kit
96792	28.85	N/A or Unfinished	Handle kit	98037	27.10	N/A or Unfinished	Handle kit
96795	33.95	Chrome	Handle kit	98039	28.95	N/A or Unfinished	Handle kit
96797	28.95	N/A or Unfinished	Knob handle kit, Chateau 1 handle tub/shower, clear knob with white & chrome insert	98040	15.65	N/A or Unfinished	Cartridge repair kit
96798	28.85	N/A or Unfinished	Handle kit	98055	88.05	N/A or Unfinished	Hose kit
				98077ORB	82.40	Oil Rubbed Bronze	Lift rod kit

Moen Genuine Parts

Listed in numerical order

Part Number	List Price	Finish	Description	Part Number	List Price	Finish	Description
98079	25.10	N/A or Unfinished	Hardware kit	100023	32.50	Chrome	Handle cap kit
98082	41.60	N/A or Unfinished	Pivot rod	100024	9.85	N/A or Unfinished	Stop tube kit
98133	8.65	Polished Brass	Plug button kit	100024BN	16.70	Brushed Nickel	Stop tube kit
98213	5.30	N/A or Unfinished	Gasket	100040	109.65	N/A or Unfinished	Cartridge
98430	12.60	N/A or Unfinished	Escutcheon gasket	100109	11.05	N/A or Unfinished	Plug button kit for 7600 series kitchen faucets
98576	22.20	Chrome	Escutcheon	100109WBL	12.50	N/A or Unfinished	Plug button kit
98577	42.15	Polished Brass	Escutcheon	100110	13.90	N/A or Unfinished	installation tool
99460	13.75	Polished Brass	Stream straightener	100112	15.90	Chrome	Aerator, 2.2 gpm, Monticello large, male thread
99479	19.10	N/A or Unfinished	Cartridge nut	100112P	38.60	Polished Brass	Aerator
99497	41.50	Polished Brass	Stop tube kit	100112W	35.45	Glacier	Aerator
99498	13.70	Polished Brass	Escutcheon screws	100113	19.40	Chrome	Aerator
99503	52.15	Polished Brass	Handle extension kit	100113P	29.90	Polished Brass	Aerator
99511	35.85	Polished Brass	Lift rod kit	100113PM	22.25	Platinum	Aerator
99547	21.50	Polished Brass	Plug button kit	100113V	29.90	Ivory	Aerator
99556	32.55	Chrome	Escutcheon & gasket kit	100113W	29.90	Glacier	Aerator
99557	32.55	Chrome	Escutcheon & gasket kit	100118	8.70	Chrome	Handle skirt
99558	41.85	Chrome	Escutcheon & gasket kit	100118W	11.40	Glacier	Handle skirt
99559	32.55	Chrome	Deck plate	100119	44.75	N/A or Unfinished	Hose kit
99573	39.70	Polished Brass	Spout escutcheon	100131	15.90	Chrome	Lift rod kit
99596	36.75	Polished Brass	Drain plug & seat	100138	35.90	N/A or Unfinished	Handle adapter kit
99712	11.30	Chrome	Handle cap kit	100139	88.75	Chrome	Handle kit
99892	6.90	N/A or Unfinished	Set screw kit	100139P	144.90	Polished Brass	Handle kit
99915	0.20	N/A	Moen silicone grease for cartridges and o-rings	100140	19.20	N/A or Unfinished	Grip ring
100000	10.35	N/A or Unfinished	O-ring kit	100142P	75.20	Polished Brass	Escutcheon
100005CSL	20.00	Classic Stainless	Hose guide	100142W	70.45	Glacier	Escutcheon
100005SL	20.00	Stainless	Hose guide	100150	45.25	Chrome	Handle kit
100005SLP	20.00	Brushed Platinum	Hose guide	100150BL	65.60	Matte Black	Handle kit
100006	17.50	Glacier	Hose guide	100150CSL	134.75	Classic Stainless	Handle kit
100007	22.90	Sand	Hose guide	100150S	65.60	Sand	Handle kit
100008	18.50	N/A or Unfinished	Hardware kit	100150SL	65.60	Stainless	Handle kit
100009	161.05	Chrome	Spout kit	100150V	63.20	Ivory	Handle kit
100009P	241.50	Polished Brass	Spout kit	100150W	63.20	Glacier	Handle kit
100009S	241.50	Sand	Spout kit	100151	26.55	Chrome	Escutcheon
100009SL	233.40	Stainless	Spout kit	100151BL	30.15	Matte Black	Escutcheon
100009V	233.40	Ivory	Spout kit	100151S	30.15	Sand	Escutcheon
100009W	233.40	Glacier	Spout kit	100151SL	32.15	Stainless	Escutcheon
100011	26.75	Chrome	Escutcheon	100151W	30.15	Glacier	Escutcheon
100011SL	37.10	Stainless	Escutcheon	100152	95.15	Chrome	Spout receptor kit
100011V	38.40	Ivory	Escutcheon	100152BL	106.80	Matte Black	Spout receptor kit
100011W	38.40	Glacier	Escutcheon	100152CSL	170.20	Classic Stainless	Spout receptor kit
100012	37.70	Chrome	Handle kit	100152S	110.75	Sand	Spout receptor kit
100012BL	56.55	Matte Black	Handle kit	100152SL	134.45	Stainless	Spout receptor kit
100012P	56.55	Polished Brass	Handle kit	100152W	113.60	Glacier	Spout receptor kit
100012S	56.55	Sand	Handle kit	100154	46.50	Chrome	Handle kit
100012SL	54.70	Stainless	Handle kit	100154CSL	64.60	Classic Stainless	Handle kit
100012V	56.55	Ivory	Handle kit	100154S	65.15	Sand	Handle kit
100012W	56.55	Glacier	Handle kit	100154SL	67.50	Stainless	Handle kit
100014	20.00	Chrome	Dome	100154W	65.15	Glacier	Handle kit
100014P	29.70	Polished Brass	Dome	100155	17.30	Chrome	Handle cap kit
100014SL	27.65	Stainless	Dome	100155CSL	21.20	Classic Stainless	Handle cap kit
100014V	30.40	Ivory	Dome	100155SL	25.05	Stainless	Handle cap kit
100014W	30.40	Glacier	Dome	100155V	24.25	Ivory	Handle cap kit
100015	24.25	N/A or Unfinished	Support plate with gasket	100155W	24.25	Glacier	Handle cap kit
100016	82.85	Chrome	Spout kit	100169P	157.55	Polished Brass	Spout kit
100016SL	120.05	Stainless	Spout kit	100169W	157.55	Glacier	Spout kit
100016W	124.20	Glacier	Spout kit	100202	11.25	N/A or Unfinished	Handle adapter kit
100021	16.35	Chrome	Handle cap & temperature indicator kit for 7400 series kitchen faucets	100205	8.25	N/A or Unfinished	Set screw kit
100021S	18.70	Sand	Handle cap kit	100214	17.15	N/A or Unfinished	Handle adapter kit
100021SLP	18.35	Brushed Platinum	Handle cap kit	100216	14.80	N/A or Unfinished	Cartridge cap & nut kit
100021V	18.70	Ivory	Handle cap kit	100223	7.60	N/A or Unfinished	Handle adapter & brake kit, Chateau & Moentrol lever 1 handle tub/shower
100021W	18.70	Glacier	Handle cap kit				

Moen Genuine Parts

Listed in numerical order

Part Number	List Price	Finish	Description	Part Number	List Price	Finish	Description
100224	19.70	Chrome	Handle kit	100562	4.50	N/A or Unfinished	Handle adapter, Monticello widespread lav & bidet
100224P	31.20	Polished Brass	Handle kit				
100226	37.65	Chrome	Handle cap & screw	100563	4.45	N/A or Unfinished	Handle adapter, Monticello 2 handle tub/shower, 2 handle kitchen, & Roman tub
100227	75.60	Chrome	Spout nut kit				
100228	36.45	Chrome	Escutcheon	100566	12.50	N/A or Unfinished	Small chassis for Monticello bar, centerset, mini widespread
100230	55.35	Chrome	Spout hub kit				
100232	39.25	Chrome	Handle hub	100593	117.60	N/A or Unfinished	Vacuum breaker kit
100233	40.35	Chrome	Handle hub	100602	110.00	N/A or Unfinished	Vacuum breaker kit
100242	6.40	N/A or Unfinished	Handle insert kit	100615	31.85	Chrome	Escutcheon
100250	14.00	Chrome	Spout cap	100616	53.60	Chrome	Spout kit
100251	2.75	N/A or Unfinished	Washer	100621	57.05	Chrome	Handle kit
100254	65.25	Chrome	Spout kit	100621BC	68.50	Brushed Chrome	Handle kit
100255	19.10	N/A or Unfinished	Diverter kit	100621CBN	51.50	Classic Brushed Nickel	Handle kit
100261	42.80	Chrome	Escutcheon	100624	57.05	Chrome	Handle kit
100263	10.55	N/A or Unfinished	Handle cap & screw	100624BC	68.50	Brushed Chrome	Handle kit
100265	19.05	N/A or Unfinished	Handle cap & screw	100624CBN	51.50	Classic Brushed Nickel	Handle kit
100270	5.30	N/A or Unfinished	Handle connector	100625	27.10	Chrome	Escutcheon
100283	1.75	N/A or Unfinished	Gasket	100626	39.20	Chrome	Bar spout & spout nut
100311	15.05	N/A or Unfinished	Handle adapter kit	100649	125.10	Chrome	Spout kit
100332	9.75	N/A or Unfinished	Hot/cold indicator kit	100649CBN	152.15	Classic Brushed Nickel	Spout kit
100429	6.40	Chrome	Handle adapter kit	100650	12.70	Chrome	Escutcheon
100433	49.30	Chrome	Escutcheon	100650BC	15.45	Brushed Chrome	Escutcheon
100433BL	58.45	Matte Black	Escutcheon	100650CBN	19.05	Classic Brushed Nickel	Escutcheon
100433CSL	70.10	Classic Stainless	Escutcheon	100650P	19.90	Polished Brass	Escutcheon
100433SL	54.30	Stainless	Escutcheon	100652	143.30	Chrome	Roman tub spout kit
100433SRS	77.10	Spot Resist Stainless	Escutcheon	100652BC	172.05	Brushed Chrome	Roman tub spout kit
100433W	56.65	Glacier	Escutcheon	100652P	222.15	Polished Brass	Roman tub spout kit
100439	13.75	Chrome	Dome kit	100654	157.80	Chrome	Roman tub diverter spout
100439BL	80.40	Matte Black	Dome kit	100654BC	181.40	Brushed Chrome	Roman tub spout kit
100439S	15.05	Sand	Dome kit	100655	33.20	Chrome	Diverter rod kit
100439SL	22.00	Stainless	Dome kit	100655BC	38.10	Brushed Chrome	Diverter rod kit
100439W	15.05	Glacier	Dome kit	100656	121.80	Chrome	Garden tub spout
100440	29.10	N/A or Unfinished	Handle hardware kit, pullout kitchens	100657	25.20	Chrome	Handle kit
100444	22.70	N/A or Unfinished	Quarter turn connector & screen washer	100657BC	30.15	Brushed Chrome	Handle kit
100513	25.85	Chrome	Soap dispenser pump	100657P	39.05	Polished Brass	Handle kit
100538	7.90	N/A or Unfinished	Spout plug	100657W	35.25	Glacier	Handle kit
100539	13.00	N/A or Unfinished	Mounting kit	100665	34.95	Polished Brass	Spout kit
100541	26.00	N/A or Unfinished	Handle adapter kit	100667	125.10	Polished Brass	Spout kit
100552	83.65	Chrome	Handle hub kit	100675	137.30	Polished Brass	Spout kit
100552ORB	133.55	Oil Rubbed Bronze	Handle hub kit	100676	38.45	N/A or Unfinished	Valve body
100552P	129.70	Polished Brass	Handle hub kit	100679	58.15	Chrome	Handle kit
100552SL	121.35	Stainless	Handle hub kit	100683	5.80	N/A or Unfinished	Gasket
100553	83.65	Chrome	Handle hub kit	100695	37.20	N/A or Unfinished	Handle kit
100553ORB	133.55	Oil Rubbed Bronze	Handle hub kit	100702	31.40	N/A or Unfinished	Shank kit
100553P	129.70	Polished Brass	Handle hub kit	100710	21.45	N/A or Unfinished	Knob handle kit, Posi-Temp 1 handle tub/shower, with white & chrome insert
100553SL	121.35	Stainless	Handle hub kit	100736	9.75	N/A or Unfinished	Hardware kit
100556	34.05	Chrome	Handle hub kit	100742	42.20	N/A or Unfinished	Valve body
100556BN	49.35	Brushed Nickel	Handle hub kit	100743	42.20	N/A or Unfinished	Valve body
100556P	54.40	Polished Brass	Handle hub kit	100746	21.70	Chrome	Handle kit
100556PM	39.20	Platinum	Handle hub kit	100746ORB	32.00	Oil Rubbed Bronze	Handle kit
100556ST	54.40	Satine	Handle hub kit	100746SRS	26.90	Spot Resist Stainless	Handle kit
100556W	54.40	Glacier	Handle hub kit	100816	24.65	N/A or Unfinished	Extension kit
100557	39.35	Chrome	Handle hub kit	100817	31.50	N/A or Unfinished	Shank kit
100557P	60.65	Polished Brass	Handle hub kit	100818	33.80	N/A or Unfinished	Extension kit
100558	39.10	Chrome	Handle hub kit	100820	70.80	Chrome	Spout kit
100558P	60.20	Polished Brass	Handle hub kit	100820SRS	88.90	Spot Resist Stainless	Spout kit
100558SL	56.65	Stainless	Handle hub kit				
100558W	60.20	Chrome	Handle hub kit				
100559	44.35	Chrome	Handle hub kit				
100559P	68.40	Polished Brass	Handle hub kit				
100561	11.55	N/A or Unfinished	Handle adapter, hot and cold, Monticello bar, centerset, mini widespread				

Moen Genuine Parts

Listed in numerical order

Part Number	List Price	Finish	Description	Part Number	List Price	Finish	Description
100895	24.60	Chrome	Handle kit	101246	83.00	Chrome	Spout receptor kit
100895SRS	30.90	Spot Resist Stainless	Handle kit	101246SL	91.25	Stainless	Spout receptor kit
100896	74.95	Chrome	Spout kit	101246V	68.20	Ivory	Spout receptor kit
100896ORB	121.25	Oil Rubbed Bronze	Spout kit	101246W	68.20	Glacier	Spout receptor kit
100896SRS	98.65	Spot Resist Stainless	Spout kit	101249	16.10	Chrome	Handle collar & nut kit, OneTouch
100928	25.20	Chrome	Handle kit	101249S	24.70	Sand	Collar & nut kit
100928ORB	38.35	Oil Rubbed Bronze	Handle kit	101249SL	23.30	Stainless	Collar & nut kit
100928SRS	31.65	Spot Resist Stainless	Handle kit	101249V	24.70	Ivory	Collar & nut kit
100955	7.55	N/A or Unfinished	Cartridge nut	101249W	24.70	Glacier	Collar & nut kit
100957	23.30	Chrome	Escutcheon	101257	14.55	Chrome	Pullout spout aerator kit
100957ORB	30.40	Oil Rubbed Bronze	Escutcheon	101310	20.55	Chrome	Lever handle kit, Chateau 1 handle lav
100957SRS	26.85	Spot Resist Stainless	Escutcheon	101406	18.05	Chrome	Lift rod kit
100961	125.20	Chrome	Spout kit	101406BN	25.85	Brushed Nickel	Lift rod kit
100961ORB	186.25	Oil Rubbed Bronze	Spout kit	101408	24.40	Chrome	Handle kit
100961SRS	155.80	Spot Resist Stainless	Spout kit	101410	52.75	Chrome	Handle kit
100998	16.10	Chrome	Escutcheon	101412	28.15	Chrome	Handle kit
101010	14.55	Chrome	Aerator	101414P	235.35	Polished Brass	Roman tub spout kit
101010ORB	22.65	Bronze - Oil Rubbed	Aerator	101418	36.15	N/A or Unfinished	Spout cap kit
101010W	10.65	Glacier	Aerator	101420	22.80	N/A or Unfinished	Spout cap kit
101012BN	17.55	Brushed Nickel	Aerator	101424	14.20	N/A or Unfinished	Handle insert kit
101023	22.70	Chrome	Aerator	101475	5.45	Chrome	Hose guide
101023CSL	32.80	Classic Stainless	Aerator kit	101484	91.95	Chrome	Spout receptor kit
101023NL	32.50	Nickel	Aerator	101484SL	129.90	Stainless	Spout receptor kit
101023WR	35.40	Wrought Iron	Aerator	101484W	103.30	Glacier	Spout receptor kit
101029	15.65	Chrome	Aerator	101652	32.00	Chrome	Tub drain assembly
101029BN	23.45	Brushed Nickel	Aerator	101653	31.40	Chrome	Tub drain assembly
101029CSL	22.85	Classic Stainless	Aerator	101707	18.05	N/A or Unfinished	Vacuum breaker hub assembly
101029NL	23.65	Nickel	Aerator	101708	70.05	N/A or Unfinished	Hose kit
101029ORB	25.85	Bronze - Oil Rubbed	Aerator	101869	24.30	N/A or Unfinished	Hardware kit
101029SRS	22.05	Spot Resist Stainless	Aerator	101871	109.40	Chrome	Spout kit
101029WR	25.85	Wrought Iron	Aerator	101871SL	131.95	Stainless	Spout kit
101036	15.45	Chrome	Aerator	101878	33.75	Chrome	Aerator
101039	13.00	N/A or Unfinished	Hardware kit	101879	6.70	N/A or Unfinished	Spout retaining ring kit, Monticello & Traditional 2 handle bar
101048	18.95	Chrome	Aerator	101951	18.40	N/A or Unfinished	Diverter kit
101064	31.40	Chrome	Handle kit	101952	23.65	N/A or Unfinished	Hardware kit
101064BN	46.20	Brushed Nickel	Handle kit	101956	19.20	N/A or Unfinished	Stem extension kit
101064ORB	56.55	Oil Rubbed Bronze	Handle kit	101957	16.55	N/A or Unfinished	Lever handle mechanism kit
101076	5.20	Chrome	Aerator	101964	22.15	Chrome	Aerator kit
101077	13.10	Chrome	Aerator	101964BN	32.15	Brushed Nickel	Aerator kit
101077CSL	16.15	Classic Stainless	Aerator	101964NL	32.50	Polished Nickel	Aerator kit
101077ORB	22.00	Oil Rubbed Bronze	Aerator	101964ORB	35.40	Oil Rubbed Bronze	Aerator kit
101077SRS	15.50	Spot Resist Stainless	Aerator	101975	4.60	N/A or Unfinished	Posi-Temp test plug
101099	6.35	N/A or Unfinished	Handle connector, spacer, screw & washer, Loop handle kitchens	102562	11.80	Chrome	Stop tube kit
101100	30.80	N/A or Unfinished	Push-button diverter plug	102562BN	19.60	Brushed Nickel	Stop tube kit
101117	22.95	Chrome	Aerator kit	102563	48.10	Chrome	Escutcheon
101117CSL	22.95	Classic Stainless	Aerator kit	102564	53.90	Chrome	Handle kit
101118	16.10	Chrome	Aerator	102565	39.10	Chrome	Handle kit
101119	16.35	Chrome	Aerator kit	102565BC	47.80	Brushed Chrome	Handle kit
101119ORB	26.00	Oil Rubbed Bronze	Aerator kit	102565SL	57.80	Stainless	Handle kit
101120	19.05	Chrome	Aerator kit	102565V	104.05	Ivory	Handle kit
101120ORB	30.35	Oil Rubbed Bronze	Aerator kit	102565W	50.60	Glacier	Handle kit
101120SRS	27.60	Spot Resist Stainless	Aerator kit	102566	8.30	Chrome	Collar
101140	31.75	Chrome	Handle kit	102566BN	31.60	Brushed Nickel	Collar
101140BN	44.45	Brushed Nickel	Handle kit	102567	4.60	Chrome	Ring shield
101140NL	44.45	Polished Nickel	Handle kit	102567BN	11.50	Brushed Nickel	Collar
101140ORB	48.90	Oil Rubbed Bronze	Handle kit	102568	16.75	N/A or Unfinished	Lever handle mechanism kit, Villeta 1 handle lav
101146	14.55	Chrome	Aerator	102569	5.80	N/A or Unfinished	Gasket
101199	6.80	N/A or Unfinished	Screen washer, pullout spout hose	102570	33.95	Chrome	Lift rod kit
101205	10.75	N/A or Unfinished	Handle insert kit	103432	5.50	N/A or Unfinished	Spout retainer kit
101209	35.95	Chrome	Handle kit				
101237	7.95	N/A or Unfinished	Cup seal & diverter gate, 3800 tub spout				

Moen Genuine Parts

Listed in numerical order

Part Number	List Price	Finish	Description	Part Number	List Price	Finish	Description
103433	94.80	Chrome	Spout hub kit	103686	19.10	N/A or Unfinished	Check stop
103433P	201.40	Polished Brass	Spout hub kit	103687	61.30	N/A or Unfinished	Check stop
103437	5.65	N/A or Unfinished	Handle connector, spacer, screw & washer, Integra	103688	27.45	N/A or Unfinished	Thermostatic cartridge parts
103441V	33.90	Ivory	Aerator	103689	29.75	N/A or Unfinished	Temperature limit stop kit
103454	69.90	Chrome	Handle kit	103690	16.15	N/A or Unfinished	Handle adapter kit
103454BN	101.25	Brushed Nickel	Handle kit	103691	4.15	N/A or Unfinished	Screw kit
103454NL	107.55	Polished Nickel	Handle kit	103692	23.80	N/A or Unfinished	Retainer nut
103454ORB	107.55	Oil Rubbed Bronze	Handle kit	103744	9.30	N/A or Unfinished	Escutcheon clip & washer
103454P	107.55	Polished Brass	Handle kit	103745	61.20	Chrome	Handle escutcheon
103454WR	107.55	Wrought Iron	Handle kit	103745P	94.15	Polished Brass	Handle escutcheon
103455	71.50	Chrome	Spray nozzle	103759	10.10	N/A or Unfinished	Hardware kit
103455BN	99.90	Brushed Nickel	Spray nozzle	103760	85.90	Chrome	Spout escutcheon
103455ORB	106.00	Oil Rubbed Bronze	Spray nozzle	103760P	97.90	Polished Brass	Spout escutcheon
103455P	106.00	Polished Brass	Spray nozzle	104212	11.45	N/A or Unfinished	Aerator removal tool
103455WR	106.00	Wrought Iron	Spray nozzle	104213	181.35	Chrome	Spout kit
103456	24.85	N/A or Unfinished	Handle adapter kit, widedspread lav & bidet, M-PACT	104213P	279.35	Polished Brass	Spout kit
103457NL	50.60	Polished Nickel	Escutcheon	104215	24.70	Chrome	Lift rod kit
103460	9.00	N/A or Unfinished	O-ring kit	104215NL	41.70	Polished Nickel	Lift rod kit
103461	31.20	Chrome	Spout escutcheon	104217	9.25	Chrome	Aerator
103461P	42.15	Polished Brass	Spout escutcheon	104218	9.80	N/A or Unfinished	O-ring kit
103462	10.45	N/A or Unfinished	Installation tool, M-PACT mini widedspread & widedspread	104224	9.95	N/A or Unfinished	Handle adapter kit
103463	35.80	Chrome	Spout escutcheon	104225	10.20	N/A or Unfinished	Hardware kit
103463BN	48.85	Brushed Nickel	Spout escutcheon	104228	14.65	Chrome	Aerator
103463P	48.15	Polished Brass	Spout escutcheon	104231BL	49.95	Matte Black	Handle shell
103463W	45.05	Glacier	Spout escutcheon	104231V	38.10	Ivory	Handle shell
103464	19.70	Chrome	Lift rod kit	104232	19.70	Chrome	Handle kit
103464BN	28.55	Brushed Nickel	Lift rod kit	104233	6.80	N/A or Unfinished	Handle adapter kit
103464P	30.30	Polished Brass	Lift rod kit	104235	16.50	Chrome	Hose guide
103465	7.20	N/A or Unfinished	Set screw kit	104235CP	18.20	Chrome	Hose guide
103466	5.50	N/A or Unfinished	O-ring kit	104235ORB	26.05	Oil Rubbed Bronze	Hose guide
103468	141.55	Chrome	Spout kit	104235P	22.15	Polished Brass	Hose guide
103468BN	205.25	Brushed Nickel	Spout kit	104247	6.90	N/A or Unfinished	Escutcheon screws
103468P	218.00	Polished Brass	Spout kit	104248	7.10	N/A or Unfinished	Handle adapter kit
103469	51.65	N/A or Unfinished	Hose kit	104249P	22.50	Polished Brass	Stop tube kit
103470	58.20	Chrome	Escutcheon	104407	14.95	N/A or Unfinished	Handle housing kit
103470BN	82.35	Brushed Nickel	Escutcheon	104409	4.75	N/A or Unfinished	Handle adapter kit
103470NL	87.50	Polished Nickel	Escutcheon	104410	89.10	Chrome	Handle kit
103470ORB	80.45	Oil Rubbed Bronze	Escutcheon	104410NL	151.65	Polished Nickel	Handle kit
103470P	79.55	Polished Brass	Escutcheon	104411	4.10	N/A or Unfinished	Set screw kit
103470WR	90.45	Wrought Iron	Escutcheon	104419	6.90	N/A or Unfinished	Plug button kit
103674	254.35	N/A or Unfinished	Cartridge	104421	50.65	N/A or Unfinished	cartridge removal tool for 1200 or 1225 or 1222 cartridges
103675	35.25	Chrome	Handle shell	104452	163.60	N/A or Unfinished	CONTROL MODULE 8310 CLOSET 1.28
103675BL	49.25	Matte Black	Handle shell	104453	58.35	Chrome	AC TUBE AND Flange FOR FLUSH VALVE
103675BN	51.00	Brushed Nickel	Handle shell	104454	94.65	Chrome	AC FLUSH VALVE CAP
103675NL	52.80	Polished Nickel	Handle shell	104455	82.95	Chrome	DC FLUSH VALVE CAP
103675ORB	56.10	Oil Rubbed Bronze	Handle shell	104456	12.85	N/A or Unfinished	SENSOR EYE CASING
103675P	54.45	Polished Brass	Handle shell	104457	2.50	N/A or Unfinished	O-RING FOR ELECTRONIC FAUCET SPOUT
103675V	49.25	Ivory	Handle shell	104458	2.50	N/A or Unfinished	SPLIT WASHER FOR ELECTRONIC SPOUT
103675WR	56.10	Wrought Iron	Handle shell	104459	6.50	N/A or Unfinished	BATTERY HOLDER FOR ELECTRONIC FAUCET
103678	19.65	Chrome	Escutcheon	104460	9.20	Chrome	ELECTRONIC FAUCET SPOUT NUT
103678BN	29.15	Brushed Nickel	Escutcheon	104461	30.75	Chrome	MANUAL OVERRIDE BUTTON
103678NL	30.05	Polished Nickel	Escutcheon	104534	18.15	Chrome	1.5 GPM AERATOR FOR 83-5 SERIES
103678ORB	32.15	Oil Rubbed Bronze	Escutcheon	104540	37.40	Chrome	Service kit
103678P	32.25	Polished Brass	Escutcheon	104541	32.75	Chrome	Service kit
103678WR	32.15	Wrought Iron	Escutcheon				
103681	53.05	Chrome	Handle shell				
103681BL	36.35	Matte Black	Handle shell				
103681P	76.95	Polished Brass	Handle shell				
103681V	36.35	Ivory	Handle shell				
103685	32.35	N/A or Unfinished	Retainer nut				

Moen Genuine Parts

Listed in numerical order

Part Number	List Price	Finish	Description	Part Number	List Price	Finish	Description
104542	45.55	Chrome	Service kit	113173	9.75	N/A or Unfinished	Mounting kit
104543	50.25	Chrome	Service kit	113957	5.50	Chrome	Plug button & set screw
104544	56.05	Chrome	Service kit	113958	5.85	N/A or Unfinished	Gasket
104545	61.90	Chrome	Service kit	113959	7.40	Chrome	Dome kit
104546	32.75	Chrome	Service kit	113959BN	17.15	Brushed Nickel	Dome kit
104547	36.25	Chrome	Service kit	113959ORB	19.60	Oil Rubbed Bronze	Dome kit
104548	38.55	Chrome	Service kit	113959WR	19.60	Wrought Iron	Dome kit
104549	42.05	Chrome	Service kit	113973	21.45	Chrome	Handle kit
104550	46.75	Chrome	Service kit	113974	7.35	N/A or Unfinished	Gasket kit
104551	50.25	Chrome	Service kit	114295	17.25	N/A or Unfinished	Hardware kit
104552	56.05	Chrome	Service kit	114299	33.75	N/A or Unfinished	Hose kit
104553	59.60	Chrome	Service kit	114303	7.25	N/A or Unfinished	Cartridge nut
104554	64.25	Chrome	Service kit	114304	37.90	Chrome	Handle kit
104555	112.55	Chrome	Stop valve	114304CSL	55.05	Classic Stainless	Handle kit
104556	112.55	Chrome	Stop valve	114304ORB	78.45	Oil Rubbed Bronze	Handle kit
104557	19.70	Chrome	Service kit	114304SL	55.05	Stainless	Handle kit
104592	26.45	Chrome	Service kit	114305	14.70	Chrome	Handle hub
104617	29.80	N/A or Unfinished	Service kit	114305CSL	21.50	Classic Stainless	Handle hub
104618	70.50	Chrome	Service kit	114305ORB	38.30	Oil Rubbed Bronze	Handle hub
104619	70.50	Chrome	Service kit	114305SL	21.50	Stainless	Handle hub
104620	70.50	Chrome	Service kit	114306	18.05	N/A or Unfinished	Hardware kit
104621	70.50	Chrome	Service kit	114307	20.95	N/A or Unfinished	Hose kit, Aberdeen 7590 series
104622	70.50	Chrome	Service kit	114308	12.80	N/A or Unfinished	Stem extension kit
104623	70.50	Chrome	Service kit	114309	36.45	Chrome	Handle hub kit
104624	70.50	Chrome	Service kit	114309SL	56.30	Stainless	Handle hub kit
104625	33.20	Chrome	Service kit	114310	26.10	Chrome	Handle insert kit
104626	34.10	Chrome	Service kit	114310SL	39.30	Stainless	Handle insert kit
104627	31.70	Chrome	Service kit	114311	7.80	N/A or Unfinished	Screen washer
104628	93.80	N/A or Unfinished	Service kit	114324	18.80	Chrome	Handle cap kit
104630	96.35	N/A or Unfinished	Service kit	114324BN	27.15	Brushed Nickel	Handle cap kit
104631	31.80	Chrome	Service kit	114324ORB	29.75	Oil Rubbed Bronze	Handle cap kit
104633	113.50	N/A or Unfinished	Service kit	114324P	26.00	Polished Brass	Handle cap kit
104634	22.40	Chrome	Service kit	114324SRS	26.20	Spot Resist Stainless	Handle cap kit
104635	145.00	N/A or Unfinished	Electronic module bracket kit	114324W	4.35	White	Cap kit
104636	145.00	N/A or Unfinished	Electronic module bracket kit	114324WR	29.75	Wrought Iron	Handle cap kit
104637	145.00	N/A or Unfinished	Electronic module bracket kit	114328	26.25	Chrome	Lift rod kit
104638	145.00	N/A or Unfinished	Electronic module bracket kit	114328BN	38.30	Brushed Nickel	Lift rod kit
104639	145.00	N/A or Unfinished	Electronic module bracket kit	114328ORB	42.20	Oil Rubbed Bronze	Lift rod kit
104640	145.00	N/A or Unfinished	Electronic module bracket kit	114331	17.70	Chrome	Handle hub kit
104641	145.00	N/A or Unfinished	Electronic module bracket kit	114331BN	25.00	Brushed Nickel	Handle hub
104770	20.75	Chrome	Pop-up waste kit	114331ORB	27.50	Oil Rubbed Bronze	Handle hub kit
104775	22.80	Chrome	Pop-up waste kit	114331P	27.80	Polished Brass	Handle hub kit
105896	8.30	N/A or Unfinished	Hardware kit	114331WR	27.50	Wrought Iron	Handle hub kit
105897	32.35	Chrome	Shower escutcheon	114332	13.60	Chrome	Aerator
106322	10.65	N/A or Unfinished	Hardware kit	114332BN	19.50	Brushed Nickel	Aerator
106324	27.50	N/A or Unfinished	T-connector	114332ORB	21.55	Oil Rubbed Bronze	Aerator
106376	21.50	Chrome	Handshower bracket	114332WR	21.55	Wrought Iron	Aerator
106378	19.05	N/A or Unfinished	Stem extension kit	114333	6.20	N/A or Unfinished	Gasket
106479	4.60	N/A or Unfinished	Temperature limit stop kit, Posi-Temp 1 handle tub/shower	114334	15.35	Chrome	Lift rod kit
109110	22.05	N/A or Unfinished	Hardware kit	114334BN	22.30	Brushed Nickel	Lift rod kit
109248	70.05	N/A or Unfinished	Hose kit	114334ORB	23.75	Oil Rubbed Bronze	Lift rod kit
110301W	24.70	Glacier	Lift rod kit	114334P	23.75	Polished Brass	Lift rod kit
110307	4.90	N/A or Unfinished	Cartridge nut	114334WR	23.75	Wrought Iron	Lift rod kit
110308P	52.10	Polished Brass	Handle hub kit	114336	9.80	Chrome	Handle insert kit
110312NL	22.20	Polished Nickel	Spout nut kit	114336ORB	19.40	Oil Rubbed Bronze	Handle insert kit
110317	96.20	Chrome	Handle extension kit	114336SRS	20.40	Spot Resist Stainless	Handle kit
111881	24.70	Chrome	Handle kit	114337	65.20	Chrome	Handle hub kit
111881BC	29.70	Brushed Chrome	Handle kit	114337BN	94.70	Brushed Nickel	Handle kit
				114337NL	96.20	Polished Nickel	Handle kit
				114337ORB	104.15	Oil Rubbed Bronze	Handle hub kit
				114337P	92.15	Polished Brass	Handle hub kit
				114337WR	104.15	Wrought Iron	Handle hub kit
				114338	219.35	Chrome	Roman tub spout kit
				114338BN	252.20	Brushed Nickel	Spout kit

Moen Genuine Parts

Listed in numerical order

Part Number	List Price	Finish	Description	Part Number	List Price	Finish	Description
114338ORB	337.80	Oil Rubbed Bronze	Roman tub spout kit	115046	38.15	Chrome	Handle kit
114339BN	252.40	Brushed Nickel	Spout kit	115047	54.90	Chrome	Spout kit
114339ORB	333.40	Oil Rubbed Bronze	Roman tub spout kit	115049	32.45	Chrome	Escutcheon with hose guide
114340	10.80	Chrome	Diverter rod kit	115051	27.30	Chrome	Handle hub
114340BN	26.85	Brushed Nickel	Lift rod kit	115051BN	39.60	Brushed Nickel	Handle hub
114340ORB	28.85	Oil Rubbed Bronze	Diverter rod kit	115055	11.25	Chrome	Handle cap & screw
114340P	28.85	Polished Brass	Diverter rod kit	115055BN	15.65	Brushed Nickel	Handle cap & screw
114340WR	28.85	Wrought Iron	Diverter rod kit	115056	23.45	Chrome	Handle kit
114343	15.05	N/A or Unfinished	Handle cap & screw	115057	5.00	Chrome	Gasket
114343BN	21.85	Brushed Nickel	Handle cap & screw	115060	24.80	Chrome	Handle kit
114343NL	23.45	Polished Nickel	Handle cap kit	115060SLP	27.10	Brushed Platinum	Handle kit
114343ORB	24.05	Oil Rubbed Bronze	Handle cap & screw	115061	7.40	N/A or Unfinished	Bearing washer kit
114343P	23.45	Polished Brass	Handle cap & screw	115062	4.60	N/A or Unfinished	Gasket
114343WR	24.05	Wrought Iron	Handle cap & screw	115063	40.65	Chrome	Handle kit
114344	24.25	Chrome	Handle hub	115063BN	63.05	Brushed Nickel	Handle kit
114344BN	35.15	Brushed Nickel	Handle hub	115066	7.25	Chrome	Handle insert kit
114344ORB	38.70	Oil Rubbed Bronze	Handle hub	115066P	12.30	Polished Brass	Handle insert kit
114344P	37.50	Polished Brass	Handle hub	115071	22.00	Chrome	Handshower bracket
114344WR	38.70	Wrought Iron	Handle hub	115072	29.65	N/A or Unfinished	Hardware kit
114346	26.55	Chrome	Handle hub	115073	11.45	N/A or Unfinished	Hardware kit
114346BN	38.65	Brushed Nickel	Handle kit	115077	74.70	Chrome	Vacuum breaker kit
114346NL	41.20	Polished Nickel	Handle kit	115335	108.40	Chrome	Spout kit
114346ORB	42.45	Oil Rubbed Bronze	Handle hub	115335BN	157.15	Brushed Nickel	Spout kit
114346P	41.20	Polished Brass	Handle hub	115335ORB	166.85	Oil Rubbed Bronze	Spout kit
114346WR	42.45	Wrought Iron	Handle hub	115335WR	166.85	Wrought Iron	Spout kit
114347NL	40.60	Polished Nickel	Handle hub kit	115336	26.55	N/A or Unfinished	Handle kit
114384	6.70	N/A or Unfinished	Retainer ring kit	116379	28.70	N/A or Unfinished	Retainer nut
114385	17.25	N/A or Unfinished	Liquid dispenser bottle	116604	38.70	Chrome	Handle hub
115000	28.55	N/A or Unfinished	Knob handle kit, Posi-Temp 82683	116604BN	56.10	Brushed Nickel	Handle hub
115006	3.85	N/A or Unfinished	Screw kit	116604NL	54.75	Polished Nickel	Handle hub
115007	14.55	Chrome	Spout hub kit	116604ORB	61.65	Oil Rubbed Bronze	Handle hub
115010	60.10	N/A or Unfinished	Spout kit	116604WR	61.65	Wrought Iron	Handle hub
115012	243.95	N/A or Unfinished	8 foot cable assembly for wall	116606	37.45	Chrome	Shower escutcheon
115022	36.75	Chrome	Handle kit	116606BN	54.30	Brushed Nickel	Shower escutcheon
115023	6.65	Chrome	Handle cap kit	116606NL	53.00	Polished Nickel	Shower escutcheon
115023SL	10.10	Stainless	Handle cap kit	116606ORB	59.80	Oil Rubbed Bronze	Shower escutcheon
115026	13.65	N/A or Unfinished	Handle adapter kit	116606WR	59.80	Wrought Iron	Shower escutcheon
115026BN	20.45	Brushed Nickel	Handle adapter kit	116610	7.95	N/A or Unfinished	Handle adapter kit
115026P	21.25	Polished Brass	Handle adapter kit	116618	15.65	Chrome	Aerator
115027	12.20	Chrome	Lift rod kit	116618BN	23.45	Brushed Nickel	Aerator
115027BN	16.95	Brushed Nickel	Lift rod kit	116618CSL	23.45	Classic Stainless	Aerator
115029	18.40	Chrome	Handle hub	116618NL	23.65	Polished Nickel	Aerator
115029BN	27.70	Brushed Nickel	Handle hub	116618ORB	25.85	Oil Rubbed Bronze	Aerator
115029SLP	20.90	Brushed Platinum	Handle hub	116618SRS	22.70	Spot Resist Stainless	Aerator
115030	23.75	Chrome	Handle kit	116618WR	25.85	Wrought Iron	Aerator
115030SLP	26.00	Brushed Platinum	Handle kit	116619	18.55	Chrome	Lift rod kit
115033	18.00	N/A or Unfinished	Porcelain handle insert	116619BN	39.20	Brushed Nickel	Lift rod kit
115034	11.30	Chrome	Handle cap kit, chrome & polished brass	116619NL	43.15	Polished Nickel	Lift rod kit
115034BC	13.60	Brushed Chrome	Handle cap kit	116619ORB	43.15	Oil Rubbed Bronze	Lift rod kit
115034BN	16.35	Brushed Nickel	Handle cap kit	116620	23.05	Chrome	Spout hub kit
115035	7.25	Chrome	Handle hub	116620BN	33.55	Brushed Nickel	Spout hub kit
115036	23.95	Chrome	Handle kit	116620NL	33.55	Polished Nickel	Spout hub kit
115037	10.35	Chrome	Spout cap kit	116620ORB	36.75	Oil Rubbed Bronze	Spout hub kit
115038	7.60	N/A or Unfinished	Bearing washer kit	116622	32.70	Chrome	Escutcheon
115039	53.80	Chrome	Spout kit	116622BN	47.45	Brushed Nickel	Escutcheon
115039P	76.65	Polished Brass	Spout kit	116622NL	47.45	Polished Nickel	Escutcheon
115040	13.00	Chrome	Hose guide	116622ORB	52.25	Oil Rubbed Bronze	Escutcheon
115040SL	18.40	Stainless	Hose guide	116623	17.55	N/A or Unfinished	Retainer ring kit
115041	24.95	Chrome	Escutcheon & gasket kit	116626	62.65	Chrome	Spout kit
115043	49.60	Chrome	Spout kit	116626BN	89.35	Brushed Nickel	Spout kit
115045	8.75	Chrome	Aerator	116626NL	90.50	Polished Nickel	Spout kit
115045P	13.05	Polished Brass	Aerator	116626ORB	98.40	Oil Rubbed Bronze	Spout kit
115045SL	13.60	Stainless	Aerator	116627	17.95	Chrome	Spout escutcheon
				116627BN	26.05	Brushed Nickel	Spout escutcheon

Part Number	List Price	Finish	Description	Part Number	List Price	Finish	Description
116627NL	27.15	Polished Nickel	Spout escutcheon	116645ORB	302.40	Oil Rubbed Bronze	Spout kit
116627ORB	28.70	Oil Rubbed Bronze	Spout escutcheon	116645SRS	252.90	Spot Resist Stainless	Spout kit
116628	14.25	Chrome	Handle kit	116645WR	302.40	Wrought Iron	Spout kit
116628BN	20.55	Brushed Nickel	Handle kit	116646	54.10	Chrome	Handle hub kit
116628NL	20.55	Polished Nickel	Handle kit	116646BN	78.50	Brushed Nickel	Handle hub kit
116628ORB	22.75	Oil Rubbed Bronze	Handle kit	116646NL	86.30	Polished Nickel	Handle hub kit
116628SRS	19.90	Chrome	Handle kit	116646ORB	86.30	Oil Rubbed Bronze	Handle hub kit
116628WR	22.75	Wrought Iron	Handle kit	116646SRS	79.45	Spot Resist Stainless	Handle hub kit
116629	49.25	Chrome	Handle hub	116646WR	86.30	Wrought Iron	Handle hub kit
116629BN	94.20	Brushed Nickel	Handle hub	116647	54.05	Chrome	Handle hub kit
116629NL	94.20	Polished Nickel	Handle hub	116647BN	78.40	Brushed Nickel	Handle hub kit
116629ORB	102.15	Oil Rubbed Bronze	Handle hub	116647NL	86.20	Polished Nickel	Handle hub kit
116629SRS	85.60	Spot Resist Stainless	Handle hub kit	116647ORB	86.20	Oil Rubbed Bronze	Handle hub kit
116629WR	102.15	Wrought Iron	Handle hub	116647SRS	79.35	Spot Resist Stainless	Handle hub kit
116630	117.25	Chrome	Spout cap	116647WR	86.20	Wrought Iron	Handle hub kit
116630BN	170.00	Brushed Nickel	Spout cap	116648	18.40	Chrome	Lift rod kit
116630NL	187.00	Polished Nickel	Spout cap	116648BN	36.15	Brushed Nickel	Lift rod kit
116630ORB	187.00	Oil Rubbed Bronze	Spout cap	116648NL	39.75	Polished Nickel	Lift rod kit
116631	89.30	Chrome	Roman tub spout kit	116648ORB	39.75	Oil Rubbed Bronze	Lift rod kit
116631BN	161.50	Brushed Nickel	Roman tub spout kit	116648WR	39.75	Wrought Iron	Lift rod kit
116631NL	177.65	Polished Nickel	Roman tub spout kit	116649	27.40	Chrome	Spout cap
116631ORB	177.65	Oil Rubbed Bronze	Roman tub spout kit	116649BN	39.10	Brushed Nickel	Spout cap
116631WR	177.65	Wrought Iron	Roman tub spout kit	116649NL	39.60	Polished Nickel	Spout cap
116632	41.50	Chrome	Stream straightener	116649ORB	43.05	Oil Rubbed Bronze	Spout cap
116632BN	60.30	Brushed Nickel	Stream straightener	116649WR	43.05	Wrought Iron	Spout cap
116632NL	66.35	Polished Nickel	Stream straightener	116653	6.80	N/A or Unfinished	Posi-Temp handle adapter kit
116632ORB	66.35	Oil Rubbed Bronze	Stream straightener	116662P	21.05	Polished Brass	Diverter rod kit
116632WR	66.35	Wrought Iron	Stream straightener	116664	145.15	Chrome	Spout kit
116633	51.15	Chrome	Spout escutcheon	116664BN	210.45	Brushed Nickel	Spout kit
116633BN	77.20	Brushed Nickel	Spout escutcheon	116664ORB	223.55	Oil Rubbed Bronze	Spout kit
116633NL	75.30	Polished Nickel	Spout escutcheon	116664P	177.10	Polished Brass	Spout kit
116633ORB	84.90	Oil Rubbed Bronze	Spout escutcheon	116664WR	223.55	Wrought Iron	Spout kit
116633WR	84.90	Wrought Iron	Spout escutcheon	116665	245.75	Chrome	Roman tub spout kit
116634NL	22.30	Polished Nickel	Aerator	116665BN	356.30	Brushed Nickel	Roman tub spout kit
116635	14.25	Chrome	Diverter rod kit	116665ORB	378.40	Oil Rubbed Bronze	Roman tub spout kit
116635BN	30.05	Brushed Nickel	Diverter rod kit	116665P	393.75	Polished Brass	Roman tub spout kit
116635NL	33.00	Polished Nickel	Diverter rod kit	116665WR	376.80	Wrought Iron	Roman tub spout kit
116635ORB	33.00	Oil Rubbed Bronze	Diverter rod kit	116666	298.90	Chrome	Roman tub spout kit
116635WR	33.00	Wrought Iron	Diverter rod kit	116666BN	382.95	Brushed Nickel	Roman tub spout kit
116636	102.85	Chrome	Diverter spout cap	116666ORB	421.15	Oil Rubbed Bronze	Roman tub spout kit
116636BN	149.20	Brushed Nickel	Diverter spout cap	116666P	422.10	Polished Brass	Roman tub spout kit
116636ORB	164.10	Oil Rubbed Bronze	Diverter spout cap	116666WR	421.15	Wrought Iron	Roman tub spout kit
116636WR	164.10	Wrought Iron	Diverter spout cap	116667	15.90	Chrome	Diverter rod kit
116638	35.15	Chrome	Handle kit	116667BN	22.95	Brushed Nickel	Diverter rod kit
116638ORB	54.70	Oil Rubbed Bronze	Handle kit	116667ORB	24.40	Oil Rubbed Bronze	Diverter rod kit
116638WR	54.70	Wrought Iron	Handle kit	116667P	24.40	Polished Brass	Diverter rod kit
116640	77.95	Chrome	Spout cap	116670	61.80	Chrome	Hot handle kit
116640NL	124.25	Polished Nickel	Spout cap	116670NL	82.50	Polished Nickel	Hot handle kit
116640ORB	124.25	Oil Rubbed Bronze	Spout cap	116670ORB	90.65	Oil Rubbed Bronze	Hot handle kit
116640SL	113.00	Stainless	Spout cap	116670SL	82.50	Stainless	Hot handle kit
116640SRS	109.20	Spot Resist Stainless	Spout cap	116670SRS	82.50	Spot Resist Stainless	Hot handle kit
116640WR	124.25	Wrought Iron	Spout cap	116670WR	90.65	Wrought Iron	Hot handle kit
116641	63.05	Chrome	Spout kit	116671	61.80	Chrome	Cold handle kit
116641ORB	112.55	Oil Rubbed Bronze	Spout kit	116671NL	82.50	Polished Nickel	Cold handle kit
116641SRS	90.35	Spot Resist Stainless	Spout kit	116671ORB	90.65	Oil Rubbed Bronze	Cold handle kit
116641WR	112.55	Wrought Iron	Spout kit	116671SL	82.50	Stainless	Cold handle kit
116642	50.40	Chrome	Spout escutcheon	116671SRS	82.50	Spot Resist Stainless	Cold handle kit
116642ORB	83.05	Oil Rubbed Bronze	Spout escutcheon	116671WR	90.65	Wrought Iron	Cold handle kit
116642SRS	72.95	Spot Resist Stainless	Spout escutcheon	116672	25.95	Chrome	Handle escutcheon
116642WR	83.05	Wrought Iron	Spout escutcheon	116672ORB	39.75	Oil Rubbed Bronze	Handle escutcheon
116644	45.65	Chrome	Spout cap	116672SRS	33.30	Spot Resist Stainless	Handle escutcheon
116644ORB	74.40	Oil Rubbed Bronze	Spout cap	116672WR	39.75	Wrought Iron	Handle escutcheon
116644SRS	65.45	Spot Resist Stainless	Spout cap	116673	80.15	Chrome	Spout escutcheon
116644WR	74.40	Wrought Iron	Spout cap	116673ORB	127.85	Oil Rubbed Bronze	Spout escutcheon
116645	206.30	Chrome	Spout kit				

Moen Genuine Parts

Listed in numerical order

Part Number	List Price	Finish	Description	Part Number	List Price	Finish	Description
116673SRS	106.90	Spot Resist Stainless	Spout escutcheon	117874	58.60	Chrome	Spout receptor kit
116673WR	127.85	Wrought Iron	Spout escutcheon	117947	27.70	Chrome	Handle kit
116683BN	50.65	Brushed Nickel	Handle insert kit	117948	36.60	Chrome	Handle kit
116691BN	75.25	Brushed Nickel	Handle kit	118228	31.15	Chrome	Handle hub kit
116692BN	42.95	Brushed Nickel	Lift rod kit	118229BN	27.30	Brushed Nickel	Handle insert kit
116694BN	27.20	Brushed Nickel	Spout cap	118230	9.90	Chrome	Handle shell
116696	53.35	Chrome	Hose kit	118230BN	14.30	Brushed Nickel	Handle shell
116698	24.95	N/A or Unfinished	Hardware kit	118231	27.45	Chrome	Handle kit
116699	49.95	Chrome	Spout escutcheon	118231BN	38.05	Brushed Nickel	Handle kit
116699BN	74.25	Brushed Nickel	Spout escutcheon	118232	27.45	Chrome	Handle kit
116699NL	75.30	Polished Nickel	Spout escutcheon	118232BN	38.05	Brushed Nickel	Handle kit
116699ORB	81.75	Oil Rubbed Bronze	Spout escutcheon	118239	17.30	Chrome	Aerator
116699WR	81.75	Wrought Iron	Spout escutcheon	118239BN	25.00	Brushed Nickel	Aerator
116711	6.90	N/A or Unfinished	Flow restrictor kit	118239ORB	27.50	Oil Rubbed Bronze	Aerator
116712	8.20	N/A or Unfinished	Flow restrictor kit	118239P	26.85	Polished Brass	Aerator
116713	45.50	Chrome	Handle kit	118239WR	27.50	Wrought Iron	Aerator
116713BRB	81.55	Mediterranean Bronze	Handle kit	118240	8.95	Chrome	Handle cap kit
116716	20.40	Chrome	Handle kit	118240BN	33.35	Brushed Nickel	Handle cap kit
116719	33.00	N/A or Unfinished	Cartridge	118240ORB	40.65	Oil Rubbed Bronze	Handle cap kit
116720	5.70	N/A or Unfinished	Gasket	118240P	24.70	Polished Brass	Handle cap kit
116722	17.80	Chrome	Handle insert kit	118240WR	40.65	Wrought Iron	Handle cap kit
116726	18.30	Chrome	Escutcheon & gasket kit	118241	9.00	Chrome	Handle cap kit
116726ORB	28.95	Oil Rubbed Bronze	Escutcheon & gasket kit	118242P	38.40	Polished Brass	Handle kit
116726SL	26.25	Stainless	Escutcheon & gasket kit	118242WR	50.50	Wrought Iron	Handle kit
116726SRS	25.40	Spot Resist Stainless	Escutcheon & gasket kit	118243	5.65	Chrome	Plug button kit
116728	36.85	Chrome	Handle kit	118243BN	11.50	Brushed Nickel	Plug button kit
116728CSL	53.35	Classic Stainless	Handle kit	118243ORB	12.60	Oil Rubbed Bronze	Plug button kit
116728ORB	58.55	Oil Rubbed Bronze	Handle kit	118243P	13.10	Polished Brass	Plug button kit
116728SL	53.35	Stainless	Handle kit	118244	16.85	Chrome	Lift rod kit
116730	44.75	N/A or Unfinished	Hardware kit	118244BN	24.55	Brushed Nickel	Lift rod kit
116731	6.95	N/A or Unfinished	Bearing washer kit	118244ORB	26.90	Oil Rubbed Bronze	Lift rod kit
116732	41.30	Chrome	Soap dispenser	118244P	34.15	Polished Brass	Lift rod kit
116732SL	59.95	Stainless	Soap dispenser	118244WR	26.90	Wrought Iron	Lift rod kit
116733	7.60	Chrome	Lift rod kit	118245	9.95	N/A or Unfinished	Hardware kit
116953	41.05	Chrome	Hot handle kit	118297	11.45	N/A or Unfinished	Handle mechanism kit
116953BN	63.10	Brushed Nickel	Hot handle kit	118299CSL	86.15	Classic Stainless	Spout kit
116953ORB	69.40	Oil Rubbed Bronze	Handle kit	118299ORB	94.80	Oil Rubbed Bronze	Spout kit
116953P	63.60	Polished Brass	Hot handle kit	118302	56.65	Chrome	Spout hub kit
116953WR	69.40	Wrought Iron	Hot handle kit	118302CSL	82.35	Classic Stainless	Spout nut kit
116954	41.05	Chrome	Cold handle kit	118302ORB	90.45	Oil Rubbed Bronze	Spout hub kit
116954BN	63.10	Brushed Nickel	Cold handle kit	118302V	80.35	Ivory	Spout hub kit
116954ORB	69.40	Oil Rubbed Bronze	Handle kit	118303	21.55	N/A or Unfinished	Hardware kit
116954P	63.60	Polished Brass	Cold handle kit	118304	8.35	N/A or Unfinished	O-ring kit
116954WR	69.40	Wrought Iron	Cold handle kit	118305	12.45	N/A or Unfinished	installation tool
117000	4.20	N/A or Unfinished	Handle insert kit	118306	3.90	N/A or Unfinished	Hot/cold indicator kit
117347	17.55	Chrome	Diverter rod kit	118881	31.95	Chrome	Escutcheon
117347BN	25.50	Brushed Nickel	Diverter rod kit	118881BN	46.35	Brushed Nickel	Escutcheon
117347P	27.15	Polished Brass	Diverter rod kit	118881ORB	51.00	Oil Rubbed Bronze	Escutcheon
117348	241.80	Chrome	Roman tub spout kit	118881P	35.90	Polished Brass	Deck plate
117348BN	350.60	Brushed Nickel	Roman tub spout kit	118881WR	51.00	Wrought Iron	Escutcheon
117348P	374.85	Polished Brass	Roman tub spout kit	118882	18.35	Chrome	Escutcheon
117349	30.55	Chrome	Spout escutcheon	118882BN	27.45	Brushed Nickel	Escutcheon
117349BN	44.25	Brushed Nickel	Spout escutcheon	118882ORB	30.15	Oil Rubbed Bronze	Escutcheon
117349P	47.60	Polished Brass	Spout escutcheon	118882P	36.80	Polished Brass	Escutcheon
117350	324.05	Chrome	Roman tub spout kit	118882WR	30.15	Wrought Iron	Escutcheon
117351P	25.75	Polished Brass	Diverter rod kit	122553	38.75	Chrome	Lift rod kit
117351W	24.60	Glacier	Diverter rod kit	122553BN	56.90	Brushed Nickel	Lift rod kit
117352	453.45	Chrome	Roman tub spout kit	122553ORB	62.65	Oil Rubbed Bronze	Lift rod kit
117352P	336.40	Polished Brass	Roman tub spout kit	122555	72.90	Chrome	Handle kit
117352W	396.80	Glacier	Roman tub spout kit	122555BN	101.85	Brushed Nickel	Handle kit
117654	12.25	Chrome	Diverter rod kit	122555ORB	112.05	Oil Rubbed Bronze	Handle kit
117654P	19.85	Polished Brass	Diverter rod kit	122556	5.65	N/A or Unfinished	O-ring kit
117658	52.95	Chrome	Spout kit	122557	171.60	Chrome	Spout kit
117659	10.90	Chrome	Aerator kit	122557BN	258.15	Brushed Nickel	Spout kit
117660	37.15	Chrome	Handle kit	122557ORB	284.05	Oil Rubbed Bronze	Spout kit

Moen Genuine Parts

Listed in numerical order

Part Number	List Price	Finish	Description	Part Number	List Price	Finish	Description
122558	55.90	Chrome	Handle kit	123804	24.65	Chrome	Lift rod kit
122558BN	84.20	Brushed Nickel	Handle kit	123804BN	37.95	Brushed Nickel	Lift rod kit
122558ORB	92.60	Oil Rubbed Bronze	Handle kit	123807	16.50	Chrome	Stream straightener kit
122559	57.35	Chrome	Handle kit	123807BN	27.15	Brushed Nickel	Stream straightener kit
122559BN	86.25	Brushed Nickel	Handle kit	123807CSL	21.40	Classic Stainless	Stream straightener kit
122559ORB	92.60	Oil Rubbed Bronze	Handle kit	123807SRS	14.25	Spot Resist Stainless	Stream straightener
122560	18.95	Chrome	Aerator kit	123809	20.20	Chrome	Set screw kit
122561	44.15	Chrome	Shower escutcheon	123816	46.90	Chrome	Grid drain without overflow
122561BN	82.85	Brushed Nickel	Shower escutcheon	123816BN	74.00	Brushed Nickel	Grid drain without overflow
122561ORB	86.55	Oil Rubbed Bronze	Shower escutcheon	123816ORB	72.25	Oil Rubbed Bronze	Grid drain without overflow
122562	81.90	Chrome	Escutcheon	124652	11.35	N/A or Unfinished	Hardware kit
122562BN	121.75	Brushed Nickel	Escutcheon	124657ORB	109.85	Oil Rubbed Bronze	Spout kit
122562ORB	133.95	Oil Rubbed Bronze	Escutcheon	124657SRS	99.90	Spot Resist Stainless	Spout kit
122563	96.70	Chrome	Handle kit	124658	48.85	Chrome	Wand kit
122563BN	143.70	Brushed Nickel	Handle kit	124660	36.80	Chrome	Spout hub kit
122563ORB	158.15	Oil Rubbed Bronze	Handle kit	124660SRS	54.55	Spot Resist Stainless	Spout hub kit
122564	123.75	Chrome	Handle kit	124661	30.00	N/A or Unfinished	Hardware kit
122564BN	179.30	Brushed Nickel	Handle kit	124662	68.80	N/A or Unfinished	Hose kit
122564ORB	197.20	Oil Rubbed Bronze	Handle kit	124663	95.85	Chrome	Spout receptor kit
122566	14.05	N/A or Unfinished	Handle adapter kit	124663ORB	162.15	Oil Rubbed Bronze	Spout receptor kit
122569	14.70	N/A or Unfinished	Screw kit	124663W	134.15	Glacier	Spout receptor kit
122570	7.85	N/A or Unfinished	Hardware kit	124664	88.90	Chrome	Wand kit
122576	26.00	Chrome	Diverter kit	124664CSL	146.15	Classic Stainless	WAND KIT, 7545 CSL
122576BN	37.65	Brushed Nickel	Diverter kit	124664ORB	156.05	Oil Rubbed Bronze	Wand kit
123227	7.05	N/A or Unfinished	Gasket	124664SL	141.90	Stainless	Wand kit
123244	38.70	Chrome	Deck plate	124664W	129.15	Glacier	Wand kit
123244ORB	60.25	Oil Rubbed Bronze	Escutcheon & gasket kit	124665	8.35	N/A or Unfinished	Bearing washer kit
123244SL	54.80	Stainless	Deck plate	124737	34.70	Chrome	Handle kit
123244V	46.70	Ivory	Deck plate	124737SL	53.60	Stainless	Handle kit
123244W	56.30	Glacier	Deck plate	124737W	48.60	Glacier	Handle kit
123245	46.30	Chrome	Escutcheon & gasket kit	124738	77.95	Chrome	Wand kit
123245ORB	73.85	Oil Rubbed Bronze	Escutcheon	124738CSL	54.25	Classic Stainless	Wand kit
123246	4.85	Chrome	Hardware kit	124738SL	119.85	Stainless	Wand kit
123247	88.30	Chrome	Spout kit	124738W	109.00	Glacier	Wand kit
123247CSL	128.10	Classic Stainless	Spout kit	124823	60.60	Chrome	Spout receptor kit
123247ORB	140.90	Oil Rubbed Bronze	Spout kit	124823SL	93.40	Stainless	Spout receptor kit
123247SRS	128.10	Spot Resist Stainless	Spout kit	124823W	84.95	Glacier	Spout receptor kit
123249	29.55	Chrome	Handle kit	124854	29.75	Chrome	Handle kit
123249ORB	47.05	Oil Rubbed Bronze	Handle kit	125752	33.90	Chrome	Grid drain cover
123249W	56.30	Glacier	Handle kit	125752BN	51.70	Brushed Nickel	Grid drain cover
123250	11.20	Chrome	Dome	125752P	74.85	Polished Brass	Grid drain cover
123250ORB	41.90	Oil Rubbed Bronze	Dome	125754	39.55	Chrome	Handle kit
123250W	15.50	Glacier	Dome	125754BN	62.70	Brushed Nickel	Handle kit
123340	36.80	Chrome	Hot handle kit	125754ORB	68.90	Oil Rubbed Bronze	Handle kit
123340SL	56.90	Stainless	Hot handle kit	125755	52.85	Chrome	Shower escutcheon
123342	7.10	N/A or Unfinished	Gasket	125755BN	83.90	Brushed Nickel	Shower escutcheon
123346BN	37.05	Brushed Nickel	Handshower escutcheon	125755ORB	92.35	Oil Rubbed Bronze	Shower escutcheon
123346ORB	40.80	Oil Rubbed Bronze	Handshower escutcheon	125756	83.05	Chrome	Handle kit
123349	40.35	Chrome	Escutcheon	125756BN	128.90	Brushed Nickel	Handle kit
123349BN	54.90	Brushed Nickel	Escutcheon	125756ORB	141.75	Oil Rubbed Bronze	Handle kit
123349ORB	60.30	Oil Rubbed Bronze	Escutcheon	125756SRS	124.55	Spot Resist Stainless	Handle kit
123351	88.75	Chrome	Handle kit	125757BN	28.85	Brushed Nickel	Lift rod kit
123351BN	125.40	Brushed Nickel	Handle kit	125757ORB	31.70	Oil Rubbed Bronze	Lift rod kit
123351ORB	138.00	Oil Rubbed Bronze	Handle kit	125758	17.25	Chrome	Spout cap
123352	92.55	Chrome	Escutcheon	125758BN	29.60	Brushed Nickel	Spout cap
123352BN	134.30	Brushed Nickel	Escutcheon	125758ORB	32.55	Oil Rubbed Bronze	Spout cap
123352ORB	147.80	Oil Rubbed Bronze	Escutcheon	125759	122.35	Chrome	Spout kit
123353	61.30	N/A or Unfinished	Hardware kit	125759BN	189.50	Brushed Nickel	Spout kit
123353BN	88.90	Brushed Nickel	Hardware kit	125759ORB	208.50	Oil Rubbed Bronze	Spout kit
123353ORB	97.80	Oil Rubbed Bronze	Hardware kit	125760BN	365.95	Brushed Nickel	Roman tub spout kit
123354ORB	115.20	Oil Rubbed Bronze	Handshower bracket	125760ORB	402.50	Oil Rubbed Bronze	Roman tub spout kit
123355	96.50	Chrome	Handle kit	125761	12.15	Chrome	Diverter rod kit
123355BN	139.90	Brushed Nickel	Handle kit	125761BN	18.30	Brushed Nickel	Diverter rod kit
123663	7.35	N/A or Unfinished	Gasket				
123799	11.80	Chrome	Handle cap kit				

Moen Genuine Parts

Listed in numerical order

Part Number	List Price	Finish	Description	Part Number	List Price	Finish	Description
125761ORB	20.05	Oil Rubbed Bronze	Diverter rod kit	128873BN	45.80	Brushed Nickel	Lift rod kit
125762	45.15	Chrome	Spout cap kit	128873ORB	50.40	Oil Rubbed Bronze	Lift rod kit
125762BN	70.05	Brushed Nickel	Spout cap kit	128876	56.55	Chrome	Handle kit
125762ORB	77.05	Oil Rubbed Bronze	Spout cap kit	128876BN	90.30	Brushed Nickel	Handle kit
125763BN	365.50	Brushed Nickel	Roman tub diverter spout	128877	56.55	Chrome	Handle kit
125763ORB	402.10	Oil Rubbed Bronze	Roman tub diverter spout	128877BN	90.30	Brushed Nickel	Handle kit
125765SRS	97.55	Spot Resist Stainless	Cold handle kit	128878	17.30	Chrome	Aerator kit
125766	16.35	Chrome	Lift rod kit	128879	112.40	Chrome	Spout kit
125766BN	25.20	Brushed Nickel	Lift rod kit	128879BN	179.45	Brushed Nickel	Spout kit
125766ORB	27.75	Oil Rubbed Bronze	Lift rod kit	128880	63.60	Chrome	Handle kit
125795	25.20	Chrome	Handle kit	128880BN	94.30	Brushed Nickel	Handle kit
125796	10.00	N/A or Unfinished	installation tool	128881	41.25	Chrome	Escutcheon
125857	89.75	Chrome	Spout receptor kit	128881BN	63.70	Brushed Nickel	Escutcheon
125979	35.25	N/A or Unfinished	Hot/cold indicator kit	128882	39.75	Chrome	Handle kit
125989	15.10	N/A or Unfinished	Hose weight	128882BN	61.30	Brushed Nickel	Handle kit
125999	5.90	N/A or Unfinished	Hot/cold indicator kit	128883	160.10	Chrome	Roman tub spout kit
126956	17.10	Chrome	Hose guide	128883BN	232.10	Brushed Nickel	Roman tub spout kit
126964	10.90	Chrome	Dome kit	128884	19.00	Chrome	Stream straightener
126964BC	37.25	Brushed Chrome	Dome kit	128885	16.45	Chrome	Lift rod kit
126964V	42.40	Ivory	Dome kit	128885BN	24.30	Brushed Nickel	Lift rod kit
126964W	41.90	Glacier	Dome kit	128886	212.90	Chrome	Roman tub diverter spout
126970	80.05	Chrome	Spout kit	128886BN	308.65	Brushed Nickel	Roman tub diverter spout
126971	33.00	Chrome	Handle kit	129102	35.95	Chrome	Escutcheon
126971BC	41.20	Brushed Chrome	Handle kit	129102BN	53.10	Brushed Nickel	Escutcheon
126971V	46.80	Ivory	Handle kit	129102NL	53.10	Polished Nickel	Escutcheon
126971W	46.35	Glacier	Handle kit	129102ORB	58.40	Oil Rubbed Bronze	Escutcheon
127683	40.25	N/A or Unfinished	Filter manifold kit	129102WR	58.40	Wrought Iron	Escutcheon
127685	46.50	N/A or Unfinished	Hardware kit	129665	10.65	N/A or Unfinished	Handle kit
127686	7.05	N/A or Unfinished	Screw kit	129666	20.90	N/A or Unfinished	Sillcock service kit
127688	14.55	N/A or Unfinished	Spout nut kit	129704	24.90	N/A or Unfinished	Hot/cold indicator kit
127689	13.20	N/A or Unfinished	O-ring kit	129706	24.90	N/A or Unfinished	Hot/cold indicator kit
127690	6.70	N/A or Unfinished	Aerator kit	129707	23.95	N/A or Unfinished	Hot/cold indicator kit
127691	13.55	N/A or Unfinished	Diverter kit	129709	35.90	Chrome	Handle kit
127695	92.90	Chrome	Spout kit	129797	26.00	N/A or Unfinished	Stem extension kit
127745	30.00	Chrome	Spout tip and escutcheon with	129807	72.25	Chrome	Handle escutcheon
127745CSL	46.25	Classic Stainless	Spout escutcheon	129807BN	111.15	Brushed Nickel	Handle escutcheon
127745ORB	50.90	Oil Rubbed Bronze	Spout tip and escutcheon with	129808	54.40	Chrome	Escutcheon
127745W	42.10	Glacier	Spout tip and escutcheon with	129808BN	83.65	Brushed Nickel	Escutcheon
127746	82.05	Chrome	Handle hub kit	129819	20.55	N/A or Unfinished	Hot/cold indicator kit
127746CSL	119.00	Classic Stainless	Handle hub kit	129820BN	46.75	Brushed Nickel	Lift rod kit
127746ORB	130.85	Oil Rubbed Bronze	Handle hub kit	129825BN	72.65	Brushed Nickel	Lift rod kit
128865	21.05	Chrome	Lift rod kit	129826BN	171.10	Brushed Nickel	Spout kit
128865BN	32.50	Brushed Nickel	Lift rod kit	129827	33.10	Chrome	Lift rod kit
128865ORB	35.85	Oil Rubbed Bronze	Lift rod kit	129827BN	50.95	Brushed Nickel	Lift rod kit
128866	50.50	Chrome	Handle kit	129828BN	44.80	Brushed Nickel	Diverter spout cap
128866BN	77.50	Brushed Nickel	Handle kit	129829	337.90	Chrome	Roman tub spout kit
128866ORB	85.25	Oil Rubbed Bronze	Handle kit	129830	339.05	Chrome	Roman tub spout kit
128867	51.65	Chrome	Handle kit	129831	5.70	N/A or Unfinished	Bearing washer kit
128867BN	79.15	Brushed Nickel	Handle kit	129905	14.15	Chrome	Plug button kit
128867ORB	87.25	Oil Rubbed Bronze	Handle kit	129905CSL	19.60	Classic Stainless	Plug button kit
128868	51.65	Chrome	Handle kit	129905ORB	21.65	Oil Rubbed Bronze	Plug button kit
128868BN	79.15	Brushed Nickel	Handle kit	129905SL	19.60	Stainless	Plug button kit
128868ORB	87.25	Oil Rubbed Bronze	Handle kit	129907	56.00	Chrome	Spout receptor kit
128869	7.05	N/A or Unfinished	Gasket	129908	46.90	Chrome	Wand kit
128870	48.15	Chrome	Escutcheon	129921	22.10	Chrome	Handle kit hot
128870BN	71.30	Brushed Nickel	Escutcheon	129953	61.80	Chrome	Shower escutcheon
128870ORB	78.50	Oil Rubbed Bronze	Escutcheon	129953BN	66.80	Brushed Nickel	Escutcheon
128871	46.90	Chrome	Handle kit	129954BN	58.35	Brushed Nickel	Handle hub
128871BN	72.40	Brushed Nickel	Handle kit	129957BN	622.60	Brushed Nickel	Roman tub spout kit
128871ORB	79.70	Oil Rubbed Bronze	Handle kit	129958BN	43.85	Brushed Nickel	Lift rod kit
128873	30.80	Chrome	Lift rod kit	129960	61.80	Chrome	Shower escutcheon
				129960BN	65.90	Brushed Nickel	Escutcheon
				130120ORB	29.95	Oil Rubbed Bronze	Spout cap kit
				130120SRS	25.35	Spot Resist Stainless	Cap kit

Moen Genuine Parts

Listed in numerical order

Part Number	List Price	Finish	Description	Part Number	List Price	Finish	Description
130142	20.30	N/A or Unfinished	Handle adapter kit	130976SL	22.25	Stainless	Handle cap kit
130143	67.85	N/A or Unfinished	Extension kit	130998	123.10	Chrome	Spout kit
130147	7.80	Chrome	Temperature override kit	130998BN	189.50	Brushed Nickel	Spout kit
130147BN	12.60	Brushed Nickel	Temperature override kit	131092	29.95	Chrome	Lift rod kit
130147NL	13.05	Polished Nickel	Temperature override kit	131092BN	46.05	Brushed Nickel	Lift rod kit
130147ORB	13.90	Oil Rubbed Bronze	Temperature override kit	131097	61.80	Chrome	Handle kit
130147WR	13.90	Wrought Iron	Temperature override kit	131097BN	89.80	Brushed Nickel	Handle kit
130148	46.80	Chrome	Shower escutcheon	131097ORB	98.75	Oil Rubbed Bronze	Handle kit
130148BN	100.60	Brushed Nickel	Escutcheon	131098	61.80	Chrome	Handle kit
130148ORB	110.65	Bronze - Oil Rubbed	Escutcheon	131098BN	89.80	Brushed Nickel	Handle kit
130148WR	110.65	Wrought Iron	Shower escutcheon	131098ORB	98.75	Oil Rubbed Bronze	Handle kit
130149	102.45	Chrome	Handle kit	131099	5.85	Chrome	Handle cap kit
130149BN	157.80	Brushed Nickel	Handle kit	131099BN	8.55	Brushed Nickel	Handle cap kit
130149NL	78.50	Polished Nickel	Handle kit	131099ORB	9.45	Oil Rubbed Bronze	Handle cap kit
130149ORB	173.55	Oil Rubbed Bronze	Handle kit	131100	16.45	Chrome	Lift rod kit
130149WR	173.55	Wrought Iron	Handle kit	131100BN	23.75	Brushed Nickel	Lift rod kit
130150	22.20	Chrome	Handle cap kit	131100NL	52.85	Polished Nickel	Lift rod kit
130150BN	32.80	Brushed Nickel	Handle cap kit	131100ORB	26.10	Oil Rubbed Bronze	Lift rod kit
130150NL	33.95	Polished Nickel	Handle cap kit	131101	71.25	Chrome	Handle kit
130150ORB	36.15	Bronze - Oil Rubbed	Handle cap kit	131101BN	103.50	Brushed Nickel	Handle kit
130150WR	36.15	Wrought Iron	Handle cap kit	131101ORB	113.75	Oil Rubbed Bronze	Handle kit
130151	103.55	Chrome	Handle kit	131104	181.95	Chrome	Roman tub spout kit
130151BN	159.50	Brushed Nickel	Handle kit	131107	20.35	Chrome	Lift rod kit
130151NL	78.50	Polished Nickel	Handle kit	131107BN	29.55	Brushed Nickel	Lift rod kit
130151ORB	175.45	Oil Rubbed Bronze	Handle kit	131107ORB	32.45	Oil Rubbed Bronze	Lift rod kit
130151WR	175.45	Wrought Iron	Handle kit	131108	36.70	Chrome	Shower escutcheon
130152	24.40	Chrome	Handle escutcheon	131108BN	53.25	Brushed Nickel	Shower escutcheon
130152BN	48.95	Brushed Nickel	Handle escutcheon	131108ORB	58.50	Oil Rubbed Bronze	Shower escutcheon
130152NL	41.00	Polished Nickel	Escutcheon	131109	55.35	Chrome	Handle kit
130152ORB	53.80	Bronze - Oil Rubbed	Handle escutcheon	131109BN	80.30	Brushed Nickel	Handle kit
130152WR	53.80	Wrought Iron	Handle escutcheon	131109ORB	88.35	Oil Rubbed Bronze	Handle kit
130153	35.75	Chrome	Handle escutcheon	131120	14.00	Chrome	Dome kit
130153BN	54.95	Brushed Nickel	Handle escutcheon	131121	18.30	Chrome	Escutcheon
130153NL	60.00	Polished Nickel	Handle escutcheon	131164	19.60	Chrome	Escutcheon
130153ORB	60.40	Bronze - Oil Rubbed	Handle escutcheon	131166	11.70	Chrome	Aerator kit
130155	23.20	Chrome	Extension kit	131185	57.55	Chrome	Wall escutcheon and gasket
130156	223.80	N/A or Unfinished	Cartridge repair kit	131185BN	85.40	Brushed Nickel	Wall escutcheon and gasket
130183	38.85	Chrome	Spout kit	131186	69.50	Chrome	Wall escutcheon and gasket
130183CSL	65.90	Classic Stainless	Spout kit	131186BN	106.95	Brushed Nickel	Wall escutcheon and gasket
130183ORB	72.50	Oil Rubbed Bronze	Spout kit	131187	57.90	Chrome	Wall escutcheon and gasket
130183W	59.90	Glacier	Spout kit	131187BN	89.25	Brushed Nickel	Wall escutcheon and gasket
130525	76.10	Chrome	Handle hub kit	131187NL	89.25	Polished Nickel	Wall escutcheon and gasket
130525P	125.05	Polished Brass	Handle hub kit	131187ORB	98.20	Oil Rubbed Bronze	Wall escutcheon and gasket
130526	76.10	Chrome	Handle hub kit	131187WR	98.20	Wrought Iron	Wall escutcheon and gasket
130526P	125.05	Polished Brass	Handle hub kit	131191	122.70	Chrome	Handle kit
130965	46.80	Chrome	Handle hub kit	131191BN	188.95	Brushed Nickel	Handle kit
130965ORB	91.35	Oil Rubbed Bronze	Handle hub	131191NL	188.95	Polished Nickel	Handle kit
130965SRS	56.40	Spot Resist Stainless	Handle hub kit	131191ORB	207.75	Oil Rubbed Bronze	Handle kit
130966	11.45	Chrome	Hinge pin caps	131191WR	207.75	Wrought Iron	Handle kit
130966CSL	10.45	Classic Stainless	Hinge cap kit	131195	123.85	Chrome	Handle kit
130966ORB	11.50	Oil Rubbed Bronze	Hinge pin caps	131195BN	190.50	Brushed Nickel	Handle kit
130966SRS	12.50	Spot Resist Stainless	Hinge cap kit	131195NL	190.50	Polished Nickel	Handle kit
130967	23.45	Chrome	Hinge pin assembly	131195ORB	209.55	Oil Rubbed Bronze	Handle kit
130968	38.50	Chrome	Escutcheon & gasket kit	131195WR	209.55	Wrought Iron	Handle kit
130968ORB	41.95	Oil Rubbed Bronze	Wall escutcheon and gasket	131380	82.20	Chrome	Wand kit
130968SRS	51.30	Spot Resist Stainless	Escutcheon	131380BL	81.00	Matte Black	Wand kit
130969	27.20	Chrome	Hardware kit	131380CSL	99.40	Classic Stainless	Wand kit
130970	21.40	Chrome	Aerator kit	131380ORB	102.15	Oil Rubbed Bronze	Wand kit
130970CSL	21.05	Classic Stainless	Aerator kit				
130970ORB	23.25	Oil Rubbed Bronze	Stream straightener				
130970SRS	21.30	Spot Resist Stainless	Stream straightener kit				
130976	7.75	Chrome	Handle cap kit				
130976CSL	22.25	Classic Stainless	Handle cap kit				
130976ORB	45.05	Oil Rubbed Bronze	Handle cap kit				

Moen Genuine Parts

Listed in numerical order

Part Number	List Price	Finish	Description	Part Number	List Price	Finish	Description
131380SL	96.60	Stainless	Wand kit	134743SL	73.10	Stainless	Spout kit
131381	47.20	Chrome	Hose kit	134938	52.75	Chrome	Handle kit
131383	63.55	Chrome	Deck plate	134938BN	71.75	Brushed Nickel	Handle kit
131383BL	70.55	Matte Black	Deck plate	134938ORB	81.95	Oil Rubbed Bronze	Handle kit
131383SL	82.75	Stainless	Deck plate	135149	83.45	Chrome	Escutcheon
131384	17.25	Chrome	Wand kit	135149BN	117.15	Brushed Nickel	Escutcheon
131384BL	12.15	Matte Black	Wand kit	135149ORB	139.40	Oil Rubbed Bronze	Escutcheon
131384SL	27.50	Stainless	Wand kit	135149P	100.60	Polished Brass	Escutcheon
131386SL	155.30	Stainless	Wand kit	135149WR	139.40	Wrought Iron	Escutcheon
131553	66.75	Chrome	id	135150	28.60	Chrome	Handle kit
131553BN	99.95	Brushed Nickel	Pop-up waste kit	135150BN	46.50	Brushed Nickel	Handle kit
131553NL	99.95	Polished Nickel	Pop-up waste kit	135150ORB	51.15	Oil Rubbed Bronze	Handle kit
131553ORB	112.45	Oil Rubbed Bronze	Pop-up waste kit	135150P	51.15	Polished Brass	Handle kit
132152	9.00	N/A or Unfinished	Spout tube	135150WR	51.15	Wrought Iron	Handle kit
132448	14.25	Chrome	Stop tube kit	135151	9.10	Chrome	Stop tube kit
132448BN	18.80	Brushed Nickel	Stop tube kit	135151BN	13.35	Brushed Nickel	Stop tube kit
132448P	21.70	Polished Brass	Stop tube kit	135151P	16.30	Polished Brass	Stop tube kit
132448WR	20.55	Wrought Iron	Stop tube kit	135151WR	14.60	Wrought Iron	Stop tube kit
132452	12.60	Chrome	Spacer kit	135152	4.75	N/A or Unfinished	Spacer kit
132596	37.35	N/A or Unfinished	Hose kit	135153	43.95	Chrome	Escutcheon
132597	21.00	N/A or Unfinished	Hardware kit	135153BN	58.55	Brushed Nickel	Escutcheon
133436	8.95	N/A or Unfinished	Bushing	135167	49.70	Chrome	Handle extension kit
133437	60.00	Chrome	Escutcheon	135167BN	90.70	Brushed Nickel	Handle extension kit
133437BN	81.95	Brushed Nickel	Escutcheon	135167P	71.35	Polished Brass	Handle extension kit
133437ORB	90.20	Oil Rubbed Bronze	Escutcheon	135167WR	99.95	Wrought Iron	Handle extension kit
133481	18.35	Chrome	Lift rod kit	136101	24.80	N/A or Unfinished	Adapter kit
133481BN	24.15	Brushed Nickel	Lift rod kit	136102	12.20	N/A or Unfinished	Hydrolock® Hose Spray Kit
133482	18.55	Chrome	Escutcheon	136103	38.20	Black	Hose & spray
133482BN	25.00	Brushed Nickel	Escutcheon	136103BL	52.85	Matte Black	Hose & spray
133483	38.10	Chrome	Deck plate	136103C	38.20	Chrome	Hose & spray
133483BN	55.05	Brushed Nickel	Deck plate	136103CP	56.20	Chrome	Hose & spray
133484	7.80	Chrome	Plug button kit	136103ORB	88.60	Oil Rubbed Bronze	Hose & spray
133484BN	10.40	Brushed Nickel	Plug button kit	136103SL	52.85	Stainless	Hose & spray
133486	11.70	Chrome	Plug button kit	136103SLP	52.85	Brushed Platinum	Hose & spray
133486BN	13.55	Brushed Nickel	Plug button kit	136103V	38.20	Ivory	Hose & spray
134120	24.70	Chrome	Lift rod kit	136103W	38.20	Glacier	Hose & spray
134122	472.50	Chrome	infrared sensor control box	136104	74.25	Chrome	Hose & spray
134309	140.10	Chrome	Spout kit	136104CSL	126.85	Classic Stainless	Hose & spray
134309BN	203.05	Brushed Nickel	Spout kit	136104ORB	139.55	Oil Rubbed Bronze	Hose & spray
134309ORB	215.75	Oil Rubbed Bronze	Spout kit	136104SRS	215.20	Spot Resist Stainless	Hose & spray
134309P	169.10	Polished Brass	Spout kit	136104WR	139.55	Wrought Iron	Hose & spray
134310	130.95	Chrome	Spout kit	136105SL	136.55	Stainless	Hose & spray
134310BN	189.90	Brushed Nickel	Spout kit	136106	76.50	Chrome	Hose & spray
134402	71.95	Chrome	Handle kit	136106CSL	76.50	Classic Stainless	Side spray kit
134402BN	117.80	Brushed Nickel	Handle kit	136106ORB	92.50	Oil Rubbed Bronze	Hose & spray
134404	26.15	Chrome	Lift rod kit	136106SL	76.50	Stainless	Hose & spray
134404BN	63.00	Brushed Nickel	Lift rod kit	136106SRS	76.50	Spot Resist Stainless	Hose & spray
134404NL	63.00	Polished Nickel	Lift rod kit	136109	41.00	Black	Hose & spray
134404ORB	63.00	Oil Rubbed Bronze	Lift rod kit	136123	24.90	N/A or Unfinished	Hardware kit
134404P	63.00	Polished Brass	Lift rod kit	136195	11.50	Chrome	Escutcheon screws
134404WR	63.00	Wrought Iron	Lift rod kit	136195BN	16.70	Brushed Nickel	Escutcheon screws
134413	33.75	Chrome	Handle escutcheon	136195NL	17.65	Polished Nickel	Escutcheon screws
134413CSL	51.80	Classic Stainless	Handle escutcheon	136195P	17.65	Polished Brass	Escutcheon screws
134413SL	52.45	Stainless	Handle escutcheon	136195WR	17.65	Wrought Iron	Escutcheon screws
134418CSL	58.45	Classic Stainless	Spout escutcheon	136196	36.60	Chrome	Handle adapter kit
134418SL	58.45	Stainless	Escutcheon	136196BN	48.30	Brushed Nickel	Handle adapter kit
134742	89.55	Chrome	Wand kit	136197	6.35	Chrome	Plug button kit
134742CSL	111.00	Classic Stainless	Wand kit	136197BN	16.15	Brushed Nickel	Plug button kit
134742ORB	116.50	Oil Rubbed Bronze	Wand kit	136197NL	9.30	Polished Nickel	Plug button kit
134742SL	111.00	Stainless	Wand kit	136197ORB	17.65	Oil Rubbed Bronze	Plug button kit
134742SRS	107.25	Spot Resist Stainless	Wand kit	136197P	13.20	Polished Brass	Plug button kit
134743	50.50	Chrome	Spout kit	136197WR	17.65	Wrought Iron	Plug button kit
134743CSL	73.10	Classic Stainless	Spout kit	136304	7.85	N/A or Unfinished	Diverter kit
134743ORB	80.45	Oil Rubbed Bronze	Spout kit	136331	8.75	N/A or Unfinished	Spout plug

Moen Genuine Parts

Listed in numerical order

Part Number	List Price	Finish	Description	Part Number	List Price	Finish	Description
136640	46.75	Chrome	Handle kit	137398	19.25	Chrome	Escutcheon
136640BN	62.80	Brushed Nickel	Handle kit	137398BN	24.70	Brushed Nickel	Escutcheon
136640NL	70.85	Polished Nickel	Handle kit	137398ORB	27.20	Oil Rubbed Bronze	Escutcheon
136640ORB	69.15	Oil Rubbed Bronze	Handle kit	137399	27.90	Chrome	Deck plate
136640P	69.15	Polished Brass	Service kit	137399BN	38.50	Brushed Nickel	Deck plate
136640WR	69.15	Wrought Iron	Handle kit	137399ORB	42.35	Oil Rubbed Bronze	Deck plate
136829	55.00	Chrome	Pullout spout, Extensa	137401	13.30	N/A or Unfinished	Aerator
136829BL	52.65	Matte Black	Pullout spout	137402	17.00	N/A or Unfinished	Stream straightener kit
136829SL	66.35	Stainless	Pullout spout, Extensa	137403	4.70	N/A or Unfinished	Plug button kit
136829V	52.65	Ivory	Pullout spout	137404	4.70	N/A or Unfinished	Plug button kit
136829WG	52.65	Glacier	Pullout spout	137481	17.35	Chrome	Escutcheon
137001	10.45	N/A or Unfinished	Collar	137488	7.65	Chrome	Shower arm flange
137028	43.95	N/A or Unfinished	Hose kit	137488BL	7.55	Matte Black	Shower arm flange
137034	20.45	Chrome	Slider for slide bar	137488BN	19.95	Brushed Nickel	Shower arm flange
137034BN	53.85	Brushed Nickel	Slider for slide bar	137510	19.25	N/A or Unfinished	Handle kit
137034NL	53.85	Polished Nickel	Slider for slide bar	137510BN	53.15	Brushed Nickel	Handle kit
137034ORB	59.25	Oil Rubbed Bronze	Slider for slide bar	137511	4.75	Chrome	Handle rod
137034P	59.25	Polished Brass	Slider for slide bar	137511BN	20.60	Brushed Nickel	Handle kit
137034WR	59.25	Wrought Iron	Slider for slide bar	137512	6.75	N/A or Unfinished	Dome
137035	9.65	N/A or Unfinished	Hardware kit	137512BN	16.75	Brushed Nickel	Dome kit
137114	40.80	N/A or Unfinished	Extension kit	137513	4.20	Chrome	Cartridge nut
137228	8.20	N/A or Unfinished	Hot/cold indicator kit	137514	11.30	Chrome	Aerator kit
137347	38.35	Chrome	Handle extension kit	137514BN	21.80	Brushed Nickel	Aerator kit
137347BN	62.40	Brushed Nickel	Handle extension kit	137515	1.15	Chrome	O-ring kit
137347NL	45.50	Polished Nickel	Handle extension kit	137516	9.80	Chrome	Escutcheon
137347P	61.10	Polished Brass	Handle extension kit	137516BN	21.50	Brushed Nickel	Escutcheon
137347WR	68.65	Wrought Iron	Handle extension kit	137517	3.75	Chrome	Hardware kit
137386	60.95	Chrome	Handle kit	137518	5.00	Chrome	Hardware kit
137386BN	88.35	Brushed Nickel	Handle kit	137520	7.25	Chrome	Aerator kit
137386ORB	97.20	Oil Rubbed Bronze	Handle kit	137521	63.45	Chrome	Spout kit
137387	60.95	Chrome	Handle kit	137522	1.30	Chrome	Spout retainer kit
137387BN	88.35	Brushed Nickel	Handle kit	137523	11.85	Chrome	Spout nut kit
137387ORB	97.20	Oil Rubbed Bronze	Handle kit	137524	174.50	Chrome	Spout kit
137388	67.05	Chrome	Handle kit	137524BN	322.45	Brushed Nickel	Roman tub spout kit
137388BN	97.25	Brushed Nickel	Handle kit	137525	14.65	Chrome	Spout cap
137388ORB	106.95	Oil Rubbed Bronze	Handle kit	137526	3.90	Chrome	Flow restrictor kit
137389	31.10	Chrome	Lift rod kit	137526BN	9.10	Brushed Nickel	Aerator kit
137389BN	45.05	Brushed Nickel	Lift rod kit	137527	36.55	Chrome	Handle kit
137389ORB	49.60	Oil Rubbed Bronze	Lift rod kit	137527BN	97.00	Brushed Nickel	Handle kit
137390	147.05	Chrome	Spout kit	137528	1.55	Chrome	Plug button kit
137390BN	218.05	Brushed Nickel	Spout kit	137528BN	3.20	Brushed Nickel	Plug button kit
137390ORB	239.85	Oil Rubbed Bronze	Spout kit	137530	1.10	Chrome	Hot/cold indicator kit
137391	199.55	Chrome	Roman tub spout kit	137532	10.75	Chrome	Escutcheon
137391BN	289.35	Brushed Nickel	Roman tub spout kit	137533	15.00	Chrome	Lift rod kit
137391ORB	307.25	Bronze - Oil Rubbed	Spout kit	137533BN	32.75	Brushed Nickel	Lift rod kit
137392	206.25	Chrome	Roman tub diverter spout	137534	13.20	Chrome	Spout cap kit
137392BN	298.90	Brushed Nickel	Roman tub diverter spout	137534BN	26.60	Brushed Nickel	Spout cap kit
137392ORB	328.80	Oil Rubbed Bronze	Roman tub diverter spout	137536	20.05	Chrome	Handle kit
137393	21.85	Chrome	Diverter rod kit	137536BN	54.65	Brushed Nickel	Handle kit
137393BN	31.75	Brushed Nickel	Diverter rod kit	137537	4.75	Chrome	Handle rod
137393ORB	34.95	Oil Rubbed Bronze	Diverter rod kit	137537BN	20.90	Brushed Nickel	Handle rod
137394	62.65	Chrome	Escutcheon	137538	1.30	Chrome	Plug button kit
137394BN	90.70	Brushed Nickel	Escutcheon	137538BN	8.55	Brushed Nickel	Plug button kit
137394ORB	99.95	Oil Rubbed Bronze	Escutcheon	137540	43.95	Chrome	Escutcheon
137395	67.65	Chrome	Shower escutcheon	137540BN	63.05	Brushed Nickel	Escutcheon
137395BN	98.05	Brushed Nickel	Shower escutcheon	137541	10.35	Chrome	Aerator kit
137395ORB	107.85	Oil Rubbed Bronze	Shower escutcheon	137543	5.30	Chrome	Spout cap
137396	47.20	Chrome	Handle kit	137543BN	11.70	Brushed Nickel	Spout cap
137396BN	68.50	Brushed Nickel	Handle kit	137544	36.85	Chrome	Handle kit
137396ORB	75.35	Oil Rubbed Bronze	Handle kit	137544BN	98.10	Brushed Nickel	Handle kit
137397	27.75	Chrome	Handle kit	137545	13.30	Chrome	Lift rod kit
137397BN	38.50	Brushed Nickel	Handle kit	137545BN	27.85	Brushed Nickel	Lift rod kit
137397ORB	42.35	Oil Rubbed Bronze	Handle kit	138765	16.30	N/A or Unfinished	Hardware kit
				139071	7.20	N/A or Unfinished	Hardware kit

Moen Genuine Parts

Listed in numerical order

Part Number	List Price	Finish	Description	Part Number	List Price	Finish	Description
139221	14.15	N/A or Unfinished	Liquid soap/lotion dispenser pump only	140777	6.90	N/A or Unfinished	Flow restrictor kit
139260	2.85	N/A or Unfinished	Mounting kit	140779	6.90	N/A or Unfinished	Flow restrictor kit
139280	6.35	N/A or Unfinished	Template kit	140780	59.20	Chrome	Lavatory drain assembly
139760	103.00	Chrome	Handle kit	140780BN	82.60	Brushed Nickel	Lavatory drain assembly
139760BN	199.30	Brushed Nickel	Handle kit	140780NL	81.90	Polished Nickel	Lavatory drain assembly
139762	27.50	Chrome	Lift rod kit	140780ORB	93.30	Oil Rubbed Bronze	Lavatory drain assembly
139762BN	55.00	Brushed Nickel	Lift rod kit	140780P	114.00	Polished Brass	Waste assembly
139763	13.70	Chrome	Hot/cold indicator kit	140860	15.60	N/A or Unfinished	Deck gasket
139765BN	238.00	Brushed Nickel	Spout kit	140899	6.75	N/A or Unfinished	Siding wedge
139766	349.10	Chrome	Roman tub spout kit	140900	9.70	N/A or Unfinished	Vacuum breaker kit
139766BN	506.15	Brushed Nickel	Roman tub spout kit	140901	6.25	N/A or Unfinished	Hot/cold indicator kit
139767	34.35	Chrome	Lift rod kit	140902	6.45	N/A or Unfinished	Temperature limit stop kit
139767BN	68.70	Brushed Nickel	Lift rod kit	140903	15.65	N/A or Unfinished	Handle kit
139769	34.35	Chrome	Handle adapter kit	140904	12.50	N/A or Unfinished	Retainer nut
139772	68.70	Chrome	Handle kit	140994	90.20	Chrome	Spout kit
139772BN	123.80	Brushed Nickel	Handle kit	140994CSL	130.05	Classic Stainless	Spout kit
139773	69.80	Chrome	Handle kit	140995	60.90	Chrome	Wand kit
139773BN	101.05	Brushed Nickel	Handle kit	140995CSL	69.85	Classic Stainless	Wand kit
139774	70.85	Chrome	Handle kit	140996CSL	36.45	Classic Stainless	Handle kit
139774BN	102.60	Brushed Nickel	Handle kit	140997	11.55	Chrome	Dome kit
139885	74.20	Chrome	Handle kit	140997BL	99.15	Matte Black	Spout kit
139885BN	104.95	Brushed Nickel	Handle kit	140997CSL	16.45	Classic Stainless	Dome kit
139885ORB	115.35	Oil Rubbed Bronze	Handle kit	140997ORB	23.80	Oil Rubbed Bronze	Dome kit
139885P	111.40	Polished Brass	Handle kit	140998	11.30	Chrome	Cartridge nut
139885WR	115.35	Wrought Iron	Handle kit	140999	5.80	Chrome	Gasket kit
139968	54.70	N/A or Unfinished	Hardware kit	141002	47.95	Chrome	Escutcheon
140028	27.30	Chrome	Service kit	141002BL	55.05	Matte Black	Escutcheon
140244	68.70	Chrome	Wand kit	141002CSL	59.55	Classic Stainless	Escutcheon
140244BL	123.80	Matte Black	Wand kit	141002NL	52.20	Polished Nickel	Escutcheon
140245	68.70	Chrome	Wand kit	141002ORB	60.65	Oil Rubbed Bronze	Escutcheon
140245BL	123.80	Matte Black	Wand kit	141002SRS	55.05	Spot Resist Stainless	Escutcheon
140245SRS	55.80	Spot Resist Stainless	Wand kit	141003	13.90	N/A or Unfinished	installation tool
140246	61.80	Chrome	Wand kit	141005	72.65	Chrome	Spout kit
140247	123.80	Chrome	Spout kit	141005CSL	101.25	Classic Stainless	Spout kit
140249BL	192.45	Matte Black	Spout kit	141006	35.25	Chrome	Hose & spray
140251	13.70	Chrome	Gasket kit	141006CSL	58.35	Classic Stainless	Hose & spray
140325	33.75	N/A or Unfinished	Shank kit	141007	12.40	Chrome	Hose guide
140379	76.85	Chrome	Wand kit	141007CSL	15.00	Classic Stainless	Hose guide
140379CSL	104.55	Classic Stainless	Wand kit	141007SRS	18.00	Spot Resist Stainless	Hose guide
140379W	68.20	Glacier	Wand kit	141008	20.10	Chrome	Aerator kit
140392	76.30	Chrome	Wand Kit	141008CSL	22.70	Classic Stainless	Aerator kit
140392BL	68.20	Matte Black	Wand kit	141025	11.50	N/A or Unfinished	O-ring kit
140392CSL	68.20	Classic Stainless	Wand kit	141044	99.10	Chrome	Wand hose kit
140392S	68.20	Sand/Almond/Bone	Wand kit	141044ORB	152.70	Oil Rubbed Bronze	Wand hose kit
140392SL	86.20	Stainless	Wand kit	141044SL	143.70	Stainless	Wand hose kit
140392V	68.20	Ivory	Wand kit	141044V	152.70	Ivory	Wand hose kit
140392W	68.20	Glacier	Wand kit	141044W	152.70	Glacier	Wand hose kit
140676	5.50	N/A	Moen silicone grease for Posi-Temp balancing spools	141797	32.95	Chrome	Dome kit
140706	8.60	N/A or Unfinished	Hardware kit	141797BL	55.00	Matte Black	Dome kit
140708	10.35	N/A or Unfinished	Hardware kit	141797CSL	55.00	Classic Stainless	Dome kit
140709	5.70	N/A or Unfinished	Handle adapter kit	141797ORB	60.45	Oil Rubbed Bronze	Dome kit
140710	4.95	N/A or Unfinished	Cartridge nut	141797SRS	27.65	Spot Resist Stainless	Dome kit
140712	20.60	N/A or Unfinished	Shank kit	141798	50.90	Chrome	Roman tub hand shower elbow
140713	23.45	N/A or Unfinished	Hose kit	141798BN	72.40	Brushed Nickel	Handle elbows
140714	16.50	N/A or Unfinished	CPVC transition fittings (4) &	142538	5.15	N/A or Unfinished	Hardware kit
140715	10.75	N/A or Unfinished	Change to Cold expansion PEX adapters	142980	11.00	N/A or Unfinished	Stem extension kit
140716	5.40	N/A or Unfinished	O-ring kit	142981	5.65	N/A or Unfinished	Escutcheon adjuster kit
140718	5.10	N/A or Unfinished	O-ring kit	143002	9.95	N/A or Unfinished	Handle adapter kit
140719	32.95	N/A or Unfinished	Hose kit	143200	6.75	N/A or Unfinished	Gasket kit
140720	24.10	N/A or Unfinished	Hardware kit	143321	27.45	Chrome	Handle kit
140721	7.85	N/A or Unfinished	Quick-connect clips (5)	143321BN	34.20	Brushed Nickel	Handle kit
				143321ORB	42.95	Oil Rubbed Bronze	Handle kit
				143322	24.95	Chrome	Handle kit
				143322BN	34.30	Brushed Nickel	Handle kit

Moen Genuine Parts

Listed in numerical order

Part Number	List Price	Finish	Description	Part Number	List Price	Finish	Description
143322ORB	38.65	Oil Rubbed Bronze	Handle kit	146219W	51.15	Glacier	Handle kit
143323	24.60	Chrome	Escutcheon	146220	34.80	Chrome	Handle kit
143323BN	37.85	Brushed Nickel	Escutcheon	146220BL	48.95	Matte Black	Handle kit
143323ORB	41.60	Oil Rubbed Bronze	Escutcheon	146220CSL	50.70	Classic Stainless	Handle kit
143324	26.10	Chrome	Escutcheon	146220SRS	50.70	Spot Resist Stainless	Handle kit
143324BN	35.45	Brushed Nickel	Escutcheon	146220V	48.95	Ivory	Handle kit
143324ORB	39.00	Oil Rubbed Bronze	Escutcheon	146220W	48.95	Glacier	Handle kit
143325	6.00	N/A or Unfinished	Gasket	146221	70.90	Chrome	Spout receptor kit
143326	12.30	N/A or Unfinished	Aerator	146221BL	99.10	Matte Black	Spout receptor kit
143327	6.35	N/A or Unfinished	Shank kit	146221SRS	102.65	Spot Resist Stainless	Spout receptor kit
143530	8.95	N/A or Unfinished	Diverter plug	146221V	99.10	Ivory	Spout receptor kit
144266	5.45	N/A or Unfinished	Cartridge nut	146221W	99.10	Glacier	Spout receptor kit
144318	27.50	N/A or Unfinished	Hardware kit	146670	5.75	Chrome	Plug button kit
144322	61.80	N/A or Unfinished	Data cable	146670BN	12.35	Brushed Nickel	Slide bar end cap
144323	8.30	N/A or Unfinished	Template kit	146670ORB	13.60	Oil Rubbed Bronze	Plug button kit
144324	12.40	N/A or Unfinished	inlet filter kit	146670P	13.60	Polished Brass	Slide bar end cap
144325	41.20	N/A or Unfinished	inlet adapter kit	146670WR	13.60	Wrought Iron	Plug button kit
144332	34.35	N/A or Unfinished	Push fit kit	146711CSL	184.70	Classic Stainless	Spout kit
144450	17.40	Chrome	Lever handle mechanism kit	146711ORB	203.20	Oil Rubbed Bronze	Spout kit
144451	17.40	Chrome	Lever handle mechanism kit	146712	30.25	Chrome	Handle kit
144453	6.80	Chrome	Aerator kit	146712ORB	46.55	Oil Rubbed Bronze	Handle kit
144454	21.40	Chrome	Escutcheon	146712SRS	40.95	Spot Resist Stainless	Handle kit
144455	2.50	Chrome	Gasket	146778	29.90	Chrome	Escutcheon
145058	17.80	N/A or Unfinished	Adapter kit	146778BC	38.75	Brushed Chrome	Escutcheon
145665	4.85	N/A or Unfinished	Hardware kit	146778SRS	37.35	Spot Resist Stainless	Deck plate
146188	32.35	Chrome	Handle kit	146778W	41.75	Glacier	Escutcheon
146188BN	46.75	Brushed Nickel	Handle kit	146779	29.25	Chrome	Escutcheon
146188ORB	51.50	Oil Rubbed Bronze	Handle kit	146779BC	38.15	Brushed Chrome	Escutcheon
146189	27.05	Chrome	Dome	146780	39.20	Chrome	Handle kit
146189BN	39.05	Brushed Nickel	Dome	146781	26.90	Chrome	Handle kit
146189NL	41.45	Polished Nickel	Dome	146781BC	34.80	Brushed Chrome	Handle kit
146189ORB	41.45	Oil Rubbed Bronze	Dome	146781SRS	34.25	Spot Resist Stainless	Handle kit
146189WR	41.45	Wrought Iron	Dome	146781W	37.60	Glacier	Handle kit
146190	6.20	N/A or Unfinished	Mounting kit	146782	27.45	Chrome	Handle kit
146191	33.55	Chrome	Handle kit	146783	10.15	Chrome	Dome
146191BN	48.45	Brushed Nickel	Handle kit	146783BC	13.25	Brushed Chrome	Dome
146191ORB	51.70	Oil Rubbed Bronze	Handle kit	146783SRS	12.45	Spot Resist Stainless	Dome
146191P	51.70	Polished Brass	Handle kit	146783W	14.20	Glacier	Dome
146191WR	51.70	Wrought Iron	Handle kit	146784	167.50	Chrome	Spout kit
146192	33.65	Chrome	Handle kit	146784ORB	176.25	Oil Rubbed Bronze	Spout kit
146192BN	48.75	Brushed Nickel	Handle kit	146784SRS	242.85	Spot Resist Stainless	Spout kit
146194	3.75	N/A or Unfinished	Cartridge nut	146785	71.00	Chrome	Spout kit
146210	30.25	Chrome	Handle kit	146786	56.65	Chrome	Spout kit
146211	12.50	Chrome	Dome	146786BC	73.80	Brushed Chrome	Spout kit
146211BL	17.50	Matte Black	Dome	146786SRS	71.60	Spot Resist Stainless	Spout kit
146211CSL	18.05	Classic Stainless	Handle kit	146786W	79.45	Glacier	Spout kit
146211ORB	20.00	Oil Rubbed Bronze	Dome	146787	6.50	N/A or Unfinished	Bearing washer kit
146211W	17.50	Glacier	Dome	146788	32.95	Chrome	Escutcheon
146212SRS	94.80	Spot Resist Stainless	Spout receptor kit	146789	6.35	N/A or Unfinished	O-ring kit
146213	5.30	N/A or Unfinished	O-ring kit	146790	13.65	N/A or Unfinished	Mounting kit
146214	31.75	Chrome	Handle kit	146851	34.35	Chrome	Handle kit
146214ORB	50.70	Oil Rubbed Bronze	Handle kit	146851BL	55.00	Matte Black	Handle kit
146214SRS	46.15	Spot Resist Stainless	Handle kit	146851SRS	53.15	Spot Resist Stainless	Handle kit
146214W	44.45	Glacier	Handle kit	146926	5.50	N/A or Unfinished	O-ring kit
146216	37.35	Chrome	Handle kit	146927	9.85	N/A or Unfinished	Mounting kit
146216CSL	54.05	Classic Stainless	Handle kit	146928	28.65	Chrome	Handle kit
146217	12.85	Chrome	Dome	146928CSL	41.35	Classic Stainless	Handle kit
146217BL	18.00	Matte Black	Dome	146936	5.00	N/A or Unfinished	Spacer kit
146217SRS	18.85	Spot Resist Stainless	Dome	147204	25.80	Chrome	Escutcheon & gasket kit
146217V	18.00	Ivory	Dome	147204BN	62.45	Brushed Nickel	Escutcheon & gasket kit
146217W	18.00	Glacier	Dome	147206	91.50	N/A or Unfinished	Extension kit
146219	36.55	Chrome	Handle kit	147207	27.50	N/A or Unfinished	Handle adapter kit
146219BL	51.15	Matte Black	Handle kit	147208	147.05	N/A or Unfinished	Cartridge repair kit
146219CSL	53.00	Classic Stainless	Handle kit	147209	41.20	N/A or Unfinished	Check stop
				147210	34.35	N/A or Unfinished	Cartridge repair kit

Moen Genuine Parts

Listed in numerical order

Part Number	List Price	Finish	Description	Part Number	List Price	Finish	Description
147211	20.55	N/A or Unfinished	Handle adapter kit	148148NL	12.70	Polished Nickel	Dome kit
147212	34.35	N/A or Unfinished	Handle extension kit	148148ORB	12.70	Oil Rubbed Bronze	Dome kit
147213	11.00	N/A or Unfinished	Mounting kit	148149BN	24.80	Brushed Nickel	Handle kit
147539	31.95	Chrome	Escutcheon	148282	6.90	Chrome	Flow restrictor kit
147539SRS	47.60	Spot Resist Stainless	Escutcheon	148478	5.50	Chrome	Plaster ground
147540	10.15	Chrome	Plug button kit	148479	27.50	Chrome	Extension kit
147540CSL	15.60	Classic Stainless	Plug button kit	148479BN	51.50	Brushed Nickel	Extension kit
147540SRS	15.60	Spot Resist Stainless	Plug button kit	148479NL	42.70	Polished Nickel	Extension kit
147541	32.45	Chrome	Handle hub kit	148479WR	51.85	Wrought Iron	Extension kit
147541CSL	49.80	Classic Stainless	Handle hub kit	148480	27.50	Chrome	Shower escutcheon
147541SRS	48.20	Spot Resist Stainless	Handle hub kit	148480BN	34.35	Chrome	Shower escutcheon
147542	20.90	Chrome	Handle kit	148480ORB	37.85	Oil Rubbed Bronze	Shower escutcheon
147542BN	30.80	Brushed Nickel	Handle insert kit	148521	11.00	N/A or Unfinished	Support plate with gasket
147542SRS	31.10	Spot Resist Stainless	Handle kit	148606	10.35	N/A or Unfinished	CPVC transition fittings (4) &
147543	202.40	Chrome	Spout kit	148819	76.55	Chrome	Spout kit
147543SRS	301.05	Spot Resist Stainless	Spout kit	148819CSL	98.20	Classic Stainless	Spout kit
147544	11.50	N/A or Unfinished	Bearing washer kit	148819ORB	111.00	Oil Rubbed Bronze	Spout kit
147545	138.30	Chrome	Spout kit	148820	27.50	Chrome	Handle kit
147546	66.00	Chrome	Wand kit	148820BL	40.40	Matte Black	Handle kit
147546CSL	89.05	Classic Stainless	Wand kit	148820CSL	35.90	Classic Stainless	Handle kit
147548	21.25	N/A or Unfinished	Hose adapter	148820ORB	39.80	Oil Rubbed Bronze	Handle kit
147549	15.35	Chrome	Escutcheon & gasket kit	148820SRS	35.90	Spot Resist Stainless	Handle kit
147549BN	22.65	Brushed Nickel	Escutcheon	148821	5.45	N/A or Unfinished	Gasket kit
147550	16.30	Chrome	Lift rod kit	148974	3.65	Chrome	Gasket kit
147550BN	23.80	Brushed Nickel	Lift rod kit	149088	9.50	N/A or Unfinished	Diverter kit
147552	32.45	Chrome	Handle hub kit	149111	30.50	Chrome	Handle kit
147552BN	47.65	Brushed Nickel	Handle hub	149111BN	40.95	Brushed Nickel	Handle kit
147554	9.55	Chrome	Spout cap kit	149112	18.55	Chrome	Lift rod kit
147554BN	13.90	Brushed Nickel	Slot plug	149112BN	22.80	Brushed Nickel	Lift rod kit
147555	39.20	Chrome	Extension kit	149113	47.15	Chrome	Handle kit
147555BN	57.55	Brushed Nickel	Extension kit	149113BN	65.00	Brushed Nickel	Handle kit
147556	135.70	Chrome	Extension kit	149114	216.35	Chrome	Spout kit
147556BN	199.05	Brushed Nickel	Extension kit	149114BN	293.75	Brushed Nickel	Spout kit
147557	33.90	Chrome	Handle kit	149115	15.60	Chrome	Lift rod kit
147557BN	49.70	Brushed Nickel	Handle kit	149115BN	20.00	Brushed Nickel	Lift rod kit
147558	7.85	N/A or Unfinished	Plug button kit	149116	282.55	Chrome	Roman tub spout kit
147559	25.30	N/A or Unfinished	Handle adapter kit	149116BN	379.50	Brushed Nickel	Roman tub spout kit
147562	10.45	Chrome	Escutcheon	149117	13.30	Chrome	Aerator
147562BN	14.70	Brushed Nickel	Escutcheon	149118	306.20	Chrome	Roman tub spout kit
147563	11.15	Chrome	Escutcheon	149118BN	404.25	Brushed Nickel	Roman tub spout kit
147563BN	16.30	Brushed Nickel	Escutcheon	149119	21.70	Chrome	Lift rod kit
147564	24.60	Chrome	Lift rod kit	149119BN	27.10	Brushed Nickel	Lift rod kit
147564BN	36.05	Brushed Nickel	Lift rod kit	149121	5.15	N/A or Unfinished	Hot/cold indicator kit
147565	323.95	Chrome	Spout kit	149122	34.35	Chrome	Handle kit
147565BN	475.05	Brushed Nickel	Spout kit	149122BN	45.25	Brushed Nickel	Handle kit
147566	30.70	Chrome	Escutcheon	149123	56.60	Chrome	Shower escutcheon
147566BN	45.00	Brushed Nickel	Escutcheon	149123BN	75.95	Brushed Nickel	Shower escutcheon
147567	57.35	Chrome	Escutcheon	149381	8.30	N/A or Unfinished	Plaster ground
147567BN	83.90	Brushed Nickel	Escutcheon	149570	33.90	Chrome	Handle kit
147568	357.35	Chrome	Spout kit	149570CSL	49.10	Classic Stainless	Handle kit
147568BN	523.70	Brushed Nickel	Spout kit	149570SRS	69.85	Spot Resist Stainless	Handle kit
147569	42.20	Chrome	Lift rod kit	149571	38.50	Chrome	Escutcheon
147569BN	61.70	Brushed Nickel	Lift rod kit	149571SRS	67.55	Spot Resist Stainless	Escutcheon
147570	5.55	N/A or Unfinished	Bearing washer kit	149748	13.50	Chrome	Slide bar end cap
147571	25.20	N/A or Unfinished	Shank kit	149748BN	19.60	Brushed Nickel	Plug button kit
147572	11.00	Chrome	Shower arm flange	150036	22.00	Chrome	Ø
147572BN	16.10	Brushed Nickel	Shower arm flange	150040	27.65	N/A or Unfinished	Handle adapter kit
147573	30.50	Chrome	Handle kit	150041	36.10	Chrome	Handle kit
147573BN	44.80	Brushed Nickel	Handle kit	150042	27.70	Chrome	Escutcheon
147574	60.15	Chrome	Escutcheon & gasket kit	150257	39.80	N/A or Unfinished	Cartridge
147574BN	88.25	Brushed Nickel	Shower escutcheon	150259	35.00	N/A or Unfinished	Hose kit
147575	5.45	N/A or Unfinished	Set screw kit	150260	16.50	N/A or Unfinished	Hose weight
147576	63.10	Chrome	Escutcheon & gasket kit	150287CSL	129.20	Classic Stainless	Spout kit
147576BN	92.55	Brushed Nickel	Shower escutcheon	150288	199.30	Chrome	Spout kit
148148BN	11.00	Brushed Nickel	Dome				

Moen Genuine Parts

Listed in numerical order

Part Number	List Price	Finish	Description	Part Number	List Price	Finish	Description
150288CSL	255.85	Classic Stainless	Spout kit	152859P	5.85	Polished Brass	Plug button kit
150288SRS	247.20	Spot Resist Stainless	Spout kit	152859W	4.75	Glacier	Plug button kit
150313	8.95	N/A or Unfinished	3/8" Square drive tool	153206	7.80	Chrome	Dome
150625	24.70	Chrome	Handle kit	153206P	12.00	Chrome	Dome
150625BC	29.70	Brushed Chrome	Handle kit	153641	50.85	Chrome	Dome
150625BN	49.40	Brushed Nickel	Handle kit	153641CSL	73.70	Classic Stainless	Dome
150625P	38.45	Brushed Chrome	Handle kit	153641ORB	81.05	Oil Rubbed Bronze	Dome
150626	25.20	Chrome	Handle kit	153641SRS	67.80	Spot Resist Stainless	Dome
150627	28.95	N/A or Unfinished	Handle hub	153641WR	81.05	Wrought Iron	Dome
150628	7.40	Chrome	Dome	153977	45.50	Chrome	Wand kit
150628BC	9.00	Chrome	Dome	153977CSL	55.35	Chrome	Wand kit
150628BN	10.80	Brushed Nickel	Handle hub	153977ORB	85.65	Chrome	Wand kit
150628CBN	10.40	Classic Brushed Nickel	Dome	153978	29.75	Chrome	Handle kit
150628P	11.70	Chrome	Dome	153978ORB	48.25	Chrome	Handle kit
150662	27.25	Chrome	Handle kit	153978SRS	36.85	Spot Resist Stainless	Handle kit
150662ORB	43.40	Oil Rubbed Bronze	Handle kit	153982	22.70	Chrome	Aerator kit
150662SRS	36.35	Spot Resist Stainless	Handle kit	153982ORB	35.30	Old World Bronze	Aerator kit
150662WR	43.40	Wrought Iron	Handle kit	153983	4.55	Chrome	Gasket kit
150663	50.85	Chrome	Handle escutcheon	154285	58.75	Chrome	Handle cap kit
150663ORB	81.05	Oil Rubbed Bronze	Handle escutcheon	154286	173.05	Chrome	Spout kit
150663SRS	67.80	Spot Resist Stainless	Handle escutcheon	154286BN	258.55	Brushed Nickel	Spout kit
150663WR	81.05	Wrought Iron	Handle escutcheon	154286NL	284.45	Polished Nickel	Spout kit
150664	32.00	Chrome	Handle kit	154286ORB	284.45	Oil Rubbed Bronze	Spout kit
150664CSL	46.40	Classic Stainless	Handle kit	154287	20.40	Chrome	Lift rod kit
150664ORB	51.05	Oil Rubbed Bronze	Handle kit	154287BN	26.15	Brushed Nickel	Lift rod kit
150665	38.45	Chrome	Handle kit	154287NL	28.85	Polished Nickel	Lift rod kit
150665ORB	61.30	Oil Rubbed Bronze	Handle kit	154287ORB	28.85	Oil Rubbed Bronze	Lift rod kit
150665SRS	55.70	Spot Resist Stainless	Handle kit	154288	22.70	Chrome	Aerator
150666	10.35	Chrome	Dome kit	154288ORB	34.95	Oil Rubbed Bronze	Aerator
150666ORB	23.40	Oil Rubbed Bronze	Dome kit	154288SRS	32.70	Spot Resist Stainless	Aerator
150666SRS	13.00	Spot Resist Stainless	Dome kit	154289	7.20	N/A or Unfinished	Aerator
150667	38.45	Chrome	Handle escutcheon	154290	218.30	Chrome	Roman tub spout kit
150667ORB	61.30	Oil Rubbed Bronze	Handle escutcheon	154290BN	316.60	Brushed Nickel	Roman tub spout kit
150667SRS	55.70	Spot Resist Stainless	Handle escutcheon	154290NL	336.20	Polished Nickel	Roman tub spout kit
150668	35.00	Chrome	Handle kit	154290ORB	336.20	Oil Rubbed Bronze	Roman tub spout kit
150668ORB	55.90	Oil Rubbed Bronze	Handle kit	154291	237.45	Chrome	Roman tub diverter spout
150668SRS	49.10	Spot Resist Stainless	Handle kit	154291BN	344.30	Brushed Nickel	Roman tub diverter spout
150669	11.85	Chrome	Dome kit	154291NL	357.95	Polished Nickel	Roman tub diverter spout
150669ORB	25.15	Oil Rubbed Bronze	Dome kit	154291ORB	357.95	Oil Rubbed Bronze	Roman tub diverter spout
150669SRS	16.60	Spot Resist Stainless	Dome kit	154292	14.25	Chrome	Diverter rod kit
150671	28.65	Chrome	Handle kit	154292BN	21.25	Brushed Nickel	Diverter rod kit
150671SRS	35.80	Spot Resist Stainless	Handle kit	154292NL	23.35	Polished Nickel	Diverter rod kit
150672	111.00	Chrome	Spout kit	154292ORB	23.35	Oil Rubbed Bronze	Diverter rod kit
150883	3.80	N/A or Unfinished	Hot/cold indicator kit	154293	378.10	Chrome	Spout kit
151187CSL	124.25	Classic Stainless	Spout kit	154293BN	549.95	Brushed Nickel	Spout kit
151188	54.75	Chrome	Spout kit	154293NL	582.25	Polished Nickel	Spout kit
151188CSL	79.40	Classic Stainless	Spout kit	154293ORB	582.25	Oil Rubbed Bronze	Spout kit
151188ORB	87.35	Oil Rubbed Bronze	Spout kit	154294	24.80	Chrome	Handle kit
151189	30.55	Chrome	Wand kit	154294BN	35.90	Brushed Nickel	Handle kit
151189BL	53.35	Matte Black	Spout kit	154294NL	38.15	Polished Nickel	Handle kit
151189CSL	41.25	Classic Stainless	Wand kit	154294ORB	38.15	Oil Rubbed Bronze	Handle kit
151189ORB	44.55	Oil Rubbed Bronze	Wand kit	154294SRS	35.90	Spot Resist Stainless	Handle kit
151190	17.15	Chrome	Aerator kit	154295	33.75	Chrome	Stream straightener
151190CSL	32.60	Classic Stainless	Aerator kit	154295BN	50.70	Brushed Nickel	Stream straightener
151644	1.40	N/A or Unfinished	Plug button kit	154295NL	55.70	Polished Nickel	Stream straightener
151813	22.30	Chrome	Escutcheon	154295ORB	55.70	Oil Rubbed Bronze	Stream straightener
151813BN	29.90	Brushed Nickel	Escutcheon	154296BN	283.55	Brushed Nickel	Brushed nickel slide bars
152027	59.45	Chrome	Chrome line list items	154297	8.60	Chrome	Slide bar end cap
152027BN	88.55	Brushed Nickel	Brushed nickel line list items	154297BN	13.55	Brushed Nickel	Slide bar end cap
152859	4.95	Chrome	Plug button kit	154297NL	14.95	Polished Nickel	Slide bar end cap
152859BL	5.85	Black	Plug button kit	154297ORB	14.95	Oil Rubbed Bronze	Slide bar end cap
152859CSL	5.85	Classic Stainless	Plug button kit				
152859NL	5.85	Polished Nickel	Plug button kit				
152859ORB	5.85	Oil Rubbed Bronze	Plug button kit				

Moen Genuine Parts

Listed in numerical order

Part Number	List Price	Finish	Description	Part Number	List Price	Finish	Description
154298	15.90	Chrome	Handle kit	156815	119.75	Chrome	Showerhead kit
154298BN	22.90	Brushed Nickel	Handle kit	157131	28.90	Chrome	Shower escutcheon
154298NL	22.90	Polished Nickel	Handle kit	157131BC	50.40	Brushed Chrome	Shower escutcheon
154298ORB	25.20	Oil Rubbed Bronze	Handle kit	157131P	45.00	Polished Brass	Shower escutcheon
154299	57.90	Chrome	Wall escutcheon and gasket	157328	42.90	Chrome	Escutcheon
154299BN	89.25	Brushed Nickel	Wall escutcheon and gasket	157328ORB	54.30	Oil Rubbed Bronze	Escutcheon
154299NL	98.20	Polished Nickel	Wall escutcheon and gasket	157328SRS	49.35	Spot Resist Stainless	Escutcheon
154299ORB	98.20	Oil Rubbed Bronze	Wall escutcheon and gasket	158080	14.65	Chrome	Escutcheon
154300	37.45	Chrome	Shower escutcheon	158080BN	17.25	Brushed Nickel	Escutcheon
154300BN	54.30	Brushed Nickel	Shower escutcheon	158197	83.50	Chrome	Spout kit
154300NL	59.80	Polished Nickel	Shower escutcheon	158197CSL	114.40	Classic Stainless	Spout kit
154300ORB	59.80	Oil Rubbed Bronze	Shower escutcheon	158198CSL	101.05	Classic Stainless	Spout kit
154301	38.70	Chrome	Handle hub	158198SRS	89.65	Spot Resist Stainless	Spout kit
154301BN	56.10	Brushed Nickel	Handle hub	158378	59.90	Chrome	Diverter tub spout
154301NL	61.65	Polished Nickel	Handle hub	158492	25.40	Chrome	Handle kit
154301ORB	61.65	Oil Rubbed Bronze	Handle hub	158493	23.05	Chrome	Handle kit
154302	47.75	Chrome	Handle hub	158493BN	28.25	Brushed Nickel	Handle kit
154302BN	56.10	Brushed Nickel	Handle hub	158494	29.65	Chrome	Handle kit
154302NL	56.10	Polished Nickel	Handle hub	158494BN	40.90	Brushed Nickel	Handle kit
154302ORB	58.30	Oil Rubbed Bronze	Handle hub	158495	33.95	Chrome	Handle kit
154306	14.25	Chrome	Handle kit	158495BN	48.25	Brushed Nickel	Handle kit
154306BN	20.55	Brushed Nickel	Handle kit	158532ORB	11.95	Chrome	Dome
154306NL	22.75	Polished Nickel	Handle kit	158550	4.70	N/A or Unfinished	Check valve kit
154306ORB	22.75	Oil Rubbed Bronze	Handle kit	159014	40.00	Chrome	Escutcheon
154364	6.95	N/A or Unfinished	Aerator kit	159014BN	52.80	Brushed Nickel	Escutcheon
154391	30.90	Chrome	Handle hub	159018	71.95	Chrome	Handle kit
154391BN	43.35	Brushed Nickel	Handle hub kit	159018BN	97.25	Brushed Nickel	Handle kit
155023	4.95	N/A or Unfinished	Screw kit	159018ORB	108.90	Oil Rubbed Bronze	Handle kit
155649	42.35	Chrome	Escutcheon	159019	71.85	Chrome	Handle kit
155649BN	61.40	Brushed Nickel	Escutcheon	159019BN	94.00	Brushed Nickel	Handle kit
155649NL	61.40	Polished Nickel	Escutcheon	159020	72.30	Chrome	Handle kit
155649ORB	67.55	Oil Rubbed Bronze	Escutcheon	159020BN	98.50	Brushed Nickel	Handle kit
155650	37.75	Chrome	Escutcheon	159022	63.75	Chrome	Escutcheon
155650BN	54.80	Brushed Nickel	Escutcheon	159022BN	87.40	Brushed Nickel	Escutcheon
155650NL	54.80	Polished Nickel	Escutcheon	159022ORB	84.70	Oil Rubbed Bronze	Escutcheon
155650ORB	60.25	Oil Rubbed Bronze	Escutcheon	159023	60.30	Chrome	Escutcheon
155651	17.00	N/A or Unfinished	Hardware kit	159023BN	81.95	Brushed Nickel	Escutcheon
155652	6.50	N/A or Unfinished	Hardware kit	159024	71.60	Chrome	Handle kit
155654	4.45	N/A or Unfinished	O-ring kit	159024BN	96.75	Brushed Nickel	Handle kit
155655	1.35	N/A or Unfinished	Screen washer	159028	72.60	Chrome	Handle kit
155656	35.55	N/A or Unfinished	Extension kit	159028BN	95.65	Brushed Nickel	Handle kit
155658	15.10	N/A or Unfinished	Hardware kit	159029	72.65	Chrome	Handle kit
155664	216.35	Chrome	Spout kit	159029BN	98.95	Brushed Nickel	Handle kit
155664BN	278.45	Brushed Nickel	Spout kit	159029ORB	105.95	Oil Rubbed Bronze	Handle kit
155664ORB	313.55	Oil Rubbed Bronze	Spout kit	159060	18.80	N/A or Unfinished	Hose guide
155665	204.25	Chrome	Spout kit	159107	35.10	Chrome	Handle kit
155665BN	262.35	Brushed Nickel	Spout kit	159107BN	51.35	Brushed Nickel	Handle kit
155665ORB	295.25	Oil Rubbed Bronze	Spout kit	159107P	56.35	Polished Brass	Handle kit
155759	8.25	N/A or Unfinished	Screw kit	159264	34.35	Chrome	Escutcheon
155891	58.70	Chrome	Chrome eco-performance handshower	159264BN	43.05	Brushed Nickel	Escutcheon
155891BL	93.70	Matte Black	Handshower	159266	35.65	Chrome	Handle kit
155891BN	85.15	Brushed Nickel	Brushed nickel eco-performance rainshower	159266BN	52.15	Brushed Nickel	Handle kit
156723	15.90	Chrome	Handle kit	159559	13.35	N/A or Unfinished	Hose weight
156723P	48.95	Polished Brass	Handle kit	159560	33.95	N/A or Unfinished	Hose kit
156724	45.85	Chrome	Handle kit	159561	54.00	Chrome	Wand kit
156724BC	55.00	Brushed Chrome	Handle kit	159561BL	53.25	Matte Black	Wand kit
156781	64.65	Chrome	Spout hub kit	159561ORB	103.90	Matte Black	Wand kit
156781CSL	92.00	Classic Stainless	Spout kit	159561SRS	63.05	Spot Resist Stainless	Wand kit
156781ORB	102.90	Oil Rubbed Bronze	Spout hub kit	159563	58.75	Chrome	Wand kit
156782	29.00	N/A or Unfinished	Hardware kit	159563ORB	84.15	Oil Rubbed Bronze	Wand kit
				159576	6.80	N/A or Unfinished	Gasket
				159581	34.75	N/A or Unfinished	Hose kit
				159582	17.15	N/A or Unfinished	Hose kit
				160659	8.80	Chrome	Dome kit
				160659BN	9.40	Chrome	Dome kit

Moen Genuine Parts

Listed in numerical order

Part Number	List Price	Finish	Description	Part Number	List Price	Finish	Description
160659NL	12.20	Polished Nickel	Dome kit	161917	15.05	Chrome	Lift rod kit
160659ORB	10.20	Chrome	Dome kit	161917BN	18.30	Brushed Nickel	Lift rod kit
160659SRS	11.25	Spot Resist Stainless	Dome kit	161917ORB	18.65	Oil Rubbed Bronze	Lift rod kit
160660	8.80	Chrome	Cartridge nut	161919	22.30	Chrome	Deck plate
160660BL	14.70	Matte Black	Dome	161919BN	31.60	Brushed Nickel	Deck plate
160660BN	9.40	Brushed Nickel	Cartridge nut	161919ORB	39.70	Oil Rubbed Bronze	Deck plate
160660ORB	10.20	Oil Rubbed Bronze	Cartridge nut	161942	59.35	Chrome	Handle kit
160660SRS	15.20	Spot Resist Stainless	Dome	161942BN	81.05	Brushed Nickel	Handle kit
160997SRS	29.00	Spot Resist Stainless	Aerator	161942ORB	92.45	Oil Rubbed Bronze	Handle kit
160998SRS	51.55	Spot Resist Stainless	Wand kit	161944	138.35	Chrome	Spout kit
160999SRS	20.10	Spot Resist Stainless	Aerator	161944BN	183.30	Brushed Nickel	Spout kit
161143	55.00	Chrome	Wand kit	161944ORB	210.10	Oil Rubbed Bronze	Spout kit
161143BL	52.65	Matte Black	Wand kit	161945	39.80	Chrome	Handle screw
161143SRS	57.10	Spot Resist Stainless	Wand kit	161945BN	49.05	Brushed Nickel	Handle kit
161143V	40.15	Ivory	Wand kit	161945ORB	65.50	Oil Rubbed Bronze	Handle kit
161143WG	52.65	Glacier	Wand kit	161947	294.25	Chrome	Roman tub spout kit
161144	48.85	Chrome	Wand kit	161947BN	399.40	Brushed Nickel	Spout kit
161144SRS	72.40	Spot Resist Stainless	Wand kit	161947ORB	377.60	Oil Rubbed Bronze	Spout kit
161145	30.55	Chrome	Wand kit	161949	321.50	Chrome	Roman tub spout kit
161145BL	45.40	Matte Black	Wand kit	161949BN	422.35	Brushed Nickel	Spout kit
161145ORB	44.55	Oil Rubbed Bronze	Wand kit	161949ORB	407.00	Oil Rubbed Bronze	Spout kit
161146	77.95	Chrome	Wand kit	161950	15.90	Chrome	Lift rod kit
161146CSL	71.85	Classic Stainless	Wand kit	161950BN	19.50	Brushed Nickel	Lift rod kit
161147	88.90	Chrome	Wand kit	161950ORB	20.15	Brushed Nickel	Lift rod kit
161147ORB	156.05	Chrome	Wand kit	161952	45.95	Chrome	Shower escutcheon
161147W	129.15	Glacier	Wand kit	161952BN	84.20	Brushed Nickel	Shower escutcheon
161148	60.90	Chrome	Wand kit	161952ORB	66.00	Oil Rubbed Bronze	Shower escutcheon
161148CSL	69.85	Classic Stainless	Wand kit	161953	34.35	Chrome	Shower escutcheon
161149	89.55	Chrome	Wand kit	161953BN	72.35	Brushed Nickel	Shower escutcheon
161149ORB	116.50	Oil Rubbed Bronze	Wand kit	161953ORB	50.05	Oil Rubbed Bronze	Shower escutcheon
161149SRS	107.25	Spot Resist Stainless	Wand kit	161954	42.20	Chrome	Handle kit
161150	82.20	Chrome	Wand kit	161954BN	56.35	Brushed Nickel	Handle kit
161150BL	81.00	Black	Wand kit	161954ORB	60.95	Oil Rubbed Bronze	Handle kit
161150CSL	99.40	Classic Stainless	Wand kit	161955ORB	122.90	Oil Rubbed Bronze	Oil rubbed bronze line list items
161150ORB	102.15	Oil Rubbed Bronze	Wand kit	161956	6.35	Chrome	Hot/cold indicator kit
161151	66.00	Chrome	Wand kit	162105	11.00	N/A or Unfinished	Handle cap kit
161151CSL	89.05	Classic Stainless	Wand kit	162154	27.65	N/A or Unfinished	Cartridge
161152	61.80	Chrome	Wand kit	162378	9.90	N/A or Unfinished	Check valve kit
161152CSL	116.90	Classic Stainless	Wand kit	162379	9.90	N/A or Unfinished	Check valve kit
161152SRS	112.85	Spot Resist Stainless	Wand kit	162649	104.00	N/A or Unfinished	Cartridge nut
161153	37.00	Chrome	Wand kit	163053	186.15	Chrome	Spout kit
161153ORB	56.80	Oil Rubbed Bronze	Wand kit	163053BN	238.55	Brushed Nickel	Spout kit
161153SRS	49.90	Spot Resist Stainless	Wand kit	163053ORB	277.15	Oil Rubbed Bronze	Spout kit
161154	68.70	Chrome	Wand kit	163127	109.65	N/A or Unfinished	Cartridge
161154SRS	119.55	Spot Resist Stainless	Wand kit	163138	39.80	Chrome	Handle kit
161156	53.15	Chrome	Wand kit	163138BN	49.05	Brushed Nickel	Handle kit
161156ORB	65.95	Oil Rubbed Bronze	Wand kit	163138ORB	65.50	Oil Rubbed Bronze	Handle kit
161156SRS	63.10	Spot Resist Stainless	Wand kit	163153	28.40	Chrome	Escutcheon
161157	45.50	Chrome	Wand kit	163153BN	34.40	Brushed Nickel	Escutcheon
161157ORB	85.65	Oil Rubbed Bronze	Wand kit	163153ORB	41.60	Oil Rubbed Bronze	Escutcheon
161157SRS	55.35	Spot Resist Stainless	Wand kit	163215	10.40	N/A or Unfinished	C-clip
161756	24.55	N/A or Unfinished	Mounting kit	163244	59.30	Chrome	Wand kit
161757	7.40	N/A or Unfinished	Cartridge nut	163244SRS	68.05	Spot Resist Stainless	Wand kit
161758	26.10	N/A or Unfinished	Stem extension kit	163245	171.15	Chrome	Spout kit
161759	5.30	N/A or Unfinished	Plaster ground	163245SRS	207.35	Spot Resist Stainless	Spout kit
161760	6.45	N/A or Unfinished	Mounting kit	163246	55.60	Chrome	Wand kit
161761	37.25	N/A or Unfinished	Shank kit	163246CSL	68.30	Classic Stainless	Wand kit
161762	24.05	N/A or Unfinished	Mounting kit	163246SRS	68.30	Spot Resist Stainless	Wand kit
161771	9.25	N/A or Unfinished	Mounting kit	163247	56.10	Chrome	Spout receptor kit
161772	34.65	N/A or Unfinished	Diverter kit	163248	59.35	Chrome	Wand kit
161773	19.95	N/A or Unfinished	installation tool	163248CSL	68.75	Classic Stainless	Wand kit
161774	9.75	N/A or Unfinished	Handle adapter kit	163248ORB	121.75	Oil Rubbed Bronze	Wand kit
161909	28.25	Chrome	Handle kit	163248SRS	68.75	Spot Resist Stainless	Wand kit
161909BN	38.55	Brushed Nickel	Handle kit	163248W	52.65	Wrought Iron	Wand kit
161909ORB	43.50	Oil Rubbed Bronze	Handle kit				

Moen Genuine Parts

Listed in numerical order

Part Number	List Price	Finish	Description	Part Number	List Price	Finish	Description
163249ORB	105.40	Oil Rubbed Bronze	Spout receptor kit	165922	20.65	Porcelain	Handle cap kit
163249W	115.30	Wrought Iron	Spout receptor kit	165998	26.90	Chrome	Spout cap
163250	70.95	Chrome	Spout kit	165998NL	21.25	Chrome	Spout cap
163250SRS	94.35	Spot Resist Stainless	Spout kit	165998ORB	33.80	Chrome	Spout cap
163710	6.40	N/A or Unfinished	Hose guide	165998SRS	33.80	Chrome	Spout cap
163711	12.30	N/A or Unfinished	Battery kit	168492	89.80	Chrome	Wand kit
163714	200.50	N/A or Unfinished	Electronic module bracket kit	168492BL	130.10	Matte Black	Wand kit
163716	12.70	N/A or Unfinished	Hose kit	168492SRS	130.10	Spot Resist Stainless	Wand kit
163717	12.80	N/A or Unfinished	Filter manifold kit	168493	100.05	Chrome	Spout kit
163718	25.80	N/A or Unfinished	Hose kit	168493BL	144.05	Matte Black	Spout kit
163792	3.60	Chrome	Cap	168493BRB	155.55	Mediterranean Bronze	Spout kit
163792BN	5.90	Brushed Nickel	Cap	168493MSRS	126.70	Spot Resist Stainless Microban	Spout kit
163792ORB	6.60	Oil Rubbed Bronze	Cap	168493ORB	155.55	Oil Rubbed Bronze	Spout kit
163793	4.35	N/A or Unfinished	Hardware kit	168493SRS	145.10	Spot Resist Stainless	Spout kit
163795SRS	59.35	Spot Resist Stainless	Wand kit	168494	23.45	Chrome	Handle kit
163847	10.45	N/A or Unfinished	Aerator	168494BL	34.00	Matte Black	Handle kit
163949	4.00	Chrome	Plug button kit	168494SRS	34.00	Spot Resist Stainless	Handle kit
163949BN	4.10	Brushed Nickel	Plug button kit	168495	144.55	Chrome	Spout kit
163949ORB	4.35	Oil Rubbed Bronze	Plug button kit	168495SRS	209.55	Spot Resist Stainless	Spout kit
164486	12.10	Chrome	Hose guide	168496	31.70	Chrome	Hose & spray
164486NL	27.55	Polished Nickel	Hose guide	168496SRS	46.00	Spot Resist Stainless	Hose & spray
164486ORB	57.45	Oil Rubbed Bronze	Hose guide	168497	93.10	Chrome	Spout kit
164486SRS	16.30	Spot Resist Stainless	Hose guide	168497SRS	134.90	Spot Resist Stainless	Spout kit
164487	25.30	Chrome	Handle kit	168498	5.45	N/A or Unfinished	Gasket
164487NL	33.50	Polished Nickel	Handle kit	168499	8.00	Chrome	Aerator
164487ORB	39.50	Oil Rubbed Bronze	Handle kit	168500	89.75	N/A or Unfinished	Wand kit
164487SRS	33.90	Spot Resist Stainless	Handle kit	168501	155.45	Chrome	Pullout spout
164488	40.40	Chrome	Aerator kit	168501BL	217.60	Matte Black	Pullout spout
164488NL	42.95	Polished Nickel	Aerator kit	168501SRS	225.35	Spot Resist Stainless	Pullout spout
164488ORB	48.95	Oil Rubbed Bronze	Aerator kit	168502	27.40	Chrome	Handle kit
164488SRS	42.95	Spot Resist Stainless	Aerator kit	168502BL	38.40	Matte Black	Handle kit
165003BL	38.95	Matte Black	Lift rod kit	168502SRS	39.70	Spot Resist Stainless	Handle kit
165006	23.60	Chrome	Deck plate	168503	139.45	Chrome	Spout kit
165006BN	44.35	Brushed Nickel	Deck plate	168503BL	195.30	Matte Black	Spout kit
165018	6.95	N/A or Unfinished	Aerator	168503SRS	202.30	Spot Resist Stainless	Spout kit
165193	37.35	Chrome	Handle kit	168504	5.45	N/A or Unfinished	Gasket
165572	3.10	N/A or Unfinished	Lift rod kit	168665	27.30	N/A or Unfinished	Adapter kit
165901	35.80	Chrome	Escutcheon	168666	17.40	N/A or Unfinished	Side spray kit
165903	23.20	Chrome	Handle kit	168682	238.65	Chrome	Spout kit
165903BN	30.65	Brushed Nickel	Handle kit	168682BN	293.55	Brushed Nickel	Spout kit
165904	26.10	Chrome	Handle kit	168683	69.85	Chrome	Shower escutcheon
165904BN	33.65	Brushed Nickel	Handle kit	168683BN	105.10	Brushed Nickel	Shower escutcheon
165905	50.10	Chrome	Handle kit	168809	8.05	N/A or Unfinished	Mounting kit
165905BN	68.80	Brushed Nickel	Handle kit	168994	7.20	N/A or Unfinished	O-ring kit
165906	255.40	Chrome	Spout kit	169031	132.55	N/A or Unfinished	Adapter kit
165906BN	330.85	Brushed Nickel	Spout kit	169032	228.05	N/A or Unfinished	MotionSense reprogramming kit
165907	5.40	N/A or Unfinished	Hot/cold indicator kit	169245ORB	11.65	Oil Rubbed Bronze	Dome kit
165908	229.20	Chrome	Spout kit	169250ORB	71.35	Oil Rubbed Bronze	Wand kit
165908BN	317.45	Brushed Nickel	Spout kit	169252	40.45	Chrome	Escutcheon & gasket kit
165909	392.30	Chrome	Diverter tub spout	169252ORB	47.20	Oil Rubbed Bronze	Escutcheon & gasket kit
165909BN	446.90	Brushed Nickel	Diverter tub spout	169507	15.45	Chrome	Extension kit
165910	52.15	Chrome	Lift rod kit	169752	69.15	Chrome	Shower escutcheon
165910BN	72.15	Brushed Nickel	Lift rod kit	170145	336.10	Chrome	Spout kit
165911	81.10	Chrome	Shower escutcheon	170145CSL	173.75	Classic Stainless	Spout kit
165911BN	122.15	Brushed Nickel	Shower escutcheon	170145ORB	450.35	Oil Rubbed Bronze	Spout kit
165912	45.85	Chrome	Handle escutcheon	170145SRS	420.55	Spot Resist Stainless	Spout kit
165912BN	64.10	Brushed Nickel	Handle escutcheon	170206	6.25	N/A or Unfinished	Bearing washer kit
165913	34.35	Chrome	Handle kit	170926S	76.80	Sand	Hose & spray
165913BN	47.00	Brushed Nickel	Handle kit	171325	8.20	Black	Service kit
165916	67.85	Chrome	Handle kit	172654	36.10	Chrome	Handle kit
165916BN	94.20	Brushed Nickel	Handle kit	172654BL	44.65	Matte Black	Handle kit
165917	67.45	Chrome	Handle kit	172654BN	44.70	Brushed Nickel	Handle kit
165917BN	93.50	Brushed Nickel	Handle kit	172655	33.70	Chrome	Escutcheon
165918	36.90	Chrome	Escutcheon	172655BL	49.80	Matte Black	Escutcheon

Moen Genuine Parts

Listed in numerical order

Part Number	List Price	Finish	Description	Part Number	List Price	Finish	Description
172655BN	41.75	Brushed Nickel	Escutcheon	174818	21.70	Chrome	Spout kit
172658	40.25	Chrome	Lift rod kit	174836	4.55	N/A or Unfinished	Diverter kit
172658BN	57.35	Brushed Nickel	Lift rod kit	174948MBRB	117.70	Mediterranean Bronze Microban	Spout kit
172659	245.70	Chrome	Spout kit	175083	6.95	N/A or Unfinished	Aerator
172659BN	332.10	Brushed Nickel	Spout kit	175084	6.95	N/A or Unfinished	Aerator
172660	241.50	Chrome	Spout kit	175376	35.50	Chrome	Handle kit
172660BN	334.15	Brushed Nickel	Spout kit	175376BN	49.60	Brushed Nickel	Handle kit
172661	35.90	Chrome	Lift rod kit	175376NL	49.60	Polished Nickel	Handle kit
172661BL	44.75	Matte Black	Lift rod kit	175376ORB	54.65	Oil Rubbed Bronze	Handle kit
172661BN	50.85	Brushed Nickel	Lift rod kit	175377	46.70	Chrome	Escutcheon
172662	20.45	Chrome	Spout kit	175377BN	65.50	Brushed Nickel	Escutcheon
172662BL	161.20	Matte Black	Spout kit	175377NL	65.50	Polished Nickel	Escutcheon
172662BN	28.30	Brushed Nickel	Spout kit	175377ORB	72.05	Oil Rubbed Bronze	Escutcheon
172663	47.35	Chrome	Handle kit	175378	32.15	Chrome	Lift rod kit
172663BL	64.90	Matte Black	Handle kit	175378BN	44.95	Brushed Nickel	Lift rod kit
172663BN	65.45	Brushed Nickel	Handle kit	175378NL	44.95	Polished Nickel	Lift rod kit
172664BN	31.70	Brushed Nickel	Handle kit	175378ORB	49.45	Oil Rubbed Bronze	Lift rod kit
172665	29.05	Chrome	Handle kit	175379	46.10	Chrome	Handle kit
172665BL	54.80	Matte Black	Handle kit	175379BN	64.45	Brushed Nickel	Handle kit
172665BN	34.20	Brushed Nickel	Handle kit	175379NL	64.45	Polished Nickel	Handle kit
172666	16.15	Chrome	Escutcheon	175379ORB	70.90	Oil Rubbed Bronze	Handle kit
172666BL	28.25	Matte Black	Escutcheon	175380	58.60	Chrome	Handle kit
172666BN	20.05	Brushed Nickel	Escutcheon	175380BN	82.05	Brushed Nickel	Handle kit
172667	10.55	Chrome	Lift rod kit	175380NL	82.05	Polished Nickel	Handle kit
172667BL	20.75	Matte Black	Lift rod kit	175380ORB	90.30	Oil Rubbed Bronze	Handle kit
172667BN	13.60	Brushed Nickel	Lift rod kit	175381	151.25	Chrome	Spout kit
172668	11.80	Chrome	Escutcheon	175381BN	211.70	Brushed Nickel	Spout kit
172668BL	21.00	Matte Black	Escutcheon	175381NL	211.70	Polished Nickel	Spout kit
172668BN	14.45	Brushed Nickel	Escutcheon	175381ORB	232.90	Oil Rubbed Bronze	Handle kit
172669	50.35	Chrome	Escutcheon	175382	290.95	Chrome	Spout kit
172669BN	66.45	Brushed Nickel	Escutcheon	175382BN	407.35	Brushed Nickel	Spout kit
173488BL	12.35	Black	Knob kit (soap dispenser cap)	175382NL	407.35	Polished Nickel	Spout kit
173490	16.50	N/A or Unfinished	Liquid dispenser bottle	175382ORB	448.15	Oil Rubbed Bronze	Spout kit
173714	177.80	N/A or Unfinished	Electronic module bracket kit	175383	46.70	Chrome	Escutcheon
173717	30.15	N/A or Unfinished	Filter manifold kit	175383BN	65.45	Brushed Nickel	Escutcheon
173720	3.10	N/A or Unfinished	Check valve kit	175383NL	65.45	Polished Nickel	Escutcheon
173981	101.80	Chrome	Spout kit	175383ORB	72.05	Oil Rubbed Bronze	Escutcheon
173987	23.20	Chrome	Handle kit	175385	71.65	Chrome	Chrome diverter spouts line list items
173987SRS	30.00	Spot Resist Stainless	Handle kit	175385BN	111.20	Brushed Nickel	Brushed nickel diverter spouts line list items
173988	77.80	Chrome	Wand kit	175385NL	111.20	Polished Nickel	Polished nickel diverter spouts line list items
173988SRS	94.80	Spot Resist Stainless	Wand kit	175385ORB	122.20	Oil Rubbed Bronze	Oil rubbed bronze diverter spouts line list items
173989	102.90	Chrome	Spout receptor kit	175386	30.05	Chrome	Escutcheon
173989SRS	136.45	Spot Resist Stainless	Spout receptor kit	175386BN	42.10	Brushed Nickel	Escutcheon
174055	29.85	N/A or Unfinished	Battery housing	175386NL	42.10	Polished Nickel	Escutcheon
174056	94.85	N/A or Unfinished	Solenoid repair kit	175386ORB	46.30	Oil Rubbed Bronze	Escutcheon
174057	26.35	N/A or Unfinished	Strain relief & sensor cable	175394	67.45	N/A or Unfinished	Piston, bulk kit
174060	16.70	N/A or Unfinished	Mounting kit	175709	107.80	N/A or Unfinished	Extension kit
174061	23.40	Chrome	Manual ovrrd temp cntrl handle	175916	14.95	N/A or Unfinished	Adapter kit
174062	8.65	N/A or Unfinished	Hardware kit	175917	14.95	N/A or Unfinished	Adapter kit
174065	47.35	N/A or Unfinished	in-line filter w/ check valve	175918	14.95	N/A or Unfinished	Adapter kit
174066	5.45	N/A or Unfinished	Filter screen	175921	14.95	N/A or Unfinished	Adapter kit
174290	19.85	N/A or Unfinished	Extension kit	175925	14.95	N/A or Unfinished	Service kit
174291	39.80	N/A or Unfinished	Valve body	175926	14.95	N/A or Unfinished	Service kit
174292	39.80	N/A or Unfinished	Valve body	175959	29.45	Chrome	Handle kit
174329	8.80	N/A or Unfinished	Handle adapter kit	175959ORB	43.15	Oil Rubbed Bronze	Handle kit
174333	43.95	Chrome	Shower escutcheon	175959SRS	37.05	Spot Resist Stainless	Handle kit
174333BL	48.20	Matte Black	Shower escutcheon	175960	55.20	Chrome	Wand kit
174333BN	63.05	Brushed Nickel	Shower escutcheon	175960ORB	81.90	Oil Rubbed Bronze	Wand kit
174335	187.35	N/A or Unfinished	ir sensor bracket	175960SRS	65.25	Spot Resist Stainless	Wand kit
174336	18.55	Chrome	Plug button kit	175961	193.70	Chrome	Spout receptor kit
174337	18.55	Chrome	Plug button kit				

Moen Genuine Parts

Listed in numerical order

Part Number	List Price	Finish	Description	Part Number	List Price	Finish	Description
175961ORB	303.00	Oil Rubbed Bronze	Spout receptor kit	176633	32.45	Chrome	Diverter kit
175961SRS	249.10	Spot Resist Stainless	Spout receptor kit	176633BN	45.45	Brushed Nickel	Diverter kit
175983	150.50	Chrome	Spout kit	176633NL	45.45	Polished Nickel	Diverter kit
175983ORB	226.50	Oil Rubbed Bronze	Spout kit	176633ORB	49.95	Oil Rubbed Bronze	Diverter kit
175983SRS	185.60	Spot Resist Stainless	Spout kit	176787	14.05	N/A or Unfinished	Hardware kit
175984	42.25	Chrome	Wand kit	177049	21.55	N/A or Unfinished	O-ring kit
175984ORB	60.90	Oil Rubbed Bronze	Wand kit	177054	0.05	N/A or Unfinished	O-ring kit
175984SRS	51.80	Spot Resist Stainless	Wand kit	177056	0.10	N/A or Unfinished	O-ring kit
175985	25.70	Chrome	Handle kit	177138	37.20	Chrome	Handle kit
175985ORB	37.15	Oil Rubbed Bronze	Handle kit	177138BN	52.10	Brushed Nickel	Handle kit
175985SRS	32.20	Spot Resist Stainless	Handle kit	177138ORB	57.40	Oil Rubbed Bronze	Handle kit
175988	139.20	Chrome	Spout kit	177167	36.60	Chrome	Deck plate
175988ORB	216.20	Oil Rubbed Bronze	Spout kit	177167BN	51.30	Brushed Nickel	Deck plate
175988SRS	178.40	Spot Resist Stainless	Spout kit	177167NL	51.30	Polished Nickel	Deck plate
175989	41.35	Chrome	Wand kit	177167ORB	56.35	Oil Rubbed Bronze	Deck plate
175989ORB	61.35	Oil Rubbed Bronze	Wand kit	177565	55.35	N/A or Unfinished	AC Adapter for MotionSense
175989SRS	50.80	Spot Resist Stainless	Wand kit	177566	40.75	N/A or Unfinished	Mounting hardware
175991	4.30	N/A or Unfinished	Gasket	177567	15.05	N/A or Unfinished	Battery kit
176077	79.65	Chrome	Spout kit	177568	107.45	N/A or Unfinished	Service kit
176077BL	102.40	Black	Spout kit	177569	204.10	N/A or Unfinished	Service kit
176077BRB	123.90	Mediterranean Bronze	Spout kit	177570	10.55	N/A or Unfinished	Mounting kit
176077MSRS	101.05	Spot Resist Stainless Microban	Spout kit	177572	24.70	N/A or Unfinished	Hose kit
176077ORB	123.90	Oil Rubbed Bronze	Spout kit	177573	389.00	Chrome	Spout kit
176078	88.45	Chrome	Spout kit	177573ORB	431.90	Oil Rubbed Bronze	Spout kit
176078BRB	127.60	Mediterranean Bronze	Spout kit	177573SRS	411.05	Spot Resist Stainless	Spout kit
176078ORB	127.60	Oil Rubbed Bronze	Spout kit	177574	410.30	Chrome	Spout kit
176078SRS	96.80	Spot Resist Stainless	Spout kit	177574ORB	451.20	Oil Rubbed Bronze	Spout kit
176079	85.50	Chrome	Spout kit	177574SRS	433.45	Spot Resist Stainless	Spout kit
176079BL	106.95	Black	Spout kit	177575	371.70	Chrome	Spout kit
176079ORB	129.85	Oil Rubbed Bronze	Spout kit	177575SRS	395.10	Spot Resist Stainless	Spout kit
176079SRS	114.95	Spot Resist Stainless	Spout kit	177576	427.05	Chrome	Spout kit
176080	84.70	Chrome	Spout kit	177576SRS	473.55	Spot Resist Stainless	Spout kit
176080ORB	117.95	Oil Rubbed Bronze	Spout kit	177701	37.25	Chrome	Diverter knob kit
176080SRS	129.45	Spot Resist Stainless	Spout kit	177701BN	52.25	Brushed Nickel	Diverter knob kit
176081	91.00	Chrome	Spout kit	177701ORB	57.45	Oil Rubbed Bronze	Diverter knob kit
176081BL	116.95	Black	Spout kit	177702	33.10	Chrome	Escutcheon
176081SRS	128.45	Spot Resist Stainless	Spout kit	177702BN	46.30	Brushed Nickel	Escutcheon
176083	156.65	Chrome	Spout kit	177702ORB	50.90	Oil Rubbed Bronze	Escutcheon
176083ORB	212.95	Oil Rubbed Bronze	Spout kit	177703	256.05	N/A or Unfinished	Valve body
176083SRS	201.60	Spot Resist Stainless	Spout kit	177704	43.20	Chrome	Spray nozzle
176085	48.90	Chrome	Spout kit	177704BN	60.40	Brushed Nickel	Spray nozzle
176085ORB	68.75	Oil Rubbed Bronze	Spout kit	177704ORB	66.50	Oil Rubbed Bronze	Spray nozzle
176085SRS	71.35	Spot Resist Stainless	Spout kit	177705	58.10	Chrome	Spray nozzle
176086	92.05	Chrome	Spout kit	177706	13.95	N/A or Unfinished	Cartridge nut
176086ORB	124.30	Oil Rubbed Bronze	Spout kit	178216	30.90	Chrome	Handle kit
176086SRS	124.25	Spot Resist Stainless	Spout kit	178216ORB	43.60	Oil Rubbed Bronze	Handle kit
176087	56.05	Chrome	Spout kit	178216SRS	38.65	Spot Resist Stainless	Handle kit
176087BL	63.00	Black	Spout kit	178217	12.05	Chrome	Handle kit
176087ORB	72.20	Oil Rubbed Bronze	Spout kit	178217ORB	19.85	Oil Rubbed Bronze	Handle kit
176087SRS	72.40	Spot Resist Stainless	Spout kit	178217SRS	16.90	Spot Resist Stainless	Handle kit
176088	70.95	Chrome	Spout kit	178218	81.10	Chrome	Spout kit
176088SRS	92.10	Spot Resist Stainless	Spout kit	178218ORB	131.40	Oil Rubbed Bronze	Spout kit
176260	24.70	Chrome	Handle kit	178218SRS	147.05	Spot Resist Stainless	Spout kit
176260SRS	34.15	Spot Resist Stainless	Handle kit	178219	34.30	Chrome	Spout hub kit
176261	63.30	Chrome	Spout kit	178219ORB	57.95	Oil Rubbed Bronze	Spout hub kit
176261ORB	83.40	Oil Rubbed Bronze	Spout kit	178219SRS	43.85	Spot Resist Stainless	Spout hub kit
176261SRS	89.65	Spot Resist Stainless	Spout kit	178231	17.10	Chrome	Spout cap
176262	181.90	Chrome	Spout kit	178231ORB	23.75	Oil Rubbed Bronze	Spout cap
176262SRS	243.40	Spot Resist Stainless	Spout kit	178231SRS	31.30	Spot Resist Stainless	Spout cap
176263	37.00	Chrome	Wand kit	178232	36.55	Chrome	Handle kit
176264	44.65	Chrome	Spout kit	178232ORB	56.10	Oil Rubbed Bronze	Handle kit
176264SRS	55.40	Spot Resist Stainless	Spout kit	178232SRS	47.35	Spot Resist Stainless	Handle kit
176265	6.20	Chrome	Gasket kit	178233	73.50	Chrome	Spout hub kit
176415	24.45	Chrome	Vacuum breaker kit	178233ORB	103.50	Oil Rubbed Bronze	Spout hub kit

Moen Genuine Parts

Listed in numerical order

Part Number	List Price	Finish	Description	Part Number	List Price	Finish	Description
178233SRS	94.10	Spot Resist Stainless	Spout hub kit	179782BN	51.55	Brushed Nickel	Handle kit
178234	33.35	Chrome	Escutcheon	179783	21.25	N/A or Unfinished	Gasket
178234ORB	51.35	Oil Rubbed Bronze	Escutcheon	179784	57.20	Chrome	Handle kit
178234SRS	41.95	Spot Resist Stainless	Escutcheon	179784BN	68.55	Brushed Nickel	Handle kit
178294	33.55	N/A or Unfinished	Extension kit	179785	222.35	Chrome	Roman tub spout kit
178462	34.10	Chrome	Handle kit	179785BN	263.00	Brushed Nickel	Roman tub spout kit
178462BN	47.75	Brushed Nickel	Handle kit	179786	36.75	Chrome	Lift rod kit
178462NL	47.75	Polished Nickel	Handle kit	179786BN	39.15	Brushed Nickel	Lift rod kit
178462ORB	52.55	Oil Rubbed Bronze	Handle kit	179787	132.60	Chrome	Spout kit
178755	69.15	Chrome	Shower escutcheon	179787BN	176.15	Brushed Nickel	Spout kit
178755BN	100.30	Chrome	Shower escutcheon	179788		Chrome	Chrome one-Function 3.75" diameter spray head standard
178755ORB	106.55	Chrome	Shower escutcheon	179788BN		Brushed Nickel	Brushed nickel one-Function 3.75" diameter spray head standard
178888	177.45	Chrome	Spout kit	179788EP		Chrome	Chrome one-Function 3.75" diameter spray head eco-performance Showerhead
178888BN	257.35	Brushed Nickel	Spout kit	179788EPBN		Brushed Nickel	Brushed nickel one-Function 3.75" diameter spray head eco-performance Showerhead
178888ORB	283.05	Oil Rubbed Bronze	Spout kit	179790	29.55	Chrome	Escutcheon
178890	173.95	Chrome	Spout kit	179790BN	49.30	Brushed Nickel	Escutcheon
178890BN	252.35	Brushed Nickel	Spout kit	179791	86.55	Chrome	Chrome diverter spouts
178890ORB	277.50	Oil Rubbed Bronze	Spout kit	179791BN	110.10	Brushed Nickel	Brushed nickel diverter spouts
178892	191.45	Chrome	Spout kit	179792	49.60	Chrome	Handle kit
178892BN	277.60	Brushed Nickel	Spout kit	179792BN	58.30	Brushed Nickel	Handle kit
178892ORB	305.40	Oil Rubbed Bronze	Spout kit	179793	20.60	Chrome	Hose guide
178894	233.90	Chrome	Spout kit	179793ORB	24.20	Oil Rubbed Bronze	Hose guide
178894BN	339.15	Brushed Nickel	Spout kit	179793SRS	28.55	Spot Resist Stainless	Hose guide
178894ORB	373.00	Oil Rubbed Bronze	Spout kit	179827	25.95	Chrome	Handle kit
178896	246.25	Chrome	Spout kit	179828	7.00	Chrome	Lift rod kit
178896BN	357.05	Brushed Nickel	Spout kit	179829	9.95	Chrome	Lift rod kit
178896ORB	392.75	Oil Rubbed Bronze	Spout kit	179830	33.25	Chrome	Handle kit
179084	36.55	Chrome	Handle kit	179831	211.95	Chrome	Spout kit
179084ORB	56.10	Oil Rubbed Bronze	Handle kit	179832	11.35	Chrome	Handle adapter kit
179084SRS	47.35	Spot Resist Stainless	Handle kit	179833	12.35	Chrome	Escutcheon
179085	85.20	Chrome	Spout kit	179834	13.85	Chrome	Shower arm flange
179085ORB	139.60	Oil Rubbed Bronze	Spout kit	179836	39.70	Chrome	Escutcheon & gasket kit
179085SRS	160.40	Spot Resist Stainless	Spout kit	179837	31.40	Chrome	Handle kit
179086	47.30	Chrome	Side spray kit	179877	8.10	N/A or Unfinished	O-ring kit
179086ORB	64.45	Oil Rubbed Bronze	Side spray kit	179878	5.05	N/A or Unfinished	Gasket
179086SRS	54.70	Spot Resist Stainless	Side spray kit	179879	17.75	N/A or Unfinished	Waterway
179353ORB	22.05	Oil Rubbed Bronze	Aerator	180059	83.85	N/A or Unfinished	Wand kit
179353SRS	17.80	Spot Resist Stainless	Aerator	180059SRS	88.65	Spot Resist Stainless	Wand kit
179354	188.05	Chrome	Lift rod kit	180073	38.45	Chrome	Diverter rod kit
179354BN	263.25	Brushed Nickel	Lift rod kit	180073BN	53.80	Brushed Nickel	Diverter rod kit
179354NL	263.25	Polished Nickel	Lift rod kit	180073NL	53.80	Polished Nickel	Diverter rod kit
179354ORB	289.60	Oil Rubbed Bronze	Lift rod kit	180073ORB	59.20	Oil Rubbed Bronze	Diverter rod kit
179572	83.20	N/A or Unfinished	Data cable	180157	7.65	N/A or Unfinished	Aerator kit
179573	65.00	N/A or Unfinished	Battery kit	180158	9.35	N/A or Unfinished	Aerator kit
179574	41.20	Chrome	Wand kit	180823	5.25	N/A or Unfinished	Washer
179639	13.25	N/A or Unfinished	Filter	181007	11.65	N/A or Unfinished	Aerator kit
179640	26.25	N/A or Unfinished	O-ring kit	181040	14.95	N/A or Unfinished	Adapter kit
179645	46.15	Chrome	Wand kit	181066BN	8.80	Brushed Nickel	Aerator
179645ORB	81.05	Oil Rubbed Bronze	Wand kit	181085	9.55	Chrome	Aerator
179645SRS	55.70	Spot Resist Stainless	Wand kit	181087BN	16.65	Brushed Nickel	Aerator kit
179655	30.80	Chrome	Handle kit	181089	37.00	Chrome	Aerator kit
179655ORB	42.50	Oil Rubbed Bronze	Handle kit	181106	57.05	Chrome	Handle kit
179655SRS	40.10	Spot Resist Stainless	Handle kit	181106BC	68.50	Brushed Chrome	Handle kit
179656	45.40	Chrome	Wand kit	181107	57.05	Chrome	Handle kit
179656ORB	62.65	Oil Rubbed Bronze	Wand kit	181107BC	68.50	Brushed Chrome	Handle kit
179656SRS	59.00	Spot Resist Stainless	Wand kit	181250	69.50	Black	Mounting kit
179657	138.70	Chrome	Spout receptor kit				
179657ORB	180.35	Oil Rubbed Bronze	Spout receptor kit				
179657SRS	191.40	Spot Resist Stainless	Spout receptor kit				
179675	20.05	Chrome	Handle kit				
179675SRN	28.05	Spot Resist Brushed Nickel	Handle kit				
179781	15.10	Chrome	Lift rod kit				
179781BN	19.90	Brushed Nickel	Lift rod kit				
179782	44.75	Chrome	Handle kit				

Moen Genuine Parts

Listed in numerical order

Part Number	List Price	Finish	Description	Part Number	List Price	Finish	Description
181500	31.65	Chrome	Escutcheon	183296SRS	71.75	Spot Resist Stainless	Handle kit
181500BN	42.80	Brushed Nickel	Escutcheon	183297	88.70	Chrome	Wand kit
181500NL	42.80	Polished Nickel	Escutcheon	183297SRS	108.20	Spot Resist Stainless	Wand kit
181500ORB	47.00	Oil Rubbed Bronze	Escutcheon	183298	31.25	Chrome	Receptor
181500WR	47.00	Wrought Iron	Escutcheon	183298SRS	39.25	Spot Resist Stainless	Receptor
181502	27.15	Chrome	Escutcheon	183570	31.15	Chrome	Slider for slide bar
181502BN	36.65	Brushed Nickel	Escutcheon	183570BL	46.70	Matte Black	Slider for slide bar
181502ORB	40.40	Oil Rubbed Bronze	Escutcheon	183570BN	45.15	Brushed Nickel	Slider for slide bar
181600	75.75	Chrome	Handle kit	183570ORB	46.70	Oil Rubbed Bronze	Slider for slide bar
181600BN	102.25	Brushed Nickel	Handle kit	183598	20.55	Chrome	Handle kit
181602	38.55	Chrome	Handle kit	183599	4.90	N/A or Unfinished	Screw kit
181602BN	52.00	Brushed Nickel	Handle kit	183732	12.30	N/A or Unfinished	Aerator kit
181602NL	52.00	Polished Nickel	Handle kit	183810	46.05	Chrome	Handle kit
181602ORB	57.30	Oil Rubbed Bronze	Handle kit	183961	33.30	N/A or Unfinished	3 4 inlet nipple nut oring
181603	86.25	Chrome	Handle kit	183962	28.85	N/A or Unfinished	Filter
181603BN	116.50	Brushed Nickel	Handle kit	183963	14.80	N/A or Unfinished	Controller mounting hardware
181603NL	116.50	Polished Nickel	Handle kit	183964	31.40	N/A or Unfinished	1 2 inlet nipple nut oring kit
181603ORB	128.15	Oil Rubbed Bronze	Handle kit	183965	32.90	N/A or Unfinished	1 2 outlet nipple nut oring
181603WR	128.15	Wrought Iron	Handle kit	183966	110.45	N/A or Unfinished	Data cable adapters
181929	149.20	Chrome	Swing arm	183969	16.80	N/A or Unfinished	Controller mounting bracket
181929SRS	189.65	Spot Resist Stainless	Swing arm	183972	41.60	N/A or Unfinished	Ac adapter
181930	78.15	Chrome	Spring spout & bearing	184081	36.10	Chrome	Handle kit
181930SRS	106.80	Spot Resist Stainless	Spring spout & bearing	184082	9.80	N/A or Unfinished	Aerator kit
182074	374.60	Chrome	Roman tub spout kit	184083	10.45	N/A or Unfinished	Aerator kit
182074BN	524.40	Brushed Nickel	Roman tub spout kit	184084	5.55	N/A or Unfinished	Hot/cold indicator kit
182074NL	524.40	Polished Nickel	Roman tub spout kit	184085	123.75	Chrome	Spout kit
182074ORB	576.80	Oil Rubbed Bronze	Roman tub spout kit	184086	144.00	Chrome	Spout kit
182191	5.90	N/A or Unfinished	Aerator	184445BN	48.05	Brushed Nickel	Handle kit
182212	118.25	Chrome	Spout kit	184445ORB	52.85	Oil Rubbed Bronze	Handle kit
182212BN	159.55	Brushed Nickel	Spout kit	184450	33.55	Chrome	Handle kit
182212ORB	175.05	Oil Rubbed Bronze	Spout kit	184450BN	46.90	Chrome	Handle kit
182213	114.80	Chrome	Spout kit	184597	47.75	Chrome	Handle kit
182213BN	142.05	Brushed Nickel	Spout kit	184608	8.20	Chrome	O-ring kit
182213ORB	172.70	Oil Rubbed Bronze	Spout kit	184618	284.85	Chrome	Roman tub spout kit
182244	35.85	Chrome	Handle kit	185807	39.30	Chrome	Handle kit
182244BN	50.20	Brushed Nickel	Handle kit	185807BN	47.50	Brushed Nickel	Handle kit
182244ORB	55.20	Oil Rubbed Bronze	Handle kit	185807ORB	50.75	Oil Rubbed Bronze	Handle kit
182496	33.85	Chrome	Handle kit	185808	15.40	Chrome	Lift rod kit
182496BN	47.35	Brushed Nickel	Handle kit	185808BN	18.80	Brushed Nickel	Lift rod kit
182496NL	47.35	Polished Nickel	Handle kit	185808ORB	19.40	Oil Rubbed Bronze	Lift rod kit
182496ORB	52.10	Oil Rubbed Bronze	Handle kit	185809	7.65	N/A or Unfinished	O-ring kit
182546	31.85	N/A or Unfinished	Service kit	185810	39.35	Chrome	Escutcheon
182624	27.10	N/A or Unfinished	Adapter kit	185810BN	46.35	Brushed Nickel	Escutcheon
182632BL	33.30	Matte Black	Escutcheon & gasket kit	185810ORB	48.25	Oil Rubbed Bronze	Escutcheon
182632BN	32.25	Brushed Nickel	Escutcheon & gasket kit	185811	37.05	Chrome	Handle kit
182632ORB	33.30	Oil Rubbed Bronze	Escutcheon & gasket kit	185811BN	45.05	Brushed Nickel	Handle kit
182633BL	70.80	Matte Black	Hardware kit	185811ORB	77.25	Oil Rubbed Bronze	Handle kit
182633BN	68.40	Brushed Nickel	Hardware kit	185812	16.35	Chrome	Lift rod kit
182633ORB	70.80	Oil Rubbed Bronze	Hardware kit	185812BN	19.40	Brushed Nickel	Lift rod kit
182636BL	7.25	Matte Black	Cap kit	185812ORB	20.55	Oil Rubbed Bronze	Lift rod kit
182636BN	7.00	Brushed Nickel	Cap kit	185813	16.25	Chrome	Spout cap kit
182636ORB	7.25	Oil Rubbed Bronze	Cap kit	185813BN	37.50	Brushed Nickel	Spout cap kit
182637BL	35.20	Matte Black	Diverter knob kit	185813ORB	38.15	Oil Rubbed Bronze	Spout cap kit
182637BN	34.00	Brushed Nickel	Diverter knob kit	185814	17.30	Chrome	Lift rod kit
182637ORB	35.20	Oil Rubbed Bronze	Diverter knob kit	185814BN	21.60	Brushed Nickel	Lift rod kit
182719	14.95	Chrome	Aerator	185814ORB	22.50	Oil Rubbed Bronze	Lift rod kit
182843	15.65	Chrome	Lift rod kit	185815	43.40	Chrome	Handle kit
182843BN	18.65	Brushed Nickel	Lift rod kit	185815BN	53.65	Brushed Nickel	Handle kit
182862	56.60	Chrome	Escutcheon	185815ORB	84.30	Oil Rubbed Bronze	Handle kit
182862BN	75.95	Brushed Nickel	Escutcheon	185816	138.45	Chrome	Spout kit
183073	12.45	N/A or Unfinished	Spacer kit	185816BN	178.40	Brushed Nickel	Spout kit
183082	23.00	N/A or Unfinished	Spacer kit	185816ORB	185.20	Oil Rubbed Bronze	Spout kit
183196ORB	34.30	Oil Rubbed Bronze	Handle kit				
183245	12.05	N/A or Unfinished	Aerator kit				
183296	57.80	Chrome	Handle kit				

Moen Genuine Parts

Listed in numerical order

Part Number	List Price	Finish	Description	Part Number	List Price	Finish	Description
185817	232.30	Chrome	Spout kit	221641BN	101.85	Brushed Nickel	Handle kit
185817BN	303.00	Brushed Nickel	Spout kit	221641NL	112.05	Polished Nickel	Handle kit
185817ORB	310.60	Oil Rubbed Bronze	Spout kit	221641ORB	112.05	Oil Rubbed Bronze	Handle kit
185818	215.80	Chrome	Spout kit	221642	72.90	Chrome	Handle kit
185818BN	280.90	Brushed Nickel	Spout kit	221642BN	105.70	Brushed Nickel	Handle kit
185818ORB	300.15	Oil Rubbed Bronze	Spout kit	221642NL	112.30	Polished Nickel	Handle kit
185819	20.20	Chrome	Diverter rod kit	221642ORB	112.30	Oil Rubbed Bronze	Handle kit
185819BN	25.60	Brushed Nickel	Diverter rod kit	221672	22.80	Chrome	Chrome handle cap
185819ORB	26.35	Oil Rubbed Bronze	Diverter rod kit	221672BN	30.30	Brushed Nickel	Brushed nickel handle cap
185821	30.65	Chrome	Handle kit	221672NL	30.30	Polished Nickel	Polished nickel handle cap
185821BN	41.40	Brushed Nickel	Handle kit	221672ORB	33.50	Oil Rubbed Bronze	Oil rubbed bronze handle cap
185821ORB	43.60	Oil Rubbed Bronze	Handle kit	221673	15.45	Chrome	Handle cap kit
185823	27.00	Chrome	Escutcheon	221673BN	20.60	Brushed Nickel	Handle cap kit
185823BN	33.60	Brushed Nickel	Escutcheon	221673NL	20.60	Polished Nickel	Handle cap kit
185823ORB	35.35	Oil Rubbed Bronze	Escutcheon	221673ORB	22.75	Oil Rubbed Bronze	Handle cap kit
185834	28.35	Chrome	Escutcheon	221772	14.65	Chrome	Handle cap kit
185834BN	54.70	Brushed Nickel	Escutcheon	221772BN	19.45	Brushed Nickel	Handle cap kit
185834ORB	78.25	Oil Rubbed Bronze	Escutcheon	222307	20.95	Stainless	Easy clean drain assembly
186589	9.30	N/A or Unfinished	Plastic Drain Stopper	222900	8.65	Chrome	Plug button kit
186948	10.00	N/A or Unfinished	Service kit	222900SL	10.35	Stainless	Plug button kit
187073	46.30	Chrome	Deck plate	222900WR	10.80	Wrought Iron	Plug button kit
187728	37.30	Chrome	Wand kit	252001	31.55	Chrome	Handle kit
187728SRS	47.40	Spot Resist Stainless	Wand kit	252001BN	40.90	Brushed Nickel	Handle kit
187729	25.95	Chrome	Handle kit	252002	30.40	Chrome	Handshower cradle
187729SRS	33.05	Spot Resist Stainless	Handle kit	252002BN	40.90	Brushed Nickel	Handshower cradle
188029	24.05	Chrome	Handle kit	252004	37.45	Chrome	Diverter knob kit
188029SRS	40.50	Chrome	Handle kit	252004BN	46.15	Brushed Nickel	Diverter knob kit
188030	24.90	Chrome	Handle kit	252005	23.00	N/A or Unfinished	Cartridge
188030SRS	32.20	Spot Resist Stainless	Handle kit	252006	43.45	N/A or Unfinished	Cartridge sleeve
190102	40.75	Chrome	Hot handle kit	252006BN	53.65	Brushed Nickel	Cartridge sleeve
190102BN	57.05	Brushed Nickel	Hot handle kit	252007	46.15	N/A or Unfinished	Cartridge nut
190102ORB	62.80	Oil Rubbed Bronze	Hot handle kit	252008	154.80	N/A or Unfinished	Bracket
190112	33.95	Chrome	Lift rod kit	252009	201.20	N/A or Unfinished	Manifold
190112BN	47.50	Brushed Nickel	Lift rod kit	252010	124.15	Chrome	Diverter kit
190112ORB	52.25	Oil Rubbed Bronze	Lift rod kit	252010BN	152.90	Chrome	Diverter kit
190202	47.95	Chrome	Handle kit	259416	128.45	Chrome	Service kit
190202BN	67.15	Brushed Nickel	Handle kit	259416BN	162.15	Brushed Nickel	Service kit
190202ORB	73.80	Oil Rubbed Bronze	Handle kit	259417	52.05	N/A or Unfinished	Screw kit
190322	264.05	Chrome	Roman tub spout kit	259418	40.50	N/A or Unfinished	Screw kit
190322BN	369.75	Brushed Nickel	Roman tub spout kit	259419	60.20	Chrome	Handle hub kit
190322ORB	406.75	Oil Rubbed Bronze	Roman tub spout kit	259419BN	74.00	Brushed Nickel	Handle hub kit
190444	26.40	Chrome	Escutcheon	259420	8.45	N/A or Unfinished	Screw kit
190444BN	37.00	Brushed Nickel	Escutcheon	259421	166.85	N/A or Unfinished	Mounting kit
190444ORB	40.75	Oil Rubbed Bronze	Escutcheon	259422	168.40	N/A or Unfinished	Mounting kit
190503	52.35	Chrome	Handle kit	259423	235.80	Chrome	Service kit
190503BN	73.40	Brushed Nickel	Handle kit	259423BN	297.95	Brushed Nickel	Service kit
190503ORB	80.70	Oil Rubbed Bronze	Handle kit	259424	5.10	N/A or Unfinished	O-ring kit
197000	4.05	N/A or Unfinished	Screw kit	262000	107.50	Chrome	Handle kit
197001	31.35	N/A or Unfinished	Shank kit	262000BN	130.30	Brushed Nickel	Handle kit
197002	18.85	N/A or Unfinished	Stem extension kit	262001	33.15	Chrome	Handle kit
197003	19.75	N/A or Unfinished	Handle adapter kit	262001BN	51.25	Brushed Nickel	Handle kit
197004	15.25	N/A or Unfinished	Stem extension kit	262002	49.60	Chrome	Handle hub
200001	385.55	Chrome	Roman tub spout kit	262002BN	61.50	Brushed Nickel	Handle hub
200001BN	474.25	Brushed Nickel	Roman tub spout kit	262003	76.20	N/A or Unfinished	Handle adapter kit
200006	28.40	N/A or Unfinished	Bracket	262004	53.65	Chrome	Escutcheon
200007	11.20	N/A or Unfinished	Mounting hardware	262004BN	64.35	Brushed Nickel	Escutcheon
200008	72.15	N/A or Unfinished	Mounting plate	262005	268.05	Chrome	Handshower cradle
200009	58.85	N/A or Unfinished	Mounting plate	262005BN	334.65	Brushed Nickel	Handshower cradle
200010	105.75	N/A or Unfinished	Bracket extension	262006	30.00	Chrome	Escutcheon
200011	85.70	N/A or Unfinished	Bracket extension	262006BN	42.05	Brushed Nickel	Escutcheon
200012	26.20	N/A or Unfinished	Riser cover	262007	145.25	N/A or Unfinished	Manifold
200013	22.95	N/A or Unfinished	Riser cover	262008	128.60	N/A or Unfinished	Bracket
216711	6.95	N/A or Unfinished	Flow restrictor kit				
216721	6.95	N/A or Unfinished	Flow restrictor kit				
221641	72.90	Chrome	Handle kit				

Moen Genuine Parts

Listed in numerical order

Part Number	List Price	Finish	Description
262955	94.80	N/A or Unfinished	Shank kit
262956	1.25	N/A or Unfinished	O-ring kit
316711	6.95	N/A or Unfinished	Flow restrictor kit
316721	10.45	N/A or Unfinished	Aerator
344112SRS	78.80	Spot Resist Stainless	Spout kit
344114SRS	93.50	Spot Resist Stainless	Spout kit
400102	7.05	N/A or Unfinished	Disposal unjamming wrench
416711	6.95	N/A or Unfinished	Flow restrictor kit
516711	6.95	N/A	Aerator flow restrictor, 0.5 gpm
716711	6.90	N/A or Unfinished	Aerator
840011	86.50	Chrome	Handle cap kit
840011CBN	129.75	Classic Brushed Nickel	Handle cap kit
840012	86.50	Chrome	Handle cap kit
840012CBN	129.75	Classic Brushed Nickel	Handle cap kit
840013	21.05	N/A or Unfinished	Cartridge nut
840014	44.15	N/A or Unfinished	Cartridge nut
840015F03	13.15	Chrome	Aerator
840015F05	13.15	Chrome	Aerator
840015F15	13.15	Chrome	Aerator
840015F22	13.15	Chrome	Aerator
840016	44.50	N/A or Unfinished	Back flow preventor kit
870111	119.65	Chrome	Spout kit
870112	13.85	Chrome	Escutcheon
870113	46.55	Chrome	Deck plate
870114	119.65	Chrome	Spout kit
870115	123.10	Chrome	Spout kit
870116	135.60	Chrome	Escutcheon
870121	108.90	Chrome	Spout kit
A704OWB	25.05	Old World Bronze	Arm and flange
A705	52.50	Chrome	Shower arm flange
A705CBN	78.75	Classic Brushed Nickel	Shower arm flange
A714WR	63.30	Wrought Iron	Vacuum breaker kit
A2020	134.10	Chrome	Extension kit
A2020BN	192.10	Brushed Nickel	Extension kit
ASB-4201	12.95	N/A or Unfinished	Air switch service part
AT2199SLP	14.40	Brushed Platinum	Shower arm flange
CA3919	14.15	Chrome	Aerator
CA3924	14.15	Chrome	Aerator
CL703	78.40	Chrome	Shower arm diverter
CL703BN	113.70	Brushed Nickel	Shower arm diverter
CL703ORB	125.10	Oil Rubbed Bronze	Shower arm diverter
CL707	106.45	Chrome	Shower arm diverter
CL707BN	154.30	Brushed Nickel	Shower arm diverter
CL707ORB	169.80	Oil Rubbed Bronze	Shower arm diverter
CL6302	85.70	Chrome	Showerhead
CL6302BN	133.85	Brushed Nickel	Showerhead
CL6302EP	85.70	Chrome	Showerhead, 1.75 GPM
CL6302EPBN	133.85	Brushed Nickel	Showerhead, 1.75 GPM
CL6303	47.40	Chrome	Showerhead
CL6303BN	72.60	Brushed Nickel	Showerhead
CL6303EP	47.40	Chrome	Showerhead, 1.75 GPM
CL6303EPBN	72.60	Brushed Nickel	Showerhead, 1.75 GPM
CL10154	27.40	Chrome	6" shower arm and flange
CL10154BN	55.55	Brushed Nickel	6" shower arm and flange
CL26500	50.45	Chrome	5 Function Showerhead
CL26500BN	82.35	Brushed Nickel	5 Function Showerhead
CL26500EP	50.45	Chrome	5 Function Showerhead 2.0 GPM
CL26500EPBN	82.35	Brushed Nickel	5 Function Showerhead 2.0 GPM

Part Number	List Price	Finish	Description
CL123815	34.45	Chrome	8" Shower Arm & Flange
CL123815BN	64.90	Brushed Nickel	8" Shower Arm & Flange
CL145058	17.80	N/A or Unfinished	Adapter kit
CL155694	22.65	Chrome	Handshower wall bracket
CL155694BN	32.70	Brushed Nickel	Handshower wall bracket
CL155747	58.70	Chrome	Handshower, 2.0 GPM
CL155747BN	85.15	Brushed Nickel	Handshower, 2.0 GPM
CL155748	35.00	Chrome	59" Shower Hose
CL155748BN	50.85	Brushed Nickel	59" Shower Hose
CL164928	70.10	Chrome	4 Function Handshower
CL164928BN	101.60	Brushed Nickel	Brushed nickel eco-performance handshower
CLA701	46.00	Chrome	Shower arm cradle
CLA701BN	66.60	Brushed Nickel	Shower arm cradle
S3896	95.30	Chrome	Chrome diverter spouts
S3896BN	138.20	Chrome	Chrome diverter spouts
S3901	115.65	Chrome	Chrome nondiverter spouts
SK1711	3.50	N/A or Unfinished	Retainer clip

BULK

Bulk Pack

Integra® One-Handle Kitchen Faucet / 67315
2200™ Series Drop-In Double/Equal Bowl Sink / BG222173

Please see moen.com/consumer-support/warranty
for complete product warranty information.

Table of Contents

- 438 Kitchen
- 440 Bathroom
- 444 Moentrol® Showering Rough-in Valves and Trim
- 445 Posi-Temp® Showering Rough-in Valves and Trim
- 456 Non-Pressure Balancing Showering

MOEN® BULK-PACK

Bulk-Pack gives you everything you need for on-site installation: kitchen, lavatory, roman tub, tub/shower faucets and stainless steel sinks in case lots.

Each kitchen and lavatory faucet carton contains individually packaged faucets ready for installation.



Roman tub and tub/shower faucets come packaged in two cartons. The rough-in valves are in one carton, the finish trim in another carton. This helps you avoid losing or damaging the trim.









Each carton is labeled for easy identification.

CROSS-REFERENCE For Bulk Pack Faucets and Valves**CROSS-REFERENCE TABLE**

	Single Pack	Bulk Pack
Kitchen	7425	67425
Kitchen	7430	67430
Kitchen	7434	67434
Kitchen	7840	67840
Kitchen	7900	67900
Kitchen	7910	67910
Kitchen	67315C	67315C
Kitchen	67315SRS	67315SRS
Valves	2510	62300
Valves	2520	62320
Valves	2570	62370
Valves	2580	62380
Valves	2590	62390
Valves	3570	63170
Valves	9000	69000
Tub/Shower	T2131	T62131
Tub/Shower	T2132	T62132
Tub/Shower	T2133	T62133
Tub/Shower	T2151	T62151
Tub/Shower	T2152	T62152
Tub/Shower	T2153	T62153
Tub/Shower	T2182	T62182
Tub/Shower	T2183	T62183
Tub/Shower	T2742	T62742
Tub/Shower	T2743	T62743
Tub/Shower	2352	T182 + 62320
Tub/Shower	L2352	TL182 + 62300
Tub/Shower	2353	T183 + 62320
Tub/Shower	L2353	TL183 + 62300
Tub/Shower	L2361	TL181 + 62370
Tub/Shower	L2362	TL182 + 62370
Tub/Shower	2363	T183 + 62370
Tub/Shower	L2363	TL183 + 62370
Bathroom Sink Faucet	L4601	L64601
Bathroom Sink Faucet	L4621	L64620
Bathroom Sink Faucet	L4625	L64624
Bathroom Sink Faucet	4925	64925
Bathroom Sink Faucet	6172	66172
Bathroom Sink Faucet	6410	66410
Bathroom Sink Faucet	6610	66610
Bathroom Sink Faucet	6802	66802
Bathroom Sink Faucet	6810	66810

BULK Kitchen Faucets

Must order in Case Quantity.

		MODEL NUMBER	LIST PRICE	FINISH/ CONNECTION	CASE QTY
CAMERIST®	ONE-HANDLE PULLOUT KITCHEN FAUCET				
	<ul style="list-style-type: none"> • application: one or three hole • overall height: 12.00" • connection size: 3/8" • connection type: compression • number of functions: two-function • spray type: powerful cleaning rinse; aerated stream • water usage: 1.5 gpm (5.7 L/min) max. • hose length: 68" • deckplate: included 	67545C	314.90	Chrome	3
		 reflex POWERCLEAN DURALOCK DURALAST			
INTEGRA®	ONE-HANDLE PULLOUT KITCHEN FAUCET				
	<ul style="list-style-type: none"> • application: one or three hole • overall height: 10.63" • connection size: 3/8" • connection type: compression • number of functions: two-function • spray type: powerful cleaning rinse; aerated stream • water usage: 1.5 gpm (5.7 L/min) max. • hose length: 59" • deckplate: included 	67315C	239.05	Chrome	6
		67315SRS ●	337.90	Spot Resist Stainless	6
	 POWERCLEAN DURALOCK DURALAST				
CAMERIST®	ONE-HANDLE KITCHEN FAUCET				
	<ul style="list-style-type: none"> • application: two to four hole • overall height: 8.13" • connection size: 3/8" • connection type: compression • water usage: 1.5 gpm (5.7 L/min) max. • deckplate: included • side spray: included 	67840	198.05	Chrome	6
		 DURALOCK DURALAST			







BULK

NOTES

- Spot Resist Stainless Finish 
- reflex** Self-Retracting Spray Hose
- POWERCLEAN** Power Clean™ Technology
- DURALOCK** Duralock® Quick Connections
- DURALAST** Duralast® Cartridge

BULK Kitchen Faucets

Must order in Case Quantity.

		MODEL NUMBER	LIST PRICE	FINISH/ CONNECTION	CASE QTY
CHATEAU®	ONE-HANDLE KITCHEN FAUCET				
	<ul style="list-style-type: none"> • application: three hole • overall height: 8.50" • connection size: 3/8" • connection type: compression • water usage: 1.5 gpm (5.7 L/min) max.  DURALAST®	67425	129.95	Chrome	6
	<ul style="list-style-type: none"> • application: four hole • overall height: 8.50" • connection size: 3/8" • connection type: compression • water usage: 1.5 gpm (5.7 L/min) max. • side spray: included  DURALOCK® DURALAST®	67430	163.30	Chrome	6
	<ul style="list-style-type: none"> • application: three hole • overall height: 8.50" • connection size: 3/8" • connection type: compression • water usage: 1.5 gpm (5.7 L/min) max. • side spray: included  DURALOCK® DURALAST®	67434	163.30	Chrome	6
CHATEAU®	TWO-HANDLE KITCHEN FAUCET				
	<ul style="list-style-type: none"> • application: three hole • overall height: 6.50" • connection size: 1/2" • connection type: IPS • water usage: 1.5 gpm (5.7 L/min) max. 	67900	96.05	Chrome	12
	<ul style="list-style-type: none"> • application: three hole • overall height: 6.50" • connection size: 1/2" • connection type: IPS • water usage: 1.5 gpm (5.7 L/min) max. 	67901	98.10	Chrome	12















BULK**NOTES**

DURALOCK® Duralock® Quick Connections

DURALAST® Duralast® Cartridge

BULK Bathroom Faucets

Must order in Case Quantity.

		MODEL NUMBER	LIST PRICE	FINISH/ CONNECTION	CASE QTY
	BRANTFORD® ONE-HANDLE BATHROOM FAUCET	66600	183.25	Chrome	6
	<ul style="list-style-type: none"> • application: one or three hole • supply line length: flexible • connection size: 3/8" • connection type: compression • deckplate: included • drain assembly: 50% plastic/50% metal • drain assembly type: lift rod   DURALAST®				
	METHOD™ ONE-HANDLE BATHROOM FAUCET	66810	192.60	Chrome	6
	<ul style="list-style-type: none"> • application: one or three hole • supply line length: flexible • connection size: 3/8" • connection type: compression • deckplate: included • drain assembly: 50% plastic/50% metal • drain assembly type: lift rod   DURALAST®				
	CHATEAU® ONE-HANDLE BATHROOM FAUCET	64601	117.65	Chrome	12
	<ul style="list-style-type: none"> • application: three hole • center dimensions: 4" center • connection size: 1/2" • connection type: IPS • drain assembly: drain not included  DURALAST®				
		64620	153.55	Chrome	12
	<ul style="list-style-type: none"> • application: three hole • center dimensions: 4" center • connection size: 1/2" • connection type: IPS • drain assembly: metal • drain assembly type: lift rod  DURALAST®				
		64621	144.65	Chrome	12
	<ul style="list-style-type: none"> • application: three hole • center dimensions: 4" center • connection size: 1/2" • connection type: IPS • drain assembly: 50% plastic/50% metal • drain assembly type: lift rod  DURALAST®				
		64625	146.15	Chrome	12
	<ul style="list-style-type: none"> • application: three hole • center dimensions: 4" center • supply line length: flexible • connection size: 3/8" • connection type: compression • drain assembly: 50% plastic/50% metal • drain assembly type: lift rod  DURALAST®				



















BULK

NOTES

DURALAST® Duralast® Cartridge

BULK Bathroom Faucets

Must order in Case Quantity.

		MODEL NUMBER	LIST PRICE	FINISH/ CONNECTION	CASE QTY
CHATEAU®	ONE-HANDLE BATHROOM FAUCET				
	<ul style="list-style-type: none"> • application: three hole • center dimensions: 4" center • supply line length: flexible • connection size: 3/8" • connection type: compression • drain assembly: drain not included 	L64600	117.65	Chrome	12
		DURALAST®			
	<ul style="list-style-type: none"> • application: three hole • center dimensions: 4" center • connection size: 1/2" • connection type: IPS • drain assembly: drain not included 	L64601	117.65	Chrome	12
		DURALAST®			
	<ul style="list-style-type: none"> • application: three hole • center dimensions: 4" center • connection size: 1/2" • connection type: IPS • drain assembly: metal • drain assembly type: lift rod 	L64620	153.55	Chrome	12
		DURALAST®			
	<ul style="list-style-type: none"> • application: three hole • center dimensions: 4" center • connection size: 1/2" • connection type: IPS • drain assembly: 50% plastic/50% metal • drain assembly type: lift rod 	L64621	144.65	Chrome	12
		DURALAST®			
	<ul style="list-style-type: none"> • application: three hole • center dimensions: 4" center • supply line length: flexible • connection size: 3/8" • connection type: compression • drain assembly: metal • drain assembly type: lift rod 	L64624	158.00	Chrome	12
		DURALAST®			
	<ul style="list-style-type: none"> • application: three hole • center dimensions: 4" center • supply line length: flexible • connection size: 3/8" • connection type: compression • drain assembly: 50% plastic/50% metal • drain assembly type: lift rod 	L64625	146.15	Chrome	12
		DURALAST®			



















BULK

NOTES

DURALAST® Duralast® Cartridge

BULK Bathroom Faucets

Must order in Case Quantity.















		MODEL NUMBER	LIST PRICE	FINISH/ CONNECTION	CASE QTY
CHATEAU®	ONE-HANDLE BATHROOM FAUCET				
	<ul style="list-style-type: none"> • application: three hole • center dimensions: 4" center • connection size: 1/2" • connection type: IPS • drain assembly: metal • drain assembly type: spring loaded pop-up • red/blue markings: included 	L64635	158.00	Chrome	12
	  DURALAST®				
DARTMOOR™	TWO-HANDLE CENTERSET BATHROOM FAUCET				
	<ul style="list-style-type: none"> • application: three hole • center dimensions: 4" center • connection size: 1/2" • connection type: IPS • drain assembly: 50% plastic/50% metal • drain assembly type: lift rod 	66802	150.25	Chrome	6
	  DURALAST®				
GLYDE™	TWO-HANDLE CENTERSET BATHROOM FAUCET				
	<ul style="list-style-type: none"> • application: three hole • center dimensions: 4" center • connection size: 1/2" • connection type: IPS • drain assembly: 50% plastic/50% metal • drain assembly type: lift rod 	66172	150.25	Chrome	6
	  DURALAST®				
BRANTFORD®	TWO-HANDLE CENTERSET BATHROOM FAUCET				
	<ul style="list-style-type: none"> • application: three hole • center dimensions: 4" center • connection size: 1/2" • connection type: IPS • drain assembly: 50% plastic/50% metal • drain assembly type: lift rod 	66610	150.25	Chrome	6
	  DURALAST®				
EVA®	TWO-HANDLE CENTERSET BATHROOM FAUCET				
	<ul style="list-style-type: none"> • application: three hole • center dimensions: 4" center • connection size: 1/2" • connection type: IPS • drain assembly: 50% plastic/50% metal • drain assembly type: lift rod 	66410	150.25	Chrome	6
	  DURALAST®				
	<ul style="list-style-type: none"> • application: three hole • center dimensions: 4" center • connection size: 1/2" • connection type: IPS • drain assembly: 50% plastic/50% metal • drain assembly type: spring loaded pop-up • red/blue markings: included 	66411	150.25	Chrome	6
	  DURALAST®				

NOTES

DURALAST® Duralast® Cartridge

BULK Bathroom Faucets

Must order in Case Quantity.

	MODEL NUMBER	LIST PRICE	FINISH/ CONNECTION	CASE QTY
CHATEAU® TWO-HANDLE CENTERSET BATHROOM FAUCET				
	64900	77.80	Chrome	12
<ul style="list-style-type: none"> • application: three hole • center dimensions: 4" center • connection size: 1/2" • connection type: IPS • drain assembly: drain not included • transitioning to Duralast®: Q2 2018 				
	64919	113.80	Chrome	12
<ul style="list-style-type: none"> • application: three hole • center dimensions: 4" center • connection size: 1/2" • connection type: IPS • drain assembly: metal • drain assembly type: lift rod • transitioning to Duralast®: Q2 2018 				
	64920	109.25	Chrome	12
<ul style="list-style-type: none"> • application: three hole • center dimensions: 4" center • connection size: 1/2" • connection type: IPS • drain assembly: 50% plastic/50% metal • drain assembly type: lift rod • transitioning to Duralast®: Q2 2018 				
	64922	92.00	Chrome	12
<ul style="list-style-type: none"> • application: three hole • center dimensions: 4" center • connection size: 1/2" • connection type: IPS • drain assembly: drain not included   DURALAST®				
	64925	127.60	Chrome	12
<ul style="list-style-type: none"> • application: three hole • center dimensions: 4" center • connection size: 1/2" • connection type: IPS • drain assembly: 50% plastic/50% metal • drain assembly type: lift rod   DURALAST®				
M-PACT® BULK PACK WIDESPREAD VALVE 8" - 16" CENTER 1/2" IPS CONNECTION				
	69000	109.55	1/2" IPS	6
<ul style="list-style-type: none"> • application: three hole • center dimensions: 8" - 16" center • drain assembly: metal • drain assembly type: lift rod  DURALOCK® DURALAST®				

BULK

NOTES

- DURALOCK® Duralock® Quick Connections
- DURALAST® Duralast® Cartridge

BULK Moentrol® Showering

Must order in Case Quantity.

		MODEL NUMBER	LIST PRICE	FINISH/ CONNECTION	CASE QTY
LEGEND®	MOENTROL® TUB/SHOWER				
	<ul style="list-style-type: none"> • showerhead functions: one-function • showerhead type: standard • showerhead size: 2-1/2" diameter spray head • showerhead flow rate: 2.5 gpm (9.5 L/min) max. • spout length: 5 1/2" • spout connection type: slip fit • tub spout type: diverter • valve sold separately  	TL172	82.70	Chrome	12
	<ul style="list-style-type: none"> • showerhead type: showerhead sold separately • spout length: 5 1/2" • spout connection type: slip fit • tub spout type: diverter • valve sold separately  	TL172NH	56.20	Chrome	12
LEGEND®	MOENTROL® SHOWER ONLY				
	<ul style="list-style-type: none"> • showerhead functions: one-function • showerhead type: standard • showerhead size: 2-1/2" diameter spray head • showerhead flow rate: 2.5 gpm (9.5 L/min) max. • valve sold separately  	TL171	50.55	Chrome	12
	<ul style="list-style-type: none"> • showerhead type: showerhead sold separately • valve sold separately  	TL171NH	34.35	Chrome	12
LEGEND®	MOENTROL® VALVE ONLY				
	<ul style="list-style-type: none"> • valve sold separately  	TL170	46.00	Chrome	12
M-PACT®	MOENTROL® VALVE				
	<ul style="list-style-type: none"> • ports: four • adjustable temp limit stop: included • check stops: included • includes: volume control 	63150	181.85	1/2" IPS	12
	<ul style="list-style-type: none"> • ports: four • adjustable temp limit stop: included • check stops: included • includes: volume control 	63170	181.85	1/2" CC	12

HOW TO ORDER A COMPLETE TUB/SHOWER FAUCET

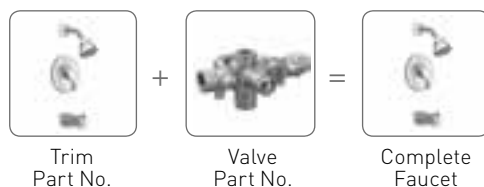











NOTES

 Moen® **M•PACT®** Common Valve System

BULK

BULK Posi-Temp® Showering

Must order in Case Quantity.

		MODEL NUMBER	LIST PRICE	FINISH/ CONNECTION	CASE QTY
DARTMOOR™	POSI-TEMP® TUB/SHOWER				
	<ul style="list-style-type: none"> • showerhead functions: one-function • showerhead type: standard • showerhead size: 4" diameter spray head • showerhead flow rate: 2.5 gpm (9.5 L/min) max. • spout length: 7" • spout connection type: slip fit • tub spout type: diverter • valve sold separately 	T62183	89.80	Chrome	12
GLYDE™	POSI-TEMP® TUB/SHOWER				
	<ul style="list-style-type: none"> • showerhead functions: one-function • showerhead type: standard • showerhead size: 3-3/4" diameter spray head • showerhead flow rate: 2.5 gpm (9.5 L/min) max. • spout length: 7" • spout connection type: slip fit • tub spout type: diverter • valve sold separately 	T62743	89.80	Chrome	6
BRANTFORD®	POSI-TEMP® TUB/SHOWER				
	<ul style="list-style-type: none"> • showerhead functions: one-function • showerhead type: standard • showerhead size: 3-3/8" diameter spray head • showerhead flow rate: 2.5 gpm (9.5 L/min) max. • spout length: 6 1/2" • spout connection type: slip fit • tub spout type: diverter • chrome sold in case qty only: no single pack • valve sold separately 	T62153	89.80	Chrome	12
	<ul style="list-style-type: none"> • showerhead functions: one-function • showerhead type: eco-performance showerhead • showerhead size: 3-3/8" diameter spray head • showerhead flow rate: 1.75 gpm (6.65 L/min) max. • spout length: 6 1/2" • spout connection type: slip fit • tub spout type: diverter • valve sold separately 	T62153EP	89.80	Chrome	12
	<ul style="list-style-type: none"> • showerhead type: showerhead sold separately • spout length: 6 1/2" • spout connection type: slip fit • tub spout type: diverter • chrome sold in case qty only: no single pack • valve sold separately 	T62153NH	76.90	Chrome	12

HOW TO ORDER A COMPLETE TUB/SHOWER FAUCET

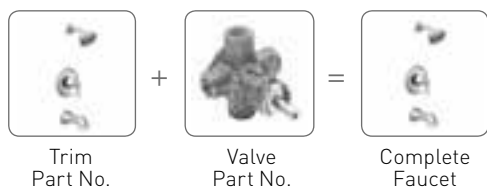











NOTES

 Moen® **M•PACT®** Common Valve System

BULK

BULK Posi-Temp® Showering

Must order in Case Quantity.

		MODEL NUMBER	LIST PRICE	FINISH/ CONNECTION	CASE QTY
EVA®	POSI-TEMP® TUB/SHOWER				
	<ul style="list-style-type: none"> • showerhead functions: one-function • showerhead type: standard • showerhead size: 3-3/8" diameter spray head • showerhead flow rate: 2.5 gpm (9.5 L/min) max. • spout length: 7" • spout connection type: slip fit • tub spout type: diverter • valve sold separately 	T62133	89.80 Chrome	12	
	<ul style="list-style-type: none"> • showerhead functions: one-function • showerhead type: eco-performance showerhead • showerhead size: 3-3/8" diameter spray head • showerhead flow rate: 1.75 gpm (6.65 L/min) max. • spout length: 7" • spout connection type: slip fit • tub spout type: diverter • chrome sold in case qty only: no single pack • valve sold separately 	T62133EP	89.80 Chrome	12	
	<ul style="list-style-type: none"> • showerhead type: showerhead sold separately • spout length: 7" • spout connection type: slip fit • tub spout type: diverter • chrome sold in case qty only: no single pack • valve sold separately 	T62133NH	76.90 Chrome	12	
METHOD™	POSI-TEMP® TUB/SHOWER				
	<ul style="list-style-type: none"> • showerhead functions: one-function • showerhead type: standard • showerhead size: 2-1/2" diameter spray head • showerhead flow rate: 2.5 gpm (9.5 L/min) max. • spout length: 5 7/8" • spout connection type: slip fit • tub spout type: diverter • red/blue markings: included • valve sold separately 	T62803	89.80 Chrome	12	
	<ul style="list-style-type: none"> • showerhead functions: one-function • showerhead type: eco-performance showerhead • showerhead size: 2-1/2" diameter spray head • showerhead flow rate: 1.75 gpm (6.65 L/min) max. • spout length: 5 7/8" • spout connection type: slip fit • tub spout type: diverter • red/blue markings: included • valve sold separately 	T62803EP	89.80 Chrome	12	

BULK

HOW TO ORDER A COMPLETE TUB/SHOWER FAUCET

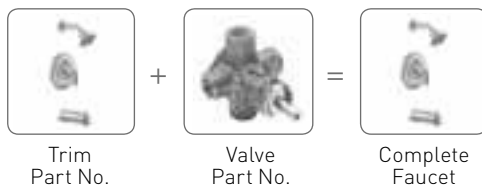









NOTES

 Moen® **M•PACT®** Common Valve System

BULK Posi-Temp® Showering

Must order in Case Quantity.

METHOD™	POSI-TEMP® TUB/SHOWER (CONTINUED)	MODEL NUMBER	LIST PRICE	FINISH/ CONNECTION	CASE QTY
	<ul style="list-style-type: none"> • showerhead type: showerhead sold separately • spout length: 5 7/8" • spout connection type: slip fit • tub spout type: diverter • red/blue markings: included • valve sold separately 	T62803NH	76.90	Chrome	12
	<ul style="list-style-type: none"> • showerhead functions: one-function • showerhead type: standard • showerhead size: 2-1/2" diameter spray head • showerhead flow rate: 2.5 gpm (9.5 L/min) max. • spout length: 5 1/2" • spout connection type: slip fit • tub spout type: diverter • red/blue markings: included • valve sold separately 	T183	61.70	Chrome	12
	<ul style="list-style-type: none"> • showerhead functions: one-function • showerhead type: eco-performance showerhead • showerhead size: 2-1/2" diameter spray head • showerhead flow rate: 1.75 gpm (6.65 L/min) max. • spout length: 5 1/2" • spout connection type: slip fit • tub spout type: diverter • red/blue markings: included • valve sold separately 	T183EP	61.70	Chrome	12
	<ul style="list-style-type: none"> • showerhead functions: one-function • showerhead type: standard • showerhead size: 2-1/2" diameter spray head • showerhead flow rate: 2.5 gpm (9.5 L/min) max. • spout length: 5 1/2" • spout connection type: slip fit • tub spout type: diverter • red/blue markings: included • valve sold separately 	TL183 TL183BC	61.70 101.40	Chrome Brushed Chrome	12 12

HOW TO ORDER A COMPLETE TUB/SHOWER FAUCET

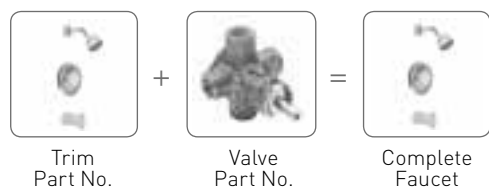

















NOTES

 Moen® **M•PACT®** Common Valve System

BULK

BULK Posi-Temp® Showering

Must order in Case Quantity.

		MODEL NUMBER	LIST PRICE	FINISH/ CONNECTION	CASE QTY
CHATEAU® POSI-TEMP® TUB/SHOWER (CONTINUED)					
	<ul style="list-style-type: none"> • showerhead functions: one-function • showerhead type: eco-performance showerhead • showerhead size: 2-1/2" diameter spray head • showerhead flow rate: 1.75 gpm (6.65 L/min) max. • spout length: 5 1/2" • spout connection type: slip fit • tub spout type: diverter • red/blue markings: included • valve sold separately 	TL183EP	61.70	Chrome	12
		TL183EPBC	95.40	Brushed Chrome	12
  					
	<ul style="list-style-type: none"> • showerhead type: showerhead sold separately • spout length: 5 1/2" • spout connection type: slip fit • tub spout type: diverter • red/blue markings: included • valve sold separately 	TL183NH	54.25	Chrome	12
		TL183NHBC	94.85	Brushed Chrome	12
 					
DARTMOOR™ POSI-TEMP® SHOWER ONLY					
	<ul style="list-style-type: none"> • showerhead functions: one-function • showerhead type: standard • showerhead size: 4" diameter spray head • showerhead flow rate: 2.5 gpm (9.5 L/min) max. • valve sold separately 	T62182	59.60	Chrome	12
 					
GLYDE™ POSI-TEMP® SHOWER ONLY					
	<ul style="list-style-type: none"> • showerhead functions: one-function • showerhead type: standard • showerhead size: 3-3/4" diameter spray head • showerhead flow rate: 2.5 gpm (9.5 L/min) max. • valve sold separately 	T62742	59.60	Chrome	12
 					
BRANTFORD® POSI-TEMP® SHOWER ONLY					
	<ul style="list-style-type: none"> • showerhead functions: one-function • showerhead type: standard • showerhead size: 3-3/8" diameter spray head • showerhead flow rate: 2.5 gpm (9.5 L/min) max. • valve sold separately 	T62152	59.60	Chrome	12
 					

BULK

HOW TO ORDER A COMPLETE TUB/SHOWER FAUCET

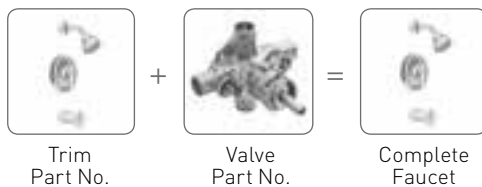

















NOTES

 Moen® **M•PACT®** Common Valve System

BULK Posi-Temp® Showering

Must order in Case Quantity.

		MODEL NUMBER	LIST PRICE	FINISH/ CONNECTION	CASE QTY
BRANTFORD®	POSI-TEMP® SHOWER ONLY (CONTINUED)				
	<ul style="list-style-type: none"> • showerhead functions: one-function • showerhead type: eco-performance showerhead • showerhead size: 3-3/8" diameter spray head • showerhead flow rate: 1.75 gpm (6.65 L/min) max. • spout connection type: not applicable • chrome sold in case qty only: no single pack • valve sold separately 	T62152EP	59.60	Chrome	12
	  				
	<ul style="list-style-type: none"> • showerhead type: showerhead sold separately • chrome sold in case qty only: no single pack • valve sold separately 	T62152NH	56.65	Chrome	12
	 				
EVA®	POSI-TEMP® SHOWER ONLY				
	<ul style="list-style-type: none"> • showerhead functions: one-function • showerhead type: standard • showerhead size: 3-3/8" diameter spray head • showerhead flow rate: 2.5 gpm (9.5 L/min) max. • valve sold separately 	T62132	59.60	Chrome	12
	 				
	<ul style="list-style-type: none"> • showerhead functions: one-function • showerhead type: eco-performance showerhead • showerhead size: 3-3/8" diameter spray head • showerhead flow rate: 1.75 gpm (6.65 L/min) max. • chrome sold in case qty only: no single pack • valve sold separately 	T62132EP	59.60	Chrome	12
	  				
	<ul style="list-style-type: none"> • showerhead type: showerhead sold separately • chrome sold in case qty only: no single pack • valve sold separately 	T62132NH	56.65	Chrome	12
	 				

BULK

HOW TO ORDER A COMPLETE SHOWER FAUCET

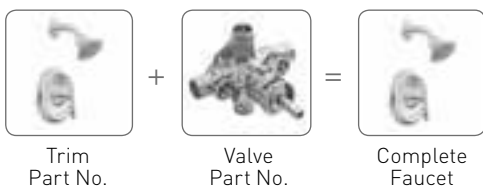











NOTES

 Moen® **M•PACT®** Common Valve System

BULK Posi-Temp® Showering

Must order in Case Quantity.

METHOD™	POSI-TEMP® SHOWER ONLY	MODEL NUMBER	LIST PRICE	FINISH/ CONNECTION	CASE QTY
	<ul style="list-style-type: none"> • showerhead functions: one-function • showerhead type: standard • showerhead size: 2-1/2" diameter spray head • showerhead flow rate: 2.5 gpm (9.5 L/min) max. • red/blue markings: included • valve sold separately 	T62802	59.60	Chrome	12
	<ul style="list-style-type: none"> • showerhead functions: one-function • showerhead type: eco-performance showerhead • showerhead size: 2-1/2" diameter spray head • showerhead flow rate: 1.75 gpm (6.65 L/min) max. • red/blue markings: included • valve sold separately 	T62802EP	59.60	Chrome	12
	<ul style="list-style-type: none"> • showerhead type: showerhead sold separately • red/blue markings: included • valve sold separately 	T62802NH	56.65	Chrome	12
CHATEAU®	POSI-TEMP® SHOWER ONLY				
	<ul style="list-style-type: none"> • showerhead functions: one-function • showerhead type: standard • showerhead size: 2-1/2" diameter spray head • showerhead flow rate: 2.5 gpm (9.5 L/min) max. • red/blue markings: included • valve sold separately 	T182	38.05	Chrome	12
	<ul style="list-style-type: none"> • showerhead functions: one-function • showerhead type: eco-performance showerhead • showerhead size: 2-1/2" diameter spray head • showerhead flow rate: 1.75 gpm (6.65 L/min) max. • red/blue markings: included • valve sold separately 	T182EP	38.05	Chrome	12

BULK

HOW TO ORDER A COMPLETE SHOWER FAUCET

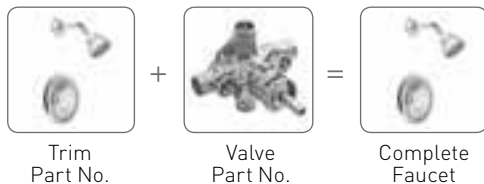







NOTES

 Moen® **M•FACT®** Common Valve System

BULK Posi-Temp® Showering

Must order in Case Quantity.

CHATEAU®		MODEL NUMBER	LIST PRICE	FINISH/ CONNECTION	CASE QTY
POSI-TEMP® SHOWER ONLY (CONTINUED)					
	<ul style="list-style-type: none"> • showerhead functions: one-function • showerhead type: standard • showerhead size: 2-1/2" diameter spray head • showerhead flow rate: 2.5 gpm (9.5 L/min) max. • red/blue markings: included • valve sold separately 	TL182	38.05	Chrome	12
		TL182BC	75.75	Brushed Chrome	12
					
	<ul style="list-style-type: none"> • showerhead functions: one-function • showerhead type: eco-performance showerhead • showerhead size: 2-1/2" diameter spray head • showerhead flow rate: 1.75 gpm (6.65 L/min) max. • red/blue markings: included • valve sold separately 	TL182EP	38.05	Chrome	12
		TL182EPBC	71.30	Brushed Chrome	12
					
	<ul style="list-style-type: none"> • showerhead type: showerhead sold separately • red/blue markings: included • valve sold separately 	TL182NH	36.05	Chrome	12
		TL182NHBC	70.20	Chrome	12
					

BULK

HOW TO ORDER A COMPLETE SHOWER FAUCET

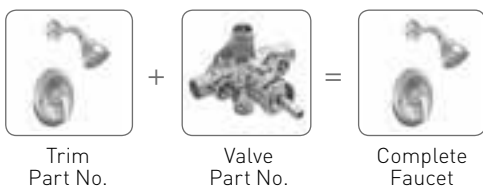

NOTES

 Moen® **M•PACT®** Common Valve System

BULK Posi-Temp® Showering Connections

Must order in Case Quantity.

		MODEL NUMBER	LIST PRICE	FINISH/ CONNECTION	CASE QTY
BRANTFORD®	POSI-TEMP® VALVE ONLY				
	<ul style="list-style-type: none"> • valve sold separately  	T62151	44.35	Chrome	12
EVA®	POSI-TEMP® VALVE ONLY				
	<ul style="list-style-type: none"> • valve sold separately  	T62131	44.35	Chrome	12
CHATEAU®	POSI-TEMP® VALVE ONLY				
	<ul style="list-style-type: none"> • red/blue markings: included • valve sold separately 	T181	34.55	Chrome	12
	<ul style="list-style-type: none"> • red/blue markings: included • valve sold separately  	T187	34.55	Chrome	12
	<ul style="list-style-type: none"> • red/blue markings: included • valve sold separately  	TL181	34.55	Chrome	12

BULK

HOW TO ORDER A COMPLETE SHOWER FAUCET

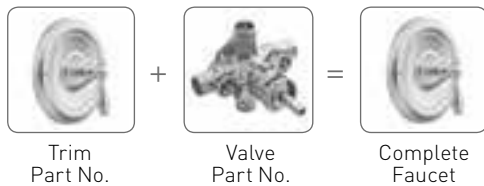















NOTES

 Moen® **M•PACT®** Common Valve System

BULK Posi-Temp® Showering Connections

Must order in Case Quantity.

		MODEL NUMBER	LIST PRICE	FINISH/ CONNECTION	CASE QTY
M-PACT®	POSI-TEMP® VALVE				
	<ul style="list-style-type: none"> • ports: four • adjustable temp limit stop: included 	62300	111.35	1/2" IPS	12
	<ul style="list-style-type: none"> • ports: four • adjustable temp limit stop: included 	62320	111.35	1/2" CC	12
	<ul style="list-style-type: none"> • ports: four • adjustable temp limit stop: included 	FP62320	111.35	1/2" CC	12
	<ul style="list-style-type: none"> • ports: four • adjustable temp limit stop: included • quarter turn stops: included 	62330	147.55	1/2" CPVC	12
	<ul style="list-style-type: none"> • ports: four • adjustable temp limit stop: included 	62340	123.55	1/2" CPVC	12
	<ul style="list-style-type: none"> • ports: three • adjustable temp limit stop: included 	62345	111.35	1/2" CC, IPS	12
	<ul style="list-style-type: none"> • ports: four • adjustable temp limit stop: included • quarter turn stops: included 	62360	135.30	1/2" Crimp ring PEX	12





BULK

NOTES

 Moen® **M-PACT®** Common Valve System

BULK Posi-Temp® Showering Connections

Must order in Case Quantity.









		MODEL NUMBER	LIST PRICE	FINISH/ CONNECTION	CASE QTY
M-PACT®	POSI-TEMP® VALVE (CONTINUED)				
	<ul style="list-style-type: none"> • ports: four • adjustable temp limit stop: included • quarter turn stops: included 	62370	135.30	1/2" CC	12
	<ul style="list-style-type: none"> • ports: four • adjustable temp limit stop: included • quarter turn stops: included • test plug: included 	FP62370	135.30	1/2" CC	12
	<ul style="list-style-type: none"> • ports: four • adjustable temp limit stop: included 	62380	111.35	1/2" Crimp ring PEX	12
	<ul style="list-style-type: none"> • ports: four • adjustable temp limit stop: included • quarter turn stops: included 	62390	135.30	1/2" IPS	12
	<ul style="list-style-type: none"> • ports: four • adjustable temp limit stop: included • test plug: included 	FP62300	111.35	1/2" IPS	12
	<ul style="list-style-type: none"> • ports: four • adjustable temp limit stop: included • test plug: included 	FP62340	123.55	1/2" CPVC	12
	<ul style="list-style-type: none"> • ports: four • adjustable temp limit stop: included • test plug: included 	FP62380	111.35	1/2" Crimp ring PEX	12

NOTES

 Moen® **M•PACT®** Common Valve System

BULK Posi-Temp® Showering Connections

Must order in Case Quantity.

		MODEL NUMBER	LIST PRICE	FINISH/ CONNECTION	CASE QTY
M-PACT®	POSI-TEMP® VALVE (CONTINUED)				
	<ul style="list-style-type: none"> • ports: four • adjustable temp limit stop: included • quarter turn stops: included • test plug: included 	FP62390	135.30	1/2" IPS	12
POSI-TEMP®	POSI-TEMP® VALVE				
	<ul style="list-style-type: none"> • ports: four • adjustable temp limit stop: included 	62365	111.35	1/2" Cold Expansion PEX	12
	<ul style="list-style-type: none"> • ports: four • adjustable temp limit stop: included • test plug: included 	FP62365	111.35	1/2" Cold Expansion PEX	12
	<ul style="list-style-type: none"> • ports: four • adjustable temp limit stop: included • quarter turn stops: included 	62385	135.30	1/2" Cold Expansion PEX	12
	<ul style="list-style-type: none"> • ports: four • adjustable temp limit stop: included • quarter turn stops: included • test plug: included 	FP62385	135.30	1/2" Cold Expansion PEX	12













BULK

NOTES

 Moen® **M•PACT®** Common Valve System

BULK Non-Pressure Balancing Showering Connections

Must order in Case Quantity.

		MODEL NUMBER	LIST PRICE	FINISH/ CONNECTION	CASE QTY
CHATEAU®	ONE-HANDLE NON-PRESSURE BALANCED TUB/SHOWER				
	<ul style="list-style-type: none"> • showerhead functions: one-function • showerhead type: standard • showerhead size: 2-1/2" diameter spray head • showerhead flow rate: 2.5 gpm (9.5 L/min) max. • spout length: 5 1/2" • spout connection type: slip fit • tub spout type: diverter • red/blue markings: included • valve sold separately 	T471	70.80	Chrome	12
					
	<ul style="list-style-type: none"> • showerhead functions: one-function • showerhead type: eco-performance showerhead • showerhead size: 2-1/2" diameter spray head • showerhead flow rate: 1.75 gpm (6.65 L/min) max. • spout length: 5 1/2" • spout connection type: slip fit • tub spout type: diverter • red/blue markings: included • valve sold separately 	T471EP	70.80	Chrome	12
	 				
	<ul style="list-style-type: none"> • showerhead functions: one-function • showerhead type: standard • showerhead size: 2-1/2" diameter spray head • showerhead flow rate: 2.5 gpm (9.5 L/min) max. • spout length: 5 1/2" • spout connection type: slip fit • tub spout type: diverter • red/blue markings: included • valve sold separately 	TL471	70.80	Chrome	12
	 				
	<ul style="list-style-type: none"> • showerhead functions: one-function • showerhead type: eco-performance showerhead • showerhead size: 2-1/2" diameter spray head • showerhead flow rate: 1.75 gpm (6.65 L/min) max. • spout length: 5 1/2" • spout connection type: slip fit • tub spout type: diverter • red/blue markings: included • valve sold separately 	TL471EP	70.80	Chrome	12
	  				

BULK

HOW TO ORDER A COMPLETE STANDARD VALVE

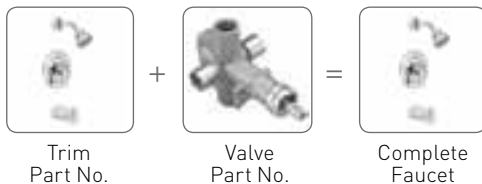













NOTES

 Moen® **M•FACT®** Common Valve System

BULK Non-Pressure Balancing Showering Connections

Must order in Case Quantity.

		MODEL NUMBER	LIST PRICE	FINISH/ CONNECTION	CASE QTY
CHATEAU® ONE-HANDLE NON-PRESSURE BALANCED SHOWER ONLY					
	<ul style="list-style-type: none"> • showerhead functions: one-function • showerhead type: standard • showerhead size: 2-1/2" diameter spray head • showerhead flow rate: 2.5 gpm (9.5 L/min) max. • red/blue markings: included • valve sold separately 	T473	43.75	Chrome	12
					
	<ul style="list-style-type: none"> • showerhead functions: one-function • showerhead type: eco-performance showerhead • showerhead size: 2-1/2" diameter spray head • showerhead flow rate: 1.75 gpm (6.65 L/min) max. • red/blue markings: included • valve sold separately 	T473EP	43.75	Chrome	12
					
	<ul style="list-style-type: none"> • showerhead functions: one-function • showerhead type: standard • showerhead size: 2-1/2" diameter spray head • showerhead flow rate: 2.5 gpm (9.5 L/min) max. • red/blue markings: included • valve sold separately 	TL473	43.75	Chrome	12
					
	<ul style="list-style-type: none"> • showerhead functions: one-function • showerhead type: eco-performance showerhead • showerhead size: 2-1/2" diameter spray head • showerhead flow rate: 1.75 gpm (6.65 L/min) max. • red/blue markings: included • valve sold separately 	TL473EP	43.75	Chrome	12
					

BULK

HOW TO ORDER A COMPLETE STANDARD VALVE

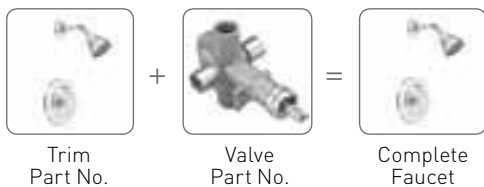









NOTES

 Moen® **M•PACT®** Common Valve System

BULK Non-Pressure Balancing Showering Connections

Must order in Case Quantity.

		MODEL NUMBER	LIST PRICE	FINISH/ CONNECTION	CASE QTY
CHATEAU®	ONE-HANDLE NON-PRESSURE BALANCED VALVE ONLY				
	<ul style="list-style-type: none"> valve sold separately 	T470	36.70	Chrome	12
	<ul style="list-style-type: none"> valve sold separately  	TL470	36.70	Chrome	12
MPACT®	NON-PRESSURE BALANCED VALVE				
	<ul style="list-style-type: none"> ports: four includes: volume control 	62700	101.40	1/2" IPS	12
	<ul style="list-style-type: none"> ports: four 	62720	101.40	1/2" CC	12

BULK

HOW TO ORDER A COMPLETE STANDARD VALVE

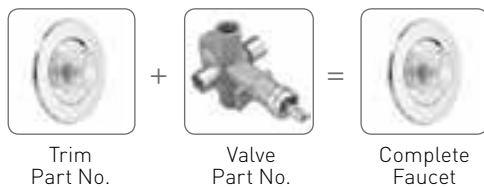

NOTES

 Moen® **M•PACT®** Common Valve System



Commercial Products Catalog 2018

COMMERCIAL

Please see moen.com/consumer-support/warranty
for complete product warranty information.

Products that address your highest priorities.

From leaks and vandalism to normal wear and tear, worries never cease where commercial and institutional fixtures are concerned. That's why Moen® Commercial engineers and designers think of every imaginable scenario — and plan for it in advance. The result is a full line of faucets and valves every facilities manager can rely on from the number one faucet brand in North America.

Our products will help you:

- reduce maintenance costs
- resist vandalism
- save water while maintaining performance
- cut your total cost of ownership

On the pages ahead, we welcome you to discover all the reasons you can count on Moen Commercial to provide the best solutions for your most challenging environments.

Contents

462	M•DURA™ Heavy-Duty Faucets
482	M•PRESS™ Heavy-Duty Metering Faucets
485	M•BITION™ Medium-Duty Faucets
492	M•POWER™ Sensor-Operated Faucets
500	M•POWER™ Sensor-Operated Flush Valves
505	M•DURA™ Heavy-Duty Manual Flush Valves
509	M•DURA™ Heavy-Duty Showering
535	Accessories and Service Kits
540	Suggested List Price

COMMERCIAL

We're here to help you meet every challenge.

Anticipating every need, your Moen® Commercial representative will help you find the right solutions that will serve you well for years. With our experienced guidance, you'll not only satisfy regulations and requirements, but also create aesthetic environments thanks to our trendsetting, residential-inspired styles.

Your representative is committed to ensuring your fixtures' suitability for demanding uses, as indicated by the following symbols:

Moen 5-Year Limited Warranty



We're so confident in the performance of our products that we back them with a 5-Year Limited Warranty. If they should ever drip, leak or prove to have a finish defect, we'll send you the replacement parts, free of charge. Just call 1-800-BUY-MOEN or see your Moen dealer for complete details.



With the growing demand for eco-friendly products, Moen Commercial offers many fixtures whose water savings exceed industry standards.



With very few exceptions, fixtures from Moen Commercial comply with the Americans with Disabilities Act (ADA).



A wide range of our products meet the current requirements of the Buy American Act (BAA).



We offer many products which meet WaterSense® criteria to contribute toward meeting LEED® standards and maximizing LEED points*. While helping you achieve ambitious environmental standards, Moen Commercial can also help you ensure essential function. For instance, installing extremely low-flow fixtures that save water could end up being costlier elsewhere. Without enough water pressure to clear pipes of solids, performance, maintenance and sanitation can quickly become serious issues. Exceedingly low-flow fixtures also provide consumers with a disappointing experience. Being LEED certified doesn't mean sacrificing performance to save water. With the guidance of a Moen Commercial representative, you can build beautifully efficient properties without increasing health risks and downgrading the consumer experience.

* Projects pursuing LEED certification earn points across several areas that address sustainability issues, and based on the number of points achieved, a project receives one of four LEED rating levels: Certified, Silver, Gold or Platinum.

Moen products comply with the Safe Drinking Water Act's stringent lead safety standards.

Each product in this catalog has been identified by the following icons where applicable:

- ▲ NSF 61/9 and 372 compliant
- NSF 372 compliant
- Non-drinking water faucet

To see our full line of faucets and valves, visit moencommercial.com.

M•DURA™ Heavy-Duty Faucets



COMMERCIAL

M•DURA™ Modern Widespread Lavatory Faucet / 9220 and 9223 Series

M•DURA™ Heavy-Duty Lavatory Faucets

	MODEL NUMBER	LIST PRICE	FINISH/ CONNECTION	CASE QTY
MODERN SINGLE-MOUNT LAVATORY FAUCET				
	<ul style="list-style-type: none"> • connection: 3/8" compression • vandal resistant: yes • cartridge type: 1255® Duralast® • flow type: vandal resistant aerated • water usage: 1.2 gpm (4.5L/min) max. • mount type: single mount • supply length: 22" • temp limit stops: yes • drain assembly: drain not included • no lift rod hole • handle type: lever • material: brass 	9417F12	257.50 Chrome	3
	4" DECKPLATE SOLD SEPARATELY			
		99559	32.55 Chrome	20
	<ul style="list-style-type: none"> • water usage: 1.5 gpm (5.7 L/min) max. • drain assembly: drain not included • handle type: lever • material: brass 	9417F05	257.50 Chrome	3
	<ul style="list-style-type: none"> • water usage: 1.2 gpm (4.5L/min) max. • drain assembly: metal • handle type: lever • material: brass 	9419F12	286.10 Chrome	3
<ul style="list-style-type: none"> • water usage: 0.5 gpm (1.9 L/min) max. • drain assembly: metal • handle type: lever • material: brass 	9419F05	286.10 Chrome	3	



M•DURA™ Heavy-Duty Lavatory Faucets

	MODEL NUMBER	LIST PRICE	FINISH/ CONNECTION	CASE QTY
SINGLE-MOUNT LAVATORY FAUCET				
	<ul style="list-style-type: none"> • connection: 3/8" compression • cartridge type: ceramic disc • flow type: aerated • water usage: 2.2 gpm (8.3 L/min) max. • mount type: single mount • supply length: 22" • temp limit stops: yes • drain assembly: drain not included • no lift rod hole • handle type: lever • material: brass 	8417	232.65 Chrome	6
	<ul style="list-style-type: none"> • water usage: 1.2 gpm (4.5L/min) max. • drain assembly: drain not included • handle type: lever • material: brass 	8417F12	232.65 Chrome	6
	<ul style="list-style-type: none"> • water usage: 0.5 gpm (1.9 L/min) max. • drain assembly: drain not included • handle type: lever • material: brass 	8417F05	232.65 Chrome	6
	<ul style="list-style-type: none"> • water usage: 1.2 gpm (4.5L/min) max. • drain assembly: metal • handle type: lever • material: brass 	8419F12	264.30 Chrome	6
	<ul style="list-style-type: none"> • water usage: 0.5 gpm (1.9 L/min) max. • drain assembly: metal • handle type: lever • material: brass 	8419F05	264.30 Chrome	6

SINGLE-MOUNT LAVATORY FAUCET

	<ul style="list-style-type: none"> • connection: 3/8" compression • cartridge type: ceramic disc • flow type: aerated • water usage: 2.2 gpm (8.3 L/min) max. • mount type: single mount • supply length: 22" • temp limit stops: yes • drain assembly: drain not included • no lift rod hole • handle type: lever • material: brass 	8418	244.55 Chrome	6
	<ul style="list-style-type: none"> • ADA compliant 			





COMMERCIAL

M•DURA™ Heavy-Duty Lavatory Faucets



	MODEL NUMBER	LIST PRICE	FINISH/ CONNECTION	CASE QTY
ONE-HANDLE CENTERSET LAVATORY FAUCET				
	<ul style="list-style-type: none"> • connection: 1/2" IPS • cartridge type: ceramic disc • flow type: aerated • water usage: 2.2 gpm (8.3 L/min) max. • mount type: centerset • temp limit stops: yes • drain assembly: drain not included • no lift rod hole • handle type: lever • material: brass 	8413	168.40 Chrome	6
	<ul style="list-style-type: none"> • water usage: 1.2 gpm (4.5L/min) max. • drain assembly: drain not included • handle type: lever • material: brass 	8413F12	168.40 Chrome	3
	<ul style="list-style-type: none"> • water usage: 0.5 gpm (1.9 L/min) max. • drain assembly: drain not included • handle type: lever • material: brass 	8413F05	168.40 Chrome	3
	<ul style="list-style-type: none"> • water usage: 0.35 gpm (1.32 L/min) max. • drain assembly: drain not included • handle type: lever • material: brass 	8413F03	168.40 Chrome	3
	<ul style="list-style-type: none"> • water usage: 2.2 gpm (8.3 L/min) max. • drain assembly: metal • handle type: lever • material: brass 	8414	201.00 Chrome	6
	<ul style="list-style-type: none"> • water usage: 1.2 gpm (4.5L/min) max. • drain assembly: metal • handle type: lever • material: brass 	8414F12 8414F12BN	201.00 Chrome 260.05 Brushed Nickel	3 3

ONE-HANDLE CENTERSET LAVATORY FAUCET				
	<ul style="list-style-type: none"> • connection: 1/2" IPS • cartridge type: ceramic disc • flow type: aerated • water usage: 2.2 gpm (8.3 L/min) max. • mount type: centerset • temp limit stops: yes • drain assembly: drain not included • no lift rod hole • handle type: lever • material: brass 	8416	180.90 Chrome	6
	<ul style="list-style-type: none"> • water usage: 0.5 gpm (1.9 L/min) max. • drain assembly: drain not included • handle type: lever • material: brass 	8416F05	180.90 Chrome	3







COMMERCIAL

 NSF 6 1/9 and 372 compliant
  NSF 372 compliant
  Non-drinking water faucet
 WaterSense®
  Water-saving

M•DURA™ Heavy-Duty Lavatory Faucets

	MODEL NUMBER	LIST PRICE	FINISH/ CONNECTION	CASE QTY
MODERN WIDESPREAD LAVATORY FAUCET				
	<ul style="list-style-type: none"> • connection: 1/2" IPS • vandal resistant: yes • cartridge type: ceramic cartridge hot/cold • flow type: vandal resistant aerated • water usage: 1.2 gpm (4.5L/min) max. • mount type: widespread • drain assembly: drain not included • no lift rod hole • handle type: lever • material: brass 	9220F12	317.40 Chrome	3
	<ul style="list-style-type: none"> • water usage: 0.5 gpm (1.9 L/min) max. • drain assembly: drain not included • handle type: lever • material: brass 	9220F05	317.40 Chrome	3
	<ul style="list-style-type: none"> • water usage: 1.2 gpm (4.5L/min) max. • drain assembly: metal • handle type: lever • material: brass 	9223F12	352.65 Chrome	3
	<ul style="list-style-type: none"> • water usage: 0.5 gpm (1.9 L/min) max. • drain assembly: metal • handle type: lever • material: brass 	9223F05	352.65 Chrome	3
WIDESPREAD LAVATORY FAUCET				
	<ul style="list-style-type: none"> • connection: 1/2" IPS • vandal resistant: yes • cartridge type: ceramic cartridge hot/cold • flow type: vandal resistant aerated • water usage: 2.2 gpm (8.3 L/min) max. • mount type: widespread • drain assembly: drain not included • no lift rod hole • handle type: lever • material: brass 	8220	308.10 Chrome	6
	<ul style="list-style-type: none"> • water usage: 0.5 gpm (1.9 L/min) max. • drain assembly: drain not included • handle type: lever • material: brass 	8220F05	308.10 Chrome	3
	<ul style="list-style-type: none"> • water usage: 2.2 gpm (8.3 L/min) max. • drain assembly: metal • handle type: lever • material: brass 	8223	341.90 Chrome	6
	<ul style="list-style-type: none"> • water usage: 2.2 gpm (8.3 L/min) max. • drain assembly: grid strainer waste • handle type: lever • material: brass 	8224	335.35 Chrome	6

COMMERCIAL

 ADA compliant
  BAA compliant
  NSF 6 1/9 and 372 compliant
  NSF 372 compliant
  Non-drinking water faucet
  WaterSense®
  Water-saving

M•DURA™ Heavy-Duty Lavatory Faucets

	MODEL NUMBER	LIST PRICE	FINISH/ CONNECTION	CASE QTY
	<ul style="list-style-type: none"> • connection: 1/2" IPS • vandal resistant: yes • cartridge type: ceramic cartridge hot/cold • flow type: vandal resistant aerated • water usage: 2.2 gpm (8.3 L/min) max. • mount type: widespread • drain assembly: drain not included • no lift rod hole • handle type: wrist blade • material: brass 	8228	327.55 Chrome	6
	<ul style="list-style-type: none"> • water usage: 1.2 gpm (4.5L/min) max. • drain assembly: drain not included • handle type: wrist blade • material: brass 	8228F12	327.55 Chrome	3
	<ul style="list-style-type: none"> • water usage: 0.5 gpm (1.9 L/min) max. • drain assembly: drain not included • handle type: wrist blade • material: brass 	8228F05	327.55 Chrome	3
	<ul style="list-style-type: none"> • water usage: 2.2 gpm (8.3 L/min) max. • drain assembly: metal • handle type: wrist blade • material: brass 	8239	361.35 Chrome	6

COMMERCIAL

M•DURA™ Heavy-Duty Lavatory Faucets

	MODEL NUMBER	LIST PRICE	FINISH/ CONNECTION	CASE QTY
TWO-HANDLE CENTERSET LAVATORY FAUCET				
	<ul style="list-style-type: none"> • connection: 1/2" IPS • vandal resistant: yes • cartridge type: ceramic cartridge hot/cold • flow type: vandal resistant aerated • water usage: 2.2 gpm (8.3 L/min) max. • mount type: centerset • drain assembly: drain not included • no lift rod hole • handle type: lever • material: brass 	8210	196.70 Chrome	6
	<ul style="list-style-type: none"> • water usage: 1.2 gpm (4.5L/min) max. • drain assembly: drain not included • handle type: lever • material: brass 	8210F12	196.70 Chrome	6
	<ul style="list-style-type: none"> • water usage: 1.2 gpm (4.5L/min) max. • drain assembly: drain not included • handle type: smooth lever • material: brass 	8210SMF12	196.70 Chrome	6
	<ul style="list-style-type: none"> • water usage: 0.5 gpm (1.9 L/min) max. • drain assembly: drain not included • handle type: lever • material: brass 	8210F05	196.70 Chrome	6
	<ul style="list-style-type: none"> • water usage: 0.5 gpm (1.9 L/min) max. • drain assembly: drain not included • handle type: smooth lever • material: brass 	8210SMF05	196.70 Chrome	6
	<ul style="list-style-type: none"> • water usage: 2.2 gpm (8.3 L/min) max. • drain assembly: metal • handle type: lever • material: brass 	8216	222.15 Chrome	6
	<ul style="list-style-type: none"> • water usage: 2.2 gpm (8.3 L/min) max. • drain assembly: grid strainer waste • handle type: lever • material: brass 	8218	215.75 Chrome	6

COMMERCIAL

M•DURA™ Heavy-Duty Lavatory Faucets

	MODEL NUMBER	LIST PRICE	FINISH/ CONNECTION	CASE QTY
TWO-HANDLE CENTERSET LAVATORY FAUCET				
	<ul style="list-style-type: none"> • connection: 1/2" IPS • vandal resistant: yes • cartridge type: ceramic cartridge hot/cold • flow type: vandal resistant aerated • water usage: 2.2 gpm (8.3 L/min) max. • mount type: centerset • drain assembly: drain not included • no lift rod hole • handle type: wrist blade • material: brass 	8215	218.10 Chrome	6
	<ul style="list-style-type: none"> • water usage: 1.2 gpm (4.5L/min) max. • drain assembly: drain not included • handle type: wrist blade • material: brass 	8215F12	218.10 Chrome	6
	<ul style="list-style-type: none"> • water usage: 1.2 gpm (4.5L/min) max. • drain assembly: drain not included • handle type: smooth wrist blades • material: brass 	8215SMF12	218.10 Chrome	6
	<ul style="list-style-type: none"> • water usage: 0.5 gpm (1.9 L/min) max. • drain assembly: drain not included • handle type: wrist blade • material: brass 	8215F05	218.10 Chrome	6
	<ul style="list-style-type: none"> • water usage: 0.35 gpm (1.32 L/min) max. • drain assembly: drain not included • handle type: wrist blade • material: brass 	8215F03	218.10 Chrome	6
	<ul style="list-style-type: none"> • water usage: 2.2 gpm (8.3 L/min) max. • drain assembly: metal • handle type: wrist blade • material: brass 	8219	242.35 Chrome	6

COMMERCIAL

M•DURA™ Heavy-Duty Faucets

	MODEL NUMBER	LIST PRICE	FINISH/ CONNECTION	CASE QTY
--	--------------	------------	--------------------	----------

MANUAL-TO-METERING CONVERSION KIT



- excludes 8242, 8244 and modern lavs
- includes hot/cold color indicator rings

52120	154.00	Chrome	12
--------------	--------	--------	----

TWO-HANDLE CENTERSET GOOSENECK FAUCET



- connection: 1/2" IPS
- vandal resistant: yes
- cartridge type: ceramic cartridge hot/cold
- spout reach: 3.60
- flow type: vandal resistant laminar
- water usage: 1.2 gpm (4.5L/min) max.
- mount type: centerset
- drain assembly: drain not included
- handle type: lever
- material: brass

8270	233.95	Chrome	6
-------------	--------	--------	---



TWO-HANDLE CENTERSET GOOSENECK FAUCET



- connection: 1/2" IPS
- vandal resistant: yes
- cartridge type: ceramic cartridge hot/cold
- spout reach: 5.25
- flow type: vandal resistant laminar
- water usage: 1.2 gpm (4.5L/min) max.
- mount type: centerset
- drain assembly: drain not included
- handle type: lever
- material: brass

8272	245.25	Chrome	6
-------------	--------	--------	---



TWO-HANDLE CENTERSET GOOSENECK FAUCET



- connection: 1/2" IPS
- vandal resistant: yes
- cartridge type: ceramic disc
- spout reach: 6.00
- flow type: aerated
- water usage: 1.2 gpm (4.5L/min) max.
- mount type: centerset
- drain assembly: drain not included
- handle type: lever
- material: brass

8273	201.15	Chrome	6
-------------	--------	--------	---



- drain assembly: drain not included
- handle type: lever
- material: brass
- spout: not included

8274	188.60	Chrome	6
-------------	--------	--------	---



COMMERCIAL

M•DURA™ Heavy-Duty Faucets



	MODEL NUMBER	LIST PRICE	FINISH/ CONNECTION	CASE QTY
TWO-HANDLE CENTERSET GOOSENECK FAUCET				
	<ul style="list-style-type: none"> • connection: 1/2" IPS • vandal resistant: yes • cartridge type: ceramic cartridge hot/cold • spout reach: 3.60 • flow type: vandal resistant laminar • water usage: 1.2 gpm (4.5L/min) max. • mount type: centerset • drain assembly: drain not included • handle type: wrist blade • material: brass 	8278	246.50 Chrome	6
	<ul style="list-style-type: none"> • water usage: 2.2 gpm (8.3 L/min) max. • drain assembly: drain not included • handle type: smooth wrist blades • material: brass 	8278SM	246.50 Chrome	6
	<ul style="list-style-type: none"> • water usage: 1.2 gpm (4.5L/min) max. • drain assembly: drain not included • handle type: smooth wrist blades • material: brass 	8278SMF12	246.50 Chrome	6

TWO-HANDLE CENTERSET GOOSENECK FAUCET				
	<ul style="list-style-type: none"> • connection: 1/2" IPS • vandal resistant: yes • cartridge type: ceramic cartridge hot/cold • spout reach: 5.25 • flow type: vandal resistant laminar • water usage: 1.2 gpm (4.5L/min) max. • mount type: centerset • drain assembly: drain not included • handle type: wrist blade • material: brass 	8279	266.75 Chrome	6
	<ul style="list-style-type: none"> • water usage: 2.2 gpm aerated/2.0 laminar • drain assembly: drain not included • handle type: smooth wrist blades • material: brass 	8279SM	262.30 Chrome	6
	<ul style="list-style-type: none"> • water usage: 1.2 gpm (4.5L/min) max. • drain assembly: drain not included • handle type: smooth wrist blades • material: brass 	8279SMF12	262.30 Chrome	6
	<ul style="list-style-type: none"> • drain assembly: drain not included • handle type: wrist blade • material: brass • spout: not included 	8276	210.00 Chrome	6

Optional spouts available on page 480.

- ▲ NSF 6 1/9 and 372 compliant
- NSF 372 compliant
- Non-drinking water faucet
- ♿ ADA compliant
- Ⓢ BAA compliant
- 💧 WaterSense®
- 🌿 Water-saving

M•DURA™ Heavy-Duty Faucets















	MODEL NUMBER	LIST PRICE	FINISH/ CONNECTION	CASE QTY
WIDESPREAD GOOSENECK FAUCET				
	<ul style="list-style-type: none"> • connection: 1/2" IPS • vandal resistant: yes • cartridge type: ceramic cartridge hot/cold • spout reach: 5.25 • flow type: aerated • water usage: 1.2 gpm (4.5L/min) max. • mount type: widespread • drain assembly: drain not included • handle type: wrist blade • material: brass 	8248	313.25 Chrome	6
	<ul style="list-style-type: none"> • water usage: 2.2 gpm aerated/2.0 laminar • drain assembly: drain not included • handle type: smooth wrist blades • material: brass 	8248SM	313.25 Chrome	3
	<ul style="list-style-type: none"> • water usage: 1.2 gpm (4.5L/min) max. • drain assembly: drain not included • handle type: smooth wrist blades • material: brass 	8248SMF12	313.25 Chrome	3
WIDESPREAD GOOSENECK FAUCET				
	<ul style="list-style-type: none"> • connection: 1/2" IPS • vandal resistant: yes • cartridge type: ceramic cartridge hot/cold • spout reach: 8.00 • flow type: aerated • water usage: 1.5 gpm (5.7 L/min) max. • mount type: widespread • drain assembly: drain not included • handle type: wrist blade • material: brass 	8225	319.85 Chrome	6
	<ul style="list-style-type: none"> • drain assembly: drain not included • handle type: wrist blade • material: brass • spout: not included 	8229	266.70 Chrome	6
	<ul style="list-style-type: none"> • water usage: 2.2 gpm aerated/2.0 laminar • drain assembly: drain not included • handle type: smooth wrist blades • material: brass 	8225SM	319.85 Chrome	3
	<ul style="list-style-type: none"> • water usage: 1.5 gpm aerated/1.5 laminar • drain assembly: drain not included • handle type: smooth wrist blades • material: brass 	8225SMF15	319.85 Chrome	3

COMMERCIAL

Optional spouts available on page 480.

- ▲ NSF 6 1/9 and 372 compliant
- NSF 372 compliant
- Non-drinking water faucet
- ♿ ADA compliant
- Ⓢ BAA compliant
- 💧 WaterSense®
- 🌿 Water-saving



M•DURA™ Heavy-Duty Faucets

	MODEL NUMBER	LIST PRICE	FINISH/ CONNECTION	CASE QTY
WIDESPREAD GOOSENECK FAUCET				
	8227	300.40	Chrome	6
	<ul style="list-style-type: none"> • connection: 1/2" IPS • vandal resistant: yes • cartridge type: ceramic cartridge hot/cold • spout reach: 8.00 • flow type: aerated • water usage: 1.5 gpm (5.7 L/min) max. • mount type: widespread • drain assembly: drain not included • handle type: lever • material: brass 			
	  			
WIDESPREAD GOOSENECK FAUCET				
	8226	247.15	Chrome	6
	<ul style="list-style-type: none"> • drain assembly: drain not included • handle type: lever • material: brass • spout: not included 			
	  			
WIDESPREAD GOOSENECK FAUCET				
	8242	344.60	Chrome	6
	<ul style="list-style-type: none"> • connection: 1/2" IPS • vandal resistant: yes • cartridge type: ceramic cartridge hot/cold • spout reach: 8.00 • flow type: aerated • water usage: 1.5 gpm (5.7 L/min) max. • mount type: widespread • side spray: yes • drain assembly: drain not included • handle type: lever • material: brass 			
	  			
WIDESPREAD GOOSENECK FAUCET				
	8244	364.00	Chrome	6
	<ul style="list-style-type: none"> • connection: 1/2" IPS • vandal resistant: yes • cartridge type: ceramic cartridge hot/cold • spout reach: 8.00 • flow type: aerated • water usage: 1.5 gpm (5.7 L/min) max. • mount type: widespread • side spray: yes • drain assembly: drain not included • handle type: wrist blade • material: brass 			
	  			

Optional spouts available on page 480.

- ▲ NSF 6 1/9 and 372 compliant
- NSF 372 compliant
- Non-drinking water faucet
- ♿ ADA compliant
- Ⓢ BAA compliant
- 💧 WaterSense®
- 🌿 Water-saving

M•DURA™ Heavy-Duty Kitchen Faucets









	MODEL NUMBER	LIST PRICE	FINISH/ CONNECTION	CASE QTY
TWO-HANDLE KITCHEN FAUCET				
	<ul style="list-style-type: none"> • connection: 1/2" IPS • vandal resistant: yes • cartridge type: ceramic cartridge hot/cold • spout reach: 8.00 • flow type: aerated • water usage: 1.5 gpm (5.7 L/min) max. • drain assembly: drain not included • handle type: lever • material: brass 	8287	295.30 Chrome	6
	<ul style="list-style-type: none"> • drain assembly: drain not included • handle type: lever • material: brass • spout: not included 	8280	236.90 Chrome	6
TWO-HANDLE KITCHEN FAUCET				
	<ul style="list-style-type: none"> • connection: 1/2" IPS • vandal resistant: yes • cartridge type: ceramic cartridge hot/cold • spout reach: 8.00 • flow type: aerated • water usage: 1.5 gpm (5.7 L/min) max. • drain assembly: drain not included • handle type: wrist blade • material: brass 	8289	314.65 Chrome	6
	<ul style="list-style-type: none"> • drain assembly: drain not included • handle type: wrist blade • material: brass • spout: not included 	8285	256.35 Chrome	6

COMMERCIAL

Optional spouts available on page 480.

- ▲ NSF 6 1/9 and 372 compliant
- NSF 372 compliant
- Non-drinking water faucet
- ♿ ADA compliant
- Ⓢ BAA compliant
- 💧 WaterSense®
- 🌿 Water-saving





M•DURA™ Heavy-Duty Kitchen Faucets

	MODEL NUMBER	LIST PRICE	FINISH/ CONNECTION	CASE QTY
ONE-HANDLE KITCHEN FAUCET				
	<ul style="list-style-type: none"> • connection: 3/8" compression • vandal resistant: yes • cartridge type: 1255® Duralast® • spout reach: 9.00 • flow type: aerated • water usage: 1.5 gpm (5.7 L/min) max. • supply length: 22" • temp limit stops: yes • drain assembly: drain not included • handle type: lever • material: brass 	8701	145.40 Chrome	12
				
<hr/>				
	<ul style="list-style-type: none"> • water usage: 1.5 gpm (5.7 L/min) max. • drain assembly: drain not included • handle type: lever • material: brass • spout reach: 12.00 	8711	217.35 Chrome	6
				
ONE-HANDLE KITCHEN FAUCET				
	<ul style="list-style-type: none"> • connection: 3/8" compression • vandal resistant: yes • cartridge type: 1255® Duralast® • spout reach: 9.00 • flow type: aerated • water usage: 1.5 gpm (5.7 L/min) max. • supply length: 22" • temp limit stops: yes • side spray: yes • drain assembly: drain not included • handle type: lever • material: brass 	8707	173.25 Chrome	6
				
<hr/>				
	<ul style="list-style-type: none"> • water usage: 1.5 gpm (5.7 L/min) max. • drain assembly: drain not included • handle type: lever • material: brass • spout reach: 12.00 	8717	256.80 Chrome	6
				
ONE-HANDLE WALLMOUNT KITCHEN FAUCET				
	<ul style="list-style-type: none"> • connection: 1/2" eccentric; IPS • vandal resistant: yes • cartridge type: 1255® Duralast® • spout reach: 9.00 • flow type: aerated • water usage: 1.5 gpm (5.7 L/min) max. • mount type: wall mount • temp limit stops: yes • drain assembly: drain not included • handle type: lever • material: brass 	8713	436.45 Chrome	12
				
<hr/>				
	<ul style="list-style-type: none"> • water usage: 1.5 gpm (5.7 L/min) max. • drain assembly: drain not included • handle type: lever • material: brass • spout reach: 12.00 	8714	449.95 Chrome	12
				

Optional spouts available on page 480.

- ▲ NSF 6 1/9 and 372 compliant
- NSF 372 compliant
- Non-drinking water faucet
- ♿ ADA compliant
- ♻️ BAA compliant
- 💧 WaterSense®
- 💧 Water-saving

M•DURA™ Heavy-Duty Multi-Purpose Faucets

	MODEL NUMBER	LIST PRICE	FINISH/ CONNECTION	CASE QTY
ONE-HANDLE MULTI-PURPOSE FAUCET				
	<ul style="list-style-type: none"> • connection: 3/8" compression • vandal resistant: yes • cartridge type: 1255® Duralast® • flow type: aerated • water usage: 1.5 gpm (5.7 L/min) max. • mount type: widespread • supply length: 22" • temp limit stops: yes • side spray: yes • drain assembly: drain not included • handle type: lever • material: brass 	8138	286.20 Chrome	6
ONE-HANDLE MULTI-PURPOSE FAUCET				
	<ul style="list-style-type: none"> • connection: 3/8" compression • vandal resistant: yes • cartridge type: 1255® Duralast® • flow type: aerated • water usage: 1.5 gpm (5.7 L/min) max. • mount type: widespread • supply length: 22" • temp limit stops: yes • drain assembly: drain not included • handle type: lever • material: brass 	8137	240.45 Chrome	6
	<ul style="list-style-type: none"> • drain assembly: drain not included • handle type: lever • material: brass • spout: not included 	8125	183.30 Chrome	6
ONE-HANDLE MULTI-PURPOSE FAUCET				
	<ul style="list-style-type: none"> • connection: 1/2" IPS • vandal resistant: yes • cartridge type: ceramic disc • flow type: vandal resistant aerated • water usage: 0.5 gpm (1.9 L/min) max. • mount type: single mount • cold only: yes • drain assembly: drain not included • handle type: lever • material: brass 	8161	145.35 Chrome	6
   				

COMMERCIAL

M•DURA™ Heavy-Duty Multi-Purpose Faucets

	MODEL NUMBER	LIST PRICE	FINISH/ CONNECTION	CASE QTY
TWO-HANDLE CENTERSET UTILITY FAUCET				



- connection: 1/2" IPS
- 3/4" garden hose thread
- vandal resistant: yes
- cartridge type: ceramic cartridge hot/cold
- spout reach: 6.50
- water usage: unrestricted
- mount type: centerpiece
- drain assembly: drain not included
- handle type: lever
- material: brass

8277

212.85 Chrome

6



TWO-HANDLE WALLMOUNT UTILITY FAUCET				
--------------------------------------------	--	--	--	--



- connection: 1/2" eccentric IPS
- vandal resistant: yes
- cartridge type: ceramic cartridge hot/cold
- spout reach: 12.00
- flow type: aerated
- water usage: 1.5 gpm (5.7 L/min) max.
- mount type: wall mount
- drain assembly: drain not included
- handle type: lever
- material: brass

8119

297.80 Chrome

6



TWO-HANDLE WALLMOUNT UTILITY FAUCET				
--------------------------------------------	--	--	--	--



- connection: 1/2" eccentric IPS
- vandal resistant: yes
- cartridge type: ceramic cartridge hot/cold
- spout reach: 8.00
- flow type: aerated
- water usage: 1.5 gpm (5.7 L/min) max.
- mount type: wall mount
- drain assembly: drain not included
- handle type: wrist blade
- material: brass

8126

298.55 Chrome

6



- drain assembly: drain not included
- handle type: wrist blade
- material: brass
- spout: not included

8121













241.60 Chrome

6



COMMERCIAL

M•DURA™ Heavy-Duty Multi-Purpose Faucets

		MODEL NUMBER	LIST PRICE	FINISH/ CONNECTION	CASE QTY
TWO-HANDLE WALLMOUNT SERVICE SINK FAUCET					
	<ul style="list-style-type: none"> • connection: 1/2" eccentric IPS • 3/4" garden hose thread • vandal resistant: yes • cartridge type: ceramic cartridge hot/cold • spout reach: 9.38 • water usage: unrestricted • mount type: wall mount • wall bracket included: yes • vacuum breaker: yes • pail hook: yes • drain assembly: drain not included • handle type: lever • material: brass 	8230	204.70	Rough Chrome	3
	  				
TWO-HANDLE WALLMOUNT SERVICE SINK FAUCET					
	<ul style="list-style-type: none"> • connection: 1/2" eccentric IPS • 3/4" garden hose thread • vandal resistant: yes • cartridge type: ceramic cartridge hot/cold • spout reach: 10.25 • water usage: unrestricted • mount type: wall mount • wall bracket included: yes • backflow preventers included: yes • vacuum breaker: yes • pail hook: yes • drain assembly: drain not included • handle type: lever • material: brass 	8124	252.35	Chrome	6
	  				
	<ul style="list-style-type: none"> • water usage: unrestricted • drain assembly: drain not included • handle type: wrist blade • material: brass 	8232	296.20	Chrome	6
	  				
MOP HANGER					
	<ul style="list-style-type: none"> • holds 3 handles 	8198	66.45	Stainless	10
HOSE BRACKET					
	<ul style="list-style-type: none"> • 30" heavy-duty rubber hose 	8199	48.40	Stainless	10

Optional spouts available on page 480.

- ▲ NSF 6 1/9 and 372 compliant
- NSF 372 compliant
- Non-drinking water faucet
- ♿ ADA compliant
- Ⓢ BAA compliant
- 💧 WaterSense®
- 🌿 Water-saving

M•DURA™ Heavy-Duty Laboratory Faucets

	MODEL NUMBER	LIST PRICE	FINISH/ CONNECTION	CASE QTY
--	--------------	------------	--------------------	----------

ONE-HANDLE LABORATORY FAUCET



- connection: 3/8" compression
- vandal resistant: yes
- cartridge type: ceramic cartridge hot/cold
- spout reach: 5.25
- flow type: aerated
- water usage: 2.2 gpm (8.3 L/min) max.
- mount type: single mount
- supply length: 22"
- cold only: yes
- drain assembly: drain not included
- handle type: lever
- material: brass

8103

171.45 Chrome

6



ONE-HANDLE LABORATORY FAUCET



- connection: 3/8" compression
- serrated hose nozzle
- vandal resistant: yes
- cartridge type: ceramic cartridge hot/cold
- spout reach: 6.00
- water usage: unrestricted
- mount type: single mount
- supply length: 22"
- vacuum breaker: yes
- cold only: yes
- drain assembly: drain not included
- handle type: lever
- material: brass

8106

231.45 Chrome

6



TWO-HANDLE LABORATORY FAUCET



- connection: 3/8" compression
- vandal resistant: yes
- cartridge type: ceramic cartridge hot/cold
- spout reach: 5.25
- flow type: aerated
- water usage: 2.2 gpm (8.3 L/min) max.
- mount type: single mount
- supply length: 22"
- drain assembly: drain not included
- handle type: lever
- material: brass

8113

254.00 Chrome

6



TWO-HANDLE LABORATORY FAUCET



- connection: 3/8" compression
- serrated hose nozzle
- vandal resistant: yes
- cartridge type: ceramic cartridge hot/cold
- spout reach: 6.00
- water usage: unrestricted
- mount type: single mount
- supply length: 22"
- vacuum breaker: yes
- drain assembly: drain not included
- handle type: lever
- material: brass

8116

314.00 Chrome

6



COMMERCIAL

M•DURA™ Heavy-Duty Spouts

DOUBLE-BEND SPOUTS



S0003



S0010

Model Number	Reach	Base to Aerator*	Overall Height	Weight Each Pounds	Case Quantity	List Price
S0000 ▲	6.00"	2.00"	4.325"	0.89	12	48.55
S0001 ▲	6.00"	3.75"	7.375"	1.20	12	58.35
S0002 ▲	6.00"	5.00"	9.125"	1.64	12	59.60
S0003 ▲	6.00"	5.75"	9.75"	1.60	12	58.35
S0004 ▲	6.00"	8.50"	12.75"	1.71	12	70.10
S0006 ▲	8.00"	0.75"	3.50"	1.20	12	44.45
S0007 ▲	8.00"	6.00"	9.75"	1.90	12	59.60
S0009 ▲	10.00"	5.75"	9.75"	2.20	12	64.25
S0010 ▲	12.00"	0.50"	3.125"	1.40	12	70.10
S0011 ▲	12.00"	6.00"	9.75"	1.64	12	58.35

MULTI-BEND SPOUTS



Model Number	Reach	Base to Aerator*	Overall Height	Weight Each Pounds	Case Quantity	List Price
S0012 ▲	18.00"	3.75"	7.75"	2.40	12	127.40

VACUUM-BREAKER SPOUTS



SV003

Model Number	Reach	Base to Aerator*	Overall Height	Weight Each Pounds	Case Quantity	List Price
SV003 ■	6.00"	5.75"	10.50"	2.15	12	120.35
SV006 ■	8.00"	0.50"	4.00"	1.40	12	112.20
SV010 ■	12.00"	0.50"	4.00"	1.70	12	118.00

All spouts include 2.2 gpm [8.3 lpm] max. aerators (except as noted below). Spouts are designed for use only with 8100 and 8200 series aerators.

* Height from spout nut base plane to aerator

** Threaded-end gooseneck spouts – spout tip is threaded, no aerator included

*** Smooth-end gooseneck spouts – spout tip is smooth and will not take an aerator; flow is controlled by 1.5gpm laminar flow spout base insert.

▲ NSF 6 1/9 and 372 compliant ● NSF 372 compliant ■ Non-drinking water faucet
 ♿ ADA compliant ♻️ BAA compliant ♻️ WaterSense® ♻️ Water-saving

GOOSENECK SPOUTS



Model Number	Reach	Base to Aerator*	Overall Height	Weight Each Pounds	Case Quantity	List Price
S0020 ▲	3.625"	6.25"	8.75"	1.47	12	59.60
S0030 ▲	5.25"	5.50"	10.00"	1.55	12	65.45
S0050 ▲	8.00"	6.125"	11.375"	1.65	12	72.45
S0060 ▲	8.00"	10.00"	12.00"	1.10	12	90.00
S0070 ▲	9.50"	6.50"	9.175"	1.81	12	78.30

THREADED-END GOOSENECK SPOUTS

Model Number	Reach	Base to Aerator**	Overall Height	Weight Each Pounds	Case Quantity	List Price
S0000T ▲	6.00"	N/A	4.325"	0.89	12	33.55
S0010T ▲	12.00"	N/A	3.125"	1.40	12	55.10
S0020T ▲	3.625"	N/A	8.75"	1.47	12	44.60
S0030T ▲	5.25"	N/A	10.00"	1.55	12	50.45
S0050T ▲	8.00"	N/A	11.375"	1.85	12	57.45

SMOOTH-END GOOSENECK SPOUTS

Model Number	Reach	Base to Aerator***	Overall Height	Weight Each Pounds	Case Quantity	List Price
S0030NA ▲	5.25"	N/A	10.00"	1.15	6	64.05

All spouts include 2.2 gpm [8.3 lpm] max. aerators (except as noted below). Spouts are designed for use only with 8100 and 8200 series aerators.

- * Height from spout nut base plane to aerator
- ** Threaded-end gooseneck spouts – spout tip is threaded, no aerator included
- *** Smooth-end gooseneck spouts – spout tip is smooth and will not take an aerator; flow is controlled by 1.5gpm laminar flow spout base insert.

- ▲ NSF 6 1/9 and 372 compliant
- NSF 372 compliant
- Non-drinking water faucet
- ♿ ADA compliant
- ♻️ BAA compliant
- 💧 WaterSense®
- 🌿 Water-saving

M•PRESS™ Heavy-Duty Metering Faucets



COMMERCIAL

M•PRESS™ Single-Mount Metering Faucet / 8884

M•PRESS™ Heavy-Duty Metering Faucets

	MODEL NUMBER	LIST PRICE	CASE QTY
ECO-PERFORMANCE SINGLE-MOUNT METERING FAUCET			
	8884	177.15	6
	4" DECKPLATE SOLD SEPARATELY		
	99550	29.75	12
<ul style="list-style-type: none"> • connection: 1/2" IPS • vandal resistant: yes • flow type: vandal resist multi-laminar • water usage: 0.5 gpm (1.9 L/min) max. • mount type: single mount • timing preset: yes • drain assembly: drain not included • material: brass   			
ECO-PERFORMANCE SINGLE-MOUNT EXTENDED REACH METERING FAUCET			
	8894	201.15	6
	4" DECKPLATE SOLD SEPARATELY		
	99551	29.75	12
<ul style="list-style-type: none"> • connection: 1/2" IPS • vandal resistant: yes • flow type: vandal resist multi-laminar • water usage: 0.5 gpm (1.9 L/min) max. • mount type: single mount • timing preset: yes • drain assembly: drain not included • material: brass   			
ECO-PERFORMANCE CENTERSET METERING FAUCET			
	8886	326.55	6
<ul style="list-style-type: none"> • connection: 1/2" IPS • vandal resistant: yes • flow type: vandal resist multi-laminar • water usage: 0.5 gpm (1.9 L/min) max. • mount type: centerset • timing preset: yes • drain assembly: drain not included • material: brass   			
ECO-PERFORMANCE WIDESPREAD METERING FAUCET			
	8889	417.95	6
<ul style="list-style-type: none"> • connection: 1/2" IPS • vandal resistant: yes • flow type: vandal resist multi-laminar • water usage: 0.5 gpm (1.9 L/min) max. • mount type: widespread • timing preset: yes • drain assembly: drain not included • material: brass   			

M•PRESS™ Heavy-Duty Metering Faucets

		MODEL NUMBER	LIST PRICE	CASE QTY
--	--	--------------	------------	----------

DURAMETER METERING CARTRIDGE



- brass, pressure-independent replacement cartridge

52100

82.95

24

MANUAL-TO-METERING CONVERSION KIT



- excludes 8242, 8244 and modern lavs
- includes hot/cold color indicator rings

52120

154.00

12



M•BITION™ Medium-Duty Faucets



COMMERCIAL

M•BITION™ Single-Handle Lavatory Faucet / 8430 Series

M•BITION™ Medium-Duty Lavatory Faucets

		MODEL NUMBER	LIST PRICE	FINISH/ CONNECTION	CASE QTY
MODERN SINGLE-MOUNT LAVATORY FAUCET					
	<ul style="list-style-type: none"> • connection: 3/8" compression • vandal resistant: yes • cartridge type: 1255® Duralast® • flow type: vandal resistant aerated • water usage: 1.2 gpm (4.5L/min) max. • mount type: single mount • supply length: 24" • temp limit stops: yes • drain assembly: drain not included • no lift rod hole • handle type: lever 	9480	159.35	Chrome	3
				4" DECKPLATE SOLD SEPARATELY	
		99559	32.55	Chrome	20
	<ul style="list-style-type: none"> • water usage: 1.2 gpm (4.5L/min) max. • drain assembly: metal • handle type: lever 	9482	177.05	Chrome	3
ONE-HANDLE CENTERSET LAVATORY FAUCET					
	<ul style="list-style-type: none"> • connection: 1/2" IPS • vandal resistant: yes • cartridge type: 1255® Duralast® • flow type: vandal resistant aerated • water usage: 1.2 gpm (4.5L/min) max. • mount type: center set • temp limit stops: yes • drain assembly: drain not included • removable plug button in lift: yes • handle type: lever 	8400	176.35	Chrome	6
	<ul style="list-style-type: none"> • water usage: 1.2 gpm (4.5L/min) max. • drain assembly: metal • handle type: lever 	8420	204.65	Chrome	6
		8420CBN	255.85	Classic Brushed Nickel	12
	<ul style="list-style-type: none"> • water usage: 1.2 gpm (4.5L/min) max. • drain assembly: grid strainer waste • handle type: lever 	8425	199.25	Chrome	6
ONE-HANDLE CENTERSET LAVATORY FAUCET					
	<ul style="list-style-type: none"> • connection: 3/8" compression • vandal resistant: yes • cartridge type: 1255® Duralast® • flow type: vandal resistant aerated • water usage: 1.2 gpm (4.5L/min) max. • mount type: center set • supply length: flexible • temp limit stops: yes • drain assembly: drain not included • removable plug button in lift: yes • handle type: lever 	8422	185.05	Chrome	12
	<ul style="list-style-type: none"> • water usage: 0.5 gpm (1.9 L/min) max. • drain assembly: drain not included • handle type: lever 	8422F05	185.05	Chrome	12







COMMERCIAL

M•BITION™ Medium-Duty Lavatory Faucets

	MODEL NUMBER	LIST PRICE	FINISH/ CONNECTION	CASE QTY	
ONE-HANDLE CENTERSET LAVATORY FAUCET					
	<ul style="list-style-type: none"> • connection: 1/2" IPS • vandal resistant: yes • cartridge type: 1255® Duralast® • flow type: vandal resistant aerated • water usage: 1.2 gpm (4.5L/min) max. • mount type: centerset • temp limit stops: yes • drain assembly: drain not included • removable plug button in lift: yes • handle type: lever 	8430	137.90	Chrome	12
		8430CBN	172.45	Classic Brushed Nickel	12
	<ul style="list-style-type: none"> • water usage: 0.5 gpm (1.9 L/min) max. • drain assembly: drain not included • handle type: lever 	8430F05	137.90	Chrome	12
	<ul style="list-style-type: none"> • water usage: 1.2 gpm (4.5L/min) max. • drain assembly: metal • handle type: lever 	8432	169.70	Chrome	12
	<ul style="list-style-type: none"> • water usage: 0.5 gpm (1.9 L/min) max. • drain assembly: metal • handle type: lever 	8432F05	169.70	Chrome	12
<ul style="list-style-type: none"> • water usage: 1.2 gpm (4.5L/min) max. • drain assembly: grid strainer waste • handle type: lever 	8434	163.60	Chrome	12	





















ONE-HANDLE CENTERSET LAVATORY FAUCET					
	<ul style="list-style-type: none"> • connection: 3/8" compression • vandal resistant: yes • cartridge type: 1255® Duralast® • flow type: vandal resistant aerated • water usage: 1.2 gpm (4.5L/min) max. • mount type: centerset • supply length: flexible • temp limit stops: yes • drain assembly: drain not included • removable plug button in lift: yes • handle type: lever 	8439	146.80	Chrome	12
	<ul style="list-style-type: none"> • water usage: 0.5 gpm (1.9 L/min) max. • drain assembly: drain not included • handle type: lever 	8439F05	146.80	Chrome	12
	<ul style="list-style-type: none"> • water usage: 1.2 gpm (4.5L/min) max. • drain assembly: metal • handle type: lever 	8437	178.55	Chrome	12
		8437CBN	223.20	Classic Brushed Nickel	12











M•BITION™ Medium-Duty Lavatory Faucets

	MODEL NUMBER	LIST PRICE	FINISH/ CONNECTION	CASE QTY
MODERN WIDESPREAD LAVATORY FAUCET				
	<ul style="list-style-type: none"> • connection: 1/2" IPS • vandal resistant: yes • cartridge type: 1234 duralast® • flow type: aerated • water usage: 1.2 gpm (4.5L/min) max. • mount type: widespread • drain assembly: drain not included • no lift rod hole • handle type: lever 	9921	229.45 Chrome	3
				
<hr/>				
	<ul style="list-style-type: none"> • water usage: 1.2 gpm (4.5L/min) max. • drain assembly: metal • handle type: lever 	9922	254.95 Chrome	3
				
<hr/>				
WIDESPREAD LAVATORY FAUCET				
	<ul style="list-style-type: none"> • connection: 1/2" IPS • vandal resistant: yes • cartridge type: 1224 • flow type: aerated • water usage: 1.2 gpm (4.5L/min) max. • mount type: widespread • drain type: lift rod • drain assembly: metal • handle type: lever 	8922 8922CBN	253.60 Chrome 304.40 Classic Brushed Nickel	6 6
				
<hr/>				
	<ul style="list-style-type: none"> • water usage: 1.2 gpm (4.5L/min) max. • drain assembly: grid strainer waste • handle type: lever 	8924	271.40 Chrome	6
				

COMMERCIAL



















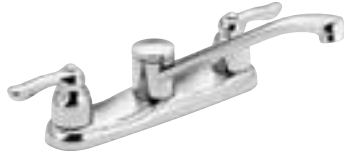

M•BITION™ Medium-Duty Lavatory Faucets

	MODEL NUMBER	LIST PRICE	FINISH/ CONNECTION	CASE QTY
TWO-HANDLE CENTERSET LAVATORY FAUCET				
	<ul style="list-style-type: none"> • connection: 1/2" IPS • vandal resistant: yes • cartridge type: 1224 • flow type: aerated • water usage: 1.2 gpm (4.5L/min) max. • drain assembly: drain not included • removable plug button in lift: yes • handle type: wrist blade 	8800	163.65 Chrome	6
		8800CBN	200.65 Classic Brushed Nickel	6
				    
	<ul style="list-style-type: none"> • water usage: 0.5 gpm (1.9 L/min) max. • drain assembly: drain not included • handle type: wrist blade 	8800F05	163.65 Chrome	6
			    	
	<ul style="list-style-type: none"> • water usage: 1.2 gpm (4.5L/min) max. • drain assembly: grid strainer waste • handle type: wrist blade 	8810	187.65 Chrome	6
			    	
	<ul style="list-style-type: none"> • water usage: 1.2 gpm (4.5L/min) max. • drain assembly: metal • handle type: wrist blade 	8820	193.35 Chrome	6
		8820CBN	237.10 Classic Brushed Nickel	6
			    	

TWO-HANDLE CENTERSET LAVATORY FAUCET				
	<ul style="list-style-type: none"> • connection: 1/2" IPS • vandal resistant: yes • cartridge type: 1224 • spout reach: 6.00 • flow type: aerated • water usage: 1.2 gpm (4.5L/min) max. • mount type: centerset • drain assembly: drain not included • removable plug button in lift: yes • handle type: lever 	8915	120.30 Chrome	12
		8915CBN	150.35 Classic Brushed Nickel	12
				    
	<ul style="list-style-type: none"> • water usage: 1.2 gpm (4.5L/min) max. • drain assembly: metal • handle type: lever 	8917	141.80 Chrome	12
		8917CBN	177.35 Classic Brushed Nickel	12
			    	

COMMERCIAL

M•BITION™ Medium-Duty Kitchen Faucets

	MODEL NUMBER	LIST PRICE	FINISH/ CONNECTION	CASE QTY
TWO-HANDLE KITCHEN FAUCET				
 <ul style="list-style-type: none"> • connection: 1/2" IPS • vandal resistant: yes • cartridge type: 1224 • spout reach: 9.00 • flow type: aerated • water usage: 1.5 gpm (5.7 L/min) max. • side spray: yes • drain assembly: drain not included • handle type: lever   	8791	138.85	Chrome	6
TWO-HANDLE KITCHEN FAUCET				
 <ul style="list-style-type: none"> • connection: 1/2" IPS • vandal resistant: yes • cartridge type: 1224 • spout reach: 8.50 • flow type: aerated • water usage: 2.0 gpm (7.6 L/min) max. • side spray: yes • drain assembly: drain not included • handle type: lever   	8792	268.95	Chrome	6
TWO-HANDLE KITCHEN FAUCET				
 <ul style="list-style-type: none"> • connection: 1/2" IPS • vandal resistant: yes • cartridge type: 1224 • spout reach: 9.00 • flow type: aerated • water usage: 1.5 gpm (5.7 L/min) max. • drain assembly: drain not included • handle type: lever   	8780	117.80	Chrome	6
TWO-HANDLE KITCHEN FAUCET				
 <ul style="list-style-type: none"> • connection: 1/2" IPS • vandal resistant: yes • cartridge type: 1224 • spout reach: 9.00 • flow type: aerated • water usage: 1.5 gpm (5.7 L/min) max. • drain assembly: drain not included • handle type: wrist blade   	8798	188.85	Chrome	6
TWO-HANDLE KITCHEN FAUCET				
 <ul style="list-style-type: none"> • connection: 1/2" IPS • vandal resistant: yes • cartridge type: 1224 • spout reach: 8.50 • flow type: aerated • water usage: 1.5 gpm (5.7 L/min) max. • drain assembly: drain not included • handle type: wrist blade   	8799	246.20	Chrome	6

COMMERCIAL

M•BITION™ Medium-Duty Bar/Pantry Faucets

	MODEL NUMBER	LIST PRICE	FINISH/ CONNECTION	CASE QTY
--	--------------	------------	--------------------	----------

TWO-HANDLE BAR/PANTRY FAUCET



- connection: 1/2" IPS
- vandal resistant: yes
- cartridge type: 1224
- spout reach: 4.56
- flow type: aerated
- water usage: 1.2 gpm (4.5L/min) max.
- mount type: centerset
- drain assembly: drain not included
- handle type: wrist blade

8938

163.20 Chrome

6



TWO-HANDLE BAR/PANTRY FAUCET



- connection: 1/2" IPS
- vandal resistant: yes
- cartridge type: 1224
- spout reach: 4.56
- flow type: aerated
- water usage: 1.2 gpm (4.5L/min) max.
- mount type: centerset
- drain assembly: drain not included
- handle type: lever

8957

125.70 Chrome

12



TWO-HANDLE BAR/PANTRY FAUCET



- connection: 1/2" IPS
- vandal resistant: yes
- cartridge type: 1224
- spout reach: 4.75
- flow type: aerated
- water usage: 1.2 gpm (4.5L/min) max.
- mount type: centerset
- drain assembly: drain not included
- handle type: wrist blade

8948

161.00 Chrome

6



TWO-HANDLE BAR/PANTRY FAUCET



- connection: 1/2" IPS
- vandal resistant: yes
- cartridge type: 1224
- spout reach: 8.50
- flow type: aerated
- water usage: 1.2 gpm (4.5L/min) max.
- mount type: centerset
- drain assembly: drain not included
- handle type: wrist blade

8940

233.20 Chrome

6



COMMERCIAL

M•POWER™ Below-Deck Sensor-Operated Faucets & Soap Dispensers



COMMERCIAL

Align® Below-Deck Sensor-Operated Modern Faucet / 8559

Align® Below-Deck Sensor-Operated Modern Soap Dispenser / 8560

M•POWER™ Sensor-Operated Faucets

	MODEL NUMBER	LIST PRICE	CASE QTY
--	--------------	------------	----------

ALIGN® BELOW-DECK SENSOR-OPERATED MODERN FAUCET



- connection: 3/8" compression
- vandal resistant: yes
- power source: 4 AA included with optional AC*
- flow type: vandal resist multi-laminar
- water usage: 0.5 gpm (1.9 L/min) max.
- mount type: single mount
- supply length: 24"
- non-mixing: yes
- drain assembly: drain not included
- material: brass

8559	647.70	6
4" DECKPLATE SOLD SEPARATELY		
182546	31.85	12
8" DECKPLATE SOLD SEPARATELY		
99558	41.85	20



ALIGN® BELOW-DECK SENSOR-OPERATED MODERN SOAP DISPENSER



- easily refillable 1500ml foam soap reservoir included
- material: brass

8560	495.00	3
BRASS SPACER SOLD SEPARATELY		
181149	67.50	12



BELOW-DECK SENSOR-OPERATED CENTERSET FAUCET



- connection: 3/8" compression
- vandal resistant: yes
- power source: 4 AA included with optional AC*
- flow type: vandal resist multi-laminar
- water usage: 0.5 gpm (1.9 L/min) max.
- mount type: centerset
- supply length: 24"
- non-mixing: yes
- drain assembly: drain not included
- material: brass

CA8301	656.35	6
---------------	--------	---



BELOW-DECK SENSOR-OPERATED TRANSITIONAL FAUCET



- connection: 3/8" compression
- vandal resistant: yes
- power source: 4 AA included with optional AC*
- flow type: vandal resist multi-laminar
- water usage: 0.5 gpm (1.9 L/min) max.
- mount type: single mount
- supply length: 24"
- non-mixing: yes
- drain assembly: drain not included
- material: brass

CA8302	647.70	6
4" DECKPLATE SOLD SEPARATELY		
182546	31.85	12
8" DECKPLATE SOLD SEPARATELY		
99558	41.85	20



BELOW-DECK SENSOR-OPERATED TRANSITIONAL SOAP DISPENSER



- easily refillable 1500ml foam soap reservoir included
- material: brass

8558	495.00	3
BRASS SPACER SOLD SEPARATELY		
181148	78.00	12



*Convert to AC power with the following accessories: for single or multi-unit AC applications, order one (1) multi-unit transformer (104630) powers up to (8) units, and one (1) faucet AC connector (182538) per unit.

M•POWER™ Sensor-Operated Faucets

MODEL NUMBER	LIST PRICE	CASE QTY
--------------	------------	----------

BELOW-DECK SENSOR-OPERATED GOOSENECK MIXING FAUCET



- connection: 3/8" compression
- power source: 4 AA included with optional AC*
- flow type: multi-stream laminar
- water usage: 0.5 gpm (1.9 L/min) max.
- mount type: single mount
- supply length: 24"
- drain assembly: drain not included
- handle type: lever
- material: brass

8562	1150.00	3
<u>4" DECKPLATE SOLD SEPARATELY</u>		
182546	31.85	12
<u>8" DECKPLATE SOLD SEPARATELY</u>		
99558	41.85	20



BELOW-DECK SENSOR-OPERATED GOOSENECK FAUCET



- connection: 3/8" compression
- vandal resistant: yes
- power source: 4 AA included with optional AC*
- flow type: vandal resist multi-laminar
- water usage: 0.5 gpm (1.9 L/min) max.
- mount type: single mount
- supply length: 24"
- non-mixing: yes
- drain assembly: drain not included
- material: brass

CA8303	714.25	6
<u>4" DECKPLATE SOLD SEPARATELY</u>		
182546	31.85	12
<u>8" DECKPLATE SOLD SEPARATELY</u>		
99558	41.85	20



BELOW-DECK SENSOR-OPERATED GOOSENECK FAUCET WITHOUT SPOUT



- connection: 3/8" compression
- vandal resistant: yes
- power source: 4 AA included with optional AC*
- sold without spout: yes
- mount type: single mount
- supply length: 24"
- non-mixing: yes
- drain assembly: drain not included
- material: brass
- spout: not included

8565	664.25	3
<u>4" DECKPLATE SOLD SEPARATELY</u>		
182546	31.85	12
<u>8" DECKPLATE SOLD SEPARATELY</u>		
99558	41.85	20



*Convert to AC power with the following accessories: for single or multi-unit AC applications, order one (1) multi-unit transformer (104630) powers up to (8) units, and one (1) faucet AC connector (182538) per unit.

M•POWER™ Above-Deck Sensor-Operated Faucets



M•POWER™ Above-Deck Sensor-Operated Lavatory Faucet / 8551 Series

COMMERCIAL

M•POWER™ Sensor-Operated Faucets

MODEL NUMBER LIST PRICE CASE QTY

ABOVE-DECK SENSOR-OPERATED MODERN FAUCET



- connection: 3/8" compression
- vandal resistant: yes
- power source: battery-powered (4 AA included)
- flow type: vandal resist multi-laminar
- water usage: 0.5 gpm (1.9 L/min) max.
- mount type: single mount
- supply length: 24"
- non-mixing: yes
- drain assembly: drain not included

8551	667.55	6
<u>4" DECKPLATE SOLD SEPARATELY</u>		
99556	32.55	20
<u>8" DECKPLATE SOLD SEPARATELY</u>		
99558	41.85	20



AC ABOVE-DECK SENSOR-OPERATED MODERN FAUCET



- connection: 3/8" compression
- vandal resistant: yes
- power source: ac powered
- flow type: vandal resist multi-laminar
- water usage: 0.5 gpm (1.9 L/min) max.
- mount type: single mount
- supply length: 24"
- non-mixing: yes
- drain assembly: drain not included

8551AC	685.75	6
<u>4" DECKPLATE SOLD SEPARATELY</u>		
99556	32.55	20
<u>8" DECKPLATE SOLD SEPARATELY</u>		
99558	41.85	20



ABOVE-DECK SENSOR-OPERATED MODERN MIXING FAUCET



- connection: 3/8" compression
- vandal resistant: yes
- power source: battery-powered (4 AA included)
- flow type: vandal resist multi-laminar
- water usage: 0.5 gpm (1.9 L/min) max.
- mount type: single mount
- supply length: 24"
- temperature & manual override: yes
- drain assembly: drain not included
- handle type: lever

8552	737.75	6
<u>4" DECKPLATE SOLD SEPARATELY</u>		
99556	32.55	20
<u>8" DECKPLATE SOLD SEPARATELY</u>		
99558	41.85	20



AC ABOVE-DECK SENSOR-OPERATED MODERN MIXING FAUCET



- connection: 3/8" compression
- vandal resistant: yes
- power source: ac powered
- flow type: vandal resist multi-laminar
- water usage: 0.5 gpm (1.9 L/min) max.
- mount type: single mount
- supply length: 24"
- temperature & manual override: yes
- drain assembly: drain not included
- handle type: lever

8552AC	737.75	6
<u>4" DECKPLATE SOLD SEPARATELY</u>		
99556	32.55	20
<u>8" DECKPLATE SOLD SEPARATELY</u>		
99558	41.85	20



For single or multi-unit AC applications, order one (1) multi-unit transformer (104630) powers up to (8) units

M•POWER™ Sensor-Operated Faucets

	MODEL NUMBER	LIST PRICE	CASE QTY
ABOVE-DECK SENSOR-OPERATED TRANSITIONAL FAUCET			
	8553	667.55	6
	4" DECKPLATE SOLD SEPARATELY		
	99557	32.55	20
	8" DECKPLATE SOLD SEPARATELY		
	99558	41.85	20

- connection: 3/8" compression
- vandal resistant: yes
- power source: battery-powered (4 AA included)
- flow type: vandal resist multi-laminar
- water usage: 0.5 gpm (1.9 L/min) max.
- mount type: single mount
- supply length: 24"
- non-mixing: yes
- drain assembly: drain not included



AC ABOVE-DECK SENSOR-OPERATED TRANSITIONAL FAUCET			
	8553AC	685.75	6
	4" DECKPLATE SOLD SEPARATELY		
	99557	32.55	20
	8" DECKPLATE SOLD SEPARATELY		
	99558	41.85	20

- connection: 3/8" compression
- vandal resistant: yes
- power source: ac powered
- flow type: vandal resist multi-laminar
- water usage: 0.5 gpm (1.9 L/min) max.
- mount type: single mount
- supply length: 24"
- non-mixing: yes
- drain assembly: drain not included



ABOVE-DECK SENSOR-OPERATED TRANSITIONAL MIXING FAUCET			
	8554	737.75	6
	4" DECKPLATE SOLD SEPARATELY		
	99557	32.55	20
	8" DECKPLATE SOLD SEPARATELY		
	99558	41.85	20

- connection: 3/8" compression
- vandal resistant: yes
- power source: battery-powered (4 AA included)
- flow type: vandal resist multi-laminar
- water usage: 0.5 gpm (1.9 L/min) max.
- mount type: single mount
- supply length: 24"
- temperature & manual override: yes
- drain assembly: drain not included
- handle type: lever



AC ABOVE-DECK SENSOR-OPERATED TRANSITIONAL MIXING FAUCET			
	8554AC	737.75	6
	4" DECKPLATE SOLD SEPARATELY		
	99557	32.55	20
	8" DECKPLATE SOLD SEPARATELY		
	99558	41.85	20

- connection: 3/8" compression
- vandal resistant: yes
- power source: ac powered
- flow type: vandal resist multi-laminar
- water usage: 0.5 gpm (1.9 L/min) max.
- mount type: single mount
- supply length: 24"
- temperature & manual override: yes
- drain assembly: drain not included
- handle type: lever



For single or multi-unit AC applications, order one (1) multi-unit transformer (104630) powers up to (8) units

M•POWER™ Sensor-Operated FaucetsMODEL
NUMBER LIST PRICE CASE
QTY**LOW-FLOW THERMOSTATIC MIXING VALVE**

- connection: 1/2" female thread; IPS
- includes: 3/8" compression adapters
- no of ports: three
- water usage: 0.35 gpm min. (1.32 L/min.)
- listed to ASSE1070

104451

173.00

12

THERMOSTATIC MIXING VALVE SERVICE KITS

Part No.	Description	List Price	Case Qty
175916	1/2" IPS Adapter Kit	14.95	12
175917	1/2" CC Adapter Kit	14.95	1
175918	1/2" Cold Expansion PEX Adapter Kit	14.95	12
181040	1/2" Crimp Ring PEX Adapter Kit	14.95	12
175921	3/8" Compression Adapter Kit	14.95	12
175925	Fitting Nut Kit	14.95	12
175926	Screen Washers and Seal Washer Kit	14.95	12

See page 499 for sensor-operated faucet accessories.

M•POWER™ Sensor-Operated Faucets

SENSOR-OPERATED FAUCET ACCESSORIES		
Part No.	Description	List Price
174055	Battery Housing for Above and Below-Deck Models	29.85
174056	Solenoid Repair Kit for All Above-Deck SKUs 8551, 8552, 8553, 8554, 8551AC, 8552AC, 8553AC, 8554AC	94.85
174057	Strain Relief and Sensor Cable Extension for 8551-8554	26.35
174060	Mounting Hardware for All Above-Deck SKUs 8551, 8552, 8553, 8554, 8551AC, 8552AC, 8553AC, 8554AC	16.70
174061	Manual Temperature Control Handle Kit 8552, 8554, 8552AC, 8554AC	23.40
174062	T10 Torx Key and Screw for All Above-Deck SKUs 8551, 8552, 8553, 8554, 8551AC, 8552AC, 8553AC, 8554AC	8.65
174065	In-Line Filter with Check Valve for All Above-Deck SKUs 8551, 8552, 8553, 8554, 8551AC, 8552AC, 8553AC, 8554AC	47.35
174066	Filter Screen for Filter Housing for All Above-Deck SKUs 8551, 8552, 8553, 8554, 8551AC, 8552AC, 8553AC, 8554AC	5.45
174334	Sensor and Bracket for 8551, 8552, 8551AC, 8552AC	187.35
174335	Sensor and Bracket for 8553, 8554, 8553AC, 8554AC	187.35
174336	Override Plug Button for 8552, 8552AC	18.55
174337	Override Plug Button for 8554, 8554AC	18.55
99556	4" Deckplate designed for 8551, 8551AC, 8552, 8552AC	32.55
99557	4" Deckplate designed for 8553, 8553AC, 8554, 8554AC	32.55
99558	8" Deckplate for 8559, CA8302, 8562, CA8303, 8565, 8551, 8551AC, 8552, 8552AC, 8553, 8553AC, 8554, 8554AC	41.85
52016F05	0.5 gpm Multi-Stream Laminar Flow Aerator	18.15
52016F10	1.0 gpm Aerator	18.15
S0030NA	Smooth-End Spout with 1.5 gpm Laminar Flow Base Insert	64.05
104630	Multi-Unit AC Transformer (powers up to 8 units)	96.35
182534	Control Box for Gooseneck and Above-Deck AC Models	48.90
182535	Control Box for CA83021, 8559, CA8302	131.80
182536	Control Box Wall Mounting Hardware	9.30
182537	IR Sensor Assembly and Bracket for Below-Deck Models	145.00
182538	AC Connector	20.50
182539	36" Cable for Gooseneck Models	42.90
182540	Cable Harness and Vandal Sleeve for Below-Deck Non-Mixing Models	49.60
182542	Centerset Deck Gasket for CA8301	15.90
182543	Transitional Deck Gasket for CA8302	15.80
182544	Modern Deck Gasket for 8559	15.80
182547	Override Plug Button	23.00
182546	4" Deckplate for 8559, CA8302, 8562, CA8303, 8565	31.85
Sensor-Operated Soap Dispenser Accessories		
182413	Non-Drip Foam Soap Pump	60.60
182414	1500mL Foam Soap Bottle	17.10
182415	Control Box for Sensor Soap	125.00
182416	Mounting Bracket, Vandal Shield and Mounting Hardware for Sensor Soap	92.80
182417	Soap Tube, O-Ring, Spout Barb and Soap Net	51.00
182418	Soap Net	31.90
182419	Vandal Sheathing for Sensor Soap	15.50
182420	Wire Vandal Sheathing for Sensor Soap	40.60
182421	D-Cell Battery Box for Sensor Soap	58.90
182422	Sensor, Bracket and Screw for Sensor Soap	145.00
182423	Mounting Hardware for Sensor Soap	13.30
181148	Transitional Deck Spacer for 8558	78.00
181149	Modern Deck Spacer for 8560	67.50

M•POWER™ Sensor-Operated Flush Valves

COMMERCIAL

M•POWER™ Sensor-Operated Flush Valve / 8312



M•POWER™ Sensor-Operated Flush Valves

1-1/2" DC SENSOR-OPERATED CLOSET FLUSH VALVE



- flush valve type: water closet
- GPF: 3.5 GPF (13.0LPF)
- vandal resistant: yes
- battery-powered (4 AA included)
- flush valve technology: accuset piston
- material: cast brass
- easy front battery access: yes
- mechanical override: yes

MODEL NUMBER	LIST PRICE	CASE QTY
8310S35	596.45	3



• GPF: 1.6 GPF (6.0 LPF)	8310	596.45	4
--------------------------	-------------	--------	---



• GPF: 1.28 GPF (4.8 LPF)	8311	596.45	4
---------------------------	-------------	--------	---



• GPF: 1.0/1.6 GPF (3.8/6.0 LPF)	8310DF16	626.20	4
----------------------------------	-----------------	--------	---



1-1/2" AC SENSOR-OPERATED CLOSET FLUSH VALVE



- flush valve type: water closet
- GPF: 1.6 GPF (6.0 LPF)
- vandal resistant: yes
- ac powered
- requires 12v transformer: sold separately
- flush valve technology: accuset piston
- material: cast brass
- easy front battery access: yes
- mechanical override: yes

8310AC16	596.45	4
-----------------	--------	---



• GPF: 1.28 GPF (4.8 LPF)	8311AC12	596.45	4
---------------------------	-----------------	--------	---



• GPF: 1.0/1.6 GPF (3.8/6.0 LPF)	8310ACDF16	626.20	4
----------------------------------	-------------------	--------	---



3/4" DC SENSOR-OPERATED URINAL FLUSH VALVE



- flush valve type: urinal
- GPF: 1.0 GPF (3.8LPF)
- vandal resistant: yes
- battery-powered (4 AA included)
- flush valve technology: accuset piston
- material: cast brass
- easy front battery access: yes
- mechanical override: yes

8312	596.45	4
-------------	--------	---



• GPF: 0.5 GPF (1.9 LPF)	8315	596.45	4
--------------------------	-------------	--------	---



• GPF: 0.125 GPF (0.5 LPF)	8316	596.45	4
----------------------------	-------------	--------	---



For single or multi-unit AC applications, order one (1) multi-unit transformer (104630) powers up to (8) units.

COMMERCIAL

M•POWER™ Sensor-Operated Flush Valves

	MODEL NUMBER	LIST PRICE	CASE QTY	
1-1/4" DC SENSOR-OPERATED URINAL FLUSH VALVE				
	<ul style="list-style-type: none"> flush valve type: urinal GPF: 1.0 GPF (3.8LPF) vandal resistant: yes battery-powered (4 AA included) flush valve technology: accuset piston material: cast brass easy front battery access: yes mechanical override: yes 	8314	596.45	6
	 			
3/4" AC SENSOR-OPERATED URINAL FLUSH VALVE				
	<ul style="list-style-type: none"> flush valve type: urinal GPF: 1.0 GPF (3.8LPF) vandal resistant: yes ac powered requires 12v transformer: sold separately flush valve technology: accuset piston material: cast brass easy front battery access: yes mechanical override: yes 	8312AC10	596.45	4
	 			
	<ul style="list-style-type: none"> GPF: 0.5 GPF (1.9 LPF) 	8315AC05	596.45	4
	   			
	<ul style="list-style-type: none"> GPF: 0.125 GPF (0.5 LPF) 	8316AC	596.45	4
	   			

COMMERCIAL

For single or multi-unit AC applications, order one (1) multi-unit transformer (104630) powers up to (8) units.

M•POWER™ Sensor-Operated Flush Valves

	MODEL NUMBER	LIST PRICE	CASE QTY
DC SENSOR-OPERATED CLOSET FLUSH VALVE RETROFIT KIT			



- flush valve type: water closet retro fit
- GPF: 3.5 GPF (13.0LPF)
- vandal resistant: yes
- battery-powered (4 AA included)
- flush valve technology: accuset piston
- material: cast brass
- easy front battery access: yes
- mechanical override: yes

8310SR35	499.10	3
-----------------	--------	---



8310R16	499.10	8
----------------	--------	---



8310SR128	499.10	3
------------------	--------	---



8310RDF16	524.00	4
------------------	--------	---



DC SENSOR-OPERATED URINAL FLUSH VALVE RETROFIT KIT			
-----------------------------------------------------------	--	--	--



- flush valve type: urinal retro fit
- GPF: 1.0 GPF (3.8LPF)
- vandal resistant: yes
- battery-powered (4 AA included)
- flush valve technology: accuset piston
- material: cast brass
- easy front battery access: yes
- mechanical override: yes

8312R10	499.10	8
----------------	--------	---



8312SR05	499.10	3
-----------------	--------	---



8312SR125	499.10	3
------------------	--------	---



COMMERCIAL

For single or multi-unit AC applications, order one (1) multi-unit transformer (104630) powers up to (8) units.

M•POWER™ Sensor-Operated Flush Valves

SENSOR-OPERATED FLUSH VALVE ACCESSORIES		
Part No.	Description	List Price
104585	1½" Flush Extension Tube-24"	120.65
104587	Flush Valve Trap Primer	147.05
104588	1" Sweat Kit, Flush Valve	27.65
104589	1" Sweat Kit, Flush Valve 6" Long	44.45
104555	1" Angle Stop Valve Flush Valve	112.55
104556	¾" Angle Stop Valve Flush Valve	112.55
104570	Vacuum Breaker Kit	18.40
104571	Brass Valve Body Nut Flush Valve	24.55
104578	1½" Brass Flush Valve Tube	46.95
104579	1¼" Brass Flush Tube	51.00
104580	¾" Brass Flush Tube	47.05
104581	1½" Top Spud Assembly	32.90
104582	1¼" Top Spud Assembly	29.95
104583	¾" Top Spud Assembly	25.75
104584	Urinal Tailpiece (24" x ¾")	76.60
104617	Flush Valve Battery Pack	29.80
104618	Front Shroud 1.6gpf	70.50
104619	Front Shroud 1.28gpf	70.50
104620	Front Shroud 3.5gpf	70.50
104621	Front Shroud 1.0gpf	70.50
104622	Front Shroud 0.5gpf	70.50
104623	Front Shroud 1.0/1.6gpf	70.50
104624	Front Shroud 0.125gpf	70.50
104625	Rear shroud DC	33.20
104626	Rear shroud AC	34.10
104627	Flush Valve Override Assembly	31.70
104628	Piston and Manifold Tool	93.80
104630	Multi-Unit AC Transformer (powers up to 8 units)	96.35
104631	AC Cover Tube and Escutcheon	31.80
104633	Solenoid Manifold and Tool	113.50
104634	Flush Valve Override Cap	22.40

M•DURA™ Heavy-Duty Manual Flush Valves



M•DURA™ Heavy-Duty Manual Urinal Flush Valve / 8312M Series

COMMERCIAL

M•DURA™ Heavy-Duty Manual Flush Valves

MODEL NUMBER LIST PRICE CASE QTY

1-1/2" MANUAL CLOSET FLUSH VALVE



- flush valve type: water closet
- GPF: 3.5 GPF (13.0LPF)
- flush valve technology: accuset piston
- material: cast brass

8310M35

185.80 Chrome

3



- GPF: 1.6 GPF (6.0 LPF)

8310M16

185.80 Chrome

3



- GPF: 1.28 GPF (4.8 LPF)

8310M128

185.80 Chrome

3



3/4" MANUAL URINAL FLUSH VALVE



- flush valve type: urinal
- GPF: 1.0 gpm (3.8L/min)
- flush valve technology: accuset piston
- material: cast brass

8312M10

185.80 Chrome

3



- GPF: 0.5 GPF (1.9 LPF)

8312M05

185.80 Chrome

3



- GPF: 0.125 GPF (0.5 LPF)

8312M0125

185.80 Chrome

3



1-1/4" MANUAL URINAL FLUSH VALVE



- flush valve type: urinal
- GPF: 1.0 GPF (3.8LPF)
- flush valve technology: accuset piston
- material: cast brass

8314M10





185.80 Chrome

3



COMMERCIAL

M•DURA™ Heavy-Duty Manual Flush Valves

		MODEL NUMBER	LIST PRICE	CASE QTY
MANUAL CLOSET FLUSH VALVE RETROFIT KIT				
	<ul style="list-style-type: none"> flush valve type: water closet retro fit GPF: 3.5 GPF (13.0LPF) flush valve technology: accuset piston material: cast brass 	8310MR35	149.50 Chrome	6
	<ul style="list-style-type: none"> GPF: 1.6 GPF (6.0 LPF) 	8310MR16	149.50 Chrome	6
	<ul style="list-style-type: none"> GPF: 1.28 GPF (4.8 LPF) 	8310MR128	149.50 Chrome	6
MANUAL URINAL FLUSH VALVE RETROFIT KIT				
	<ul style="list-style-type: none"> flush valve type: urinal retro fit GPF: 1.0 GPF (3.8LPF) flush valve technology: accuset piston material: cast brass 	8312MR10	149.50 Chrome	6
	<ul style="list-style-type: none"> GPF: 0.5 GPF (1.9 LPF) 	8312MR05	149.50 Chrome	6
	<ul style="list-style-type: none"> GPF: 0.125 GPF (0.5 LPF) 	8312MR0125	149.50 Chrome	6
1-1/2" MANUAL CLOSET FLUSH VALVE WITH BEDPAN WASHER				
	<ul style="list-style-type: none"> flush valve type: water closet GPF: 3.5 GPF (13.0LPF) flush valve technology: accuset piston material: cast brass 	8310BPW35	567.15 Chrome	2
	<ul style="list-style-type: none"> GPF: 1.6 GPF (6.0 LPF) 	8310BPW16	567.15 Chrome	2
BEDPAN WASHER DIVERTER KIT				
	<ul style="list-style-type: none"> flush valve type: bedpan washer diverter kit material: solid brass 	8310BPWR	410.05 Chrome	3

COMMERCIAL

M•DURA™ Heavy-Duty Manual Flush Valves**MANUAL FLUSH VALVE ACCESSORIES**

Part No.	Description	List Price
104540	M•DURA™ 2 1/4" Extension (standard) Nipple (compatible with Delany angle stops)	37.40
104541	M•DURA™ 1 3/4" Extension Nipple (compatible with Delany angle stops)	32.75
104542	M•DURA™ 2 3/4" Extension Nipple (compatible with Delany angle stops)	45.55
104543	M•DURA™ 3 1/4" Extension Nipple (compatible with Delany angle stops)	50.25
104544	M•DURA™ 3 3/4" Extension Nipple (compatible with Delany angle stops)	56.05
104545	M•DURA™ 4 1/4" Extension Nipple (compatible with Delany angle stops)	61.90
104546	M•DURA™ 2 1/8" Extension (standard) Nipple*	32.75
104547	M•DURA™ 2 1/2" Extension Nipple*	36.25
104548	M•DURA™ 3" Extension Nipple*	38.55
104549	M•DURA™ 3 1/2" Extension Nipple*	42.05
104550	M•DURA™ 4" Extension Nipple*	46.75
104551	M•DURA™ 4 1/2" Extension Nipple*	50.25
104552	M•DURA™ 5" Extension Nipple*	56.05
104553	M•DURA™ 5 1/2" Extension Nipple*	59.60
104554	M•DURA™ 6" Extension Nipple*	64.25
104555	M•DURA™ 1" Angle Stop	112.55
104556	M•DURA™ 3/4" Angle Stop	112.55
104557	M•DURA™ Angle Stop Repair Kit	19.70
104560	M•DURA™ Offset Flush Tube 2 21/2" x 1 1/2"	43.70
104561	M•DURA™ Cap Assembly	61.70
104563	M•DURA™ 3.5 gpf (13.2 lpf) Piston	82.95
104564	M•DURA™ 1.6 gpf (6.0 lpf) Piston	82.95
104565	M•DURA™ 1.28 gpf (4.8 lpf) Piston	82.95
104566	M•DURA™ 1.0 gpf (3.8 lpf) Piston	82.95
104567	M•DURA™ 0.5 gpf (1.9 lpf) Piston	82.95
104568	M•DURA™ 0.125 gpf (0.5 lpf) Piston	82.95
104569	M•DURA™ Handle Assembly	24.90
104570	M•DURA™ Vacuum Breaker Assembly	18.40
104571	M•DURA™ Body Nut	24.55
104572	M•DURA™ Angle Stop Replacement Cap	6.40
104578	M•DURA™ Flush Tube 8 1/2" x 1 1/2"	46.95
104579	M•DURA™ Flush Tube 8" x 1 1/4"	51.00
104580	M•DURA™ Flush Tube 8" x 1 3/4"	47.05
104581	M•DURA™ 1 1/2" Top Spud Assembly	32.90
104582	M•DURA™ 1 1/4" Top Spud Assembly	29.95
104583	M•DURA™ 3/4" Top Spud Assembly	25.75
104584	M•DURA™ Flush Extension Tube 24" x 3/4"	76.60
104585	M•DURA™ Flush Extension Tube 24" x 1 1/2"	120.65
104588	M•DURA™ Sweat Kit (1" supply) 3" length	27.65
104589	M•DURA™ Sweat Kit (1" supply) 6" length	44.45
104590	M•DURA™ Cap Assembly with 3.5 gpf Marking	26.45
104591	M•DURA™ Cap Assembly with 1.6 gpf Marking	26.45
104592	M•DURA™ Cap Assembly with 1.28 gpf Marking	26.45
104593	M•DURA™ Cap Assembly with 1.0 gpf Marking	26.45
104594	M•DURA™ Cap Assembly with 0.5 gpf Marking	26.45
104595	M•DURA™ Cap Assembly with 0.125 gpf Marking	26.45
104597	M•DURA™ Tail Piece and Interior Cap Tool	17.65
104598	M•DURA™ Sweat Kit (3/4" supply) 3" length	26.05
104599	M•DURA™ Sweat Kit (3/4" supply) 6" length	46.75
104609	M•DURA™ Piston Gaskets	10.20

BEDPAN WASHER ACCESSORIES

Part No.	Description	List Price
104573	M•DURA™ Bedpan Washer Seal Kit	23.80
104574	M•DURA™ Bedpan Washer Seal Kit	52.00
104575	M•DURA™ Bedpan Washer Arm Assembly	52.00
104577	M•DURA™ Bedpan Washer Spray Face	11.15
104600	M•DURA™ Offset Flush Tube 8" x 1 1/2"	50.20
SMA10000CH*	SecureMount™ anchors, 1 pair, for use with bedpan washer wallmount flange	30.05



M•DURA™ Heavy-Duty Showering



M•DURA™ Modern Heavy-Duty Shower System / T9342 Series

COMMERCIAL

M•DURA™ Heavy-Duty Showering

		MODEL NUMBER	LIST PRICE	FINISH/ CONNECTION	CASE QTY
MODERN POSI-TEMP® PRESSURE-BALANCING TUB/SHOWER					
	<ul style="list-style-type: none"> • connection: 1/2" • showerhead type: standard with handshower • # of showerhead functions: one-function • hose length: 69" • valve type: Posi-Temp®; transfer • slide bar: yes† • drop ell: yes • water usage: 2.5 gpm (9.5 L/min) max. • cartridge type: 1222HD • handshower functions: 1f with non-positive pause • valve sold separately 	T9343	488.70	Chrome	1
	<ul style="list-style-type: none"> • water usage: 1.5 gpm (5.7 L/min) max. • valve sold separately 	T9343EP15	488.70	Chrome	1
	<ul style="list-style-type: none"> • cartridge type: 1222HD • valve type: Posi-Temp® • # of ports: four 	8370HD	130.85	1/2" CC connection without integral stops	6
		8371HD	157.50	1/2" CC connection with integral stops	6
		8372HD	157.50	1/2" IPS connection with integral stops	6
		8373HD	157.50	1/2" PEX connection with integral stops	6
		8374HD	169.75	1/2" CPVC connection with integral stops	6
		8375HD	157.50	1/2" cold expansion PEX connection with integral stops	6
	<ul style="list-style-type: none"> • cartridge type: ceramic disc • valve type: transfer • # of ports: four • three distinct functions 	3360	192.60	Commercial three-function 1/2" transfer valve	6

COMMERCIAL

HOW TO ORDER A COMPLETE SHOWER

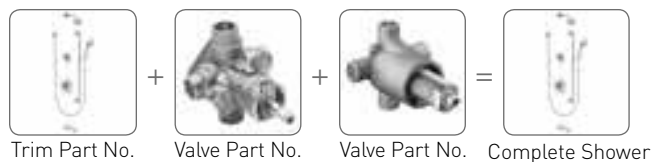











MoenPro.com

*The brass Posi-Temp® and Moentrol® valves meet ASSE 1016 compliance requirements for controlling temperature fluctuations when paired with Moen Commercial showerheads and handshowers with flow rates as low as 1.5 gpm (5.7 lpm).

† Slide bar is not a grab bar. Not to be used as support.

- ADA compliant (excluding holders, slide bars and diverting tub spout)
- BAA compliant
- WaterSense®
- Water-saving

M•DURA™ Heavy-Duty Showering



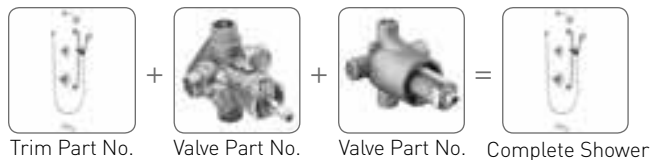

	MODEL NUMBER	LIST PRICE	FINISH/ CONNECTION	CASE QTY
MODERN POSI-TEMP® PRESSURE-BALANCING TUB/SHOWER WITH SLIDE BAR/GRAB BAR				
 <ul style="list-style-type: none"> • connection: 1/2" • showerhead type: standard with handshower • # of showerhead functions: one-function • hose length: 69" • valve type: Posi-Temp®; transfer • drop ell: yes • water usage: 2.5 gpm (9.5 L/min) max. • cartridge type: 1222HD • slidebar/grab bar: yes • handshower functions: 1f with non-positive pause • valve sold separately  	T9343GBM25	537.60	Chrome	1
	<ul style="list-style-type: none"> • water usage: 1.5 gpm (5.7 L/min) max. • valve sold separately    	T9343GBM15	537.60	Chrome
 <ul style="list-style-type: none"> • cartridge type: 1222HD • valve type: Posi-Temp® • # of ports: four 	8370HD	130.85	1/2" CC connection without integral stops	6
	8371HD	157.50	1/2" CC connection with integral stops	6
	8372HD	157.50	1/2" IPS connection with integral stops	6
	8373HD	157.50	1/2" PEX connection with integral stops	6
	8374HD	169.75	1/2" CPVC connection with integral stops	6
	8375HD	157.50	1/2" cold expansion PEX connection with integral stops	6
 <ul style="list-style-type: none"> • cartridge type: ceramic disc • valve type: transfer • # of ports: four • three distinct functions 	3360	192.60	Commercial three-function 1/2" transfer valve	6

HOW TO ORDER A COMPLETE SHOWER





MoenPro.com

*The brass Posi-Temp® and Moentrol® valves meet ASSE 1016 compliance requirements for controlling temperature fluctuations when paired with Moen Commercial showerheads and handshowers with flow rates as low as 1.5 gpm (5.7 lpm).

-  ADA compliant (excluding holders, slide bars and diverting tub spout)
-  BAA compliant
-  WaterSense®
-  Water-saving

COMMERCIAL

M•DURA™ Heavy-Duty Showering

	MODEL NUMBER	LIST PRICE	FINISH/ CONNECTION	CASE QTY
POSI-TEMP® PRESSURE-BALANCING TUB/SHOWER				
	<ul style="list-style-type: none"> • connection: 1/2" • showerhead type: standard with handshower • # of showerhead functions: one-function • hose length: 69" • valve included: yes • valve type: Posi-Temp®; transfer • slide bar: yes† • drop ell: yes • water usage: 2.5 gpm (9.5 L/min) max. • cartridge type: 1222HD • check stops: yes • valve meets ASSE performance requirements • handshower functions: 1f with non-positive pause 	8343	668.10 Chrome	1
	<ul style="list-style-type: none"> • water usage: 2.5 gpm (9.5 L/min) max. 	T8343	357.45 Chrome	1
	<ul style="list-style-type: none"> • valve sold separately 	T8343CBN	525.55 Classic Brushed Nickel	1
	<ul style="list-style-type: none"> • water usage: 1.5 gpm (5.7 L/min) max. 	T8343EP15	357.45 Chrome	1
	<ul style="list-style-type: none"> • valve sold separately 	T8343EP15CBN	525.55 Classic Brushed Nickel	1
<ul style="list-style-type: none"> • showerhead type: showerhead sold separately • valve sold separately 	T8343NH	349.35 Chrome	1	
	T8343NHCBN	481.05 Classic Brushed Nickel	1	
	<ul style="list-style-type: none"> • cartridge type: 1222HD • valve type: Posi-Temp® • # of ports: four 	8370HD	130.85 1/2" CC connection without integral stops	6
		8371HD	157.50 1/2" CC connection with integral stops	6
		8372HD	157.50 1/2" IPS connection with integral stops	6
		8373HD	157.50 1/2" PEX connection with integral stops	6
		8374HD	169.75 1/2" CPVC connection with integral stops	6
		8375HD	157.50 1/2" cold expansion PEX connection with integral stops	6
	<ul style="list-style-type: none"> • cartridge type: ceramic disc • valve type: transfer • # of ports: four • three distinct functions 	3360	192.60 Commercial three-function 1/2" transfer valve	6

COMMERCIAL



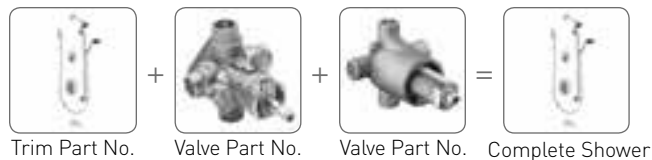

HOW TO ORDER A COMPLETE SHOWER





MoenoPro.com

*The brass Posi-Temp® and Moentrol® valves meet ASSE 1016 compliance requirements for controlling temperature fluctuations when paired with Moen Commercial showerheads and handshowers with flow rates as low as 1.5 gpm (5.7 lpm).

† Slide bar is not a grab bar. Not to be used as support.

-  ADA compliant (excluding holders, slide bars and diverting tub spout)
-  BAA compliant
-  WaterSense®
-  Water-saving

M•DURA™ Heavy-Duty Showering

	MODEL NUMBER	LIST PRICE	FINISH/ CONNECTION	CASE QTY
MODERN POSI-TEMP® PRESSURE-BALANCING SHOWER				
 <ul style="list-style-type: none"> • connection: 1/2" • showerhead type: standard with handshower • # of showerhead functions: one-function • hose length: 69" • valve type: Posi-Temp®; transfer • slide bar: yes† • drop ell: yes • water usage: 2.5 gpm (9.5 L/min) max. • cartridge type: 1222HD • handshower functions: 1f with non-positive pause • valve sold separately 	T9342	462.50	Chrome	1
	<ul style="list-style-type: none"> • water usage: 1.5 gpm (5.7 L/min) max. • valve sold separately 	T9342EP15	462.50	Chrome
 <ul style="list-style-type: none"> • cartridge type: 1222HD • valve type: Posi-Temp® • # of ports: four 	8370HD	130.85	1/2" CC connection without integral stops	6
	8371HD	157.50	1/2" CC connection with integral stops	6
	8372HD	157.50	1/2" IPS connection with integral stops	6
	8373HD	157.50	1/2" PEX connection with integral stops	6
	8374HD	169.75	1/2" CPVC connection with integral stops	6
	8375HD	157.50	1/2" cold expansion PEX connection with integral stops	6
 <ul style="list-style-type: none"> • cartridge type: ceramic disc • valve type: transfer • # of ports: four • three distinct functions 	3360	192.60	Commercial three-function 1/2" transfer valve	6



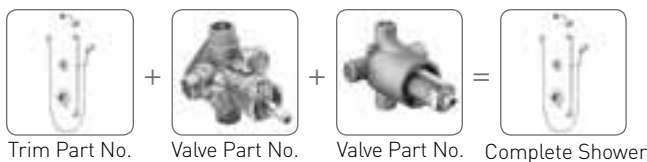

HOW TO ORDER A COMPLETE SHOWER





MoenPro.com

*The brass Posi-Temp® and Moentrol® valves meet ASSE 1016 compliance requirements for controlling temperature fluctuations when paired with Moen Commercial showerheads and handshowers with flow rates as low as 1.5 gpm (5.7 lpm).

† Slide bar is not a grab bar. Not to be used as support.

-  ADA compliant (excluding holders, slide bars and diverting tub spout)
-  BAA compliant
-  WaterSense®
-  Water-saving

M•DURA™ Heavy-Duty Showering

		MODEL NUMBER	LIST PRICE	FINISH/ CONNECTION	CASE QTY
MODERN POSI-TEMP® PRESSURE-BALANCING SHOWER WITH SLIDE BAR/GRAB BAR					
	<ul style="list-style-type: none"> • connection: 1/2" • showerhead type: standard with handshower • # of showerhead functions: one-function • hose length: 69" • valve type: Posi-Temp®; transfer • drop ell: yes • water usage: 2.5 gpm (9.5 L/min) max. • cartridge type: 1222HD • slidebar/grab bar: yes • handshower functions: 1f with non-positive pause • valve sold separately 	T9342GBM25	508.75	Chrome	1
	<ul style="list-style-type: none"> • water usage: 1.5 gpm (5.7 L/min) max. • valve sold separately 	T9342GBM15	508.75	Chrome	1
	<ul style="list-style-type: none"> • cartridge type: 1222HD • valve type: Posi-Temp® • # of ports: four 	8370HD	130.85	1/2" CC connection without integral stops	6
		8371HD	157.50	1/2" CC connection with integral stops	6
		8372HD	157.50	1/2" IPS connection with integral stops	6
		8373HD	157.50	1/2" PEX connection with integral stops	6
		8374HD	169.75	1/2" CPVC connection with integral stops	6
		8375HD	157.50	1/2" cold expansion PEX connection with integral stops	6
	<ul style="list-style-type: none"> • cartridge type: ceramic disc • valve type: transfer • # of ports: four • three distinct functions 	3360	192.60	Commercial three-function 1/2" transfer valve	6

COMMERCIAL

HOW TO ORDER A COMPLETE SHOWER

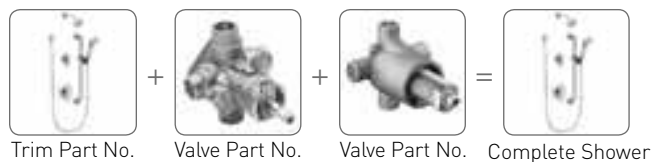



MoenPro.com

*The brass Posi-Temp® and Moentrol® valves meet ASSE 1016 compliance requirements for controlling temperature fluctuations when paired with Moen Commercial showerheads and handshowers with flow rates as low as 1.5 gpm (5.7 lpm).

- ADA compliant (excluding holders, slide bars and diverting tub spout)
- BAA compliant
- WaterSense®
- Water-saving

M•DURA™ Heavy-Duty Showering

	MODEL NUMBER	LIST PRICE	FINISH/ CONNECTION	CASE QTY
POSI-TEMP® PRESSURE-BALANCING SHOWER				
	<ul style="list-style-type: none"> • connection: 1/2" • showerhead type: standard with handshower • # of showerhead functions: one-function • hose length: 69" • valve included: yes • valve type: Posi-Temp®; transfer • slide bar: yes† • drop ell: yes • water usage: 2.5 gpm (9.5 L/min) max. • cartridge type: 1222HD • check stops: yes • valve meets ASSE performance requirements • handshower functions: 1f with non-positive pause 	8342	650.50 Chrome	1
	<ul style="list-style-type: none"> • water usage: 1.5 gpm (5.7 L/min) max. 	8342EP15	650.50 Chrome	1
	<ul style="list-style-type: none"> • water usage: 2.5 gpm (9.5 L/min) max. • valve sold separately 	T8342 T8342CBN	338.30 Chrome 497.30 Classic Brushed Nickel	1 1
	<ul style="list-style-type: none"> • water usage: 1.5 gpm (5.7 L/min) max. • valve sold separately 	T8342EP15 T8342EP15CBN	338.30 Chrome 497.30 Classic Brushed Nickel	1 1
	<ul style="list-style-type: none"> • showerhead type: showerhead sold separately • valve sold separately 	T8342NH T8342NHCBN	330.15 Chrome 452.80 Classic Brushed Nickel	1 1
	<ul style="list-style-type: none"> • cartridge type: 1222HD • valve type: Posi-Temp® • # of ports: four 	8370HD 8371HD 8372HD 8373HD 8374HD 8375HD	130.85 1/2" CC connection without integral stops 157.50 1/2" CC connection with integral stops 157.50 1/2" IPS connection with integral stops 157.50 1/2" PEX connection with integral stops 169.75 1/2" CPVC connection with integral stops 157.50 1/2" cold expansion PEX connection with integral stops	6 6 6 6 6 6
	<ul style="list-style-type: none"> • cartridge type: ceramic disc • valve type: transfer • # of ports: four • three distinct functions 	3360	192.60 Commercial three-function 1/2" transfer valve	6



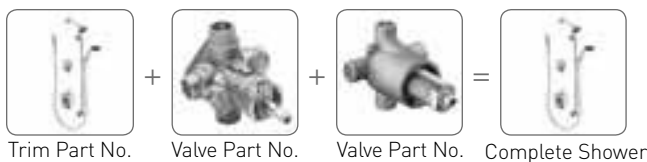

HOW TO ORDER A COMPLETE SHOWER



MoenPro.com



*The brass Posi-Temp® and Moentrol® valves meet ASSE 1016 compliance requirements for controlling temperature fluctuations when paired with Moen Commercial showerheads and handshowers with flow rates as low as 1.5 gpm (5.7 lpm).

† Slide bar is not a grab bar. Not to be used as support.

-  ADA compliant (excluding holders, slide bars and diverting tub spout)
-  BAA compliant
-  WaterSense®
-  Water-saving

COMMERCIAL

M•DURA™ Heavy-Duty Showering

		MODEL NUMBER	LIST PRICE	FINISH/ CONNECTION	CASE QTY
POSI-TEMP® PRESSURE-BALANCING TUB/SHOWER					
	<ul style="list-style-type: none"> • connection: 1/2" • showerhead type: handshower • # of showerhead functions: not applicable • hose length: 69" • valve included: yes • valve type: Posi-Temp®; transfer • slide bar: yes† • drop ell: yes • water usage: 2.5 gpm (9.5 L/min) max. • cartridge type: 1222HD • check stops: yes • valve meets ASSE performance requirements • handshower functions: 1f with non-positive pause 	8341	645.00	Chrome	1
	<ul style="list-style-type: none"> • water usage: 2.5 gpm (9.5 L/min) max. • valve sold separately 	T8341	332.35	Chrome	1
	<ul style="list-style-type: none"> • cartridge type: 1222HD • valve type: Posi-Temp® • # of ports: four 	8370HD	130.85	1/2" CC connection without integral stops	6
		8371HD	157.50	1/2" CC connection with integral stops	6
		8372HD	157.50	1/2" IPS connection with integral stops	6
		8373HD	157.50	1/2" PEX connection with integral stops	6
		8374HD	169.75	1/2" CPVC connection with integral stops	6
		8375HD	157.50	1/2" cold expansion PEX connection with integral stops	6
	<ul style="list-style-type: none"> • cartridge type: ceramic disc • valve type: transfer • # of ports: four • three distinct functions 	3360	192.60	Commercial three-function 1/2" transfer valve	6

COMMERCIAL



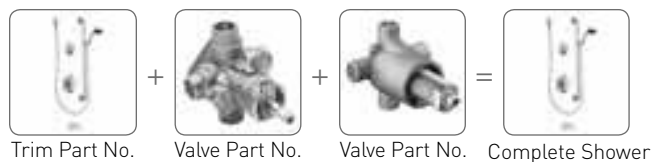

HOW TO ORDER A COMPLETE SHOWER





MoenPro.com

*The brass Posi-Temp® and Moentrol® valves meet ASSE 1016 compliance requirements for controlling temperature fluctuations when paired with Moen Commercial showerheads and handshowers with flow rates as low as 1.5 gpm (5.7 lpm).

† Slide bar is not a grab bar. Not to be used as support.

-  ADA compliant (excluding holders, slide bars and diverting tub spout)
-  BAA compliant
-  WaterSense®
-  Water-saving

M•DURA™ Heavy-Duty Showering

	MODEL NUMBER	LIST PRICE	FINISH/ CONNECTION	CASE QTY
MODERN POSI-TEMP® PRESSURE-BALANCING HANDSHOWER				
 <ul style="list-style-type: none"> • connection: 1/2" • showerhead type: handshower • # of showerhead functions: not applicable • hose length: 69" • valve type: Posi-Temp® • slide bar: yes† • drop ell: yes • water usage: 2.5 gpm (9.5 L/min) max. • cartridge type: 1222HD • handshower functions: 1f with non-positive pause • valve sold separately 	T9346	407.45	Chrome	4
	<ul style="list-style-type: none"> • water usage: 1.5 gpm (5.7 L/min) max. • valve sold separately 	T9346EP15	407.45	Chrome
 <ul style="list-style-type: none"> • cartridge type: 1222HD • valve type: Posi-Temp® • # of ports: four 	8370HD	130.85	1/2" CC connection without integral stops	6
	8371HD	157.50	1/2" CC connection with integral stops	6
	8372HD	157.50	1/2" IPS connection with integral stops	6
	8373HD	157.50	1/2" PEX connection with integral stops	6
	8374HD	169.75	1/2" CPVC connection with integral stops	6
	8375HD	157.50	1/2" cold expansion PEX connection with integral stops	6





HOW TO ORDER A COMPLETE SHOWER



MoenPro.com

*The brass Posi-Temp® and Moentrol® valves meet ASSE 1016 compliance requirements for controlling temperature fluctuations when paired with Moen Commercial showerheads and handshowers with flow rates as low as 1.5 gpm (5.7 lpm).

† Slide bar is not a grab bar. Not to be used as support.

-  ADA compliant (excluding holders, slide bars and diverting tub spout)
-  BAA compliant
-  WaterSense®
-  Water-saving

M•DURA™ Heavy-Duty Showering

	MODEL NUMBER	LIST PRICE	FINISH/ CONNECTION	CASE QTY
MODERN POSI-TEMP® PRESSURE-BALANCING HANDSHOWER WITH SLIDE BAR/GRAB BAR				
	<ul style="list-style-type: none"> • connection: 1/2" • showerhead type: handshower • # of showerhead functions: not applicable • hose length: 69" • valve type: Posi-Temp® • drop ell: yes • water usage: 2.5 gpm (9.5 L/min) max. • cartridge type: 1222HD • slidebar/grab bar: yes • handshower functions: 1f with non-positive pause • valve sold separately 	T9346GBM25	448.20 Chrome	1
	<ul style="list-style-type: none"> • water usage: 1.5 gpm (5.7 L/min) max. • valve sold separately 	T9346GBM15	448.20 Chrome	1
	<ul style="list-style-type: none"> • cartridge type: 1222HD • valve type: Posi-Temp® • # of ports: four 	8370HD	130.85 1/2" CC connection without integral stops	6
		8371HD	157.50 1/2" CC connection with integral stops	6
		8372HD	157.50 1/2" IPS connection with integral stops	6
		8373HD	157.50 1/2" PEX connection with integral stops	6
		8374HD	169.75 1/2" CPVC connection with integral stops	6
		8375HD	157.50 1/2" cold expansion PEX connection with integral stops	6

COMMERCIAL

HOW TO ORDER A COMPLETE SHOWER





MoenPro.com

*The brass Posi-Temp® and Moentrol® valves meet ASSE 1016 compliance requirements for controlling temperature fluctuations when paired with Moen Commercial showerheads and handshowers with flow rates as low as 1.5 gpm (5.7 lpm).

- ADA compliant (excluding holders, slide bars and diverting tub spout)
- BAA compliant
- WaterSense®
- Water-saving

M•DURA™ Heavy-Duty Showering

	MODEL NUMBER	LIST PRICE	FINISH/ CONNECTION	CASE QTY		
POSI-TEMP® PRESSURE-BALANCING HANDSHOWER						
 <ul style="list-style-type: none"> • connection: 1/2" • showerhead type: handshower • # of showerhead functions: not applicable • hose length: 69" • valve included: yes • valve type: Posi-Temp® • slide bar: yes† • drop ell: yes • water usage: 2.5 gpm (9.5 L/min) max. • cartridge type: 1222HD • check stops: yes • valve meets ASSE performance requirements • handshower functions: 1f with non-positive pause 	<ul style="list-style-type: none"> • ADA compliant • BAA compliant 	8346	461.85	Chrome	4	
	<ul style="list-style-type: none"> • water usage: 1.5 gpm (5.7 L/min) max. 	<ul style="list-style-type: none"> • ADA compliant • BAA compliant • WaterSense® • Water-saving 	8346EP15	461.85	Chrome	4
	<ul style="list-style-type: none"> • water usage: 2.5 gpm (9.5 L/min) max. • valve sold separately 	<ul style="list-style-type: none"> • ADA compliant • BAA compliant 	T8346	312.20	Chrome	4
			T8346CBN	442.70	Classic Brushed Nickel	4
	<ul style="list-style-type: none"> • water usage: 1.5 gpm (5.7 L/min) max. • valve sold separately 	<ul style="list-style-type: none"> • ADA compliant • BAA compliant • WaterSense® • Water-saving 	T8346EP15	312.20	Chrome	4
		T8346EP15CBN	442.70	Classic Brushed Nickel	4	
 <ul style="list-style-type: none"> • cartridge type: 1222HD • valve type: Posi-Temp® • # of ports: four 	<ul style="list-style-type: none"> • ADA compliant 	8370HD	130.85	1/2" CC connection without integral stops	6	
		8371HD	157.50	1/2" CC connection with integral stops	6	
		8372HD	157.50	1/2" IPS connection with integral stops	6	
		8373HD	157.50	1/2" PEX connection with integral stops	6	
		8374HD	169.75	1/2" CPVC connection with integral stops	6	
		8375HD	157.50	1/2" cold expansion PEX connection with integral stops	6	

HOW TO ORDER A COMPLETE SHOWER



MoenPro.com





*The brass Posi-Temp® and Moentrol® valves meet ASSE 1016 compliance requirements for controlling temperature fluctuations when paired with Moen Commercial showerheads and handshowers with flow rates as low as 1.5 gpm (5.7 lpm).

† Slide bar is not a grab bar. Not to be used as support.

- ADA compliant (excluding holders, slide bars and diverting tub spout)
- BAA compliant
- WaterSense®
- Water-saving

COMMERCIAL

M•DURA™ Heavy-Duty Showering

		MODEL NUMBER	LIST PRICE	FINISH/ CONNECTION	CASE QTY
MODERN POSI-TEMP® PRESSURE-BALANCING TUB/SHOWER					
	<ul style="list-style-type: none"> # of showerhead functions: one-function valve type: Posi-Temp® water usage: 2.5 gpm (9.5 L/min) max. cartridge type: 1222HD handshower functions: not applicable valve sold separately 	T9389	155.30	Chrome	3
	<ul style="list-style-type: none"> water usage: 1.5 gpm (5.7 L/min) max. valve sold separately 	T9389EP15	155.30	Chrome	3
					
	<ul style="list-style-type: none"> cartridge type: 1222HD valve type: Posi-Temp® # of ports: four 	8370HD 8371HD 8372HD 8373HD 8374HD 8375HD	130.85 157.50 157.50 157.50 169.75 157.50	1/2" CC connection without integral stops 1/2" CC connection with integral stops 1/2" IPS connection with integral stops 1/2" PEX connection with integral stops 1/2" CPVC connection with integral stops 1/2" cold expansion PEX connection with integral stops	6 6 6 6 6 6





COMMERCIAL

HOW TO ORDER A COMPLETE SHOWER









MoenPro.com

*The brass Posi-Temp® and Moentrol® valves meet ASSE 1016 compliance requirements for controlling temperature fluctuations when paired with Moen Commercial showerheads and handshowers with flow rates as low as 1.5 gpm (5.7 lpm).

-  ADA compliant (excluding holders, slide bars and diverting tub spout)
-  BAA compliant
-  WaterSense®
-  Water-saving

M•DURA™ Heavy-Duty Showering

	MODEL NUMBER	LIST PRICE	FINISH/ CONNECTION	CASE QTY	
POSI-TEMP® PRESSURE-BALANCING TUB/SHOWER					
	<ul style="list-style-type: none"> • connection: 1/2" • # of showerhead functions: one-function • valve included: yes • valve type: Posi-Temp® • water usage: 2.5 gpm (9.5 L/min) max. • cartridge type: 1222HD • check stops: yes • valve meets ASSE performance requirements • handshower functions: not applicable 	8389	238.85	Chrome	6
	<ul style="list-style-type: none"> • water usage: 1.5 gpm (5.7 L/min) max. 	8389EP15	238.85	Chrome	6
	<ul style="list-style-type: none"> • water usage: 2.5 gpm (9.5 L/min) max. • valve sold separately 	T8389	93.35	Chrome	3
		T8389CBN	145.80	Classic Brushed Nickel	3
	<ul style="list-style-type: none"> • water usage: 1.5 gpm (5.7 L/min) max. • valve sold separately 	T8389EP15	93.35	Chrome	3
		T8389EP15CBN	145.80	Classic Brushed Nickel	3
	<ul style="list-style-type: none"> • showerhead type: showerhead sold separately • valve sold separately 	T8389NH	77.95	Chrome	3
		T8389NHCBN	114.20	Classic Brushed Nickel	3
	<ul style="list-style-type: none"> • cartridge type: 1222HD • valve type: Posi-Temp® • # of ports: four 	8370HD	130.85	1/2" CC connection without integral stops	6
		8371HD	157.50	1/2" CC connection with integral stops	6
		8372HD	157.50	1/2" IPS connection with integral stops	6
		8373HD	157.50	1/2" PEX connection with integral stops	6
		8374HD	169.75	1/2" CPVC connection with integral stops	6
		8375HD	157.50	1/2" cold expansion PEX connection with integral stops	6





HOW TO ORDER A COMPLETE SHOWER



Trim Part No. + Valve Part No. = Complete Shower



MoenPro.com

*The brass Posi-Temp® and Moentrol® valves meet ASSE 1016 compliance requirements for controlling temperature fluctuations when paired with Moen Commercial showerheads and handshowers with flow rates as low as 1.5 gpm [5.7 lpm].

-  ADA compliant (excluding holders, slide bars and diverting tub spout)
-  BAA compliant
-  WaterSense®
-  Water-saving

COMMERCIAL

M•DURA™ Heavy-Duty Showering

		MODEL NUMBER	LIST PRICE	FINISH/ CONNECTION	CASE QTY
MODERN POSI-TEMP® PRESSURE-BALANCING SHOWER					
	<ul style="list-style-type: none"> # of showerhead functions: one-function valve type: Posi-Temp® water usage: 2.5 gpm (9.5 L/min) max. cartridge type: 1222HD handshower functions: not applicable valve sold separately 	T9375	122.05	Chrome	3
	<ul style="list-style-type: none"> water usage: 1.5 gpm (5.7 L/min) max. valve sold separately 	T9375EP15	122.05	Chrome	3
	<ul style="list-style-type: none"> cartridge type: 1222HD valve type: Posi-Temp® # of ports: four 	8370HD 8371HD 8372HD 8373HD 8374HD 8375HD	130.85 157.50 157.50 157.50 169.75 157.50	1/2" CC connection without integral stops 1/2" CC connection with integral stops 1/2" IPS connection with integral stops 1/2" PEX connection with integral stops 1/2" CPVC connection with integral stops 1/2" cold expansion PEX connection with integral stops	6 6 6 6 6 6





COMMERCIAL

HOW TO ORDER A COMPLETE SHOWER







MoenPro.com

*The brass Posi-Temp® and Moentrol® valves meet ASSE 1016 compliance requirements for controlling temperature fluctuations when paired with Moen Commercial showerheads and handshowers with flow rates as low as 1.5 gpm (5.7 lpm).

-  ADA compliant (excluding holders, slide bars and diverting tub spout)
-  BAA compliant
-  WaterSense®
-  Water-saving

M•DURA™ Heavy-Duty Showering

	MODEL NUMBER	LIST PRICE	FINISH/ CONNECTION	CASE QTY
POSI-TEMP® PRESSURE-BALANCING SHOWER				
 <ul style="list-style-type: none"> • connection: 1/2" • # of showerhead functions: one-function • valve included: yes • valve type: Posi-Temp® • water usage: 2.5 gpm (9.5 L/min) max. • cartridge type: 1222HD • check stops: yes • valve meets ASSE performance requirements • handshower functions: not applicable 	8375	209.15	Chrome	12
	 <ul style="list-style-type: none"> • water usage: 1.5 gpm (5.7 L/min) max. 	8375EP15	209.15	Chrome
 <ul style="list-style-type: none"> • water usage: 2.5 gpm (9.5 L/min) max. • valve sold separately 	T8375	60.95	Chrome	3
	T8375CBN	93.75	Classic Brushed Nickel	3
	T8375EP15	60.95	Chrome	3
	T8375EP15CBN	93.75	Classic Brushed Nickel	3
 <ul style="list-style-type: none"> • showerhead type: showerhead sold separately • valve sold separately 	T8375NH	43.15	Chrome	3
	T8375NHCBN	72.20	Classic Brushed Nickel	3
 <ul style="list-style-type: none"> • cartridge type: 1222HD • valve type: Posi-Temp® • # of ports: four 	8370HD	130.85	1/2" CC connection without integral stops	6
	8371HD	157.50	1/2" CC connection with integral stops	6
	8372HD	157.50	1/2" IPS connection with integral stops	6
	8373HD	157.50	1/2" PEX connection with integral stops	6
	8374HD	169.75	1/2" CPVC connection with integral stops	6
8375HD	157.50	1/2" cold expansion PEX connection with integral stops	6	





HOW TO ORDER A COMPLETE SHOWER



Trim Part No. + Valve Part No. = Complete Shower





MoenPro.com





*The brass Posi-Temp® and Moentrol® valves meet ASSE 1016 compliance requirements for controlling temperature fluctuations when paired with Moen Commercial showerheads and handshowers with flow rates as low as 1.5 gpm [5.7 lpm].

-  ADA compliant (excluding holders, slide bars and diverting tub spout)
-  BAA compliant
-  WaterSense®
-  Water-saving

COMMERCIAL

M•DURA™ Heavy-Duty Showering

		MODEL NUMBER	LIST PRICE	FINISH/ CONNECTION	CASE QTY
MODERN POSI-TEMP® PRESSURE-BALANCING VALVE CONTROL					
 <ul style="list-style-type: none"> • valve type: Posi-Temp® • handshower functions: not applicable • valve sold separately  		T9370	97.55	Chrome	3
	 <ul style="list-style-type: none"> • cartridge type: 1222HD • valve type: Posi-Temp® • # of ports: four 		8370HD	130.85	1/2" CC connection without integral stops
		8371HD	157.50	1/2" CC connection with integral stops	6
		8372HD	157.50	1/2" IPS connection with integral stops	6
		8373HD	157.50	1/2" PEX connection with integral stops	6
		8374HD	169.75	1/2" CPVC connection with integral stops	6
		8375HD	157.50	1/2" cold expansion PEX connection with integral stops	6

POSI-TEMP® PRESSURE-BALANCING VALVE CONTROL					
 <ul style="list-style-type: none"> • connection: 1/2" • valve included: yes • valve type: Posi-Temp® • cartridge type: 1222HD • check stops: yes • valve meets ASSE performance requirements • handshower functions: not applicable  		8370	185.60	Chrome	12
		T8370	35.25	Chrome	3
	T8370CBN	64.40	Classic Brushed Nickel	3	
 <ul style="list-style-type: none"> • cartridge type: 1222HD • valve type: Posi-Temp® • # of ports: four 		8370HD	130.85	1/2" CC connection without integral stops	6
		8371HD	157.50	1/2" CC connection with integral stops	6
		8372HD	157.50	1/2" IPS connection with integral stops	6
		8373HD	157.50	1/2" PEX connection with integral stops	6
		8374HD	169.75	1/2" CPVC connection with integral stops	6
		8375HD	157.50	1/2" cold expansion PEX connection with integral stops	6



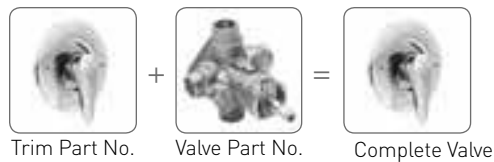

COMMERCIAL

HOW TO ORDER A COMPLETE VALVE







MoenPro.com

*The brass Posi-Temp® and Moentrol® valves meet ASSE 1016 compliance requirements for controlling temperature fluctuations when paired with Moen Commercial showerheads and handshowers with flow rates as low as 1.5 gpm [5.7 lpm].

-  ADA compliant (excluding holders, slide bars and diverting tub spout)
-  BAA compliant
-  WaterSense®
-  Water-saving

M•DURA™ Heavy-Duty Showering

	MODEL NUMBER	LIST PRICE	FINISH/ CONNECTION	CASE QTY
MOENTROL® PRESSURE-BALANCING VALVE CONTROL WITH VOLUME CONTROL				
 <ul style="list-style-type: none"> • connection: 1/2" • valve included: yes • valve type: Moentrol® • cartridge type: 1225 • check stops: yes • valve meets ASSE performance requirements • handshower functions: not applicable 	8350	244.65	Chrome	6
	T8350	62.25	Chrome	3
	T8350CBN	112.65	Classic Brushed Nickel	3
 <ul style="list-style-type: none"> • cartridge type: 1225 • valve type: Moentrol® • no of ports: four 	3520	158.10	1/2" CC Moentrol® valve	6
 <ul style="list-style-type: none"> • cartridge type: 1225 • valve type: Moentrol® • no of ports: four 	3570	188.35	Moentrol® 1/2" cc connections includes pressure balancing with check stops and volume control	6

MODERN THREE-FUNCTION TRANSFER VALVE CONTROL				
 <ul style="list-style-type: none"> • valve type: transfer • handshower functions: not applicable • valve sold separately 	T9360	124.80	Chrome	3
	3360	192.60	Commercial three-function 1/2" transfer valve	6
 <ul style="list-style-type: none"> • cartridge type: ceramic disc • valve type: transfer • no of ports: four • three distinct functions 				

COMMERCIAL

HOW TO ORDER A COMPLETE VALVE







MoenPro.com

*The brass Posi-Temp® and Moentrol® valves meet ASSE 1016 compliance requirements for controlling temperature fluctuations when paired with Moen Commercial showerheads and handshowers with flow rates as low as 1.5 gpm [5.7 lpm].

- ADA compliant (excluding holders, slide bars and diverting tub spout)
- BAA compliant
- WaterSense®
- Water-saving

M•DURA™ Heavy-Duty Showering

		MODEL NUMBER	LIST PRICE	FINISH/ CONNECTION	CASE QTY
THREE-FUNCTION TRANSFER VALVE CONTROL					
 <ul style="list-style-type: none"> • connection: 1/2" • valve included: yes • valve type: transfer • cartridge type: ceramic disc • handshower functions: not applicable 		8360	228.35	Chrome	6
	<ul style="list-style-type: none"> • valve sold separately 	T8360	45.10	Chrome	3
		T8360CBN	82.40	Classic Brushed Nickel	3
 <ul style="list-style-type: none"> • cartridge type: ceramic disc • valve type: transfer • no of ports: four • three distinct functions 		3360	192.60	Commercial three-function 1/2" transfer valve	6
ALIGN® THREE-FUNCTION TRANSFER VALVE CONTROL					
 <ul style="list-style-type: none"> • use with 3360 transfer valve • valve sold separately 		T4192	137.00	Chrome	12
		3360	192.60	Commercial three-function 1/2" transfer valve	6
 <ul style="list-style-type: none"> • cartridge type: ceramic disc • valve type: transfer • no of ports: four • three distinct functions 		3360	192.60	Commercial three-function 1/2" transfer valve	6



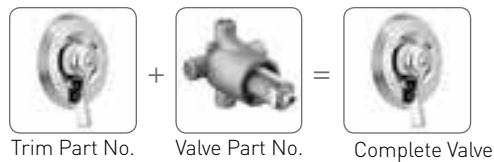

COMMERCIAL

HOW TO ORDER A COMPLETE VALVE



MoenPro.com

*The brass Posi-Temp® and Moentrol® valves meet ASSE 1016 compliance requirements for controlling temperature fluctuations when paired with Moen Commercial showerheads and handshowers with flow rates as low as 1.5 gpm [5.7 lpm].

-  ADA compliant (excluding holders, slide bars and diverting tub spout)
-  BAA compliant
-  WaterSense®
-  Water-saving

M•DURA™ Heavy-Duty Showering

	MODEL NUMBER	LIST PRICE	FINISH/ CONNECTION	CASE QTY
24" X 1-1/2" SLIDE BAR/GRAB BAR HANDSHOWER WITHOUT VALVE				
	<ul style="list-style-type: none"> showerhead type: eco-performance handshower hose length: 69" drop ell: yes water usage: 1.5 gpm (5.7 L/min) max. slidebar/grab bar: yes handshower functions: 1f with non-positive pause metal hose 	52224GBM15	241.00 Chrome/Stainless	3
		52224GBM15CBN	494.05 Classic Brushed Nickel	3
	<ul style="list-style-type: none"> water usage: 1.75 gpm (6.65 L/min) max. 	52224GBM17	241.00 Chrome/Stainless	3
	<ul style="list-style-type: none"> water usage: 2.5 gpm (9.5 L/min) max. 	52224GBM25	241.00 Chrome/Stainless	3

24" X 1-1/4" SLIDE BAR/GRAB BAR HANDSHOWER WITHOUT VALVE				
	<ul style="list-style-type: none"> showerhead type: handshower # of showerhead functions: not applicable hose length: 69" drop ell: yes water usage: 2.5 gpm (9.5 L/min) max. slidebar/grab bar: yes handshower functions: 1f with non-positive pause metal hose 	52124GBM25	235.65 Chrome/Stainless	3
		52124GBM25CBN	483.10 Classic Brushed Nickel	3

24" X 1-1/2" SLIDE BAR/GRAB BAR HANDSHOWER WITHOUT VALVE				
	<ul style="list-style-type: none"> showerhead type: handshower # of showerhead functions: not applicable hose length: 60" drop ell: yes water usage: 2.5 gpm (9.5 L/min) max. slidebar/grab bar: yes handshower functions: 1f with non-positive pause plastic hose 	52224GBP25	208.95 Chrome/Stainless	3

M•DURA™ Heavy-Duty Showering

	MODEL NUMBER	LIST PRICE	FINISH/ CONNECTION	CASE QTY
36" X 1-1/2" SLIDE BAR/GRAB BAR HANDSHOWER WITHOUT VALVE				
	<ul style="list-style-type: none"> showerhead type: eco-performance handshower # of showerhead functions: not applicable hose length: 69" drop ell: yes water usage: 1.5 gpm (5.7 L/min) max. slidebar/grab bar: yes handshower functions: 1f with non-positive pause metal hose 	52236GBM15	262.40 Chrome/Stainless	3
		52236GBM15CBN	536.85 Classic Brushed Nickel	3
	<ul style="list-style-type: none"> water usage: 1.75 gpm (6.65 L/min) max. 	52236GBM17	262.40 Chrome/Stainless	3
		52236GBM25	262.40 Chrome/Stainless	3

36" X 1-1/4" SLIDE BAR/GRAB BAR HANDSHOWER WITHOUT VALVE				
	<ul style="list-style-type: none"> showerhead type: handshower # of showerhead functions: not applicable hose length: 69" drop ell: yes water usage: 2.5 gpm (9.5 L/min) max. slidebar/grab bar: yes handshower functions: 1f with non-positive pause metal hose 	52136GBM25	257.00 Chrome/Stainless	3
		52136GBM25CBN	526.85 Classic Brushed Nickel	3

36" X 1-1/2" SLIDE BAR/GRAB BAR HANDSHOWER WITHOUT VALVE				
	<ul style="list-style-type: none"> showerhead type: handshower # of showerhead functions: not applicable hose length: 60" drop ell: yes water usage: 2.5 gpm (9.5 L/min) max. slidebar/grab bar: yes handshower functions: 1f with non-positive pause plastic hose 	52236GBP25	230.30 Chrome/Stainless	3

COMMERCIAL

M•DURA™ Heavy-Duty Showering





	MODEL NUMBER	LIST PRICE	FINISH/ CONNECTION	CASE QTY
HANDSHOWER WITHOUT VALVE				
 <ul style="list-style-type: none"> • connection: 1/2" • showerhead type: handshower • hose length: 69" • slide bar: yes† • drop ell: yes • water usage: 2.5 gpm (9.5 L/min) max. • handshower functions: 1f with non-positive pause 	52710	273.55	Chrome	6
	52710CBN	544.45	Classic Brushed Nickel	6
	52710EP15	273.55	Chrome	6
	52710EP15CBN	544.45	Classic Brushed Nickel	6

ENVI® THREE-FUNCTION HANDSHOWER WITHOUT VALVE				
 <ul style="list-style-type: none"> • showerhead type: eco-performance handshower • hose length: 69" • slide bar: yes† • drop ell: yes • water usage: 1.75 gpm (6.65 L/min) max. • handshower functions: three-function 	52740EP17	272.95	Chrome	6

HANDSHOWER WITHOUT VALVE				
 <ul style="list-style-type: none"> • showerhead type: handshower • hose length: 69" • drop ell: yes • water usage: 1.5 gpm (5.7 L/min) max. • handshower functions: 1f with non-positive pause 	52748EP15	199.55	Chrome	6

COMMERCIAL





† Slide bar is not a grab bar. Not to be used as support.



-  ADA compliant (excluding holders, slide bars and diverting tub spout)
-  BAA compliant
-  WaterSense®
-  Water-saving



M•DURA™ Heavy-Duty Showerheads

		MODEL NUMBER	LIST PRICE	FINISH/ CONNECTION	CASE QTY
MODERN HANDSHOWER					
	<ul style="list-style-type: none"> • connection: 1/2" • showerhead type: handshower • water usage: 2.5 gpm (9.5 L/min) max. • handshower functions: 1f with non-positive pause • integral double check valves in handshower 	9349	106.25	Chrome	6
	<ul style="list-style-type: none"> • water usage: 1.5 gpm (5.7 L/min) max. 	9349EP15	106.25	Chrome	6
HANDSHOWER					
	<ul style="list-style-type: none"> • showerhead type: handshower • water usage: 2.5 gpm (9.5 L/min) max. • handshower functions: 1f with non-positive pause • integral double check valves in handshower 	8349	74.85	Chrome	6
		8349CBN	109.00	Classic Brushed Nickel	6
	<ul style="list-style-type: none"> • water usage: 1.5 gpm (5.7 L/min) max. 	8349EP15	74.85	Chrome	6
		8349EP15CBN	109.00	Classic Brushed Nickel	6
	<ul style="list-style-type: none"> • water usage: 1.75 gpm (6.65 L/min) max. 	8349EP17	74.85	Chrome/Stainless	6
		8349EP17CBN	109.00	Classic Brushed Nickel	6
SHOWER ARM AND FLANGE					
	<ul style="list-style-type: none"> • all metal 	A705	52.50	Chrome	12
		A705CBN	78.75	Classic Brushed Nickel	12
MODERN VANDAL-RESISTANT SHOWERHEAD					
	<ul style="list-style-type: none"> • connection: 1/2" • # of showerhead functions: one-function • water usage: 2.5 gpm (9.5 L/min) max. • handshower functions: not applicable 	9263	72.20	Chrome	12
	<ul style="list-style-type: none"> • water usage: 1.5 gpm (5.7 L/min) max. 	9263EP15	72.20	Chrome	12

M•DURA™ Heavy-Duty Showerheads

VANDAL-RESISTANT SHOWERHEAD		MODEL NUMBER	LIST PRICE	FINISH/ CONNECTION	CASE QTY
	<ul style="list-style-type: none"> • connection: 1/2" • # of showerhead functions: one-function • water usage: 2.5 gpm (9.5 L/min) max. • handshower functions: not applicable 	5263	52.80	Chrome	12
		5263CBN	96.35	Classic Brushed Nickel	12
	<ul style="list-style-type: none"> • water usage: 1.5 gpm (5.7 L/min) max. 	5263EP15	52.80	Chrome	12
	 	5263EP15CBN	96.35	Classic Brushed Nickel	12
	<ul style="list-style-type: none"> • water usage: 1.75 gpm (6.65 L/min) max. 	5263EP17	52.80	Chrome	12
	 	5263EP17CBN	96.35	Classic Brushed Nickel	12

VANDAL-RESISTANT SHOWERHEAD		MODEL NUMBER	LIST PRICE	FINISH/ CONNECTION	CASE QTY
	<ul style="list-style-type: none"> • connection: 1/2" • # of showerhead functions: one-function • water usage: 1.5 gpm (5.7 L/min) max. • handshower functions: not applicable 	52716EP15	69.50	Chrome	20
 					

VANDAL-RESISTANT WALL-MOUNTED SHOWERHEAD		MODEL NUMBER	LIST PRICE	FINISH/ CONNECTION	CASE QTY
	<ul style="list-style-type: none"> • connection: 1/2" • # of showerhead functions: one-function • water usage: 2.5 gpm (9.5 L/min) max. • handshower functions: not applicable 	8290	118.40	Chrome	12
	<ul style="list-style-type: none"> • water usage: 1.5 gpm (5.7 L/min) max. 	8290EP15	113.80	Chrome	12
 					

VANDAL-RESISTANT WALL-MOUNTED SHOWERHEAD		MODEL NUMBER	LIST PRICE	FINISH/ CONNECTION	CASE QTY
	<ul style="list-style-type: none"> • connection: 1/2" • # of showerhead functions: one-function • water usage: 2.5 gpm (9.5 L/min) max. • handshower functions: not applicable 	8292	123.55	Chrome	12

M•DURA™ Heavy-Duty Showering Accessories



TUB/SHOWER ACCESSORIES			
Part No.	Finish	Description	List Price
15856	Chrome	Diverter tub spout, 1/2" slip fit, vandal-resistant	59.60
15856CBN	Classic Brushed Nickel	Diverter tub spout, 1/2" slip fit, vandal-resistant	86.75
100686	Chrome	Slide bar swivel bracket for handshower	49.70
100686CBN	Classic Brushed Nickel	Slide bar swivel bracket for handshower	71.45
101629	Chrome	30" adjustable slide bar with attaching hardware	137.25
101629CBN	Classic Brushed Nickel	30" adjustable slide bar with attaching hardware	199.85
104414	Chrome	Wall-mounted bracket for handshower	50.25
52711	---	Slide bar/Grab bar bracket - 1-1/2" diameter	49.55
52714	---	Slide bar/Grab bar bracket - 1-1/4" diameter	49.55
SMA1000CH**	---	SecureMount™ anchors, 1 pair, for use with bedpan washer wallmount flange and grab bars	30.05
A725	Chrome	Drop ell	47.60
A725CBN	Classic Brushed Nickel	Drop ell	69.75
A726	Chrome	69" metal hose (vacuum breaker sold separately)	91.10
A723	Chrome	59" plastic hose (vacuum breaker sold separately)	28.65
A780	Chrome	80" metal hose (vacuum breaker sold separately)	107.40
52703	Chrome	Optional vacuum breaker for handshower, 1/2" IPS connections	66.05
A714ST	Classic Brushed Nickel	Optional vacuum breaker for handshower, 1/2" IPS connections	55.45



**Moen Accessories part numbers are included for reference purposes only. Moen Accessories CANNOT be combined with Moen faucet parts on a purchase order.



 ADA compliant (excluding holders, slide bars and diverting tub spout)



 BAA compliant  WaterSense®  Water-saving



M•DURA™ Heavy-Duty Tub/Shower Valves

	MODEL NUMBER	LIST PRICE	FINISH/ CONNECTION	CASE QTY
BRASS POSI-TEMP® CARTRIDGE				
 <ul style="list-style-type: none"> graphite composite pressure-balancing spool design material: brass 	1222HD	93.95	N/A or Unfinished	18

BRASS POSI-TEMP® ROUGH-IN VALVE				
 <ul style="list-style-type: none"> cartridge type: 1222HD valve type: Posi-Temp® # of ports: four 	8370HD	130.85	1/2" CC	6





BRASS POSI-TEMP® ROUGH-IN VALVE				
 <ul style="list-style-type: none"> cartridge type: 1222HD valve type: Posi-Temp® # of ports: four stops: included 	8371HD	157.50	1/2" CC	6

BRASS POSI-TEMP® ROUGH-IN VALVE				
 <ul style="list-style-type: none"> cartridge type: 1222HD valve type: Posi-Temp® # of ports: four stops: included 	8372HD	157.50	1/2" IPS	6



BRASS POSI-TEMP® ROUGH-IN VALVE				
 <ul style="list-style-type: none"> cartridge type: 1222HD valve type: Posi-Temp® # of ports: four stops: included 	8373HD	157.50	1/2" crimp ring PEX	6



COMMERCIAL



*The brass Posi-Temp® and Moentrol® valves meet ASSE 1016 compliance requirements for controlling temperature fluctuations when paired with Moen Commercial showerheads and handshowers with flow rates as low as 1.5 gpm [5.7 lpm].



-  ADA compliant (excluding holders, slide bars and diverting tub spout)
-  BAA compliant
-  WaterSense®
-  Water-saving

M•DURA™ Heavy-Duty Tub/Shower Valves

	MODEL NUMBER	LIST PRICE	FINISH/ CONNECTION	CASE QTY
BRASS POSI-TEMP® ROUGH-IN VALVE				
	8374HD	169.75	1/2" CPVC	6
<ul style="list-style-type: none"> • cartridge type: 1222HD • valve type: Posi-Temp® • # of ports: four • stops: included 				

BRASS POSI-TEMP® ROUGH-IN VALVE				
	8375HD	157.50	1/2" cold expansion PEX	6
<ul style="list-style-type: none"> • cartridge type: 1222HD • valve type: Posi-Temp® • # of ports: four • stops: included 				

THREE-FUNCTION TRANSFER VALVE				
	3360	192.60	N/A or Unfinished	6
<ul style="list-style-type: none"> • cartridge type: ceramic disc • valve type: transfer • # of ports: four • three distinct functions 				

HIGH-FLOW THERMOSTATIC MIXING VALVE				
	104465	173.00	1/2" CC	12
<ul style="list-style-type: none"> • description: high flow thermostatic mixing valve for roman tubs • # of ports: three • water usage: 12 gpm (45.4 L/min) max. • ASSE standard 1070: yes 	104466	173.00	1/2" IPS	12



THERMOSTATIC MIXING VALVE SERVICE KITS

PART NO.	DESCRIPTION	LIST PRICE
175916	1/2" IPS Adapter Kit	14.95
175917	1/2" CC Adapter Kit	14.95
175918	1/2" Cold Expansion PEX Adapter Kit	14.95
181040	1/2" Crimp Ring PEX Adapter Kit	14.95
175921	3/8" Compression Adapter Kit	14.95
175925	Fitting Nut Kit	14.95
175726	Screen Washers and Seal Washer Kit	14.95

*The brass Posi-Temp® and Moentrol® valves meet ASSE 1016 compliance requirements for controlling temperature fluctuations when paired with Moen Commercial showerheads and handshowers with flow rates as low as 1.5 gpm (5.7 lpm).

 NSF 372 compliant

 ADA compliant (excluding holders, slide bars and diverting tub spout)

 BAA compliant  WaterSense®  Water-saving

Model No.	Finish	Product Description	UPC Code	List Price
A705	Chrome	Shower Flange and Shower Arm	026508240816	52.50
A705CBN	Classic Brushed Nickel	Shower Flange and Shower Arm	026508240823	78.75
A723	Chrome	59" Plastic Hose (vacuum breaker sold separately)	026508228654	28.65
12523	-	Stem Bushing Support, 14834 and 14848 Wrist-Blade Handles	026508053959	2.35
12828	Chrome	Kitchen Spout, 12" Long	026508036365	123.30
14690	-	Heavy-Duty Ceramic Cartridge 8100 Series Prior to 2005	026508025550	52.60
14695	-	Heavy-Duty Ceramic Cartridge 8100 Series Prior to 2005 (wide-spread)	026508025567	52.60
14750	Chrome	1 1/4" Grid Strainer Waste	026508005880	25.75
14834	Chrome	Wrist-Blade Handle, Hot Sani-Stream Models	026508035870	57.30
14834CBN	Classic Brushed Nickel	Wrist-Blade Handle Kit - Hot, Classic Brushed Nickel	026508239827	83.45
14838	Chrome	Wrist-Blade Handle, Cold Sani-Stream Models	026508035863	57.30
14838CBN	Classic Brushed Nickel	Wrist-Blade Handle Kit - Cold, Classic Brushed Nickel	026508239834	83.45
15856	Chrome	Diverter Spout, Slip Fit, Vandal-Resistant	026508015186	59.60
15856CBN	Classic Brushed Nickel	Diverter Spout, Slip Fit, Vandal-Resistant	026508239858	86.75
16000	Chrome	Handle Kit for Metering Faucet	026508167038	63.30
16264	Chrome	High-Arch Spout for 8940, 8796 and 8799	026508036129	114.55
16350	Chrome	Aerator 0.5 gpm Vandal-Resistant, Male Thread	026508036662	17.65
16352	-	Plastic Replacement Cartridge for 8884, 8886 and 8889	026508044896	103.30
52000	-	2-Handle Brass Shell Ceramic Disc Cartridge - Hot	026508160503	15.20
52001	-	2-Handle Brass Shell Ceramic Disc Cartridge - Cold	026508160510	15.20
52002	-	Cartridge Nut, O-Ring, Cover 8200 Series	026508160527	21.10
52003	Chrome	Widespread Escutcheon 8200 Series	026508160534	35.10
52005	-	Torx Head Wrench 8200 Series	026508160541	4.60
52006	-	Aerator 2.2 gpm Insert 8200 Series	026508160558	10.50
52008	Chrome	Lever Handle, Cold, 8200 Series	026508160572	23.40
52009	Chrome	Lever Handle, Hot, 8200 Series	026508160589	23.40
52010	Chrome	Wrist-Blade Handle, Cold, 8200 Series	026508165041	46.75
52011	Chrome	Wrist-Blade Handle, Hot, 8200 Series	026508165058	46.75
52012	Chrome	Vacuum Breaker Service Kit	026508182451	16.35
52015	Chrome	Handle Kits for Laboratory Faucets (hot or cold)	026508212554	43.25
52016	Chrome	Aerator 0.5 gpm Insert 8200 Series	026508165065	19.70
52016F03	-	0.35 gpm max. [1.3 lpm] Recessed Vandal-Resistant Rosetta Spray	026508236277	18.15
52016F05	-	0.5 gpm max. [1.9 lpm] Recessed Vandal-Resistant Rosetta Spray	026508236284	18.15
52016F15	-	1.5 gpm max. [5.7 lpm] Recessed Vandal-Resistant Aerator	026508236291	18.15
52016F22	-	2.2 gpm max. [8.3 lpm] Recessed Vandal-Resistant Aerator	026508236307	18.15
52019	Chrome	Wallmount Connections Kit for 8124 (1 per)	026508212561	61.90
52020	Chrome	Wallmount Connections Kit for 8230 (1 per)	026508212578	61.90
52021	Chrome	Widespread Spout 8200 Series	026508212585	107.50
52022	-	Set Screw for Widespread Spout Hub	026508212592	1.80
52023	Chrome	Widespread Mounting Kit for 8200 Series	026508212608	31.55
52024	-	Set Screw for Metering Handle	026508212615	1.80
52025	-	Friction Washers for S Series Spout (2 per)	026508212622	2.95
52028	-	Center Spout Hub for M•DURA™ Widespread Faucets	026508228340	58.35
52618	Chrome	0.35 gpm max. [1.3 lpm] Vandal-Resistant Rosetta Spray	026508035917	13.15
52652	Chrome	Laminar Flow Spout, Flow Control in Base, 1.5 gpm, Fits S-Series Spouts with Spout Ring	026508036198	28.10
52653	Chrome	Laminar Flow Spout, Flow Control in Base, 1.0 gpm, Fits S-Series Spouts with Spout Ring	026508029336	28.10
52655	Chrome	Laminar Flow Spout, Flow Control in Base, 0.5 gpm, Fits S-series Spouts without Spout Ring	026508029510	17.65
52703	Chrome	Optional Vacuum Breaker for Handshowers, 1/2" IPS Connections	026508026083	66.05
52711	-	Slide Bar/Grab Bar Bracket	026508228630	49.55
59001	Chrome	Modern 1-Handle Kit	026508012376	36.30
59002	-	Modern 1-Handle Retaining Nut and Cartridge	026508012383	29.75
59005	-	Aerator Key for Cache PCA JR	026508261613	4.30
59006	Chrome	Waste Assembly with Modern Lift Rod	026508012413	61.30
59007	-	Modern 1-Handle Mounting Hardware	026508007457	24.05
59008	Chrome	Modern Widespread Handle Kit	026508261491	37.30
59009	-	Modern Widespread Red/Blue Color Rings	026508261620	6.00
59010	Chrome	Modern Widespread Handle Hub Kit	026508261507	72.25
59011	-	Widespread Spout/Handle Mounting Kit	026508261514	25.15
59012	Chrome	Modern Widespread Spout, Diverting, 0.5 gpm	026508261637	170.50

Model No.	Finish	Product Description	UPC Code	List Price
59013	Chrome	Modern Widespread Spout, Diverting, 1.5 gpm	026508261644	170.50
59014	Chrome	Modern Widespread Spout, Nondiverting, 0.5 gpm	026508261651	171.65
59015	Chrome	Modern Widespread Spout, Nondiverting, 1.5 gpm	026508261668	171.65
59016	Chrome	Modern Shower Escutcheon	026508261521	30.55
59017	Chrome	Modern Shower Handle Lever Kit	026508261538	46.70
59018	Chrome	Modern 3-Function Escutcheon	026508261675	51.85
59019	Chrome	Modern 3-Function Handle Repair Kit	026508261682	58.90
59021	Chrome	Modern Tub Spout, Diverting	026508261545	88.95
59022	Chrome	Modern Tub Spout, Nondiverting	026508261699	82.20
59023	Chrome	Modern Tub Gate Kit15.35	026508261705	16.10
92191	Chrome	Tri-Blade Replacement Handles (2 per)	026508032923	52.55
93379	Chrome	Handle Cap with Color Indicators, All 1-Handle Lever Faucets	026508040089	18.40
93380	Chrome	Lever Handle Kit, 1-Handle Kitchen, 4"	026508040096	91.75
93385	Chrome	Lever Handle Kit, 1-Handle Lav, 2 1/2"	026508040140	89.10
93390	Chrome	Lever Handle Kit, 1-Handle Lav, 4"	026508040102	89.10
93410	Chrome	Handle Kit with Insert, 1-Handle Tub/Shower	026508026403	26.35
93415	Chrome	Easy Grip Handle Kit, 1-Handle Lav, Vandal-Proof	026508040218	47.95
93426	Chrome	Easy Grip Handle Kit, 1-Handle Tub/Shower, Vandal-Proof	026508040225	47.95
93455	Chrome	Escutcheon Screws, Torx for Posi-Temp 3/4 and Moentrol 3/4 1-Handle Tub/showers	026508040119	10.50
93455CBN	Classic Brushed Nickel	Escutcheon Screws, Classic Brushed Nickel	026508244722	12.20
99457	Chrome	4" Deckplate (for use with previous 8884 model)	026508049754	27.45
99550	Chrome	Anti-Rotation Deckplate for 8161 and 8884	026508207659	29.75
99551	Chrome	Anti-Rotation Deckplate for 8894	026508220689	29.75
99559	Chrome	Modern 4" Optional Deckplate	026508258859	32.55
100078	-	Handle Screw Kit, Sani-Stream 3-Function Transfer Valve	026508096284	20.45
100078CBN	Classic Brushed Nickel	Handle Screw Kit, Classic Brushed Nickel	026508244821	10.50
100079	Chrome	Lever Handle Kit, 3-Function Transfer Valve Kit	026508096291	34.55
100079CBN	Classic Brushed Nickel	Handle Repair Kit, Classic Brushed Nickel	026508239797	50.20
100080	-	Mounting Sleeve, 3-Function Transfer Valve	026508096307	47.95
100080CBN	Classic Brushed Nickel	Mounting Sleeve, Classic Brushed Nickel	026508244760	69.85
100087	-	Shower Function Label, 3-Function Transfer Valve	026508096321	7.65
100686	Chrome	Slide Bar Swivel for Handshower	026508057711	49.70
101629	Chrome	Adjustable 30" Slide Bar with Attaching Hardware	026508064375	137.25
101629CBN	Classic Brushed Nickel	Adjustable 30" Slide Bar with Attaching Hardware	026508246443	199.85
101867	Chrome	Temperature Limit Stop Kit, 1-Handle Lav	026508068373	12.60
101868	Chrome	Conversion Kit with Adjustable Temperature Limit Stop	026508068380	62.55
104424	Chrome	Mixing Valve, Includes Integral Check Valves	026508084229	64.35
104451	-	Thermostatic Mixing Valve	026508199282	173.00
104540	Chrome	M•DURA™ 2 1/4" Delany (standard) Nipple	026508245293	37.40
104541	Chrome	M•DURA™ 1 3/4" Delany Nipple	026508245309	32.75
104542	Chrome	M•DURA™ 2 3/4" Delany Nipple	026508245316	45.55
104543	Chrome	M•DURA™ 3 1/4" Delany Nipple	026508245323	50.25
104544	Chrome	M•DURA™ 3 3/4" Delany Nipple	026508245330	56.05
104545	Chrome	M•DURA™ 4 1/4" Delany Nipple	026508245347	61.90
104546	Chrome	M•DURA™ 2 1/8" Sloan (standard) Nipple	026508245354	32.75
104547	Chrome	M•DURA™ 2 1/2" Sloan Nipple	026508245361	36.25
104548	Chrome	M•DURA™ 3" Sloan Nipple	026508245378	38.55
104549	Chrome	M•DURA™ 3 1/2" Sloan Nipple	026508245385	42.05
104550	Chrome	M•DURA™ 4" Sloan Nipple	026508245392	46.75
104551	Chrome	M•DURA™ 4 1/2" Sloan Nipple	026508245408	50.25
104552	Chrome	M•DURA™ 5" Sloan Nipple	026508245415	56.05
104553	Chrome	M•DURA™ 5 1/2" Sloan Nipple	026508245422	59.60
104554	Chrome	M•DURA™ 6" Sloan Nipple	026508245439	64.25
104555	Chrome	M•DURA™ 1" Angle Stop Flush Valve	026508246535	112.55
104556	Chrome	M•DURA™ 3/4" Angle Stop Flush Valve	026508244074	112.55
104557	Chrome	M•DURA™ Angle Stop Repair Kit	026508244081	19.70
104561	Chrome	M•DURA™ Flush Valve Cap Assembly	026508246559	61.70
104563	-	3.5 gpf (13.2 lpf) Piston	026508245446	82.95
104564	-	1.6 gpf (6.0 lpf) Piston	026508246573	82.95
104565	-	1.28 gpf (4.8 lpf) Piston	026508245453	82.95
104566	-	1.0 gpf (3.8 lpf) Piston	026508245460	82.95

Model No.	Finish	Product Description	UPC Code	List Price
104567	-	0.5 gpf (1.9 lpf) Piston	026508245477	82.95
104568	-	0.125 gpf (0.5 lpf) Piston	026508245484	82.95
104569	Chrome	M•DURA™ Flush Valve Handle Assembly	026508245491	24.90
104570	Chrome	M•DURA™ Vacuum Breaker Assembly	026508245507	18.40
104571	Chrome	M•DURA™ Flush Valve Body Nut	026508246580	24.55
104572	Chrome	M•DURA™ Angle Stop Replacement Cap	026508245514	6.40
104573	Chrome	M•DURA™ Flush Valve Wallmount Assembly	026508246801	23.80
104574	Chrome	M•DURA™ Bedpan Washer Seal Kit	026508246818	52.00
104575	Chrome	M•DURA™ Bedpan Washer Arm Assembly	026508248010	52.00
104577	Chrome	M•DURA™ Bedpan Washer Spray Face	026508246825	11.15
104578	-	1 1/2" Flush Tube	026508244098	46.95
104579	-	1 1/4" Flush Tube	026508244104	51.00
104580	-	3/4" Flush Tube	026508244111	47.05
104581	-	1 1/2" Top Spud Assembly	026508244128	32.90
104582	-	1 1/4" Top Spud Assembly	026508246832	29.95
104583	-	3/4" Top Spud Assembly	026508246856	25.75
104584	-	Urinal Tailpiece 24" x 3/4"	026508247877	76.60
104585	-	Flush Extension Tube - 24"	026508247884	120.65
104588	-	1" Sweat Kit Flush Valve	026508246863	27.65
104589	-	1" Sweat Kit Flush Valve - 6"	026508246870	44.45
104590	-	M•DURA™ Cap Assembly 3.5 gpf	026508247426	26.45
104591	-	M•DURA™ Cap Assembly 1.6 gpf	026508247433	26.45
104592	-	M•DURA™ Cap Assembly 1.28 gpf	026508247440	26.45
104593	-	M•DURA™ Cap Assembly 1.0 gpf	026508247457	26.45
104594	-	M•DURA™ Cap Assembly .5 gpf	026508247464	26.45
104595	-	M•DURA™ Cap Assembly 0.125 gpf	026508247471	26.45
104597	-	M•DURA™ Flush Valve Tailpiece and Interior Cap Tool	026508246849	17.65
104770	Chrome	Metal Drain Assembly with Round Knob Lift Rod	026508210123	20.75
104775	Chrome	Metal Drain Assembly with Fluted Knob Lift Rod	026508210130	22.80
106321	-	Extension Kit, 3-Function Transfer Valve	026508085158	101.40
116715	Chrome	Spout Kit, 8948	026508133453	33.85
121520	Chrome	Lever Handle for 8413, 8414, 8417 Series	026508134757	22.15
121521	Chrome	Lever Handle for 8701	026508134740	19.70
121549	-	1-Handle Ceramic Disc Cartridge - Models 8413 Series	026508134719	22.80
121550	-	2-Handle Plastic Shell Ceramic Disc Cartridge - Hot	026508134726	12.75
121551	-	2-Handle Plastic Shell Ceramic Disc Cartridge - Cold	026508134733	12.75
121620	-	1-Handle Ceramic Disc Cartridge - Model 8701 (prior to 2010)	026508136683	22.80
129900	Chrome	Lever Handle Extended Reach 8416, 8418	026508165072	32.75
129901	Brushed Chrome	Lever Handle for 8414 Series	026508165089	29.20
129902	Brushed Nickel	Lever Handle for 8414 Series	026508165096	29.20
161380	Chrome	Moentrol 3/4 Escutcheon	026508260241	48.45
163215	-	Fixed Spout Clip for S-Series Spouts	026508255360	10.40
174066	-	Filter Screen for Filter Housing for All Above-Deck SKUs 8551, 8552, 8553, 8554, 8551AC, 8552AC, 8553AC, 8554AC	026508252789	5.45
174334	-	Sensor and Bracket for 8551, 8552, 8551AC, 8552AC	026508254387	187.35
174335	-	Sensor and Bracket for 8553, 8554, 8553AC, 8554AC	026508254394	187.35
174336	Chrome	Override Plug Button for 8552, 8552AC	026508254400	18.55
174337	Chrome	Override Plug Button for 8554, 8554AC	026508254417	18.55
175916	-	1/2" IPS Adapter Kit	026508261903	14.95
175917	-	1/2" CC Adapter Kit	026508261910	14.95
175918	-	1/2" Cold Expansion PEX Adapter Kit	026508261927	14.95
181040	-	1/2" Crimp Ring PEX Adapter Kit	026508266786	14.95
175921	-	3/8" Compression Adapter Kit	026508266755	14.95
175925	-	Fitting Nut Kit	026508266762	14.95
175926	-	Screen Washers and Seal Washer Kit	026508266779	14.95
840011	Chrome	3" Handle Kit	026508237076	86.50
840011CBN	Classic Brushed Nickel	3" Handle Kit	026508232999	129.75
840012	Chrome	4" Handle Kit	026508237083	86.50
840012CBN	Classic Brushed Nickel	4" Handle Kit	026508191354	129.75
840015F03	-	0.35 gpm max. (1.3 lpm) Recessed Vandal-Resistant Rosetta Spray	026508236338	13.15
840015F05	-	0.5 gpm max. (1.9 lpm) Recessed Vandal-Resistant Rosetta Spray	026508236345	13.15
840015F15	-	1.5 gpm max. (5.7 lpm) Recessed Vandal-Resistant Aerator	026508236369	13.15

Model No.	Finish	Product Description	UPC Code	List Price
840015F22	-	2.2 gpm max. (8.3 lpm) Recessed Vandal-Resistant Aerator	026508236352	13.15
870111	Chrome	Spout Assembly Kit	026508244135	119.65
870112	Chrome	Optional Single-Mount Escutcheon	026508244142	13.85
870113	Chrome	Optional Deckplate	026508244067	46.55
870114	Chrome	9" Spout Assembly Kit	026508244159	119.65
870115	Chrome	12" Spout Assembly Kit	026508244166	123.10
104598	Chrome	3" Sweat Kit for Urinals	026508251843	26.05
104599	Chrome	6" Sweat Kit for Urinals	026508251850	46.75
104600	Chrome	8" Offset Tube with 1- 1/2" Diameter	026508252536	50.20
104609	Chrome	Gaskets for Piston	026508251867	10.20
140860	-	Deck Gasket for 8210-8219 Series, 8886	026508253274	15.60
174055	-	Battery Housing for Above and Below-Deck Models	026508235799	29.85
174056	-	Solenoid Repair Kit for All Above-Deck SKUs 8551, 8552, 8553, 8554, 8551AC, 8552AC, 8553AC, 8554AC	026508235904	94.85
174057	-	Strain Relief and Sensor Cable Extension for 8551-8554	026508235911	26.35
174060	-	Mounting Hardware for All Above-Deck SKUs 8551, 8552, 8553, 8554, 8551AC, 8552AC, 8553AC, 8554AC	026508235942	16.70
174061	Chrome	Manual Temperature Control Handle Kit 8552, 8554, 8552AC, 8554AC	026508235959	23.40
174062	-	T10 Torx Key and Screw for All Above-Deck SKUs 8551, 8552, 8553, 8554, 8551AC, 8552AC, 8553AC, 8554AC	026508252765	8.65
174065	-	In-Line Filter with Check Valve for All Above-Deck SKUs 8551, 8552, 8553, 8554, 8551AC, 8552AC, 8553AC, 8554AC	026508252772	47.35
178466	Chrome	3F Transfer Valve Handle	026508260920	43.30
178467	Chrome	3F Transfer Valve Escutcheon Kit	026508260937	71.70
183073	-	Cage Spacer for 8138	026508271513	12.45
183082	-	Mounting Hardware Kit for 8138	026508271520	23.00
52016F12	Chrome	1.2 gpm max. (4.5 lpm) Recessed Vandal-Resistant Aerator	026508269619	9.85
52016SLC12	-	1.2 gpm max. (4.5 lpm) Recessed Vandal-Resistant SLC Aerator	026508269121	18.15
59003	-	M-Dura Adjustable Temperature Limit Stop and O-Ring	026508012390	14.80
59004	Chrome	M-DuraModern 1H Dome	026508012406	23.65
59024	Chrome	M-DuraModern Widespread Waste Assembly & Lift Rod	026508261552	76.85
59025	-	WS MDURA MOUNTING KIT (LIFT ROD VERSION)	026508261569	46.90
59027	Chrome	M-BitionModern 1H Handle Kit	026508264737	35.75
59029	Chrome	3/32 Set Screw with Allen Wrench	026508264744	5.30
59030	-	Modern 1H Lav Valve Body O-Ring	026508264751	5.10
59031	Chrome	M-Bition Waste Assembly	026508264768	42.30
59033	Chrome	M-Bition Widespread Lift Rod	026508264775	15.35
59034	Chrome	M-BitionModern Widespread Spout 1.2gpm with Lift Rod	026508264782	148.15
59035	Chrome	M-Bition Spout 1.2 gpm without Lift Rod	026508264799	146.10
59036	Chrome	M-Bition Widespread Handle Trim Kit	026508264805	71.50
59037	Chrome	M-Bition Widespread Handle Set Screw and Plug Button	026508264812	4.60
840015F12	-	1.2 gpm Recessed Vandal-Resistant Aerator	026508269640	29.00
99556	Chrome	4" Deckplate designed for 8551, 8551AC, 8552, 8552AC	026508252130	32.55
99557	Chrome	4" Deckplate designed for 8553, 8553AC, 8554, 8554AC	026508252147	32.55
99558	Chrome	8" Deckplate for 8559, CA8302, 8562, CA8303, 8565, 8551, 8551AC, 8552, 8552AC, 8553, 8553AC, 8554, 8554AC	026508252154	41.85
S0030NA	Chrome	Smooth-End Spout with 1.5 gpm Laminar Flow Base Insert	026508273821	64.05
104630	-	Multi-Unit AC Transformer (powers up to 8 units)	026508273609	96.35
182534	-	Control Box for Gooseneck and Above-Deck AC Models	026508273708	48.90
182535	-	Control Box for CA83021, 8559, CA8302	026508273715	131.80
182536	-	Control Box Wall Mounting Hardware	026508273722	9.30
182537	-	IR Sensor Assembly and Bracket for Below-Deck Models	026508273739	145.00
182538	-	AC Connector	026508273746	20.50
182539	-	36" Cable for Gooseneck Models	026508273753	42.90
182540	-	Cable Harness and Vandal Sleeve for Below-Deck Non-Mixing Models	026508273760	49.60
182542	-	Centerset Deck Gasket for CA8301	026508273777	15.90
182543	-	Transitional Deck Gasket for CA8302	026508273784	15.80
182544	-	Modern Deck Gasket for 8559	026508273791	15.80
182547	Chrome	Override Plug Button	026508273814	23.00
182546	Chrome	4" Deckplate for 8559, CA8302, 8562, CA8303, 8565	026508273807	31.85
182413	-	Non-Drip Foam Soap Pump	026508272305	60.60
182414	-	1500mL Foam Soap Bottle	026508272312	17.10

Model No.	Finish	Product Description	UPC Code	List Price
182415	-	Control Box for Sensor Soap	026508272329	125.00
182416	-	Mounting Bracket, Vandal Shield and Mounting Hardware for Sensor Soap	026508272336	92.80
182417	-	Soap Tube, O-Ring, Spout Barb and Soap Net	026508272343	51.00
182418	-	Soap Net	026508272350	31.90
182419	-	Vandal Sheathing for Sensor Soap	026508272367	15.50
182420	-	Wire Vandal Sheathing for Sensor Soap	026508272374	40.60
182421	-	D-Cell Battery Box for Sensor Soap	026508272381	58.90
182422	-	Sensor, Bracket and Screw for Sensor Soap	026508272398	145.00
182423	-	Mounting Hardware for Sensor Soap	026508272404	13.30
181148	Chrome	Transitional Deck Spacer for 8558	026508274491	78.00
181149	Chrome	Modern Deck Spacer for 8560	026508274507	67.50
104617	-	Flush Valve Battery Pack	026508273999	29.80
104618	Chrome	Front Shroud 1.6gpf	026508274002	70.50
104619	Chrome	Front Shroud 1.28gpf	026508274019	70.50
104620	Chrome	Front Shroud 3.5gpf	026508274026	70.50
104621	Chrome	Front Shroud 1.0gpf	026508274033	70.50
104622	Chrome	Front Shroud 0.5gpf	026508274040	70.50
104623	Chrome	Front Shroud 1.0/1.6gpf	026508274057	70.50
104624	Chrome	Front Shroud 0.125gpf	026508274064	70.50
104625	Chrome	Rear shroud DC	026508274071	33.20
104626	Chrome	Rear shroud AC	026508274088	34.10
104627	Chrome	Flush Valve Override Assembly	026508274095	31.70
104628	-	Piston and Manifold Tool	026508274101	93.80
104631	Chrome	AC Cover Tube and Escutcheon	026508274118	31.80
104633	-	Solenoid Manifold and Tool	026508274125	113.50
104634	Chrome	Flush Valve Override Cap	026508274132	22.40
100621CBN	Classic Brushed Nickel	Lever Handle Kit, Cold	026508244838	51.50
100624CBN	Classic Brushed Nickel	Lever Handle Kit, Hot	026508244777	51.50
104414	Chrome	Wall Bracket and Hardware for Handheld Shower	026508081525	50.25
104560	Chrome	1- 1/2" Offset Tail Piece	026508247891	43.70
104587	Chrome	Trap Primer	026508248614	147.05
150628CBN	Classic Brushed Nickel	Handle Dome	026508239841	10.40
162649	-	Extension Service Kit	026508234594	104.00
163127	-	Cartridge Kit	026508234563	109.65
163128	Chrome	Escutcheon	026508234570	68.35
163128CBN	Classic Brushed Nickel	Escutcheon	026508239865	102.55
16360	Chrome	Aerator Key	026508228944	4.95
166471	-	S-Spout O-Ring	026508246542	2.25
52016F10	-	1.0 gpm max. (3.8 lpm) Recessed Vandal-Resistant Aerator	026508228708	18.15
52035	Chrome	Lever Handle (Hot/Cold)	026508229576	23.40
54035	Chrome	4" Smooth Lever Handle	026508241455	33.00
54036	-	Hot/Cold Indicators for Smooth Handles	026508241462	10.80
881111	Chrome	Handle Kit 8894	026508235201	23.40
881121	Chrome	Widespread Metering Spout Kit	026508235249	107.50

Model No.	UPC	Page Number	Case Qty.	List Price
1222HD	0-26508 20760-4	533	18	93.95
3360	0-26508 22276-8	510	6	192.60
3520	0-26508 10232-9	525	6	158.10
3570	0-26508 07298-1	525	6	188.35
5263	0-26508 23721-2	531	12	52.80
5263CBN	0-26508 23722-9	531	12	96.35
5263EP15	0-26508 23723-6	531	12	52.80
5263EP15CBN	0-26508 23724-3	531	12	96.35
5263EP17	0-26508 23725-0	531	12	52.80
5263EP17CBN	0-26508 23726-7	531	12	96.35
8103	0-26508 16230-9	479	6	171.45
8106	0-26508 16232-3	479	6	231.45
8113	0-26508 16227-9	479	6	254.00
8116	0-26508 16231-6	479	6	314.00
8119	0-26508 16233-0	477	6	297.80
8121	0-26508 02520-8	477	6	241.60
8124	0-26508 02616-8	478	6	252.35
8125	0-26508 02618-2	476	6	183.30
8126	0-26508 16234-7	477	6	298.55
8137	0-26508 18547-6	476	6	240.45
8138	0-26508 19904-6	476	6	286.20
8161	0-26508 22771-8	476	6	145.35
8198	0-26508 14068-0	478	10	66.45
8199	0-26508 14069-7	478	10	48.40
8210	0-26508 15378-9	468	6	196.70
8210F05	0-26508 23543-0	468	6	196.70
8210F12	0-26508 26684-7	468	6	196.70
8210SM	0-26508 23863-9	468	6	196.70
8210SMF05	0-26508 25886-6	468	6	196.70
8210SMF12	0-26508 26685-4	468	6	196.70
8215	0-26508 16118-0	469	6	218.10
8215F03	0-26508 23544-7	469	6	218.10
8215F05	0-26508 23545-4	469	6	218.10
8215F12	0-26508 26694-6	469	6	218.10
8215SM	0-26508 23865-3	469	6	218.10
8215SMF12	0-26508 26683-0	469	6	218.10
8216	0-26508 01417-2	468	6	222.15
8218	0-26508 15512-7	468	6	215.75
8219	0-26508 16778-6	469	6	242.35
8220	0-26508 01596-4	466	6	308.10
8220F05	0-26508 23550-8	466	3	308.10
8223	0-26508 15541-7	466	6	341.90
8224	0-26508 15542-4	466	6	335.35
8225	0-26508 16243-9	472	6	319.85
8225SM	0-26508 23867-7	472	3	319.85
8225SMF15	0-26508 23868-4	472	3	319.85
8226	0-26508 15543-1	473	6	247.15
8227	0-26508 16225-5	473	6	300.40
8228	0-26508 16119-7	467	6	327.55
8228F05	0-26508 23552-2	467	3	327.55
8228F12	0-26508 26682-3	467	3	327.55
8229	0-26508 16226-2	472	6	266.70
8230	0-26508 17217-9	478	3	204.70
8232	0-26508 19905-3	478	6	296.20
8239	0-26508 01597-1	467	6	361.35
8242	0-26508 18548-3	473	6	344.60
8244	0-26508 18549-0	473	6	364.00
8248	0-26508 18108-9	472	6	313.25
8248SM	0-26508 23869-1	472	3	313.25
8248SMF12	0-26508 26707-3	472	3	313.25
8270	0-26508 15461-8	470	6	233.95
8272	0-26508 15462-5	470	6	245.25
8273	0-26508 18149-2	470	6	201.15
8274	0-26508 15544-8	470	6	188.60
8276	0-26508 16771-7	471	6	210.00
8277	0-26508 19906-0	477	6	212.85
8278	0-26508 16780-9	471	6	246.50
8278SM	0-26508 23871-4	471	6	246.50
8278SMF12	0-26508 26708-0	471	6	246.50
8279	0-26508 16781-6	471	6	266.75

Model No.	UPC	Page Number	Case Qty.	List Price
8279SM	0-26508 23873-8	471	6	262.30
8279SMF12	0-26508 26709-7	471	6	262.30
8280	0-26508 15463-2	474	6	236.90
8285	0-26508 16120-3	474	6	256.35
8287	0-26508 16223-1	474	6	295.30
8289	0-26508 16224-8	474	6	314.65
8290	0-26508 15406-9	531	12	118.40
8290EP15	0-26508 21336-0	531	12	113.80
8292	0-26508 17218-6	531	12	123.55
8310	0-26508 00641-2	501	4	596.45
8310AC16	0-26508 16764-9	501	4	596.45
8310ACDF16	0-26508 20596-9	501	4	626.20
8310BPW16	0-26508 24226-1	507	2	567.15
8310BPW35	0-26508 24225-4	507	2	567.15
8310BPWR	0-26508 24015-1	507	3	410.05
8310DF16	0-26508 20597-6	501	4	626.20
8310M128	0-26508 23652-9	506	3	185.80
8310M16	0-26508 23653-6	506	3	185.80
8310M35	0-26508 23654-3	506	3	185.80
8310MR128	0-26508 23655-0	507	6	149.50
8310MR16	0-26508 23921-6	507	6	149.50
8310MR35	0-26508 23656-7	507	6	149.50
8310R16	0-26508 16032-9	503	8	499.10
8310RDF16	0-26508 20598-3	503	4	524.00
8310S35	0-26508 26512-3	501	3	596.45
8310SR128	0-26508 26517-8	503	3	499.10
8310SR35	0-26508 26519-2	503	3	499.10
8311	0-26508 19907-7	501	4	596.45
8311AC12	0-26508 19909-1	501	4	596.45
8312	0-26508 15222-5	501	4	596.45
8312AC10	0-26508 16765-6	502	4	596.45
8312M0125	0-26508 23657-4	506	3	185.80
8312M05	0-26508 23658-1	506	3	185.80
8312M10	0-26508 23659-8	506	3	185.80
8312MR0125	0-26508 23660-4	507	6	149.50
8312MR05	0-26508 23661-1	507	6	149.50
8312MR10	0-26508 23662-8	507	6	149.50
8312R10	0-26508 16030-5	503	8	499.10
8312SR05	0-26508 26526-0	503	3	499.10
8312SR125	0-26508 26528-4	503	3	499.10
8314	0-26508 15223-2	502	6	596.45
8314M10	0-26508 23664-2	506	3	185.80
8315	0-26508 19908-4	501	4	596.45
8315AC05	0-26508 19910-7	502	4	596.45
8316	0-26508 20599-0	501	4	596.45
8316AC	0-26508 21322-3	502	4	596.45
8341	0-26508 07825-9	516	1	645.00
8342	0-26508 07826-6	515	1	650.50
8342EP15	0-26508 21337-7	515	1	650.50
8343	0-26508 08313-0	512	1	668.10
8346	0-26508 06334-7	519	4	461.85
8346EP15	0-26508 21338-4	519	4	461.85
8349	0-26508 01509-4	530	6	74.85
8349CBN	0-26508 23703-8	530	6	109.00
8349EP15	0-26508 21339-1	530	6	74.85
8349EP15CBN	0-26508 23704-5	530	6	109.00
8349EP17	0-26508 22864-7	530	6	74.85
8349EP17CBN	0-26508 23705-2	530	6	109.00
8350	0-26508 01467-7	525	6	244.65
8360	0-26508 08681-0	526	6	228.35
8370	0-26508 01396-0	524	12	185.60
8370HD	0-26508 22847-0	510	6	130.85
8371HD	0-26508 22848-7	510	6	157.50
8372HD	0-26508 22849-4	510	6	157.50
8373HD	0-26508 22850-0	510	6	157.50
8374HD	0-26508 22851-7	510	6	169.75
8375	0-26508 04042-3	523	12	209.15
8375EP15	0-26508 21340-7	523	12	209.15
8375HD	0-26508 23980-3	510	6	157.50
8389	0-26508 04043-0	521	6	238.85

Model No.	UPC	Page Number	Case Qty.	List Price	Model No.	UPC	Page Number	Case Qty.	List Price
8389EP15	0-26508 21341-4	521	6	238.85	8922	0-26508 03917-5	488	6	253.60
8400	0-26508 01506-3	486	6	176.35	8922CBN	0-26508 23541-6	488	6	304.40
8413	0-26508 12971-5	465	6	168.40	8924	0-26508 03920-5	488	6	271.40
8413F03	0-26508 23444-0	465	3	168.40	8938	0-26508 00395-4	491	6	163.20
8413F05	0-26508 23445-7	465	3	168.40	8940	0-26508 01376-2	491	6	233.20
8413F12	0-26508 26656-4	465	3	168.40	8948	0-26508 06169-5	491	6	161.00
8414	0-26508 13712-3	465	6	201.00	8957	0-26508 03026-4	491	12	125.70
8414F12	0-26508 26995-4	465	3	201.00	9220F05	0-26508 25539-1	466	3	317.40
8414F12BN	0-26508 27177-3	465	3	260.05	9220F12	0-26508 26695-3	466	3	317.40
8416	0-26508 01727-2	465	6	180.90	9223F05	0-26508 25730-2	466	3	352.65
8416F05	0-26508 23447-1	465	3	180.90	9223F12	0-26508 26696-0	466	3	352.65
8417	0-26508 12972-2	464	6	232.65	9263	0-26508 25542-1	530	12	72.20
8417F05	0-26508 23449-5	464	6	232.65	9263EP15	0-26508 25543-8	530	12	72.20
8417F12	0-26508 26657-1	464	6	232.65	9349	0-26508 25544-5	530	6	106.25
8418	0-26508 15080-1	464	6	244.55	9349EP15	0-26508 25545-2	530	6	106.25
8419F05	0-26508 22784-8	464	6	264.30	9417F05	0-26508 25729-6	463	3	257.50
8419F12	0-26508 26658-8	464	6	264.30	9417F12	0-26508 26697-7	463	3	257.50
8420	0-26508 01507-0	486	6	204.65	9419F05	0-26508 25548-3	463	3	286.10
8420CBN	0-26508 23532-4	486	12	255.85	9419F12	0-26508 26698-4	463	3	286.10
8422	0-26508 23212-5	486	12	185.05	9480	0-26508 25549-0	486	3	159.35
8422F05	0-26508 23214-9	486	12	185.05	9482	0-26508 25550-6	486	3	177.05
8425	0-26508 01508-7	486	6	199.25	9921	0-26508 25551-3	488	3	229.45
8430	0-26508 06645-4	487	12	137.90	9922	0-26508 25552-0	488	3	254.95
8430CBN	0-26508 23534-8	487	12	172.45	15856	0-26508 01518-6	532	12	59.60
8430F05	0-26508 23215-6	487	12	137.90	15856CBN	0-26508 23985-8	532	12	86.75
8432	0-26508 06646-1	487	12	169.70	52016F05	0-26508 23628-4	499	24	18.15
8432F05	0-26508 26470-6	487	12	169.70	52016F10	0-26508 22870-8	499	24	18.15
8434	0-26508 06647-8	487	12	163.60	52100	0-26508 20763-5	484	24	82.95
8437	0-26508 23216-3	487	12	178.55	52120	0-26508 20704-8	470	12	154.00
8437CBN	0-26508 23535-5	487	12	223.20	52124GBM25	0-26508 23411-2	527	3	235.65
8439	0-26508 23217-0	487	12	146.80	52124GBM25CBN	0-26508 23412-9	527	3	483.10
8439F05	0-26508 23267-5	487	12	146.80	52136GBM25	0-26508 19133-0	528	3	257.00
8551	0-26508 24990-1	496	6	667.55	52136GBM25CBN	0-26508 19134-7	528	3	526.85
8551AC	0-26508 24991-8	496	6	685.75	52224GBM15	0-26508 22696-4	527	3	241.00
8552	0-26508 24992-5	496	6	737.75	52224GBM15CBN	0-26508 23697-0	527	3	494.05
8552AC	0-26508 24993-2	496	6	737.75	52224GBM17	0-26508 22697-1	527	3	241.00
8553	0-26508 24994-9	497	6	667.55	52224GBM25	0-26508 22699-5	527	3	241.00
8553AC	0-26508 24995-6	497	6	685.75	52224GBP25	0-26508 22700-8	527	3	208.95
8554	0-26508 24996-3	497	6	737.75	52236GBM15	0-26508 22701-5	528	3	262.40
8554AC	0-26508 24997-0	497	6	737.75	52236GBM15CBN	0-26508 23700-7	528	3	536.85
8558	0-26508 27199-5	493	3	495.00	52236GBM17	0-26508 22702-2	528	3	262.40
8559	0-26508 27148-3	493	6	647.70	52236GBM25	0-26508 22704-6	528	3	262.40
8560	0-26508 27200-8	493	3	495.00	52236GBP25	0-26508 22695-7	528	3	230.30
8562	0-26508 27149-0	494	3	1,150.00	52703	0-26508 02608-3	532	12	66.05
8565	0-26508 27150-6	494	3	664.25	52710	0-26508 06336-1	529	6	273.55
8701	0-26508 12973-9	475	12	145.40	52710CBN	0-26508 23710-6	529	6	544.45
8707	0-26508 20651-5	475	6	173.25	52710EP15	0-26508 21334-6	529	6	273.55
8711	0-26508 02028-9	475	6	217.35	52710EP15CBN	0-26508 23714-4	529	6	544.45
8713	0-26508 02095-1	475	12	436.45	52711	0-26508 22863-0	532	12	49.55
8714	0-26508 01593-3	475	12	449.95	52714	0-26508 24987-1	532	12	49.55
8717	0-26508 23764-9	475	6	256.80	52716EP15	0-26508 21335-3	531	20	69.50
8780	0-26508 02185-9	490	6	117.80	52740EP17	0-26508 22852-4	529	6	272.95
8791	0-26508 12570-0	490	6	138.85	52748EP15	0-26508 23475-4	529	6	199.55
8792	0-26508 12571-7	490	6	268.95	99550	0-26508 20765-9	476	12	29.75
8798	0-26508 00393-0	490	6	188.85	99551	0-26508 22068-9	483	12	29.75
8799	0-26508 01377-9	490	6	246.20	99556	0-26508 25213-0	496	20	32.55
8800	0-26508 00777-8	489	6	163.65	99557	0-26508 25214-7	497	20	32.55
8800CBN	0-26508 23537-9	489	6	200.65	99558	0-26508 25215-4	496	20	41.85
8800F05	0-26508 23531-7	489	6	163.65	99559	0-26508 25885-9	486	20	32.55
8810	0-26508 00778-5	489	6	187.65	100686	0-26508 05771-1	532	60	49.70
8820	0-26508 00779-2	489	6	193.35	100686CBN	0-26508 24643-6	532	60	71.45
8820CBN	0-26508 23538-6	489	6	237.10	101629	0-26508 06437-5	532	9	137.25
8884	0-26508 09323-8	483	6	177.15	101629CBN	0-26508 24644-3	532	1	199.85
8886	0-26508 09324-5	483	6	326.55	104414	0-26508 08152-5	532	1	50.25
8889	0-26508 09325-2	483	6	417.95	104451	0-26508 19928-2	498	12	173.00
8894	0-26508 22067-2	483	6	201.15	104465	0-26508 20436-8	534	12	173.00
8915	0-26508 09414-3	489	12	120.30	104466	0-26508 26710-3	534	12	173.00
8915CBN	0-26508 23539-3	489	12	150.35	104540	0-26508 27419-4	508	20	37.40
8917	0-26508 03032-5	489	12	141.80	104541	0-26508 27420-0	508	20	32.75
8917CBN	0-26508 23540-9	489	12	177.35	104542	0-26508 24531-6	508	20	45.55

Model No.	UPC	Page Number	Case Qty.	List Price	Model No.	UPC	Page Number	Case Qty.	List Price
104543	0-26508 24532-3	508	20	50.25	174056	0-26508 23590-4	499	12	94.85
104544	0-26508 24533-0	508	20	56.05	174057	0-26508 23591-1	499	12	26.35
104545	0-26508 24534-7	508	20	61.90	174060	0-26508 23594-2	499	12	16.70
104546	0-26508 24535-4	508	20	32.75	174061	0-26508 23595-9	499	12	23.40
104547	0-26508 24536-1	508	20	36.25	174062	0-26508 25276-5	499	12	8.65
104548	0-26508 24537-8	508	20	38.55	174065	0-26508 25277-2	499	12	47.35
104549	0-26508 24538-5	508	20	42.05	174066	0-26508 25278-9	499	12	5.45
104550	0-26508 24539-2	508	20	46.75	174334	0-26508 25438-7	499	12	187.35
104551	0-26508 24540-8	508	20	50.25	174335	0-26508 25439-4	499	12	187.35
104552	0-26508 24541-5	508	20	56.05	174336	0-26508 25440-0	499	20	18.55
104553	0-26508 24542-2	508	20	59.60	174337	0-26508 25441-7	499	20	18.55
104554	0-26508 24543-9	508	20	64.25	175916	0-26508 26190-3	534	12	14.95
104555	0-26508 24653-5	504	20	112.55	175917	0-26508 26191-0	534	1	14.95
104556	0-26508 24407-4	504	20	112.55	175918	0-26508 26192-7	534	12	14.95
104557	0-26508 24408-1	508	20	19.70	175921	0-26508 26675-5	534	12	14.95
104560	0-26508 24789-1	508	12	43.70	175925	0-26508 26676-2	534	12	14.95
104561	0-26508 24655-9	508	20	61.70	175926	0-26508 26677-9	498	12	14.95
104563	0-26508 24544-6	508	20	82.95	181040	0-26508 26678-6	498	12	14.95
104564	0-26508 24657-3	508	20	82.95	181148	0-26508 27449-1	493	12	78.00
104565	0-26508 24545-3	508	20	82.95	181149	0-26508 27450-7	493	12	67.50
104566	0-26508 24546-0	508	20	82.95	182413	0-26508 27230-5	499	64	60.60
104567	0-26508 24547-7	508	20	82.95	182414	0-26508 27231-2	499	12	17.10
104568	0-26508 24548-4	508	20	82.95	182415	0-26508 27232-9	499	24	125.00
104569	0-26508 24549-1	508	20	24.90	182416	0-26508 27233-6	499	12	92.80
104570	0-26508 24550-7	504	12	18.40	182417	0-26508 27234-3	499	12	51.00
104571	0-26508 24658-0	504	20	24.55	182418	0-26508 27235-0	499	12	31.90
104572	0-26508 24551-4	508	20	6.40	182419	0-26508 27236-7	499	12	15.50
104573	0-26508 24680-1	508	30	23.80	182420	0-26508 27237-4	499	12	40.60
104574	0-26508 24681-8	508	15	52.00	182421	0-26508 27238-1	499	12	58.90
104575	0-26508 24801-0	508	6	52.00	182422	0-26508 27239-8	499	12	145.00
104577	0-26508 24682-5	508	30	11.15	182423	0-26508 27240-4	499	12	13.30
104578	0-26508 24409-8	504	12	46.95	182534	0-26508 27370-8	499	6	48.90
104579	0-26508 24410-4	504	12	51.00	182535	0-26508 27371-5	499	6	131.80
104580	0-26508 24411-1	504	12	47.05	182536	0-26508 27372-2	499	20	9.30
104581	0-26508 24412-8	504	20	32.90	182537	0-26508 27373-9	499	12	145.00
104582	0-26508 24683-2	504	20	29.95	182538	0-26508 27374-6	499	20	20.50
104583	0-26508 24685-6	504	20	25.75	182539	0-26508 27375-3	499	12	42.90
104584	0-26508 24787-7	504	12	76.60	182540	0-26508 27376-0	499	12	49.60
104585	0-26508 24788-4	504	#N/A	120.65	182542	0-26508 27377-7	499	20	15.90
104587	0-26508 24861-4	504	6	147.05	182543	0-26508 27378-4	499	20	15.80
104588	0-26508 24686-3	504	20	27.65	182544	0-26508 27379-1	499	20	15.80
104589	0-26508 24687-0	504	20	44.45	182546	0-26508 27380-7	493	12	31.85
104590	0-26508 24742-6	508	33	26.45	182547	0-26508 27381-4	499	20	23.00
104591	0-26508 24743-3	508	33	26.45	A705	0-26508 24081-6	530	12	52.50
104592	0-26508 24744-0	508	33	26.45	A705CBN	0-26508 24082-3	530	12	78.75
104593	0-26508 24745-7	508	33	26.45	A714ST	0-26508 08101-3	532	24	55.45
104594	0-26508 24746-4	508	33	26.45	A723	0-26508 22865-4	532	20	28.65
104595	0-26508 24747-1	508	33	26.45	A725	0-26508 04455-1	532	12	47.60
104597	0-26508 24684-9	508	40	17.65	A725CBN	0-26508 19122-4	532	12	69.75
104598	0-26508 25184-3	508	20	26.05	A726	0-26508 07303-2	532	12	91.10
104599	0-26508 25185-0	508	20	46.75	A780	0-26508 22713-8	532	20	107.40
104600	0-26508 25253-6	508	12	50.20	CA8301	0-26508 21107-6	493	6	656.35
104609	0-26508 25186-7	508	20	10.20	CA8302	0-26508 21108-3	493	6	647.70
104617	0-26508 27399-9	504	12	29.80	CA8303	0-26508 21109-0	494	6	714.25
104618	0-26508 27400-2	504	12	70.50	S0000	0-26508 18146-1	480	12	48.55
104619	0-26508 27401-9	504	12	70.50	S0000T	0-26508 26963-3	481	12	33.55
104620	0-26508 27402-6	504	12	70.50	S0001	0-26508 02531-4	480	12	58.35
104621	0-26508 27403-3	504	12	70.50	S0002	0-26508 02532-1	480	12	59.60
104622	0-26508 27404-0	504	12	70.50	S0003	0-26508 02533-8	480	12	58.35
104623	0-26508 27405-7	504	12	70.50	S0004	0-26508 02534-5	480	12	70.10
104624	0-26508 27406-4	504	12	70.50	S0006	0-26508 02536-9	480	12	44.45
104625	0-26508 27407-1	504	12	33.20	S0007	0-26508 02537-6	480	12	59.60
104626	0-26508 27408-8	504	12	34.10	S0009	0-26508 02539-0	480	12	64.25
104627	0-26508 27409-5	504	12	31.70	S0010	0-26508 02540-6	480	12	70.10
104628	0-26508 27410-1	504	12	93.80	S0010T	0-26508 26982-4	481	12	55.10
104630	0-26508 27360-9	499	12	96.35	S0011	0-26508 02541-3	480	12	58.35
104631	0-26508 27411-8	504	12	31.80	S0012	0-26508 02542-0	480	12	127.40
104633	0-26508 27412-5	504	12	113.50	S0020	0-26508 14811-2	481	12	59.60
104634	0-26508 27413-2	504	20	22.40	S0020T	0-26508 26983-1	481	12	44.60
174055	0-26508 23579-9	499	12	29.85	S0030	0-26508 14812-9	481	12	65.45

Model No.	UPC	Page Number	Case Qty.	List Price
S0030NA	0-26508 27382-1	499	6	64.05
S0030T	0-26508 26984-8	481	12	50.45
S0050	0-26508 16071-8	481	12	72.45
S0050T	0-26508 26985-5	481	12	57.45
S0060	0-26508 19927-5	481	12	90.00
S0070	0-26508 18147-8	481	12	78.30
SMA1000CH*	0-34584 00772-8	508	24	30.05
SMA1000CH**	0-34584 00772-8	532	24	30.05
SV003	0-26508 02544-4	480	12	120.35
SV006	0-26508 02547-5	480	12	112.20
SV010	0-26508 02551-2	480	12	118.00
T4192	0-26508 26032-6	526	12	137.00
T8341	0-26508 22855-5	516	1	332.35
T8342	0-26508 22856-2	515	1	338.30
T8342CBN	0-26508 23715-1	515	1	497.30
T8342EP15	0-26508 22857-9	515	1	338.30
T8342EP15CBN	0-26508 23716-8	515	1	497.30
T8342NH	0-26508 23717-5	515	1	330.15
T8342NHCBN	0-26508 23718-2	515	1	452.80
T8343	0-26508 22858-6	512	1	357.45
T8343CBN	0-26508 23719-9	512	1	525.55
T8343EP15	0-26508 22859-3	512	1	357.45
T8343EP15CBN	0-26508 23762-5	512	1	525.55
T8343NH	0-26508 23763-2	512	1	349.35
T8343NHCBN	0-26508 23575-1	512	1	481.05
T8346	0-26508 22860-9	519	4	312.20
T8346CBN	0-26508 23563-8	519	4	442.70
T8346EP15	0-26508 22861-6	519	4	312.20
T8346EP15CBN	0-26508 23564-5	519	4	442.70
T8350	0-26508 21187-8	525	3	62.25
T8350CBN	0-26508 23706-9	525	3	112.65
T8360	0-26508 22277-5	526	3	45.10
T8370	0-26508 21188-5	524	3	35.25
T8370CBN	0-26508 23566-9	524	3	64.40
T8375	0-26508 21189-2	523	3	60.95
T8375CBN	0-26508 23567-6	523	3	93.75
T8375EP15	0-26508 22278-2	523	3	60.95
T8375EP15CBN	0-26508 23568-3	523	3	93.75
T8375NH	0-26508 23569-0	523	3	43.15
T8375NHCBN	0-26508 23570-6	523	3	72.20
T8389	0-26508 21213-4	521	3	93.35
T8389CBN	0-26508 23571-3	521	3	145.80
T8389EP15	0-26508 22279-9	521	3	93.35
T8389EP15CBN	0-26508 23572-0	521	3	145.80
T8389NH	0-26508 23573-7	521	3	77.95
T8389NHCBN	0-26508 23574-4	521	3	114.20
T9342	0-26508 25733-3	513	1	462.50
T9342EP15	0-26508 25734-0	513	1	462.50
T9342GBM15	0-26508 25738-8	514	1	508.75
T9342GBM25	0-26508 25737-1	514	1	508.75
T9343	0-26508 25731-9	510	1	488.70
T9343EP15	0-26508 25732-6	510	1	488.70
T9343GBM15	0-26508 25736-4	511	1	537.60
T9343GBM25	0-26508 25735-7	511	1	537.60
T9346	0-26508 25554-4	517	4	407.45
T9346EP15	0-26508 25555-1	517	4	407.45
T9346GBM15	0-26508 25556-8	518	1	448.20
T9346GBM25	0-26508 25557-5	518	1	448.20
T9360	0-26508 25558-2	525	3	124.80
T9370	0-26508 25559-9	524	3	97.55
T9375	0-26508 25560-5	522	3	122.05
T9375EP15	0-26508 25561-2	522	3	122.05
T9389	0-26508 25562-9	520	3	155.30
T9389EP15	0-26508 25563-6	520	3	155.30



Look for the WaterSense® logo to identify water-efficient Moen® faucets and showerheads that meet WaterSense® criteria.

Moen® kitchen faucet SKUs* are manufactured with a 1.5 gpm aerator that is certified to meet WaterSense® criteria. As of July 1, 2016, lavatory faucets are manufactured with a 1.2 gpm aerator that is certified to meet WaterSense® criteria and the California Energy Commission (CEC) regulation. The packaging label clearly indicates the WaterSense® logo and product flow rate. If the product you receive does not have the qualifying label markings, a replacement aerator can be ordered by calling 1-800-BUY-MOEN.

Moen® flow-optimized rainshowers and showerheads use up to 30% less water (compared to traditional 2.5 gpm showerheads) without sacrificing performance. Products throughout our showering portfolio with a WaterSense logo — including wall-mount, handshower and rainshower showerheads - are certified to meet EPA WaterSense® labeling criteria. These also contribute towards maximizing LEED points.

*Excluding all bathtub spouts and some commercial faucets and showerheads.



Moen® Eco-Performance (EP) showerheads and handshowers are flow-optimized to use up to 30% less water (compared to traditional 2.5 gpm showerheads) without sacrificing performance, and contribute towards maximizing LEED points.



The U.S. Green Building Council® developed the Leadership in Energy and Environmental Design (LEED®) Green Building Rating System as a nationally accepted benchmark for measuring and documenting green building practices.



The Green UPC® symbol indicates that this product has been certified by the International Association of Plumbing and Mechanical Officials (IAPMO) to reduce water consumption by at least 20% when compared to standard flow rates.

All Moen® lavatory and kitchen faucets meet NSF 372 requirements.



ADA Compliant – Many Moen® faucets, sinks and shower valve controls meet requirements for the physically challenged.

Shower Valve Flow Rates

Flow Rate vs. Flowing Inlet Pressure of Moen Showering Valves (Unrestricted)

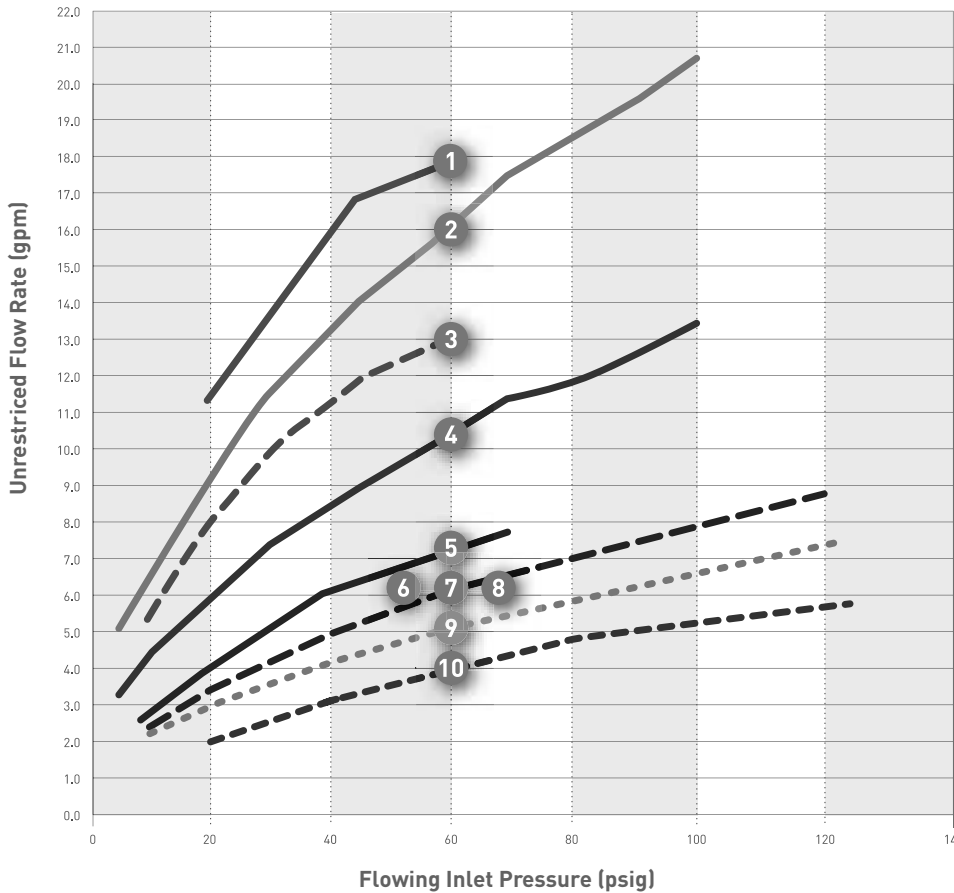

1. **3/4" ExactTemp®**
S3371 3/4" ExactTemp: 18.0 gpm
2. **U by Moen™ Shower – Four-Outlet**
S3104 Four-Outlet: 16.0 gpm
3. **Volume Control**
S3600 Volume Control: 13+ gpm
4. **U by Moen Shower – Two-Outlet**
S3102 Two-Outlet: 10.3 gpm
5. **Moentrol® Tub Port**
Moentrol 3520/3510/3570
Flow at Tub: 7.2 gpm
6. **Moentrol Shower Port**
Moentrol 3520/3510/3570
Flow at Shower: 6.3 gpm
7. **Posi-Temp® Tub Port**
Posi-Temp 2520/2510/2570/2580/2590
Flow at Tub: 6.3 gpm
8. **Posi-Temp 62345**
Moentrol 3520/3510: 6.3 gpm
9. **Moentrol Two Outlets**
Moentrol 3320/3330/3350
Two-Outlets: 5.2 gpm
10. **Posi-Temp Shower Port**
Posi-Temp 2520/2510/2570/2580/2590
Shower: 4.0 gpm

Shower Spa Installation Recommendations

Graph Line	Valve	Flow Rate through shower port (gpm) @ 20 PSI	Flow Rate through shower port (gpm) @ 40 PSI	Flow Rate through shower port (gpm) @ 60 PSI	Use with 2- or 3-function transfer	Maximum Components
1	3/4" ExactTemp® S3371	11.4	15.7	18.0	No	4 components: Any combination of showerheads, handshowers and body sprays (4 max)
2	U by Moen™ Four-Outlet S3104	9.0	13.0	16.0	No	4 components: Any combination of showerheads, handshowers and body sprays (4 max)
4	U by Moen Two-Outlet S3102	6.0	8.5	10.0	No	Showerhead, handshower or showerhead, 2 body sprays
6	Moentrol® 3520, 3510, 3570	3.5	5.0	6.3	Yes	Showerhead, handshower
8	Posi-Temp® 62345	3.6	5.1	6.3	Yes	Showerhead, handshower or showerhead, 2 body sprays
9	Moentrol Two Outlets 3320, 3330, 3350	3.0*	4.2*	5.2*	No	Showerhead, handshower or showerhead, 2 body sprays
10	Posi-Temp 2520, 2510, 2570, 2580, 2590	2.1	3.2	4.0	Yes	Showerhead, handshower

* 3-Function Moentrol flow is the total flow when used in the shared mode.

MOEN®

Pricing effective February 1, 2018. Although descriptions are believed correct at publication approval, accuracy cannot be guaranteed. Moen reserves the right to make product specification changes from time to time, without notice or obligation, and to change or discontinue models.

Connect with us:
moen.com/social

U.S. Headquarters:
Moen Incorporated
25300 Al Moen Drive, North Olmsted, OH
44070-8022

Canada Headquarters:
Moen
2816 Bristol Circle, Oakville, Ontario
L6H 5S7

Visit our website at moen.com

1-800-BUY-MOEN

1-800-465-6130