

# Empire®

EMPIRE LEVEL MFG. CORP.

## Product Catalog

Effective 12.1.10

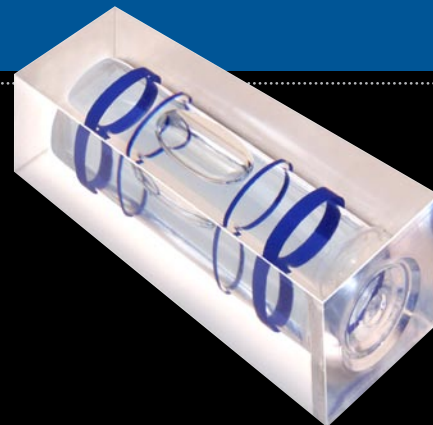



<b>DESCRIPTION</b>	<b>PAGE #</b>
<b>History of Empire Level</b>	<b>2-3</b>
<b>The TRUE BLUE® Story</b>	<b>4-5</b>
<b>Packaging, Merchandising, Advertising</b>	<b>6</b>
<b>Dewalt Levels</b>	<b>7</b>
<b>Digital &amp; Box Levels</b>	<b>8</b>
<b>Masonry Levels</b>	<b>9</b>
<b>I-Beams Levels</b>	<b>10-11</b>
<b>Torpedo Levels</b>	<b>12</b>
<b>Utility Levels</b>	<b>13</b>
<b>Combination Squares</b>	<b>14</b>
<b>Rafter Squares &amp; Protractors</b>	<b>15</b>
<b>Framing Squares</b>	<b>16</b>
<b>T-Squares</b>	<b>17</b>
<b>Straight Edges &amp; Plumb Bobs</b>	<b>18</b>
<b>Caution Tape/Safety Products/Construction Line</b>	<b>19</b>
<b>Power Tapes</b>	<b>20</b>
<b>Open Reel &amp; Closed Case Tapes</b>	<b>21</b>
<b>Miter Boxes/Shaping Tools</b>	<b>22</b>
<b>Precision Tools</b>	<b>23-30</b>
<b>Contact Information</b>	<b>31</b>
<b>Cross Reference Index</b>	<b>32</b>

**STRAIGHT TALK FROM THE PRESIDENT OF EMPIRE LEVEL**

Let's not mince words: the new reality is the economy demands that we all work harder than ever. I expect the most from our team and know you do too. So, in these challenging times, I am pleased to say we have launched more than 20 new products in addition to an acquisition that has added another 10.

But our strategy goes beyond just hard work- we listen. Over the past two years, we have talked to over 10,000 end users. For example, professional builders told us that existing digital levels weren't getting the job done. They want a durable level that has consistent and accurate readings, a case, a lighted display for quick reading, and most important it has to be easier to use than existing products. Based on e70 technology, the new e100 Series Digital Level solves all of these issues and delivers even more.

While high-tech levels are great, we continue to grow our traditional tool line too. The addition of American's mahogany levels provides professional builders, remodelers and serious DIY'ers the ideal combination of craftsmanship and quality that complements our existing wood level line. The significant intellectual property that we will gain through this acquisition will allow us to further enhance and grow the line in the future.

Perhaps I'm most proud of our new Quad-Box technology. It solves the #1 requested product from end users: a level that remains accurate on the job site, day after day. The patent-pending chassis uses a four box cross section which makes the frame over 200% stronger than anything on the market. It also allows us to mount the vials directly to the frame, eliminating the need for adjustment at the factory or during use- a first in box levels. And every Quad-Box level is made right here in Mukwonago, Wisconsin.

It's interesting that while the industry and our company continue to change, some things don't. Delivering more value as a supplier means driving sales and profits. We simply work hard, listen and innovate, just like we have been doing for over 90 years.

Thank you for your business,



Jenni Becker

A handwritten signature in black ink that reads "Jenni".

Fifth Generation President  
Empire Level Mfg. Corp.

## A POWERFUL HERITAGE OF INNOVATION

Empire has been the company to kick dirt on conventional wisdom for 90 years. It started in 1919 with Henry Ziemann's vision to marry the art of tool making with the science of modern design, and it hasn't stopped since. From the invention of the Mono Vial® to the versatile torpedo level, more than 30 patents mark our lineage.

TRUE BLUE® is the most significant change in levels since the Mono-Vial® and is symbolic of our commitment to developing truly innovative tools.



Four buildings comprise the "Campus style" setting for Empire Level in Mukwonago, Wisconsin

- 1919** Empire Level Founded
- 1929** Started Producing Craftsman Brand Levels and Squares
- 1935** Torpedo Level Invented
- 1956** First Extruded Aluminum I-Beam Level
- 1965** Invented the Magnetic Level
- 1966** Invented the Mono-Vial®
- 1979** Introduced First "VARI-PITCH™ Vial
- 1986** Introduced Magnum™ and Speed Level™
- 1997** Introduced the Tool Box Level
- 1999** Invented the Monster Vial™
- 2000** Acquired Hempe Manufacturing
- 2003** Jenni Becker Appointed 5th Generation President
- 2004** TRUE BLUE® Vials Introduced
- 2005** Introduced the TRUE BLUE® e70 Series Box Level
- 2006** Introduced the TRUE BLUE® em71 Series Magnetic Box Level
- 2009** Introduced the TRUE BLUE® e100 Series Digital Level
- 2010** Launch Quadbox Chassis
- 2010** Acquired American Level



### GENESIS OF A REVOLUTION

Let's face it; competing in today's environment is survival of the fittest. You don't survive 90 years without hanging it out there once in a while. And while Henry Ziemann's gene and genius can still be found in the halls of Empire Level, there is, as they say, no rest for the weary. For twelve months we approached our task with single-minded focus and determination. From top management down we sweated all the details, debated, and each, in our own way, grabbed onto the development of True Blue®. This wasn't just an internal exercise either. We put on our work boots and hit the job sites asking the tough questions and getting unbiased feedback. We think the result is the most accurate, user-friendly and durable levels ever invented. And here are a few of the reasons why:

### THIS IS REAL TECHNOLOGY AT WORK



Advanced Concentric Molding™ is the latest in vial manufacturing technology. The results allow Empire to create levels unchallenged in terms of accuracy and reliability. ACM™ provides us the most accurate and precise ability to make vials with 360° of accuracy, every vial, every time. With Empire's new ACM™ capability, we can certify accuracy to within 0.0005" per inch *in all ten level and plumb working positions.*

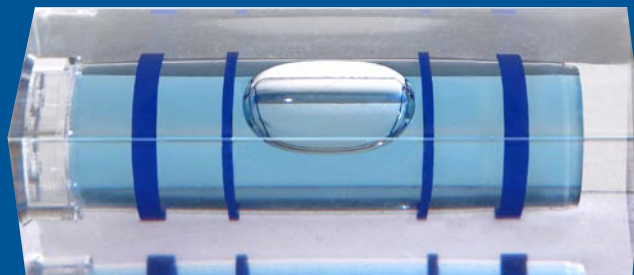

Empire is the only manufacturer who offers the same warranty on the plumb vials. No matter the application or use, Empire True Blue® levels, with our patented True Blue® Vials, provide the most accurate read. Period. Don't let the competition smoke you - no one else even comes close.

## FACE THE FACTS: BLUE IS BETTER

This isn't a change from yellow liquid to blue. *This is the start of a revolution.* It has been independently proven that our new True Blue® vials have maximum accuracy and superior durability. For years, Empire has manufactured the most accurate vials on the planet and now, we've pushed our technical advantage even further. Combining world-class industrial design, advanced manufacturing techniques, and optic science, we've created the next generation of levels.

## BLUE BANDS



The secret to a faster, more accurate read? Two dark blue bands (patent pending) at the ends of the vial highlight the bubble. The darkened edges create a more defined bubble, making the level much easier to read, even in low light situations. Just compare True Blue® versus an old-school yellow vial and you'll immediately see the difference.



## LIFETIME WARRANTY

We think of our warranty as a code of honor - an unflinching standard for those who put their trust and their hard-earned dollars to work with Empire. We are pleased to stand firmly behind every product that is good enough to bear the True Blue® name.



## EMPIRE TRUE BLUE® LIFETIME WARRANTY



*Empire True Blue® Levels are warranted to be free from imperfections in materials and workmanship. If you have a problem with your True Blue® Level, Empire will replace it with a new one. With proper care, this level will be accurate for your lifetime. Bent frames void warranty.*

## ADVERTISING



## PACKAGING



The design of our packaging clearly demonstrates the innovation that makes Empire the leader in its industry. Using easy to read charts, icons and color-coding per type of level and use enables the consumer to easily determine the best tool for the job. Custom die cuts allow for easy handling, view of the vials and makes for a more uniform placement on the tool and visual consistency across the merchandising rack. The design compliments the level and its existing product graphics. After all, we are selling a level, and the package is a guide to identify the features that make each Empire level unique.

## National Media Efforts

Spreading the True Blue® story via national print media has become one of Empire's marketing priorities. From top flight customer publications like *Extreme How-To* and *Tools of the Trade* to industry must reads like *Construction Distribution* and *Pro Sales*, Empire is committed to getting the word out what True Blue® can mean to the casual tool user, the seasoned pro and the retailer looking to maximize profits.

## Expanded Web Site

Even the seasoned contractor has embraced the online revolution. With our improved interface and expanded ad program more consumers are clicking through to our web site. Better content and information helps customers find the Empire products on your shelves. Visit us at [www.empirelevel.com](http://www.empirelevel.com)

## Public Relations

Editors agree- Empire's seismic leap in level technology is newsworthy stuff. Our focused PR team is helping reinforce the True Blue® message in consumer and trade publications around the globe. Look for empire-related headlines in a news outlet near you.

## MERCHANDISING

Empire has taken merchandising to a new plane with permanent displays made from cold, hard steel. Empire is committed to thoughtfully develop merchandising programs that fit your store, make a bold, visual impact and move product.

### 1 Wide Rack

6"W x 21"H x 14"D  
(1-SLOTTRAK)



### 4 Wide Rack

13"W x 24"H x 12"D  
(4-SLOTTRAK)



### 6 Wide Rack

19"W x 32"H x 15"D  
(6-SLOTTRAK)





### DLX10.48

X-Brace adds reinforcement to the center of the level, where you need it most

Dual-Density Endcaps are bolted on to absorb shocks.



Lexan® windows provide exceptional strength and optical clarity

Quadbox Chassis for increased strength



### DeWALT Professional Box Level

- Innovative Quadbox Chassis technology increases strength and allows the vial to be mounted directly to the frame—an industry first.
- The Revolutionary X-Brace adds reinforcement where you need it most making the level stronger than ever.
- Lexan® windows provide exceptional strength and optical clarity.
- Dual-Density Endcaps are bolted on to absorb shocks.
- Xenoy® grips allow for a more comfortable, tough and larger opening ensuring a better fit for a gloved hand.

<b>DLX10.24</b>	24" Box Level
<b>DLX10.48</b>	48" Box Level (shown)
<b>DLX10.72</b>	72" Box Level

The new line of box levels from DeWALT delivers both strength and accuracy. Innovative design and materials like Lexan® and Xenoy® make this level exceptionally strong, while its patent-pending chassis technology means it starts accurate and stays that way. **Guaranteed Tough.®**



X-BRACE



DUAL-DENSITY ENDCAPS



LEXAN® AND XENOY®



QUADBOX CHASSIS



### DeWALT DLX60.07 Rafter Square

- Innovative laser-etched graduations offer best in class readability making layout a snap.
- Larger base provides a better grip on boards.
- 6063 extruded aluminum construction will not bend or crack. Anodized aluminum will not rust or corrode.



### DeWALT DLX1 Merchandising Rack

- Eye-catching steel display conveniently organizes products
- Small footprint - use free standing or in-line
- Mounted Cut-Away level chassis and full color tell/sell information

### e70.24

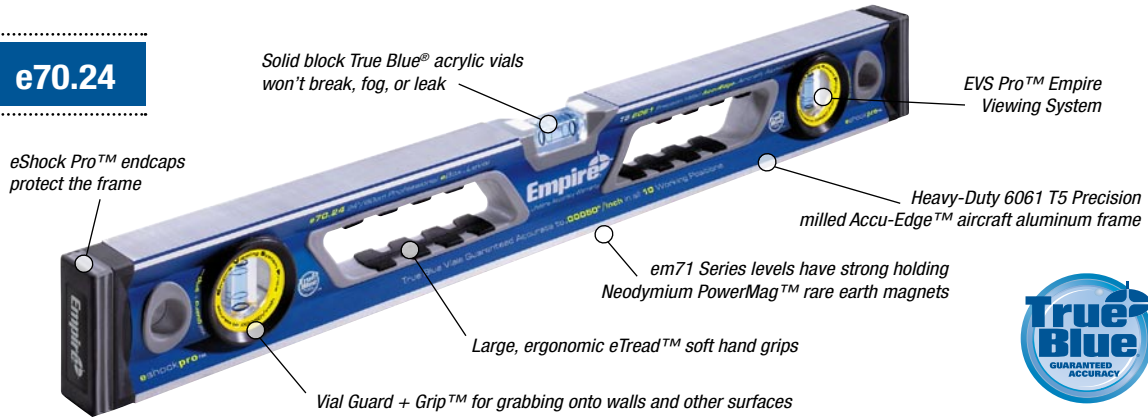

### e100 Series Digital Level

- True Blue® vials are accurate to within 0.0005" per inch in all 10 level and plumb working positions
- Heavy-duty 6061 aircraft aluminum chassis
- Solid block acrylic vials won't break, leak or fog
- Milled edges for accuracy
- Dual molded rubber endcaps for extreme shock resistance
- Vial Guard to protect vials
- Gripping surface to assist drawing straight lines
- Laser Level for accurately extending your level capabilities
- Digital Module for accurate reads of slope, pitch and inch/ft in any light

**e100.24** 24" e100 Level (shown)  
**e100.48** 48" e100 Level

**PRO**  
LIFETIME WARRANTY



### e70/em71 Series Levels

- True Blue® vials are accurate to within 0.00050" per inch in all 10 level and plumb working positions
- Heavy-duty 6061 T5 precision milled Accu-Edge™ aircraft aluminum frame
- eShock Pro™ endcaps protect frame
- Vial Guard + Grip™ for grabbing onto work surfaces
- Large, ergonomic eTread™ hand grips
- em71 Series Magnetic Levels feature Neodymium Powermag™ rare earth magnets for super-strong holding onto ferrous surfaces

<b>e70.24</b>	24" e70 Level	<b>em71.24</b>	24" e71 Magnetic Level
<b>e70.48</b>	48" e70 Level	<b>em71.48</b>	48" e71 Magnetic Level
<b>e70.72</b>	72" e70 Level	<b>em71.78</b>	78" e71 Magnetic Level
<b>e70.96</b>	96" e70 Level	<b>em71.96</b>	96" e71 Magnetic Level
<b>e70JAMB</b>	78"/32" e70 Level Set	<b>em71 JAMB</b>	78"/32" em71 Magnetic Level Set

**PRO**  
LIFETIME WARRANTY



### 845 Series Box Level

- Sturdy frame with milled edges
- Ergonomic hand grips
- Solid block acrylic vials won't leak, 300° top read vial

**845.24** 24" 845 Level    **845.48** 48" 845 Level    **845.72** 72" 845 Level

**BETTER**



### 600 Series Box Level

- Rigid aluminum box frame with milled edges
- Solid block acrylic vials won't leak, 300° top read vial

**600.24** 24" Box Level    **600.48** 48" Box Level

**GOOD**



### I-Beam Mahogany Level

PRO

- Durable aluminum I-beam with straight-grain mahogany inserts
- Vials are hand set and hand marked for high accuracy and precision
- Rubber endcaps protect against drops and shocks

26278	24" Handcrafted Mahogany I-Beam Level
26302	36" Handcrafted Mahogany I-Beam Level
26286	48" Handcrafted Mahogany I-Beam Level



### Brass Bound Mahogany Level

PRO

- Top quality straight-grain mahogany specially cured to assure straightness
- Stands up to mortar and rough use
- Vials are hand set and hand marked for high accuracy and precision
- Brass binding "bites" into wood
- Brass endcaps are reinforced for maximum protection and durability

26252	24" Handcrafted Mahogany Mason's Level
26187	36" Handcrafted Mahogany Mason's Level
26195	42" Handcrafted Mahogany Mason's Level
26203	48" Handcrafted Mahogany Mason's Level



### Basic Mason's Level

BETTER

- Solid Sapele Mahogany frame
- Dual hand set and hand marked glass vials
- Brass edges
- Aluminum endcaps

26633	24" Basic Mahogany Mason's Level
26658	48" Basic Mahogany Mason's Level



### e90 Series Magnum™ Level

PRO  
LIFETIME  
WARRANTY

- True Blue® vials are accurate to within 0.0005" per inch in all 10 level and plumb working positions
- Aluminum reinforced frame will not warp
- Polycarbonate lenses will not fog over
- Replaceable vials and lenses

e90.24	24" Magnum Level
e90.48	48" Magnum Level



### 850-48 Series "The Natural" 48" Stainless Steel Trim Wood Level

GOOD

- Select grade hardwood surpasses all other levels in the load test
- Handcrafted from earth's renewable resources
- Edges wrapped with stainless steel trim
- Beveled rubber endcaps protect from shock

**em81.24**

*anodized aluminum frame with milled edges for accuracy*

*Shock absorbing endplates protect the frame*

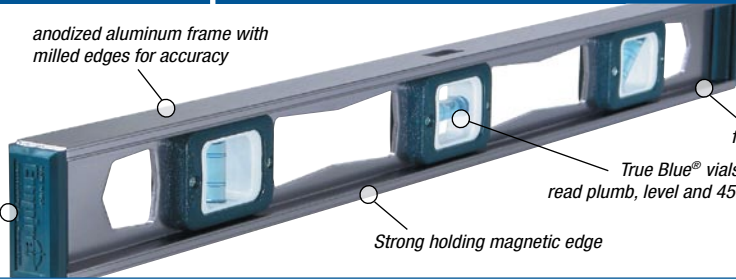

*Dropped edge for added rigidity*

*True Blue® vials read plumb, level and 45°*

*Strong holding magnetic edge*



### e80/em81 Series Heavy-Duty Levels

- True Blue vials are accurate to within 0.0005" per inch in all 10 level and plumb working positions
- Super strong anodized I-Beam frame
- Shock absorbing endcaps
- Top reading window
- em81 has strong holding magnetic edge

<b>e80.24</b>	24" Heavy-Duty Level w/VARI-PITCH™
<b>e80.48</b>	48" Heavy-Duty Level w/VARI-PITCH™
<b>e80.72</b>	72" Heavy-Duty Level
<b>e80.78</b>	78" Heavy-Duty Level
<b>e80.96</b>	96" Heavy-Duty Level
<b>TC16</b>	78" & 32" Heavy-Duty Level Door Jamb Set
<b>em81.24</b>	24" Heavy-Duty Magnetic Level w/45° vial (shown)
<b>em81.48</b>	48" Heavy-Duty Magnetic Level
<b>em81.68</b>	48" Heavy-Duty Magnetic Level and Case
<b>em81.78</b>	78" Heavy-Duty Magnetic Level
<b>em81.96</b>	96" Heavy-Duty Magnetic Level
<b>TC17</b>	78" & 32" Heavy-Duty Magnetic Level Door Jamb Set

**PRO**  
LIFETIME  
WARRANTY



### e50/em51 Heavy Duty Aluminum Series Level

- New ergonomic handgrips that provide a comfortable grip and cover the internal openings in the extrusion
- High visibility plumb vial surrounds make viewing easier in all light conditions
- Durable center vial surround aids visibility and protects the vials
- em51 has strong holding full length magnetic edge

<b>e50.24</b>	24" Level	<b>em51.24</b>	24" Level
<b>e50.48</b>	48" Level	<b>em51.48</b>	48" Level
<b>e50.72</b>	72" Level	<b>em51.78</b>	78" Level

**PRO**  
LIFETIME  
WARRANTY



### 580/581 Series Aluminum Levels

- Advanced frame design assures accuracy
- Top read window
- Beveled endcaps protect vials from shock
- 581 has magnetic edge that holds to ferrous surfaces

<b>580-18VP</b>	18" Aluminum Level w/VARI-PITCH™
<b>580-24</b>	24" Aluminum Level
<b>580-36</b>	36" Aluminum Level
<b>580-48</b>	48" Aluminum Level
<b>580-72</b>	72" Aluminum Level
<b>581-18</b>	18" Magnetic Aluminum Level w/45° vial
<b>581-24</b>	24" Magnetic Aluminum Level w/45° vial (shown)
<b>581-36</b>	36" Magnetic Aluminum Level
<b>581-48</b>	48" Magnetic Aluminum Level
<b>581-72</b>	72" Magnetic Aluminum Level

**BETTER**



### 540 Series Aluminum Levels

- Rugged aluminum I-beam frame
- Top read window for convenience
- Beveled endcaps protect vials from shock

540-24	24" Aluminum Level
540-48	48" Aluminum Level

**BETTER**



### 430 Series Homeowner Aluminum Levels

- Rigid aluminum I-Beam frame
- Easy grip hand holes
- Durable acrylic vials

430-18	18" Aluminum Level
430-24	24" Aluminum Level
430-36	36" Aluminum Level
430-48	48" Aluminum Level

**GOOD**



### 330 Series Polycast® Levels

- Durable Polycast® frame is virtually unbreakable under normal use
- Will not mar or scratch fine surfaces or furniture
- Durable acrylic vials

330-24	24" POLYCAST® Level
330-36	36" POLYCAST® Level
330-48	48" POLYCAST® Level

**GOOD**



48" Level Case (levels not included)



78" Level Case (levels not included)

### Soft Side Level Cases

- 600 Denier poly construction with double stitching and bar tacking
- Convenient carrying handle and adjustable shoulder strap
- Heavy-duty zipper closure
- 48" case also holds 24" level in a custom-fit outer pocket
- 78" case also holds 32" level in a custom-fit outer pocket
- Soft side level cases fit all Empire/DEWALT levels

68-148	48" Soft Side Level Case
68-178	78" Soft Side Level Case

**BETTER**



### 68-048 Duraguard™ 48" Level Case

- Protects your level from damage
- Tough, high density polyethylene
- Duraguard™ case fits all Empire levels\*

\*Fits all levels except DEWALT levels and Empire e70, em71

**GOOD**

em81.9

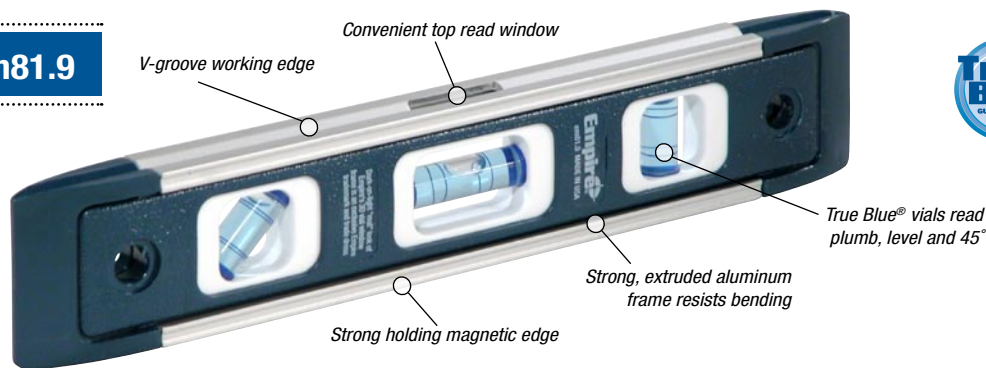

### em81.10 10" Rare Earth Magnetic Torpedo Level

- True Blue® vials are accurate to within 0.0005" per inch in all 10 level and plumb working positions
- Heavy-duty aluminum frame with top read window
- Powerful rare earth magnets for 10 lbs. of holding power
- V-grooved working edge fits on pipe or conduit

**PRO**  
LIFETIME  
WARRANTY



### em81.12 12" Heavy Duty Magnetic Tool Box Level

- True Blue® vials are accurate to within 0.0005" per inch in all 10 level and plumb working positions
- Heavy-duty 12" extruded aluminum frame
- 4 vials read plumb, level, 45°, and Vari-Pitch™
- Powerful, full-length magnetic edge
- Vari-Pitch™ vial reads slope in 1/8" increments

**PRO**  
LIFETIME  
WARRANTY



### em81.9 9" Heavy Duty Magnetic Torpedo Level

- True Blue® vials are accurate to within 0.0005" per inch in all 10 level and plumb working positions
- Heavy-duty extruded aluminum frame
- Vials read plumb, level and 45°.
- Strong-holding magnetic edge
- V-grooved working edge fits on pipe or conduit

**PRO**  
LIFETIME  
WARRANTY

e80.9 Heavy-Duty Aluminum Torpedo Level (non-magnetic)



### 581-9 9" Magnetic Torpedo Level

- Durable acrylic vials read plumb, level and 45°
- Solid aluminum frame, 9" overall length
- Magnetic edge frees hands

**BETTER**

587-24 9" Magnetic Torpedo Level 24 Piece Display



### 331-9 9" Magnetic Polycast® Torpedo Level

- Durable acrylic vials read plumb, level and 45°
- Solid aluminum frame, 9" overall length
- Magnetic edge frees hands

**GOOD**



### 33-9 9" Polycast® Torpedo Level

- Strong, accurate 9" Polycast® frame
- Non-conductive frame insulates from heat, cold and electricity
- Vials read plumb, level and 45°

**GOOD**



### 460-36 36" Aluminum Speed Level™

**BETTER**

- Triangular frame design to level, measure and cut
- Large, easy to read numbers and graduations
- Ideal for wallpapering, shelving, as a cutting guide
- 3 durable acrylic vials



### Polycast® Post Level

**BETTER**

- Sturdy, high impact Polycast® construction
- Durable vials read plumb and level
- Establish plumb or level on decks, fences, support poles

720 Polycast® Post Level  
 721 Polycast® Magnetic Post Level  
 727-24 Polycast® Post Level 24 Piece Display



### 93-3 3" Aluminum Line Level

**BETTER**

- Lightweight construction minimizes line sag
- Unbendable open hooks allow level to slide freely
- Pocket clip will guard tool against loss



### Line Levels

**GOOD**

- Lightweight construction minimizes line sag
- Unbendable open hooks allow level to slide freely
- Pocket clip will guard tool against loss
- Vari-Pitch™ vial reads from level to 1/2" pitch in 1/8" increments

83-3 Standard Line Level  
 83-50 Standard Line Level 50 Pack  
 83038 Line Level Set-Standard & VARI-PITCH™



### 84-5 Pocket Level

**GOOD**

- Strong molded frame
- Overall length 5"
- Top read window
- Durable pocket clip



### 3604 Bullseye™ Level

**GOOD**

- Levels in all directions
- Use on ranges, refrigerators, washers, dryers, stereos, RV's



### 27368 Surface Level

**GOOD**

- Levels in horizontal and vertical directions at the same time
- Molded construction with convenient mounting holes
- Use on ranges, refrigerators, washers, dryers, stereos, RV's

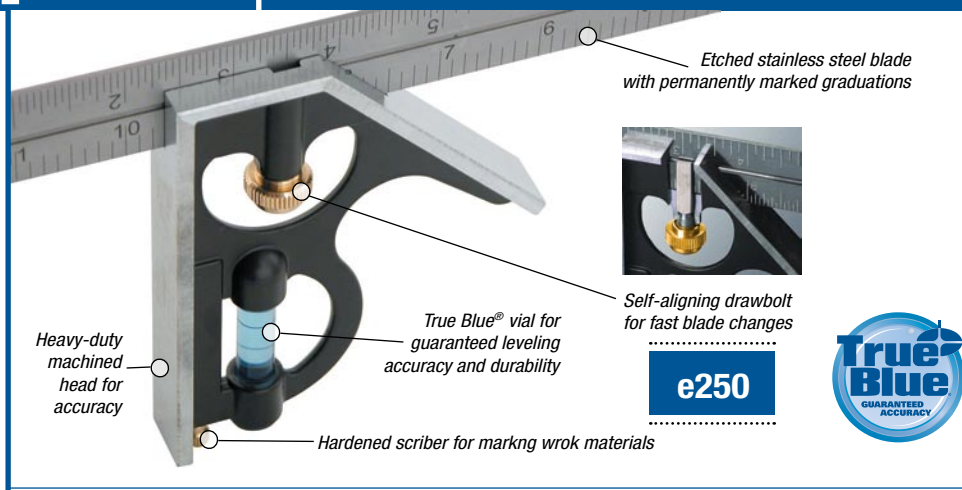

### e280 16" Heavy-Duty Professional Combination Square

- Precision machined head and true blue vials ensure squareness to .001
- 16" etched stainless steel blade with inch graduations
- Heavy-duty machined square head
- Self-aligning drawbolt, hardened scriber
- True Blue® vial for accuracy

e280M Metric graduations

**PRO**  
LIFETIME  
WARRANTY



### e250 12" Heavy-Duty Professional Combination Square

- Precision machined head and true blue vials ensure squareness to .001
- 12" etched stainless steel blade with inch graduations
- Heavy-duty machined square head
- Self-aligning drawbolt, hardened scriber
- True Blue® vial for accuracy

e250M Metric graduations

**PRO**  
LIFETIME  
WARRANTY

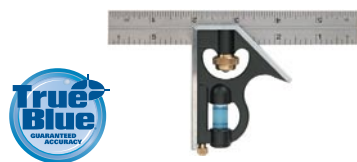

### e255 6" Pocket Combination Square

- Precision machined head and true blue vials ensure squareness to .001
- 6" etched stainless steel blade with inch graduations
- Machined square head
- Self-aligning drawbolt, hardened scriber
- True Blue® vial for accuracy

e255M Metric graduations

**PRO**  
LIFETIME  
WARRANTY



### 230 12" Combination Square

- 12" satin steel blade with inch graduations
- Machined square head
- Self-aligning drawbolt, hardened scriber

**BETTER**



### 240 12" Combination Square

- 12" satin steel blade with inch graduations
- Metal square head, full view acrylic vial
- Self-aligning drawbolt

**BETTER**

240IM 12" Satin Steel blade has inch/metric graduations  
240M 12" Satin Steel blade has metric graduations



### 220 Polysquare™ Combination Square

- 12" satin steel blade with inch graduations
- Durable Polycast® head, full view acrylic vial
- Self-aligning drawbolt

**GOOD**

220IM Etched Stainless Steel blade has inch/metric graduations



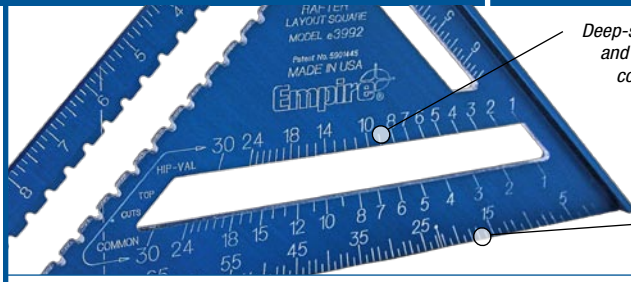

Deep-stamped, long lasting graduations, easier reading and longer product life. Convenient stamped-in rafter conversion tables for more versatility

**e3992**

Thicker frame design ensures safer use as a saw guide



**2990**



### e3992 12" HI-Vis Rafter Square

- High visibility, deep stamped, long lasting graduations
- Anodized aluminum construction will not rust or corrode
- Mark or cut boards up to 12" wide
- Thick edge makes for a safer saw guide
- Convenient stamped-in conversion tables
- Includes helpful instruction manual with complete rafter tables

**PRO**  
LIFETIME WARRANTY



### e2992 7" HI-Vis Rafter Square

- High visibility, deep stamped, long lasting graduations
- Anodized aluminum construction will not rust or corrode
- Thick edge makes for a safer saw guide
- Convenient stamped-in conversion tables
- Includes helpful instruction manual with complete rafter tables

**PRO**  
LIFETIME WARRANTY



### 3990 12" Heavy-Duty Magnum™ Rafter Square

- Solid aluminum extruded square will not bend or break
- Stamped conversion tables
- Mark or cut boards up to 12" wide
- Thicker frame design ensures safe use as a saw guide
- Graduated notches for "pulling" layout lines
- Includes helpful instruction manual with complete rafter tables

**PRO**



### 2990 7" Heavy-Duty Magnum™ Rafter Square

- Solid aluminum extruded square will not bend or break
- Aluminum will not rust or corrode
- Stamped conversion tables
- Thick edge makes for a safer saw guide

2999 Includes instruction manual with complete rafter tables

**PRO**



### Polysquares™ 12" and 7" Rafter Square

- Extra large size makes marking and cutting wider boards easy
- Tough, durable Polycast® material stands up to every day use
- Molded conversion tables
- Easy to see graduations repeated on both sides

396 12" Polysquare™ Rafter Square 295 7" Polysquare™ Rafter Square  
296 7" Polysquare™ in 48 Piece Display POP

**GOOD**



### 36 Magnetic Polycast® Protractor

- Magnetic base and back
- Easy reading dial with adjustable angle pointer

**BETTER**



### 361 Small Angle Magnetic Protractor

- Magnetic base
- Full view acrylic vial protractor dial is graduated in 5° increments
- Durable Polycast® construction

**GOOD**

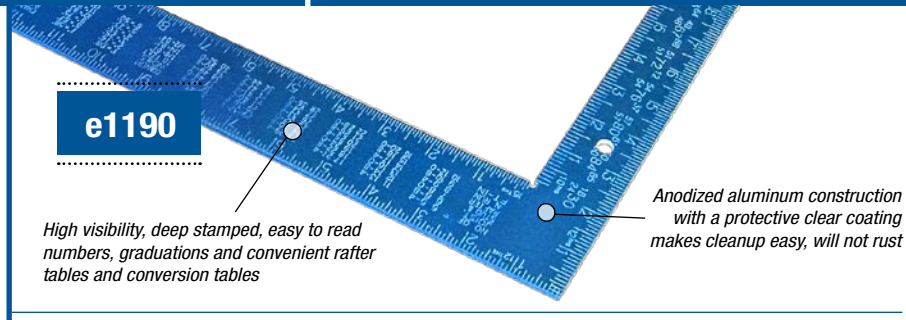

**e1190**

High visibility, deep stamped, easy to read numbers, graduations and convenient rafter tables and conversion tables

Anodized aluminum construction with a protective clear coating makes cleanup easy, will not rust

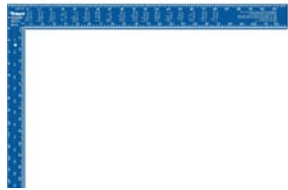

### **e1190 HI-Vis Aluminum Professional Framing Square**

- High visibility, deep stamped, long lasting graduations
- 24" x 2" body, 16" x 1-1/2" tongue, 1/8" thick
- Anodized aluminum construction will not rust
- Includes 1/8", 1/10", 1/12", 1/16" stamped graduations and conversion tables

**PRO**  
LIFETIME WARRANTY



### **1240 16" x 24" "Fat Boy" Aluminum Framing Square**

- 24" x 2" body, 16" x 1-1/2" tongue
- 50% thicker, heavy-gauge aluminum 3/16" thick resists bending
- Deep stamped inch graduations, numbers and rafter tables for long life
- Aluminum construction will not rust or corrode
- Includes 1/8", 1/10", 1/12", 1/16" stamped graduations

**PRO**  
LIFETIME WARRANTY



### **1140 16" x 24" Aluminum Framing Square**

- 24" x 2" body, 16" x 1-1/2" tongue, 1/8" thick
- Permanently stamped numbers, rafter tables, graduations on brushed aluminum finish
- Aluminum construction will not rust or corrode
- Includes 1/8", 1/10", 1/16" stamped graduation

**PRO**



### **1110 16" x 24" Steel Tradesman Square**

- 24" x 2" body, 16" x 1-1/2" tongue, 1/16" thick
- Permanently stamped numbers and 1/8" graduations
- Durable protective epoxy finish to prevent rust

1110IM Steel Tradesman Square with inch/metric graduations

**BETTER**



### **1010 12" x 16" Steel Carpenter Square**

- 12" x 16" square, 1/16" thick
- Permanently stamped numbers and 1/8" graduations
- Durable protective epoxy finish to prevent rust

**GOOD**



### **100 8" x 12" Steel Carpenter Square**

- 8" x 12" square, 1/16" thick
- Durable protective epoxy finish to prevent rust

100IM Steel Carpenter Square with inch/metric graduations

**GOOD**



### **105 Brass Stair Gauges**

- Use for making fast, repeat angle cuts on rafters and stairs
- Solid brass construction with sure-grip thumbscrews
- Attaches to any Empire framing square or rafter square

**BETTER**

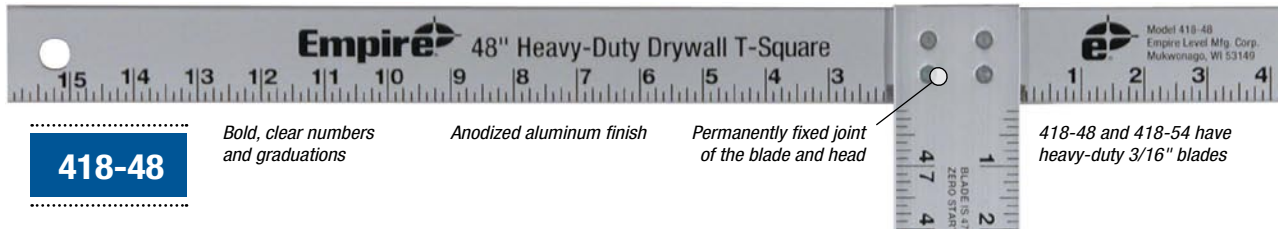

**418-48**

Bold, clear numbers and graduations

Anodized aluminum finish

Permanently fixed joint of the blade and head

418-48 and 418-54 have heavy-duty 3/16" blades



### Professional Drywall T-Squares

**PRO**

- Anodized aluminum finish
- Large, bold numbers and graduations
- Patented rivet design. Permanently fixed joint of blade and head
- Heavy-duty 3/16" thick blade
- Specifically designed for the drywall professional

**418-48** Drywall T-Square with 3/16" thick, 47-7/8" long blade

**418-54** Professional Drywall T-Square with 3/16" thick, 53-7/8" long blade



### 419-48 48" Heavy-Duty Adjustable T-Square

**BETTER**

- **SUPER** heavy-duty 1/4" thick blade
- Head adjusts to any angle. 30°, 45°, 60° and 75° angles marked
- Anodized aluminum finish with easy to read numbers and graduations



### 410-48 Drywall T-Square

**BETTER**

- High visibility, deep stamped, long lasting graduations
- Anodized aluminum construction will not rust
- Large, bold numbers and graduations
- Securely riveted head for accurate cuts and marks



**PRO**  
LIFETIME WARRANTY

### 122 8" Heavy Duty Aluminum Try Square

- Stainless steel etched blade prevents rust and corrosion
- Heavy Duty Aluminum billet handle



**PRO**  
LIFETIME WARRANTY



### 132 9" Heavy Duty Aluminum T-bevel

- T-Bevel has a Heavy Duty Aluminum billet handle
- Low profile locking nut allows for left or right hand use
- Adjustable 9" stainless steel blade



**BETTER**

### 120 8" Polysteel™ Try Square

- Stainless steel blade prevents rust and corrosion
- Polycast® handle includes acrylic vial for level, plumb and 90°/45° work
- 120 has 1/8" graduations. Reads full 8" on inside and outside measurements
- 120M has metric graduations on both sides of the blade Reads full 200mm on inside and outside measurements

**120** Polysteel™ Try Square with inch graduations  
**120M** Polysteel™ Try Square with metric graduations



**BETTER**

### 130 9" Polysteel™ T-Bevel

- T-Bevel has a durable Polycast® handle
- Recessed handgrip
- Low profile locking nut allows for left or right hand use
- Adjustable 9" stainless steel blade



### 900 Pro's Edge Cutting Guide

- 2 Heavy-duty aluminum rails joined together make straight, accurate cuts up to 8' 6"
- Includes both rails, joiner plate, 2 c-clamps
- Use with circular saw, router, utility knife, jigsaw, etc.

**BETTER**



### Heavy-Duty Aluminum Straight Edges

- Easy reading inch scale graduations
- Heavy-duty aluminum straight edge – 2" width

<b>4002</b>	24" Aluminum Straight Edge
<b>4003</b>	36" Aluminum Straight Edge
<b>4004</b>	48" Aluminum Straight Edge
<b>4004IM</b>	48" Aluminum Straight Edge (inch/metric graduations)
<b>4006</b>	72" Aluminum Straight Edge
<b>4008</b>	96" Aluminum Straight Edge
<b>4010</b>	1 Meter Aluminum Straight Edge
<b>403</b>	36" x 1-1/8" Aluminum Straight Edge

**BETTER**



### 320 48" Polycast® Bubble Stick

- Polycast® straight edge with level and plumb vials
- Silk screened, easy to read graduations
- Will not mar or scratch fine surfaces
- Handy for wallpaper and shelving work

**GOOD**



### Brass Plumb Bobs

- Solid brass plumb bob with lacquered finish to resist corrosion
- Ties easily to any string or line

<b>908BR</b>	8 oz. Brass Plumb Bob
<b>912BR</b>	12 oz. Brass Plumb Bob
<b>916BR</b>	16 oz. Brass Plumb Bob
<b>924BR</b>	24 oz. Brass Plumb Bob
<b>932BR</b>	32 oz. Brass Plumb Bob
<b>90832</b>	Brass Plumb Bob Replacement Tip

**PRO**



### Steel Plumb Bobs

- Steel plumb bob with plated finish to resist corrosion
- Ties easily to any string or line

<b>905</b>	5 oz. Steel Plumb Bob
<b>908</b>	8 oz. Steel Plumb Bob

**GOOD**



### 87BLK Carpenter's Pencils

- Unique shape prevents rolling
- Bulk Pack of 72 pieces
- Medium lead can be sharpened easily



### 1000' x 3" Barricade Tape

- Made of durable plastic
- Plastic remains pliant in cold weather

71-1001	CAUTION CAUTION	Yellow Tape with Black Ink/General Purpose
77-1001	CAUTION CAUTION	Yellow Tape with Black Ink
77-1002	CAUTION-CUIDADO	Yellow Tape with Black Ink
77-1004	DANGER DANGER	Red Tape with Black Ink
77-1006	CAUTION-DO NOT ENTER	Yellow Tape with Black Ink
77-1054	CAUTION-CUIDADO	Yellow Tape with Black Ink 54 Pc. Pallet
11-081	DANGER-DO NOT ENTER	Red Tape with Black Ink



### 500' x 3" Reinforced Construction Grade Tape

- Super strong 300 lb break strength is 16x stronger than regular barricade tape
- Long term applications
- No stretch or sag

76-0600	CAUTION-CUIDADO	Yellow Tape with Black Ink
76-0604	DANGER-PELIGRO	Red Tape with Black Ink



### 200'/300' x 3" Barricade Tape

- Made of durable plastic
- Plastic remains pliant in cold weather

77-0201	200' x 3"	CAUTION-CUIDADO	Yellow Tape with Black Ink
77-0204	200' x 3"	DANGER-PELIGRO	Red Tape with Black Ink
71-0301	Econo Grade 300' x 3"	CAUTION	Yellow Tape with Black Ink



### Flagging Tape

- Fluorescent colors
- Durable plastic remains pliant in cold weather
- Each roll is individually UPC'd

200' x 1" ROLLS	600' x 1" ROLLS	600' x 2" ROLLS
77-001 Lime Green	77-062 Orange	77-262 Orange
77-002 Orange	77-063 Pink	
77-003 Pink	77-064 Yellow	
77-004 Yellow	77-065 Blue	
	77-066 White	
	77-067 Red	



### Stake Flags

- 2-1/2" x 3-1/2" flag with 21" wire stem
- Packed in bundles of 100 flags
- Each bundle is individually UPC'd

78-001	Blue	78-006	White
78-002	Orange	78-007	Red
78-003	Pink		
78-004	Yellow		



### Line Reels

- Available in 100', 250' and 500' reels
- Easy to see bright orange, gold, and pink
- Choice of twisted or braided line

TWISTED LINE	BRAIDED LINE	DISPLAY
39201N 250' Gold	39111N 100' Gold	D39101N 100' Gold Twisted Line Reel Display
39203N 250' Orange	39113N 100' Orange	D39513N 500' Orange Twisted Line Reel Display
39503N 500' Orange	39211N 250' Gold	D39511N 500' Gold Braided Line Reel Display
	39213N 250' Orange	
	39214N 250' Pink	
	39514N 500' Pink	



### Construction Line

- Available with 100', 250' and 500' line reels
- Easy to see bright orange and gold

BRAIDED LINE	
39611N 250' Gold	39712N 500' White
39612N 250' White	39713N 500' Orange
39613N 250' Orange	39714N 500' Pink
39614N 250' Pink	39813N 1000' Orange
39711N 500' Gold	

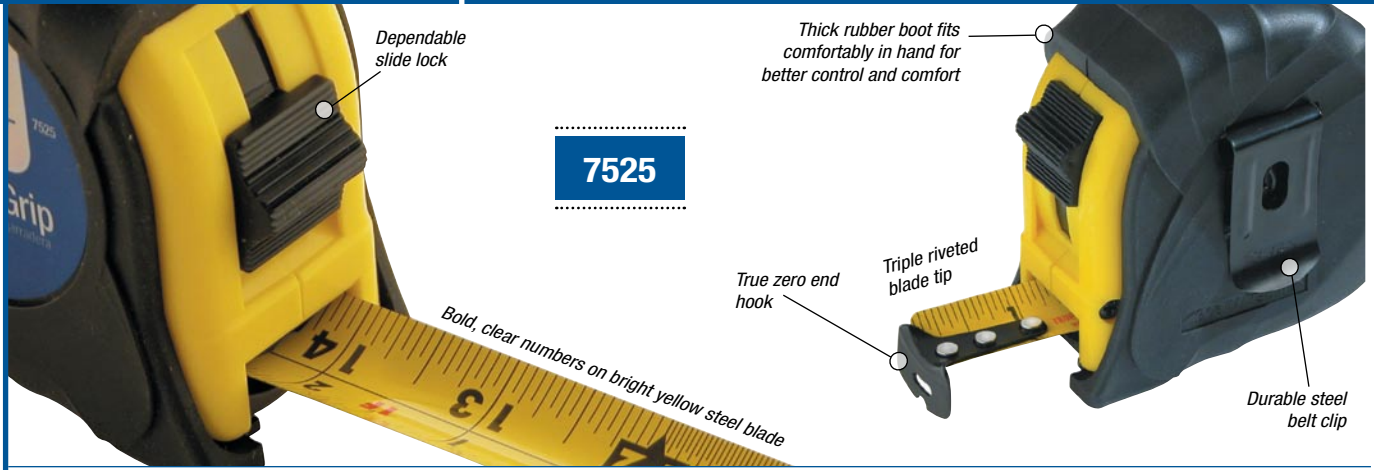

### Power Grip Tapes

- Thick, molded rubber boot fits comfortably in hand for better control, absorbs impacts
- Durable ABS black and yellow cases
- Bold clear numbers on bright yellow tape
- Rigid blade with protective acrylic coating
- Durable steel belt clip
- Dependable slide lock
- Yellow Grip Tapes have blades with fractional graduations

#### BLACK RUBBER BOOT

7516	16' x 3/4" Blade
7525	25' x 1" Blade
7530	30' x 1" Blade
7535	35' x 1" Blade

**BETTER**

#### YELLOW RUBBER BOOT

7517	16' x 3/4" Blade
7526	25' x 1" Blade
7531	30' x 1" Blade
7536	35' x 1" Blade

**BETTER**



### Power Tapes

- Durable chrome and yellow cases
- High impact resistant ABS body
- Bold clear numbers on bright yellow tape
- Rigid blade with protective acrylic coating
- Durable steel belt clip
- Dependable slide lock

#### CHROME CASE

610	10' x 5/8" Blade
612	12' x 5/8" Blade
616	16' x 3/4" Blade
626	25' x 1" Blade
636	30' x 1" Blade

**BETTER**

#### YELLOW CASE

6910	10' x 5/8" Blade
6912	12' x 5/8" Blade
6916	16' x 3/4" Blade
6926	25' x 1" Blade
6936	30' x 1" Blade
6271M	25' x 1" Blade (Inch/Metric)
6371M	30' x 1" Blade (Inch/Metric)
6271E	25' x 1" Blade (Inch/Engineers)
6527POP	25' x 1" Blade (24 Piece Display)

**GOOD**



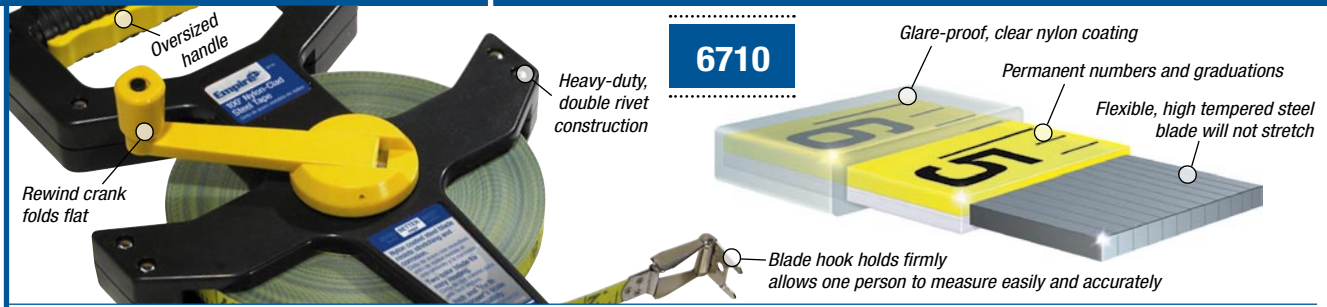

### Nylon-Clad Steel Measuring Tapes

**BETTER**

- Glare-proof, clear nylon coating protects blade from corrosion
- Flexible high tempered steel blade will not stretch
- High impact resistant ABS body
- Numbers and graduations printed in black, foot markings in red
- Black case with two color tape, white side of tape has inch markings, yellow side has engineering scale
- Each tape comes packaged in an attention-getting full color retail box

**6710** 100' x 1/2" Ny clad Steel Measuring Tape  
**6720** 200' x 1/2" Ny clad Steel Measuring Tape



### Open Reel Fiberglass Measuring Tapes

**BETTER**

- Heavy-duty construction, high impact resistant ABS body
- Numbers and graduations printed in black
- Fiberglass tape will not rot, corrode or distort
- Comfortable rubber hand grip
- Yellow case tape has two color tape, white side of tape has inch markings, yellow side has engineering scale
- Black case tape has one color tape with inch/metric graduations

**6799** 100' x 1/2" Fiberglass Measuring Tape (5 piece POP display-Yellow Case)  
**6820** 200' x 1/2" Fiberglass Measuring Tape (Yellow Case)  
**6830** 300' x 1/2" Fiberglass Measuring Tape (Yellow Case)  
**6711** 100' x 1/2" Fiberglass Measuring Tape (Black Case)



### 100' Closed Case Measuring Tapes

**BETTER**

- High impact resistant ABS body
- Contoured rubber grip fits comfortably in hand
- Folding handle for quick retrieval of tape
- 6699 has 3/8" wide carbon steel blade with protective acrylic coating
- 6100 has white 1/2" wide fiberglass tape printed on two sides with inch/engineers scale printed in black, foot markings in red

**6699** 100' Closed Case Steel Measuring Tape  
**6100** 100' Closed Case Fiberglass Measuring tape

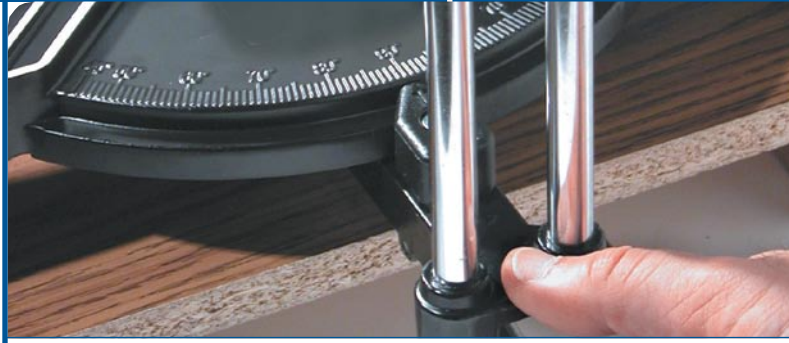

The 8805 Plane is an ideal product for shaving drywall. Its perforated non-clogging design is also ideal for wood, soft metals and plastic.

**36191N**

Easy to operate positive-stop locking mechanism adjustment for common cutting angles left or right



### 36191N Precision Miter Box

- Fully machined diecast base and back
- Work clamps to prevent material movement
- Cutting depth saw stops, reversible length gauge for making repetitive cuts
- Preset common angles, cuts any angle 45° left to right
- 21" European style fine tooth saw

36192N Replacement Blade



### Plastic Miter Box

- Made from high impact plastic
- Features precise cutting angles at 45° left, 90° center, 45° right, and 45° bevel cut

3608N 12" Plastic Miter Box  
36082N 12" Plastic Miter Box with Saw



### 36171N Practical Miter Box

- Durable molded base and back
- Cuts 45°, 54°, 60°, 67.5°, 81° and 90° angles
- 14" Back saw included



### 8802 10" Surface Forming Plane

- Diecast body, 11-1/4" overall length
- Ideal for use on wood, medium metals, plastic, drywall
- Perforated, non-clogging design, hardened steel blade
- High visibility yellow handle

8902 Replacement Blade for 8802



### 8804 Hand Shaper

- Durable plastic body, 7-1/4" long
- Used for close, precision work on curved surfaces/decorative work
- Perforated, non-clogging design, hardened steel blade
- High visibility yellow handle



### 8803 9" Round File

- Wooden handle, 14" overall length
- Used for forming/shaping holes and curves
- Perforated, hardened steel blade, won't clog, cleans easily
- High visibility yellow handle



### 8805 Hand Shaper

- Durable metal body, 5-1/2" long
- Used for close, precision work on curved surfaces/decorative work
- Perforated, non-clogging design, hardened steel blade
- High visibility yellow handle

8901 Replacement Blade for 8805



27105



27030



2704



### 2702 Double Ended Scriber



- Points made from hardened and ground steel. One straight and one bent
- 7-1/4" long with knurled grip

### 20711 3 Pc. Needle File Set



- Set includes flat, round, triangular files
- Sturdy plastic handles

### 27023 Carbide Tipped Scriber



- 6" long for marking on metal, glass, wood, etc.
- Ideal for machinists, welders, mechanics

### 27105 Precision Screwdriver Set



- 6 piece set includes handle with chuck and pivoting end cap
- Black oxide tips, 4 standard flat style, 1 phillips style. Standard sizes .040, .055, .070, 1.00, Phil #0

### 27030 Precision Pencil Compass



- Draws arcs or circles up to 7-1/4" diameter
- Adjustable nut for easy movement
- Hardened and tempered bow spring

### 2715 Precision Drill Set



- 7 Pc. set includes knurled grip with bit storage in end, brass collet, pocket clip
- 6 drill bits, #52, #56, #60, #66, #70, #74
- Used for very small hole drilling on miniatures, jewelry, etc.
- 6-1/4" overall length

### 27031 Compass Scriber



- Coated die cast body with hardened steel scriber pin
- For drawing arcs or circles up to 12"

### 2720 Automatic Center Punch



- Adjustable compression power for one hand use. Tip recoils into work.
- Replaceable hardened point

### 2704 24" Mechanical Pickup



- Retrieves objects from hard to reach places
- Flexible shaft
- Spring action tongs for grabbing

27216



2745



### 27201 Jiffy Center Punch

- Plated steel with replaceable point
- Spring return action used with hammer
- Beveled tip centers screw hole



### 2749 Glass Cutter

- Diecast body with circular steel cutting wheel
- Cuts most household glass up to 1/4" thick
- 5" long, tapping ball at end of handle
- Tooth design removes rough edges



### 27203 Pocket Auto Center Punch

- Lightweight aluminum body
- Hardened steel point
- Convenient pocket clip



### 27621 Heavy-Duty Nut Splitter

- Used for removing rusted, stripped or stubborn nuts
- Drop forged steel construction



### 27216 Revolving Punch

- Nickel chrome steel plated body
- Spring tension self-opening mechanism
- Used for punching round holes in leather, canvas, rubber, plastic, cardboard
- 6 hardened steel punch sizes (5/64", 3/32", 7/64", 1/8", 5/32", 3/16")



### 2776 Precision Oiler

- Brushed aluminum finish with O-ring sealed oil compartment
- Push button control with cover and pocket clip, 5-1/2" long
- Allows precise distribution of oil, one drop at a time



### 2740 4 Pc. Pick Set

- Set includes different shaped picks at different angles, each 6-7/8" long
- High carbon ground points
- Lightweight, hex shaped aluminum handles
- Used for separating wires, scribing, retrieving small parts, "O" ring removal



### 27770 T-Handled Tapered Reamer

- Precision hardened steel reaming blade
- T-handle for extra leverage
- Reaming capacity 1/8" to 1/2" holes



### 2745 Precision Pliers and Snip Set

- Ideal for cutting thin gauge metal, stripping and snipping wires
- Stainless steel jaws and tips
- Pliers 5-1/4" long, small cutter 4-1/4" long



### 27783 Heavy-Duty Swivel Handle Deburring Tool

- Precision ground steel blade
- Hex shaped aluminum high visibility yellow handle

27991

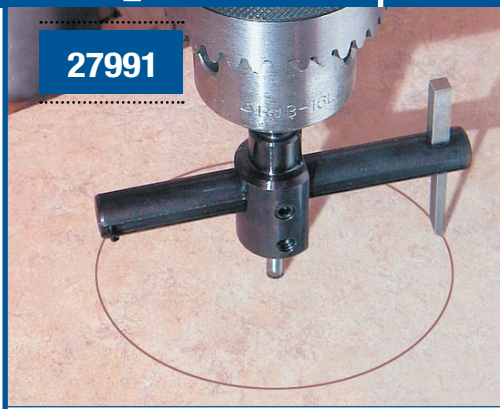

2754



### 27026 6-1/2" Scratch Awl

- Forged, high carbon steel 3-1/2" blade
- Precision ground point
- Durable, contoured hardwood handle
- Used for scribing, perforating, punching



### 2754 Contour Gauge

- Stainless steel probes with 6" long metal casing
- 3-1/4" probe length will read a 1-7/8" maximum pattern depth
- Low profile for easy operation



### 27221 7/64" Self-Centering Hinge Bit #5, #6

### 27222 9/64" Self-Centering Hinge Bit #8, #10

### 27223 11/64" Self-Centering Hinge Bit #12

- Spring loaded beveled tip centers hinge holes
- Adjustable drill depth
- Drills soft metal, wood, plastic
- Replaceable jobber length drill bits
- Hex shaft and quick disconnect



### 27771 High Speed Steel Countersink

- 1/2" Capacity, 5 Flute
- Hardened steel with 82° taper. 1-3/4" long
- Cuts wood, plastic, soft metal
- Cuts clean, round holes, chatter-free
- To be used with an electric drill



### 27532 6 Pc. Drill Stop Set

- Adjusts to exact hole depth, prevents overdrilling
- 6 sizes: 3/16", 1/4", 5/16", 3/8", 7/16", 1/2"
- For all types of drill bits



### 27991 5" Circle Cutter

(7/8" to 5" dia.)

### 27992 6" Circle Cutter

(7/8" to 6" dia.)

### 27993 8" Heavy-Duty Circle Cutter

(7/8" to 8" dia.)

- 1/2" Capacity, 5 Flute
- Hardened steel with 82° taper. 1-3/4" long
- Cuts wood, plastic, soft metal
- Cuts clean, round holes, chatter-free
- To be used with an electric drill
- Hex Key included with 27991, 27992 Circle Cutter



2780

27303

2784



### 2730 6" Pocket Ruler

- Stainless steel
- 32nds, mm markings, dec. equivalents



### 27302 6" Ruler

- Stainless steel
- 32nds and millimeters on front, conversion table on the back
- Permanent and accurate photo-engravings/electrolytical etchings
- Sub zero feature allows 32nds and 64ths readings from right to left below the "0" mark



### 27551 Conversion Table

- Slide rule conversion 7" long
- Converts inch/mm, ga./liter, pounds/kg., Fahrenheit/celsius, feet/meters, yards/meters
- Extensive equivalents, formulas, fraction/decimal/metric equivalent chart



### 2760 Screw ID Gauge

- SAE standards - #1 to 5/16"
- Tempered steel 5/64" thick, 5-1/8" long
- Used to identify size of screws, bolts, rivets, wires, pins with length, diameter, wire size, screw pitch, and clearance drill size



### 27303 6" Stiff Ruler

- Stainless steel
- 100ths, 64ths, 32nds, 16ths, 10ths, mm



### 2780 1" Micrometer

- Diecast metal frame, 5" long
- 1" capacity by .0005"
- Ratchet stop and spindle lockout to hold measurement
- Adjustable realignment to "0"



### 27308 12" Hook Ruler

- 32nds, mm, cm



### 2783 Brass Pocket Caliper

- Brass body and slide, 4-7/8" long
- 4"/80mm capacity by 32nds and mm.
- Reads inside and outside measurements



### 27318 18" Stainless Steel Ruler

- 8ths, 16ths, mm



### 2784 Vernier Caliper

- 4-3/4"/120mm capacity by 1/6"/1/10mm
- 7-1/8" long steel body
- Friction stop roller and thumb screw lockout
- 3 way measuring- inside, outside, depth



### 27511 26 Leaf Feeler Gauges 27512 Metric 26 Leaf Feeler Gauges

- Leaves from .002 to .025 w/mm equiv. & 2" scale, .038 mm - .098 mm for metric
- Used individually or combined for precise measurement of gaps
- Chrome plated with knurled nut to lock in place
- Meets Fed. Specs #GGG-G-17C for tolerance



### 2785 Metric Dial Caliper

- 3 way measuring- inside, outside, depth
- Bezel realignment to "0"
- Reinforced nylon construction



### 2755 Drill Gauge

- 29 fractional drills 1/16" to 1/2" by 64ths
- Made of tempered steel 6-1/2" long
- Reads in fractions with decimal equivalents
- Easy to read white markings on black finish, stamped letters on reverse side

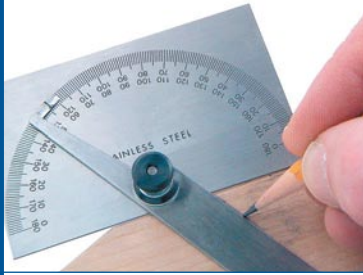

Precision measuring tools made of the finest stainless steel, aluminum and state-of-the-art plastics are the foundation for obtaining precise readings and doing accurate work

**27912**

**2792**

2792, 2793, 2794 Dividers and calipers excel in taking accurate measurements in a shop environment



2786/2787 Dial Calipers offer the flexibility of inside, outside and depth measurements

**2786**



### 2786 6" Dial Caliper Measurement by .001

### 2787 6" Dial Caliper Measurement by .01 and 64ths

- Direct dial reading in inches and mm
- 4 way measuring- inside, outside, depth, and step
- Adjustable bezel realignment to "0"
- Fiberglass reinforced nylon with milled jaws for precision. 8-3/4" long.
- Thumb lockout holds measurement.



### 2789 6" Digital Electronic Caliper

- Hardened stainless steel with satin chrome finish. 9-1/8" long.
- Accurate to .0005/.25mm
- 3 way measuring- inside, outside, depth
- LCD display with automatic power off
- SPC interface #RS232
- Uses #37891 (SR44W) replacement battery



### 27912 Stainless Steel Protractor

- 6" stainless steel arm, square head
- 0-180° measurements
- Use to measure and transfer angles



### 27913 Depth and Angle Finder Gauge

- Use for making precise depth measurements in small holes and slots
- Spring tension nut secures the rule at 90° to the base
- Angles of 30°, 45°, and 60° are etched on backside

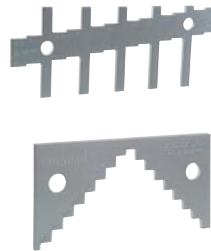

### 10304 Router and Saw Depth Gauge Set

- Use for setting cutting depth of router bit, table saw or circular saw blade
- Solid aluminum gauges will not rust
- Deep stamped numbers and graduations



### 2791 Protractor/Angle Finder

- 6" long, high strength plastic with brass hardware.
- Measure/transfer inside/outside sloped angles
- Use for miter angle layout
- The finest multi-purpose protractor on the market



### 2792 6" Divider

### 2793 6" Inside Caliper

### 2794 6" Outside Caliper

- Square leg calipers of hardened, forged steel
- Fast-action release
- Hardened and tempered bow springs
- Fulcrum spools provide even tension
- Adjustment screws for quick, easy movement



### 27033 12" Compass

- Made from heat treated polished steel
- Spring is hardened and tempered
- Ideal for laying out distances between two points and making circles



27058



27065



27059



### 27050 High Power Magnetic Pickup

- Overall length is 8-3/4" long
- High powered Neodymium magnet has 2 pounds pull
- Locking pivot point for greater control
- Handy pocket clip



### 27052 Telescoping Magnetic Pickup

- High powered Neodymium magnet lifts 1-1/2 pounds
- Extends from 5-5/8" to 25-7/8"
- Built in pocket clip



### 27056 Telescoping Pointer Magnet

- Extends from 5-3/4" to 25-7/8"
- High powered Neodymium magnet lifts 1-1/2 pounds lifting power
- Convenient pocket clip



### 27058 Magnetic Clean Club

- Powerful magnetic head
- Aluminum shaft extends to 40"
- Lifts nails, screws, nuts, bolts, small machined parts



### 27059 Magnetic Clean Sweep

- Rolling unit with powerful magnetic head 11-1/2" wide lifts nails, screws, nuts, bolts, small machined parts
- Aluminum shaft extends to 40"
- Adjustable angle magnetic head



### 27060 24" Heavy Duty Magnetic Sweep

- Rolling unit with powerful magnets enclosed in a heavy gauge aluminum shell
- Picks up to 30lbs of metallic debris over a variety of surfaces
- Release handle for easy removal of debris
- Adjustable sweeping height: 3/4" to 1-1/2"
- Adjustable handle length: 25" to 40"
- Removable handle for easy storage



### 2706 16" Bendable Magnet

- Bendable shaft shapes and reshapes with round style to fit any need
- High powered Neodymium magnet lifts 1-1/2 pounds
- Used for retrieving parts/tools from very hard to reach places
- Lightweight knurled aluminum handle



### 27065 Power Lift Magnet

- Lifts 150 lbs
- Permanent magnet with eye hook
- Retrieving tools, fishing poles, tackle boxes, temporary lifting of small motors, machined parts



### 2707 Flexible Magnetic Strip

- 1/2" wide x 30" long
- Can be cut to desired length
- Opposite side has adhesive backing
- Used to hold small metal items



### 27071 1" Flexible Magnetic Strip

- 1" wide x 30" long
- Can be cut to desired length
- Opposite side has adhesive backing
- Used to hold small metal items



### 27073 3/4" Button Magnet (7 Pcs) 27074 1" Button Magnet (6 Pcs)

- Use to position, hold, lift
- Ideal for the home, office, school, or crafts

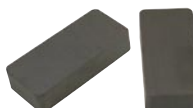

### 2708 All Purpose Magnets

- 2 high power ceramic magnets
- Lifting capacity is 3 lbs. each
- Used to identify metal, locate studs, hang notes, glue-onto-projects, holding metal objects, magnetizing tools, parts pickup

### 27088

Teamed together with our 2788 Readout gauge, this makes for an unbeatable ensemble for getting accurate readings in a shop or manufacturing environment



### 2709

Both halves banded together will add magnetism to your tools. Using the two halves separately will remove those magnetic properties

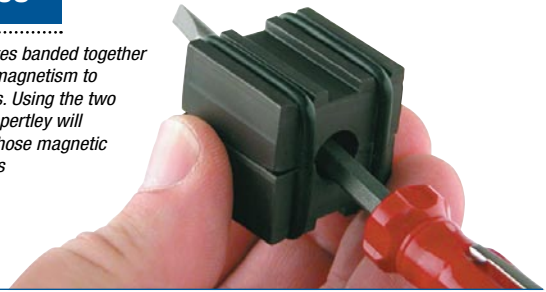

### 27083 30 Pc. Ferrite Magnet Set

- 10 each of round, square and triangular shaped magnets
- 1-1/4" sizes
- Ideal for crafts, hobbies, experiments



### 27085 Shallow Pot Magnet 1-3/8" Diameter. 15 lb. pull

### 27086 Shallow Pot Magnet 2" Diameter. 20 lb. pull

- Magnetic base in chrome plated cup
- 3/16" center hole for mounting
- Used for positioning, holding or lifting



### 27021 Scriber/Magnet

- Scriber end has carbide tip for long life
- High powered Neodymium magnet lifts 1-1/2 lbs
- Knurled aluminum handle with pocket clip
- 5-3/4" long



### 27088 Dial Indicator Magnetic Base

- Stepped rod for clamp
- Powerful and compact magnetic base
- Ideal for use with dial indicator



### 27091 Alnico Horseshoe Magnet

- Pocket size for convenience
- Powerful 1 oz. magnet has 2-1/4 lb. pull
- Includes keeper for long life



### 2709 Magnetizer/Demagnetizer

- Magnetizes or demagnetizes metal objects
- Converts tools into magnetic pickups or to steady screws
- Ideal for use on screwdrivers, wrenches, taps, etc.



### 2788 Dial Indicator Readout Gauge

- Full 1" capacity
- Rotating bezel base
- Rear lug indexes 90° for vertical or horizontal mounting

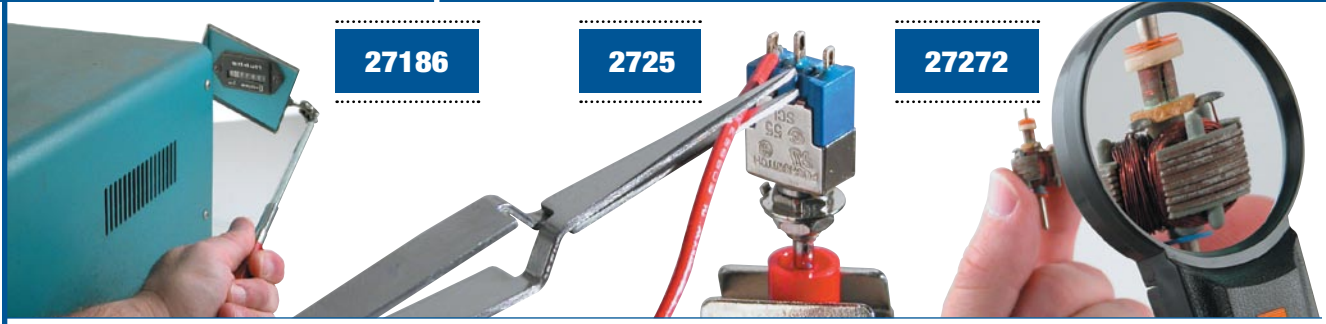

27186

2725

27272



### 2718 Round Inspection Mirror

- 1-1/4" round, copper backed clear view glass mirror, 8" length with built in pocket clip
- All-angle ball swivel joint



### 27253 6-1/2" Curved Tweezers

- Nickel plated points for durability



### 27185 Round Inspection Mirror

- 2-1/4" round mirror version has 14" telescoping extension, swivel-ball joint for 360° viewing, vinyl grip, clear view glass mirror



### 2727 2" Magnifying Glass

- 4x magnifying power optical quality glass in molded, one piece frame
- Unbreakable, scratch-resistant glass



### 27186 Rectangular Inspection Mirror

- 2" x 3" rectangular mirror version has swivel-ball joint, vinyl grip, extends to 16"



### 27271 Eye Loupe

- Unbreakable, scratch resistant lens
- 5x magnifying power
- Durable one piece plastic housing



### 2725 4-1/2" Cross Lock Tweezers

- Self-closing tips provide tension to act like a miniature vise. Jaws open 5/8"
- Stainless steel with precision points



### 27272 3" Lighted Magnifying Glass

- Durable plastic housing
- Shatter proof lens has 3x power magnification
- Uses 2 AA size batteries (not included)



### 27252 5" Bevel Point Tweezers

- Nickel plated points
- Perfect for watch repair, crafts, etc.



**SALES AND MARKETING HEADQUARTERS**

Empire Level Mfg. Corp.  
929 Empire Drive  
Mukwonago, WI 53149

**MANUFACTURING HEADQUARTERS**

Empire Level Mfg. Corp.  
932 Empire Drive  
Mukwonago, WI 53149

**MAILING ADDRESS**

Empire Level Mfg. Corp.  
P.O. Box 800  
Mukwonago, WI 53149

**PAYMENT REMITTANCE**

Empire Level Mfg. Corp.  
Bin #380  
Milwaukee, WI 53288

**CUSTOMER SERVICE ORDER DEPT** 1.800.558.0722  
**CUSTOMER SERVICE FAX DIRECT** 262.368.2131

**PHONE** 262.368.2000  
**FAX** 262.368.2127  
**EMAIL** [empire@empirelevel.com](mailto:empire@empirelevel.com)  
**WEB** [www.empirelevel.com](http://www.empirelevel.com)



PRODUCT #	PAGE #	PRODUCT #	PAGE #	PRODUCT #	PAGE #	PRODUCT #	PAGE #	PRODUCT #	PAGE #
<b>1</b> 100	16	27253	30	396	15	6936	20	<b>D</b> DLX1	7
100IM	16	2727	30	39611N	19			DLX10.24	7
10304	27	27271	30	39612N	19	<b>7</b> 71-0301	19	DLX10.48	7
105	16	27272	30	39613N	19	71-0302	19	DLX10.72	7
1010	16	2730	26	39614N	19	71-1001	19	D39101N	19
11-081	19	27302	26	39711N	19	720	13	D39511N	19
1110	16	27303	26	39712N	19	721	13	D39513N	19
1110IM	16	27308	26	39713N	19	727-24	13	DLX60.07	7
1140	16	27318	26	39714N	19	7516	20		
120	17	27368	13	39813N	19	7517	20	<b>e</b> e1190	16
120M	17	2740	24	3990	15	7525	20	e250	14
122	17	2745	24			7526	20	e250M	14
1240	16	2749	24	<b>4</b> 4002	18	7530	20	e255	14
130	17	27511	26	4003	18	7531	20	e255M	14
132	17	27512	26	4004	18	7535	20	e280	14
		27532	25	4004IM	18	7536	20	e280M	14
<b>2</b> 20711	23	2754	25	4006	18	76-0600	19	e2992	15
220	14	2755	26	4008	18	76-0604	19	e3992	15
220IM	14	27551	26	4010	18	77-001	19	e50.24	10
230	14	2760	26	403	18	77-002	19	e50.48	10
240	14	27621	24	410-48	17	77-003	19	e50.72	10
240IM	14	2776	24	418-48	17	77-004	19	em51.24	10
240M	14	27770	24	418-54	17	77-0201	19	em51.48	10
26187	9	27771	25	419-48	17	77-0204	19	em51.78	10
26195	9	27783	24	430-18	11	77-062	19	e70.24	8
26203	9	2780	26	430-24	11	77-063	19	e70.48	8
26252	9	2783	26	430-36	11	77-064	19	e70.72	8
26278	9	2784	26	430-48	11	77-065	19	e70.96	8
26286	9	2785	26	460-36	13	77-066	19	e70JAMB	8
26302	9	2786	27			77-067	19	em71.24	8
2702	23	2787	27	<b>5</b> 540-24	11	77-1001	19	em71.48	8
27021	29	2788	29	540-48	11	77-1002	19	em71.78	8
27023	23	2789	27	580-18VP	11	77-1004	19	em71.96	8
27026	25	2791	27	580-24	11	77-1054	19	em71JAMB	8
27030	23	27912	27	580-36	11	77-262	19	e80.24	10
27031	23	27913	27	580-48	11	78-001	19	e80.48	10
27033	27	2792	27	580-72	11	78-002	19	e80.72	10
2704	23	2793	27	581-18	10	78-003	19	e80.78	10
27050	28	2794	27	581-24	10	78-004	19	e80.9	12
27052	28	27991	25	581-36	10	78-006	19	e80.96	10
27056	28	27992	25	581-48	10	78-007	19	em81.10	12
27058	28	27993	25	581-72	10			em81.12	12
27059	28	295	15	581-9	12	<b>8</b> 83038	13	em81.24	10
2706	28	296	15	587-24	12	83-3	13	em81.48	10
27060	28	2990	15			83-50	13	em81.68	10
27065	28	2999	15	<b>6</b> 600.24	8	840.72	8	em81.78	10
2707	28			600.48	8	845.24	8	em81.9	12
27071	28	<b>3</b> 320	18	610	20	845.48	8	em81.96	10
27073	28	330-24	11	6100	21	84-5	13	e90.24	9
27074	28	330-36	11	612	20	850-48	9	e90.48	9
2708	28	330-48	11	616	20	87BLK	18	e100.24	8
27083	29	331-9	12	626	20	8802	22	e100.48	
27085	29	338-36	12	627IE	20	8803	22		
27086	29	33-9	12	627IM	20	8804	22	<b>T</b> TC16	10
27088	29	36	15	636	20	8805	22	TC17	10
2709	29	3604	13	637IM	20	8901	22		
27091	29	3608N	22	6527POP	20	8902	22		
27105	23	36082N	22	6699	21				
2715	23	361	15	6710	21	<b>9</b> 900	18		
2718	30	36171N	22	6711	21	905	18		
27185	30	36191N	22	6720	21	908	18		
27186	30	36192N	22	6799	21	90832	18		
2720	23	39111N	19	68-048	11	908BR	18		
27201	24	39113N	19	68-148	11	912BR	18		
27203	24	39201N	19	68-178	11	916BR	18		
27216	24	39203N	19	6820	21	924BR	18		
27221	25	39211N	19	6830	21	932BR	18		
27222	25	39213N	19	6910	20	93-3	13		
27223	25	39214N	19	6912	20	990BB-24	9		
2725	30	39503N	19	6916	20	990BB-48	9		
27252	30	39514N	19	6926	20				





**EMPIRE LEVEL MFG. CORP.**  
929 Empire Drive  
Mukwonago, WI 53149  
Phone: 262-368-2000  
Fax: 262-368-2127  
Customer Service: 1-800-558-0722  
Customer Service Fax: 262-368-2131  
E-mail: [empire@empirelevel.com](mailto:empire@empirelevel.com)  
Web: [www.empirelevel.com](http://www.empirelevel.com)

PR 300 6/10  
©2010 Empire Level Mfg. Corp.