



Assortments



Farm Hardware



Merchandisers



Shop Supplies



Lubrication



Tow Pro Towing & Accessories



Impulse Buy Displays & Products



Chain & Rigging



Boss Tools & Accessories



General Hardware



Cargo Control



Paladin Lighting



PRODUCT CATALOGUE 2018





Your Trusted Source.

OUR STANDARDS

- 95% or better fill rates
- Minimal shipping errors
- Industries lowest defect rates (less than .5%)
- Penalty-free! One year stock protection guarantee on new products
- Annual stock return of up to 5% of prior year sales
- Stock orders shipped within 48 hours, rush orders same day.
- Annual review
- Prepaid freight policy

Ask us about us about all the benefits of becoming a recognized Dynaline Distributor!

High performance standards that insure you can't lose. Your success is our success.

BRAND FAMILY



This is our original and trusted brand for quality products. Included are shop supplies, lubrication, cargo control and hardware supplies.



Boss products are the tradespersons best friend. This brand offers a variety of products such as drill bits, cutters/blades, tape measures, saw blades, LED flashlights, and carpenter pencils. Accompanied by our *Boss Custom Printing Program*, the Boss brand provides an excellent and affordable way to advertise your business with products you can proudly stand behind.



Paladin lights the way to your success by offering high-intensity lighting solutions. The Paladin line boasts the some of the highest quality materials and design in the industrial lighting industry. The products range from work site lights to light bars and even to hand-held lighting solutions, making sure your customers and your business are never left in the dark.



Tow Pro is the cornerstone of trailer and towing industry. If something needs hauling, Tow Pro will make sure it gets there. From industrial to recreational demands, the Tow Pro line offers a wide selection of ball mounts, hitches, jacks, couplers, trailer balls, and a load of other trailer and towing accessories. Tow Pro products meet or exceed all U.S. VESC tow standards.



Tool Valley is our brand for *impulse buy* products. Products and merchandising bins are offered at three different price points to hit the widest market possible and provide an excellent return on investment. Supported by our product guarantee policy and Dynaline's Tool Tracker program, which is offered to select distributors with busy showroom traffic.

PROUD MEMBERS OF



CHHMA

Quality Systems Since 1994



ISO 9001

ISO 9001:2008
Quality Management System
CERT-0050960

Merchandisers



- Gondolas
- Plan-O-Grams
- Board Merchandisers
- Free Standing
- Counter-top Merchandisers
- Impulse Buy Merchandisers



MERCHANDISERS



Merchandisers



Table of Contents

Introduction	3	Shop Supplies Merchandisers	46
Free Standing Merchandiser Rack	4	Springs Merchandiser - Retail Packaged	46
00024 - Merchandiser Rack	4	Springs - Expanded Selection 1	47
Customization Options	4	Springs - Expanded Selection 2	47
Tow Pro Trailer & Towing Merchandisers	6	Retainer Rings Merchandiser	48
Trailer Balls Merchandiser	6	Retainer Rings Cont.....	49
Trailer Couplers Merchandiser	6	Machinery Bushings Merchandiser	49
Trailer Connectors Merchandiser	7	Retainer Rings Tilt Bins Merchandiser	50
Trailer & Towing Plan-O-Gram 72"	8	Springs Merchandiser - Bulk Springs Cabinet	51
Trailer & Towing Plan-O-Gram 48"	9	Keystock	51
Ball Mount Rack	10	Caster Wheels Plan-O-Gram	52
Jack Rack	11	Small Wheel Rack Merchandiser	52
Lubrication Merchandisers.....	12	Castor & Assorted Wheels Merchandiser	53
S.A.E. O-Rings Merchandiser	12	Wheel Merchandiser	53
Grease Accessories Merchandiser	13	Boss Merchandisers	54
Lubrication Plan-O-Gram	14	BOSS Padlock Merchandiser	54
Funnels & Lubrication Merchandiser	15	BOSS Quality Cutters and Blades Merchandiser	54
Plastic Funnels & Measures Merchandiser	16	Drill Bit Display	55
Lubrication Plan-O-Gram	17	Boss Counter Top Merchandisers	56
O-Ring Tilt Bins Merchandiser	18	Overtime Saw Blades	56
Assortments Merchandisers	19	12mm Carpenter Pencils.....	56
Dynakit Assortments Merchandiser	19	15mm Carpenter Pencils.....	56
Dynatray Assortments Merchandiser	19	Plastic Cutter, 3/4" Blade	56
New Assortments Merchandisers	20	Utility Grade Tape Measures - 6/Box	56
Assortments Plan-O-Gram	21	Professional Grade Tape Measures - 12/Box	56
Cargo Control Merchandisers	22	Fold-able Funnels	56
Cargo Control Plan-O-Gram	22	Dual Head Stubby Ratchet.....	57
Load Binder/Cable Puller Rack	22	Stubby Claw Hammer	57
Chain and Rigging Merchandisers.....	23	Razor Folding Utility Cutter	57
Wire Rope Accessories Merchandisers	23	Cree LED 3W Focusing Light	57
Stainless Steel Hardware Merchandiser	24	8 LED Light with Laser Pointer.....	57
Chain Connectors Merchandiser	25	Counter-top BOSS Driver Bit Kit Display.....	58
Chain Hooks Merchandiser	26	Counter-top BOSS Compact Driver Bit Display	58
Shackles & Clevises Merchandiser.....	26	Paladin Lighting Merchandisers.....	59
Wire Rope Accessories Merchandiser	27	Paladin Work Light Merchandiser	59
Chain Rack - 4'	28	2-in-1 COB Work Flashlight.....	59
Chain Rack - 2'	28	Pocket Work Light and Spot Light	59
Chain & Steel Cable Rack Merchandiser.....	29	Magnetic Utility Light with Hook	59
General Hardware Merchandisers	30	Impulse Products Merchandisers.....	60
General Hardware Merchandiser	30	Red Impulse Buy Table	60
General Hardware Continued	31	Blue Impulse Buy Table	60
Snaps Merchandiser	32	Black Impulse Buy Table	60
Eyebolts & Rings Merchandiser	33	Backdrops and Signs.....	61
U-Bolts Merchandiser	34	Custom Bulk Bin Program	62
Muffler Clamps Merchandiser	34	Empty Product Storage Solutions.....	64
Pulley Blocks Merchandiser	35	Tilt Bins.....	64
Aluminum Pulleys Merchandiser	36	Dynaline Bin Box.....	64
Turnbuckles Merchandiser - General Purpose.....	37	Storage Bins.....	64
Turnbuckles Merchandiser - Forged Steel.....	37		
Bronze Bushings Merchandiser	38		
Snaps Merchandiser	39		
Farm Hardware Merchandisers	40		
Pins Merchandiser	40		
Farm Hardware Merchandiser	41		
Grade 8 Hitch Pins Merchandiser	42		
E-Grip & Forged Steel Hitch Pins Merchandiser	42		
Hitch Pins Merchandiser	43		
Hitch Pins (Fold Over Handle) Merchandiser	43		
Tractor Linkage Parts Merchandiser	44		
Stroke Control Merchandiser	44		
Weather Caps Merchandiser	45		
Farm packs Merchandiser	45		



Dynaline's Merchandiser Program

Improve the visibility of product in your store and provide a clean and organized product presentation, at the same time, saving valuable retail space. Become recognized as the best supplier of these products in your area.

Dynaline merchandisers offer the most popular product mix to ensure maximum results.

WE CAN HELP YOU:

- Customize your selection based on your market.
- Work together to make the product mix right for you.
- Assist with change over to our new merchandiser design.



Merchandisers

Free Standing Merchandiser Rack

Free Standing Customizable Merchandiser



*Merchandiser Boards
Sold Separately*

Fully Customizable

Easy Setup, stock and update.

Great ROI per Sq/foot. Only uses 4 Sq/Ft of retail space.

We can help you choose the best product mix for your business.

We will assist the change to our merchandisers.

Flat base or caster wheel base options.

★★★★★
**CUSTOMER
 FAVORITE**

00024 - Merchandiser Rack

Sturdy, free standing floor unit securely holds up to twelve 24" x 24" or up to twenty four 12" x 24" DYNALINE Board Merchandisers. Includes rack and assembly hardware.

Dimensions: 24" x 24" x 84".

PART#	CONTENTS
00024	Merchandiser Rack Only
00024-1	Set of 4 Caster Wheels Only . Swivel and Locking (optional)



Caster option available



Merchandisers



The 00024 merchandiser is one of the most versatile merchadiser in the market.

Once the frame is setup it can accomodate many different layouts and product categories. Along with multiple categories of products that can be displayed, Dynaline also offers multiple sizing options for many of the display boards increasing options and control of merchandise even further (See below).

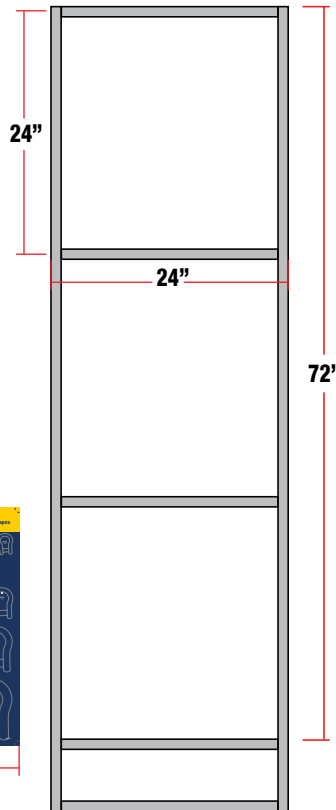

Here is a listing of our pre-designed merchandisers that can mix and match to fit the 00024 floor display rack

- | | |
|--|---|
| Trailer Balls - Part# 00208 | Hitch Pins - Part# 00436 |
| Trailer Couplers - Part# 00215 | Grade 8 Hitch Pins - Part# 00439 |
| Machinery Bushings - Part# 00235 | E-Grip Hitch Pins - Part# 00441 |
| Bronze Bushings - Part# 00325 | Hitch Pins - Ext Selection - Part# 00435 |
| Dynakit Assortments - Part# 00296 | Wire Rope Accessories - Part# 00566/00567 |
| Dynatray Assortments - Part# 00031 | Stainless Steel Hardware - Part# 00619 |
| S.A.E O-Rings - Part# 00318 | Chain Connectors - Part# 00614 |
| Grease Accessories - Part# 00527 | Chain Hooks - Part# 00408 |
| Springs : Retail packaged - Part# 00242 | Shackles and Clevises - Part# 00386 |
| Springs : Expanded selection - Part# 00244 | Stroke Control - Part# 00297 |
| Bulk Springs - Part# 00243 | Universal Display Boards - Part# 00800 |
| Retainer Rings - Part# 00245 | U-Bolt - Part# 00612 |
| Turnbuckles : Gen. purpose - Part# 00416 | Weather Caps - Part# 00226 |
| Turnbuckles : Forged Steel- Part# 00417 | Pulley Blocks - Part# 00334 |
| Snaps - Part# 00447 & Part# 00448 | Aluminum Pulleys - Part# 00335 |
| Padlocks - Part# 00225 | Pins - Part# 00557 |
| Eyebolts and Rings - Part# 00611 | Tractor Linkage Parts - Part# 00438/00437 |
| Muffler Clamps - Part# 00307 | Farm Packs - Part# 00620 |

Merchandisers

Tow Pro Trailer & Towing Merchandisers



TOW-PRO



00024 ✓
Compatible

Trailer Balls Merchandiser

PART#	CONTENTS
00208	Trailer Balls Display Board Only , 12" x 24"
00208K	Full Trailer Balls Merchandiser . Includes 00208 display board, 12 pegs (80004) and product listed below:

PART#	DESCRIPTION	QTY.
11147P	1-7/8" Ball, 1" external thread	2 ea.
11148P	1-7/8" Ball, 3/4" internal thread	2 ea.
11149P	2" Ball, 3/4" internal thread	2 ea.
11151P	1-7/8" Ball, 3/4" external thread	2 ea.
11152P	2" Ball, 3/4" external thread	2 ea.
11153P	2" Ball, 1" external thread	2 ea.
11154P	2-5/16" Ball, 1" external thread	2 ea.
11155P	2-5/16" Ball, 1-1/4" external thread	2 ea.
11155HP	2-5/16" Ball, 1-1/4" external thread, HD	2 ea.
11155XP	2-5/16" Ball, 1-1/4" external thread, HD	2 ea.
11251P	1-7/8" Ball, 3/4" external thread, long shank	1 ea.
11252P	2" Ball, 3/4" external thread, long shank	1 ea.



TOW-PRO



00024 ✓
Compatible

Trailer Couplers Merchandiser

PART#	CONTENTS
00215	Trailer Couplers Display Board Only , 24" x 24"
00215K	Full Trailer Couplers Merchandiser . Includes 00215 display board, 10 pegs (80004) and product listed below:

PART#	DESCRIPTION	QTY.
11156	For 1-7/8" Trailer Balls, 2" Channel	2 ea.
11157	For 1-7/8" Trailer Balls, 2-1/2" Channel	2 ea.
11158	For 1-7/8" Trailer Balls, 3" Channel	2 ea.
11159	For 2" Trailer Balls, 2-1/2" Channel	2 ea.
11159N	For 2" Trailer Balls, 2" Channel	1 ea.
11160	For 2" Trailer Balls, 3" Channel	2 ea.
11161	For 2" Trailer Balls	1 ea.
66276	Coupler Lock	2 ea.
66277	Coupler and Receiver Lock Set	2 ea.

Plan-O-Grams do not include gondola or shelves. Products may not be exactly as illustrated.

Trailer Connectors Merchandiser

PART#	CONTENTS
01042	Trailer Connectors Backdrop Only , 48" x 48"
01042K	Full Tow Pro Trailer Connectors Plan-o-gram. Includes 01042 and 35 pegs (80004) and the products listed below:

PART#	DESCRIPTION	QTY.
27002	2 Pole Flat Connector	2 ea.
27004	4 Pole Flat Connector, 18 Ga. Wire	2 ea.
27006	4 Pole Flat Connector	2 ea.
27008	4 Pole Flat Connect, 25 ft. Loop	2 ea.
27010	Heavy Duty 4 Pole Connector	2 ea.
27015	4 Pole Round Plug & Socket	2 ea.
27020	5 Pole Flat Male Connector	2 ea.
27022	5 Pole Flat Female Connector	2 ea.
27030	6 Pole HD Plug & Socket	2 ea.
27034	6 Pole Round Socket-Heavy Duty	2 ea.
27036	6 Pole Plug, Heavy Duty	2 ea.
27040	Mounting Bracket for 7 Way Trailer Connectors	2 ea.
27042	7-Way Socket, Vehicle Side	2 ea.
27044	7-Way Blade Plug	2 ea.
27046	7-Way Plug & Socket With Cover	2 ea.
27048	7-Way Socket, Plastic Housing - Vehicle Side	2 ea.
27050	7-Way Plug-in Plastic Housing - Trailer Side	2 ea.
27052	7-Way Socket & 4-Way Plug Set - Vehicle Side	2 ea.
27056	7-Way Socket & 4-Way Plug plus Mounting Kit	2 ea.
27060	7-Way Plug, Heavy Duty - Trailer Side	2 ea.
27062	7-Way Socket, Heavy Duty - Vehicle Side	2 ea.
27064	7-Way Plug, ABS Housing - Trailer Side	2 ea.
27066	7-Way Socket, ABS Housing - Vehicle Side	2 ea.
27068	7-Way Socket, Heavy Duty - Vehicle Side	2 ea.
27076	4-Way In-Line Adapter	2 ea.
27078	Trailer Adapter, 6-Way Round	2 ea.
27080	Trailer Adapter, 7-Way Round	2 ea.
27082	Trailer Adapter, 7-Way Round to 6 Way	2 ea.
27084	Trailer Adapter, 7-Way Round to 4 Way	2 ea.
27086	Adapter, 7-Way Rnd. to 6-Way; 5-Way Flat to 4 Way	2 ea.
27088	Adapter, 7-Way Blade, Male to Female	2 ea.
27090	4-Way Flat Connector with cover	2 ea.
27092	4-Way Flat Tester	2 ea.



27093	4-Way & 5-Way Flat Tester	2 ea.
27096	7-Way Blade Tester	2 ea.
27098	Breakaway Switch, 4 ft. 16 Ga. Wire	2 ea.
27024	5 Way Pole Flat Connector - Heavy Duty	2 ea.
11978	LED Magnetic Towing Light Kit	2 ea.
11980	LED Submersible Towing Light Kit	2 ea.

Plan-O-Grams do not include gondola or shelves. Products may not be exactly as illustrated.



Merchandisers

Tow Pro Trailer & Towing Merchandisers

Trailer & Towing Plan-O-Gram 72"

PART#	CONTENTS
00057	Trailer & Towing Backdrop Only , 48" x 72"
00057K	Full Trailer & Towing Plan-O-Gram . Includes 00057, 21 pegs (80004), and contents listed below:

PART#	DESCRIPTION	QUANTITY
00210	Ball Mount Display Rack	1 ea.
00637	Jack Rack for Gondola	1 ea.
11147P	Trailer Ball, 1-7/8" x 1", External Thread, Pkgd.	1 ea.
11148P	Trailer Ball, 1-7/8" x 3/4", Internal Thread, Pkgd.	1 ea.
11149P	Trailer Ball, 2" x 3/4", Internal Thread, Pkgd.	1 ea.
11151P	Trailer Ball, 1-7/8" x 3/4", External Thread, Pkgd.	1 ea.
11152P	Trailer Ball, 2" x 3/4", External Thread, Pkgd.	1 ea.
11153P	Trailer Ball, 2" x 1", External Thread, Pkgd.	1 ea.
11156	Trailer Coupler, 1-7/8" x 2"	1 ea.
11157	Trailer Coupler, 1-7/8" x 2-1/2"	1 ea.
11158	Trailer Coupler, 1-7/8" x 3"	1 ea.
11159	Trailer Coupler, 2" x 2-1/2"	1 ea.
11159N	Trailer Coupler, 2" x 2"	1 ea.
11160	Trailer Coupler, 2" x 3"	1 ea.
11170	Trailer Ball Reducer, Bushing 1" to 3/4"	2 ea.
11171	Trailer Ball Reducer, Bushing 1-1/4" to 1"	2 ea.
11305	Hand Winch, 2000 lb	1 ea.
11310	Hand Winch Auto Brake, 2500 lb	1 ea.
11468	Imp. Jack, Top Wind, Tube Mnt, 5000 lb, 10" Lift	1 ea.
11469	Imp. Jack, Top Wind Tube Mnt, 5000 lb, 15" Lift	1 ea.
11471	Imp. Jack, Top Wind, Swivel Mnt, 2000 lb, 15" Lift	1 ea.
11472	Imp. Jack, Side Wind, Tube Mnt, 5000 lb, 15" Lift	1 ea.
11473	Imp. Jack, Side Wind, Tube Mnt, 5000 lb, 10" Lift	1 ea.
11545	Square Tube Jack, Side Wind, 5000 lb, 15" Lift	1 ea.
11579	Ball Mount - Clevis	1 ea.
11591	Ball Mount Kit, 2"	1 ea.
11592	Ball Mount Kit, 2-5/16"	1 ea.
11600	Straight Bar Ball Mount	1 ea.
11601	Ball Mount, 2" Drop	1 ea.



PART#	DESCRIPTION	QUANTITY
11602	Ball Mount, 4" Drop	1 ea.
11607	Triple Ball Mount	1 ea.
11615	Pintle Hook, 8 Ton	1 ea.
11616	Pintle Hook, 2" Ball	1 ea.
11617	Pintle Hook, 2-5/16" Ball	1 ea.
11618	Pintle Hook, 5 Ton	1 ea.
11619	Pintle Hook, 15 Ton	1 ea.
11620	Pintle Hook, 10 Ton	1 ea.
11670	Ball Mount, 1-1/4" Shank	1 ea.
11671	Ball Mount, 1-1/4" Shank	1 ea.
11686	Ball Mount, Forged	1 ea.
11690	Ball Mount, 1-1/4", Super Duty	1 ea.
11693	Shackle Ball Mount, 9-3/8"	1 ea.
11786	Hitch Adapter, 2" to 1-1/4"	1 ea.
11787	Hitch Adapter, 1-1/4" to 2"	1 ea.
11788	Hitch Adapter, 2" to 1-1/4"	1 ea.
66270	Pull Pin, 1/2"	2 ea.
66271	Pull Pin, 5/8", 3" Usable Length	2 ea.
66271P	Pull Pin, 5/8", 3" Usable Length - Pkgd.	2 ea.
66274	Hitch Lock Pin, 1/2" x 2-1/2"	2 ea.
66275	Hitch Lock Pin, 5/8" x 3"	2 ea.
66276	Coupler Lock	2 ea.
66277	Coupler & Receiver Lock Set	2 ea.

Plan-O-Grams do not include gondola or shelves. Products may not be exactly as illustrated.



Merchandisers



Trailer & Towing Plan-O-Gram 48"

PART#	CONTENTS
-------	----------

01041 Trailer & Towing **Backdrop Only**, 48" x 48"

01041K **Full Trailer & Towing Plan-O-Gram**. Includes 01041, 21 pegs (80004), and contents listed below:

PART#	DESCRIPTION	QTY.
00210	Ball Mount Display Rack	1 ea.
11147P	Trailer Ball, 1-7/8" x 1", External Thread, Pkgd.	2 ea.
11148P	Trailer Ball, 1-7/8" x 3/4", Internal Thread, Pkgd.	2 ea.
11149P	Trailer Ball, 2" x 3/4", Internal Thread, Pkgd.	2 ea.
11151P	Trailer Ball, 1-7/8" x 3/4", External Thread, Pkgd.	2 ea.
11152P	Trailer Ball, 2" x 3/4", External Thread, Pkgd.	2 ea.
11153P	Trailer Ball, 2" x 1", External Thread, Pkgd.	2 ea.
11156	Trailer Coupler, 1-7/8" x 2"	2 ea.
11157	Trailer Coupler, 1-7/8" x 2-1/2"	2 ea.
11158	Trailer Coupler, 1-7/8" x 3"	2 ea.
11159	Trailer Coupler, 2" x 2-1/2"	2 ea.
11159N	Trailer Coupler, 2" x 2"	2 ea.
11160	Trailer Coupler, 2" x 3"	2 ea.
11170	Trailer Ball Reducer, Bushing 1" to 3/4"	2 ea.
11171	Trailer Ball Reducer, Bushing 1-1/4" to 1"	2 ea.
11305	Hand Winch, 2000 lb	1 ea.
11310	Hand Winch Auto Brake, 2500 lb	1 ea.
11579	Ball Mount - Clevis	1 ea.
11591	Ball Mount Kit, 2"	1 ea.
11592	Ball Mount Kit, 2-5/16"	1 ea.
11600	Straight Bar Ball Mount	1 ea.
11601	Ball Mount, 2" Drop	1 ea.
11602	Ball Mount, 4" Drop	1 ea.
11607	Triple Ball Mount	1 ea.
11615	Pintle Hook, 8 Ton	1 ea.
11616	Pintle Hook, 2" Ball	1 ea.
11617	Pintle Hook, 2-5/16" Ball	1 ea.
11618	Pintle Hook, 5 Ton	1 ea.
11619	Pintle Hook, 15 Ton	1 ea.
11620	Pintle Hook, 10 Ton	1 ea.
11670	Ball Mount, 1-1/4" Shank	1 ea.
11671	Ball Mount, 1-1/4" Shank	1 ea.
11686	Ball Mount, Forged	1 ea.
11690	Ball Mount, 1-1/4", Super Duty	1 ea.
11693	Shackle Ball Mount, 9-3/8"	1 ea.



PART#	DESCRIPTION	QTY.
11786	Hitch Adapter, 2" to 1-1/4"	1 ea.
11787	Hitch Adapter, 1-1/4" to 2"	1 ea.
11788	Hitch Adapter, 2" to 1-1/4"	1 ea.
66270	Pull Pin, 1/2"	2 ea.
66271	Pull Pin ,5/8, 3" Usable Length	2 ea.
66271P	Pull Pin, 5/8", 3" Usable Length - Pkgd.	2 ea.
66274	Hitch Lock Pin, 1/2" x 2-1/2"	2 ea.
66275	Hitch Lock Pin, 5/8" x 3"	2 ea.
66276	Coupler Lock	2 ea.
66277	Coupler & Receiver Lock Set	2 ea.

Plan-O-Grams do not include gondola or shelves. Products may not be exactly as illustrated.



Merchandisers

Tow Pro Trailer & Towing Merchandisers

Ball Mount Rack

PART#	CONTENTS
-------	----------

00210 Ball Mount **Rack Only**, 48" x 15" x 10"

00210K **Full Ball Mount Rack Merchandiser.** Includes the display and an assortment of our most popular ball mounts and receivers.

PART#	DESCRIPTION	QUANTITY	PART#	DESCRIPTION	QUANTITY
11579	Clevis Ball Mount 5000lb	1 ea.	11671	Ball Mount, 1-1/4" Shank	1 ea.
11591	Ball Mount Kit 2	1 ea.	11686	Ball Mount, Forged, 2" Drop	1 ea.
11592	Ball Mount Kit 2-5/16	1 ea.	11690	Ball Mount 1-1/4" Super Duty, 3" Drop	1 ea.
11600	Straight Bar Ball Mount	1 ea.	11693	Shackle Ball Mount	1 ea.
11601	Ball Mount 2" Drop	1 ea.	11786	Hitch Adapter - 2 to 1-1/4	1 ea.
11602	Ball Mount 4" Drop	1 ea.	11787	Hitch Adapter - 2 to 1-1/4	1 ea.
11607	Triple Ball Mount	1 ea.	11788	Hitch Adapter 1-1/4 to 2	1 ea.
11670	Ball Mount, 1-1/4" Shank	1 ea.			



Any load. Any where. Any time.

For more information on ball mounts and accessories, See the Tow Pro Trailer and Towing Section in this catalogue.



Plan-O-Grams do not include gondola or shelves. Products may not be exactly as illustrated.



Jack Rack

Jack Rack Merchandiser can be placed on floor or bottom of a gondola shelf.
Fits regular 4 ft. Gondola Shelf, 18" deep.

PART#	CONTENTS	
00637	Jack Stand Bracket Only , 1 piece display (bolts not included)	
00637K	Full Jack Rack Merchandiser. Includes 00637 Jack Rack for Gondola shelf, labels and products below:	
PART#	DESCRIPTION	QTY.
11468	Implement Jack, Tube Mount, Top Wind, 5000 lb, 10" Lift	2 ea.
11469	Implement Jack, Tube Mount, Top Wind, 5000 lb, 15" Lift	2 ea.
11471	Swivel Bracket Mount, 2000 lb, 15" Lift	2 ea.
11472	Implement Jack, Tube Mount, Side Wind, 5000 lb, 15" Lift	2 ea.
11473	Implement Jack, Tube Mount, Side Wind, 5000 lb, 10" Lift	2 ea.
11545	Tube Mount, Side Wind, Square Tube, 5000 lb, 15" Lift	2 ea.



TOW-PRO™

Any load. Any where. Any time.

For more information on jacks, See the Tow Pro Trailer and Towing Section in this catalogue.

TOW PRO™



Plan-O-Grams do not include gondola or shelves. Products may not be exactly as illustrated.



Merchandisers

Lubrication Merchandisers

S.A.E. O-Rings Merchandiser

PART#	CONTENTS
-------	----------

00318 O-Rings **Display Board Only**, 24" x 24"

00318K **Full O-Rings Merchandiser**. Includes 00318 display board, 110 cornice hooks (65043) and product listed below:

PART#	REF#	QUANTITY	PART#	REF#	QUANTITY
54006	006	1 pkg. of 15	54126	126	1 pkg. of 10
54007	007	1 pkg. of 15	54127	127	1 pkg. of 10
54008	008	1 pkg. of 15	54128	128	1 pkg. of 10
54009	009	1 pkg. of 15	54129	129	1 pkg. of 10
54010	010	1 pkg. of 15	54130	130	1 pkg. of 10
54011	011	1 pkg. of 15	54131	131	1 pkg. of 10
54012	012	1 pkg. of 15	54132	132	1 pkg. of 10
54013	013	1 pkg. of 10	54133	133	1 pkg. of 10
54014	014	1 pkg. of 10	54134	134	1 pkg. of 10
54015	015	1 pkg. of 10	54135	135	1 pkg. of 10
54016	016	1 pkg. of 10	54136	136	1 pkg. of 10
54017	017	1 pkg. of 10	54137	138	1 pkg. of 10
54018	018	1 pkg. of 10	54138	138	1 pkg. of 10
54019	019	1 pkg. of 10	54139	139	1 pkg. of 10
54020	020	1 pkg. of 10	54140	140	1 pkg. of 10
54021	021	1 pkg. of 10	54141	141	1 pkg. of 10
54022	022	1 pkg. of 10	54142	142	1 pkg. of 10
54023	023	1 pkg. of 10	54143	143	1 pkg. of 10
54024	024	1 pkg. of 10	54144	144	1 pkg. of 10
54025	025	1 pkg. of 10	54145	145	1 pkg. of 10
54026	026	1 pkg. of 10	54146	146	1 pkg. of 10
54027	027	1 pkg. of 10	54147	147	1 pkg. of 10
54028	028	1 pkg. of 10	54148	148	1 pkg. of 10
54110	110	1 pkg. of 15	54149	149	1 pkg. of 10
54111	111	1 pkg. of 15	54210	210	1 pkg. of 10
54112	112	1 pkg. of 15	54211	211	1 pkg. of 10
54113	113	1 pkg. of 15	54212	212	1 pkg. of 10
54114	114	1 pkg. of 15	54213	213	1 pkg. of 10
54115	115	1 pkg. of 15	54214	214	1 pkg. of 10
54116	116	1 pkg. of 15	54215	215	1 pkg. of 10
54117	117	1 pkg. of 10	54216	216	1 pkg. of 10
54118	118	1 pkg. of 10	54217	217	1 pkg. of 10
54119	119	1 pkg. of 10	54218	218	1 pkg. of 10
54120	120	1 pkg. of 10	54219	219	1 pkg. of 10
54121	121	1 pkg. of 10	54220	220	1 pkg. of 10
54122	122	1 pkg. of 10	54221	221	1 pkg. of 10
54123	123	1 pkg. of 10	54222	222	1 pkg. of 10
54124	124	1 pkg. of 10	54223	223	1 pkg. of 10
54125	125	1 pkg. of 10	54224	224	1 pkg. of 10



Reference Chart Available
See end of catalogue



PART#	REF#	QUANTITY
54225	225	1 pkg. of 10
54226	226	1 pkg. of 10
54227	227	1 pkg. of 10
54228	228	1 pkg. of 10
54229	229	1 pkg. of 10
54230	230	1 pkg. of 10
54231	231	1 pkg. of 10
54232	232	1 pkg. of 10
54233	233	1 pkg. of 10
54234	234	1 pkg. of 10
54235	235	1 pkg. of 10
54236	236	1 pkg. of 10
54325	325	1 pkg. of 5
54326	326	1 pkg. of 5
54327	327	1 pkg. of 5
54328	328	1 pkg. of 5
54329	329	1 pkg. of 5
54330	330	1 pkg. of 5
54331	331	1 pkg. of 5
54332	332	1 pkg. of 5
54333	333	1 pkg. of 5
54334	334	1 pkg. of 5
54335	335	1 pkg. of 5
54336	336	1 pkg. of 5

Plan-O-Grams do not include gondola or shelves. Products may not be exactly as illustrated.

Merchandisers





Grease Accessories Merchandiser

PART#	CONTENTS
-------	----------

00527 Grease Accessories
Display Board Only, 24" x 24"

00527K Full Grease Accessories Merchandiser.
Includes 00057 display board, 41 pegs (80004)
and product listed below:

PART#	DESCRIPTION	QUANTITY
-------	-------------	----------

00163	S.A.E. Grease Fittings Dynakit	3 ea.
00181	Metric Grease Fittings Dynakit	2 ea.
00182	Drive-In Grease Fittings Dynakit	2 ea.
11077	Grease Gun Holder Bracket	2 ea.
11122	Grease Injectors Dynapak, (3 pcs.), 10 Ga.	6 pkgs. of 3
11140	Grease Hose, Plastic, 12", packaged	2 ea.
11141	Grease Hose, Plastic, 18", packaged	4 ea.
11071A	360 Degree Swivel Coupler, 1/8" NPT	2 ea.
11075A	Needle Nose Dispenser, 1-1/2"	4 ea.
11081A	90° Angle Grease Coupler	2 ea.
11100A	S.A.E. Grease Fittings Dynapak, 10 x 11100	6 pkgs. of 10
11102A	S.A.E. Grease Fittings Dynapak, 5 x 11102	2 pkgs. of 5
11104A	S.A.E. Grease Fittings Dynapak, 5 x 11104	4 pkgs. of 5
11105A	S.A.E. Grease Fittings Dynapak, 10 x 11105	4 pkgs. of 10
11106A	S.A.E. Grease Fittings Dynapak, 10 x 11106	2 pkgs. of 10
11107A	S.A.E. Grease Fittings Dynapak, 5 x 11107	2 pkgs. of 5
11109A	S.A.E. Grease Fittings Dynapak, 5 x 11109	2 pkgs. of 5
11110A	S.A.E. Grease Fittings Dynapak, 5 x 11110	2 pkgs. of 5
11112A	S.A.E. Grease Fittings Dynapak, 5 x 11112	2 pkgs. of 5
11113A	S.A.E. Grease Fittings Dynapak, 5 x 11113	2 pkgs. of 5
11114A	Metric Grease Fittings Dynapak, 5 x 11114	2 pkgs. of 5
11115A	Metric Grease Fittings Dynapak, 5 x 11115	2 pkgs. of 5
11116A	Metric Grease Fittings Dynapak, 5 x 11116	2 pkgs. of 5
11117A	Metric Grease Fittings Dynapak, 5 x 11117	2 pkgs. of 5
11118A	Metric Grease Fittings Dynapak, 5 x 11118	2 pkgs. of 5
11119A	Metric Grease Fittings Dynapak, 5 x 11119	2 pkgs. of 5



PART#	DESCRIPTION	QUANTITY
11120A	Metric Grease Fittings Dynapak, 5 x 11120	2 pkgs. of 5
11121A	Grease Coupler Dynapak, 1/8" NPT	6 ea.
11123A	Grease Injector, 18 Ga.	2 ea.
11124A	Grease Injectors (2 sizes: 18 Ga. & 21 Ga.)	2 pkgs. of 2
11125A	Grease Couplers, 1/8" NPT, Heavy Duty	2 ea.
11126A	Metric Grease Fittings Dynapak, 5 x 11126	2 pkgs. of 5
11127A	Metric Grease Fittings Dynapak, 5 x 11127	2 pkgs. of 5
11131A	Drive-In Grease Fittings Dynapak, 5 x 11131	2 pkgs. of 5
11132A	Drive-In Grease Fittings Dynapak, 5 x 11132	2 pkgs. of 5
11133A	Drive-In Grease Fittings Dynapak, 5 x 11133	2 pkgs. of 5
11134A	Drive-In Grease Fittings Dynapak, 5 x 11134	2 pkgs. of 5
11135A	Drive-In Grease Fittings Dynapak, 5 x 11135	2 pkgs. of 10
11136A	Drive-In Grease Fittings Dynapak, 5 x 11136	2 pkgs. of 10
11142A	Grease Hose, Rubber, 12"	2 ea.
11143A	Grease Hose, Rubber, 18"	4 ea.

Plan-O-Grams do not include gondola or shelves. Products may not be exactly as illustrated.



Merchandisers

Lubrication Merchandisers

Lubrication Plan-O-Gram

PART#	CONTENTS
01031	Lubrication Backdrop Only , 48" x 48"
01031K	Full Lubrication Plan-O-Gram . Includes 01031, 64 pegs (80004), and contents listed below:

PART#	DESCRIPTION	QUANTITY
00163	S.A.E. Grease Fitting Dynakit, 40 Pcs.	2 ea.
00181	Metric Grease Fittings Dynakit, 50 Pcs.	2 ea.
00182	Drive-In Grease Fittings Dynakit, 50 Pcs.	2 ea.
11066	Professional Pistol Grease Gun	2 ea.
11073	Multi-Purpose Lithium Grease, 3 X 85G	1 Pkg. of 3
11076	Needle Nose Adapter, 4"	2 ea.
11077	Grease Gun Holder Bracket	2 ea.
11091	Lever Action Pail Pump	1 ea.
11122	Grease Injector, 18Ga	1 Pkg. of 3
11140	Grease Hose 12"	2 ea.
11141	Grease Hose 18"	2 ea.
13002	2 Tube Grease Holder	4 ea.
11071A	360° Swivel Coupler 1/8" NPT	2 ea.
11075A	Needle Nose Dispenser, 1-1/2"	2 ea.
11080A	Needle Nose Adapter, Fine	2 ea.
11081A	90° Angle Grease Coupler	2 ea.
11082C	Premium Lever Grease Gun, H.D.	2 ea.
11084A	Pistol Grease Gun, C/W Hose, H.D.	2 ea.
11085A	Lever Grease Gun, H.D.	2 ea.
11087A	Heavy Duty Pistol Grease Gun	2 ea.
11090A	Suction Gun	2 ea.
11092A	Lever Action Barrel Pump	2 ea.
11100A	Dynapak Grease Fitting, 1/8" Straight	1 Pkg. of 10
11102A	Dynapak Grease Fitting, 1/8" 45°	1 Pkg. of 5
11104A	Dynapak Grease Fitting, 1/8" 90°	1 Pkg. of 5
11105A	Dynapak Grease Fitting, 1/4" Straight	1 Pkg. of 5
11106A	Dynapak Grease Fitting, 1/4" Long	1 Pkg. of 10
11107A	Dynapak Grease Fitting, 1/4" 45°	1 Pkg. of 5
11109A	Dynapak Grease Fitting, 1/4" 90°	1 Pkg. of 5
11110A	Dynapak Grease Fitting, 1/4" Straight	1 Pkg. of 5
11112A	Dynapak Grease Fitting, 5/16" Straight	1 Pkg. of 5
11113A	Dynapak Grease Fitting, 3/8" Straight	1 Pkg. of 5
11114A	Dynapak Grease Fitting, M6 X 1 Straight	1 Pkg. of 5
11115A	Dynapak Grease Fitting, M6 X 1 45°	1 Pkg. of 5
11116A	Dynapak Grease Fitting, M6 X 1 90°	1 Pkg. of 5



PART#	DESCRIPTION	QUANTITY
11117A	Dynapak Grease Fitting, M8 X 1 Straight	1 Pkg. of 5
11118A	Dynapak Grease Fitting, M8 X 1 45°	1 Pkg. of 5
11119A	Dynapak Grease Fitting, M8 X 1 90°	1 Pkg. of 5
11120A	Dynapak Grease Fitting, M10 X 1 Str.	1 Pkg. of 5
11121A	Dynapak Grease Coupler, 6000 Psi	2 ea.
11123A	Grease Injector, 18Ga	2 ea.
11124A	Grease Injector, (1) 18Ga, (1) 21Ga	1 Pkg. of 2
11125A	Heavy Duty Grease Coupler	2 ea.
11126A	Dynapak Grease Fitting, M10 X 1, 45°	1 Pkg. of 5
11127A	Dynapak Grease Fitting, M10 X 1, 90°	1 Pkg. of 5
11131A	Dynapak Grease Fitting, 3/16" Drive-In	1 Pkg. of 5
11132A	Dynapak Grease Fitting, 1/4" Drive-In	1 Pkg. of 5
11133A	Dynapak Grease Fitting, 5/16" Drive-In	1 Pkg. of 5
11134A	Dynapak Grease Fitting, 3/8" Drive-In	1 Pkg. of 5
11135A	S.A.E. Grease Fittings, Dynapak	1 Pkg. of 10
11136A	Metric Grease Fittings, Dynapak	1 Pkg. of 10
11142A	Grease Hose 12"	2 ea.
11143A	Grease Hose 18"	2 ea.

Plan-O-Grams do not include gondola or shelves. Products may not be exactly as illustrated.



Merchandisers



Funnels & Lubrication Merchandiser

PART#	CONTENTS
01032	Funnels and Lubrication Backdrop Only , 48" x 48"
01032K	Full Funnels and Lubrication Plan-o-gram. Includes 01032 and 59 pegs (80004) and the products listed below:

PART#	DESCRIPTION	QTY.
00163	S.A.E. Grease Fittings Dynakit	2 ea.
00181	Metric Grease Fittings Dynakit	2 ea.
00182	Drive-In Grease Fittings Dynakit	2 ea.
11077	Grease Gun Holder Bracket	2 ea.
11141	Grease Hose 18", packaged	2 ea.
13002	Grease-2-Go! 2-tubes holder	2 ea.
13003	Funnel With Filter, 3" diameter	2 ea.
13005	Funnel With Filter, 5" diameter	2 ea.
13008	Funnel With Filter Auto, 8" diameter	2 ea.
13009	Funnel With Filter, 9" diameter	2 ea.
14014	Metal Transmission Funnel, 6-1/2" diameter	2 ea.
14045	Measuring Container - 4.5 L	2 ea.
11080A	Needle Tip Dispenser	2 ea.
11081A	90 Degree Grease Coupler	2 ea.
11082C	Grease Gun - Lever - H.D.	2 ea.
11084A	Grease Gun Pistol, C/W Hose	2 ea.
11085A	Grease Gun - Lever	2 ea.
11087A	Grease Gun - Pistol	2 ea.
11090A	Fluid Suction Gun	2 ea.
11091	Oil Pump	1 ea.
11092A	Lever Action Barrel Pump	2 ea.
11100A	Dynapak - 10 x 11100	2 pkgs. of 10
11102A	Dynapak - 5 x 11102	2 pkgs. of 5
11104A	Dynapak - 5 x 11104	2 pkgs. of 5
11105A	Dynapak - 10 x 11105	2 pkgs. of 5
11106A	Dynapak - 10 x 11106	2 pkgs. of 10
11107A	Dynapak - 5 x 11107	2 pkgs. of 5
11109A	Dynapak - 5 x 11109	2 pkgs. of 5
11110A	Dynapak - 5 x 11110	2 pkgs. of 5
11113A	Dynapak - 5 x 11113	2 pkgs. of 5
11120A	Dynapak - 5 x 11120 (Metric)	2 pkgs. of 5
11121A	Grease Coupler Dynapak	2 ea.
11123A	Grease Injector 18GA	2 ea.



PART#	DESCRIPTION	QTY.
11125A	Dynapak - 1 x 11125	2 ea.
11131A	Dynapak - 5 x 11131	2 pkgs. of 5
11133A	Dynapak - 5 x 11133	2 pkgs. of 5
11134A	Dynapak - 5 x 11134	2 pkgs. of 5
11135A	S.A.E. Grease Fitting Assortment	2 pkgs. of 10
11142A	Grease Hose, 12", Packaged	1 ea.
11143A	Grease Hose, 18", Packaged	1 ea.
C35050	5" Funnel without Filter	2 ea.

Plan-O-Grams do not include gondola or shelves. Products may not be exactly as illustrated.

Merchandisers

Lubrication Merchandisers



Merchandisers



Plastic Funnels & Measures Merchandiser

PART#	CONTENTS
00626	Plastic Funnels & Measurer's Backdrop Only , 48" x 48".
00626K	Full Plastic Funnels & Measures Plan-o-gram. Includes 00626 and the products listed below:

PART#	DESCRIPTION	QTY.
13003	Funnel with Filter, 3"	10 ea.
13005	Funnel with Filter, 5"	12 ea.
13008	Automotive with Filter	8 ea.
13009	Funnel with Filter, 9"	4 ea.
13015	Anti-Splash Funnel, 5"	10 ea.
13019	Anti-Splash Funnel, 9"	5 ea.
13504	Multi-Purpose Funnel, 4"	10 ea.
13505	Multi-Purpose Funnel, 5"	10 ea.
13506	Multi-Purpose Funnel, 6"	10 ea.
13508	Multi-Purpose Funnel, 8"	10 ea.
14015	2-in-1 Flexible Spout	3 ea.
14017	Transmission Funnel (plastic), 16" spout	2 ea.
14022	Drain Pan, 16 L	2 ea.
14023	Drain Pan, 24 L	2 ea.
14025	Measurer, 2.5 L	2 ea.
14045	Measurer, 4.5 L	2 ea.



For more information on these product see the Lubrication Section of the catalogue.



Plan-O-Grams do not include gondola or shelves. Products may not be exactly as illustrated.



Lubrication Plan-O-Gram

PART#	CONTENTS
00063	Lubrication Backdrop Only , 48" x 72".

00063K Full Lubrication Plan-o-gram. Includes 00063, 66 pegs (80004), and products listed below:

PART#	DESCRIPTION	QTY.
00163	S.A.E. Grease Fitting Dynakit, 40 Pcs.	1 ea.
00181	Metric Grease Fittings Dynakit, 50 Pcs.	1 ea.
00182	Drive-in Grease Fittings Dynakit, 50 Pcs.	1 ea.
11060	Rechargeable Grease Gun Kit, 12V	1 ea.
11066	Professional Pistol Grease Gun	1 ea.
11073	Multi-Purpose Lithium Grease, 3 X 85G	pkg. of 3
11076	Needle Nose Adapter, 4"	1 ea.
11077	Grease Gun Holder Bracket	1 ea.
11078	Replacement Grease Gun Pipe, 5 1/2"	1 ea.
11091	Lever Action Pail Pump	1 ea.
11093	Fluid Transfer Pump	1 ea.
11122	Grease Injector, 18 Ga.	pkg. of 3
11140	Grease Hose, 12"	1 ea.
11141	Grease Hose, 18"	1 ea.
13000	Tube Tote - Grease	1 ea.
13002	2 Tube Grease Holder	1 ea.
14022	Drain Pan - 16 Litres	1 ea.
14023	Drain Pan - 24 Litres	1 ea.
11071A	360° Swivel Coupler, 1/8" NPT	1 ea.
11075A	Needle Nose Dispenser, 1 1/2"	1 ea.
11080A	Needle Nose Adapter, Fine	1 ea.
11081A	90° Angle Grease Coupler	1 ea.
11082C	Professional Lever Grease Gun	1 ea.
11084A	Pistol Grease Gun, C/W hose, heavy duty	1 ea.
11087A	Heavy Duty Pistol Grease Gun	1 ea.
11089A	Mini Pistol Grease Gun	1 ea.
11090A	Suction Gun	1 ea.
11094A	Rotary Barrel Pump	1 ea.
11100A	Dynapak Grease Fitting, 1/8", Straight	pkg. of 10
11102A	Dynapak Grease Fitting, 1/8", 45°	pkg. of 5
11104A	Dynapak Grease Fitting, 1/8", 90°	pkg. of 5
11105A	Dynapak Grease Fitting, 1/4", Straight	pkg. of 5
11106A	Dynapak Grease Fitting, 1/4", Long	pkg. of 10
11107A	Dynapak Grease Fitting, 1/4", 45°	pkg. of 5
11109A	Dynapak Grease Fitting, 1/4", 90°	pkg. of 5



PART#	DESCRIPTION	QTY.
11110A	Dynapak Grease Fitting, 1/4", Straight	pkg. of 5
11112A	Dynapak Grease Fitting, 5/16", Straight	pkg. of 5
11113A	Dynapak Grease Fitting, 3/8" Straight	pkg. of 5
11114A	Dynapak Grease Fitting, M6 X 1 Straight	pkg. of 5
11115A	Dynapak Grease Fitting, M6 X 1 45°	pkg. of 5
11116A	Dynapak Grease Fitting, M6 X 1 90°	pkg. of 5
11117A	Dynapak Grease Fitting, M8 X 1 Straight	pkg. of 5
11118A	Dynapak Grease Fitting, M8 X 1 45°	pkg. of 5
11119A	Dynapak Grease Fitting, M8 X 1 90°	pkg. of 5
11120A	Dynapak Grease Fitting, M10 X 1 Straight	pkg. of 5
11121A	Dynapak Grease Coupler, 6000 PSI	1 ea.
11123A	Grease Injector, 18 Ga	1 ea.
11124A	Grease Injector (1)18 Ga, (1) 21 Ga	pkg. of 2
11125A	Heavy Duty Grease Coupler (1 Per Pkg.)	1 pkg.
11126A	Dynapak Grease Fitting, M10 X 1 45°	pkg. of 5
11127A	Dynapak Grease Fitting, M10 X 1 90°	pkg. of 5
11131A	Dynapak Grease Fitting, 3/16", Drive In	pkg. of 5
11132A	Dynapak Grease Fitting, 1/4", Drive-in	pkg. of 5
11133A	Dynapak Grease Fitting, 5/16", Drive-in	pkg. of 5
11134A	Dynapak Grease Fitting, 3/8", Drive-in	pkg. of 5
11135A	S.A.E. Grease Fittings Dynapak	pkg. of 10
11136A	Metric Grease Fittings Dynapak	pkg. of 10
11142A	Grease Hose 12"	1 ea.
11143A	Grease Hose 18"	1 ea.

Plan-O-Grams do not include gondola or shelves. Products may not be exactly as illustrated.



Merchandisers

Lubrication Merchandisers

O-Ring Tilt Bins Merchandiser

PART#	CONTENTS
-------	----------

00716K Full O-Rings Tilt Bin Merchandiser.
Dimensions: 23-5/8" x 3-5/8" x 36"
Includes Tilt Bins, assembly hardware and the products listed below:

PART#	DESCRIPTION	QTY.
54117	O-Ring 117	1 pkg. of 10
54118	O-Ring 118	1 pkg. of 10
54119	O-Ring 119	1 pkg. of 10
54120	O-Ring 120	1 pkg. of 10
54121	O-Ring 121	1 pkg. of 10
54122	O-Ring 122	1 pkg. of 10
54123	O-Ring 123	1 pkg. of 10
54124	O-Ring 124	1 pkg. of 10
54125	O-Ring 125	1 pkg. of 10
54128	O-Ring 128	1 pkg. of 10
54210	O-Ring 210	1 pkg. of 10
54211	O-Ring 211	1 pkg. of 10
54212	O-Ring 212	1 pkg. of 10
54213	O-Ring 213	1 pkg. of 10
54214	O-Ring 214	1 pkg. of 10
54215	O-Ring 215	1 pkg. of 10
54216	O-Ring 216	1 pkg. of 10
54217	O-Ring 217	1 pkg. of 10
54218	O-Ring 218	1 pkg. of 10
54219	O-Ring 219	1 pkg. of 10
54220	O-Ring 220	1 pkg. of 10
54221	O-Ring 221	1 pkg. of 10
54222	O-Ring 222	1 pkg. of 10
54223	O-Ring 223	1 pkg. of 10
54224	O-Ring 224	1 pkg. of 10
54225	O-Ring 225	1 pkg. of 10
54226	O-Ring 226	1 pkg. of 10
54227	O-Ring 227	1 pkg. of 10
54228	O-Ring 228	1 pkg. of 10
54229	O-Ring 229	1 pkg. of 10
54230	O-Ring 230	1 pkg. of 10
54231	O-Ring 231	1 pkg. of 10
54232	O-Ring 232	1 pkg. of 10
54235	O-Ring 235	1 pkg. of 10
54236	O-Ring 236	1 pkg. of 10
54325	O-Ring 325	1 pkg. of 5
54326	O-Ring 326	1 pkg. of 5
54327	O-Ring 327	1 pkg. of 5
TF306	Tilt Bin 6 comp.	6 ea.
TF308	Tilt Bin 8 comp.	4 ea.



Reference Chart Available

See end of catalogue

PART#	DESCRIPTION	QTY.
54006	O-Ring 006	1 pkg. of 15
54007	O-Ring 007	1 pkg. of 15
54008	O-Ring 008	1 pkg. of 15
54009	O-Ring 009	1 pkg. of 15
54010	O-Ring 010	1 pkg. of 15
54011	O-Ring 011	1 pkg. of 15
54012	O-Ring 012	1 pkg. of 15
54013	O-Ring 013	1 pkg. of 10
54014	O-Ring 014	1 pkg. of 10
54015	O-Ring 015	1 pkg. of 10
54016	O-Ring 016	1 pkg. of 10
54017	O-Ring 017	1 pkg. of 10
54018	O-Ring 018	1 pkg. of 10
54019	O-Ring 019	1 pkg. of 10
54020	O-Ring 020	1 pkg. of 10
54021	O-Ring 021	1 pkg. of 10
54022	O-Ring 022	1 pkg. of 10
54023	O-Ring 023	1 pkg. of 10
54024	O-Ring 024	1 pkg. of 10
54025	O-Ring 025	1 pkg. of 10
54026	O-Ring 026	1 pkg. of 10
54027	O-Ring 027	1 pkg. of 10
54028	O-Ring 028	1 pkg. of 10
54110	O-Ring 110	1 pkg. of 15
54111	O-Ring 111	1 pkg. of 15
54112	O-Ring 112	1 pkg. of 15
54113	O-Ring 113	1 pkg. of 15
54114	O-Ring 114	1 pkg. of 15
54115	O-Ring 115	1 pkg. of 15
54116	O-Ring 116	1 pkg. of 15

Plan-O-Grams do not include gondola or shelves. Products may not be exactly as illustrated.



Merchandisers



Dynakit Assortments Merchandiser

PART#	CONTENTS
-------	----------

00296 Dynakits **Display Board Only**, 12" x 24"

00296K Full Dynakits Merchandiser. Includes 00296 display board, 16 pegs (80004) and products listed below:

PART#	DESCRIPTION	QUANTITY
00140	Std. Plug-In Fuses	2 ea.
00141	Mini Plug-In Fuses	3 ea.
00160	Cotter Pins	4 ea.
00161	Cotter Pins (large)	3 ea.
00163	S.A.E. Grease Fittings	4 ea.
00164	Hair Pins Dynakit	4 ea.
00173	Spring Pins	4 ea.
00174	Woodruff Keys	2 ea.
00175	"E" Retainer Rings	1 ea.
00176	Int. Retainer Rings	1 ea.
00177	Ext. Retainer Rings	1 ea.
00178	Clevis Pins	1 ea.
00179	S.A.E. O-Ring Dynakit	2 ea.
00180	Keystock Dynakit	3 ea.
00181	Metric Grease Fittings	3 ea.
00182	Drive-In Grease Fittings	2 ea.



Dynatray Assortments Merchandiser

PART#	CONTENTS
-------	----------

00031 Dynatrays **Display Board Only**, two - 24" x 24"

00031K Full Dynatrays Merchandiser. Includes 00031A, 00031B display boards, 20 pegs (80004) and product listed below:

PART#	DESCRIPTION	QUANTITY	PART#	DESCRIPTION	QUANTITY
00108	Metric Grease Fitting Assortment	4 ea.	10117	Rivet Hardware Assortment	4 ea.
00112	S.A.E. Grease Fitting Assortment	4 ea.	10118	Fuses Assortment	4 ea.
10100	Springs Assortment	4 ea.			
10101	HNBR O-Rings Assortment	4 ea.			
10102	Cotter Pin Assortment	4 ea.			
10103	Large Cotter Pin Assortment	4 ea.			
10104	Ext. "E" Retainer Ring Assortment	4 ea.			
10105	Hair Pins Assortment	4 ea.			
10106	External Snap Rings Assortment	4 ea.			
10107	Wire Terminal Assortment	4 ea.			
10108	Grommets Assortment	4 ea.			
10109	Grease Fitting Assortment	4 ea.			
10110	Auto Fuse Assortment	4 ea.			
10111	Wire Connectors Assortment	4 ea.			
10112	Allen Cap Screws Assortment	4 ea.			
10113	Woodruff Keys Assortment	4 ea.			
10114	Copper Washers Assortment	4 ea.			
10115	Rubber Sealing Washers Assortment	4 ea.			

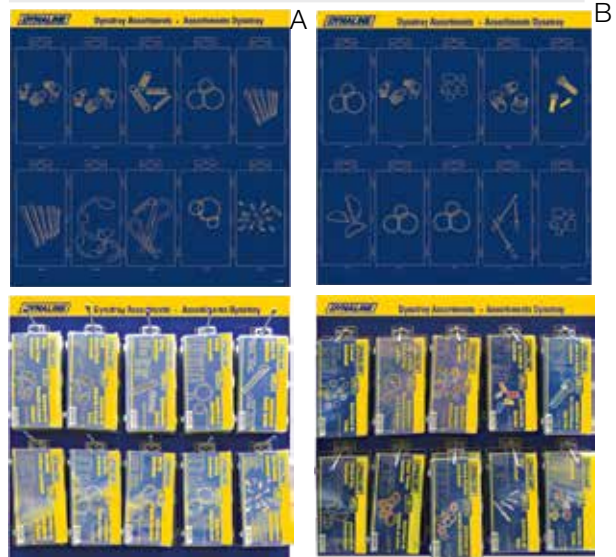

Plan-O-Grams do not include gondola or shelves. Products may not be exactly as illustrated.

Merchandisers

Assortments Merchandisers



Merchandisers

DYNALINE

Your Trusted Source.

New Assortment Selection

The new attractive display lets your customers know where they can find the products they need.

Includes :

- ATO fuses
- Snap rings
- Alligator clips
- Wiring terminals
- Half moon keys
- Spring pins
- Clips
- Pins
- Accessories
- Set screws
- Heat shrink tubes
- Shims
- Zerks
- ...and more!

Assortments save your customers time and money by having the products they need close at hand.

Ask us for more information!

COMING IN 2018



Amazing ROI per Sq/Ft!

Plan-O-Grams do not include gondola or shelves. Products may not be exactly as illustrated.

Assortments Plan-O-Gram

PART#	CONTENTS				
01021	Assortments Backdrop Only , 48" x 48"				
01021K	Full Assortments Plan-O-Gram . Includes 01021, 52 pegs (80004), and products listed below:				
PART#	DESCRIPTION	PKG.	PART#	DESCRIPTION	PKG.
00112	S.A.E. Grease Fitting Assortment	2 ea.	00189	Universal Clevis Pin Dynakit	2 ea.
00113	Hair Pin Assortment	2 ea.	10100	Spring Assortment	2 ea.
00119	Mini Plug-In Fuses	2 ea.	10101	HNBR O-Ring Assortment	2 ea.
00121	Plug-In Fuses	2 ea.	10102	Cotter Pin Assortment	2 ea.
00133	Auto Electrical Repair Kit	2 ea.	10103	Large Cotter Pin Assortment	2 ea.
00141	Mini Plug-In Fuses	2 ea.	10104	Ext. E Retainer Ring Assortment	2 ea.
00150	S.A.E. O-Ring Assortment	2 ea.	10105	Hair Pin Assortment	2 ea.
00151	Metric O-Ring Assortment	2 ea.	10106	External Snap Ring Assortment	2 ea.
00152	High pressure O-Ring Assortment	2 ea.	10107	Wire Terminal Assortment	2 ea.
00157	O-Ring Flange Kit	2 ea.	10108	Grommet Assortment	2 ea.
00160	Cotter Pin Dynakit (Small)	2 ea.	10109	Grease Fitting Assortment	2 ea.
00161	Cotter Pin Dynakit (Large)	2 ea.	10110	Auto Fuse Assortment	2 ea.
00163	S.A.E. Grease Fitting Dynakit	4 ea.	10111	Wire Connectors Assortment	2 ea.
00164	Hair Pin Dynakit	4 ea.	10112	Allen Cap Screw Assortment	2 ea.
00173	Spring Pin Dynakit	2 ea.	10113	Woodruff Key Assortment	2 ea.
00175	E Retainer Ring Dynakit	2 ea.	10114	Copper Washer Assortment	2 ea.
00177	External Retainer Ring Dynakit	2 ea.	10115	Rubber Sealing Washer Assortment	2 ea.
00178	Clevis Pin Dynakit	2 ea.	10117	Rivet Hardware Assortment	2 ea.
00180	Keystock Dynakit	2 ea.	10118	Fuse Assortment	2 ea.
00181	Metric Grease Fitting Dynakit	2 ea.	10119	Socket Set Screw Assortment	2 ea.
00182	Drive-In Grease Fitting Dynakit	2 ea.			



Plan-O-Grams do not include gondola or shelves. Products may not be exactly as illustrated.



Merchandisers

Cargo Control Merchandisers



Cargo Control Plan-O-Gram

PART#	CONTENTS
01052	Cargo Control Backdrop Only , 48" x 48"
01052K	Full Cargo Control Plan-o-gram. Includes 01052 and products listed below:

PART#	DESCRIPTION	QUANTITY
11182	Cam Strap, 1" x 6'	2 ea.
11183	Ratchet Strap, 1" x 15'	2 ea.
11183B	Ratchet Strap, 1" x 15' - Bulk	15 ea.
11185	Cam Strap, 1" x 10' - H.D.	2 ea.
11186	Ratchet Strap, 1-1/2" x 25' - H.D.	2 ea.
12230	Ratchet Strap, 1-1/2" x 15'	6 ea.
11189B	Ratchet Strap, 1" x 15' - Bulk	12 ea.
11190	Ratchet Strap, 2" x 27' - H.D.	2 ea.
11190B	Ratchet Strap, 2" x 27' - H.D. - Bulk	10 ea.
12207	Ratchet Strap, 1" x 15', Steel Hook	2 ea.
12251	Recessed Anchor, 3-1/2"	2ea.
12252	Recessed Anchor, 4-7/16" - HD	2 ea.
12320	Ratchet Strap, 1" x 15', Four Pack	2 ea.
12321	Ratchet Strap, 1" x 15', Four Pack	2 ea.
12340	Ratchet Strap, 1" x 15', J-Hooks	2 ea.
12341	Ratchet Strap, 2" x 15', J-Hooks	2 ea.
50921	Recovery Strap, 3" x 20' - 13,500 lb	2 ea.
50922	Recovery Strap, 4" x 20' - 17,500 lb	2 ea.

Load Binder/Cable Puller Rack

PART#	CONTENTS
70098	Load Binder Rack Only , 24" wide x 31.8" high x 20.6" deep
70098K	Full Cable Pullers & Load Binder Rack. Includes 24" x 24" Display Board and the products listed below:

PART#	DESCRIPTION	QTY.
11351	Cable Puller 1 Ton	2 ea.
11352	Cable Puller 2 Ton	2 ea.
11354	Cable Puller 4 Ton	2 ea.
66196	Ratchet Load Binder 1/4 - 5/16	2 ea.
66197	Ratchet Binder 5/16 - 3/8	2 ea.
66198	Ratchet Binder 3/8 - 1/2	2 ea.
66199	Ratchet Binder 1/2 - 5/8	2 ea.
66200	Load Tightener 3/16 - 1/4	2 ea.
66202	Load Binder 3/8 - 1/2	2 ea.
66203	Load Binder 1/4 - 5/16	2 ea.
66204	Load Binder 5/16 - 3/8	2 ea.
70098	Rack Display	1 ea.

Plan-O-Grams do not include gondola or shelves. Products may not be exactly as illustrated.



Merchandisers





Wire Rope Accessories Merchandisers

PART#	CONTENTS
00566	Wire Rope Accessories Display Board Only , 12" x 24"
00566K	Full Wire Rope Accessories Merchandiser. Includes 00566 display board and 30 pegs (80004) and the products listed below:

PART#	DESCRIPTION	QTY.
77030	Malleable Clip, 1/8"	1 pkg.of 10
77031	Malleable Clip, 3/16"	1 pkg.of 10
77032	Malleable Clip, 1/4"	1 pkg.of 10
77033	Malleable Clip, 5/16"	1 pkg.of 10
77034	Malleable Clip, 3/8"	2 pkg.of 5
77035	Malleable Clip, 1/2"	2 pkg.of 5
77040	Forged Clip, 1/8"	1 pkg.of 5
77041	Forged Clip, 3/16"	1 pkg.of 5
77042	Forged Clip, 1/4"	1 pkg.of 5
77043	Forged Clip, 5/16"	1 pkg.of 5
77044	Forged Clip, 3/8"	1 pkg.of 5
77045	Forged Clip, 1/2"	1 pkg.of 5
77050	Thimble, 1/8"	1 pkg.of 10
77051	Thimble, 3/16"	1 pkg.of 10
77052	Thimble, 1/4"	1 pkg.of 10
77053	Thimble, 5/16"	1 pkg.of 10
77054	Thimble, 3/8"	1 pkg.of 10
77055	Thimble, 1/2"	1 pkg.of 5
77060	Thimble, 1/4" HD	1 pkg.of 10
77061	Thimble, 5/16" HD	1 pkg.of 10
77062	Thimble, 3/8" HD	1 pkg.of 10
77063	Thimble, 1/2" HD	1 pkg.of 5
77064	Thimble, 5/8" HD	10 ea.
77107	Mini Cable Clipper	1 ea.
97080	Cable Sleeve Dynapak	4 pkgs.
97081	Cable Sleeve Dynapak	4 pkgs.
97082	Cable Sleeve Dynapak	4 pkgs.
97083	Cable Sleeve Dynapak	2 pkgs.
97084	Cable Sleeve Dynapak	4 pkgs.
97085	Cable Sleeve Dynapak	2 pkgs.



Plan-O-Grams do not include gondola or shelves. Products may not be exactly as illustrated.



Merchandisers

Chain and Rigging Merchandisers



Stainless Steel Hardware Merchandiser

PART#	CONTENTS
-------	----------

00619 Chain Connectors **Display Board Only**, 12" x 24"

00619K Full Stainless Steel Merchandiser. Includes 00619 display board, 40 pegs (80004) and product listed below:

PART#	DESCRIPTION	QTY.
64000	Quick Link, 1/8"	1 pkg. 5
64001	Quick Link, 5/32"	1 pkg. 5
64002	Quick Link, 1/4"	1 pkg. 5
64003	Quick Link, 5/16"	1 pkg. 5
64004	Quick Link, 3/8"	1 pkg. 5
64020	Wire Rope Clip, 1/8"	1 pkg. 5
64021	Wire Rope Clip, 3/16"	1 pkg. 5
64022	Wire Rope Clip, 1/4"	1 pkg. 5
64023	Wire Rope Clip, 5/16"	1 pkg. 5
64024	Wire Rope Clip, 3/8"	1 pkg. 5
64040	Thimble, 1/8"	1 pkg. 5
64041	Thimble, 3/16"	1 pkg. 5
64042	Thimble, 1/4"	1 pkg. 5
64043	Thimble, 5/16"	1 pkg. 5
64044	Thimble, 3/8"	1 pkg. 5
64060	Shackle, 3/16"	1 pkg. 5
64061	Shackle, 1/4"	1 pkg. 5
64062	Shackle, 5/16"	1 pkg. 5
64063	Shackle, 3/8"	1 pkg. 5
64070	Snap Link, 3/16"	1 pkg. 5
64071	Snap Link, 1/4"	1 pkg. 5
64072	Snap Link, 5/16"	1 pkg. 5
64073	Snap Link, 3/8"	1 pkg. 5
64100	Bolt Snap, 1/2"	1 pkg. 5
64101	Bolt Snap, 3/4"	1 pkg. 5
64102	Security Snap, 5/8"	1 pkg. 5
64103	Security Snap, 3/4"	1 pkg. 5
64104	Security Snap, 7/8"	1 pkg. 5
64105	Spring Snap, 2"	1 pkg. 5
64106	Spring Snap, 2-3/8"	1 pkg. 5
64107	Spring Snap, 3-3/4"	1 pkg. 5
64108	Boat Snap, 10 x 53	1 pkg. 5
64109	Boat Snap, 16 x 72	1 pkg. 5
64110	Boat Snap, 19 x 81	1 pkg. 5
64111	Boat Snap, 19 x 98	1 pkg. 5

Plan-O-Grams do not include gondola or shelves. Products may not be exactly as illustrated.



Merchandisers





Chain Connectors Merchandiser

PART#	CONTENTS
-------	----------

00614 Chain Connectors **Display Board Only**, 12" x 24"

00614K **Full Chain Connectors Merchandiser**. Includes 00614 display board, 35 pegs (80004) and product listed below:

PART#	DESCRIPTION	QUANTITY
66138	Mid Link, 1/4"	4 ea.
66139	Mid Link, 3/8"	4 ea.
66140	Mid Link, 1/2"	2 ea.
66165	Chain Swivel, 1/4"	1 pkg. of 2
66166	Chain Swivel, 5/16"	1 pkg. of 2
66167	Chain Swivel, 3/8"	1 pkg. of 2
66168	Chain Swivel, 1/2"	1 pkg. of 2
66400	Repair Link, 1/8"	1 pkg. of 10
66401	Repair Link, 3/16"	1 pkg. of 10
66402	Repair Link, 1/4"	1 pkg. of 10
66403	Repair Link, 5/16"	1 pkg. of 5
66404	Repair Link, 3/8"	1 pkg. of 5
66413	Link Lock, 1/4"	1 pkg. of 5
66414	Link Lock 5/16"	1 pkg. of 5
66415	Link Lock, 3/8"	1 pkg. of 5
66416	Missing Link, 1/4"	1 pkg. of 5
66417	Missing Link, 5/16"	1 pkg. of 5
66418	Missing Link, 3/8"	1 pkg. of 5
66419	Snap Link, 5 mm	1 pkg. of 10
66420	Snap Link, 6 mm	1 pkg. of 10
66421	Snap Link, 8 mm	1 pkg. of 10
66422	Snap Link, 10 mm	1 pkg. of 10
66425	Snap Link, 11 mm	1 pkg. of 5
66426	Snap Link, 12 mm	1 pkg. of 5
66430	Quick Link, 1/8"	1 pkg. of 10
66431	Quick Link, 3/16"	1 pkg. of 10
66432	Quick Link, 1/4"	1 pkg. of 10
66433	Quick Link, 5/16"	1 pkg. of 5
66434	Quick Link, 3/8"	1 pkg. of 5
66435	Quick Link, 7/16"	1 pkg. of 5
66436	Quick Link, 1/2"	1 pkg. of 5
66440	Cold Shut, 3/16"	1 pkg. of 10
66441	Cold Shut, 1/4"	1 pkg. of 10
66442	Cold Shut, 5/16"	1 pkg. of 5
66443	Cold Shut, 3/8"	1 pkg. of 5



Plan-O-Grams do not include gondola or shelves. Products may not be exactly as illustrated.



Merchandisers

Chain and Rigging Merchandisers



00024 **Compatible**



00024 **Compatible**

Chain Hooks Merchandiser

PART#	CONTENTS
-------	----------

00408 Chain Hooks **Display Board Only**, 24" x 24"

00408K Full Chain Hooks Merchandiser. Includes 00408 display board, 30 pegs (80004) and product listed below:

PART#	DESCRIPTION	QTY.	PART#	DESCRIPTION	QTY.
66070	Clevis Slip Hook, c/w latch, 1/4"	1 ea.	66117	Clevis Grab Hook, 3/8"	2 ea.
66071	Clevis Slip Hook, c/w latch, 5/16"	2 ea.	66120	Clevis Grab Hook, Alloy, 1/4"	4 ea.
66072	Clevis Slip Hook, c/w latch, 3/8"	2 ea.	66121	Clevis Grab Hook, Alloy, 5/16"	4 ea.
66073	Clevis Slip Hook, c/w latch, 1/4"	2 ea.	66122	Clevis Grab Hook, Alloy, 3/8"	4 ea.
66074	Clevis Slip Hook, c/w latch, 5/16"	2 ea.	66123	Eye Grab Hook, 1/4"	2 ea.
66075	Clevis Slip Hook, c/w latch, 3/8"	2 ea.	66124	Eye Grab Hook, 5/16"	1 ea.
66080	Alloy Grab Hook, c/w latch, 1/4"	1 ea.	66125	Eye Grab Hook, 3/8"	1 ea.
66081	Alloy Grab Hook, c/w latch, 5/16"	1 ea.	66129	Eye Grab Hook, 1/4"	1 ea.
66082	Alloy Grab Hook, c/w latch, 3/8"	1 ea.	66130	Eye Grab Hook, 5/16"	1 ea.
66110	Clevis Grab Hook, 1/4"	4 ea.	66131	Eye Grab Hook, 3/8"	1 ea.
66111	Clevis Grab Hook, 5/16"	4 ea.	66136	Safety Winch Hook, 1/4"	2 ea.
66112	Clevis Grab Hook, 3/8"	4 ea.	66137	Safety Lanyard Hook (single)	4 ea.
66115	Clevis Grab Hook, 1/4"	4 ea.	66137S	Safety Lanyard Hook (double)	2 ea.
66116	Clevis Grab Hook, 5/16"	2 ea.	66145	Eye Hoist Hook, 3/4T	2 ea.
			66146	Eye Hoist Hook, 1T	2 ea.
			66147	Eye Hoist Hook, 1.5T	1 ea.

Shackles & Clevises Merchandiser

PART#	CONTENTS
-------	----------

00386 Shackles & Clevises **Display Board Only** (24" x 24")

00386K Full Shackles & Clevises Merchandiser. Includes 00386 display board, 25 pegs (80004) and product listed below:

PART#	DESCRIPTION	QTY.	PART#	DESCRIPTION	QTY.
66000	Anchor Shackle, 1/4"	2 ea.	66014	Anchor Shackle, 5/8"	1 ea.
66001	Anchor Shackle, 5/16"	2 ea.	66017	Anchor Shackle, 7/16"	1 ea.
66002	Anchor Shackle, 3/8"	2 ea.	66020	Chain Shackle, 1/4"	2 ea.
66003	Anchor Shackle, 7/16"	2 ea.	66021	Chain Shackle, 5/16"	2 ea.
66004	Anchor Shackle, 1/2"	2 ea.	66022	Chain Shackle, 3/8"	2 ea.
66005	Anchor Shackle, 5/8"	1 ea.	66023	Chain Shackle, 7/16"	2 ea.
66006	Anchor Shackle, 3/4"	1 ea.	66024	Chain Shackle, 1/2"	2 ea.
66007	Anchor Shackle, 7/8"	1 ea.	66029	Straight Clevis, 5/8"	1 ea.
66008	Anchor Shackle, 1"	1 ea.	66030	Straight Clevis, 3/4"	1 ea.
66010	Anchor Shackle, 1/4"	2 ea.	66031	Straight Clevis, 7/8"	1 ea.
66011	Anchor Shackle, 5/16"	2 ea.	66032	Straight Clevis, 15/16"	1 ea.
66012	Anchor Shackle, 3/8"	2 ea.	66033	Straight Clevis, 1"	1 ea.
66013	Anchor Shackle, 1/2"	2 ea.			

Plan-O-Grams do not include gondola or shelves. Products may not be exactly as illustrated.



Merchandisers





Wire Rope Accessories Merchandiser

PART#	CONTENTS
00567	Wire Rope Display Board Only , 24" x 24"

Full Wire Rope Accessories Merchandiser.
00567K Includes 00567 display board and 41 pegs (80004) and the products listed below:

PART#	DESCRIPTION	QTY.
77031	Malleable Clip, 3/16"	1 pkg. of 10
77032	Malleable Clip, 1/4"	1 pkg. of 10
77033	Malleable Clip, 5/16"	1 pkg. of 10
77034	Malleable Clip, 3/8"	1 pkg. of 5
77035	Malleable Clip, 1/2"	1 pkg. of 5
77036	Malleable Clip, 5/8"	2 ea.
77037	Malleable Clip, 3/4"	2 ea.
77038	Malleable Clip, 7/8"	2 ea.
77039	Malleable Clip, 1"	2 ea.
77041	Forged Clip, 3/16"	1 pkg. of 5
77042	Forged Clip, 1/4"	1 pkg. of 5
77043	Forged Clip, 5/16"	1 pkg. of 5
77044	Forged Clip, 3/8"	1 pkg. of 5
77045	Forged Clip, 1/2"	1 pkg. of 5
77046	Forged Clip, 5/8"	2 ea.
77047	Forged Clip, 3/4"	2 ea.
77048	Forged Clip, 7/8"	2 ea.
77049	Forged Clip, 1"	2 ea.
77050	Thimble, 1/8"	1 pkg. of 10
77051	Thimble, 3/16"	1 pkg. of 10
77052	Thimble, 1/4"	1 pkg. of 10
77053	Thimble, 5/16"	1 pkg. of 10
77054	Thimble, 3/8"	1 pkg. of 10
77055	Thimble, 1/2"	1 pkg. of 5
77056	Thimble, 5/8"	2 ea.
77060	Thimble, 1/4", H.D.	1 pkg. of 10
77061	Thimble, 5/16", H.D.	1 pkg. of 10
77062	Thimble, 3/8", H.D.	1 pkg. of 10
77063	Thimble, 1/2", H.D.	1 pkg. of 5
77064	Thimble, 5/8", H.D.	2 ea.
77066	Thimble, 7/8", H.D.	2 ea.
77067	Thimble, 1", H.D.	2 ea.
77068	Thimble, 1-1/8", H.D.	2 ea.
97080	Cable Sleeves Dynapak	1 pkg.
97081	Cable Sleeves Dynapak	1 pkg.
97082	Cable Sleeves Dynapak	1 pkg.
97083	Cable Sleeves Dynapak	1 pkg.
97084	Cable Sleeves Dynapak	1 pkg.
97085	Cable Sleeves Dynapak	1 pkg.



Does not include cable clipper



Plan-O-Grams do not include gondola or shelves. Products may not be exactly as illustrated.



Merchandisers

Chain and Rigging Merchandisers

Chain Rack - 4'

PART#	CONTENTS
-------	----------

70099 Chain **Rack Only**, 47" wide x 73" high x 13" deep

70099K **Full 4' Chain Rack Merchandiser**. Includes 12" x 48" Chain Rack Header and the products listed below:

PART#	DESCRIPTION	QTY.	PART#	DESCRIPTION	QTY.
70075	Sash Chain #35 X 100' per Reel	1 Roll of 100'	70003	Grade 30 Chain 3/16" X 250'/Bucket	1 Bucket of 250'
70080	Furnace Chain, #91 X 250'/Reel	1 Roll of 250'	70004	Grade 30 Chain 1/4" X 141'/Bucket	1 Bucket of 141'
70085	Single Jack Chain, #10T X 150'/Reel	1 Roll of 150'	70005	Grade 30 Chain 5/16" X 92'/Bucket	1 Bucket of 92'
70086	Single Jack Chain, #12 X 100'/Reel	1 Roll of 100'	70006	Grade 30 Chain 3/8" X 63'/Bucket	1 Bucket of 63'
70087	Single Jack Chain, #14 X 200'/Reel	1 Roll of 200'	70024	Grade 70 Chain 1/4" X 130'/Bucket	1 Bucket of 130'
			70025	Grade 70 Chain 5/16" X 90'/Bucket	1 Bucket of 90'
			70026	Grade 70 Chain 3/8" X 64' per Bucket	2 Buckets of 64'
			70040	Straight Link Coil Chain, #4 X 100'/Reel	1 Roll of 100'
			70045	Passing Link Chain, #2/0 X 120'/Reel	1 Roll of 120'
			70050	Twist Link Machine Chain, #2/0 X 75'/Reel	1 Roll of 75'
			70051	Twist Link Machine Chain, #4 X 100'/Reel	1 Roll of 100'
			70060	Double Loop Lion Chain, #2/0 X 150'/Reel	1 Roll of 150'
			70061	Double Loop Lion Chain, #1/0 X 100'/Reel, Green PVC	1 Roll of 100'
			70062	Double Loop Lion Chain, #2/0 X 125'/Reel, Blue PVC	1 Roll of 125'
			70063	Double Loop Lion Chain, #3 X 200' per Reel	1 Roll of 200'
			70070	Brass Safety Chain, #1/0 X 200' per Reel	1 Roll of 200'

Chain Rack - 2'



Chain Rack - 4'

Chain Rack - 2'

PART#	CONTENTS
-------	----------

70010 Chain **Rack Only**, 23" wide x 73" high x 13" deep

70010K **Full 2' Chain Rack Merchandiser**. Includes 9" x 23" Dynaline Distributor sign (00003) and the products listed below:

PART#	DESCRIPTION	QTY.	PART#	DESCRIPTION	QTY.
70010	Chain Rack - 2 ft.	1 ea.	70061	Double Loop Lion Chain, #1/0 x100'	1 reel of 100'
70005	Chain 5/16" x 92' Grade 30	1 bucket of 92'	70062	Double Loop Lion Chain, #2 x 125'	1 reel of 125'
70007	Chain 3/16" x 100' Grade 30	1 bucket of 100'	70063	Double Loop Lion Chain, #3 x 200'	1 reel of 200'
70008	Chain 1/4" x 65' Grade 30	1 bucket of 65'	70070	Brass Safety Chain, #1/0 x 200'	1 reel of 200'
70016	Chain 3/8" x 45' Grade 30	1 bucket of 45'	70075	Sash Chain, #35 x 100'	1 reel of 100'
70040	Straight Link Coil Chain, #4 x 100'	1 reel of 100'	70080	Furnace Chain, #91 x 250'	1 reel of 250'
70045	Passing Link Chain, #2/0 x 120'	1 reel of 120'	70085	Single Jack Chain, #10T x 150'	1 reel of 150'
70050	Twist Link Mach. Chain, #2/0 x 75'	1 reel of 75'	70086	Single Jack Chain, #12 x 100'	1 reel of 100'
70051	Twist Link Mach. Chain, #4 x 100'	1 reel of 100'	70087	Single Jack Chain, #14 x 200'	1 reel of 200'
70060	Double Loop Lion Chain, #2/0 x150'	1 reel of 150'			

Plan-O-Grams do not include gondola or shelves. Products may not be exactly as illustrated.



Chain & Steel Cable Rack Merchandiser

PART#	CONTENTS	
70010	Chain & Wire Rope Rack Only (23" x 13" x 73") Free standing floor rack for Wire Rope Spools	
00465K	Full Steel Cable Rack Merchandiser. Includes 70010 Steel Cable Display Rack (Dimensions: 23" x 13" x 73") with 9" x 23" header and the products listed below:	
PART#	DESCRIPTION	QTY.
77010	Chain Rack - 2 ft.	1 ea.
77000	Aircraft Cable, 1/16", 500 ft. reel	1 reel of 500'
77001	Aircraft Cable, 3/32", 500 ft. reel	1 reel of 500'
77002	Aircraft Cable, 1/8", 250 ft. reel	1 reel of 250'
77003	Aircraft Cable, 5/32", 250 ft. reel	1 reel of 250'
77004	Aircraft Cable, 3/16", 250 ft. reel	1 reel of 250'
77005	Aircraft Cable, 1/4", 250 ft. reel	1 reel of 250'
77006	Aircraft Cable, 5/16", 250 ft. reel	1 reel of 250'
77007	Aircraft Cable, 3/8", 250 ft. reel	1 reel of 250'
77020	Wire Rope, 1/2", 100 ft. reel	1 reel of 100'
70040	Straight Link Coil Chain, #4, 100' reel	1 reel of 100'
70045	Passing Link Chain, #2/0, 120' reel	1 reel of 120'
70007	Grade 30 Chain, 3/16", 100' bucket	1 bucket of 100'
70005	Grade 30 Chain, 5/16", 92' bucket	1 bucket of 92'
70008	Grade 30 Chain, 1/4", 65' bucket	1 bucket of 65'
70016	Grade 30 Chain, 3/8", 45' bucket	1 bucket of 45'

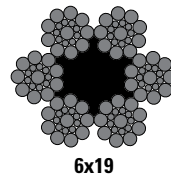
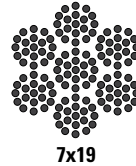
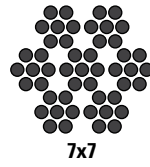

DYNALINE

For more information on these products see the Chain and Rigging section of the catalogue!



Your Trusted Source.

Plan-O-Grams do not include gondola or shelves. Products may not be exactly as illustrated.



Merchandisers

General Hardware Merchandisers

General Hardware Merchandiser

PART#	CONTENTS
-------	----------

01081 General Hardware **Backdrop Only**, 48" x 48"

01081K **Full General Hardware Plan-o-gram**. Includes 01081 and 110 pegs (80004) and the products listed below:

ITEM	PART#	DESCRIPTION	QTY.
Bolt Snaps	64100	1/2", S.S.	1 pkg. of 5
	64101	3/4", S.S.	1 pkg. of 5
	66343	3/4"	1 pkg. of 5
	66340	11/16"	1 pkg. of 5
	66366	3-1/4"	1 pkg. of 5
	66383	5"	1 pkg. of 5
	66360	Brass, 1/2" x 3"	1 pkg. of 5
Double Bolt Snap	66342	7/16"	1 pkg. of 5
Security Snaps	64102	5/8"	1 pkg. of 5
	64103	3/4"	1 pkg. of 5
	64104	7/8"	1 pkg. of 5
Spring Snaps	64105	1/4"	1 pkg. of 5
	64106	3/8"	1 pkg. of 5
	64107	1/2"	1 pkg. of 5
	66351	1"	1 pkg. of 5
Boat Snaps	64108	1/2"	1 pkg. of 5
	64109	5/8"	1 pkg. of 5
	64110	3/4"	1 pkg. of 5
	64111	3/4"	1 pkg. of 5
Eyebolts	65102	3/16" x 2"	1 pkg. of 10
	65104	3/16" x 2-1/2"	1 pkg. of 10
	65106	1/4" x 2"	1 pkg. of 10
	65107	1/4" x 2-1/2"	1 pkg. of 10
	65108	1/4" x 3"	1 pkg. of 10
	65109	1/4" x 4"	1 pkg. of 10
	65110	1/4" x 5"	1 pkg. of 10
	65111	1/4" x 6"	1 pkg. of 10
	65112	5/16" x 3-1/4"	1 pkg. of 10
	65113	5/16" x 4"	1 pkg. of 10
65114	5/16" x 5"	1 pkg. of 10	
65115	5/16" x 6"	1 pkg. of 10	
65117	3/8" x 4"	1 pkg. of 10	
65118	3/8" x 5"	1 pkg. of 10	
65119	3/8" x 6"	1 pkg. of 10	
65120	3/8" x 8"	1 pkg. of 10	
65123	1/2" x 6"	1 pkg. of 10	
65124	1/2" x 8"	1 pkg. of 10	
U-Bolts	65140	1/4" x 1-1/8"	1 pkg. of 10
	65141	1/4" x 1-3/8"	1 pkg. of 10
	65142	1/4" x 2"	1 pkg. of 10



ITEM	PART#	DESCRIPTION	QTY.
	65143	5/16" x 1-3/8"	1 pkg. of 10
	65144	5/16" x 1-3/8"	1 pkg. of 10
	65145	5/16" x 1-3/4"	1 pkg. of 10
	65146	5/16" x 1-3/4"	1 pkg. of 10
	65147	5/16" x 2"	1 pkg. of 10
	65148	5/16" x 2"	1 pkg. of 10
	65149	5/16" x 2-1/2"	1 pkg. of 10
	65150	5/16" x 2-1/2"	1 pkg. of 10
	65151	3/8" x 2-1/2"	1 pkg. of 10
	65152	3/8" x 3"	1 pkg. of 10
	65153	3/8" x 3-1/2"	1 pkg. of 10
	65161	1/4"	1 pkg. of 10
Lagscrew Eyebolts	65162	1/4"	1 pkg. of 10
	65163	5/16"	1 pkg. of 10
	65164	5/16"	1 pkg. of 10
	65165	3/8"x4"	1 pkg. of 10

Plan-O-Grams do not include gondola or shelves. Products may not be exactly as illustrated.



Merchandisers



General Hardware Continued

ITEM	PART#	DESCRIPTION	QTY.	ITEM	PART#	DESCRIPTION	QTY.
	65166	3/8"x8"	1 pkg. of 10		66335	13/16"	1 pkg. of 5
Rings	65172	W/ Eyebolt	1 pkg. of 10	Dog Lead Snaps	66336	3/8"	1 pkg. of 5
	65177	W/Lag screw Eyebolt	1 pkg. of 10		66338	Panic Snap, 1/2"	1 pkg. of 5
	65178	W/Mounting Plate	1 pkg. of 10	Trigger Snaps	66339	5/8"	1 pkg. of 5
Square U-Bolts	65181	3/8" - 2" x 3"	1 pkg. of 5		66344	3/4"	1 pkg. of 5
	65182	3/8" - 2" x 5"	1 pkg. of 5		66349	1"	1 pkg. of 5
	65184	3/8" - 4" x 3"	1 pkg. of 5		66350	13/16"	1 pkg. of 5
	65185	3/8" - 4" x 5"	1 pkg. of 5	Sq. Trigger Snap	66348	3/4"	1 pkg. of 5
	65187	3/8" - 6" x 5"	1 pkg. of 5	Open Eye Snap	66341	13/16"	1 pkg. of 5
	65188	3/8" - 6" x 7"	1 pkg. of 5	Loop Snaps	66346	3/4"	1 pkg. of 5
Shoulder Eyebolts	66100	1/4" x 2"	2 ea.		66347	1"	1 pkg. of 5
	66101	5/16" x 2-1/4"	2 ea.	Swivel Loop Snaps	66352	3/4"	1 pkg. of 5
	66102	3/8" x 2-1/2"	2 ea.		66353	1"	1 pkg. of 5
	66103	1/2" x 3-1/4"	2 ea.	Mini Bolt Snaps	66354	7/16"	1 pkg. of 5
	66104	5/8" X 4"	2 ea.	Open Decoy Snap	66355	1/2" x 2-1/2"	1 pkg. of 5
	66105	1/4" x 4"	2 ea.	Flat Spring Snaps	66356	Simplex	1 pkg. of 5
	66106	5/16" x 4-1/4"	2 ea.		66361	1"	1 pkg. of 5
	66107	3/8" x 6"	2 ea.	Square Eye Snap	66365	5/8" (Baby)	1 pkg. of 5
	66108	1/2" x 6"	1 ea.	Zinc Swivel Snaps	66367	1/2"	1 pkg. of 5
Safety Lanyard Hooks	66137	Single Latch	2 ea.		66368	5/8"	1 pkg. of 5
	66137S	Double Latch	2 ea.		66369	3/4"	1 pkg. of 5
D-Rings	66173	1" x 7/8"	1 pkg. of 10		66370	1"	1 pkg. of 5
	66174	1-1/8" x 7/8"	1 pkg. of 10	Swivel Eye Snaps	66371	1/2"	1 pkg. of 5
	66175	1-5/16" x 1"	1 pkg. of 10		66372	3/8"	1 pkg. of 5
	66176	1-5/8" x 1-1/8"	1 pkg. of 10	Lever Snaps	66374	5/8", Nickel Plated	1 pkg. of 5
	66178	2" x 1-3/4", H.D.	1 pkg. of 10		66375	3/4", Nickel Plated	1 pkg. of 5
O-Rings	66179	H.D.	1 pkg. of 10		66376	1", Nickel Plated	1 pkg. of 5
Key Rings	66180	5/8" I.D.	1 pkg. of 10		66377	1-1/8"	1 pkg. of 5
	66182	1" I.D.	1 pkg. of 10	Security Snaps	66380	7/8"	1 pkg. of 5
	66184	1-1/4" I.D.	1 pkg. of 10		66381	1"	1 pkg. of 5
S-Hooks	66230	1"	1 pkg. of 10	Eye Bull Snap	66385	3/4" x 3-3/4"	1 pkg. of 5
	66232	1-3/32"	1 pkg. of 10	Swivel Spring Snap	66387	Simplex	1 pkg. of 5
	66234	1-3/8"	1 pkg. of 10	Harness Ring	66390	1-1/4"	1 pkg. of 5
	66235	1-1/2"	1 pkg. of 10	Animal Snap	66392	1", bronze cast	1 pkg. of 5
	66236	2-1/8"	1 pkg. of 10	Security Snap	66394	1", swivel	1 pkg. of 5
	66238	2-5/8"	1 pkg. of 10	Steel Rings	66410	1/4" x 1"	1 pkg. of 10
	66239	2-7/8"	1 pkg. of 10		66411	5/16" x 1-1/8"	1 pkg. of 10
Tarp Strap Hook	66241	--	1 pkg. of 10		66412	7/32" x 2"	1 pkg. of 10
Bull Snap	66330	--	1 pkg. of 5	Tarp Hooks	66423	3/8" x 3-1/2"	1 pkg. of 10
Solid Snap Hook	66331	11/16"	1 pkg. of 5		66424	1/4" x 2-1/2"	1 pkg. of 10
Cap Snap	66332	1"	1 pkg. of 5	Screw eyes	65018	1-5/16"	1 pkg. of 10
Swivel Eye Snaps	66334	11/16"	1 pkg. of 5		65020	15/16"	1 pkg. of 10

Plan-O-Grams do not include gondola or shelves. Products may not be exactly as illustrated.



Merchandisers

General Hardware Merchandisers

Snaps Merchandiser

PART#	CONTENTS
00448	Snaps Display Board Only , 24" x 24"

00448K Full Snaps Merchandiser. Includes 00448 display board, 52 pegs (80004) and product listed below:

PART#	DESCRIPTION	QUANTITY
66330	Bull Snap, 1"	1 pkg. of 5
66331	Solid Snap Hook, 11/16"	1 pkg. of 5
66332	Cap Snap, 1"	1 pkg. of 5
66334	Swivel Eye Snap, 11/16"	1 pkg. of 5
66335	Swivel Eye Snap, 13/16"	1 pkg. of 5
66336	Dog Lead Snap, 3/8"	1 pkg. of 5
66338	Panic Snap, 1/2"	1 pkg. of 5
66339	Trigger Snap, 5/8"	1 pkg. of 5
66340	Bolt Snap, 11/16"	1 pkg. of 5
66341	Open Eye Snap, 13/16"	1 pkg. of 5
66342	Double Bolt Snap, 7/16"	1 pkg. of 5
66343	Bolt Snap, 3/4"	1 pkg. of 5
66344	Trigger Snap, 3/4"	1 pkg. of 5
66346	Loop Snap, 3/4"	1 pkg. of 5
66347	Loop Snap, 1"	1 pkg. of 5
66348	Square Trigger Snap, 3/4"	1 pkg. of 5
66349	Trigger Snap, 1"	1 pkg. of 5
66350	Trigger Snap, 13/16"	1 pkg. of 5
66351	Spring Snap, 1"	1 pkg. of 5
66352	Swivel Loop Snap, 3/4"	1 pkg. of 5
66353	Swivel Loop Snap, 1"	1 pkg. of 5
66354	Mini Bolt Snap, 7/16"	1 pkg. of 5
66355	Open Decoy Snap, 1/2"	1 pkg. of 5
66356	Simplex Snap, 11/16"	1 pkg. of 5
66360	Solid Brass Bolt Snap, 1/2" x 3"	1 pkg. of 5
66361	Brass Bolt Snap, 1"	1 pkg. of 5
66365	Baby Square Eye Snap, 5/8"	1 pkg. of 5
66366	Bolt Snap, 3-1/4"	1 pkg. of 5
66367	1/2" Zinc Swivel Snap	1 pkg. of 5
66368	5/8" Zinc Swivel Snap	1 pkg. of 5
66369	3/4" Zinc Swivel Snap	1 pkg. of 5
66370	1" Zinc Swivel Snap	1 pkg. of 5
66374	5/8" Lever Snap, Nickel Plated	1 pkg. of 5
66375	3/4" Lever Snap, Nickel Plated	1 pkg. of 5
66376	1" Lever Snap, Nickel Plated	1 pkg. of 5
66377	Lever Snap, 1-1/8"	1 pkg. of 5
66380	Security Snap, 7/8"	1 pkg. of 5



PART#	DESCRIPTION	QUANTITY
66381	Security Snap Hook, 7/8"	1 pkg. of 5
66385	Eye Bull Snap, 3/4"x 3-3/4"	1 pkg. of 5
66387	Simplex Spring Snap, Swivel	1 pkg. of 5
66392	Bronze Animal Snap 1"x4-1/2"	1 pkg. of 5
66394	Security Snap Swivel 1"x4-1/8"	1 pkg. of 5
66427	Aluminum Snap Hook, 3/16"	1 pkg. of 10
66428	Aluminum Snap Hook, 1/4"	1 pkg. of 10
66429	Aluminum Snap Hook, 5/16"	1 pkg. of 10

Plan-O-Grams do not include gondola or shelves. Products may not be exactly as illustrated.



Merchandisers



Eyebolts & Rings Merchandiser

PART#	CONTENTS
00611	Eyebolts & Rings Display Board Only , 24" x 24"
00611K	Full Eyebolts & Rings Merchandiser. Includes 00611 display board, 47 pegs (80004) and the products listed below:

PART#	DESCRIPTION	QTY.
65102	Eyebolt, 3/8"	1 pkg. of 10
65104	Eyebolt, 3/8"	1 pkg. of 10
65106	Eyebolt, 9/16"	1 pkg. of 10
65107	Eyebolt, 9/16"	1 pkg. of 10
65108	Eyebolt, 9/16"	1 pkg. of 10
65109	Eyebolt, 9/16"	1 pkg. of 10
65110	Eyebolt, 9/16"	1 pkg. of 10
65111	Eyebolt, 9/16"	1 pkg. of 10
65112	Eyebolt, 3/4"	1 pkg. of 10
65113	Eyebolt, 3/4"	1 pkg. of 10
65114	Eyebolt, 3/4"	1 pkg. of 10
65115	Eyebolt, 3/4"	1 pkg. of 10
65117	Eyebolt, 1"	1 pkg. of 10
65118	Eyebolt, 1"	1 pkg. of 10
65119	Eyebolt, 1"	1 pkg. of 10
65120	Eyebolt, 1"	1 pkg. of 10
65123	Eyebolt, 1-1/4"	1 pkg. of 10
65124	Eyebolt, 1-1/4"	1 pkg. of 10
65161	Lag screw, 1/2"	1 pkg. of 10
65162	Lag screw, 1/2"	1 pkg. of 10
65163	Lag screw, 5/8"	1 pkg. of 10
65164	Lag screw, 5/8"	1 pkg. of 10
65165	Lagscrew, 3/4"	1 pkg. of 10
65166	Lagscrew, 3/4"	1 pkg. of 10
65172	Mounting Ring, 2"	1 pkg. of 10
65177	Mounting Ring Lag Screw, 2"	1 pkg. of 10
65178	Mounting Ring with Plate, 2"	1 pkg. of 10
66100	Shoulder Eyebolt, 1/2"	2 ea.
66101	Shoulder Eyebolt, 5/8"	2 ea.
66102	Shoulder Eyebolt, 3/4"	2 ea.
Part#	Description	Qty.
66103	Shoulder Eyebolt, 1"	2 ea.
66104	Shoulder Eyebolt, 1-1/4"	2 ea.
66105	Shoulder Eyebolt, 1/2"	2 ea.
66106	Shoulder Eyebolt, 5/8"	2 ea.
66107	Shoulder Eyebolt, 3/4"	2 ea.
66108	Shoulder Eyebolt, 1"	2 ea.
66173	D-Ring, 7/8"	1 pkg. of 10
66174	D-Ring, 7/8"	1 pkg. of 10



PART#	DESCRIPTION	QTY.
66175	D-Ring, 1"	1 pkg. of 10
66176	D-Ring, 1-1/8"	1 pkg. of 10
66178	D-Ring, 1-3/4"	1 pkg. of 10
66180	Split Key Ring, 3/4"	1 pkg. of 10
66182	Split Key Ring, 1"	1 pkg. of 10
66184	Split Key Ring, 1-1/4"	1 pkg. of 10
66410	Welded Ring, 1"	1 pkg. of 10
66411	Welded Ring, 1-1/8"	1 pkg. of 10
66412	Welded Ring, 2"	1 pkg. of 10

Plan-O-Grams do not include gondola or shelves. Products may not be exactly as illustrated.



Merchandisers

General Hardware Merchandisers

U-Bolts Merchandiser

PART#	CONTENTS				
00612	U-Bolts Display Board Only , 24" x 24"				
00612K	Full U-Bolts Merchandiser. Includes 00612 display board & 26 pegs (80004) and the products below:				
PART#	DESCRIPTION	QTY.	PART#	DESCRIPTION	QTY.
65140	1/4" x 1-1/8"	1 pkg. of 10	65150	5/16" x 2-1/2"	1 pkg. of 10
65141	1/4" x 1-3/8"	1 pkg. of 10	65151	3/8" x 2-1/2"	1 pkg. of 10
65142	1/4" x 2"	1 pkg. of 10	65152	3/8" x 3"	1 pkg. of 10
65143	5/16" x 1-3/8"	1 pkg. of 10	65153	Square, 3-1/2" x 4-5/8"	1 pkg. of 10
65144	5/16" x 1-3/8"	1 pkg. of 10	65181	Square, 2" x 3"	1 pkg. of 5
65145	5/16" x 1-3/4"	1 pkg. of 10	65182	Square, 2" x 5"	1 pkg. of 5
65146	5/16" x 1-3/4"	1 pkg. of 10	65184	Square, 4" x 3"	1 pkg. of 5
65147	5/16" x 2"	1 pkg. of 10	65185	Square, 4" x 5"	1 pkg. of 5
65148	5/16" x 2"	1 pkg. of 10	65187	Square, 6" x 5"	1 pkg. of 5
65149	5/16" x 2-1/2"	1 pkg. of 10	65188	Square, 6" x 7"	1 pkg. of 5

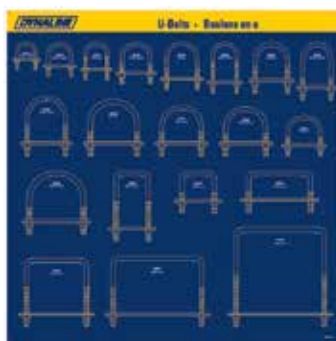

Muffler Clamps Merchandiser

PART#	CONTENTS							
00307	Muffler Clamps Display Board Only , 24" x 24"							
00307K	Full Muffler Clamps Merchandiser. Includes 00307 display board and 16 pegs (80004) and the products below:							
PART#	DESCRIPTION	QTY.	PART#	DESCRIPTION	QTY.	PART#	DESCRIPTION	QTY.
11225	Muffler Clamp 1-1/2"	2	11230	Muffler Clamp 2-1/8"	2	11235	Muffler Clamp 3-1/2"	2
11226	Muffler Clamp 1-5/8"	2	11231	Muffler Clamp 2-1/4"	2	11236	Muffler Clamp 4"	2
11227	Muffler Clamp 1-3/4"	2	11232	Muffler Clamp 2-1/2"	2	11237	Muffler Clamp 4-1/2"	2
11228	Muffler Clamp 1-7/8"	2	11233	Muffler Clamp 2-3/4"	2	11238	Muffler Clamp 5"	2
11229	Muffler Clamp 2"	2	11234	Muffler Clamp 3"	2	11239	Muffler Clamp 5-1/2"	2
						11240	Muffler Clamp 6"	2



Plan-O-Grams do not include gondola or shelves. Products may not be exactly as illustrated.



Merchandisers





Pulley Blocks Merchandiser

PART#	CONTENTS
-------	----------

00334 Pulley Blocks **Display Board Only**, 24" x 24"

00334K **Full Pulley Blocks Merchandiser**. Includes 00334 display board and 34 pegs (80004) and the products below:

PART#	DESCRIPTION	QTY.
55800	Pulley, Swivel Steel, 1-1/2"	2 ea.
55801	Pulley, Swivel Steel, 2"	2 ea.
55802	Pulley, Swivel Steel, 2-1/2"	2 ea.
55803	Pulley, Swivel Steel, 3"	2 ea.
55810	Pulley, Fixed Steel, 1-1/2"	2 ea.
55811	Pulley, Fixed Steel, 2"	2 ea.
55812	Pulley, Fixed Steel, 2-1/2"	2 ea.
55813	Pulley, Fixed Steel, 3"	2 ea.
55840	Sheave 1-1/2", 420 lb	2 ea.
55841	Sheave 2", 480 lb	2 ea.
55842	Sheave 2-1/2", 550 lb	2 ea.
55843	Sheave 3", 650 lb	2 ea.
55870	Double Hook Swivel, 1-1/2"	2 ea.
55871	Double Hook Swivel, 2"	2 ea.
55872	Double Hook Swivel, 2-1/2"	2 ea.
55873	Double Hook Swivel, 3"	2 ea.
55900	Pulley, Sngl. Fixed, 3/4"	2 ea.
55901	Pulley, Sngl. Fixed, 1"	2 ea.
55902	Pulley, Sngl. Fixed, 1-1/4"	2 ea.
55903	Pulley, Sngl. Fixed, 1-1/2"	2 ea.
55904	Pulley, Sngl. Fixed, 2"	2 ea.
55906	Pulley, Dbl. Fixed, 3/4"	2 ea.
55907	Pulley, Dbl. Fixed, 1"	2 ea.
55908	Pulley, Dbl. Fixed, 1-1/2"	2 ea.
55909	Pulley, Dbl. Fixed, 2"	2 ea.
55915	Pulley, Sngl. Swivel, 3/4"	2 ea.
55916	Pulley, Sngl. Swivel, 1"	2 ea.
55917	Pulley, Sngl. Swivel, 1-1/4"	2 ea.
55918	Pulley, Sngl. Swivel, 1-1/2"	2 ea.
55919	Pulley, Sngl. Swivel, 2"	2 ea.
55925	Pulley, Dbl. Swivel, 3/4"	2 ea.
55926	Pulley, Dbl. Swivel, 1"	2 ea.
55927	Pulley, Dbl. Swivel, 1-1/4"	2 ea.
55928	Pulley, Dbl. Swivel, 1-1/2"	2 ea.



 **00024**  **Compatible**

Plan-O-Grams do not include gondola or shelves. Products may not be exactly as illustrated.



Merchandisers

General Hardware Merchandisers

DYNALINE Die Cast Aluminum Pulleys - Poulies en aluminium moulé



DYNALINE Die Cast Aluminum Pulleys - Poulies en aluminium moulé



00024 
Compatible

Aluminum Pulleys Merchandiser

PART#	CONTENTS
-------	----------

00335 Aluminum Pulley **Display Boards Only**, two 24" x 24"

Full Aluminum Pulleys Merchandiser.

00335K Includes two 00335 display boards and 36 pegs (80004) and the products below:

PART#	DESCRIPTION	QTY.
55400	1-1/2" x 1/2"	1 ea.
55401	1-1/2" x 5/8"	2 ea.
55402	2" x 1/2"	1 ea.
55403	2" x 5/8"	2 ea.
55404	2" x 3/4"	1 ea.
55405	2-1/4" x 1/2"	1 ea.
55406	2-1/4" x 5/8"	2 ea.
55407	2-1/4" x 3/4"	1 ea.
55408	2-1/2" x 1/2"	1 ea.
55409	2-1/2" x 5/8"	2 ea.
55410	2-1/2" x 3/4"	1 ea.
55411	3" x 1/2"	1 ea.
55412	3" x 5/8"	2 ea.
55413	3" x 3/4"	1 ea.
55414	3-1/2" x 1/2"	1 ea.
55415	3-1/2" x 5/8"	2 ea.
55416	3-1/2" x 3/4"	1 ea.
55417	4" x 1/2"	1 ea.
55418	4" x 5/8"	2 ea.
55419	4" x 3/4"	1 ea.
55420	4-1/2" x 1/2"	1 ea.
55421	4-1/2" x 5/8"	2 ea.
55422	4-1/2" x 3/4"	1 ea.
55423	5" x 1/2"	1 ea.
55424	5" x 5/8"	1 ea.
55425	5" x 3/4"	1 ea.
55426	6" x 1/2"	1 ea.
55427	6" x 5/8"	1 ea.
55428	6" x 3/4"	1 ea.
55429	7" x 1/2"	1 ea.
55430	7" x 5/8"	1 ea.
55431	7" x 3/4"	1 ea.
55434	8" x 3/4"	1 ea.
<i>VARIABLE SPEED PULLEYS:</i>		
55490	3-1/4" x 1/2"	1 ea.
55491	3-1/4" x 5/8"	1 ea.
55492	3-1/4" x 3/4"	1 ea.

Plan-O-Grams do not include gondola or shelves. Products may not be exactly as illustrated.



Merchandisers





Turnbuckles Merchandiser - General Purpose

PART#	CONTENTS
-------	----------

00416 Turnbuckles **Display Board Only**, 12" x 24"

00416K **Full General Purpose Turnbuckles Merchandiser.**
Includes 00416 display board, 19 pegs (80004) and product listed below:

PART#	DESCRIPTION	QUANTITY	PART#	DESCRIPTION	QUANTITY
66206	Hook & Eye, 7/32"	1 pkg. of 10	66226	Eye & Eye, 7/32"	1 pkg. of 10
66207	Hook & Eye, 1/4"	1 pkg. of 10	66227	Eye & Eye, 1/4"	1 pkg. of 10
66208	Hook & Eye, 5/16"	1 pkg. of 10	66228	Eye & Eye, 5/16"	1 pkg. of 10
66209	Hook & Eye, 3/8"	1 pkg. of 10	66229	Eye & Eye, 3/8"	1 pkg. of 10
66210	Hook & Eye, 6mm	2 ea.			
66211	Hook & Eye, 8mm	2 ea.			
66212	Hook & Eye, 10mm	2 ea.			
66213	Hook & Eye, 12mm	2 ea.			
66214	Hook & Eye, 16mm	2 ea.			
66215	Hook & Eye, 20mm	2 ea.			
66216	Hook & Hook, 7/32"	1 pkg. of 10			
66217	Hook & Hook, 1/4"	1 pkg. of 10			
66218	Hook & Hook, 5/16"	1 pkg. of 10			
66219	Hook & Hook, 3/8"	1 pkg. of 10			



Turnbuckles Merchandiser - Forged Steel

PART#	CONTENTS
-------	----------

00417 Forged Steel Turnbuckles **Display Board Only**, 24" x 24"

00417K **Full Forged Steel Turnbuckles Merchandiser.**
Includes 00417 display board, 30 pegs (80004) and product listed below:

PART#	DESCRIPTION	QUANTITY	PART#	DESCRIPTION	QUANTITY
66206	Hook & Eye, 7/32"	1 pkg. of 10	66822	Hook & Eye, 3/8" x 6"	2 ea.
66207	Hook & Eye, 1/4"	1 pkg. of 10	66823	Hook & Eye, 1/2" x 6"	2 ea.
66209	Hook & Eye, 3/8"	1 pkg. of 10	66830	Eye & Eye, 1/4" x 4"	2 ea.
66210	Hook & Eye, 6mm	2 ea.	66831	Eye & Eye, 5/16" x 4-1/2"	2 ea.
66211	Hook & Eye, 8mm	2 ea.	66832	Eye & Eye, 3/8" x 6"	2 ea.
66212	Hook & Eye, 10mm	2 ea.	66833	Eye & Eye, 1/2" x 6"	2 ea.
66213	Hook & Eye, 12mm	2 ea.	66840	Jaw & Jaw, 1/4" x 4"	2 ea.
66214	Hook & Eye, 16mm	2 ea.	66841	Jaw & Jaw, 5/16" x 4-1/2"	2 ea.
66219	Hook & Hook, 3/8"	1 pkg. of 10	66842	Jaw & Jaw, 3/8" x 6"	2 ea.
66226	Eye & Eye, 7/32"	1 pkg. of 10	66843	Jaw & Jaw, 1/2" x 6"	2 ea.
66227	Eye & Eye, 1/4"	1 pkg. of 10			
66228	Eye & Eye, 5/16"	1 pkg. of 10			
66229	Eye & Eye, 3/8"	1 pkg. of 10			
66800	Hook & Hook, 1/4" x 4"	2 ea.			
66801	Hook & Hook, 5/16" x 4-1/2"	2 ea.			
66802	Hook & Hook, 3/8" x 6"	2 ea.			
66803	Hook & Hook, 1/2" x 6"	2 ea.			
66820	Hook & Eye, 1/4" x 4"	2 ea.			
66821	Hook & Eye, 5/16" x 4-1/2"	2 ea.			

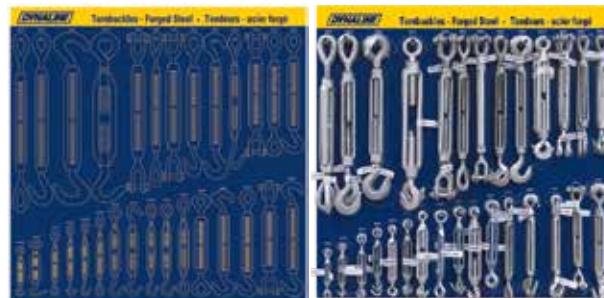

Plan-O-Grams do not include gondola or shelves. Products may not be exactly as illustrated.



Merchandisers

General Hardware Merchandisers

Bronze Bushings Merchandiser

PART#	CONTENTS
-------	----------

00325 Bronze Bushings **Display Board Only**, 12" x 24"

00325K **Full Bronze Bushings Merchandiser**. Includes 00325 display board, 51 pegs (80004) and products listed below:

PART#	INS. DIA.	OUT. DIA.	QTY.	PART#	INS. DIA.	OUT. DIA.	QTY.
55300	1/4"	5/16"	2 ea.	55336	1-1/8"	1-1/2"	1 ea.
55301	1/4"	3/8"	2 ea.	55337	1-3/16"	1-7/16"	1 ea.
55302	1/4"	7/16"	2 ea.	55338	1-3/16"	1-1/2"	1 ea.
55303	1/4"	1/2"	2 ea.	55339	1-1/4"	1-1/2"	1 ea.
55304	5/16"	3/8"	2 ea.	55340	1-1/4"	1-5/8"	1 ea.
55305	5/16"	7/16"	2 ea.	55341	1-3/8"	1-5/8"	1 ea.
55306	3/8"	1/2"	2 ea.	55342	1-3/8"	1-3/4"	1 ea.
55307	3/8"	5/8"	2 ea.	55343	1-7/16"	1-3/4"	1 ea.
55308	3/8"	3/4"	2 ea.	55344	1-1/2"	1-3/4"	1 ea.
55309	7/16"	9/16"	1 ea.	55345	1-1/2"	1-7/8"	1 ea.
55310	7/16"	5/8"	2 ea.	55346	1-5/8"	2"	1 ea.
55311	1/2"	5/8"	2 ea.	55347	1-3/4"	2"	1 ea.
55312	1/2"	11/16"	2 ea.	55348	1-3/4"	2-1/8"	1 ea.
55313	1/2"	3/4"	2 ea.	55349	2"	2-1/4"	1 ea.
55314	1/2"	13/16"	2 ea.	55350	2"	2-3/8"	1 ea.
55315	1/2"	7/8"	2 ea.				
55316	9/16"	3/4"	2 ea.				
55317	9/16"	13/16"	2 ea.				
55318	5/8"	3/4"	2 ea.				
55319	5/8"	13/16"	2 ea.				
55320	5/8"	7/8"	2 ea.				
55321	5/8"	1"	2 ea.				
55322	3/4"	7/8"	2 ea.				
55323	3/4"	15/16"	1 ea.				
55324	3/4"	1"	2 ea.				
55325	13/16"	1"	1 ea.				
55326	7/8"	1"	2 ea.				
55327	7/8"	1-1/8"	1 ea.				
55328	7/8"	1-1/4"	2 ea.				
55329	15/16"	1-1/4"	1 ea.				
55330	1"	1-1/4"	2 ea.				
55331	1"	1-3/8"	2 ea.				
55332	1"	1-1/2"	2 ea.				
55333	1-1/16"	1-5/16"	1 ea.				
55334	1-1/8"	1-1/4"	1 ea.				
55335	1-1/8"	1-3/8"	1 ea.				



Reference Chart Available
See end of catalogue

Plan-O-Grams do not include gondola or shelves. Products may not be exactly as illustrated.





Snaps Merchandiser

PART#	CONTENTS
-------	----------

00447 Snaps **Display Board Only**, 12" x 24"

00447K **Full Snaps Merchandiser**. Includes 00447 display board, 33 pegs (80004) and products listed below:

PART#	DESCRIPTION	QUANTITY
64072	Stainless Steel Snap Link, 5/16"	1 pkg. of 5
66331	Solid Snap Hook, 11/16"	1 pkg. of 5
66334	Swivel Eye Snap, 11/16"	1 pkg. of 5
66335	Swivel Eye Snap, 13/16"	1 pkg. of 5
66336	Dog Lead Snap, 3/8"	1 pkg. of 5
66338	Panic Snap, 1/2"	1 pkg. of 5
66339	Trigger Snap, 5/8"	1 pkg. of 5
66340	Bolt Snap, 11/16"	1 pkg. of 5
66341	Open Eye Snap, 13/16"	1 pkg. of 5
66343	Bolt Snap, 3/4"	1 pkg. of 5
66344	Trigger Snap, 3/4"	1 pkg. of 5
66348	Square Trigger Snap, 3/4"	1 pkg. of 5
66350	Trigger Snap, 13/16"	1 pkg. of 5
66354	Mini Bolt Snap, 7/16"	1 pkg. of 5
66360	Solid Brass Bolt Snap, 1/2" x 3"	1 pkg. of 5
66361	Brass Bolt Snap, 1"	1 pkg. of 5
66365	Baby Square Eye Snap, 5/8"	1 pkg. of 5
66366	Bolt Snap, 3-1/4"	1 pkg. of 5
66374	Lever Snap, 5/8"	1 pkg. of 5
66375	Lever Snap, 3/4"	1 pkg. of 5
66376	Lever Snap, 1"	1 pkg. of 5
66377	Lever Snap, 1-1/8"	1 pkg. of 5
66380	Security Snap, 7/8"	1 pkg. of 5
66381	Security Snap Hook, 7/8"	1 pkg. of 5
66387	Swivel Simplex Spring Snap, 1/2"	1 pkg. of 5
66427	Aluminum Snap Hook, 3/16"	1 pkg. of 10
66428	Aluminum Snap Hook, 1/4"	1 pkg. of 10



Plan-O-Grams do not include gondola or shelves. Products may not be exactly as illustrated.



Merchandisers

Farm Hardware Merchandisers

Pins Merchandiser

PART#	CONTENTS
-------	----------

00557 Pins **Display Board Only**, 24" x 24"

00557K **Full Pins Merchandiser.** Includes 00557 display board and 53 pegs (80004) and the products listed below:

PART#	DESCRIPTION	QTY.	PART#	DESCRIPTION	QTY.
66300	Hair Pin, HP-22	1 pkg. of 25	66490	Safety Pin, 2-13/16"	1 pkg. of 10
66301	Hair Pin, HP-3	1 pkg. of 25	66491	Safety Pin, 3"	1 pkg. of 5
66302	Hair Pin, HP-6	1 pkg. of 25	66492	Safety Pin, 3-3/4"	1 pkg. of 5
66303	Hair Pin, HP-7	1 pkg. of 25	66493	Safety Pin, 5"	1 pkg. of 5
66304	Hair Pin, HP-8	1 pkg. of 25	66494	Safety Pin, 5"	1 pkg. of 5
66305	Hair Pin, HP-9	1 pkg. of 25	66531	Tab, 1/4" x 1-5/8"	1 pkg. of 5
66306	Hair Pin, HP-11	1 pkg. of 25	66532	Tab, 1/4" x 2"	1 pkg. of 5
66307	Hair Pin, HP-16	1 pkg. of 25	66533	Tab, 1/4" x 2-3/4"	1 pkg. of 5
66308	Hair Pin, HP-19	1 pkg. of 10	66534	Tab, 5/16" x 1-5/8"	1 pkg. of 5
66309	Hair Pin, HP-1	1 pkg. of 25	66535	Tab, 5/16" x 2"	1 pkg. of 5
66310	Hair Pin, HP-2	1 pkg. of 25	66536	Tab, 5/16" x 2-3/4"	1 pkg. of 5
66311	Hair Pin, HP-7XX	1 pkg. of 25	66537	Tab, 3/8" x 1-5/8"	1 pkg. of 5
66312	Hair Pin, HP-10X	1 pkg. of 25	66538	Tab, 3/8" x 2-1/2"	1 pkg. of 5
66313	Hair Pin, HP-4	1 pkg. of 25	66539	Tab, 3/8" x 2-3/4"	1 pkg. of 5
66317	Hair Pin, HP-17	1 pkg. of 25			
66318	Hair Pin, HP-18	1 pkg. of 25			
66320	Hair Pin, HP-20	1 pkg. of 10			
66325	Hair Pin, HP-25	1 pkg. of 25			
66326	Hair Pin, HP-10	1 pkg. of 25			
66328	Hair Pin, HP-14	1 pkg. of 25			
66450	Linch Pin, 3/16"	1 pkg. of 10			
66451	Linch Pin, 1/4"	1 pkg. of 10			
66452	Linch Pin, 5/16"	1 pkg. of 10			
66453	Linch Pin, 3/8"	1 pkg. of 10			
66454	Linch Pin, 7/16"	1 pkg. of 10			
66455	Linch Pin, 7/16"	1 pkg. of 10			
66460	Quick Pin, 1-3/8"	1 pkg. of 5			
66461	Quick Pin, 1-3/4"	1 pkg. of 5			
66462	Quick Pin, 2-1/2"	1 pkg. of 5			
66463	Quick Pin, 1-3/8"	1 pkg. of 5			
66464	Quick Pin, 1-3/4"	1 pkg. of 5			
66465	Quick Pin, 2-1/2"	1 pkg. of 5			
66466	Quick Pin, 1-3/8"	1 pkg. of 5			
66467	Quick Pin, 2-1/4"	1 pkg. of 5			
66468	Quick Pin, 2-1/2"	1 pkg. of 5			
66470	Safety Pin, 3-1/8"	1 pkg. of 10			
66472	Safety Pin, 3-3/8"	1 pkg. of 5			
66474	Safety Pin, 5-1/4"	1 pkg. of 5			
66489	Safety Pin, 1-11/16"	1 pkg. of 10			



Plan-O-Grams do not include gondola or shelves. Products may not be exactly as illustrated.





Farm Hardware Merchandiser

PART#	CONTENTS
-------	----------

01101 Farm Hardware **Backdrop Only**, 48" x 48"

01101K **Full Farm Hardware Plan-o-gram**. Includes 01101 and 75 pegs (80004) and the products below:

PART#	DESCRIPTION	QUANTITY	PART#	DESCRIPTION	QUANTITY
66029	Straight Clevis, 1/2"	2 ea.	66472	Safety Pin, 3/16"	1 pkg. of 5
66030	Straight Clevis, 5/8"	2 ea.	66474	Safety Pin, 1/4"	1 pkg. of 5
66031	Straight Clevis, 3/4"	2 ea.	66489	Safety Pin, .091	1 pkg. of 10
66032	Straight Clevis, 7/8"	2 ea.	66490	Safety Pin, 0.12	1 pkg. of 10
66033	Straight Clevis, 1"	2 ea.	66491	Safety Pin, 0.177	1 pkg. of 5
66250	Hitch Pin, 3/8" x 3"	2 ea.	66492	Safety Pin, 0.148	1 pkg. of 5
66251	Hitch Pin, 1/2" x 3-5/8" C/W Clip	2 ea.	66493	Safety Pin, 0.243	1 pkg. of 5
66252	Hitch Pin, 5/8" x 4" C/W Clip	2 ea.	66536	Tab Quick Pin Round, 5/16 x 2-3/4"	1 pkg. of 5
66253	Hitch Pin, 3/4" x 4-1/2" C/W Clip	2ea.	66780	Hitch Pin, 1/2" x 4-1/4"	2 ea.
66254	Hitch Pin, 7/8" x 4-1/2" C/W Clip	2 ea.	66783	Hitch Pin, 3/4" x 4-1/4"	2 ea.
66255	Hitch Pin, 1" x 4-1/2" C/W Clip	2 ea.	66784	Hitch Pin, 3/4" x 6-1/4"	2 ea.
66256	Hitch Pin, 5/8" x 5-1/2" C/W Clip	2 ea.	66786	Hitch Pin, 1" x 6-1/4"	2 ea.
66257	Hitch Pin, 3/4" x 6-1/2" C/W Clip	2 ea.	66872	E-Grip Hitch Pin, 1/2" x 3-1/2"	2 ea.
66258	Hitch Pin, 7/8" x 6-1/2" C/W Clip	2 ea.	66873	E-Grip Hitch Pin, 5/8" x 3-3/4"	2 ea.
66259	Hitch Pin, 1" x 7-1/2" C/W Clip	2 ea.	66874	E-Grip Hitch Pin, 3/4" x 4"	2 ea.
66260	Hitch Pin, 1-1/8" x 8-1/2"	2 ea.	66875	E-Grip Hitch Pin, 5/8" x 6"	2 ea.
66261	Hitch Pin, 1-1/4" x 8-1/2"	2 ea.	66876	E-Grip Hitch Pin, 3/4" x 6-1/4"	2 ea.
66263	Hitch Pin, 1-1/2" x 8-1/2"	2 ea.	66877	E-Grip Hitch Pin, 7/8" x 6-1/2"	2 ea.
66302	Hair Pin, HP-6	1 pkg. of 25	66878	E-Grip Hitch Pin, 1" x 6-3/4"	2 ea.
66303	Hair Pin, HP-7	1 pkg. of 25	96300	Hair Pin Dynapak - 10 x 66300	2 ea.
66304	Hair Pin, HP-8	1 pkg. of 25	96301	Hair Pin Dynapak - 10 x 66301	2 ea.
66305	Hair Pin, HP-9	1 pkg. of 25	96302	Hair Pin Dynapak - 4 x 66302	2 ea.
66306	Hair Pin, HP-11	1 pkg. of 25	96303	Hair Pin Dynapak - 10 x 66303	2 ea.
66308	Hair Pin, HP-19	1 pkg. of 10	96304	Hair Pin Dynapak - 5 x 66304	2 ea.
66326	Hair Pin, HP-10	1 pkg. of 25	96305	Hair Pin Dynapak - 5 x 66305	2 ea.
66450	Linch Pin, 3/16"	1 pkg. of 10	96306	Hair Pin Dynapak - 5 x 66306	2 ea.
66451	Linch Pin, 1/4"	1 pkg. of 10	96307	Hair Pin Dynapak - 10 x 66307	2 ea.
66452	Linch Pin, 5/16"	1 pkg. of 10	96450	Linch Pin Dynapak - 4 x 66450	2 ea.
66453	Linch Pin, 3/8"	1 pkg. of 10	96451	Linch Pin Dynapak - 4 x 66451	2 ea.
66454	Linch Pin, 7/16"	1 pkg. of 10	96460	Quick Pin Dynapak - 2 x 66460	2 ea.
66455	Linch Pin, 7/16"	1 pkg. of 10	96461	Quick Pin Dynapak - 2 x 66461	2 ea.
66460	Quick Pin, 1/4" x 1-3/8"	1 pkg. of 5	96464	Quick Pin Dynapak - 2 x 66464	2 ea.
66461	Quick Pin, 1/4" x 1-3/4"	1 pkg. of 5			
66462	Quick Pin, 1/4" x 2-1/2"	1 pkg. of 5			
66463	Quick Pin, 5/16" x 1-3/8"	1 pkg. of 5			
66464	Quick Pin, 5/16" x 1-3/4"	1 pkg. of 5			
66465	Quick Pin, 5/16" x 2-1/2"	1 pkg. of 5			
66466	Quick Pin, 3/8" x 1-3/8"	1 pkg. of 5			
66467	Quick Pin, 3/8" x 2-1/4"	1 pkg. of 5			
66468	Quick Pin, 3/8" x 2-1/2"	1 pkg. of 5			
66470	Safety Pin, 1/8"	1 pkg. of 10			



Plan-O-Grams do not include gondola or shelves. Products may not be exactly as illustrated.

Merchandisers

Farm Hardware Merchandisers



Grade 8 Hitch Pins Merchandiser

PART#	CONTENTS
00439	Grade 8 Hitch Pins Display Board Only , 24" x 24"
00439K	Full Grade 8 Hitch Pins Merchandiser. Includes 00439 display board and 22 pegs (80004) and the products listed below:

PART#	DESCRIPTION	QTY.
66860	1/2" x 3-5/8"	2 ea.
66861	5/8" x 4"	2 ea.
66862	5/8" x 6"	2 ea.
66863	3/4" x 4"	2 ea.
66864	3/4" x 6-1/2"	2 ea.
66865	7/8" x 4-1/4"	2 ea.
66866	7/8" x 6-1/2"	2 ea.
66867	1" x 4-3/4"	2 ea.
66868	1" x 7"	2 ea.
66869	1-1/8" x 7"	2 ea.
66870	1-1/4" x 7"	1 ea.



E-Grip & Forged Steel Hitch Pins Merchandiser

PART#	CONTENTS
00441	E-Grip & Forged Steel Hitch Pins Display Board Only , 24" x 24"
00441K	Full E-Grip & Forged Steel Hitch Pins Merchandiser. Includes 00441 display board and 22 pegs (80004) and the products listed below:

PART#	DESCRIPTION	QTY.
66872	1/2" x 3-1/2"	2 ea.
66873	5/8" x 3-3/4"	2 ea.
66874	3/4" x 4"	2 ea.
66875	5/8" x 6"	2 ea.
66876	3/4" x 6-1/4"	2 ea.
66877	7/8" x 6-1/2"	2 ea.
66878	1" x 6-3/4"	2 ea.
66882	1-1/8" x 7"	1 ea.
66883	1-1/4" x 7"	1 ea.



Plan-O-Grams do not include gondola or shelves. Products may not be exactly as illustrated.



Merchandisers





Hitch Pins Merchandiser

PART#	CONTENTS
-------	----------

00435 Hitch Pins **Display Board Only**, 24" x 24"

Full Hitch Pins Merchandiser.

00435K Includes 00435 display board and 23 pegs (80004) and the products listed below:

PART#	DESCRIPTION	QTY.
66250	3/8" x 3"	2 ea.
66251	1/2" x 3-5/8"	2 ea.
66252	5/8" x 4"	2 ea.
66253	3/4" x 4-1/2"	2 ea.
66254	7/8" x 4-1/2"	2 ea.
66255	1" x 4-1/2"	2 ea.
66256	5/8" x 5-1/2"	2 ea.
66257	3/4" x 6-1/2"	2 ea.
66258	7/8" x 6-1/2"	2 ea.
66259	1" x 7-1/2"	2 ea.
66260	1-1/8" x 8-1/2"	1 ea.
66261	1-1/4" x 8-1/2"	1 ea.



Hitch Pins (Fold Over Handle with Chain) Merchandiser

PART#	CONTENTS
-------	----------

00436 Hitch Pins (FOH) **Display Board Only**, 24" x 24"

"Fold Over Handle" Full Hitch Pins Merchandiser.

00436K Includes 00436 display board and 9 pegs (80004) and the products listed below:

PART#	DESCRIPTION	QTY.
66280	1/2" x 4-1/4"	2 ea.
66281	5/8" x 4-1/4"	2 ea.
66282	5/8" x 6-1/4"	2 ea.
66283	3/4" x 4-1/4"	2 ea.
66284	3/4" x 6-1/4"	2 ea.
66285	7/8" x 6-1/4"	2 ea.
66286	1" x 6-1/4"	2 ea.
66287	1-1/8" x 6-1/4"	2 ea.
66288	1-1/4" x 6-1/4"	2 ea.



Plan-O-Grams do not include gondola or shelves. Products may not be exactly as illustrated.



Merchandisers

Farm Hardware Merchandisers



Tractor Linkage Parts Merchandiser

PART#	CONTENTS
-------	----------

00438 Tractor Linkage **Display Board Only**, 12" x 24"

00438K **Full Tractor Linkage Parts Merchandiser.**
Includes 00438 display board and 26 pegs (80004) and the products listed below:

PART#	DESCRIPTION	CAT.	QTY.
66560	Top Link Pin, 3/4"	1	2 ea.
66561	Top Link Pin, 3/4"	1	2 ea.
66562	Top Link Pin, 1"	2	2 ea.
66565	Top Link Pin, 1"	2	2 ea.
66580	Lift Arm Pin, 7/8"	1	2 ea.
66581	Lift Arm Pin, 7/8"	1	2 ea.
66582	Lift Arm Pin, 7/8"	1	2 ea.
66583	Lift Arm Pin, 1-1/8"	1-2	2 ea.
66585	Lift Arm Pin, 1-1/8"	1-2	2 ea.
66587	Lift Arm Pin, 7/8"	2-1	2 ea.
66588	Lift Arm Pin, 1-1/8"	2	2 ea.
66590	Lift Arm Pin, 7/8"	1	2 ea.
66602	Top Link Bushing, 3/4"	1-2 Long	2 ea.
66604	Top Link Bushing, 1"	2-3	2 ea.
66608	Lift Arm Bushing, 7/8"	1-2	2 ea.
66610	Lift Arm Bushing, 1-1/8"	2-3	2 ea.
66612	Lift Arm Bushing, 1-1/8"	2-3 Long	2 ea.

Stroke Control Merchandiser

PART#	CONTENTS
-------	----------

00297 Stroke Control **Display Board Only**, 12" x 24"

00297K **Full Stroke Control Merchandiser.**
Includes 00297 display board and 17 pegs (80004) and the products listed below:

PART#	DESCRIPTION	QTY.
80004	Rod Rd - 1/4 x 6-1/2"	16
55003	Stroke Control 1-1/4 x 3/4	2 ea.
55004	Stroke Control 1-1/4 x 1	2 ea.
55005	Stroke Control 1-1/4 x 1-1/4	2 ea.
55006	Stroke Control 1-1/4 x 1-1/2	2 ea.
55007	Stroke Control 1-1/2 x 3/4	2 ea.
55008	Stroke Control 1-1/2 x 1	2 ea.
55009	Stroke Control 1-1/2 x 1-1/4	2 ea.
55010	Stroke Control 1-1/2 x 1-1/2	2 ea.
55011	Stroke Control 2 x 1	2 ea.
55012	Stroke Control 2 x 1-1/2	2 ea.
55013	Stroke Control 2 x 2	2 ea.
55014	Stroke Control 2 x 4-1/4	2 ea.
56006	Stroke Control 1/2 *	2 ea.
56010	Stroke Control 3/8 *	2 ea.
56011	Stroke Control 1/2 *	2 ea.

Plan-O-Grams do not include gondola or shelves. Products may not be exactly as illustrated.



Merchandisers





Weather Caps Merchandiser

PART#	CONTENTS
-------	----------

00226 Weather Caps **Display Board Only**, 24" x 24"

00226K Full Weather Caps Merchandiser. Includes 00226 display board and 26 pegs (80004) and the products listed below:

PART#	DESCRIPTION	QTY.
11200	1-1/2"	2 ea.
11201	1-3/4"	2 ea.
11202	2"	2 ea.
11203	2-1/4"	2 ea.
11204	2-1/2"	2 ea.
11205	2-3/4"	2 ea.
11206	3"	2 ea.
11207	3-1/2"	2 ea.
11208	4"	1 ea.
11209	4-1/2"	1 ea.
11210	5"	1 ea.



Farm packs Merchandiser

PART#	CONTENTS
-------	----------

00620 Farm Packs **Display Board Only**, 24" x 24"

00620K Full Farm Packs Merchandiser. Includes 00620 display board and 37 pegs (80004) and the products listed below:

PART#	DESCRIPTION	QTY.	PART#	DESCRIPTION	QTY.
92500	Clevis Pin Dynapak	4 pkgs.	96463	Quick Pin Dynapak, 1-3/8"	4 pkgs.
92502	Clevis Pin Dynapak	4 pkgs.	96464	Quick Pin Dynapak, 1-3/4"	4 pkgs.
92504	Clevis Pin Dynapak	4 pkgs.	96465	Quick Pin Dynapak, 2-1/2"	4 pkgs.
92509	Clevis Pin Dynapak	4 pkgs.	96466	Quick Pin Dynapak, 1-3/8"	4 pkgs.
92513	Clevis Pin Dynapak	4 pkgs.	96467	Quick Pin Dynapak, 2-1/4"	4 pkgs.
96300	Hair Pin Dynapak, 1/4"	4 pkgs.	96468	Quick Pin Dynapak, 2-1/2"	4 pkgs.
96301	Hair Pin Dynapak, 7/16"	4 pkgs.	96469	Quick Pin Dynapak, 3-1/8"	4 pkgs.
96302	Hair Pin Dynapak, 7/8"	4 pkgs.	97072	Cable Stop Dynapak	4 pkgs.
96303	Hair Pin Dynapak, 5/8"	4 pkgs.	97074	Cable Stop Dynapak	4 pkgs.
96304	Hair Pin Dynapak, 7/8"	4 pkgs.	97081	Ferrule Dynapak	4 pkgs.
96305	Hair Pin Dynapak, 3/4"	4 pkgs.	97082	Ferrule Dynapak	4 pkgs.
96306	Hair Pin Dynapak, 9/16"	4 pkgs.	97083	Ferrule Dynapak	4 pkgs.
96307	Hair Pin Dynapak, 1/2"	4 pkgs.	97084	Ferrule Dynapak	4 pkgs.
96308	Hair Pin Dynapak, 3/4"	4 pkgs.			
96311	Hair Pin Dynapak, 7/16"	4 pkgs.			
96450	Linch Pin Dynapak, 3/16"	4 pkgs.			
96451	Linch Pin Dynapak, 1/4"	4pkgs.			
96452	Linch Pin Dynapak, 5/16"	4 pkgs.			
96453	Linch Pin Dynapak, 3/8"	4 pkgs.			
96454	Linch Pin Dynapak, 7/16"	4 pkgs.			
96455	Linch Pin Dynapak, 7/16"	4 pkgs.			
96460	Quick Pin Dynapak, 1-3/8"	4 pkgs.			
96461	Quick Pin Dynapak, 1-3/4"	4 pkgs.			
96462	Quick Pin Dynapak, 2-1/2"	4 pkgs.			



Plan-O-Grams do not include gondola or shelves. Products may not be exactly as illustrated.



Merchandisers

Shop Supplies Merchandisers

Springs Merchandiser - Retail Packaged

PART#	CONTENTS
-------	----------

00242 Springs Display **Boards Only**. Includes two 24" x 24" full color boards.

00242K Full Springs Merchandiser. Includes 00242 display boards, 100 pegs (80004) and product listed below:

Extension Springs

PART#	REF#	QUANTITY	PART#	REF#	QUANTITY	PART#	REF#	QUANTITY
24001	C-1	2 pkg. of 2	24143	C-143	2 pkg. of 2	24243	C-243	2 pkg. of 2
24013	C-13	2 pkg. of 2	24155	C-155	2 pkg. of 2	24253	C-253	2 ea.
24019	C-19	2 pkg. of 2	24157	C-157	2 pkg. of 2	24259	C-259	2 pkg. of 2
24025	C-25	2 pkg. of 2	24161	C-161	2 pkg. of 2	24261	C-261	2 ea.
24029	C-29	2 pkg. of 2	24163	C-163	2 pkg. of 2	24265	C-265	2 ea.
24031	C-31	2 pkg. of 2	24165	C-165	2 pkg. of 2	24269	C-269	2 ea.
24033	C-33	2 pkg. of 2	24171	C-171	2 pkg. of 2	24277	C-277	2 ea.
24055	C-55	2 pkg. of 2	24173	C-173	2 pkg. of 2	24293	C-293	2 ea.
24069	C-69	2 pkg. of 2	24175	C-175	2 pkg. of 2	24303	C-303	2 ea.
24073	C-73	2 pkg. of 2	24177	C-177	2 pkg. of 2	24311	C-311	2 ea.
24077	C-77	2 pkg. of 2	24179	C-179	2 pkg. of 2	24313	C-313	2 ea.
24081	C-81	2 pkg. of 2	24181	C-181	2 pkg. of 2	24315	C-315	2 ea.
24083	C-83	2 pkg. of 2	24183	C-183	2 pkg. of 2	24319	C-319	2 ea.
24105	C-105	2 pkg. of 2	24187	C-187	2 pkg. of 2	24321	C-321	2 ea.
24115	C-115	2 pkg. of 2	24189	C-189	2 pkg. of 2	24323	C-323	2 ea.
24119	C-119	2 pkg. of 2	24215	C-215	2 pkg. of 2	24325	C-325	2 ea.
24131	C-131	2 pkg. of 2	24219	C-219	2 pkg. of 2	24329	C-329	2 ea.
24133	C-133	2 pkg. of 2	24231	C-231	2 pkg. of 2	24337	C-337	2 ea.
24135	C-135	2 pkg. of 2	24239	C-239	2 pkg. of 2	24339	C-339	2 ea.
24141	C-141	2 pkg. of 2						

Compression Springs

PART#	REF#	QUANTITY	PART#	REF#	QUANTITY	PART#	REF#	QUANTITY
24510	C-510	2 pkg. of 6	24660	C-660	2 pkg. of 4	24736	C-736	2 pkg. of 2
24516	C-516	2 pkg. of 6	24664	C-664	2 pkg. of 4	24742	C-742	2 pkg. of 2
24526	C-526	2 pkg. of 6	24668	C-668	2 pkg. of 4	24756	C-756	2 pkg. of 2
24566	C-566	2 pkg. of 6	24672	C-672	2 pkg. of 4	24766	C-766	2 pkg. of 2
24580	C-580	2 pkg. of 6	24676	C-676	2 pkg. of 4	24782	C-782	2 pkg. of 2
24582	C-582	2 pkg. of 6	24680	C-680	2 pkg. of 4	24792	C-792	2 pkg. of 2
24608	C-608	2 pkg. of 4	24692	C-692	2 pkg. of 2	24822	C-822	2 pkg. of 2
24612	C-612	2 pkg. of 4	24702	C-702	2 pkg. of 2	24826	C-826	2 pkg. of 2
24614	C-614	2 pkg. of 4	24704	C-704	2 pkg. of 2	24830	C-830	2 pkg. of 2
24624	C-624	2 pkg. of 4	24706	C-706	2 pkg. of 2	24832	C-832	2 pkg. of 2
24632	C-632	2 pkg. of 4	24712	C-712	2 pkg. of 2	24836	C-836	2 pkg. of 2
24650	C-650	2 pkg. of 4	24730	C-730	2 pkg. of 2	24892	C-892	2 ea.
24652	C-652	2 pkg. of 4						



A

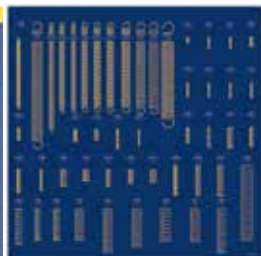

B



A



B

00024  **Compatible**

Plan-O-Grams do not include gondola or shelves. Products may not be exactly as illustrated.



Springs - Expanded Selection 1

PART#	CONTENTS
-------	----------

00244 Springs Display Board Only, 24" x 24"

00244K Full Springs Merchandiser Expansion 1 for 00242K. Includes 00242 display board, 34 pegs (80004) and products listed below:

Extension Springs

PART#	REF#	QUANTITY	PART#	REF#	QUANTITY
24139	C-139	1 pkg. of 2	24235	C-235	1 pkg. of 2
24185	C-185	1 pkg. of 2	24251	C-251	1 ea.
24191	C-191	1 pkg. of 2	24257	C-257	1 pkg. of 2
24193	C-193	1 pkg. of 2	24263	C-263	1 ea.
24221	C-221	1 pkg. of 2	24271	C-271	1 ea.
24223	C-223	1 pkg. of 2	24273	C-273	1 ea.
24227	C-227	1 pkg. of 2	24275	C-275	1 ea.
24233	C-233	1 pkg. of 2	24301	C-301	1 ea.

Compression Springs

PART#	REF#	QUANTITY	PART#	REF#	QUANTITY
24556	C-556	1 pkg. of 6	24802	C-802	1 ea.
24562	C-562	1 pkg. of 6	24806	C-806	1 ea.
24700	C-700	1 pkg. of 2	24814	C-814	1 ea.
24720	C-720	1 pkg. of 2	24838	C-818	1 pkg. of 2
24722	C-722	1 pkg. of 2	24850	C-850	1 pkg. of 2
24724	C-724	1 pkg. of 2	24856	C-856	1 pkg. of 2
24740	C-740	1 pkg. of 2	24858	C-858	1 pkg. of 2
24750	C-750	1 pkg. of 2	24864	C-864	1 ea.
24752	C-752	1 pkg. of 2	24874	C-874	1 ea.

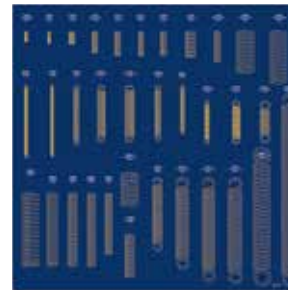

Springs - Expanded Selection 2

PART#	CONTENTS
-------	----------

00248 Springs Display Board Only, 24" x 24"

00248K Full Springs Merchandiser Expansion 2 for 00242K. Includes 00248 display board, 36 pegs (80004) and products listed below:

Extension Springs

PART#	REF#	QUANTITY	PART#	REF#	QUANTITY
00248	-	1 ea.	24209	C-209	1 ea.
24005	C-5	1 pkg. of 2	24267	C-267	1 ea.
24023	C-23	1 pkg. of 2	24281	C-281	1 ea.
24051	C-51	1 pkg. of 2	24285	C-285	1 ea.
24063	C-63	1 pkg. of 2	24287	C-287	1 ea.
24067	C-67	1 pkg. of 2	24289	C-289	1 ea.
24103	C-103	1 pkg. of 2	24307	C-307	1 ea.
24111	C-111	1 pkg. of 2	24317	C-317	1 ea.
24117	C-117	1 pkg. of 2	24333	C-333	1 ea.
24205	C-205	1 ea.			

Compression Springs

PART#	REF#	QUANTITY	PART#	REF#	QUANTITY
24500	C-500	2 pkg. of 6	24600	C-600	2 pkg. of 4
24520	C-520	2 pkg. of 6	24604	C-604	2 pkg. of 4
24530	C-530	2 pkg. of 6	24690	C-690	1 pkg. of 2
24532	C-532	2 pkg. of 6	24714	C-714	2 pkg. of 2
24550	C-550	2 pkg. of 6	24768	C-768	1 pkg. of 2
24554	C-554	2 pkg. of 6	24818	C-818	1 pkg. of 2
24570	C-570	2 pkg. of 6	24834	C-834	1 pkg. of 2
24576	C-576	2 pkg. of 6	24878	C-878	1 ea.
24578	C-578	2 pkg. of 6	24900	4001	1 ea.

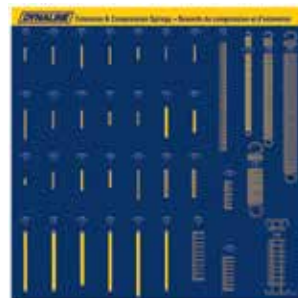

Plan-O-Grams do not include gondola or shelves. Products may not be exactly as illustrated.

Merchandisers

Shop Supplies Merchandisers

Retainer Rings Merchandiser

PART#	CONTENTS
00245	Retainer Rings Display Board Only , 24" x 24"
00245K	Full Retainer Rings Merchandiser. Includes 00245 display board, cornice hooks (65043) and products listed below:



Reference Chart Available
See end of catalogue



PART#	DESCRIPTION	REF. #	QUANTITY	PART#	DESCRIPTION	REF. #	QUANTITY
22861	"E" type, 3/16"	R1000-018	1 pkg. of 10	22891	Int., 1-1/4"	R3000-125	1 pkg. of 10
22862	"E" type, 1/4"	R1000-025	1 pkg. of 10	22892	Int., 1-5/16"	R3000-131	1 pkg. of 10
22863	"E" type, 5/16"	R1000-031	1 pkg. of 10	22893	Int., 1-3/8"	R3000-137	1 pkg. of 10
22864	"E" type, 3/8"	R1000-037	1 pkg. of 10	22894	Int., 1-7/16"	R3000-143	1 pkg. of 10
22865	"E" type, 7/16"	R1000-043	1 pkg. of 10	22895	Int., 1-1/2"	R3000-150	1 pkg. of 10
22866	"E" type, 1/2"	R1000-050	1 pkg. of 10	22896	Int., 1-9/16"	R3000-156	1 pkg. of 10
22867	"E" type, 5/8"	R1000-062	1 pkg. of 10	22897	Int., 1-5/8"	R3000-162	1 pkg. of 10
22868	"E" type, 3/4"	R1000-075	1 pkg. of 10	22900	Int., 1-3/4"	R3000-175	1 pkg. of 10
22869	"E" type, 7/8"	R1000-087	1 pkg. of 10	22901	Int., 1-13/16"	R3000-181	1 pkg. of 10
22870	"E" type, 63/64"	R1000-098	1 pkg. of 10	22902	Int., 1-7/8"	R3000-187	1 pkg. of 10
22871	"E" type, 1-3/16"	R1000-118	1 pkg. of 10	22903	Int., 1-15/16"	R3000-193	1 pkg. of 10
22872	"E" type, 1-3/8"	R1000-137	1 pkg. of 10	22904	Int., 2"	R3000-200	1 pkg. of 10
22873	Int., 1/4"	R3000-025	1 pkg. of 10	22905	Int., 2-1/16"	R3000-206	1 pkg. of 5
22874	Int., 5/16"	R3000-031	1 pkg. of 10	22906	Int., 2-1/8"	R3000-212	1 pkg. of 5
22875	Int., 3/8"	R3000-037	1 pkg. of 10	22907	Int., 2-1/4"	R3000-225	1 pkg. of 5
22876	Int., 7/16"	R3000-043	1 pkg. of 10	22908	Int., 2-3/8"	R3000-237	1 pkg. of 5
22878	Int., 1/2"	R3000-050	1 pkg. of 10	22909	Int., 2-7/16"	R3000-244	1 pkg. of 5
22879	Int., 9/16"	R3000-056	1 pkg. of 10	22910	Int., 2-1/2"	R3000-250	1 pkg. of 5
22880	Int., 5/8"	R3000-062	1 pkg. of 10	22912	Int., 2-11/16"	R3000-268	1 pkg. of 5
22881	Int., 11/16"	R3000-068	1 pkg. of 10	22913	Int., 2-3/4"	R3000-275	1 pkg. of 5
22882	Int., 3/4"	R3000-075	1 pkg. of 10	22914	Int., 2-13/16"	R3000-281	1 pkg. of 5
22884	Int., 7/8"	R3000-087	1 pkg. of 10	22916	Int., 3"	R3000-300	1 pkg. of 2
22885	Int., 15/16"	R3000-093	1 pkg. of 10	22926	Ext., 5/16"	R3100-031	1 pkg. of 10
22886	Int., 1"	R3000-100	1 pkg. of 10	22928	Ext., 3/8"	R3100-037	1 pkg. of 10
22888	Int., 1-1/16"	R3000-106	1 pkg. of 10	22929	Ext., 7/16"	R3100-043	1 pkg. of 10
22889	Int., 1-1/8"	R3000-112	1 pkg. of 10	22931	Ext., 1/2"	R3100-050	1 pkg. of 10
22890	Int., 1-3/16"	R3000-118	1 pkg. of 10	22932	Ext., 9/16"	R3100-056	1 pkg. of 10

Plan-O-Grams do not include gondola or shelves. Products may not be exactly as illustrated.





Retainer Rings Cont...

PART#	DESCRIPTION	REF. #	QUANTITY	PART#	DESCRIPTION	REF. #	QUANTITY
22933	Ext., 19/32"	R3100-059	1 pkg. of 10	22952	Ext., 1-9/16"	R3100-156	1 pkg. of 10
22934	Ext., 5/8"	R3100-062	1 pkg. of 10	22953	Ext., 1-5/8"	R3100-162	1 pkg. of 10
22935	Ext., 5/8"	R3100-066	1 pkg. of 10	22954	Ext., 1-11/16"	R3100-168	1 pkg. of 10
22936	Ext., 11/16"	R3100-068	1 pkg. of 10	22955	Ext., 1-3/4"	R3100-175	1 pkg. of 10
22937	Ext., 3/4"	R3100-075	1 pkg. of 10	22956	Ext., 1-7/8"	R3100-187	1 pkg. of 10
22938	Ext., 13/16"	R3100-081	1 pkg. of 10	22957	Ext., 1-31/32"	R3100-196	1 pkg. of 10
22939	Ext., 7/8"	R3100-087	1 pkg. of 10	22958	Ext., 2"	R3100-200	1 pkg. of 10
22940	Ext., 15/16"	R3100-093	1 pkg. of 10	22960	Ext., 2-1/8"	R3100-212	1 pkg. of 5
22942	Ext., 1"	R3100-100	1 pkg. of 10	22962	Ext., 2-1/4"	R3100-225	1 pkg. of 5
22944	Ext., 1-1/16"	R3100-106	1 pkg. of 10	22963	Ext., 2-3/8"	R3100-237	1 pkg. of 5
22945	Ext., 1-1/8"	R3100-112	1 pkg. of 10	22964	Ext., 2-7/16"	R3100-243	1 pkg. of 5
22946	Ext., 1-3/16"	R3100-118	1 pkg. of 10	22965	Ext., 2-1/2"	R3100-250	1 pkg. of 5
22947	Ext., 1-1/4"	R3100-125	1 pkg. of 10	22966	Ext., 2-5/8"	R3100-262	1 pkg. of 5
22948	Ext., 1-5/16"	R3100-131	1 pkg. of 10	22967	Ext., 2-3/4"	R3100-275	1 pkg. of 2
22949	Ext., 1-3/8"	R3100-137	1 pkg. of 10	22968	Ext., 2-7/8"	R3100-287	1 pkg. of 2
22950	Ext., 1-7/16"	R3100-143	1 pkg. of 10	22970	Ext., 3"	R3100-300	1 pkg. of 2
22951	Ext., 1-1/2"	R3100-150	1 pkg. of 10				

Machinery Bushings Merchandiser

PART#	CONTENTS
00235	Machinery Bushings Display Board Only , 12" x 24"
00235K	Full Machinery Bushings Merchandiser. Includes 00235 display board, 39 pegs (80004) and products listed below:

PART#	DESCRIPTION	QUANTITY	PART#	DESCRIPTION	QUANTITY
22700	M-16-L	1 pkg. of 10	22720	M-36-L	1 pkg. of 10
22701	M-18-L	1 pkg. of 10	22721	M-36-M	1 pkg. of 10
22702	M-18-M	1 pkg. of 10	22722	M-36-H	1 pkg. of 10
22703	M-20-L	1 pkg. of 10	22723	M-38-M	1 pkg. of 10
22704	M-20-M	1 pkg. of 10	22724	M-38-H	1 pkg. of 10
22705	M-20-H	1 pkg. of 10	22725	M-40-M	1 pkg. of 10
22706	M-22-L	1 pkg. of 10	22726	M-40-H	1 pkg. of 10
22707	M-22-M	1 pkg. of 10	22727	M-46-M	1 pkg. of 10
22708	M-24-L	1 pkg. of 10	22728	M-46-H	1 pkg. of 10
22709	M-24-M	1 pkg. of 10	22729	M-48-M	1 pkg. of 10
22710	M-24-H	1 pkg. of 10	22730	M-48-H	1 pkg. of 10
22711	M-28-L	1 pkg. of 10	22731	M-50-M	1 pkg. of 10
22712	M-28-M	1 pkg. of 10	22732	M-50-H	1 pkg. of 10
22713	M-28-H	1 pkg. of 10	22733	M-52-M	1 pkg. of 10
22714	M-30-L	1 pkg. of 10	22734	M-52-H	1 pkg. of 10
22715	M-30-M	1 pkg. of 10	22735	M-54-M	1 pkg. of 10
22716	M-30-H	1 pkg. of 10	22736	M-54-H	1 pkg. of 10
22717	M-34-L	1 pkg. of 10	22737	M-56-M	1 pkg. of 10
22718	M-34-M	1 pkg. of 10	22738	M-56-H	1 pkg. of 10
22719	M-34-H	1 pkg. of 10			



Reference Chart Available

See end of catalogue

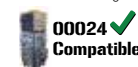

Plan-O-Grams do not include gondola or shelves. Products may not be exactly as illustrated.

Merchandisers

Shop Supplies Merchandisers

Retainer Rings Tilt Bins Merchandiser

PART#	CONTENTS
-------	----------

00746K

Full Retainer Rings Tilt Bin Merchandiser. Dimensions: 23-5/8" x 2-1/2" x 26-1/2"

Includes Tilt Bins and assembly hardware and the products listed below:

PART#	DESCRIPTION	QTY.
22860	R1000-012	1 pkg. of 10
22861	R1000-018	1 pkg. of 10
22862	R1000-025	1 pkg. of 10
22863	R1000-031	1 pkg. of 10
22864	R1000-037	1 pkg. of 10
22865	R1000-043	1 pkg. of 10
22866	R1000-050	1 pkg. of 10
22867	R1000-062	1 pkg. of 10
22868	R1000-075	1 pkg. of 10
22869	R1000-087	1 pkg. of 10
22870	R1000-098	1 pkg. of 10
22873	R3000-025	1 pkg. of 10
22874	R3000-031	1 pkg. of 10
22875	R3000-037	1 pkg. of 10
22876	R3000-043	1 pkg. of 10
22878	R3000-050	1 pkg. of 10
22879	R3000-056	1 pkg. of 10
22880	R3000-062	1 pkg. of 10
22881	R3000-068	1 pkg. of 10
22882	R3000-075	1 pkg. of 10
22884	R3000-087	1 pkg. of 10
22886	R3000-100	1 pkg. of 10
22888	R3000-106	1 pkg. of 10
22889	R3000-112	1 pkg. of 10
22893	R3000-137	1 pkg. of 10
22895	R3000-150	1 pkg. of 10
22896	R3000-156	1 pkg. of 10
22897	R3000-162	1 pkg. of 10
22900	R3000-175	1 pkg. of 10
22901	R3000-181	1 pkg. of 10
22903	R3000-193	1 pkg. of 10
22904	R3000-200	1 pkg. of 10
22906	R3000-212	1 pkg. of 5
22907	R3000-225	1 pkg. of 5
22924	R3100-018	1 pkg. of 10
22925	R3100-025	1 pkg. of 10
22926	R3100-031	1 pkg. of 10
22928	R3100-037	1 pkg. of 10
22929	R3100-043	1 pkg. of 10
22931	R3100-050	1 pkg. of 10
22932	R3100-056	1 pkg. of 10



Reference Chart Available

See end of catalogue

For empty tilt bins, see the end of this merchandiser section.

PART#	DESCRIPTION	QTY.
22933	R3100-059	1 pkg. of 10
22934	R3100-062	1 pkg. of 10
22936	R3100-068	1 pkg. of 10
22937	R3100-075	1 pkg. of 10
22938	R3100-081	1 pkg. of 10
22939	R3100-087	1 pkg. of 10
22940	R3100-093	1 pkg. of 10
22942	R3100-100	1 pkg. of 10
22944	R3100-106	1 pkg. of 10
22945	R3100-112	1 pkg. of 10
22946	R3100-118	1 pkg. of 10
22947	R3100-125	1 pkg. of 10
22948	R3100-131	1 pkg. of 10
22949	R3100-137	1 pkg. of 10
22950	R3100-143	1 pkg. of 10
22951	R3100-150	1 pkg. of 10
22952	R3100-156	1 pkg. of 10
22953	R3100-162	1 pkg. of 10
22954	R3100-168	1 pkg. of 10
22955	R3100-175	1 pkg. of 10
22956	R3100-187	1 pkg. of 10
22958	R3100-200	1 pkg. of 10
22965	R3100-250	1 pkg. of 5
TF308	Tilt Bin 8 Comp.	8 ea.

Plan-O-Grams do not include gondola or shelves. Products may not be exactly as illustrated.



Merchandisers





Springs Merchandiser - Bulk Springs Cabinet

PART#	CONTENTS
00243	Bulk Springs Display 24" x 24" Photo Board Only (features actual size photos)
00243K	Full Bulk Springs Assortment Merchandiser. 900 pieces. Also includes cabinet, 4 drawers and 00243 Photo Display Board, 24" x 24".
00243C	Cabinet Only. Cabinet size is 20" wide x 14-1/2" high x 15-3/4" deep.



Easy to match photo board which shows springs at actual size.



- Drawers with lids easily pull open
- Bulk Springs Merchandisers take up less space than packaged springs
- Cabinet holds 100 types of springs

Complete listing of BULK SPRINGS in the Shop Supplies Section of this catalogue

Keystock

PART#	CONTENTS
00285	Keystock Bin only. 8 compartments, made of durable blue plastic Dimensions: 10" x 9-1/8" x 1-1/2"



PART#	CONTENTS
00255K	Full Square Keystock Merchandiser. 30 pieces, 12" long / 6 part #'s. Includes 00285 Keystock Bin.

PART#	DESCRIPTION	QTY.	PART#	DESCRIPTION	QTY.
22750	1/8"	1 pkg. of 5	22754	3/8"	1 pkg. of 5
22751	3/16"	1 pkg. of 5	22755	7/16"	1 pkg. of 5
22752	1/4"	1 pkg. of 5	22756	1/2"	1 pkg. of 5
22753	5/16"	1 pkg. of 5	22758	5/8"	1 pkg. of 2



PART#	CONTENTS
00265K	Full Rectangular Keystock Merchandiser. 37 pieces, 12" long / 8 part #'s. Includes 00285 Keystock Bin.

PART#	DESCRIPTION	QTY.	PART#	DESCRIPTION	QTY.
22782	3/16" x 1/4"	1 pkg. of 5	22791	3/8" x 7/16"	1 pkg. of 5
22785	1/4" x 5/16"	1 pkg. of 5	22792	3/8" x 1/2"	1 pkg. of 5
22786	1/4" x 3/8"	1 pkg. of 5	22795	7/16" x 1/2"	1 pkg. of 5
22789	5/16" x 3/8"	1 pkg. of 5	22796	1/2" x 5/8"	1 pkg. of 2



PART#	CONTENTS
00275K	Full Step Keystock Merchandiser. 16 pieces, 12" long / 8 part #'s. Includes 00285 Keystock Bin

PART#	DESCRIPTION	QTY.	PART#	DESCRIPTION	QTY.
22821	3/16" x 1/4"	1 pkg. of 2	22825	3/8" x 7/16"	1 pkg. of 2
22822	1/4" x 5/16"	1 pkg. of 2	22826	3/8" x 1/2"	1 pkg. of 2
22823	1/4" x 3/8"	1 pkg. of 2	22827	7/16" x 1/2"	1 pkg. of 2
22824	5/16" x 3/8"	1 pkg. of 2	22828	1/2" x 5/8"	1 pkg. of 2



Plan-O-Grams do not include gondola or shelves. Products may not be exactly as illustrated.



Merchandisers

Shop Supplies Merchandisers

Caster Wheels Plan-O-Gram

PART#	CONTENTS
-------	----------

00300K Full Caster Wheels Plan-O-Gram.
Includes header, and products listed below.

PART#	DESCRIPTION	QTY.
31015	Rigid top plate 1-1/2"	12 ea.
31020	Rigid top plate 2"	12 ea.
31025	Rigid top plate 2-1/2"	8 ea.
31030	Rigid top plate 3"	8 ea.
31040	Rigid top plate 4"	4 ea.
31050	Rigid top plate 5"	4 ea.
31060	Rigid top plate 6"	4 ea.
31080	Rigid top plate 8"	4 ea.
32015	Swivel wheel 1-1/2"	12 ea.
32020	Swivel wheel 2"	12 ea.
32025	Swivel wheel 2-1/2"	8 ea.
32030	Swivel wheel 3"	8 ea.
32040	Swivel wheel 4"	4 ea.
32050	Swivel wheel 5"	4 ea.
32060	Swivel wheel 6"	4 ea.
32080	Swivel wheel 8"	4 ea.
33015	Swivel with side locking brake 1-1/2"	12 ea.
33020	Swivel with side locking brake 2"	12 ea.
33025	Swivel with side locking brake 2-1/2"	8 ea.
33030	Swivel with side locking brake 3"	8 ea.
33040	Swivel with side locking brake 4"	4 ea.
33050	Swivel with side locking brake 5"	4 ea.



(Gondola not included)

PART#	DESCRIPTION	QTY.
33060	Swivel with side locking brake 6"	4 ea.
33080	Swivel with side locking brake 8"	4 ea.
31100	Pneumatic Caster Wheel fixed 10"	2 ea.
31101	Pneumatic Caster Wheel with swivel 10"	2 ea.
31102	Flat Free Caster Wheel fixed 10"	2 ea.
31103	Flat Free Caster Swivel wheel 10"	2 ea.
HB2035	Storage Bin	6 ea.
HB2045	Storage Bin	6 ea.
HB3045	Storage Bin	12 ea.

Small Wheel Rack Merchandiser

PART#	CONTENTS
-------	----------

80103 Freestanding Wheel **Rack Only**, 21"x 21"(footprint) x 72"(tall).

80103K Full Wheel Rack Merchandiser. An assortment of pneumatic and flat free wheels on this space saving wheel rack. All metal with black enamel painted finish. Includes: 10" x 3" Dynaline "Replacement Wheels" decal, all products below:

PART#	DESCRIPTION	QTY.
80103	Small Wheel Rack	1 ea.
80101	Pneumatic Wheel - 8.5"-2.50 R4	2 ea.
80102	Flat Free Wheel - 8.5"-2.50 R4	2 ea.
80105	Pneumatic Hand Truck Wheel, 10.18"	2 ea.
80107	Flat Free Hand Truck Wheel, 10.18"	2 ea.
80109	Pneumatic Outdoor Hand Truck Wheel, 10.08"	2 ea.
80111	Flat Free Outdoor Hand Truck Wheel, 10.23"	2 ea.
80113	Pneumatic H.D. Hand Truck Wheel, 12.25"	2 ea.
80115	Flat Free H.D. Hand Truck Wheel, 13"	2 ea.
80116	Pneumatic Wheel Barrow Wheel, 15.08"	2 ea.
80118	Flat Free Wheel Barrow Wheel, 15.3"	2 ea.



Plan-O-Grams do not include gondola or shelves. Products may not be exactly as illustrated.



Merchandisers





Castor & Assorted Wheels Merchandiser

PART#	CONTENTS
00302K	Full Caster & Assorted Wheels Plan-O-Gram. Includes header, and products listed below.

PART#	DESCRIPTION	QTY.
31015	Fixed Caster 1-1/2"	16
31020	Fixed Caster 2"	16
31025	Fixed Caster 2-1/2"	8
31030	Fixed Caster 3"	6
31040	Fixed Caster 4"	8
31050	Fixed Caster 5"	6
31060	Fixed Caster 6"	5
31080	Fixed Caster 8"	4
33015	Swivel Caster-Brake 1-1/2"	16
33020	Swivel Caster-Brake 2"	16
33025	Swivel Caster-Brake 2-1/2"	8
33030	Swivel Caster-Brake 3"	6
33040	Swivel Caster-Brake 4"	8
33050	Swivel Caster-Brake 5"	6
33060	Swivel Caster-Brake 6"	5
33080	Swivel Caster-Brake 8"	4
80116	Pneumatic Barrow Wheel 15"	2
80105	Pneumatic Hand Truck Wheel 10"	5



(Gondola not included)

PART#	DESCRIPTION	QTY.
80109	Pneumatic Hand Truck Wheel 10"	5
80101	Pneumatic Cart Wheel 8.5"	5
80118	Flat Free Barrow Wheel 15"	2
80107	Flat Free Hand Truck Wheel 10"	5
80111	Flat Free Hand Truck Wheel 10"	5
80102	Flat Free Cart Wheel 8.5"	5
HB2045	Plastic Bin Blue	8
HB3045	Plastic Bin Blue	16

Wheel Merchandiser

PART#	CONTENTS
80100	Wheel Rack Only , 46" wide x 64" high x 24" deep
80100L	Backdrop and Labels only (44" x 12" header and rack labels)
80100K	Full Wheels Merchandiser. Includes 44" x 12" Dynaline "Wheels" Sign and labels (80100L) and the products listed below:

PART#	DESCRIPTION	QTY.
80101	Pneumatic Wheel - 10" -2.50 R4	2 ea.
80102	Flat Free Wheel - 10" -2.50 R4	3 ea.
80105	Pneumatic Hand Truck Wheel - 10" - 4.10/3.50 R4	2 ea.
80107	Flat Free Hand Truck Wheel - 10" - 4.10/3.50 R4	3 ea.
80109	Pneumatic Outdoor Hand Truck Wheel - 3.00 R4	2 ea.
80111	Flat Free Outdoor Hand Truck Wheel - 3.00 R4	3 ea.
80113	Pneumatic H.D. Hand Truck Wheel, 13x5 R6	2 ea.
80115	Flat Free H.D. Hand Truck Wheel, 13x5 R6	3 ea.
80116	Pneumatic Wheel Barrow Wheel, 4.80/4 R8	2 ea.
80118	Flat Free Wheel Barrow Wheel, 4.80/4 R8	2 ea.
80120	High Speed Trailer Wheel, 4.80 x 12	1 ea.
80124	High Speed Trailer Wheel, 5.30 x 12	2 ea.
80128	High Speed Trailer Wheel - ST205/75 D13	2 ea.
80130	High Speed Trailer Wheel - ST205/75 D14	1 ea.
80132	High Speed Trailer Wheel - ST205/75 D15	1 ea.



Plan-O-Grams do not include gondola or shelves. Products may not be exactly as illustrated.



Merchandisers

Boss Merchandisers



BOSS Padlock Merchandiser

PART#	CONTENTS	
00225	Padlock Display Board Only , 24" x 24"	
00225K	Full Padlock Merchandiser . Includes 00225 display board, 16 pegs (80004) and products listed below:	
PART#	DESCRIPTION	QTY.
2251525	Brass Padlock 25x14mm - KD	4 ea.
2251526	Brass Padlock 25x14mm - KA	4 ea.
2251530	Brass Padlock 30x20mm - KD	4ea.
2251531	Brass Padlock 30x20mm - KA	4 ea.
2251540	Brass Padlock 40x23mm - KD	4 ea.
2251541	Brass Padlock 40x23mm - KA	4 ea.
2251550	Brass Padlock 50x30mm - KD	4 ea.
2251551	Brass Padlock 50x30mm - KA	4 ea.
2251560	Brass Padlock 60x33mm - KD	4 ea.
2251561	Brass Padlock 60x33mm - KA	4 ea.
2251740	Brass Padlock 40x63mm - KD	4 ea.
2251840	Brass Padlock 40x100mm - KD	4 ea.
2251850	Brass Padlock 50x75mm - KD	4 ea.
2253540	Waterproof Padlock 40mm - KD	4 ea.
2253541	Waterproof Padlock 40mm - KD	4 ea.
2253554	Combination Padlock 50mm	1 ea.
00225	Padlock Board Only	1 ea.

KD = Keyed different KA = Keyed alike

BOSS Quality Cutters and Blades Merchandiser

PART#	CONTENTS	
77810	Padlock Display Board Only , 24" x 24"	
77810K	Full Padlock Merchandiser . Includes 77810 display board, 16 pegs (80004) and products listed below:	
PART#	DESCRIPTION	QTY.
2554403	Blade Heavy Duty 3/4"	6
2554404	Blade Single Edge	3
2554405	Blade Utility 2 notch	3
2554433	Blade Heavy Duty 3/4"	4
2555010	Samurai Blade Heavy Duty 3/4"	6
2555050	Samurai Blade Heavy Duty 3/4"	4
2560425	PKG - 3/4 Heavy Duty	2
2560430	6 Blade Auto Load 3/4'	3
2560488	PKG - Head Scraper	2
2563208	PKG - Scraper with Blade	3
2568068	Carded Auto Lock Cutter	2
556750	PKG - 3/4 Heavy Duty	3
556900	Mega Cutter 1" Knob	3
568687	PKG - 3/4 Heavy Duty	3
568688	Ergo Grip Knob Lock Cutter	3
77810	Blades & Cutters Display Board	1
80004	Rod Rd - 1/4 x 6-1/2"	19

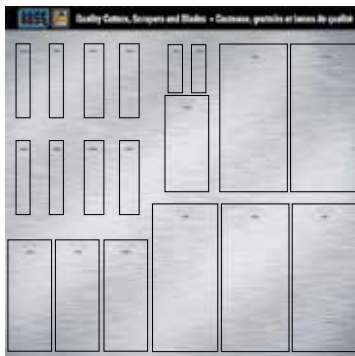

Plan-O-Grams do not include gondola or shelves. Products may not be exactly as illustrated.



Merchandisers



Drill Bit Display

PART#	CONTENTS
100811	Drill Bit Display Only . 27" x 18.5" x 17"
77890	Full Drill Bit Merchandiser . Includes 174 Pieces, display, labels and the products listed below:

PART NO.	DESCRIPTION	QUANTITY
851000	1/16" Grizzly Drill Bit 2/pack	6 ea.
851002	5/64" Grizzly Drill Bit 2/pack	6 ea.
851004	3/32" Grizzly Drill Bit 2/pack	6 ea.
851006	7/64" Grizzly Drill Bit 2/pack	6 ea.
851008	1/8" Grizzly Drill Bit 2/pack	6 ea.
851010	9/64" Grizzly Drill Bit	6 ea.
851012	5/32" Grizzly Drill Bit	6 ea.
851014	11/64" Grizzly Drill Bit	6 ea.
851016	3/16" Grizzly Drill Bit	6 ea.
851018	13/64" Grizzly Drill Bit	6 ea.
851020	7/32" Grizzly Drill Bit	6 ea.
851022	15/64" Grizzly Drill Bit	6 ea.
851024	1/4" Grizzly Drill Bit	6 ea.
851026	17/64" Grizzly Drill Bit	6 ea.
851028	9/32" Grizzly Drill Bit	6 ea.
851030	19/64" Grizzly Drill Bit	6 ea.
851032	5/16" Grizzly Drill Bit	6 ea.
851034	21/64" Grizzly Drill Bit	6 ea.
851036	11/32" Grizzly Drill Bit	6 ea.
851038	23/64" Grizzly Drill Bit	6 ea.
851040	3/8" Grizzly Drill Bit	6 ea.
851042	25/64" Grizzly Drill Bit	6 ea.
851044	13/32" Grizzly Drill Bit	6 ea.
851046	27/64" Grizzly Drill Bit	6 ea.
851048	7/16" Grizzly Drill Bit	6 ea.
851050	29/64" Grizzly Drill Bit	6 ea.
851052	15/32" Grizzly Drill Bit	6 ea.



PART NO.	DESCRIPTION	QUANTITY
851054	31/64" Grizzly Drill Bit	6 ea.
851056	1/2" Grizzly Drill Bit	6 ea.

FEATURES

GRIZZLY TIP

Grizzly Tip™ is exclusively available from BOSS. It has excellent self centering characteristics. The center split point starts the cutting with the two sides (tips of the flutes) following close behind it providing 4 cutting edges. This increases the speed and smoothness of the drill and hole.



SOLID CONSTRUCTION

M35 is a high speed steel in the tungsten molybdenum series with 5% cobalt added. The additional cobalt increase heat resistance. The carbides in it are small and evenly distributed. It has high wear resistance. After heat treatment, its hardness is the same as T1, but its bending strength can reach 4700 MPa. It's toughness and thermo plasticity are higher than T1 by 50%.



3 GROUND FLAT

The triangle shank is made by machining three flats on a round bar stock. It is intended as a minor modification of a straight shank, still allowing it to be held in a 3-jaw drill chuck, also allowing higher TORX transmission and limited slipping.



Plan-O-Grams do not include gondola or shelves. Products may not be exactly as illustrated.



Merchandisers

Boss Counter Top Merchandisers



Overtime Saw Blades

- C3 Carbide Tooth Circular Saw Blade
- C3 sub micro-grain FST grind
- Patented grind (40T cuts like 80T)
- Designed for cord or cordless saw
- Iwasaw Certified

PART#	TYPE
B54024	Samurai 7-1/4", 24 T Saw Blades (Pack of 10 - Counter top)
9B54024	Customized Samurai 7-1/4", 24 T Saw Blades (Pack of 10 - Counter top)



12mm Carpenter Pencils

12mm carpenter pencils are available in 4 colors and ship in a ready-to-display box for easy setup. Available for custom printing. See the Boss Section for more information on this product.

15mm Carpenter Pencils

15mm carpenter pencils are available in 7 colors and ship in a ready-to-display box for easy setup. Available for custom printing. See the Boss Section for more information.



Plastic Cutter, 3/4" Blade

Available in Multiple color options and arrives in easy to setup counter-top display. The customization options available make it the perfect item to provide your business with more exposure. See the Boss section for more information on this product.



Utility Grade - 6/Box

These Tape measures feature a nylon coated edge for maximum weather protection. The construction also features armor housing and two well positioned stops for easy use. Available for custom printing. For more information on this product see the Boss Section.

Professional Grade - 12/Box

These tape measures feature a nylon coated edge for maximum weather protection and a rubber coating for comfort and drop protection. This grade of tape measure also features a 30% thicker blade for long reach & durability. Tough, fast retracting spring system. Available for custom printing. For more information on this product see the Boss Section.



Fold-able Funnel

This mold-able funnel available in two sizes allows you shape the funnel to divert oil or fluids around engine parts. This innovative product is a must have for every garage.

PART#	SIZE
15009	9" x 4-3/4"
15014	14-1/2" x 6-1/2"

Plan-O-Grams do not include gondola or shelves. Products may not be exactly as illustrated.



Merchandisers





Dual Head Stubby Ratchet

PART#	DESCRIPTION	PACK
441802	1/4" and 3/8" driver head. Small size makes it great for mobility and those tight spaces.	12/Display Box*

*Sold individually. Display box available with purchase of 12 or more.



Stubby Claw Hammer

PART#	DESCRIPTION	PACK
441806	Small size makes it great for mobility and those tight spaces.	12/Display Box*

*Sold individually. Display box available with purchase of 12 or more.



Razor Folding Utility Cutter

Sturdy aluminum body in clamshell packaging for easy retail and restock

PART#	SHEATH/LOCK	POP DISPLAY	BOX/CASE
559110	Aluminum / Folding	Box of 12	12/48

*Sold individually. Display box available with purchase of 12 or more.



Cree LED 3W Focusing Light

PART#	DESCRIPTION	PACK
234439	3 W 3 x AAA Super Brite Cree LED. CREE Diode, push button, anodized aircraft aluminum body.	8/Display Box

*Sold individually. Display box available with purchase of 8 or more.



8 LED Light with Laser Pointer

PART#	DESCRIPTION	PACK
234440	8 LED with Laser Pointer 3 x AAA. Functions LED, laser and LED with laser.	8/Display Box

*Sold individually. Display box available with purchase of 8 or more.



Plan-O-Grams do not include gondola or shelves. Products may not be exactly as illustrated.



Merchandisers

Boss Counter Top Merchandisers



Counter-top BOSS Driver Bit Kit Display

- Gravity fed counter top point of purchase
- Compact design
- Contractor's choice
- Customizable kit tops

PART#	CONTENTS			
100854	Driver Bit Kit Display Only . Includes decals. (Bit Kits sold separately)			
	MAX. BIT KITS	LENGTH	WIDTH	HEIGHT
	13	7"	8"	15.5"

**THIS ITEM IS
CUSTOMIZABLE**



Does your business need more exposure? Product customization will help build your brand and boost your sales.

For more information on custom printing see Boss Tools & Accessories section or ask your local account manager.



Part# 721386

Part# 721374



Counter-top BOSS Compact Driver Bit Display

- #1 Acrylic Bit Display
- Magnetic 1/4" to 1/2"
- Robertson #1, #2, #3 from 2" to 6"
- Socket Adapters

PART#	CONTENTS			
100859	Driver Bit Kit Display Only . Includes decals.			
77799	Full Driver Bit Kit Merchandiser. Includes display, labels and 307 pieces			
	NO. PIECES	LENGTH	WIDTH	HEIGHT
	307	5"	7"	9"

Plan-O-Grams do not include gondola or shelves. Products may not be exactly as illustrated.

Paladin Work Light Merchandiser

PART#	CONTENTS
-------	----------

55100 LED Work Lights **Backdrop Only** (48" x 48")

55100K Full LED Work Lights Plan-o-gram. Includes 55100 backdrop, and product listed below:

PART NO.	DESCRIPTION	QUANTITY
55050	18W Portable LED Work Light	2 ea.
55051	30W LED Flood Work Light	2 ea.
55052	15W Work Light with Handle	2 ea.
55054	18W LED Work Light with Tripod	2 ea.
55055	36W LED Work Light with Tripod	2 ea.
55056	60W Work Light with Tripod	2 ea.
55080	2 in 1 Flashlight and Work Light	12 ea.
55081	Magnetic Base Work Light with Hook	2 ea.
55082	Pocket Work Light and Spotlight	12 ea.
55083	Magnetic Camping Light with Hook	12 ea.
55057	9W Magnet Base LED Work Light	2 ea.
55058	8W Magnet Base LED Work Light	2 ea.



2-in-1 COB Work Flashlight

PART#	DESCRIPTION	PACK
55080	Features hanging hook and high power magnetic base. Swivel head for directional use. Pull out head to reveal flood light on stem.	12/Display Box

**Sold individually. Display box available with purchase of 12 or more. Batteries not included.*



Pocket Work Light and Spot Light

PART#	DESCRIPTION	PACK
55082	Small compact size with powerful COB LED light for excellent illumination. Supports both Spot and flood light options.	12/Display Box

**Sold individually. Display box available with purchase of 12 or more. Batteries not included.*



Magnetic Utility Light with Hook

PART#	DESCRIPTION	PACK
55083	Magnetic base and swivel hanging hook for hands-free use Bright flood light design provides excellent illumination.	12/Display Box

**Sold individually. Display box available with purchase of 12 or more. Batteries not included.*



Plan-O-Grams do not include gondola or shelves. Products may not be exactly as illustrated.



Impulse Buy Black Table Products



ZERO RISK! Stock Protection Guarantee for 1 year! If it doesn't sell, we take it back.

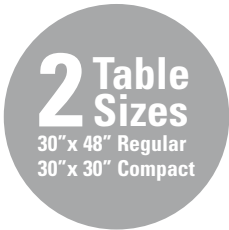

Merchandisers



Red Impulse Buy Table

The Tool Cache Red Impulse Buy Table is the perfect way to drive sales of those last minute purchases by your customers. The products in the red table are all sold at a low \$7.98 price point. The tables sizes are available in 48" x 30" and 30" x 30".

PART#	CONTENTS
WRC-4	Caster Wheels Only (Includes 4 casters)
WRD-3030	30" x 30" Double Wire Table Display Only
WRD-3048	48" x 30" Double Wire Table Display Only
51078-09	Red Table Sign Only (Bilingual)



Blue Impulse Buy Table

The Tool Cache Blue Impulse Buy Table is the perfect way to drive sales of those last minute purchases by your customers. The products in the red table are all sold at a low \$13.98 price point. The tables sizes are available in 48" x 30" and 30" x 30".

PART#	CONTENTS
WRC-4	Caster Wheels Only (Includes 4 casters)
WRD-3030	30" x 30" Double Wire Table Display Only
WRD-3048	48" x 30" Double Wire Table Display Only
51078-08	Blue Table Sign Only (Bilingual)



Black Impulse Buy Table

The Tool Cache Black Impulse Buy Table is the perfect way to drive sales of those last minute purchases by your customers. The products in the red table are all sold at a low \$19.98 price point. The tables sizes are available in 48" x 30" and 30" x 30".

PART#	CONTENTS
WRC-4	Caster Wheels Only (Includes 4 casters)
WRD-3030	30" x 30" Double Wire Table Display Only
WRD-3048	48" x 30" Double Wire Table Display Only
51078-22	Black Table Sign Only (Bilingual)

Plan-O-Grams do not include gondola or shelves. Products may not be exactly as illustrated.



Dynaline Custom Signs

PART#	CONTENTS
-------	----------

Call us! Custom Print Mounted on Corrugated Plastic material - up to 4' tall



Universal Display Boards

Create your own product selection. Simply position and drill the holes you need. Order 80004 pegs as required (sold separately). Two sizes available.

PART#	DESCRIPTION
00800	12" x 24"
00801	24" x 24"



Dynaline Custom Banner

PART#	CONTENTS
-------	----------

Call us! Custom Print on Banner Material - up to 8' long and 4' high



Plan-O-Grams do not include gondola or shelves. Products may not be exactly as illustrated.



Custom Bulk Bin Merchandising!

Dynaline strives to provide our customers with all the tools you need to be successful. Our custom bulk bin merchandising program allows you to customize the products specific to your local market. With your cooperation, our account managers will sit down with you and quickly determine what products and categories are the most popular in your business and can provide a merchandiser featuring all the fastest moving products in one simple display. Contact your local account manager for more information on this valuable program.

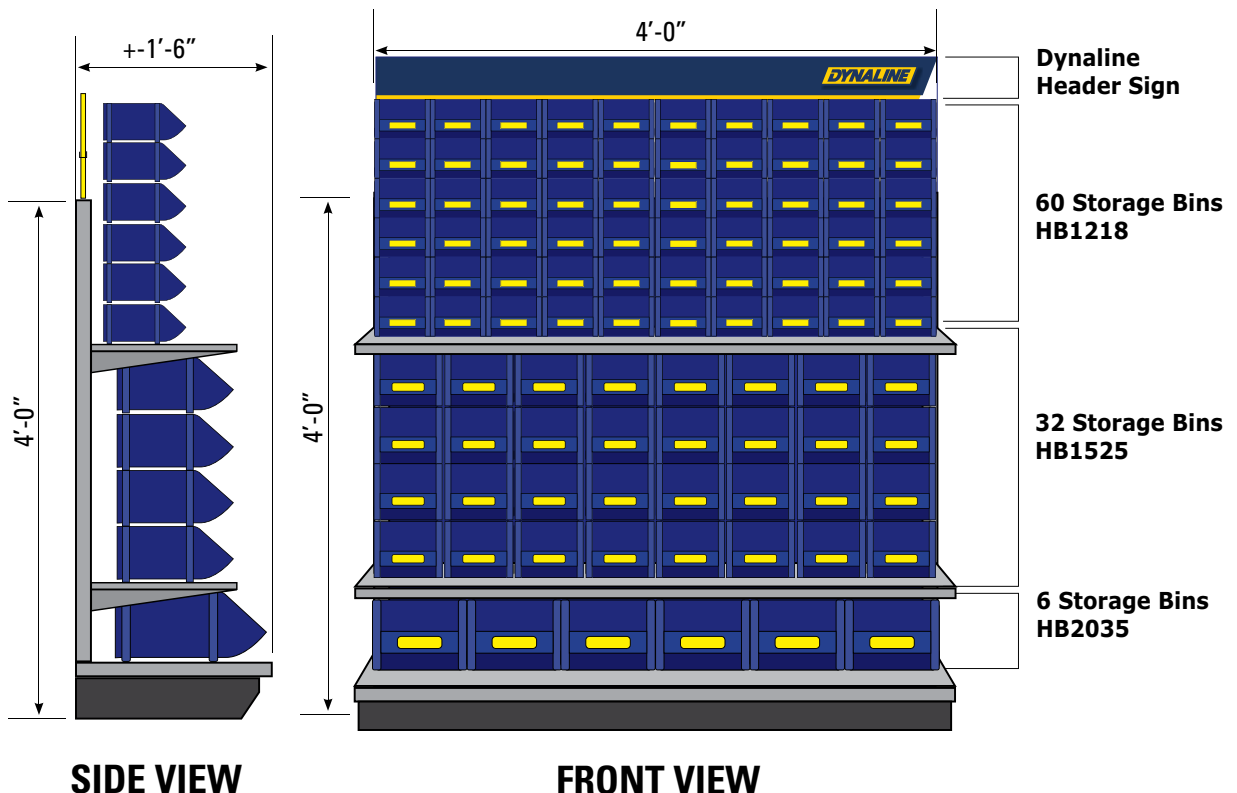
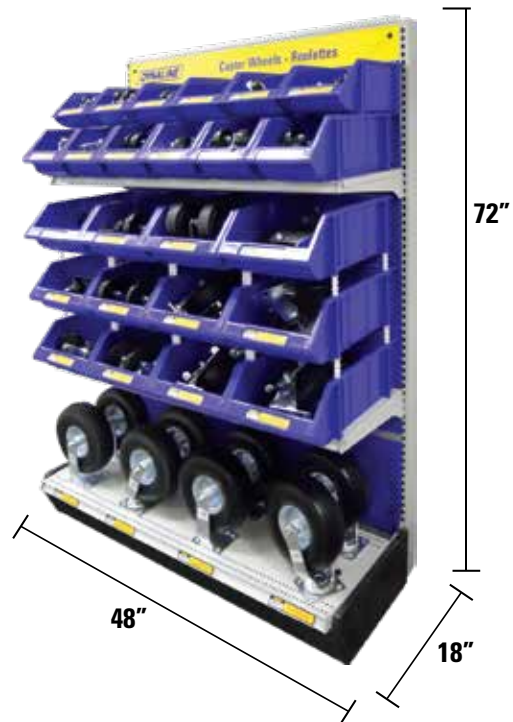

Plan-O-Grams do not include gondola or shelves. Products may not be exactly as illustrated.



Custom Bulk Bin Features



Once a product category or layout is determined, Dynaline will assemble your custom merchandiser and determine how many products it will need. We offer multiple bin sizes to ensure all your product will fit and look presentable to your valued customers.

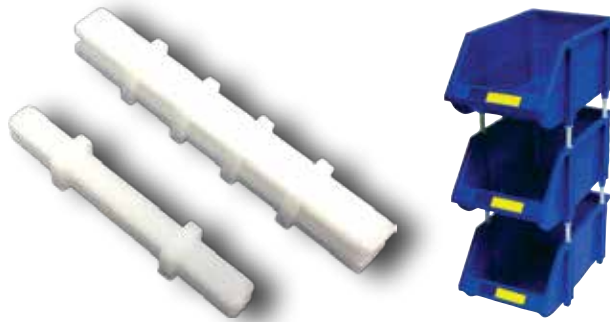

We will ship all the bins you need including riser pins so your customers have easy access to your products. All bins sizes have corresponding risers so you aren't limited in your selection.

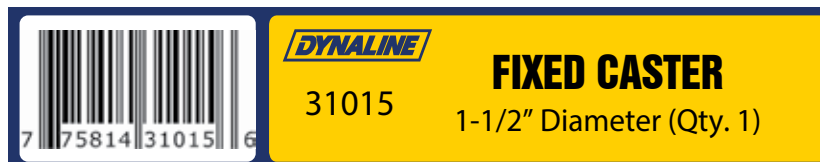

Dynaline will print out any labels you need for your custom merchandiser. We will also print merchandiser headers for your display giving your customers confidence that the products you offer are provided by the trusted Dynaline brand.

Merchandisers

Empty Product Storage Solutions



Merchandisers



Tilt Bins

- Easy multi-purpose storage solution.
- Functional design allows them to be stacked, screwed to a wall, or attached to a display unit.
- Sections interlock to form a rigid storage solution.
- Supplied with fastening screws and pegs.

PART#	DESCRIPTION			
TF306	6 Compartments Tilt Bin (3 wide & 2 high)			
	Width	Depth	Height	Weight Capacity
	11-13/16"	3-5/8"	9"	15 kg
TF308	8 Compartments Tilt Bin (4 wide & 2 high)			
	Width	Depth	Height	Weight Cap.
	11-13/16"	2-1/2"	6-5/8"	15 kg
TF604	4 Compartments Tilt Bin (4 wide)			
	Width	Depth	Height	Weight Cap.
	23-5/8"	6-5/8"	8-3/16"	30 kg
TF605	5 Compartments Tilt Bin (5 wide)			
	Width	Depth	Height	Weight Cap.
	23-5/8"	5-1/4"	6-1/2"	20 kg



Dynaline Bin Box

PART#	DESCRIPTION
00007	A great way to organize small parts Corrugated cardboard box with dividers. Dimensions: 11-11/16"L x 4-7/8"W x 3-13/16"H



Storage Bins

Durable, open, stackable design as well as side by side. Supplied with stacking pegs and labels.

PART#	LENGTH	WIDTH	HEIGHT	WEIGHT CAP.	CARTON QTY.
HB1218	7-1/16"	4-3/4"	3-5/16"	3 kg	60
HB1525	10"	5-7/8"	4-3/4"	6 kg	36
HB2035	13-3/4"	8-1/16"	5-7/8"	20 kg	16
HB2045	18-7/8"	7-7/8"	7"	30 kg	12
HB3045	18-7/8"	11-3/4"	7"	50 kg	12

Plan-O-Grams do not include gondola or shelves. Products may not be exactly as illustrated.



Paladin Lighting



Merchandisers
LED Light bars / Off road lights
Work-site lights
Utility lights
Hand-held lights



**PALADIN
LIGHTING**



Paladin Lighting Products



Table of Contents

Paladin Lighting Introduction	67
Paladin Features	68
Merchandisers • Utility Lights.....	69
Paladin Work Light Merchandiser	69
2 in 1 Flashlight Work Light	69
Pocket Work Light and Spot Light	69
Utility Light with Hook and Magnetic Backing	69
Magnetic Base Work Light with Hook	69
Work Lights.....	70
Portable Led Work Light (Corded)	70
Portable Flood Led Work Light (Corded)	70
Rechargeable Led Work Light w/ Magnetic Base	70
Rechargeable Led Work Light w/ Magnetic Base	70
Led Work Light with Handle (Corded)	70
Led Work Light with Tripod	71
Twin Head Led Work Light with Tripod	71
Adjustable Height Led Work Light with Tripod	71
Work Lights • Combo Packages	71
3-Pack COMBO KIT	71
2-Pack Head Light COMBO KIT	71
Light Bars - Straight Frame/Single Row	72
14" Led Light Bar (Straight / Single Row)	72
22" Led Light Bar (Straight / Single Row)	72
30" Led Light Bar (Straight / Single Row)	72
42" Led Light Bar (Straight / Single Row)	72
51" Led Light Bar (Straight / Single Row)	72
Light Bars - Curved Frame/Single Row	73
13" Led Light Bar (Curved / Single Row)	73
20" Led Light Bar (Curved / Single Row)	73
31" Led Light Bar (Curved / Single Row)	73
42" Led Light Bar (Curved / Single Row)	73
50" Led Light Bar (Straight / Double Row)	73
Light Bars - Straight Frame/Double Row	74
7.5" Led Light Bar (Straight / Double Row)	74
13.5" Led Light Bar (Straight / Double Row)	74
21.5" Led Light Bar (Straight / Double Row)	74
31.5" Led Light Bar (Straight / Double Row)	74
41.5" Led Light Bar (Straight / Double Row)	74
50" Led Light Bar (Straight / Double Row)	74
Light Bars - Curved Frame/Double Row	75
13.5" Led Light Bar (Curved / Double Row)	75
21.5" Led Light Bar (Curved / Double Row)	75
31.5" Led Light Bar (Curved / Double Row)	75
41.5" Led Light Bar (Curved / Double Row)	75
50" Led Light Bar (Curved / Double Row)	75
Lighting your way.	76



PALADIN

Lighting your way.



Paladin Lighting Products

Paladin Lighting provides the highest quality standard for your LED lighting needs.

Paladin boasts high IP ratings so it can withstand extreme weather and worksite conditions.

Paladin stands by its products by offering a 2 year warranty.

Paladin lights are constructed of durable materials so it can stand the test of time.

Paladin creates the highest intensity lighting in any setting.



Ideal for...



COMMERCIAL



AGRICULTURE



INDUSTRIAL



RECREATION



AQUATIC



Paladin light bars strive to deliver innovation that keeps you safe on the road, work site, where ever you are.

Features / Traits

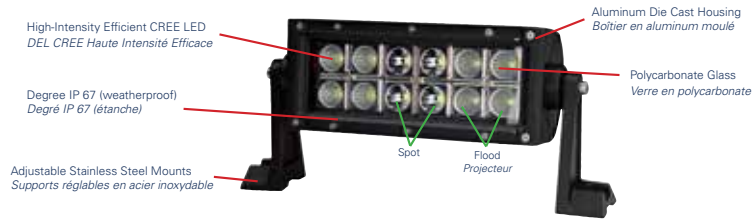

Did You Know?

Most jurisdictions **REQUIRE** light bars to be covered during highway driving.



Black PC snap on protective cover



Waterproof Deutsch connector

Only Paladin comes with a strong PC cover for all its light bar products. With a cover that looks this good you will be able to turn heads even with the lights off!

Each Paladin light bar comes with an IP rated waterproof Deutsch connector for easy install and protection. You don't have to be an electrician to install these lights!



Paladin boasts a very high IP rating standard which ensures that Paladin products prevent dust, water and debris in some of the most extreme weather and working conditions. IP67 is considered dust free and leak-free when submerged at the depth of one meter for at least 30 minutes. That is more than enough protection for the wet conditions found off-roading or driving in rainstorms.



Aluminum Die Casting



Impact Resistant

Die-cast aluminum housing and impact resistant polycarbonate lenses provide strength and quality that many competing products cannot match. Highway and work-sight debris don't stand a chance.



Superior Light Pattern

Paladin light bars are all equipped with CREE LED lights. CREE LEDs are the industry leader in LED technology. They provide unrivaled clarity and longevity with over 30,000 hour lifespan.

Paladin combines flood and beam angle lenses allowing for lighting that has maximum distance, clarity and spread.



Limited to defects in materials and workmanship from manufacturing.

The quality of Paladin products allows for the best warranty in the industry. Other competing products offer warranties that just can't compare!



Paladin Work Light Merchandiser

A collection of the best work lights on the market.

PART#	CONTENTS	
55100	Work lights backdrop - full color print (48" x 48")	
PART#	CONTENTS	
55100K	Work lights merchandiser with following the products	
PART#	DESCRIPTION	QTY.
55050	18W Portable LED Work Light	2 ea.
55051	30W LED Flood Work Light	2 ea.
55052	15W Work Light with Handle	2 ea.
55054	18W LED Work Light with Tripod	2 ea.
55055	36W LED Work Light with Tripod	2 ea.
55056	60W Work Light with Tripod	2 ea.
55080	2 in 1 Flashlight and Work Light	12 ea.
55081	Magnetic Base Work Light with Hook	2 ea.
55082	Pocket Work Light and Spotlight	12 ea.
55083	Magnetic Camping Light with Hook	12 ea.
55057	9W Magnet Base LED WorkLight	2 ea.
55058	8W Magnet Base LED WorkLight	2 ea.



2 in 1 Flashlight Work Light

Magnetic Base, Rotatable/Swivel Head with Hook, Requires 4AAA (not included)

Part#	Flashlight	3W - 70 Lumens
55080	Work Light	1.5W - 180 Lumens
	Beam Angle	Spot and Flood



Pocket Work Light and Spot Light

Magnetic Base, Spot light and flood light side, Requires 3AAA (not included)

Part#	Flashlight	0.5W - 40 Lumens
55082	Work Light	2W COB - 150 Lumens
	Beam Angle	Spot and Flood



Utility Light with Hook and Magnetic Backing

Magnetic Back with Swiveling Hook, Requires 3AA (not included)

Part#	Work Light	COB 200 Lumens
55083	Beam Angle	Flood



Magnetic Base Work Light with Hook

Magnetic Base with Hook, Car Plug entry port (plug not included), Requires 3AA (not included)

Part#	Work Light	24 SMD - 120 Lumens
55081	Beam Angle	Flood





Portable Led Work Light (Corded)

Foam handle, sturdy aluminum frame with swiveling base.

Part# 55050	LED Power	6 LED x 3 W
	Input Voltage	AC85-265V DC
	Beam Angle	Spot
	Raw Lumens	2160 Lumens
	Cord Length	4 M



Portable Flood Led Work Light (Corded)

Foam handle, sturdy aluminum frame

Part# 55051	LED Power	1 LED x 30 W
	Input Voltage	AC85-265V DC
	Beam Angle	Flood
	Raw Lumens	3600 Lumens
	Cord Length	4 M



USB included

Rechargeable Led Work Light w/ Magnetic Base

Foam handle, sturdy aluminum frame with powerful magnetic base. Includes USB power cable.

Part# 55057	LED Power	3 LED x 3 W
	Charge Time	8 Hours
	Discharge Time	4 Hours
	Beam Angle	Spot
	RAW Lumens	1080 Lumens
	Life Span	500 charges

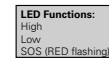

USB included

Rechargeable Led Work Light w/ Magnetic Base

Foam handle, sturdy aluminum frame with powerful magnetic base. Includes USB power cable.

Part# 55058	LED Power	16 LED x 0.5 W
	Charge Time	8 Hours
	Discharge Time	7 Hours
	Beam Angle	Flood
	RAW Lumens	800 Lumens
	Life Span	500 charges

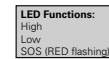

Led Work Light with Handle (Corded)

Vertical and hanging handle with swivel head.

Part# 55052	LED Power	5 LED x 3 W
	Input Voltage	AC85-265V DC
	Beam Angle	Flood
	Lumens	900 Effective
	Cord Length	4 M



Led Work Light with Tripod

Lightweight sturdy aluminum frame with adjustable height.

Part# 55054	LED Power	6 PCS x 3 W
	Input Voltage	AC85-265V DC
	Beam Angle	Spot
	Lumens	1200 Effective
	RAW Lumens	2160 Lumens
	Cord Length	4 M



Twin Head Led Work Light with Tripod

Lightweight sturdy aluminum frame with adjustable height.

Part# 55055	LED Power	6 PCS x 3 W ea.
	Input Voltage	AC85-265V DC
	Beam Angle	Spot
	Lumens	2400 Effective
	RAW Lumens	4320 Combined lumens
	Cord Length	4 M

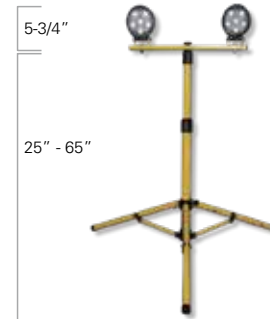

Adjustable Height Led Work Light with Tripod

Lightweight sturdy aluminum frame with adjustable height.

Part# 55056	LED Power	2 X 1 PCS x 30 W
	Input Voltage	AC85-265V DC
	Beam Angle	Flood
	Lumens	4000 Effective
	RAW Lumens	7200 Combined lumens
	Cord Length	4 M



3-Pack COMBO KIT

Mountable 7.5" light bar with two headlights.

Part# 55150	Head light	5 LED x 3 Watt ea.	Light bar	12 LED x 3 Watt ea.
	Current	12V/1.2A;24V/.06A	Current	12V/3A;24V/1.5A
	Beam Angle	Flood	Beam Angle	Flood
	Lumen	500 Effective	Lumen	2640 Effective
	RAW Lumen	900 Lumens ea.	RAW Lumen	4320 Lumens



2-Pack Head Light COMBO KIT

Two mountable head lights.

Part# 55151	Head light	5 LED x 3 Watt ea.
	Current	12V/1.2A;24V/.06A
	Beam Angle	Flood
	Lumen	500 Effective
	RAW Lumen	900 Lumens ea.



Paladin Lighting Products

Light Bars - Straight Frame/Single Row



Paladin Lighting Products



14" Led Light Bar (Straight / Single Row)

Single row lights setup with straight aluminum frame.

Part# 55110	LED Power	6 LED x 10 W
	Current Draw	12V / 4.26A - 24V / 2.1A
	Beam Angle	Spot and Flood
	Lumens	5400 Effective
	RAW Lumens	7200 Lumens



22" Led Light Bar (Straight / Single Row)

Single row lights setup with straight aluminum frame.

Part# 55111	LED Power	10 LED x 10 W
	Current Draw	12V / 7.1A - 24V / 3.5A
	Beam Angle	Spot and Flood
	Lumens	9000 Effective
	RAW Lumens	12000 Lumen



30" Led Light Bar (Straight / Single Row)

Single row lights setup with straight aluminum frame.

Part# 55112	LED Power	14 LED x 10 W
	Current Draw	12V / 9.94A - 24V / 4.9A
	Beam Angle	Spot and Flood
	Lumens	12600 Effective
	RAW Lumens	16800 Lumens



42" Led Light Bar (Straight / Single Row)

Single row lights setup with straight aluminum frame.

Part# 55113	LED Power	20 LED x 10 W
	Current Draw	12V / 14.2A - 24V / 7A
	Beam Angle	Spot and Flood
	Lumens	18000 Effective
	RAW Lumens	24000 Lumens



51" Led Light Bar (Straight / Single Row)

Single row lights setup with straight aluminum frame.

Part# 55114	LED Power	24 LED x 10 W
	Current Draw	12V / 17.4A - 24V / 8.4A
	Beam Angle	Spot and Flood
	Lumens	21600 Effective
	RAW Lumens	28800 Lumens

All Paladin Light Bars Feature...





PALADIN
Lighting your way.

All Paladin Light bars come with the components necessary to easily install the lights and maintain them.



Black PC snap-on protective cover

*Did You Know?
Most jurisdictions require light bars to be covered during highway driving.*



Waterproof Deutsch connector

13" Led Light Bar (Curved / Single Row)

Single row lights setup with curved aluminum frame.

Part# 55120	LED Power	6 LED x 10 W
	Current Draw	12V / 4.26A - 24V / 2.1A
	Beam Angle	Spot and Flood
	Lumens	5400 Effective
	RAW Lumens	7200 Lumens



20" Led Light Bar (Curved / Single Row)

Single row lights setup with curved aluminum frame.

Part# 55121	LED Power	10 LED x 10 W
	Current Draw	12V / 7.1A - 24V / 3.5A
	Beam Angle	Spot and Flood
	Lumens	9000 Effective
	RAW Lumens	12000 Lumens



31" Led Light Bar (Curved / Single Row)

Single row lights setup with curved aluminum frame.

Part# 55122	LED Power	14 LED x 10 W
	Current Draw	12V / 9.94A - 24V / 4.9A
	Beam Angle	Spot and Flood
	Lumens	12600 Effective
	RAW Lumens	16800 Lumens



42" Led Light Bar (Curved / Single Row)

Single row lights setup with curved aluminum frame.

Part# 55123	LED Power	20 LED x 10 W
	Current Draw	12V / 14.2A - 24V / 7A
	Beam Angle	Spot and Flood
	Lumens	18000 Effective
	RAW Lumens	24000 Lumens



50" Led Light Bar (Straight / Double Row)

Single row lights setup with curved aluminum frame.

Part# 55124	LED Power	24 LED x 10 W
	Current Draw	12V / 17.04A - 24V / 8.4A
	Beam Angle	Spot and Flood
	Lumens	21600 Effective
	RAW Lumens	28800 Lumens



Paladin Lighting Products



Paladin Lighting Products

Light Bars - Straight Frame/Double Row



Paladin Lighting Products



7.5" Led Light Bar (Straight / Double Row)

Double row lights setup with straight aluminum frame.

Part# 55130	LED Power	12 LED x 3 W
	Current Draw	12V / 3A - 24V / 1.5A
	Beam Angle	Spot and Flood
	Lumens	2640 Effective
	RAW Lumens	4320 Lumens



13.5" Led Light Bar (Straight / Double Row)

Double row lights setup with straight aluminum frame.

Part# 55131	LED Power	24 LED x 3 W
	Current Draw	12V / 6A - 24V / 3A
	Beam Angle	Spot and Flood
	Lumens	5280 Effective
	RAW Lumens	8640 Lumens



21.5" Led Light Bar (Straight / Double Row)

Double row lights setup with straight aluminum frame.

Part# 55132	LED Power	40 LED x 3 W
	Current Draw	12V / 10A - 24V / 5A
	Beam Angle	Spot and Flood
	Lumens	8800 Effective
	RAW Lumens	14400 Lumens



31.5" Led Light Bar (Straight / Double Row)

Double row lights setup with straight aluminum frame.

Part# 55133	LED Power	60 LED x 3 W
	Current Draw	12V / 15A - 24V / 7.5A
	Beam Angle	Spot and Flood
	Lumens	13200 Effective
	RAW Lumens	21600 Lumens



41.5" Led Light Bar (Straight / Double Row)

Double row lights setup with straight aluminum frame.

Part# 55134	LED Power	80 LED x 3 W
	Current Draw	12V / 20A - 24V / 10A
	Beam Angle	Spot and Flood
	Lumens	17600 Effective
	RAW Lumens	28800 Lumens



50" Led Light Bar (Straight / Double Row)

Double row lights setup with straight aluminum frame.

Part# 55135	LED Power	96 LED x 3 W
	Current Draw	12V / 24A - 24V / 12A
	Beam Angle	Spot and Flood
	Lumens	21120 Effective
	RAW Lumens	34560 Lumens



All Paladin Light Bars Feature...





PALADIN
Lighting your way.

All Paladin Light bars come with the components necessary to easily install the lights and maintain them.



Black PC snap-on protective cover

Did You Know?

Most jurisdictions require light bars to be covered during highway driving.



Waterproof Deutsch connector

13.5" Led Light Bar (Curved / Double Row)

Double row lights setup with curved aluminum frame.

Part# 55140	LED Power	24 LED x 3 W
	Current Draw	12V / 6A - 24V / 3A
	Beam Angle	Spot and Flood
	Lumens	5280 Effective
	RAW Lumens	8640 Lumens



21.5" Led Light Bar (Curved / Double Row)

Double row lights setup with curved aluminum frame.

Part# 55141	LED Power	40 LED x 3 W
	Current Draw	12V / 10A - 24V / 5A
	Beam Angle	Spot and Flood
	Lumens	8800 Effective
	RAW Lumens	14400 Lumens



31.5" Led Light Bar (Curved / Double Row)

Double row lights setup with curved aluminum frame.

Part# 55142	LED Power	60 LED x 3 W
	Current Draw	12V / 15A - 24V / 7.5A
	Beam Angle	Spot and Flood
	Lumens	13200 Effective
	RAW Lumens	21600 Lumens



41.5" Led Light Bar (Curved / Double Row)

Double row lights setup with curved aluminum frame.

Part# 55143	LED Power	80 LED x 3 W
	Current Draw	12V / 20A - 24V / 10A
	Beam Angle	Spot and Flood
	Lumens	17600 Effective
	RAW Lumens	28800 Lumens



50" Led Light Bar (Curved / Double Row)

Double row lights setup with curved aluminum frame.

Part# 55144	LED Power	96 LED x 3 W
	Current Draw	12V / 24A - 24V / 12A
	Beam Angle	Spot and Flood
	Lumens	21120 Effective
	RAW Lumens	34560 Lumens



DYNALINE

Introduces

PALADIN

Lighting your way.



Part# 55100K Merchandiser

PART#	CONTENTS
55100	LED Work Lights Backdrop (48" x 48")
55100K	LED Work Lights Plan-o-gram. Includes 55100 backdrop, and product listed below:

PART#	DESCRIPTION	QTY.
55050	18W Portable LED Work Light	2 ea.
55051	30W LED Flood Work Light	2 ea.
55052	15W Work Light with Handle	2 ea.
55054	18W LED Work Light with Tripod	2 ea.
55055	36W LED Work Light with Tripod	2 ea.
55056	60W Work Light with Tripod	2 ea.
55080	2 in 1 Flashlight and Work Light	12 ea.
55081	Magnetic Base Work Light with Hook	2 ea.
55082	Pocket Work Light and Spotlight	12 ea.
55083	Magnetic Camping Light with Hook	12 ea.
55057	9W Magnet Base LED WorkLight	2 ea.
55058	8W Magnet Base LED WorkLight	2 ea.

2 YEAR
Limited
Warranty



CREE
LEDs



30,000+
Hour Lifetime



Part# 55058



**HIGH-INTENSITY
LIGHTING SOLUTIONS**

Paladin Lighting Products



Impulse Buy Displays & Products



Tool tables
500+ Impulse buy products
'Tool Tracker' program
Mix and match
3 Price tiers



**IMPULSE BUY
DISPLAYS & PRODUCTS**



Impulse Buy Products



Table of Contents

Countertop Merchandisers79 - 81

2-in-1 COB Work Flashlight	79
Pocket Work Light and Spot Light	79
Magnetic Utility Light with Hook	79
Cree LED 3W Focusing Light	79
8 LED Light with Laser Pointer	79
12mm Carpenter Pencils	80
15mm Carpenter Pencils	80
Plastic Cutter, 3/4" Blade	80
Heavy Duty Plastic Cutter, 3/4" Blade	80
Utility Grade - 6/Box	80
Quality Grade - 12/Box	80
Dual Head Stubby Ratchet	81
Stubby Claw Hammer	81
Razor Folding Utility Cutter	81
Foldable Funnel	81

Red Impulse Buy Products82 - 90

Hex Key Set, 9 pcs s S.A.E.	83
Adjustable Hacksaw	83
Paint Brush, 5 pcs s set	83
Metric Deep Socket Set, 4 pcs	83
S.A.E. Socket Set with Rail, 7 pcs	83
Hex Key Set, 9 pcs s Metric	83
Measuring Tape, 25" x 1" S.A.E.	83
Wire Brush, 2 pcs s set	83
S.A.E. Deep Socket Set, 4 pcs	83
3/8" Ratchet Driver	83
Hobby Knife Set, 16 pcs	83
Artist Brush, 15 pcs set	83
Spark Plug Socket Set	83
Metric Socket Set with Rail, 7 pcs	83
Magnetic T-Bar Driver	83
Precision Screwdriver Set, 12 pcs	84
Pick-up Tool Set, 2 pcs	84
Crimping Tool with Terminals	84
Locking Pliers, 10"	84
Linesman Pliers / Cutter	84
Utility Knife Blade Dispenser	84
Hole Saw Set, 5 pcs	84
S.A.E. Nut Driver Set, 4 pcs	84
Groove Joint Pliers	84
Needle Nose Pliers, 8"	84
Tubing Cutter, Large	84
Electrical Test Kit, 3 pcs	84
Metric Nut Driver Set, 4 pcs	84
Adjustable Wrench, 8"	84
Slip Join Pliers, 8"	84
S.A.E. Combination Wrench Set, 4 pcs	85
Air Tool Coupler Set, 4 pcs	85
Brush Set, 3 pcs	85
Shock Cord Set, 8 pcs	85
15-in-1 Multi Tool with Pouch	85
Metric Combination Wrench Set, 4 pcs	85
Automotive Fuse Kit, 25 pcs	85
Air Blow Gun Set, 3 pcs	85
Screwdriver Set with Rack, 6 pcs	85
AC / DC Multi Tester	85
Power Bit Set, 10 pcs	85
File Set with Handles, 6 pcs	85
Metal Pick and Hook Set, 4 pcs	85
Diagonal Pliers, 7-1/2"	85
Pocket Calculator	85
Flexible Extensions	86
Multi Purpose Scissors, 2 pcs	86
Drill Bit Set, 13 pcs	86
Parts Cleaning Brush Set, 5 pcs	86
Mini Stubby Screwdriver Set, 6 pcs	86
9" Pocket Level	86
Close Quarter Hacksaw	86
Heavy Duty Magnifying Glass	86
Screwdriver Bit Set with Holders, 33 pcs	86
Tamper Proof Star Bit Set, 13 pcs	86
Automotive Tester, 6v and 12v	86
Straight Aviation Snips	86
Mini Tubing Cutter	86
Cable Ties Set, 150 pcs	86
Assorted Electrical Terminals, 48 pcs	86
Ratchet with S.A.E. Sockets, 1/4" Drive	87
3/8" Drive Extension Set, 2 pcs	87
Hand Saw	87
Mini Auto Fuse Set, 32 pcs	87
Flex Scraper Set, 3 pcs	87
Extra Long Socket Adapter, 3 pcs	87
Tire Repair Kit	87
Tool Bag with Pockets	87
Wire Wheel Set, 3 pcs	87
Socket Holders Set, 2 pcs	87
O-Ring Assortment, 50 pcs	87
15" Ratchet Tie Down	87

Mounted Stone Set, 10 pcs	87
Socket Adapter Set, 4 pcs	87
Utility Bar, 15"	87
Extended Scraper	88
Dust Mask Set, 3 pcs	88
Claw Hammer, 16 oz	88
Self Feeding Utility Knife	88
L.E.D. Stick-on Tap Lights, 2 pcs	88
4-in-1 Brush	88
Magnetic Parts Dish	88
Rubber Mallet	88
Magnetic Nut Setter, 3 pcs	88
Micro-driver Bit Set, 10 pcs	88
Power Nut driver and Bit Set, 13 pcs	88
Zip Pouch Set, 3 pcs	88
Double Face Mallet	88
L.E.D. Head Lamp	88
Tamper Proof Star Key Set, 10 pcs	88
Plier Set, 2 pcs	89
Long Needle Nose Pliers, 6"	89
Hacksaw Blade Set, 12 pcs	89
Big Handle Screwdriver Set, 2 pcs	89
Maxi Fuse Set, 7 pcs	89
Air Blow Gun, Pistol Type	89
Extra Long Screwdriver Set, 2 pcs	89
Telescoping Magnet, 8 lb	89
Leather Work Gloves	89
Replacement Power Cord End Set	89
4" Power Grip Vacuum Cup	89
1/4" Drive Extension Set, 3 pcs	89
Inspection Mirror, 2"	89
Micro Fuse Set, 32 pcs	89
Safety Glasses and Ear Plug Set	89
48" Elastic Cord with Hook, 2 pcs	90
Receptacle Tester	90
Glass Breaker/Seatbelt Cutter	90
Drywall Saw	90
Safety Vest	90
Sink and Drain Cleaner	90
Twine Assortment, 4pcs	90
Adhesive Felt Pads, 50 pcs	90
Cable Manager Set, 31 pcs	90

Blue Impulse Buy Products91- 97

Driver Socket Set, 10 pcs	92
10" Adjustable Wrench	92
Screwdriver Set, 8 pcs	92
3 lb Fiberglass Sledgehammer	92
Punch and Chisel Set, 7 pcs	92
1/4" Drive Socket Set, 22 pcs	92
PVC Pipe Cutter	92
Plier Set, 2 pcs	92
Mini Plier Set, 3 pcs	92
S.A.E. Deep Socket Drive Set, 7 pcs	92
Ratcheting Tie Down 2" x 27'	92
Framing Hammer, 24 oz	92
Mirror and Magnet Set, 2 pcs	92
Pry Bar Set, 4 pcs	92
Metric Deep Socket Drive Set, 7 pcs	92
AC / DC Multi Tester	93
6" x 1" Cam Buckle Set, 2 pcs	93
Cable Tie Set	93
Read Easy Tape Measure	93
20' x 1" Ratchet Tie Down Set, 2 pcs	93
Tamper Proof Star Socket Set, 9 pcs	93
1 lb Dead Blow Hammer	93
Heavy Duty Hacksaw	93
H.D. Long Stretch Cord Set, 16 pcs	93
Rubber Tie Down Strap Set, 10 pcs	93
Groove Joint Pliers	93
Hollow Shaft Nut Driver Set, 5 pcs	93
14" Tow Rope, 6500lb capacity	93
Mini Tool Accessory Set, 72 pcs	93
Automotive Fuse Assortment, 75 pcs	93
Snap Ring Plier Set, 3 pcs	94
Extra Long Needle Nose Pliers	94
Folding Utility Knife	94
Mini Car Fuse Assortment, 80 pcs	94
30-in-1 Micro Precision Bit Set	94
S.A.E. Combination Wrench Set, 6 pcs	94
Mechanics Gloves, Large	94
3" Long Power Bit Set, 29 pcs	94
O-Ring Set, 225 pcs	94
Crimping Tool and Terminal Kit, 101 pcs	94
Mechanics Gloves, X-large	94
Screwdriver Bit Set, 30 pcs	94
23" Magnetic Pick up Tool with Light	94
Ball Hex and Star Driver Set, 16 pcs	94
Mechanics Pick, Hook and Driver Set	95

Cushion Grip Screwdriver Set, 5 pcs	95
Contractor's Screwdriver Set, 8 pcs	95
Claw Hammer	95
L.E.D. Light Set, 3 pcs	95
Easy Out and Drill Bit Set, 12 pcs	95
High Speed Drill Bit Set, 16 pcs	95
S.A.E. Drive Hex Bit Socket, 10 pcs	95
Micro Fuse Set, 80 pcs	95
Iron Padlock, 75 mm	95
Wire Brush Set, 6 pcs	95
Hollow Punch Set, 6 pcs	95
Metric Drive Hex Bit Socket Set	95
Heavy Duty Voltage Tester	95
Utility Knife Set, 26 pcs	95
Ear Muffs and Safety Glasses	96
Brush Set, 7 pcs	96
Bit Holder and Extension Set, 6 pcs	96
Multi Purpose X-Large Glove Set, 3 pcs	96
Dual Head Tire Gauge	96
Heavy Duty Tire Repair Kit	96
Rubber Mallet, 32 oz	96
Paint Brush Set, 10 pcs	96
Staple Gun	96
4 Way Lug Wrench	96
6 Outlet Power Strip	96
Dust Mask Set, 100 pcs	96
Multi Purpose Large Glove Set, 3 pcs	96
Utility Bar	96
Warning Triangle	96
Tri-Tap Extension Cord	97
S.A.E. Ball Hex Key Set	97
Long Blade Aviation Tin Snip	97
Tap Set, 8 pcs	97

Black Impulse Buy Products ..98 - 102

Folding Utility Knife, 2 pack	99
1/4" & 3/8" Drive Offset Ratchet	99
Metric Non-Slip Hex Key Set, 9 pcs s	99
S.A.E. Hex Bit Socket Set, 10 pcs	99
Seal and O-Ring Remover Set, 4 pcs	99
Internal Pipe Wrench Set, 3 pcs	99
High Torque Ratcheting Drive	99
Security Bit Set, 100 pcs	99
Metric Hex Bit Socket Set, 10 pcs	99
Stainless Steel Pry Bar Set, 2 pcs	99
Nylon Scraper Set, 4 pcs	99
S.A.E. Non-Slip Hex Key Set, 13 pcs	99
Tamper Resistant Star Bit, 13 pcs	99
Multi Purpose Razor Scraper Set	99
Scraper Set, 22 pcs	99
S.A.E. Combo Wrench Set, 11 pcs	100
Metric Stubby Wrench Set, 7 pcs	100
Composite Digital Caliper	100
1/2" Drive Breaker Bar, 18" length	100
Pry Bar Set, 4 pcs	100
Metric Combo Wrench Set, 11 pcs	100
Mini Precision Plier Set, 5 pcs	100
Metric Grease Fitting Assrt, 110 pcs	100
Heat Gun	100
Adapter and U-Joint Set, 7 pcs	100
S.A.E. Stubby Wrench Set, 7 pcs	100
Blow Gun with Venturi Tip	100
12" Groove Joint Pliers	100
Master Auto Fuse Assrt, 88 pcs	100
Titanium Drill Bit Set, 22 pcs	100
Tire Inflator and Dial Gauge	101
Socket Set, 52 pcs	101
Screwdriver Set, 10 pcs	101
Tape Measure Set, 4 pcs	101
S.A.E. O-Ring Assortment, 407 pcs	101
Self Adjusting Wire Stripper	101
6" Plier Set, 4 pcs	101
Adapter and U-Joint Set, 7 pcs	101
Ratcheting Wire Terminal Crimper	101
50' PVC Air Hose, 3/8" dia	101
Cross Pain Hammer, 3 lb	101
Screwdriver Bit Set, 61 pcs	101
180° Tubing Bender	101
Utility Pick-up Tool Set, 3 pcs	101
Extra Long Ratchet, 1/2" drive	101
Offset Micro Bit Driver with Bits	102
Multi Use Power Bit Set, 45 pcs	102
Star Socket Bit Set, 9 pcs	102
18" Bolt Cutters	102
Impact Reducer Adapter Set, 3 pcs	102
Metric O-Ring Assortment, 419 pcs	102
Compound Action Cable Cutters	102
3/8" and 1/2" Drive Offset Ratchet	102
Screw Extractor / Left Hand Drill Bit, 10 pcs	102
Heat Shrink Tube Kit, 171 pcs	102



Impulse Buy Products



2-in-1 COB Work Flashlight

PART#	DESCRIPTION	PACK
55080	Features hanging hook and high power magnetic base. Swivel head for directional use. Pull out head to reveal flood light on stem.	12/Display Box

*Sold individually. Display box available with purchase of 12 or more. Batteries not included.



Pocket Work Light and Spot Light

PART#	DESCRIPTION	PACK
55082	Small compact size with powerful COB LED light for excellent illumination. Supports both Spot and flood light options.	12/Display Box

*Sold individually. Display box available with purchase of 12 or more. Batteries not included.



Magnetic Utility Light with Hook

PART#	DESCRIPTION	PACK
55083	Magnetic base and swivel hanging hook for hands-free use. Bright flood light design provides excellent illumination.	12/Display Box

*Sold individually. Display box available with purchase of 12 or more. Batteries not included.



Cree LED 3W Focusing Light

PART#	DESCRIPTION	PACK
234439	3 W 3 x AAA Super Brite Cree LED. CREE Diode, push button, anodized aircraft aluminum body.	8/Display Box

*Sold individually. Display box available with purchase of 8 or more.



8 LED Light with Laser Pointer

PART#	DESCRIPTION	PACK
234440	8 LED with Laser Pointer 3 x AAA. Functions LED, laser and LED with laser.	8/Display Box

*Sold individually. Display box available with purchase of 8 or more.



Impulse Buy Products



Impulse Buy Products

Countertop Impulse Buy Merchandisers



12mm Carpenter Pencils

PART#	COLOUR	LEAD	BOX/CASE
33801	Fl. Pink	Medium	72/ 1440
33880	Fl. Orange	Soft	72/ 1440
33890	Fl. Green	Hard	72/ 1440
33900	Red	Red/Black	72/ 1440

15mm Carpenter Pencils

PART#	COLOUR	LEAD	BOX/CASE
33810	Yellow	Medium	60 /1200
33820	Red	Medium	60 /1200
33830	Sky Blue	Medium	60 /1200
33840	Orange	Medium	60 /1200
33850	White	Medium	60 /1200
33860	Navy Blue	Medium	60 /1200
33870	Black	Medium	60 /1200



Plastic Cutter, 3/4" Blade

PART#	COLOUR	SHEATH/ LOCK	BLADE/BL. GRADE	BOX/ CASE
2558228	Red	Plastic / Thumb	3/4" / DIY	48 / 480
2558229	Dark Green	Plastic / Thumb	3/4" / DIY	48 / 480
2558230	Blue	Plastic / Thumb	3/4" / DIY	48 / 480
2558231	Yellow	Plastic / Thumb	3/4" / DIY	48 / 480
2558232	Orange	Plastic / Thumb	3/4" / DIY	48 / 480
2558233	Light Green	Plastic / Thumb	3/4" / DIY	48 / 480
2558234	Black	Plastic / Thumb	3/4" / DIY	48 / 480

Heavy Duty Plastic Cutter, 3/4" Blade

PART#	COLOUR	SHEATH/ LOCK	BLADE/BL. GRADE	BOX/ CASE
2558806	Red	Plastic / Thumb	3/4" / DIY	48 / 480
2558807	Yellow	Plastic / Thumb	3/4" / DIY	48 / 480
2558808	Blue	Plastic / Thumb	3/4" / DIY	48 / 480



Utility Grade - 6/Box

PART#	LENGTH	GRADUATION	WIDTH	HOOK
38220	25'	Imperial	1"	Standard

Quality Grade - 12/Box

PART#	LENGTH	GRADUATION	WIDTH	HOOK
38316	16'/5m	Imperial/Metric	1"	Standard
38325	16'/7.5m	Imperial/Metric	1"	Standard
38425	25'	Imperial	1"	Standard
38475	25'	Imperial/Double Sided	1"	Magnetic*
38450	25'/7.5m	Imperial/Metric	1"	Standard



Impulse Buy Products



Dual Head Stubby Ratchet

PART#	DESCRIPTION	PACK
441802	1/4" and 3/8" driver head. Small size makes it great for mobility and those tight spaces.	12/Display Box*

*Sold individually. Display box available with purchase of 12 or more.



Stubby Claw Hammer

PART#	DESCRIPTION	PACK
441806	Small size makes it great for mobility and those tight spaces.	12/Display Box*

*Sold individually. Display box available with purchase of 12 or more.



Razor Folding Utility Cutter

Sturdy aluminum body in clamshell packaging for easy retail and restock

PART#	SHEATH/LOCK	POP DISPLAY	BOX/CASE
559110	Aluminum / Folding	Box of 12	12/48

*Sold individually. Display box available with purchase of 12 or more.



Foldable Funnel

This moldable funnel available in two sizes allows you shape the funnel to divert oil or fluids around engine parts. This innovative product is a must have for every garage.

PART#	SIZE
15009	9" x 4-3/4"
15014	14-1/2" x 6-1/2"



Impulse Buy Products



Impulse Buy Products

Red Impulse Buy Table Introduction



Impulse Buy **Red Table** Products

The Tool Cache **Red** Impulse Buy Table is the perfect way to drive sales of those last minute purchases by your customers. The products in the red table are all sold at a low \$7.98 price point. The tables sizes are available in 48" x 30" and 30" x 30". Our No-risk Guarantee ensures that the products that don't sell can be returned and replaced with faster moving products at no charge. Contact your Account Manager or Dynaline customer service for more information on the Impulse Buy Tables.

PART#	CONTENTS
WRC-4	Caster Wheels Only for 30" x 30" and 48" x 30" tables (Includes 4 casters)
WRD-3030	30" x 30" Double Wire Table Display Only
WRD-3048	48" x 30" Double Wire Table Display Only
51078-09	Red Table Sign Only (Bilingual)



2 Table Sizes
30" x 48" Regular
30" x 30" Compact

ZERO RISK! Stock Protection Guarantee for 1 year!
If it doesn't sell, we take it back.



51101 - Hex Key Set, 9 pcs s S.A.E.



51102 - Hex Key Set, 9 pcs s Metric



51103 - Hobby Knife Set, 16 pcs s



51108 - Adjustable Hacksaw



51111 - Measuring Tape, 25' x 1' S.A.E.



51112 - Artist Brush, 15 pcs s set



51113 - Paint Brush, 5 pcs s set



51114 - Wire Brush, 2 pcs s set



51120 - Spark Plug Socket Set, 2 pcs s



51123 - Metric Deep Socket Set, 4 pcs s (3/8' drive)



51124 - S.A.E. Deep Socket Set, 4 pcs s (3/8' drive)



51125 - Metric Socket Set with Rail, 7 pcs (3/8' drive)



51126 - S.A.E. Socket Set with Rail, 7 pcs (3/8' drive)



51127 - 3/8' Ratchet Driver



51130 - Magnetic T-Bar Driver, 25 pcs



Impulse Buy Products

Red Impulse Buy Products



51131 - Precision Screwdriver Set, 12 pcs



51135 - Utility Knife Blade Dispenser



51140 - Tubing Cutter, Large



51141 - Pick-up Tool Set, 2 pcs



51142 - Hole Saw Set, 5 pcs



51146 - Electrical Test Kit, 3 pcs



51150 - Crimping Tool with Terminals



51157 - S.A.E. Nut Driver Set, 4 pcs



51158 - Metric Nut Driver Set, 4 pcs



51159 - Locking Pliers, 10"



51160 - Groove Joint Pliers



51161 - Adjustable Wrench, 8"



51162 - Linesman Pliers / Cutter



51163 - Needle Nose Pliers, 8"



51164 - Slip Join Pliers, 8"

Impulse Buy Products





51165 - S.A.E. Combination Wrench Set, 4 pcs



51166 - Metric Combination Wrench Set, 4 pcs



51167 - #2 Power Bit Set, 10 pcs



51170 - Air Tool Coupler Set, 4 pcs



51171 - Automotive Fuse Kit, 25 pcs



51177 - File Set with Handles, 6 pcs



51178 - Brush Set, 3 pcs



51181 - Air Blow Gun Set, 3 pcs



51182 - Metal Pick and Hook Set, 4 pcs



51184 - Shock Cord Set, 8 pcs



51185 - Screwdriver Set with Rack, 6 pcs



51202 - Diagonal Pliers, 7-1/2"



51214 - 15-in-1 Multi Tool with Pouch



51217 - AC / DC Multi Tester



51222 - Pocket Calculator



Impulse Buy Products



Impulse Buy Products

Red Impulse Buy Products



Impulse Buy Products



51225 - Flexible Extensions



51239 - 9" Pocket Level



51241 - Automotive Tester, 6v and 12v



51244 - Multi Purpose Scissors, 2 pcs



51245 - Close Quarter Hacksaw



51252 - Straight Aviation Snips



51262 - Drill Bit Set, 13 pcs



51265 - Heavy Duty Magnifying Glass



51270 - Mini Tubing Cutter



51275 - Parts Cleaning Brush Set, 5 pcs



51277 - Screwdriver Bit Set with Holders, 33 pcs



51282 - Cable Ties Set, 150 pcs



51283 - Mini Stubby Screwdriver Set, 6 pcs



51284 - Tamper Proof Star Bit Set, 13 pcs



51285 - Assorted Electrical Terminals, 48 pcs





51590 - Ratchet with S.A.E. Sockets, 1/4" Drive



51291 - Extra Long Socket Adapter, 3 pcs



51292 - O-Ring Assortment, 50 pcs



51295 - 3/8" Drive Extension Set, 2 pcs



51296 - Tire Repair Kit



51299 - 15' Ratchet Tie Down



51301 - Hand Saw



51303 - Tool Bag with Pockets



51309 - Mounted Stone Set, 10 pcs



51317 - Mini Auto Fuse Set, 32 pcs



51318 - Wire Wheel Set, 3 pcs



51327 - Socket Adapter Set, 4 pcs



51328 - Flex Scraper Set, 3 pcs



51330 - Socket Holders Set, 2 pcs



51331 - Utility Bar, 15"



Impulse Buy Products

Red Impulse Buy Products



Impulse Buy Products



51333 - Extended Scraper



51334 - 4-in-1 Brush



51338 - Power Nut driver and Bit Set, 13 pcs



51339 - Dust Mask Set, 3 pcs



51340 - Magnetic Parts Dish



51345 - Zip Pouch Set, 3 pcs



51353 - Claw Hammer, 16 oz



51360 - Rubber Mallet



51631 - Double Face Mallet



51432 - Self Feeding Utility Knife



51441 - Magnetic Nut Setter, 3 pcs



51443 - L.E.D. Head Lamp



51445 - L.E.D. Stick-on Tap Lights, 2 pcs



51446 - Micro-driver Bit Set, 10 pcs



51451 - Tamper Proof Star Key Set, 10 pcs





51452 - Plier Set, 2 pcs



51453 - Air Blow Gun, Pistol Type



51456 - 4" Power Grip Vacuum Cup



51459 - Long Needle Nose Pliers, 6"



51472 - Extra Long Screwdriver Set, 2 pcs



51473 - 1/4" Drive Extension Set, 3 pcs



51474 - Hacksaw Blade Set, 12 pcs



51478 - Telescoping Magnet, 8 lb



51479 - Inspection Mirror, 2"



51480 - Big Handle Screwdriver Set, 2 pcs



51481 - Leather Work Gloves



51482 - Micro Fuse Set, 32 pcs



51483 - Maxi Fuse Set, 7 pcs



51485 - Replacement Power Cord End Set



51486 - Safety Glasses and Ear Plug Set



Impulse Buy Products



Impulse Buy Products

Red Impulse Buy Products



51487 - 48" Elastic Cord with Hook, 2 pcs



51489 - Drywall Saw



51490 - Twine Assortment, 4pcs



51493 - Receptacle Tester



51494 - Safety Vest



51495 - Adhesive Felt Pads, 50 pcs



51496 - Emergency Glass Breaker and Seatbelt Cutter



51498 - Sink and Drain Cleaner



51499 - Cable Manager Set, 31 pcs

Red Table

TOOL SALE! YOUR CHOICE **7⁹⁸** EACH

Great Value!
Fully Guaranteed!

Excellent \$ return per sq/ft

- Fully guaranteed stock
- 150 products per table
- 80 different SKUS
- Retailers at \$1170!



Impulse Buy Products





Impulse Buy **Blue Table** Products

The Tool Cache **Blue** Impulse Buy Table is the perfect way to drive sales of those last minute purchases by your customers. The products in the red table are all sold at a low \$13.98 price point. The tables sizes are available in 48" x 30" and 30" x 30". Our No-risk Guarantee ensures that the products that don't sell can be returned and replaced with faster moving products at no charge. Contact your Account Manager or Dynaline customer service for more information on the Impulse Buy Tables.

PART#	CONTENTS
WRC-4	Caster Wheels Only for 30" x 30" and 48" x 30" tables (Includes 4 casters)
WRD-3030	30" x 30" Double Wire Table Display Only
WRD-3048	48" x 30" Double Wire Table Display Only
51078-08	Blue Table Sign Only (Bilingual)



2 Table Sizes
30" x 48" Regular
30" x 30" Compact

ZERO RISK! Stock Protection Guarantee for 1 year!
If it doesn't sell, we take it back.



Impulse Buy Products



Impulse Buy Products

Blue Impulse Buy Products



51603 - 3/8" Driver Socket Set, 10 pcs



51604 - 1/4" Drive Socket Set, 22 pcs



51606 - Ratcheting Tie Down, 2" x 27'



51607 - 10" Adjustable Wrench



51617 - PVC Pipe Cutter



51627 - Framing Hammer, 24 oz



51630 - Screwdriver Set, 8 pcs



51640 - Plier Set, 2 pcs



51645 - Mirror and Magnet Set, 2 pcs



51649 - 3 lb Fiberglass Sledgehammer



51650 - Mini Plier Set, 3 pcs



51651 - Pry Bar Set, 4 pcs



51652 - Punch and Chisel Set, 7 pcs



51654 - 3/8" S.A.E. Deep Socket Drive Set, 7 pcs



51655 - 3/8" Metric Deep Socket Drive Set, 7 pcs

Impulse Buy Products





51657 - AC / DC Multi Tester



51677 - Tamper Proof Star Socket Set, 9 pcs



51682 - Groove Joint Pliers



51691 - 6' x 1" Cam Buckle Set, 2 pcs



51692 - 1 lb Dead Blow Hammer



51694 - S.A.E. Hollow Shaft Nut Driver Set, 5 pcs



51902 - Cable Tie Set



51941 - Heavy Duty Hacksaw



51948 - 14' Tow Rope, 6500lb capacity



53945 - Read Easy Tape Measure, 25' x 1-1/4"



56102 - Heavy Duty Long Stretch Cord Set, 16 pcs



56111 - Mini Tool Accessory Set, 72 pcs



56122 - 20' x 1" Ratchet Tie Down Set, 2 pcs



56123 - Rubber Tie Down Strap Set, 10 pcs



56125 - Automotive Fuse Assortment, 75 pcs



Impulse Buy Products



Impulse Buy Products

Blue Impulse Buy Products



56126 - Snap Ring Plier Set, 3 pcs



56128 - S.A.E. Combination Wrench Set, 6 pcs



56130 - Crimping Tool and Terminal Kit, 101 pcs



56131 - Extra Long Needle Nose Pliers



56143 - Mechanics Gloves, Large



56144 - Mechanics Gloves, X-large



56146 - Folding Utility Knife



56147 - 3" Long Power Bit Set, 29 pcs



56150 - Screwdriver Bit Set, 30 pcs



56160 - Mini Car Fuse Assortment, 80 pcs



56162 - 6" Plastic Dial Caliper



56163 - 23" Magnetic Pick up Tool with Light



56168 - 30-in-1 Micro Precision Bit Set



56169 - O-Ring Set, 225 pcs



56170 - Ball Hex and Star Driver Set, 16 pcs

Impulse Buy Products





56172 - Mechanics Pick, Hook and Driver Set with Case, 8 pcs



56175 - Easy Out and Drill Bit Set, 12 pcs



56181 - Wire Brush Set, 6 pcs



56188 - Cushion Grip Screwdriver Set, 5 pcs



56189 - High Speed Drill Bit Set, 16 pcs



56191 - Hollow Punch Set, 6 pcs



56193 - Contractor's Screwdriver Set, 8 pcs



56197 - 3/8" S.A.E. Drive Hex Bit Socket, 10 pcs



56199 - 3/8" Metric Drive Hex Bit Socket Set, 10 pcs



56200 - Claw Hammer



56201 - Micro Fuse Set, 80 pcs



56203 - Heavy Duty Voltage Tester



56205 - L.E.D. Light Set, 3 pcs



56206 - Iron Padlock, 75 mm



56208 - Utility Knife Set, 26 pcs



Impulse Buy Products



Impulse Buy Products

Blue Impulse Buy Products



56209 - Ear Muffs and Safety Glasses



56210 - Heavy Duty Tire Repair Kit



56213 - 6 Outlet Power Strip



56215 - Brush Set, 7 pcs



56216 - Rubber Mallet, 32 oz



56217 - Dust Mask Set, 100 pcs



56218 - Bit Holder and Extension Set, 6 pcs



56219 - Paint Brush Set, 10 pcs



56220 - Multi Purpose Large Glove Set, 3 pcs



56221 - Multi Purpose X-Large Glove Set, 3 pcs



56222 - Staple Gun



56223 - Utility Bar



56224 - Dual Head Tire Gauge



56225 - 4 Way Lug Wrench



56227 - Warning Triangle

Impulse Buy Products





56229 - Tri-Tap Extension Cord



56230 - Long Blade Aviation Tin Snip



56231 - Tap Set, 8 pcs



51684 - S.A.E. Ball Hex Key Set



Good Profit Margins and Strong Return on Investment per Sq/ft



Quality Products, Unconditionally Guaranteed - No Hassle



Annual Stock Cleanup

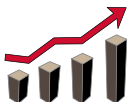

“Tool Tracker” replenishment system optimizes your inventory and turns

Blue Table

TOOL SALE! **YOUR CHOICE** **13⁹⁸** EACH

**Highest Traffic!
Fully Guaranteed!**

**Excellent \$
return
per sq/ft**

- Fully guaranteed stock
- 100 products per table
- 60 different SKUS
- Retail at \$1398!



Impulse Buy Products

Black Impulse Buy Table Introduction



Impulse Buy Black Table Products

The Tool Valley Black Impulse Buy Table is the perfect way to drive sales of those last minute purchases by your customers. The products in the red table are all sold at a low \$19.98 price point. The tables sizes are available in 48" x 30" and 30" x 30". Our No-risk Guarantee ensures that the products that don't sell can be returned and replaced with faster moving products at no charge. Contact your Account Manager or Dynaline customer service for more information on the Impulse Buy Tables.

PART#	CONTENTS
WRC-4	Caster Wheels Only for 30" x 30" and 48" x 30" tables (Includes 4 casters)
WRD-3030	30" x 30" Double Wire Table Display Only
WRD-3048	48" x 30" Double Wire Table Display Only
51078-22	Black Table Sign Only (Bilingual)



2 Table Sizes
30" x 48" Regular
30" x 30" Compact

ZERO RISK! Stock Protection Guarantee for 1 year!
If it doesn't sell, we take it back.





11020 - Folding Utility Knife, 2 pack



11498TC - Internal Pipe Wrench Set, 3 pcs



11565TC - Nylon Scraper Set, 4 pcs



12052 - 1/4" & 3/8" Drive Offset Ratchet



12220TC - High Torque Ratcheting Drive



12713 - S.A.E. Non-Slip Hex Key Set, 13 pcs



12714 - Metric Non-Slip Hex Key Set, 9 pcs



16100 - Security Bit Set, 100 pcs



16113 - Tamper Resistant Star Bit, 13 pcs



16169 - S.A.E. Hex Bit Socket Set, 10 pcs (3/8" drive)



16170 - Metric Hex Bit Socket Set, 10 pcs (3/8" drive)



17002 - Multi Purpose Razor Scraper Set, 2 pcs



17004 - Seal and O-Ring Remover Set, 4 pcs



17005 - Stainless Steel Pry Bar Set, 2 pcs



17008 - Scraper Set with Non Marring Blades, 22 pcs



Impulse Buy Products



Impulse Buy Products

Black Impulse Buy Products



17327 - S.A.E. Combo Wrench Set, 11 pcs



17328 - Metric Combo Wrench Set, 11 pcs



17373 - S.A.E. Stubby Wrench Set, 7 pcs



17374 - Metric Stubby Wrench Set, 7 pcs



51101 - Mini Precision Plier Set, 5 pcs



19402 - Blow Gun with Venturi Tip



23171 - Composite Digital Caliper



45274 - Metric Grease Fitting Assortment, 110 pcs



60743 - 12" Groove Joint Pliers



62120 - 1/2" Drive Breaker Bar, 18" length



77300 - Heat Gun



77301 - Master Auto Fuse Assortment, 88 pcs



77302 - Pry Bar Set, 4 pcs



77303 - Adapter and U-Joint Set, 7 pcs



77304 - Titanium Drill Bit Set, 22 pcs

Impulse Buy Products



77305 - Tire Inflator and Dial Gauge



77306 - Self Adjusting Wire Stripper



77307 - Cross Pein Hammer, 3 lb



77308 - Socket Set, 52 pcs



77309 - 6" Plier Set, 4 pcs



77310 - Screwdriver Bit Set, 61 pcs



77311 - Screwdriver Set, 10 pcs



77312 - Adapter and U-Joint Set, 7 pcs



77314 - 180° Tubing Bender



77315 - Tape Measure Set, 4 pcs



77316 - Ratcheting Wire Terminal Crimper



77317 - Utility Pick-up Tool Set, 3 pcs



77318 - S.A.E. O-Ring Assortment, 407 pcs



77319 - 50' PVC Air Hose, 3/8" dia



77320 - Extra Long Ratchet, 1/2" drive



Impulse Buy Products



Impulse Buy Products

Black Impulse Buy Products



77321 - Offset Micro Bit Driver with Bits



77322 - Impact Reducer Adapter Set, 3 pcs



77323 - 3/8" and 1/2" Drive Offset Ratchet



77324 - Multi Use Power Bit Set, 45 pcs



77325 - Metric O-Ring Assortment, 419 pcs



77326 - Screw Extractor / Left Hand Drill Bit, 10 pcs



77327 - Star Socket Bit Set, 9 pcs



77328 - Compound Action Cable Cutters



77329 - Heat Shrink Tube Kit, 171 pcs



97005 - 18" Bolt Cutters

Black Table

PRO TOOL SALE! YOUR CHOICE **19⁹⁸** EACH

**Professional Quality!
Fully Guaranteed!**

**Excellent \$
return
per sq/ft**

- Fully guaranteed stock
- 100 products per table
- 40 different SKUS
- Retailers at \$1998!



Impulse Buy Products



Boss Tools & Accessories



Cutters
Pencils
Blades
Saw blades
Tape measures
Bit kits

Custom products
Drill bits
Drivers
Padlocks
Magnifiers
Scrapers



**BOSS TOOLS
& ACCESSORIES**



Boss Tools and Accessories



Table of Contents

Driver Bits.....105	Drill Bits.....117
Robertson - Plain Finish Bits 105	Cobalt Drill Bits feat. Grizzly Tip..... 117
Robertson - Color Coded Bits 105	Plastic Cutters118
Robertson - Branded Impact Bits 106	Plastic Cutter, 3/4" Blade 118
Robertson - Magnetic Impact Bits 106	Heavy Duty Plastic Cutter, 3/4" Blade 118
Phillips - Colour Coded Bits 106	Heavy Duty Plastic Cutter w/ Metal Reinforced Head 118
Slotted - Plain Finish Bits 107	Heavy Duty Cutters119
Phillips - Plain Finish Bits 107	Ergo Grip Cutter, 3/4" Blade 119
TORX - Plain Finish Bits 108	Comfort Grip Cutter, 3/4" Blade 119
Hex / Allen - Plain Finish 108	Heavy Duty Knob Lock Cutter, 3/4" Blade 119
Pozi - Plain Finish Bits..... 109	Mega Blade Cutters, 1" Blade..... 119
Drywall - Plain / Brass Finish Bits 109	Ergonomic Serrated Blade Cutter, 3/4" Blade..... 119
Torque Tamper Proof - Plain Finish Bits 109	Auto Loading Cutters120
Hex Tamper Proof - Plain Finish Bits..... 110	Ergonomic Auto Loading Cutter 120
Clutch Tamper Proof - Plain Finish Bits 110	Auto Loading Ergonomic Cutter with Silver Sheath 120
Spanner Tamper Proof - Plain Finish Bits..... 110	Auto Loading Ergonomic Cutter 120
Tri-Wing Tamper Proof - Plain Finish Bits..... 110	Auto Loading Cutter 120
Nut Drivers • Socket Holders.....111	Auto Loading Cutter with Holster..... 120
Magnetic Nut Drivers - Colour Coded 111	Specialty Cutters121
Deep Hole Nut Drivers - Colour Coded 111	Plastic Cutters 121
Magnetic Nut Drivers - Plain Finish 111	Bulk Plastic Cutters..... 121
Deep Hole Nut Drivers - Plain 111	Metal Blade..... 121
Metric Magnetic Nut Drivers - Plain Finish 111	Handy Key Chain Cutter 121
Socket Holders - Plain Finish 111	Safety Cutter, 2 Notch Utility Blade..... 121
Adapters • Bit Holders.....112	Replacement Safety Utility Blade For 550460..... 121
Magnetic Bit Holders..... 112	Razors • Utility Knives • Scrapers122
Ceiling Bit Holder 112	Razor Folding Utility Cutter 122
Counter-top BOSS Compact Driver Bit Display 112	Metal Utility Cutter with Thumb Lock..... 122
Retractable Collar - Magnetic Rim 112	Head Scraper with Thumb Lock 122
Magnetic Insert Holder 112	Plastic Window Scraper 122
Deck Driver with Stopper 112	Plastic Window Scraper with Thumb Lock 122
Quick Release - 6" Holder 112	3/4" Blade Refills.....123
Heavy Duty - Quick Change Adapter 112	Economy Blades DIY - 3/4" Blade 123
Bit Bar Sets.....113	Samuri Serrated Heavy Duty - 3/4" Blade..... 123
Robertson Sq#2 Bit Bar 113	Samuri Heavy Duty - 3/4" Blade 123
Customized Robertson Sq#2 Bit Bar 113	Hi Carbon Heavy Duty - 3/4" Blade..... 123
Assorted Robertson Bit Bar..... 113	1" Blades & Utility Blade Refills124
Customized Assorted Bit Bar 113	Samuri Mega Heavy Duty Blades - 1" Blade 124
Robertson Bit Bar 113	Standary Duty Blade - 3/8" Blade 124
Robertson Impact Bit Bar 113	2 Notch Utility Hook Blades - .5mm Thickness..... 124
Customized Robertson Impact Bit Bar 113	2 Notch Safety Utility Blade - .6mm Thickness..... 124
Tamper Proof Bit Bar..... 113	Serrated Utility Blade..... 124
Customized Tamper Proof Bit Bar 113	Single Edge Blade 124
Torque Bit Bar 113	Carpenter Pencils125
Customized Torque Bit Bar 113	12mm Carpenter Pencils..... 125
Bit Bar Sets.....114	15mm Carpenter Pencils..... 125
Assorted Robertson & Phillips Bit Bar 114	Carpenter Pencil Accessories 125
Customized Assorted Rob/Phil Bit Bar 114	Counter Top Display Products.....126
Robertson Sq#2 Bit Bar 114	Dual Head Stubby Ratchet..... 126
Customized Robertson Sq#2 Bit Bar 114	Stubby Claw Hammer 126
Magnetic Nut Drivers Bit Bar, 5 Pack 114	Cree LED 3W Focusing Light 126
Customized Magnetic Nut Drivers Bit Bar 114	8 LED with Laser Pointer..... 126
Assorted Robertson & Phillips Bit Bar 114	Padlocks127
Customized Assorted Robertson & Phillips Bit Bar 114	Padlocks 127
Robertson Impact Round Body Bit Bar 114	Combination Padlock - 1 / Package 127
Customized Robertson Impact Round Body Bit Bar..... 114	Waterproof Padlocks - 1 / Package..... 127
Assorted Robertson Bit Bar 114	Tape Measures.....128
Customized Assorted Robertson Bit Bar..... 114	Utility Grade - 6/Box..... 128
Phillips Bit Bar 115	Professional Grade - 12/Box..... 128
Customized Phillips Bit Bar 115	Tire Tape Measure 128
Phillips Bit Bar 115	Saw Blades • Drywall Saws129
Metric Magnetic Nut Drivers Bit Bar 115	Overtime Saw Blades 129
Customized Metric Magnetic Nut Bit Bar 115	Drywall Saws..... 129
Customized Assorted Impact Bit Bar..... 115	Specialty Tools.....130
Customized Magnetic Nut Drivers Bit Bar 115	Industrial Security Set 130
Assorted Impact Bit Bar..... 115	Magnetizer / Demagnetizer 130
Magnetic Nut Drivers Bit Bar 115	Damaged Screw Remover 130
Assorted Bit Sets116	9 Piece Allen Set - Ball Point S2 130
Professional Assortment Bits and Nut Drive Set 116	1/4" Ratchet Set..... 130
Professional Assortment Bits and Nut Drive Set 116	3 Piece Socket Adapter Set 130
Professional Assortment Impact Driver Bits..... 116	
Professional Assortment Impact Driver Bits..... 116	



Boss Tools and Accessories



Robertson - Plain Finish Bits

- 2 piece construction made of modified SL Japanese steel designed for 1/4" impact drivers.

PART#	SIZE	LENGTH	PART#	SIZE	LENGTH
78100	#0	1"	78132	#2	3"
78101	#1	1"	78133	#3	3"
78102	#2	1"	78134	#4	3"
78103	#3	1"	78141	#1	4"
78120	#0	2"	78142	#2	4"
78121	#1	2"	78143	#3	4"
78122	#2	2"	78151	#1	6"
78123	#3	2"	78152	#2	6"
78A22*	#2	2"	78153	#3	6"
78130	#0	3"	78182	#2	12"
78131	#1	3"			



*Image is not to scale

Robertson - Color Coded Bits

- 2 piece construction made of modified SL Japanese steel designed for 1/4" impact drivers.
- Only genuine Robertson® colour coded 1/4" hex driver bits have "Cling Fit". Made with our genuine Robertson® Tip

PART#	COLOUR	SIZE	LENGTH	PART#	COLOUR	SIZE	LENGTH
72100	Yellow	#0	1"	72133	Black	#3	3"
72101	Green	#1	1"	72141	Green	#0	4"
72102	Red	#2	1"	72142	Red	#1	4"
72103	Black	#3	1"	72143	Black	#2	4"
72120	Yellow	#0	2"	72151	Green	#0	6"
72121	Green	#1	2"	72152	Red	#1	6"
72122	Red	#2	2"	72153	Black	#2	6"
72123	Black	#3	2"	72181	Green	#0	12"
72130	Yellow	#0	3"	72182	Red	#1	12"
72131	Green	#1	3"	72183	Black	#2	12"
72132	Red	#2	3"				



*Image is not to scale

Sizes are approximate. Specifications subject to change without notice.



Boss Tools and Accessories

Driver Bits



Robertson - Branded Impact Bits

- 1 piece construction, colored sleeve, for 1/4" impact drivers.



PART#	COLOUR	SIZE	LENGTH
74121	Green Band	#1	2"
74122	Red Band	#2	2"

PART#	COLOUR	SIZE	LENGTH
74123	Black Band	#3	2"



*Image is not to scale



Robertson - Magnetic Impact Bits

- 1 piece construction, Colored sleeve, for 1/4" drivers

PART#	COLOUR	SIZE	LENGTH
75121	Green	#1	2"
75122	Red	#2	2"
75123	Black	#3	2"
75131	Green	#1	3"
75132	Red	#2	3"
75133	Black	#3	3"

PART#	COLOUR	SIZE	LENGTH
75141	Green	#1	4"
75142	Red	#2	4"
75143	Black	#3	4"
75151	Green	#1	6"
75152	Red	#2	6"
75153	Black	#3	6"



*Image is not to scale



Phillips - Colour Coded Bits

- Quality controlled engineering for maximum torque
- 1/4" hex shafts fit ball retainer and regular style chucks

PART#	COLOUR	SIZE	LENGTH
72200	Yellow	#0	1"
72201	Green	#1	1"
72202	Red	#2	1"
72203	Black	#3	1"
72220	Yellow	#0	2"
72221	Green	#1	2"
72222	Red	#2	2"
72223	Red	#2	4"
72230	Yellow	#0	3"
72231	Green	#1	3"

PART#	COLOUR	SIZE	LENGTH
72232	Red	#2	3"
72233	Black	#3	3"
72241	Green	#1	4"
72242	Red	#2	4"
72243	Black	#3	4"
72251	Green	#1	6"
72252	Red	#2	6"
72253	Black	#3	6"
72282	Red	#2	12"



*Image is not to scale

Sizes are approximate. Specifications subject to change without notice.



Slotted - Plain Finish Bits

- Quality controlled engineering for maximum torque
- 1/4" hex shafts fit ball retainer and regular style chucks



PART#	SIZE	LENGTH
78300	5/32"	1"
78301	3/16"	1"
78302	1/4"	1"
78303	9/32"	1"
78320	5/32"	2"
78321	3/16"	2"
78322	1/4"	2"

PART#	SIZE	LENGTH
78323	9/32"	2"
78331	3/16"	3"
78332	1/4"	3"
78341	3/16"	4"
78342	1/4"	4"
78351	3/16"	6"
78352	1/4"	6"



*Image is not to scale

Phillips - Plain Finish Bits

- Quality controlled engineering for maximum torque
- 1/4" hex shafts fit ball retainer and regular style chucks



PART#	SIZE	LENGTH
78200	#0	1"
78201	#1	1"
78202	#2	1"
78203	#3	1"
78210	#0	1-3/4"
78211	#1	30mm
78212	#2	30mm
78213	#3	30mm
78220	#0	2"
78221	#1	2"
78222	#2	2"
78223	#3	2"

PART#	SIZE	LENGTH
78230	#0	3"
78231	#1	3"
78232	#2	3"
78233	#3	3"
78234	#4	3"
78241	#1	4"
78242	#2	4"
78243	#3	4"
78251	#1	6"
78252	#2	6"
78253	#3	6"



*Image is not to scale



Sizes are approximate. Specifications subject to change without notice.



Boss Tools and Accessories

Driver Bits



TORX - Plain Finish Bits

- *Through Hardened for exceptional durability.*
- *1/4" Hex shafts*
- *Exact fit Torx tips for reduced cam out*

PART#	SIZE	LENGTH
78400	T10	1"
78401	T15	1"
78402	T20	1"
78403	T25	1"
78404	T30	1"
78405	T40	1"
78406	T27	1"
78417	T7	2"
78418	T8	2"
78419	T9	2"
78420	T10	2"
78421	T15	2"
78422	T20	2"
78423	T25	2"

PART#	SIZE	LENGTH
78424	T30	2"
78425	T40	2"
78426	T27	2"
78427	T45	2"
78428	T50	2"
78429	T55	2"
78430	T10	3"
78431	T15	3"
78432	T20	3"
78433	T25	3"
78434	T30	3"
78435	T40	3"
78436	T27	3"



**Image is not to scale*



Hex / Allen - Plain Finish

- *Ideal for automotive and machinery fasteners*
- *1/4" hex shaft fits ball retainer and regular style chucks*
- *Chrome vanadium steel construction to withstand heavy use*

PART#	SIZE	LENGTH
78500	3/32"	1"
78501	7/64"	1"
78502	1/8"	1"
78503	9/64"	1"
78504	5/32"	1"
78505	3/16"	1"
78506	7/32"	1"
78507	1/4"	1"
78520	3/32"	2"
78521	7/64"	2"
78522	1/8"	2"
78523	9/64"	2"

PART#	SIZE	LENGTH
78524	5/32"	2"
78525	3/16"	2"
78526	7/32"	2"
78527	1/4"	2"
78530	3/32"	3"
78531	7/64"	3"
78532	1/8"	3"
78533	9/64"	3"
78534	5/32"	3"
78535	3/16"	3"
78536	7/32"	3"
78537	1/4"	3"



**Image is not to scale*

Sizes are approximate. Specifications subject to change without notice.

BOSS

Boss Tools and Accessories



Pozi - Plain Finish Bits

- Blunt tip for better seating
- Straight sides for additional torque

- 1/4" Hex shafts



PART#	SIZE	LENGTH
78600	#0	1"
78601	#1	1"
78602	#2	1"
78603	#3	1"
78620	#0	2"
78621	#1	2"

PART#	SIZE	LENGTH
78622	#2	2"
78623	#3	2"
78630	#0	3"
78631	#1	3"
78632	#2	3"
78633	#3	3"



*Image is not to scale

Drywall - Plain / Brass Finish Bits

- Blunt tip for better seating
- Straight sides for additional torque

- 1/4" Hex shafts



PART#	SIZE	LENGTH
72228	#2	1" Brass
72229	#2	2" Brass
78205 *	#2	2"

PART#	SIZE	LENGTH
78228	#2	1"
78229	#2	1"
80228 **	#2	1"



*Image is not to scale

* ACR

**With Stopper



Torque Tamper Proof - Plain Finish Bits

- Blunt tip for better seating
- Straight sides for additional torque

- 1/4" hex shafts



PART#	SIZE	L
78450	T10	2"
78451	T15	2"
78452	T20	2"
78453	T25	2"

PART#	SIZE	L
78454	T27	2"
78455	T30	2"
78456	T40	2"



*Image is not to scale

Sizes are approximate. Specifications subject to change without notice.

Boss Tools and Accessories

Driver Bits



Hex Tamper Proof - Plain Finish Bits

- Blunt tip for better seating
- Straight sides for additional torque
- 1/4" hex shafts

PART#	SIZE	LENGTH
78551	3/32	2"
78552	7/64	2"
78553	1/8	2"
78554	9/64	2"

PART#	SIZE	LENGTH
78555	5/32	2"
78556	3/16	2"
78557	7/32	2"
78558	1/4	2"



*Image is not to scale



Clutch Tamper Proof - Plain Finish Bits

- Blunt tip for better seating
- Straight sides for additional torque
- 1/4" hex shafts

PART#	SIZE	LENGTH
78700	3/32"	1"
78701	5/32"	1"
78702	3/16"	1"

PART#	SIZE	LENGTH
78703	1/4"	1"
78705	1/8"	1"



*Image is not to scale



Spanner Tamper Proof - Plain Finish Bits

- Blunt tip for better seating
- Straight sides for additional torque
- 1/4" hex shafts

PART#	SIZE	LENGTH
78806	#6	2"
78808	#8	2"

PART#	SIZE	LENGTH
78810	#10	2"
78812	#12	2"



*Image is not to scale



Tri-Wing Tamper Proof - Plain Finish Bits

- Blunt tip for better seating
- Straight sides for additional torque
- 1/4" hex shafts

PART#	SIZE	LENGTH
78920	TRI-WING #0	2"
78921	TRI-WING #1	2"
78922	TRI-WING #2	2"

PART#	SIZE	LENGTH
78923	TRI-WING #3	2"
78924	TRI-WING #4	2"
78925	TRI-WING #5	2"



*Image is not to scale

Sizes are approximate. Specifications subject to change without notice.

BOSS

BOSS Tools and Accessories

Magnetic Nut Drivers - Colour Coded

PART#	COLOUR	HEAD	LENGTH	DIA
73110	Yellow	1/4"	2-1/2"	1/4"
73111	Green	5/16"	2-1/2"	1/4"
73112	Red	3/8"	2-1/2"	1/4"
73113	Brass	7/16"	2-1/2"	1/4"
73114	Black	1/2"	2-1/2"	1/4"
73115	Blue	9/16"	2-1/2"	1/4"



*Image is not to scale

Deep Hole Nut Drivers - Plain Finish

PART#	HEAD	LENGTH	DIA
79210	1/4"	2-1/2"	1/4"
79211	5/16"	2-1/2"	1/4"
79212	3/8"	2-1/2"	1/4"
79213	7/16"	2-1/2"	1/4"
79214	1/2"	2-1/2"	1/4"



*Image is not to scale

Deep Hole Nut Drivers - Colour Coded

PART#	COLOUR	HEAD	LENGTH	DIA
73210	Yellow	1/4"	2-1/2"	1/4"
73211	Green	5/16"	2-1/2"	1/4"
73212	Red	3/8"	2-1/2"	1/4"
73213	Brass	7/16"	2-1/2"	1/4"
73214	Black	1/2"	2-1/2"	1/4"



*Image is not to scale

Metric Magnetic Nut Drivers - Plain Finish

PART#	HEAD	LENGTH	DIA
79707	#7	2-1/2"	1/4"
79708	#8	2-1/2"	1/4"
79709	#9	2-1/2"	1/4"
79710	#10	2-1/2"	1/4"
79712	#12	2-1/2"	1/4"
79715	#15	2-1/2"	1/4"
79717	#17	2-1/2"	1/4"



*Image is not to scale

Magnetic Nut Drivers - Plain Finish

PART#	HEAD	LENGTH	DIA
79110	1/4"	2-1/2"	1/4"
79111	5/16"	2-1/2"	1/4"
79112	3/8"	2-1/2"	1/4"
79113	7/16"	2-1/2"	1/4"
79114	1/2"	2-1/2"	1/4"
79310	1/4"	6"	1/4"
79311	5/16"	6"	1/4"
79312	3/8"	6"	1/4"
79313	7/16"	6"	1/4"
79314	1/2"	2-1/2"	1/4"
79410	1/4"	1-3/4"	1/4"
79411	5/16"	1-3/4"	1/4"
79412	3/8"	1-3/4"	1/4"
79413	7/16"	1-3/4"	1/4"



*Image is not to scale

Socket Holders - Plain Finish

PART#	HEAD	LENGTH	DIA
79050	1/4"	1"	1/4"
79150	1/4"	2"	1/4"
79151	1/4"	3"	1/4"
79152	1/4"	4"	1/4"
79153	1/4"	6"	1/4"
79352	3/8"	2-9/16"	1/4"
79353	1/2"	2-3/4"	1/4"
79560	3/8"	2-9/16"	5/16"
79580	1/2"	2-9/16"	5/16"
79660	3/8"	2-9/16"	7/16"
79664	3/8"	4"	7/16"
79860	1/2"	2-9/16"	7/16"
79864	1/2"	4"	7/16"



*Image is not to scale

Sizes are approximate. Specifications subject to change without notice.



Boss Tools and Accessories

Adapters • Bit Holders

Retractable Collar - Magnetic Rim

PART#	TYPE	HOLDER	LENGTH	DIA
79262	Magnet	1/4"	2-1/2"	1/4"



*Image is not to scale

Deck Driver with Stopper

PART#	TYPE	HOLDER	LENGTH
82122	Sq#2 with Stopper	1/4"	2



*Image is not to scale

Magnetic Bit Holders

PART#	HOLDER	LENGTH	DIA
79260	1/4"	2-1/2"	1/4"
79264	1/4"	4"	1/4"



*Image is not to scale

Quick Release - 6" Holder

PART#	TYPE	HOLDER	LENGTH	DIA
79284	Magnet	1/4"	6"	1/4"



*Image is not to scale

Ceiling Bit Holder

PART#	HOLDER	LENGTH	DIA
79268	1/4"	2-1/2"	1/4"



*Image is not to scale

Heavy Duty - Quick Change Adapter

PART#	HOLDER	LENGTH	DIA
79440	1/4"	2"	1/4"



*Image is not to scale

Magnetic Insert Holder

PART#	HOLDER	LENGTH	DIA
79258	1/4"	2-3/8"	1/4"



*Image is not to scale

Counter-top BOSS Compact Driver Bit Display

#1 Acrylic Bit Display

Magnetic 1/4" to 1/2"

Robertson #1, #2, #3 from 2" to 6"

Socket Adapters

PART#	CONTENTS
100859	Driver Bit Kit Display Only . Includes decals.
77799	Full Driver Bit Kit Merchandiser . Includes display, labels and 307 pieces

NO. PIECES	LENGTH	WIDTH	HEIGHT
307	5"	7"	9"



Sizes are approximate. Specifications subject to change without notice.



BOSS Tools and Accessories





771225 - Robertson Sq#2 Bit Bar, 10 Pack

9771225 - Customized Robertson Sq#2 Bit Bar, 10 Pack

PART#	DESCRIPTION	QUANTITY
78122	S2 Sq#2 x 2"	10



711252 - Assorted Robertson Bit Bar, 10 Pack

9711252 - Customized Assorted Robertson Bit Bar, 10 Pack

PART#	DESCRIPTION	QUANTITY
74121	#1 x 2" Robertson Impact Bit	2
74122	#2 x 2" Robertson Impact Bit	6
74123	#3 x 2" Robertson Impact Bit	2



711269 - Robertson Impact Bit Bar, 10 Pack

9711269 - Customized Robertson Impact Bit Bar, 10 Pack

PART#	DESCRIPTION	QUANTITY
74122	#2 x 2" Robertson Impact Bit Colored Band	10

Sizes are approximate. Specifications subject to change without notice.



774219 - Tamper Proof Bit Bar, 10 Pack

9774219 - Customized Tamper Proof Bit Bar, 10 Pack

PART#	DESCRIPTION	QUANTITY
78450	Tamper Proof Torque T10 x 2"	1
78451	Tamper Proof Torque T15 x 2"	1
78452	Tamper Proof Torque T20 x 2"	1
78453	Tamper Proof Torque T25 x 2"	1
78454	Tamper Proof Torque T27 x 2"	1
78455	Tamper Proof Torque T30 x 2"	1
78456	Tamper Proof Torque T40 x 2"	1
78806	Spanner SP#6 x 2"	1
78808	Spanner SP#8 x 2"	1
78810	Spanner SP#10 x 2"	1



774202 - Torque Bit Bar, 10 Pack

9774202 - Customized Torque Bit Bar, 10 Pack

PART#	DESCRIPTION	QUANTITY
78417	S2 Torque T7 x 2"	1
78418	S2 Torque T8 x 2"	1
78419	S2 Torque T9 x 2"	1
78420	S2 Torque T10 x 2"	1
78421	S2 Torque T15 x 2"	1
78422	Torque T20 x 2"	1
78423	Torque T25 x 2"	1
78424	Torque T30 x 2"	1
78425	Torque T40 x 2"	1
78426	S2 Torque T27 x 2"	1



Boss Tools and Accessories

Bit Bar Sets

BOSS



711201 - Assorted Robertson & Phillips Bit Bar, 10 Pack

9711201 - Customized Assorted Robertson & Phillips Bit Bar, 10 Pack

PART#	DESCRIPTION	QUANTITY
72120	Sq#0 x 2" 2pc Yellow	1
72121	Sq#1 x 2" 2pc Green	1
72122	Sq#2 x 2" 2pc Red	1
72123	Sq#3 x 2" 2pc Black	1
72220	Phillips #0 x 2" Yellow	1
72221	Phillips #1 x 2" Green	1
72222	Phillips #2 x 2" Red	1
72223	Phillips #3 x 2" Black	1
78321	S2 Slotted 3/16"x2"	1
78323	S2 Slotted 9/32"x2"	1



711221 - Robertson Sq#2 Bit Bar, 10 Pack

9711221 - Customized Robertson Sq#2 Bit Bar, 10 Pack

PART#	DESCRIPTION	QUANTITY
72122	Sq#2 x 2" 2pc Red	10

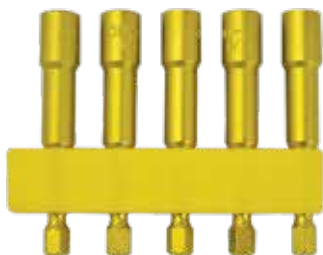

711103 - Magnetic Nut Drivers Bit Bar, 5 Pack

9711103 - Customized Magnetic Nut Drivers Bit Bar, 5 Pack

PART#	DESCRIPTION	QUANTITY
78122	1/4" Magnetic Nut Driver, 2.5"	5



711276 - Assorted Robertson & Phillips Bit Bar, 10 Pack

9711276 - Customized Assorted Robertson & Phillips Bit Bar, 10 Pack

PART#	DESCRIPTION	QUANTITY
72121	Sq#1 x 2" 2pc Green	2
72122	Sq#2 x 2" 2pc Red	3
72123	Sq#3 x 2" 2pc Black	1
72221	Phillips #1 x 2" Green	1
72222	Phillips #2 x 2" Red	2
72223	Phillips #3 x 2" Black	1



711294 - Robertson Impact Round Body Bit Bar, 10 Pack

9711294 - Customized Robertson Impact Round Body Bit Bar, 10 Pack

PART#	DESCRIPTION	QUANTITY
75122	Mag. Robertson Impact # 2 x 2"	10



711245 - Assorted Rob. Bit Bar, 10 Pack

9711245 - Customized Assorted Rob. Bit Bar, 10 Pack

PART#	DESCRIPTION	QUANTITY
72121	Sq #1 x 2" - 2pc Green	3
72122	Sq #2 x 2" - 2pc Red	5
72123	Sq #3 x 2" - 2pc Black	2

Sizes are approximate. Specifications subject to change without notice.

Boss Tools and Accessories





712228 - Phillips Bit Bar, 10 Pack
9712228 - Customized Phillips Bit Bar, 10 Pack

PART#	DESCRIPTION	QUANTITY
72222	Phillips #2 x 2" Red	10



774208 - Phillips Bit Bar, 10 Pack

PART#	DESCRIPTION	QUANTITY
78420	Torque T10 x 2"	3
78423	Torque T25 x 3"	4
78424	Torque T30 x 2"	3

THIS ITEM IS

CUSTOMIZABLE

Customized items create exceptionally long-lasting advertising opportunities and at a low cost. Let Dynaline help your business achieve the exposure you want.



Contact our Customer Service for pricing and availability today

Sizes are approximate. Specifications subject to change without notice.



777586 - Metric Magnetic Nut Drivers Bit Bar, 5 Pack
9777586 - Customized Metric Magnetic Nut Drivers Bit Bar, 5 Pack

PART#	DESCRIPTION	QUANTITY
79708	Metric Magnetic Nut Driver #8x 2.5" long	1
79709	Metric Magnetic Nut Driver #9x 2.5" long	1
79710	Metric Magnetic Nut Driver #10 x 2.5" long	1
79712	Metric Magnetic Nut Driver #12 x 2.5" Long	1
79715	Metric Magnetic Nut Driver 15mm x 65mm	1



711306 - Assorted Impact Bit Bar, 10 Pack
9711306 - Customized Assorted Impact Bit Bar, 10 Pack

PART#	DESCRIPTION	QUANTITY
72221	Phillips #1 x 2" - Green	1
72222	Phillips #2 x 2" - Red	2
72223	Phillips #3 x 2" - Black	1
75121	Mag. Robertson Impact #1 x 2" - Green	2
75122	Mag. Robertson Impact #2 x 2" - Red	3
75123	Mag. Robertson Impact #3 x 2" - Black	1



717186 - Magnetic Nut Drivers Bit Bar, 5 Pack
9717186 - Customized Magnetic Nut Drivers Bit Bar, 5 Pack

PART#	DESCRIPTION	QUANTITY
73110	Magnetic Nut Driver 1/4" x 2.5 - Yellow	1
73111	Magnetic Nut Driver 5/16" x 2.5" - Green	1
73112	Magnetic Nut Driver 3/8" x 2.5 - Red	1
73113	Magnetic Nut Driver 7/16" x 2.5" - Brass	1
73114	Magnetic Nut Driver 1/2" x 2.5 - Black	1



Boss Tools and Accessories

Assorted Bit Sets



*Image is not to scale

721386 - Professional Assortment Bits and Nut Drive Set, 18 Pack 9721386 - Professional Assortment Bits and Nut Drive Set, 18 Pack

PART#	DESCRIPTION	QUANTITY
72122	Sq#2 x 2" 2pc Red	2
72220	Ph#0 x 2" Yellow	1
72120	Sq#0 x 2" 2pc Yellow	1
72121	Sq#1 x 2" 2pc Green	1
72123	Sq#3 x 2" 2pc Black	1
72221	Ph#1 x 2" Green	1
72222	Ph#2 x 2" Red	2
72223	Ph#3 x 2" Black	1
73110	1/4" x 2.5" long Magnetic Nut Drive Yellow	1
73111	5/16" x 2.5" long Magnetic Nut Drive Green	1
73112	3/8" x 2.5" long Magnetic Nut Drive Red	1
73113	Brass Mag Nut Drive 7/16" x 2.5" long	1
73114	Black Mag Nut Drive 1/2" x 2.5" long	1
78321	S2 SL3/16"x2"	1
78323	S2 SL9/32"x2"	1
79260	Mag Insert Hold 1/4"x 60mm	1

721374 - Professional Assortment Impact Driver Bits, 18 Pack 9721374 - Professional Assortment Impact Driver Bits, 18 Pack

PART#	DESCRIPTION	QUANTITY
74121	#1 x 2" Robertson Impact Bit	1
74122	#2 x 2" Robertson Impact Bit	3
74123	#3 x 2" Robertson Impact Bit	1
72221	Phillips #1 x 2" - Green	1
72222	Phillips #2 x 2" - Red	2
72223	Phillips #3 x 2" - Black	1
78420	S2 TorqT10 x 2"	1
78421	S2 TorqT15 x 2"	1
78422	S2 TorqT20 x 2"	1
73110	1/4" x 2.5" Magnetic Nut Driver - Yellow	1
73111	5/16" x 2.5" Magnetic Nut Driver - Green	1
73112	3/8" x 2.5" Magnetic Nut Driver - Red	1
79150	Socket Holder 1/4" x 2" long	1
79352	Socket Holder 3/8" x 2.56" long	1
79353	Socket Holder 1/2" x 2.83" long	1

THIS ITEM IS

CUSTOMIZABLE

CUSTOMIZED ITEMS CREATE EXCEPTIONALLY LONG-LASTING ADVERTISING OPPORTUNITIES, AND AT A LOW COST, IT CAN HELP YOUR BUSINESS ACHIEVE HIGH PROMOTIONAL RETURN AND REPEAT BUSINESS.

Contact our Customer Service for pricing and availability today



Sizes are approximate. Specifications subject to change without notice.



Boss Tools and Accessories



Cobalt Drill Bits feat. Grizzly Tip

All bits are packaged for easy retail.

PART#	DESCRIPTION	QTY/PKG	QTY/BOX
851000	1/16"	2	6
851002	5/64"	2	6
851004	3/32"	2	6
851006	7/64"	2	6
851008	1/8"	2	6
851010	9/64"	1	6
851012	5/32"	1	6
851014	11/64"	1	6
851016	3/16"	1	6
851018	13/64"	1	6
851020	7/32"	1	6
851022	15/64"	1	6
851024	1/4"	1	6
851026	17/64"	1	6
851028	9/32"	1	6
851030	19/64"	1	6
851032	5/16"	1	6
851034	21/64"	1	6
851036	11/32"	1	6
851038	23/64"	1	6
851040	3/8"	1	6
851042	25/64"	1	6
851044	13/32"	1	6
851046	27/64"	1	6
851048	7/16"	1	6
851050	29/64"	1	6
851052	15/32"	1	6
851054	31/64"	1	6
851056	1/2"	1	6



*Image is not to scale



GRIZZLY TIP

Grizzly Tip™ is exclusively available from BOSS. It has excellent self centering characteristics. The center split point starts the cutting with the two sides (tips of the flutes) following close behind it providing 4 cutting edges. This increases the speed and smoothness of the drill and hole.



SOLID CONSTRUCTION

M35 is a high speed steel in the tungsten molybdenum series with 5% cobalt added. The additional cobalt increase heat resistance. The carbides in it are small and evenly distributed. It has high wear resistance. After heat treatment, its hardness is the same as T1, but its bending strength can reach 4700 MPa. It's toughness and thermoplasticity are higher than T1 by 50%.



3 GROUND FLAT

The triangle shank is made by machining three flats on a round bar stock. It is intended as a minor modification of a straight shank, still allowing it to be held in a 3-jaw drill chuck, also allowing higher TORX transmission and limited slipping.



Be a Boss!

Dynaline offers multiple options of merchandisers. Give your customers the products from the brand they know and trust. For information on Boss merchandisers see the Merchandiser section.



Sizes are approximate. Specifications subject to change without notice.



Boss Tools and Accessories

Plastic Cutters

BOSS

BOSS Tools and Accessories



Plastic Cutter, 3/4" Blade

Available in Multiple color options and arrives in easy to setup counter-top display. The customization options available make it the perfect item to provide your business with more exposure.

NON-CUSTOM PRINTED		CUSTOM PRINTED			
PART#	PART #	COLOUR	SHEATH/ LOCK	BLADE/ BL. GRADE	BOX/ CASE
2558228	9008228	Red	Plastic / Thumb	3/4" / DIY	48 / 480
2558229	9008229	Dark Green	Plastic / Thumb	3/4" / DIY	48 / 480
2558230	9008230	Blue	Plastic / Thumb	3/4" / DIY	48 / 480
2558231	9008231	Yellow	Plastic / Thumb	3/4" / DIY	48 / 480
2558232	9008232	Orange	Plastic / Thumb	3/4" / DIY	48 / 480
2558233	9008233	Light Green	Plastic / Thumb	3/4" / DIY	48 / 480
2558234	9008234	Black	Plastic / Thumb	3/4" / DIY	48 / 480

Heavy Duty Plastic Cutter, 3/4" Blade

This heavier plastic construction cutter is available in three color options and arrives in easy to setup counter-top display. The customization options available make it the perfect item to provide your business with more exposure.

NON-CUSTOM PRINTED		CUSTOM PRINTED			
PART#	PART #	COLOUR	SHEATH/ LOCK	BLADE/ BL. GRADE	BOX/ CASE
2558806	9008806	Red	Plastic / Thumb	3/4" / DIY	48 / 480
2558807	9008807	Yellow	Plastic / Thumb	3/4" / DIY	48 / 480
2558808	9008808	Blue	Plastic / Thumb	3/4" / DIY	48 / 480

Heavy Duty Plastic Cutter w/ Metal Reinforced Head, 3/4" Blade

This heavy duty plastic cutter features metal reinforced head for durability. The customization options available make it the perfect item to provide your business with more exposure.

NON-CUSTOM PRINTED		CUSTOM PRINTED			
PART#	PART#	COLOUR	SHEATH/ LOCK	BLADE/BL. GRADE	BOX/ CASE
2558066	9008066	Red	Plastic / Thumb	3/4" / DIY	48 / 820
2558067	9008067	Blue	Plastic / Thumb	3/4" / DIY	48 / 480
2558068	9008068	Yellow	Plastic / Thumb	3/4" / DIY	48 / 480

THIS ITEM IS

CUSTOMIZABLE

CUSTOMIZED ITEMS CREATE EXCEPTIONALLY LONG-LASTING ADVERTISING OPPORTUNITIES, AND AT A LOW COST, IT CAN HELP YOUR BUSINESS ACHIEVE HIGH PROMOTIONAL RETURN AND REPEAT BUSINESS.

Contact our Customer Service for pricing and availability today



Sizes are approximate. Specifications subject to change without notice.



Ergo Grip Cutter, 3/4" Blade

This heavier plastic construction cutter includes rubber elements to ensure the best grip possible. Available in a double-lock switch and knob-lock option. The customization options available make it the perfect item to provide your business with more exposure.

BULK	PACKAGED	CUSTOM PRINTED		
PART#	PART#	PART#	SHEATH/LOCK	BOX/CASE
548687	568687	9008687	Auto Lock/Double Locking	10/120
548688	568688	9008687	Knob Lock/Oversized Knob	10/60



Comfort Grip Cutter, 3/4" Blade

The heavier plastic construction is formed to fit the hand to provide ergonomic support and comfort. Available in a double-lock switch and knob-lock option.

BULK	PACKAGED		
PART#	PART#	SHEATH/LOCK	BOX/CASE
546750	556750	Comfort Grip Knob Lock/Oversized Knob	10/120
546760	556760	Comfort Grip Auto Lock/Double Locking	10/100



Heavy Duty Knob Lock Cutter, 3/4" Blade

This heavier plastic construction cutter is available in three color options and arrives in easy to setup counter-top display. The customization options available make it the perfect item to provide your business with more exposure.

BULK	PACKAGED		
PART#	PACK#	SHEATH/LOCK	BOX/CASE
2250425	2260425	HD Plastic 2 Blade Storage/Knob Lock	10/100



Mega Blade Cutters, 1" Blade

This heavy duty cutter uses a 1" blade for those heavy duty applications. The metal reinforced head improves the durability for those hard jobs. The cutter is available in auto-lock switch and knob-lock options.

BULK	PACKAGED		
PART#	PART#	SHEATH/LOCK	BOX/CASE
546900	556900	Stainless/Knob	10/120
546920	556920	Stainless/Auto	10/120



Ergonomic Serrated Blade Cutter, 3/4" Blade

This ergonomic cutter supports serrated blades for tougher jobs. The metal reinforced head also improves durability and prevents damage.

BULK	PACKAGED		
PART#	PART#	SHEATH/LOCK	BOX/CASE
N/A	2262600	Ergo Grip Serrated Blade/ Auto Lock	10/60



Sizes are approximate. Specifications subject to change without notice.





Ergonomic Auto Loading Cutter, 3/4" Blade

This ergonomic cutter features a metal reinforced head for durability and stores 6 blades for continual usage. Dual locking mechanism.

BULK		PACKAGED		
PART#	PART#	SHEATH	LOCK	BOX/ CASE
2550430	2560430	Stainless	Auto & Knob	10/100



Auto Loading Ergonomic Cutter with Silver Sheath, 18mm Blade

This auto loading cutter features a sleek silver sheath with 5 blade storage for continual usage. Only offered in a display card package for easy retail and restock.

BULK		PACKAGED		
PART#	PACK#	SHEATH	LOCK	BOX/ CASE
N/A	550470	Stainless	Auto	10/100



Auto Loading Ergonomic Cutter, 25mm" Blade

This heavy duty plastic auto loading cutter features 5 blade storage for continual usage. Only offered in a display card package for easy retail and restock.

BULK		PACKAGED		
PART#	PACK#	SHEATH	LOCK	BOX/ CASE
N/A	550480	Stainless	Auto	10/100



Auto Loading Cutter, 3/8" Blade

This auto loading ergonomic cutter stores up to 6 blades at a time for continual usage. This cutter uses smaller 3/8" blades for more precision jobs.

BULK		PACKAGED		
PART#	PART#	SHEATH	LOCK	BOX/ CASE
2550406	2560406	Stainless	Auto	60/240



Auto Loading Cutter with Holster, 3/4" Blade

This auto loading cutter can store 8 blades for continual use without slowing down you work. It includes a plastic holster.

BULK		PACKAGED		
PART#	PART#	SHEATH	LOCK	BOX/ CASE
550440	N/A	Stainless	Auto	10/100



Sizes are approximate. Specifications subject to change without notice.



Plastic Cutters, 3/8" Blade

This plastic cutter supports 3/8" blades and is available in two colour options.

BULK		PACKAGED		
PART#	PART#	COLOUR	SHEATH/ LOCK	BOX/ CASE
N/A	2558129	Yellow	Plastic / Thumb	60 / 120
N/A	2558130	Blue	Plastic / Thumb	60 / 120



Bulk Plastic Cutters, 3/8" Blade

This plastic cutter supports 3/8" blades are available in packaged or bulk options.

BULK		PACKAGED		
PART#	PART#	COLOUR	SHEATH/ LOCK	BOX/ CASE
2550008	2560008	Yellow	Plastic / Thumb	100 / 500
2550009	2560009	Blue	Plastic / Auto	60 / 120



Metal Blade, 3/8" Blade

A solid metal frame cutter with stainless steel clip option. Available bulk or packaged in Boss jewel case for easy display and restock.

BULK		PACKAGED		
PART#	PART#	SHEATH		BOX/CASE
2550100	2560100	Standard Metal Cutter		60/240
2550200	2560200	Standard Metal Cutter with stainless steel pocket clip		60/240



Handy Key Chain Cutter, 3/8" Blade

This small cutter comes with a key chain attachment and is great for portability.

BULK		PACKAGED		
PART#	PART#	COLOUR	SHEATH/ LOCK	BOX/ CASE
2550151	2560151	Red	Plastic / Touch	60 / 120



Safety Cutter, 2 Notch Utility Blade

The safety cutter retracts deeply so the blade cannot get accidentally exposed.

BULK		PACKAGED		
PART#	SHEATH/LOCK		BOX/CASE	
550460	Comfort Safety Cutter/ Metal Reinforced		12/24	

Replacement Safety Utility Blade For 550460 - .6mm Thickness

PART#	PACK SIZE
2554407	10 pack



Sizes are approximate. Specifications subject to change without notice.



Boss Tools and Accessories

Razors • Utility Knives • Scrapers



Razor Folding Utility Cutter

- Aluminum body
- Only available in clamshell packaging for easy retail and restock



BULK	PACKAGED			
PART#	PART#	SHEATH/LOCK	POP DISPLAY	BOX/CASE
N/A	559110	Aluminum / Folding	Box of 12	12/48



Metal Utility Cutter with Thumb Lock

- Easy to change blade
- Clamshell packaging option for easy retail and restock

BULK	PACKAGED			
PART#	PART#	SHEATH/ LOCK	BLADE/ BL. GRADE	BOX/ CASE
2551802	2561802	Metal / Thumb	Utility / Contractor	60/120



Head Scraper with Thumb Lock

- Easy to change blade
- Clamshell packaging option for easy retail and restock

BULK	PACKAGED			
PART#	PART#	SHEATH/ LOCK	BLADE/ BL. GRADE	BOX/ CASE
2550488	2560488	Plastic / Thumb	Utility / Contractor	60/120



Plastic Window Scraper

- Storage thumb lock
- Clamshell packaging option for easy retail and restock

BULK	PACKAGED			
PART#	PART#	SHEATH/ LOCK	BLADE/ BL. GRADE	BOX/ CASE
2553208	2563208	Plastic / Thumb	Single / DIY	60/120



Plastic Window Scraper with Thumb Lock

- Easy to change blade
- Clamshell packaging option for easy retail and restock

BULK	PACKAGED			
PART#	PART#	SHEATH/ LOCK	BLADE/ BL. GRADE	BOX/ CASE
N/A	2568208	Plastic / Thumb	Utility / Contractor	60/120

Sizes are approximate. Specifications subject to change without notice.

BOSS

Boss Tools and Accessories



Economy Blades DIY - 3/4" Blade .5mm Thickness

PART#	PACK SIZE	CUTTING EDGES
2554003	10 pack	8
2554033	50 pack	8



Samuri Serrated Heavy Duty - 3/4" Blade .6mm Thickness

- *Sk2 + CR formulation means it stays sharper, longer*
- *Double honed edge for maximum sharpness*

PART#	PACK SIZE	CUTTING EDGES
2554303	5 pack	8
2554333	45 pack	8



Samuri Heavy Duty - 3/4" Blade .5mm Thickness

- *Sk2 + CR formulation means it stays sharper, longer*
- *Double honed edge for maximum sharpness*

PART#	PACK SIZE	CUTTING EDGES
2555010	10 pack	8
2555050	50 pack	8



Hi Carbon Heavy Duty - 3/4" Blade .5mm Thickness

- *SAE 1125 stress proof steel, honed*

PART#	PACK SIZE	CUTTING EDGES
2554403	10 pack	8
2554433	50 pack	8



Sizes are approximate. Specifications subject to change without notice.



Boss Tools and Accessories

1" Blades • Utility Blades



Boss Tools and Accessories



Samuri Mega Heavy Duty Blades - 1" Blade .7mm Thickness

- Sk2 + CR formulation means it stays sharper, longer
- Double honed edge for maximum sharpness

PART#	BULK PART#	PACK SIZE	CUTTING EDGES
2555403	2555413	5 pack	8



Standard Duty Blade - 3/8" Blade

- Sk2 + CR formulation means it stays sharper, longer
- Double honed edge for maximum sharpness

PART#	PACK SIZE	CUTTING EDGES
2555110	10 pack	12



2 Notch Utility Hook Blades - .5mm Thickness

PART#	PACK SIZE
2554402	10 pack



2 Notch Safety Utility Blade - .6mm Thickness

PART#	PACK SIZE
2554405	10 pack



Serrated Utility Blade

PART#	PACK SIZE
2554305	10 pack



Single Edge Blade

PART#	PACK SIZE
2554404	10 pack



Sizes are approximate. Specifications subject to change without notice.



12mm Carpenter Pencils

12mm carpenter pencils are available in 4 colors and available for custom printing to increase the exposure of your business.

NON-CUSTOM PRINTED	CUSTOM PRINTED			
PART#	PART#	COLOUR	LEAD	BOX/CASE
33801	900801	Fl. Pink	Medium	72/ 1440
33880	900880	Fl. Orange	Soft	72/ 1440
33890	900890	Fl. Green	Hard	72/ 1440
33900	900900	Red	Red/Black	72/ 1440



BOSS

15mm Carpenter Pencils

15mm carpenter pencils are available in 7 colors and available for custom printing to increase the exposure of your business.

NON-CUSTOM PRINTED	CUSTOM PRINTED			
PART#	PART#	COLOUR	LEAD	BOX/CASE
33810	900810	Yellow	Medium	60 /1200
33820	900820	Red	Medium	60 /1200
33830	900830	Blue	Medium	60 /1200
33840	900840	Orange	Medium	60 /1200
33850	900850	White	Medium	60 /1200
33860	900860	Dark Blue	Medium	60 /1200
33870	900870	Black	Medium	60 /1200



THIS ITEM IS

CUSTOMIZABLE



CUSTOMIZED ITEMS CREATE EXCEPTIONALLY LONG-LASTING ADVERTISING OPPORTUNITIES, AND AT A LOW COST, IT CAN HELP YOUR BUSINESS ACHIEVE HIGH PROMOTIONAL RETURN AND REPEAT BUSINESS.

Contact our Customer Service for pricing and availability today

ADD YOUR OWN LOGO



Carpenter Pencil Accessories

PART#	DESCRIPTION	BOX
33670	Aluminum Carpenter Pencil Holder	12
33788	Pro Carpenter Pencil Sharpener	50
33105	9" Level, Carpenter Pencil w/ Sharpener	6



Sizes are approximate. Specifications subject to change without notice.





Boss Tools and Accessories



Dual Head Stubby Ratchet

PART#	DESCRIPTION	PACK
441802	1/4" and 3/8" driver head. Small size makes it great for mobility and those tight spaces.	12/Display Box*

**Sold individually. Display box available with purchase of 12 or more.*



Stubby Claw Hammer

PART#	DESCRIPTION	PACK
441806	Small size makes it great for mobility and those tight spaces.	12/Display Box*

**Sold individually. Display box available with purchase of 12 or more.*



Cree LED 3W Focusing Light

PART#	DESCRIPTION	PACK
234439	3 W 3 x AAA Super Brite Cree LED. CREE Diode, push button, anodized aircraft aluminum body.	8/Display Box

**Sold individually. Display box available with purchase of 8 or more.*



8 LED with Laser Pointer

PART#	DESCRIPTION	PACK
234440	8 LED with Laser Pointer 3 x AAA. Functions LED, laser and LED with laser.	8/Display Box

**Sold individually. Display box available with purchase of 8 or more.*

Sizes are approximate. Specifications subject to change without notice.





Padlocks

- Double locking mechanism
- Hardened steel shackle, chrome plated
- Stainless steel & hardened spring for any climate
- Solid brass case
- Anti-pick mushroom pins

PART #	TYPE	PACK QTY.	SIZE (MM)	A (MM)	B (MM)	C (MM)	D (MM)	E (MM)	F (MM)	LOCKING	PINS
2251525	KD	1	25 x 14	25	24.5	14.1	4	12.7	11.9	Single	4
2251526	KA	2									
2251530	KD	1	30 x 20	30	27.5	17.5	4.8	15.9	12.8	Double	4
2251531	KA	2									
2251540	KD	1	40 x 23	40	33	23	6.35	21.6	14.5	Double	5
2251541	KA	2									
2251550	KD	1	50 x 30	50	40.4	29	7.9	27.5	16.8	Double	5
2251551	KA	2									
2251560	KD	1	60 x 33	60	45.4	32.9	9.5	35.8	19.1	Double	5
2251561	KA	2									
2251740	KD	1	40 x 63	40	33	63	6.35	21.6	14.6	Double	4
2251741	KA	2									
2251840	KD	1	40 x 100	40	33	100	6.35	21.6	14.6	Double	4
2251841	KA	2									
2251850	KD	1	50 x 75	50	40.4	75	7.9	27.5	16.8	Double	5
2251851	KA	2									

KD = Keyed Different KA = Keyed Alike

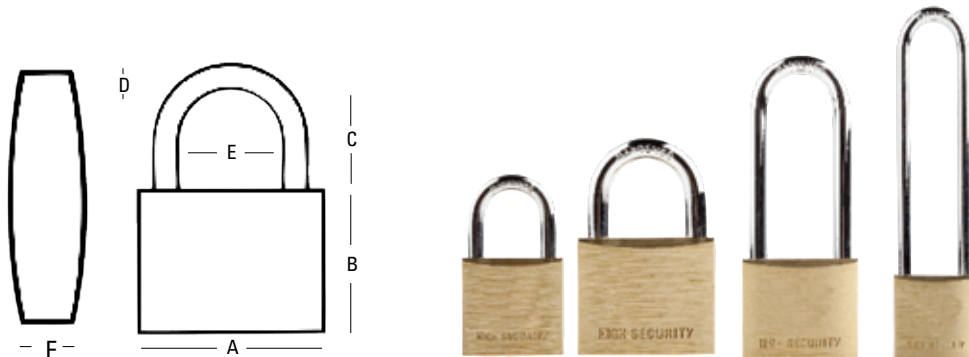

Combination Padlock - 1 / Package

PART#	DESCRIPTION
2253554	50mm Hardened steel shackle



Waterproof Padlocks - 1 / Package

PART#	DESCRIPTION
2253540	40mm Standard Shackle
2253541	40mm Long Shackle



2253540



2253541

Sizes are approximate. Specifications subject to change without notice.



Boss Tools and Accessories

Tape Measures



Utility Grade - 6/Box

- Coated: Nylon coated blade for maximum weather protection
- Armor housing
- Rivets: 3 end rivets
- Stops: Two well positioned stops for easy use

NON-CUSTOM PRINTED	CUSTOM PRINTED				
PART#	PART#	LENGTH	GRADUATION	WIDTH	HOOK
38220	938220	25'	Imperial	1"	Standard



Professional Grade - 12/Box

- Coated: Nylon coated blade for maximum weather protection (38450 - Yellow matte coated black)
- Armor: Coated with rubber for comfort and drop protection
- Rivets: 3 end rivets for extended life (38450 has 4 rivets)
- Stops: Two well positioned stops for easy use
- Heavy Duty Blade: 30% thicker blade for long reach & durability. Tough, fast retracting spring system

NON-CUSTOM PRINTED	CUSTOM PRINTED				
PART#	PART#	LENGTH	GRADUATION	WIDTH	HOOK
38316	938316	16'/5m	Imperial/Metric	1"	Standard
38325	938325	25'/7.5m	Imperial/Metric	1"	Standard
38425	938425	25'	Imperial	1"	Standard
38475	938475	25'	Imperial/Double Sided	1"	Magnetic*
38450	938450	25'/7.5m	Imperial	1-1/4"	Standard

*Grab Hold: Magnetic double hooked for easy measuring

THIS ITEM IS

CUSTOMIZABLE

CUSTOMIZED ITEMS CREATE EXCEPTIONALLY LONG-LASTING ADVERTISING OPPORTUNITIES, AND AT A LOW COST, IT CAN HELP YOUR BUSINESS ACHIEVE HIGH PROMOTIONAL RETURN AND REPEAT BUSINESS.

Contact our Customer Service for pricing and availability today

ADD YOUR OWN LOGO



Tire Tape Measure

PART#	LENGTH	GRADUATION	HOOK
38200	3'	Imperial	Key Chain



Sizes are approximate. Specifications subject to change without notice.



Overtime Saw Blades

- C3 Carbide Tooth Circular Saw Blade
- C3 sub micro-grain FST grind
- Patented grind (40T cuts like 80T)
- Designed for cord or cordless saw
- Wasaw Certified

PART#	TYPE
56026	Overtime 7-1/4", 24 T Saw Blades (Packaged)
56027	Overtime 7-1/4", 40 T Saw Blades (Packaged)
B54027	Overtime 7-1/4", 40 T Saw Blades (Bulk)
B54024	Samurai 7-1/4", 24 T Saw Blades (Pack of 10 - Counter top)
9B54024	Customized Samurai 7-1/4", 24 T Saw Blades (Pack of 10 - Counter top)



56027, 56026



B54024

THIS ITEM IS

CUSTOMIZABLE

CUSTOMIZED ITEMS CREATE EXCEPTIONALLY LONG-LASTING ADVERTISING OPPORTUNITIES, AND AT A LOW COST, IT CAN HELP YOUR BUSINESS ACHIEVE HIGH PROMOTIONAL RETURN AND REPEAT BUSINESS.

Contact our Customer Service for pricing and availability today



Drywall Saws

The Teflon blades cut through drywall with ease.

PART#	DESCRIPTION	BOX/ CASE
B54135	Tri-tooth drywall saw with holster	12 / 48
B54124	Double edge tooth drywall saw	12 / 48



B54135



B54124

Sizes are approximate. Specifications subject to change without notice.



Industrial Security Set

PART#	DESCRIPTION	PACK	CARTON
771395	33 Piece Industrial S2 Steel Security Set	Carded	10



Magnetizer / Demagnetizer

PART#	DESCRIPTION	PACK	BAR/CASE
771400	Magnetizer / Demagnetizer	Box	6/150



Damaged Screw Remover

PART#	DESCRIPTION	PACK	BAR/CASE
771410	3 Pack industrial screw remover	Carded	12/48



9 Piece Allen Set - Ball Point S2

PART#	DESCRIPTION	PACK	BAR/CASE
771500	9 Piece Ball Point Allen Set	Carded	6/36



1/4" Ratchet Set

PART#	DESCRIPTION	PACK
774440	16 Piece Ratchet Set	6



3 Piece Socket Adapter Set

PART#	DESCRIPTION	PACK	BOX/CASE
793520	3 Piece socket adapter set	Carded	25/100

Sizes are approximate. Specifications subject to change without notice.



Boss Tools and Accessories



Tow Pro Towing & Accessories



- | | |
|------------------|-------------------|
| Tow hooks | Wheel chocks |
| Trailer balls | Towing mirrors |
| Trailer couplers | Hitch accessories |
| Jacks | Anchor Winches |
| Ropes / straps | Pull pins |
| Receiver | Connectors |



**TOW PRO TOWING
& ACCESSORIES**

**TOW
PRO™**

TOW PRO TOWING AND ACCESSORIES



Table of Contents

Trailer Balls133	Towing Light Kits • Towing Mirrors.....147
Internal Thread Trailer Balls 133	LED Magnetic Towing Light Kit..... 147
External Thread Trailer Balls..... 133	RV, Marine & Utility LED Lighting Kit 147
Long Shank External Thread Trailer Balls 133	Deluxe Door Mount Towing Mirror 147
Extra Lift External Thread Trailer Balls..... 133	Trailer Connectors148
Heavy Duty External Thread Trailer Balls 133	2 Way Flat Connector..... 148
Internal Thread Trailer Balls - Retail Packaged 134	4 Pole Flat Connectors..... 148
External Thread Trailer Balls - Retail Packaged..... 134	4 Pole Flat Loop Trailer Connector - Heavy Duty..... 148
Trailer Ball Replacement Holder 134	4 Pole Round Plug & Socket..... 148
Trailer Ball Reducer Bushings 134	5 Pole Flat Connectors..... 148
Trailer Couplers135	5 Pole Flat Connector- Heavy Duty..... 148
Channel Trailer Couplers 135	6 Way Round Plug & Socket 149
A-Frame Trailer Couplers..... 135	Mounting Bracket For 7 Way Trailer Connectors 149
Trailer Coupler Repair Kits 135	7 Way Socket 149
3" Tubular Mount Ease-Guide Trailer Couplers 136	7 Way Blade Plug 149
50° A-Frame Ease-Guide Trailer Couplers 136	7 Way Plug And Socket 149
Vertical Channel Mount Ease-Guide Trailer Couplers 136	7 Way Socket 149
Gooseneck Ease-Guide Trailer Coupler 136	7 Way Plug..... 149
Adjustable Trailer Couplers 136	7 Way Socket / 4-Way Plug Set 149
Brackets • Coupler Handles • Tow Bars....137	7 Way Socket Led & 4-Way Plug With LEDs 150
Adjustable Brackets 137	7 Way Plug - Heavy Duty..... 150
Lifter Coupler Handle 137	7 Way Socket - Heavy Duty 150
Adjustable Tow Bar 137	7 Way Plug..... 150
Coupler Locks • Lock Pins.....138	7 Way Socket 150
Coupler Lock 138	7 Way Socket - Heavy Duty 150
Coupler Lock & Receiving Set..... 138	6 Way Socket, 4 Way Plug With LEDs (Adapter) 150
Receiver Lock Pins 138	4 Way In-Line Adapter..... 151
Universal Trailer Coupler Locks 138	Trailer Connector Adapters 151
Trailer Lock Kit..... 138	4 Way Flat Connector (Adapter) 151
Pins & Clips • Hitch Locks.....139	4 Way Flat Tester With LEDs 151
Receiver Pull Pins 139	4 Way And 5 Way Flat Tester With LEDs 151
EZ-Clips 139	7 Way Blade Tester With LEDs 151
Spring Latches 139	Breakaway Switch With Lanyard 151
Hitch Lock..... 139	Power Jack • Swing-Way Jack152
Ball Mounts.....140	Power Jack 152
Class 1 Ball Mounts..... 140	"Swing-Way" Jacks With Caster Wheels..... 152
Class 3-4 Ball Mounts..... 140	A-Frame Jacks153
Class 4 Forged Steel Ball Mounts 140	Top Wind with Wheel..... 153
Class 5 Forged Steel Ball Mounts 141	Side Wind With Wheel 153
Super Duty Steel Ball Mounts 141	Top Wind Without Base or Wheel 153
Forged Aluminum Ball Mounts - Solid Shank 141	Side Wind Without Wheel 153
Ball Mount Kits 141	Square Tube A-Frame Jack 153
ATV Ball Mount Kit..... 141	Round Tube Implement Jacks154
Round Shank - Triple..... 142	Round Tube Mount Jacks, Top Wind 154
Round Shank - Reversible 142	Round Tube Swivel Bracket Mount Jacks, Top Wind 154
Square Straight Shank - Reversible..... 142	Side Wind, Round Tube Mount (7-1/2" x 4" Base Plate) 154
Square Drop Shank - Reversible 142	Side Wind, Round Tube Mount (8" x 6" Base Plate) 154
Square Shank - Triple Ball Size 143	Square Tube Implement Jacks155
Square Shank - Triple Ball Size with Tow Hook 143	Top Wind, Square Tube Mount 155
Clevis Ball Mount..... 143	Side Wind, Square Tube Mount 155
Shackle (Tow Strap) Ball Mount..... 143	Square Tube Trailer Jack 155
Adjustable Triple Ball Mounts 143	Square Tube "Drop Legs" Jack 155
Adjustable Ball Mounts (Single Platform) 143	Square Tube "Drop Legs" Jacks - Heavy Duty 156
Square Drop Shank - Reversible 144	Square Tube Jack - Heavy Duty 156
Adjustable Double Ball Mount..... 144	Scissor Jacks • Stabilizer Jacks.....156
Multi-Use Ball Mount 144	Levelling Scissor Jacks 156
Hitch Extensions • Hitch Steps144	Stabilizer Jack..... 156
Dual Hitch Extension 144	Jack Parts and Accessories • Mudflaps....157
Step Bumper Receiver 144	Jack Replacement Parts And Accessories..... 157
Hitch Box Extension 144	Fifth Wheel King Pin Stabilizer 157
Hitch Adapters • Receiver Tubes145	Trailer Wheels - High Speed 157
Hitch Adapters 145	Mud Flaps..... 157
Receiver Tubes 145	Wheel Locks & Wheel Chocks.....158
Pintle Mounts & Hooks • Lunette Rings145	Wheel Locks 158
Pintle Hooks 145	Wheel Chocks 158
Pintle Hooks - Solid Shank 145	Document Holders158
Pintle Mounts 146	Document Holders 158
Combination Pintle Hooks..... 146	
Combination Pintle Hooks - 1 Piece, Solid Shank 146	
Mount Fixed Lunette Ring 146	
Adjustable 3-Position Lunette Ring 146	
4-Hole Mounting Lunette Ring 146	

TOW PRO

TOW PRO TOWING AND ACCESSORIES



Internal Thread Trailer Balls

Solid steel. Bright chrome plated finish. Meets or exceeds VESC V-5 safety specifications.

PART#	BALL DIAMETER	SHANK DIAMETER	SHANK LENGTH	GROSS LOAD RATING
11148	1-7/8"	3/4"	2"	2,000 lb
11149	2"	3/4"	2"	3,500 lb

External Thread Trailer Balls

Solid steel. Bright chrome plated finish. Meets or exceeds VESC V-5 safety specifications.

PART#	BALL DIAMETER	SHANK DIAMETER	SHANK LENGTH	GROSS LOAD RATING
11147	1-7/8"	1"	2-5/8"	3,500 lb
11151	1-7/8"	3/4"	1-1/2"	2,000 lb
11152	2"	3/4"	2"	3,500 lb
11153	2"	1"	2-5/8"	5,000 lb
11154	2-5/16"	1"	2-5/8"	5,000 lb
11155	2-5/16"	1-1/4"	2-5/8"	10,000 lb
11155H	2-5/16"	1-1/4"	2-1/4"	14,000 lb
11155X	2-5/16"	1-1/4"	2"	12,000 lb
11258	2"	1-1/4"	2-1/4"	8,000 lb

Long Shank External Thread Trailer Balls

Solid steel. Bright chrome plated finish. Meets or exceeds VESC V-5 safety specifications.

PART#	BALL DIAMETER	SHANK DIAMETER	SHANK LENGTH	GROSS LOAD RATING
11250	1-7/8"	1"	3"	2,000 lb
11251	1-7/8"	3/4"	3-1/4"	2,000 lb
11252	2"	3/4"	3-1/4"	3,500 lb
11257	2"	1"	3-1/4"	5,000 lb
11263	2-5/16"	1"	3"	6,000 lb

Extra Lift External Thread Trailer Balls

Solid steel. Bright chrome plated finish. Meets or exceeds VESC V-5 safety specifications.

PART#	BALL DIAMETER	SHANK DIAMETER	SHANK LENGTH	RISE HEIGHT	GROSS LOAD RATING
11253	2"	2-5/8"	2-5/8"	1"	3,500 lb
11254	2"	1"	1-3/4"	2"	3,500 lb
11255	2-5/16"	1-1/4"	2-1/4"	1"	7,000 lb
11256	2-5/16"	1-1/4"	2"	2"	5,000 lb

Heavy Duty External Thread Trailer Balls

Solid steel. Black powder coated finish. Meets or exceeds VESC V-5 safety specifications.

PART#	BALL DIAMETER	SHANK DIAMETER	SHANK LENGTH	RISE HEIGHT	GROSS LOAD RATING
11259	2-5/16"	1-1/4"	2-5/8"	Standard	30,000 lb
11260	2-5/16"	1-1/4"	2-5/8"	1"	30,000 lb
11261	2-5/16"	1-1/4"	2-1/2"	2"	30,000 lb

Pictures are not to scale. Sizes are approximate. Specifications subject to change without notice.



TOW PRO™

TOW PRO TOWING AND ACCESSORIES



Tow Pro Towing and Accessories

Trailer Balls (Retail Packaged) • Packaging • Trailer Ball Reducer Bushings



Internal Thread Trailer Balls - Retail Packaged

Solid steel. Black powder coated finish. Meets or exceeds VESC V-5 safety specifications.

PART#	BALL DIAMETER	SHANK DIAMETER	SHANK LENGTH	GROSS LOAD RATING
11148P	1-7/8"	3/4"	1-3/4"	2,000 lb
11149P	2"	3/4"	1-3/4"	3,500 lb



External Thread Trailer Balls - Retail Packaged

Solid steel. Black powder coated finish. Meets or exceeds VESC V-5 safety specifications.

PART#	BALL DIAMETER	SHANK DIAMETER	SHANK LENGTH	GROSS LOAD RATING
11147P	1-7/8"	1"	2-5/8"	3,500 lb
11151P	1-7/8"	3/4"	1-1/2"	2,000 lb
11152P	2"	3/4"	1-1/2"	3,500 lb
11153P	2"	1"	2-5/8"	5,000 lb
11154P	2-5/16"	1"	2-5/8"	5,000 lb
11155P	2-5/16"	1-1/4"	2-5/8"	10,000 lb
11155HP	2-5/16"	1-1/4"	2-1/4"	14,000 lb
11155XP	2-5/16"	1-1/4"	2"	12,000 lb
11251P	1-7/8"	3/4"	3-1/4"	2,000 lb
11252P	2"	3/4"	3-1/4"	3,500 lb



Trailer Ball Replacement Holder

Black plastic with generic label.

PART#	DESCRIPTION	FITS
TB001	Small - 6.89" x 2.28" x 2.52"	11148, 11149, 11151, 11152 (See previous page)
TB002	Large - 7.36" x 2.64" x 2.99"	11147, 11153, 11154, 11155, 11155H, 11155X (See previous page)



Trailer Ball Reducer Bushings

Clamshell packaged.

PART#	DESCRIPTION
11170	Trailer Ball Reducer Bushing, 1" to 3/4"
11171	Trailer Ball Reducer Bushing, 1-1/4" to 1"

TOW-PRO™

Any load. Any where. Any time.

Be a Tow Pro!

Dynaline offers multiple options of Tow Pro merchandisers. Give your customers the products they want from the brand they know and trust. For information see the Merchandiser section at the front of the catalogue.



Pictures are not scale. Sizes are approximate. Specifications subject to change without notice.



Channel Trailer Couplers

Features large trigger-action latch designed for ease of operation. Zinc Plated Finish. Stamped steel construction. Easy to install. S.A.E. Class 2

PART#	BALL SIZE	CHANNEL SIZE	GROSS LOAD RATING
11156	1-7/8"	2"	2,000 lb
11157	1-7/8"	2-1/2"	2,000 lb
11158	1-7/8"	3"	2,000 lb
11159	2"	2-1/2"	3,500 lb
11159N	2"	2"	3,500 lb
11160	2"	3"	3,500 lb



A-Frame Trailer Couplers

Features large trigger-action latch designed for ease of operation. Zinc plated finish. Stamped steel construction. Easy to install

PART#	BALL SIZE	TYPE	GROSS LOAD RATING
11161	2"	Standard	5,000 lb
11162	2-5/16"	Standard	10,000 lb



Trailer Coupler Repair Kits

Repair kit available for both 1-7/8" and 2" ball channel couplers. Zinc plate finish.

PART#	DESCRIPTION
11163	For 1-7/8" Ball Channel Coupler
11164	For 2" Ball Channel Coupler



TOW PRO

TOW PRO TOWING AND ACCESSORIES

PARTNERS IN CRIME PREVENTION



Universal Trailer Coupler Locks

Prevent theft and protect your property with this *must have* accessory for any trailer owner. Solidly built and tamper-proof, this lock provides peace of mind.



PART#	DESCRIPTION
65085	Light Duty. Fits 1-7/8", 2" and 2-5/16" Couplers.
65086	Heavy Duty . Fits 1-7/8", 2" and 2-5/16" Couplers.

Pictures are not to scale. Sizes are approximate. Specifications subject to change without notice.



Tow Pro Towing and Accessories

Ease-Guide Trailer Couplers • Adjustable Trailer Couplers

EASE-GUIDE™ TRAILER COUPLERS

Ease-Guide™ trailer couplers are a revolutionary new style of coupler that provide a 5" square area to position your hitchball into rather than positioning directly over top like traditional trailer couplers. This means you don't have to get in and out of your vehicle several times to line up your trailer coupler

perfectly over your hitch ball. before coupling the trailer to your vehicle. Once you have lowered your trailer equipped with **Ease-Guide™** coupler onto your hitch ball, you simply drive forward and leave the patented holding socket to guide itself onto the hitch ball and then insert the locking pin.

3" Tubular Mount *Ease-Guide* Trailer Couplers

Carbon steel. Black painted.

PART#	BALL SIZE	HITCH PIN	GROSS LOAD RATING
11563	2-5/16"	66254	12,500 lb
11567	2"	66252	9,000 lb

50° A-Frame *Ease-Guide* Trailer Couplers

Carbon steel. Black painted.

PART#	BALL SIZE	HITCH PIN	GROSS LOAD RATING
11564	2-5/16"	66254	12,500 lb
11568	2"	66252	9,000 lb

Vertical Channel Mount *Ease-Guide* Trailer Couplers

Carbon steel. Black painted.

PART#	BALL SIZE	HITCH PIN	GROSS LOAD RATING
11565	2-5/16"	66254	15,000 lb
11569	2"	66252	9,000 lb

Gooseneck *Ease-Guide* Trailer Coupler

Carbon steel.

PART#	BALL SIZE	HITCH PIN	GROSS LOAD RATING
11566	2-5/16"	66253	24,000 lb

Adjustable Trailer Couplers

Carbon steel.

PART#	BALL SIZE	TONGUE WEIGHT	MAX. GROSS LOAD	OVERALL DIMENSIONS
11864	2"	1,000 lb	10,000 lb	9" L x 5-1/2" W
11865	2-5/16"	1,400 lb	14,000 lb	9-1/4" L x 5-3/4" W



TOW PRO TOWING AND ACCESSORIES



Pictures are not scale. Sizes are approximate. Specifications subject to change without notice.

Adjustable Brackets

Designed for adjustable couplers.

PART#	DESCRIPTION	HOLE DIAMETER	CAPACITY	OUTSIDE WIDTH	INSIDE WIDTH	OVERALL LENGTH
11866	12 hole (6 pairs)	5/8"	16,000 lb	3-5/8"	3"	11-1/2"
11867	8 hole (4 pairs)	5/8"	16,000 lb	3-5/8"	3"	7-1/2"



Lifter Coupler Handle

For easy lifting of trailer tongue on small trailers (coupler not included).

PART#	DESCRIPTION
11870	Zinc plated with rubber coating on the handle. Handle attaches to coupler mounting bolts.



Adjustable Tow Bar

Class 3. Adjustable tow bar width of 26" to 41". Includes 2" coupler and one set of universal bumper brackets. Black powder coated coupler. Base plate may be required.

PART#	DESCRIPTION
11880	Class III, 5,000 lb GVW



Tow Pro products are also available in pre-made or custom merchandisers. Contact your local account manager for more information.

Trailer Couplers

PART#	CONTENTS
00215	Trailer Couplers Display Board Only , 24" x 24"
00215K	Full Trailer Couplers Merchandiser. Includes 00215 display board, 10 pegs (80004) and product listed below:

PART#	DESCRIPTION	QTY.
11156	For 1-7/8" Trailer Balls, 2" Channel	2 ea.
11157	For 1-7/8" Trailer Balls, 2-1/2" Channel	2 ea.
11158	For 1-7/8" Trailer Balls, 3" Channel	2 ea.
11159	For 2" Trailer Balls, 2-1/2" Channel	2 ea.
11159N	For 2" Trailer Balls, 2" Channel	1 ea.
11160	For 2" Trailer Balls, 3" Channel	2 ea.
11161	For 2" Trailer Balls	1 ea.
66276	Coupler Lock	2 ea.
66277	Coupler and Receiver Lock Set	2 ea.



TOW PRO™

TOW PRO TOWING AND ACCESSORIES



Pictures are not to scale. Sizes are approximate. Specifications subject to change without notice.

Tow Pro Towing and Accessories

Coupler Locks • Receiver Locks • Lock Pins

TRAILER LOCKS & PINS

Theft deterrent is the primary function of trailer locks. Feel secure knowing your trailer and cargo are safe.



Coupler Lock

PART#	DESCRIPTION	DIAMETER	USABLE LENGTH
66276	Fits all latch-type couplers. Two keys supplied. Yellow dichromate finish Clamshell packaging.	1/4"	7/8" (closed)



Coupler Lock & Receiving Set

PART#	DESCRIPTION	RECEIVER DIAMETER	USABLE LENGTH	COUPLER LOCK	USABLE LENGTH
66277	Fits most receiver hitches and latch-type couplers. Same key fits both locks. Chrome plated Clamshell packaging.	5/8"	2-3/4"	1/4"	1"



Receiver Lock Pins

Two sizes to fit most receiver-type hitches. Two keys supplied. Bright chrome plated pin. Black enamel painted lock body.

PART#	DIAMETER	USABLE LENGTH	TENSILE STRENGTH
66274	1/2"	2-1/2"	5,500 lb
66275	5/8"	3"	8,800 lb



Universal Trailer Coupler Locks

Bent at the perfect angle for easy removal. Made from oil tempered spring wire. Clear zinc plated finish. Features a locking bar with 6 locking positions.

PART#	DESCRIPTION
65085	Light Duty. Fits 1-7/8", 2" and 2-5/16" Couplers.
65086	Heavy Duty . Fits 1-7/8", 2" and 2-5/16" Couplers.



Trailer Lock Kit

Spring loaded bolt can be locked in the open position. Zinc plated bolt housing and keeper. Turning lever allows the bolt to close under spring pressure.

PART#	DESCRIPTION	CONTENTS
65087	Keyed alike.	Light duty Universal Trailer Coupler Lock , Brass Coupler lock , Dual bent Pin Hitch lock (fits 5/8 and 1/2 receivers)

Pictures are not scale. Sizes are approximate. Specifications subject to change without notice.

TOW PRO

TOW PRO TOWING AND ACCESSORIES



Receiver Pull Pins

For securing ball mounts to receiver-type hitches. Supplied with vinyl coated grip EZ clip.

PART#	MATERIAL	DIAMETER	USABLE LENGTH
66267	Stainless Steel - Won't Rust!	1/2"	3"
66268	Stainless Steel - Won't Rust!	5/8"	3"
66269	Stainless Steel - Won't Rust!	5/8"	3-1/2"
66270	High carbon steel, zinc plated.	1/2"	3"
66270P	As 66270 above, carded.	1/2"	3"
66271	High carbon steel, zinc plated.	5/8"	3"
66271P	As 66271 above, carded.	5/8"	3"
66272	High carbon steel, zinc plated.	5/8"	3-1/2"



EZ-Clips

Bent at the perfect angle for easy removal. Made from oil tempered spring wire. Clear zinc plated finish.

PART#	DESCRIPTION	WIRE DIAMETER	PKG. QTY.
66265	Clear zinc plated finish.	0.148"	25
66266	Vinyl coated non-slip grip.	0.148"	10
96266	Vinyl coated non-slip grip.	0.148"	2 (Blister Pack)



Spring Latches

Spring loaded bolt can be locked in the open position. Zinc plated bolt housing and keeper. Turning lever allows the bolt to close under spring pressure.

PART#	PIN DIAMETER	HANDLE TYPE	BRACKET LENGTH	BRACKET WIDTH	OVERALL LENGTH	MOUNTING HOLE DIAMETER
23057	7/16"	Loop	3-3/8"	1-1/2"	7-1/4"	3/16"
23058	1/2"	4" L shape	3-1/8"	1-3/4"	5-1/2"	1/4"



Hitch Lock

Chrome plated, weather proof cap. Clamshell packaged.

PART#	TYPE	DIAMETER	USABLE LENGTH
65091	Sleeved Barrel	5/8" or 1/2"	2-1/2"
65092	Bent Pin	5/8"	3"
65093	Dual Bent Pin	5/8" & 1/2"	--



TOW PRO™

TOW PRO TOWING AND ACCESSORIES

Pictures are not to scale. Sizes are approximate. Specifications subject to change without notice.



Tow Pro Towing and Accessories

Ball Mounts

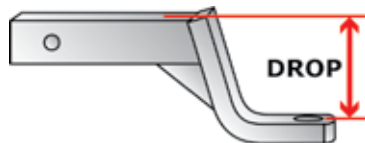

DROP

The distance from the top of the shank to the top of the ball platform

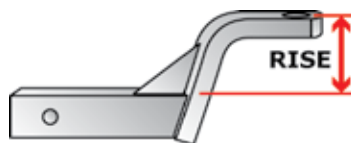

RISE

The distance from the top of the shank to the top of the ball platform

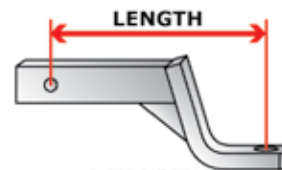

LENGTH

The distance from the center of the ball hole to the center of the pin hole

Class 1 Ball Mounts

Robotic welded, solid shank. Fits 1-1/4" Class 1 receiver tubes. Black powder coated finish.

PART#	FINISH	CLASS	TW (LB)	GTW (LB)	HOLE	DROP	RISE	LENGTH
11670	Black	1	200 lb	2,000 lb	3/4"	1-1/4"	5/8"	6-3/4"
11671	Black	1	200 lb	2,000 lb	3/4"	2-3/4"	2-1/8"	7"
11672	Black	1	200 lb	2,000 lb	3/4"	3-1/2"	3"	9-1/2"

Class 3-4 Ball Mounts

Robotic welded, hollow shank. Fits 2" receivers. Black powder coated & chrome finish.

PART#	FINISH	CLASS	TW (LB)	GTW (LB)	HOLE	DROP	RISE	LENGTH
11600	Black	3	500 lb	5,000 lb	1"	Straight	Straight	10-1/2"
11601	Black	4	600 lb	6,000 lb	1"	2"	3/4"	9"
11602	Black	4	600 lb	6,000 lb	1"	4"	3"	9-1/4"
11603	Black	4	600 lb	6,000 lb	1"	6"	5"	11"
11611	Chrome	4	600 lb	6,000 lb	1"	2"	3/4"	8"
11612	Chrome	4	600 lb	6,000 lb	1"	4"	3"	8-3/4"

Class 4 Forged Steel Ball Mounts

Solid one piece, forged ball mount. Fits 2" receivers. Black powder coated finish.

PART#	FINISH	CLASS	TW (LB)	GTW (LB)	HOLE	DROP	RISE	LENGTH
11586	Black	4	1,000 lb	10,000 lb	1-1/4"	2"	1"	9"
11587	Black	4	1,000 lb	10,000 lb	1-1/4"	4"	3"	9-1/2"
11588	Black	4	1,000 lb	10,000 lb	1-1/4"	6"	5"	11"
11660	Black	4	1,000 lb	10,000 lb	1"	2"	1"	9"
11661	Black	4	1,000 lb	10,000 lb	1"	4"	3"	9-1/2"
11662	Black	4	1,000 lb	10,000 lb	1"	6"	5"	11"

Pictures are not scale. Sizes are approximate. Specifications subject to change without notice.



Class 5 Forged Steel Ball Mounts

Solid one piece forged ball mount. Fits 2" receivers. Black powder coated finish.

PART#	FINISH	CLASS	TW (LB)	GTW (LB)	HOLE	DROP	RISE	LENGTH
11686	Black	5	1,200 lb	12,000 lb	1-1/4"	2"	1"	9"
11687	Black	5	1,200 lb	12,000 lb	1-1/4"	4"	3"	9-1/2"
11688	Black	5	1,200 lb	12,000 lb	1-1/4"	6"	5"	11"



Super Duty Steel Ball Mounts

Robotic welded, hollow shank. Fits 2-1/2" receivers. Black powder coated finish.

PART#	FINISH	CLASS	TW (LB)	GTW (LB)	HOLE	DROP	RISE	LENGTH
11690	Black	4	1,000 lb	10,000 lb	1-1/4"	3"	1-1/2"	9-3/4"
11691	Black	4	1,000 lb	10,000 lb	1-1/4"	5"	3-1/2"	10"
11692	Black	4	1,000 lb	10,000 lb	1-1/4"	8"	6-1/2"	10-1/2"



Forged Aluminum Ball Mounts - Solid Shank

Solid high strength forged aluminum shank. Fits 2" receivers.

PART#	FINISH	CLASS	TW (LB)	GTW (LB)	HOLE	DROP	RISE	LENGTH
11585	Aluminum	4	800 lb	8,000 lb	1"	6"	5"	10-3/4"



Ball Mount Kits

Includes ball mount, welded trailer ball and pull pin. Fits 2" receivers.

PART#	FINISH	CLASS	BALL	TW (LB)	GTW (LB)	DROP	RISE	LENGTH
11590	Black	4	1-7/8"	500 lb	5,000 lb	2"	1"	8-1/4"
11591	Black	4	2"	600 lb	6,000 lb	2"	1"	8-1/4"
11592	Black	4	2-5/16"	600 lb	6,000 lb	2"	1"	8-1/4"
11641	Chrome	4	2"	600 lb	6,000 lb	2"	1"	8-1/4"



ATV Ball Mount Kit

2" receiver and ball mount. Bolts to frame with 3/4" bolt and lock nuts (supplied). Ball mount is removable with pull pin and clip (supplied). Welded loop for attaching tow straps or shackles.

PART#	FINISH	TW (LB)	GTW (LB)	HOLES
11655	Black	500 lb	3,500 lb	1" & 3/4"



**TOW
PRO™**

TOW PRO TOWING AND ACCESSORIES



Pictures are not to scale. Sizes are approximate. Specifications subject to change without notice.

Tow Pro Towing and Accessories

Multi-Head Ball Mounts

MULTIPLE BALL MOUNTS - WELDED BALLS

Solid round shank with welded balls. Fits standard 2" square receivers. No need to remove when changing - **just pull the pin and turn!**

Round Shank - Triple

Solid round shank with welded balls. Fits standard 2" square receivers. No need to remove when changing - just pull the pin and turn!



PART#	FINISH	CLASS	BALL	TW (LB)	GTW (LB)	DROP	RISE	LENGTH
11648	Black	3-4	1-7/8"	350 lb	3500 lb	Straight	Straight	7-1/2"
			2"	600 lb	6,000 lb			
			2-5/16"	1000 lb	10,000 lb			

Round Shank - Reversible

Solid round shank with welded balls. Fits standard 2" square receivers. No need to remove when changing - just pull the pin and turn!



PART#	FINISH	CLASS	BALL	TW (LB)	GTW (LB)	DROP	RISE	LENGTH
11647	Black	3	2"	600 lb	6000 lb	Straight	Straight	7-1/2"
			2-5/16"	1,000 lb	10,000 lb			

Square Straight Shank - Reversible

Straight solid shank with welded balls. Fits 2" receivers.



11604

PART#	FINISH	CLASS	BALL	TW (LB)	GTW (LB)	DROP	RISE	LENGTH
11604	Black	3-4	1-7/8"	350 lb	3500 lb	Straight	Straight	7-1/4"
			2"	600 lb	6,000 lb			
11605	Black	3-4	2"	600 lb	6000 lb	Straight	Straight	7-1/4"
			2-5/16"	1,000 lb	10,000 lb			

Square Drop Shank - Reversible

Drop solid shank with welded balls. Fits 2" receivers.



11644

PART#	FINISH	CLASS	BALL	TW (LB)	GTW (LB)	DROP	RISE	LENGTH
11644	Black	3	1-7/8"	350 lb	3500 lb	2"	3/4"	8"
			2"	600 lb	6,000 lb			
11645	Black	3	2"	600 lb	6000 lb	2"	3/4"	7-1/4"
			2-5/16"	1,000 lb	10,000 lb			

Pictures are not scale. Sizes are approximate. Specifications subject to change without notice.



Square Shank - Triple Ball Size

Fits 2" receivers, 5/8" hole size.

PART#	DESCRIPTION	FINISH	CLASS	BALL	TW (LB)	GTW (LB)	LENGTH
11607	Solid square shank with welded balls	Black	3-4	1-7/8"	350 lb	3,500 lb	8"
				2"	600 lb	6,000 lb	8"
				2-5/16"	1,000 lb	10,000 lb	8"
11652	Hollow shank with welded balls	Black	3-4	1-7/8"	200 lb	2,000 lb	8"
				2"	600 lb	6,000 lb	8"
				2-5/16"	1,000 lb	10,000 lb	8"



11652

Square Shank - Triple Ball Size with Tow Hook

Fits 2" receivers, 5/8" hole size.

PART#	DESCRIPTION	FINISH	CLASS	BALL	TW (LB)	GTW (LB)	LENGTH
11606	Solid square shank with welded balls & tow hook	Black	3-4	1-7/8"	350 lb	3,500 lb	8"
				2"	600 lb	6,000 lb	8"
				2-5/16"	1,000 lb	10,000 lb	8"



11606

Clevis Ball Mount

Hollow shank. Can be used as a standard ball mount.

PART#	FINISH	TW (LB)	GTW (LB)	TUBE	HOLE	LENGTH
11579	Black	600 lb	6,000 lb	Straight	1"	10"



Shackle (Tow Strap) Ball Mount

For use with recovery straps on pickups and ATVs. Black powder coated finish with zinc plated shackle. Fits 2" receivers.

PART#	FINISH	TW (LB)	GTW (LB)	OVERALL LENGTH	SHANK TYPE	SHACKLE DIAMETER
11693	Black	600 lb	6,000 lb	9-3/8"	Hollow	5/8"
11694	Black	1000 lb	10,000 lb	10"	Solid	3/4"



Adjustable Triple Ball Mounts

High grade solid steel for maximum strength. 3-pin design for easy adjustment (pins & clips included). Straight to 6-1/2" maximum drop/rise. 2" x 2" solid shank. Meets S.A.E. J684/V-5.

PART#	CLASS	BALL	TW (LB)	GTW (LB)
11650	3-4	1-7/8"	600 lb	6,000 lb
		2"	1,000 lb	10,000 lb
		2-5/16"	1,000 lb	10,000 lb



Adjustable Ball Mounts (Single Platform)

Black powder coated finish. Perfect for use on tow trailers of various coupler heights. Can be used in the rise or drop position as needed. Fits 2" receiver. Trailer hole size is 1". Pull pin & clip are included.

PART#	FINISH	CLASS	TW (LB)	GTW (LB)	LENGTH	ADJUSTMENT
11595	Black	3	600 lb	6,000 lb	12-1/2"	2" to 7-3/4" drop, up to 6-1/2" rise



Pictures are not to scale. Sizes are approximate. Specifications subject to change without notice.

Tow Pro Towing and Accessories

Adjustable Ball Mounts • Hitch Extensions • Hitch Steps

ADJUSTABLE BALL MOUNTS

Black powder coated finish. Perfect for use on tow trailers of various coupler heights. Can be used in the rise or drop position as needed. Two pieces, comes with pull pins & clips.

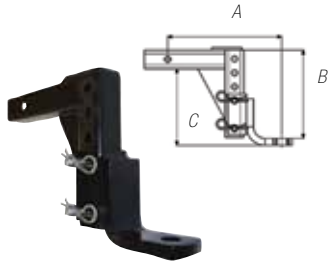

Square Drop Shank - Reversible

Drop solid shank with welded balls. Fits 2" receivers.

PART#	FINISH	TW (LB)	GTW (LB)	LENGTH (A)	DROP (B)	HEIGHT (C)
11561	Black	500 lb	5,000 lb	12-1/4"	5" - 9-1/2"	3-3/4" - 8-1/4"

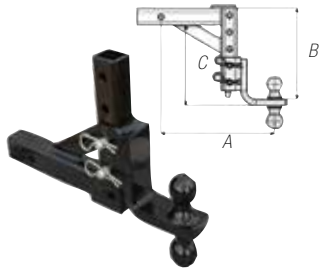

Adjustable Double Ball Mount

Solid steel with 5/8" pin hole. 1-7/8" ball supports up to 2,000 lb; 2" ball supports up to 5,000 lb.

PART#	RECEIVER OPENING	LENGTH (A)	DROP (B)	HEIGHT (C)
11562	2"x2"	13-1/2"	4-4/5" - 10-4/5"	3-3/5" - 9-3/5"

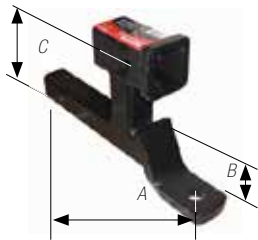

Multi-Use Ball Mount

Tow and carry hitch mounted accessories at the same time.

PART#	FINISH	TW (LB)	GTW (LB)	LENGTH (A)	DROP (B)	HEIGHT (C)
11560	Black	500 lb	5,000 lb	12-1/4"	2-1/4"	5-4/5"

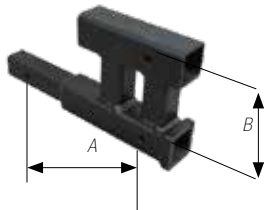

Dual Hitch Extension

Fits 2" receivers.

PART#	FINISH	TW (LB)	GTW (LB)	LENGTH (A)	HEIGHT (B)
11780	Black	400 lb	4,000 lb	12-1/4"	6-1/4"



Step Bumper Receiver

Fits 2" receivers.

PART#	FINISH	TW (LB)	GTW (LB)
11782	Black	500 lb	5,000 lb



Hitch Box Extension

Service step. 2" extension only.

PART#	DESCRIPTION	TW (LB)	GTW (LB)
11784	14" x 7" stepping area	400 lb	4,000 lb

Pictures are not scale. Sizes are approximate. Specifications subject to change without notice.

TOW PRO

TOW PRO TOWING AND ACCESSORIES



Hitch Adapters

Ideal for cargo carriers and bike carriers. Black powder coated finish.
Not to be used for towing.

PART#	DESCRIPTION
11785	Decrease receiver opening from 2-1/2" to 2", 5/8" pin, 5" in length.
11786	Decrease receiver opening from 2" to 1-1/4", 5/8" pin hole, 3-1/2" length.
11787	Increase receiver opening from 1-1/4" to 2", GTW 3500 lb
11788	Decrease receiver opening from 2" to 1-1/4", GTW 3500 lb
11789	8-1/2" Length, fits 2" receivers.



Receiver Tubes

Powder coated black finish. Welded.
 Fits 2" receivers.

PART#	LENGTH
11770	6"
11771	12"
11772	18"
11773	24"
11774	36"
11775	48"



PINTLE HOOKS

Solid forged steel construction. Black enamel painted finish. 4-1/4" x 3-1/4" base plate. All bolts are made from heat treated allow steel.

PART#	CAPACITY	TW (LB)	GTW (LB)
11618	5 Tons	2,000 lb	10,000 lb
11620	10 Tons	4,000 lb	20,000 lb
11619	15 Tons	6,000 lb	30,000 lb
11621	20 Tons	9,000 lb	40,000 lb
11622	30 Tons	14,000 lb	60,000 lb



Pintle Hooks - Solid Shank

Fits 2" receivers.

PART#	TW (LB)	HOOK CAP. (LB)
11718	2,000 lb	10,000 lb
11719	2,000 lb	20,000 lb
11720	2,000 lb	30,000 lb



Pictures are not to scale. Sizes are approximate. Specifications subject to change without notice.



Tow Pro Towing and Accessories

Pintle Mounts • Pintle Hooks • Lunette Rings



Pintle Mounts

For 2" receivers. Converts receivers for use with pintle type trailers quickly and easily. Provides mounting for both ball and pintle hooks. Black powder coat finish.

PART#	DESCRIPTION	TW (LB)	GTW (LB)	# OF HOLES	POSITION (PAIRS)
11610	7-5/16" x 5"	1,000 lb	10,000 lb	8	4th
11630	12-1/2" x 5"	1,000 lb	10,000 lb	14	7th



Combination Pintle Hooks

PART#	BALL SIZE	BALL CAP.(LB)	TW (LB)	GTW (LB)	REPLACEMENT BALL PART #'S
11616	2"	7,000 lb	3,000 lb	16,000 lb	11632
11617	2-5/16"	12,000 lb	3,000 lb	16,000 lb	11633



Combination Pintle Hooks - 1 Piece, Solid Shank

Solid steel construction. Comes with lock pin on chain and 2" trailer ball. Fits 2" receivers.

PART#	BALL SIZE	BALL CAP.(LB)	TW (LB)	GTW (LB)	SHANK	REPLACEMENT BALL PART #'S
11715	1-7/8"	2,000 lb	1,200 lb	12,000 lb	2"	11631
11716	2"	7,000 lb	1,200 lb	12,000 lb	2"	11632
11717	2-5/16"	12,000 lb	1,200 lb	12,000 lb	2"	11633



Mount Fixed Lunette Ring

Forged steel with black powder coated finish.

PART#	DESCRIPTION	TOW RATING
11634	2-1/2" ring diameter, 3-1/4" shank length, 1-1/2" shank diameter	15,000 lb



Adjustable 3-Position Lunette Ring

Forged steel with black powder coated finish.

PART#	DESCRIPTION	TOW RATING
11635	Forged ring 6" outside diameter, 2-3/4" inside diameter, 3-5/8" outside bracket width, 3" inside bracket width, 1,800 lb. vertical load.	12,000 lb



4-Hole Mounting Lunette Ring

Forged steel with black powder coated finish.

PART#	DESCRIPTION	TOW RATING
11636	2-1/2" diameter ring with square 6" base plate, 5/8" diameter mounting holes, 4,000 lb. vertical load.	42,000 lb

Pictures are not scale. Sizes are approximate. Specifications subject to change without notice.

TOW PRO

TOW PRO TOWING AND ACCESSORIES



LED Magnetic Towing Light Kit

Ideal for situations requiring temporary lighting.

PART#	DESCRIPTION	CONTENTS
11978	LED Magnetic Towing Light Kit with 20 feet of wiring with 4-pole flat adapter.	Includes 2 round magnetic LED lights, mounting hardware and connectors.



RV, Marine & Utility LED Lighting Kit

Submersible up to 80" depth.

PART#	DESCRIPTION	CONTENTS
11980	LED Trailer Lighting Kit. Over 80" submersible, 4-pole flat connector.	Includes 2 rectangular LED lights, mounting hardware and connectors.



Deluxe Door Mount Towing Mirror

PART#	DIMENSIONS	DESCRIPTION:
17722	Mirror size: 220 mm W x 145 MM H (8-5/8" W x 5-3/4" H)	Frame extends from 330 mm to 470 mm (13" to 18-1/2")

- Easy installation
- Suitable for towing trailers, campers, boats, etc.
- Mounts onto door
- Extra large stainless steel mirror head
- No-Mar flexible rubber straps protect vehicle finish and ensure snug, vibration free fit
- No tools required!



NO TOOLS REQUIRED!



Rubber pad protects vehicle's finish



Pictures are not to scale. Sizes are approximate. Specifications subject to change without notice.

Tow Pro Towing and Accessories

Trailer Connectors

**TOW
PRO**

TOW PRO TOWING AND ACCESSORIES



2 Way Flat Connector

PART#	DESCRIPTION
27002	2-pole flat connectors. 12" 18 ga. white & yellow wires.

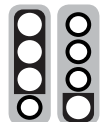

4 Pole Flat Connectors

PART#	DESCRIPTION
27004	4-pole flat wiring harness. 18 ga wire - 12" male, 48" female, 18" ground.
27006	4-pole flat wiring harness. 12" 18 ga wire.
27008	4-way flat wiring harness. 25 ft 3-wire bonded loop with ground wire. 18 ft male end, 5 ft female end. 5 ft brown extension wire included.

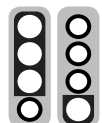

4 Pole Flat Loop Trailer Connector - Heavy Duty

PART#	DESCRIPTION
27010	4-pole flat loop. Heavy duty. 48" 18 ga. wires.

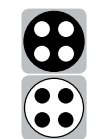

4 Pole Round Plug & Socket

PART#	DESCRIPTION
27015	Die cast, chrome plated housing. Trailer and Vehicle side.

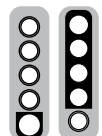

5 Pole Flat Connectors

PART#	DESCRIPTION
27020	Male connector plug. Comes with 48" of 18 gauge wire.
27022	Female connector socket. Comes with 48" of 18 gauge wire.

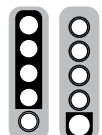

5 Pole Flat Connector- Heavy Duty

PART#	DESCRIPTION
27024	5-pole heavy duty connector loop. 48" 18 ga. wires.



Pictures are not scale. Sizes are approximate. Specifications subject to change without notice.

6 Way Round Plug & Socket

PART#	DESCRIPTION
27030	6-way round plug & socket. Heavy duty die cast housing.
27034	6-pole round socket with cover, with heavy duty die cast housing, vehicle side.
27036	6-pole round plug. Heavy duty die cast housing, trailer side.



Mounting Bracket For 7 Way Trailer Connectors

PART#	DESCRIPTION
27040	Zinc plated.



7 Way Socket

PART#	DESCRIPTION
27042	7-way blade socket with cover. Zinc plated metal housing. Vehicle side.



7 Way Blade Plug

PART#	DESCRIPTION
27044	7-way blade plug. Zinc plated metal housing. Trailer side.



7 Way Plug And Socket

PART#	DESCRIPTION
27046	7-way blade. With cover, ABS housing with red reflector. Trailer and vehicle side.



7 Way Socket

PART#	DESCRIPTION
27048	7-way blade socket. Plastic housing with red reflector. Vehicle side.



7 Way Plug

PART#	DESCRIPTION
27050	7-way blade flat plug. Plastic housing. Trailer side.



7 Way Socket / 4-Way Plug Set

PART#	DESCRIPTION
27052	7-way blade socket with cover. 4-way flat plug & Direct wiring. Vehicle side.



Pictures are not to scale. Sizes are approximate. Specifications subject to change without notice.

TOW PRO™

TOW PRO TOWING AND ACCESSORIES



Tow Pro Towing and Accessories

Trailer Connectors

**TOW
PRO**

TOW PRO TOWING AND ACCESSORIES

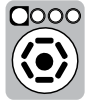

7 Way Socket Led & 4-Way Plug With LEDs

PART#	DESCRIPTION
27054	7-way pre-wired blade socket with cover. 4-way flat plug. 6 LED indicator. Vehicle side.
27056	27054 plus Mounting Kit.



7 Way Plug - Heavy Duty

PART#	DESCRIPTION
27060	7-pole round plug. Heavy duty die cast housing. Trailer side.



7 Way Socket - Heavy Duty

PART#	DESCRIPTION
27062	7 pole round socket with cover. Vehicle side.



7 Way Plug

PART#	DESCRIPTION
27064	7-pole round plug. Nylon with fiberglass housing. Trailer side.



7 Way Socket

PART#	DESCRIPTION
27066	7-pole round socket with cover. Nylon with fiberglass housing. Vehicle side.



7 Way Socket - Heavy Duty

PART#	DESCRIPTION
27068	7-pole round heavy duty socket. 3 hole mounting.

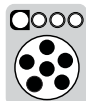

6 Way Socket, 4 Way Plug With LEDs (Adapter)

PART#	DESCRIPTION
27075	#27070 Plus mounting kit.

Pictures are not scale. Sizes are approximate. Specifications subject to change without notice.

4 Way In-Line Adapter

PART#	DESCRIPTION
27076	Trailer Connector Set, 4-way in-line adapter with cover.



Trailer Connector Adapters

PART#	DESCRIPTION
27078	6-way round to 4-way flat.
27080	7-pole round to 4-way flat.
27082	7-way blade to 6-way round. Center pin auxiliary.
27084	7-way blade to 4-way flat.
27086	7-way blade plug to 6-way round socket, 5-way flat, and 4-way flat.
27088	7-pole blade plug to 7-pole round socket. Heavy duty.



27084



27088



27078

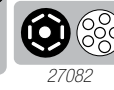

27082



27080

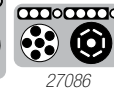

27086

27078



27086



27088



4 Way Flat Connector (Adapter)

PART#	DESCRIPTION	CONTENT
27090	Tail Light Adapter. 4 way 3 amp flat connector with cover.	Supplied with 18 gauge bonded wiring.



4 Way Flat Tester With LEDs

PART#	DESCRIPTION
27092	4-way flat tester with 3 LEDs indicator and ring.



4 Way And 5 Way Flat Tester With LEDs

PART#	DESCRIPTION
27093	4-way and 5-way flat tester with 4 LEDs indicator and cover.

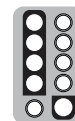

7 Way Blade Tester With LEDs

PART#	DESCRIPTION
27096	7-way blade tester with 6 LEDs indicator.



Breakaway Switch With Lanyard

PART#	DESCRIPTION
27098	With 4 ft. of 16 gauge wire. Metal bracket included.



Pictures are not to scale. Sizes are approximate. Specifications subject to change without notice.

Tow Pro Towing and Accessories

Power Jack • Swing-Way Jack



Power Jack

- 4000 lb Lifting Power!
- Tracks 10" in 60 seconds
- 12 volt DC powered with manual crank over-ride
- Allows quick break-away from coupler
- Water resistant enclosed motor
- Low noise level during operation
- Fits 2-1/4" mounting holes
- 25" total travel! (8" drop leg, 17" travel)
- 9-3/4" bracket height
- Durable black powder coated finish
- Hardened steel gears
- LED light, easy night time hookups
- Oversize 5-1/2" diameter foot pad
- Weather sealed switch
- Built-in level
- Black plastic cover
- Power cord length: 6' of #10 gauge wire
- 5 yr manufacturer warranty

PART#	VERTICAL LOAD	TRAVEL	DROP LEG	TOTAL TRAVEL	EXTENDED HEIGHT
52700	4,000 lb	17"	8"	25"	34-3/4"

All specifications for jacks are in accordance with the ASABE S 485 standards

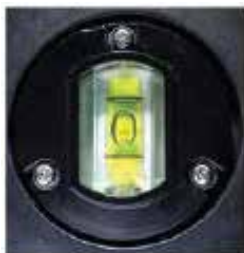

TOW PRO TOWING AND ACCESSORIES

TOW PRO™

"Swing-Way" Jacks with Caster Wheels

Black powder coated finish. Perfect for use on tow trailers of various coupler heights. Heavy duty swivel mechanism swings and locks jack to transport position. Pull-type locking pin secures jack into load-bearing position. Supplied with bolt reinforced caster and mounting bracket. Fits tongues up to 3" x 5".



PART#	SUPPORT CAPACITY	MAXIMUM LIFT CAPACITY	CASTER WHEEL	LIFT	BRACKET HEIGHT	RETRACTED HEIGHT	EXTENDED HEIGHT
11466	1,600 lb	1,200 lb	6"	10"	12-3/4"	23-1/4"	33-1/4"
11477	2,000 lb	1,500 lb	8"	10"	12-3/4"	25-1/2"	35-1/2"

All specifications for jacks are in accordance with the ASABE S 485 standards

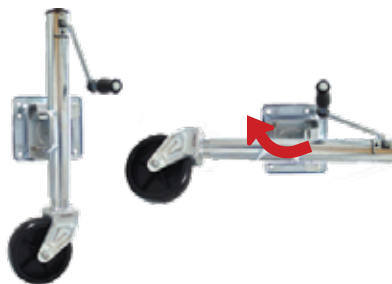

Pictures are not scale. Sizes are approximate. Specifications subject to change without notice.



Top Wind with Wheel

PART#	SUPPORT CAPACITY	MAXIMUM LIFT CAPACITY	CASTER WHEEL	LIFT	BRACKET HEIGHT	RETRACTED HEIGHT	EXTENDED HEIGHT	HANDLE
11463	2,000 lb	1,200 lb	6"	15"	8-1/2"	20"	35"	Knob
No Caster	6,000 lb	5,000 lb	-	-	-	-	-	-

Side Wind with Wheel

Non-removable handle

PART#	SUPPORT CAPACITY	MAXIMUM LIFT CAPACITY	CASTER WHEEL	LIFT	BRACKET HEIGHT	RETRACTED HEIGHT	EXTENDED HEIGHT
11467	2,000 lb	1,200 lb	6"	15"	9-1/2"	23-1/2"	38-1/2"
No Caster	2,800 lb	2,000 lb	-	-	-	-	-

Top Wind without Base or Wheel

PART#	SUPPORT CAPACITY	MAXIMUM LIFT CAPACITY	LIFT	BRACKET HEIGHT	RETRACTED HEIGHT	EXTENDED HEIGHT	
11492	6,000 lb	5,000 lb	15"	8-1/2"	20"	35"	
11493	6,000 lb	5,000 lb	15"	10"	21"	36"	
11492-1	Base for 11492, 11493 and 11484						

Side Wind without Wheel

PART#	SUPPORT CAPACITY	MAXIMUM LIFT CAPACITY	LIFT	BRACKET HEIGHT	RETRACTED HEIGHT	EXTENDED HEIGHT
11484	2,800 lb	2,000 lb	15"	9"	24"	39"

Square Tube A-Frame Jack

Outer tube: 57mm x 50mm. Base: 96mm x 196mm. Weight: 9.2 kg.

PART#	SUPPORT CAPACITY	MAXIMUM LIFT CAPACITY	TYPE	TRAVEL	BRACKET HEIGHT	RETRACTED HEIGHT	EXTENDED HEIGHT
11486	6,500 lb	5,000 lb	Side Wind	15"+ 13"	7-1/2"	24-1/2"	37-1/2"



TOW PRO™

TOW PRO TOWING AND ACCESSORIES



Pictures are not to scale. Sizes are approximate. Specifications subject to change without notice.

Tow Pro Towing and Accessories

Round Tube Implement Jacks



Round Tube Mount Jacks, Top Wind

Robust internal gear mechanism and heavy duty rolled threads for smooth operation and dependability. 4-position mounting tube, lock-pin and handle. Black enamel painted finish.

PART#	SUPPORT CAPACITY	MAXIMUM LIFT CAPACITY	LIFT	BRACKET HEIGHT	BRACKET TYPE	RETRACTED HEIGHT	EXTENDED HEIGHT
11468	6,500 lb	5,000 lb	10"	10"	Pipe	15"	25"
11469	6,500 lb	5,000 lb	15"	15"	Pipe	20-1/4"	35-1/4"



Round Tube Swivel Bracket Mount Jacks, Top Wind

Robust internal gear mechanism and heavy duty rolled threads for smooth operation and dependability. 4-position mounting tube, lock-pin and handle. Black enamel painted finish.

PART#	SUPPORT CAPACITY	MAXIMUM LIFT CAPACITY	LIFT	BRACKET HEIGHT	BRACKET TYPE	RETRACTED HEIGHT	EXTENDED HEIGHT
11470	2,800 lb	2,000 lb	10"	8-1/2"	Flange	15"	25"
11471	2,800 lb	2,000 lb	15"	13-1/4"	Flange	20"	35"



Side Wind, Round Tube Mount (7-1/2" x 4" Base Plate)

Robust internal gear mechanism and heavy duty rolled threads for smooth operation and dependability. 4-position mounting tube, lock-pin and handle. Black enamel painted finish.

PART#	SUPPORT CAPACITY	MAXIMUM LIFT CAPACITY	LIFT	BRACKET HEIGHT	BRACKET TYPE	RETRACTED HEIGHT	EXTENDED HEIGHT
11472	6,500 lb.	5,000 lb	15"	14"	Pipe	22"	37"
11473	6,500 lb	5,000 lb	10"	9"	Pipe	16-1/2"	26-1/2"



Side Wind, Round Tube Mount (8" x 6" Base Plate)

Robust internal gear mechanism and heavy duty rolled threads for smooth operation and dependability. 4-position mounting tube, lock-pin and handle. Black enamel painted finish.

PART#	SUPPORT CAPACITY	MAXIMUM LIFT CAPACITY	LIFT	BRACKET HEIGHT	BRACKET TYPE	RETRACTED HEIGHT	EXTENDED HEIGHT
11474	8,400 lb	7,000 lb	10"	9"	Pipe	17"	27"
11475	8,400 lb	7,000 lb	15"	14-1/4"	Pipe	22-1/2"	37-1/2"
11479	6,500 lb	5,000 lb	15"	15"	Pipe	22-1/2"	37-1/2"

Pictures are not scale. Sizes are approximate. Specifications subject to change without notice.

TOW PRO

TOW PRO TOWING AND ACCESSORIES



Top Wind, Square Tube Mount

Robust internal gear mechanism & heavy duty rolled threads for smooth operation. Equipped with removable cover, grease fittings, 4-position mounting tube and lock-pin. Black enamel painted finish.

PART#	SUPPORT CAPACITY	MAXIMUM LIFT CAPACITY	LIFT	BRACKET HEIGHT	BRACKET TYPE	RETRACTED HEIGHT	EXTENDED HEIGHT
11520	2,800 lb	2,000 lb	10"	10"	Pipe	19"	29"
11525	2,800 lb	2,000 lb	15"	10"	Pipe	23"	38"
11526	2,800 lb	2,000 lb	15"	15"	Pipe	21"	36"
11535	6,000 lb	5,000 lb	15"	15-3/4"	Pipe	22"	37"



11520

Side Wind, Square Tube Mount

Robust internal gear mechanism & heavy duty rolled threads for smooth operation. Equipped with removable cover, grease fittings, 4-position mounting tube and lock-pin. Black enamel painted finish.

PART#	SUPPORT CAPACITY	MAXIMUM LIFT CAPACITY	LIFT	BRACKET HEIGHT	BRACKET TYPE	RETRACTED HEIGHT	EXTENDED HEIGHT
11510	2,800 lb	2,000 lb	10"	9"	Pipe	19-1/2"	29-1/2"
11515	2,800 lb	2,000 lb	15"	15"	Pipe	23-1/2"	38-1/2"
11540	6,500 lb	6,000 lb	10"	9"	Pipe	17"	27"



11510

Square Tube Trailer Jack

Heavy duty 2-1/4" square tube "weld-on" construction designed for reliability and durability. Features grease fitting for lubrication of mechanism. Black enamel painted finish.

PART#	SUPPORT CAPACITY	MAXIMUM LIFT CAPACITY	LIFT	TYPE	RETRACTED HEIGHT	EXTENDED HEIGHT
11480	6,500 lb	5,000 lb	15"	Top Wind	22"	37"



Square Tube Trailer Jack

Robust 2-1/2" square tube. Drop leg adjusts 13" in addition to lift. Features grease fitting for lubrication of mechanism. Black enamel painted finish.

PART#	SUPPORT CAPACITY	MAXIMUM LIFT CAPACITY	TYPE	LIFT	TOTAL TRAVEL	RETRACTED HEIGHT	EXTENDED HEIGHT
11545	6,500 lb	6,000 lb	Side Wind	16"+13"	31"	24-1/2"	53-1/2"



Square Tube "Drop Legs" Jack

Robust 2-1/2" square tube "weld-on" construction. Drop leg adjusts 13" in addition to lift. Features grease fitting for lubrication of mechanism. Black enamel painted finish.

PART#	SUPPORT CAPACITY	MAXIMUM LIFT CAPACITY	TYPE	LIFT	TOTAL TRAVEL	RETRACTED HEIGHT	EXTENDED HEIGHT
11487	8,000 lb	7,000 lb	Top Wind	15" + 13"	28"	22"	50"
11488	8,000 lb	7,000 lb	Side Wind	15" + 13"	28"	24-1/2"	52-1/2"



11487

Pictures are not to scale. Sizes are approximate. Specifications subject to change without notice.

Tow Pro Towing and Accessories

Scissor Jacks • Square Tube Jacks • Stabilizer Jacks



Square Tube "Drop Legs" Jacks - Heavy Duty

Heavy duty 4" square tube "weld-on" construction. Drop leg has 5 position holes and adjusts 13" in addition to lift. Features grease fittings for lubrication of mechanism. Black finish. Both units have a lift of 12-1/2".

PART#	SUPPORT CAPACITY	MAXIMUM LIFT CAPACITY	TYPE	TOTAL TRAVEL	DROP LEG PIN LOCATION	RETRACTED HEIGHT	EXTENDED HEIGHT
11490	12,000 lb	10,000 lb	Side Wind	25-1/2"	Side	28-1/2"	54"
11495	12,000 lb	10,000 lb	Top Wind	25-1/2"	--	23-1/2"	49"



Square Tube Jack - Heavy Duty

Heavy duty 4" square tube "weld-on" construction. Features grease fittings for lubrication of mechanism. Black finish. No drop leg.

PART#	SUPPORT CAPACITY	MAXIMUM LIFT CAPACITY	TYPE	LIFT	RETRACTED HEIGHT	EXTENDED HEIGHT
11494	12,000 lb	10,000 lb	Side Wind	12-1/2"	28"	40-1/2"



Levelling Scissor Jacks

Used for stabilizing and levelling 5th wheels and travel trailers. Sturdy steel construction. Designed for today's larger and heavier units. Black finish. Permanently mounted and conveniently concealed when not in use. Easy to install. Comes with wrench.

PART#	SUPPORT CAPACITY	MAXIMUM LIFT CAPACITY
11891	5,000 lb	4" to 24"



Stabilizer Jack

Used for stabilizing travel trailers, camper trailers and boat trailers. 4" x 3-3/8" base plate.

PART#	LIFT CAPACITY	RETRACTED HEIGHT	EXTENDED HEIGHT
11895	1,000 lb	11.5"	18"

Pictures are not scale. Sizes are approximate. Specifications subject to change without notice.

TOW PRO™

TOW PRO TOWING AND ACCESSORIES



Jack Replacement Parts And Accessories

PART#	DESCRIPTION
11477-1	Plastic cap - Fits Jack #11477
11488-1	Replacement cap - Fits Jack #11488
11491	Side Wind Jack Handle - Fits Jack #11490
11500	Mounting Tube, External, Large - 2-1/2" Inside Diameter
11501	Mounting Tube, Internal, Small - 2" Outside Diameter
11502	Top Wind Handle
11505	Side Wind Handle
11509	Bushing for Jack Handle
11513	Weld-On Mounting Bracket
66469	Quick Pin for Implement Jacks - 5/8" Pin Diameter, 3-1/8" Usable Length



Fifth Wheel King Pin Stabilizer

Stabilizes motion of unhitched trailer or RV. Threaded hitch cap allows for height adjustment. Includes chain with inserts. Folds for storage. Durable steel construction. King Pin height adjusts from 35" to 55".

PART#	SUPPORT CAPACITY	FOOTPLATE DIMENSIONS	WEIGHT
11794	5,000 lb	5" x 5-1/2"	23 lb



Trailer Wheels - High Speed

Eight-spoke rim, powder-coated for increased durability and long lasting finish. Yellow River Tires feature double steel belting and full nylon plies for increased strength and product life.

PART#	WHEEL SIZE	TIRE SIZE	BOLT PATTERN	PILOT DIAMETER	CAPACITY	LOAD RANGE
80120	12" x 4"	4.8" x 12"	4	2.83"	585 lb	C
80124	12" x 4"	5.3" x 12"	5	2.83"	1,047 lb	C
80128	13" x 4-1/2"	ST175/80 D13	5	3.19"	1,477 lb	D
80130	14" x 5-1/2"	ST205/75 D14	5	3.19"	1,764 lb	C
80132	15" x 5 -1/2"	ST205/75 D15	5	3.19"	1820 lb	C



Mud Flaps

Sold separately. Each made of heavy rubber.

PART#	SIZE	THICKNESS	MOUNTING HEAD
11981	24" x 24"	1/4"	5/16"
11982	24" x 30"	1/4"	5/16"
11991	24" x 24"	3/8"	7/16"
11992	24" x 30"	7/16"	7/16"
11993	24" x 36"	7/16"	7/16"



Pictures are not to scale. Sizes are approximate. Specifications subject to change without notice.

Tow Pro Towing and Accessories

Wheel Locks • Wheel Chocks • Document Holders



Wheel Locks

Adjustable slide-lock for wheels. Fits multiple tire sizes. Weather proof locks with 2 keys.

PART#	DESCRIPTION	PACKAGING
65088	Heavy Duty. Fits 7" to 11" width tires	Double blister



PART#	DESCRIPTION	PACKAGING
65089	Super Heavy Duty. Fits 7" to 11" width tires	Colour box



PART#	DESCRIPTION	PACKAGING
65090	Extreme Heavy Duty. Fits 13" to 16" Rims. Fits tires up to 28". Diameter X 9" width	Colour box



Wheel Chocks

Rubber wheel chock for trailers, cars or other small vehicles. Non-slip surface provides superior traction.

PART#	SIZE
11984	7-1/2" x 6" x 3-3/4"
11985	10-5/8" x 7" x 4-1/2"



Wheel Chocks

Made from rubber compound with reinforced nylon fiber. Ideal for trailers and heavy loaded vehicles. Eyebolt for easy handling.

PART#	SIZE
11986	8" x 6" x 10"



Wheel Chocks

Yellow plastic wheel chock. Comes packaged in colour box. 2 wheel chocks per box.

PART#	SIZE
11988	8" x 5" x 4-1/4"



17720

Manual Holders

Molded from high density polypropylene, weather and impact resistant. Protects documents from damage. Mounts onto machines for easy access. O-Ring sealed. Screw top lid.

PART#	DESCRIPTION
17720	Plastic Holder 2" diameter x 12-1/2" long
17730	Plastic Holder 3-1/4" diameter x 12-1/2" long
17731	Tether for plastic holder 17720 and 17730
17740	Aluminum Holder 1.5" diameter x 9" long
17740-1	Rubber cap replacement for 17740



17740

Pictures are not scale. Sizes are approximate. Specifications subject to change without notice.

TOW PRO

TOW PRO TOWING AND ACCESSORIES



Lubrication



- Grease guns
- Grease gun kits
- Grease cartridges
- Grease fittings
- Funnels
- Drain pans



LUBRICATION



Lubrication



Table of Contents

Rechargeable Grease Gun Kits & Parts.....	161	Grease Tube Containers • Oilers.....	170
Rechargeable Grease Gun Kit - 19.2 V.....	161	13000 - Grease Box.....	170
Replacement Grease Hoses.....	161	13002 - Grease-2-Go!.....	170
Replacement Batteries.....	161	Pump Oilers.....	170
Replacement Chargers.....	161	Oilers with Base.....	170
Pistol Grip Grease Guns.....	162	Funnels.....	171
11066 - Pistol Grip Grease Gun.....	162	Multi-Purpose Funnels (Single).....	171
11084A - Pistol Grip Grease Gun.....	162	3-Piece Funnel Set.....	171
11087A - Pistol Grip Grease Gun.....	162	4-Piece Funnel Set.....	171
11089A - Mini Pistol Grip Grease Gun.....	162	Industrial Funnels.....	171
Lever Grease Guns • Grease Tubes.....	163	Wide Spout Industrial Funnels.....	171
11082C - Premium Heavy Duty Grease Gun.....	163	Automotive Funnel.....	172
11083 - Standard Duty Grease Gun.....	163	Anti-Splash Funnels.....	172
11085A - Heavy Duty Grease Gun.....	163	2-In-1 Flexible Spout Funnel.....	172
Grease Tubes.....	163	Foldable Funnel.....	172
Multi-Purpose Lithium Grease.....	163	Replacement Funnel Filter.....	173
Suction Guns • Fluid Pumps.....	164	Transmission Funnel.....	173
11090A - Suction Gun.....	164	Super Funnel.....	173
11093 - Fluid Transfer Pump.....	164	Dirt Free Funnels.....	173
11095 - Self Priming Copper Pump.....	164	Heavy Duty Flex Spout Funnel.....	173
11096 - Multi-Use Siphon Pump.....	164	Measuring Containers, Scoops & Fillers....	174
11091 - Lever Action Pail Pump.....	164	Measurer with Lid & Nozzle.....	173
Barrel Pump • Fuel Pumps.....	165	Measuring Container.....	174
11092A - Lever Action Barrel Pump.....	165	Measurer w/Fixed Lid & Nozzle.....	174
11094A - Rotary Barrel Pump.....	165	Portable Measurer.....	174
11800 - Diaphragm Fuel Pump.....	165	Measuring Scoops.....	174
11097 - Portable Fluid Pump.....	165	Automatic Battery Filler.....	174
Fluid Drainers • Fuel Pump.....	166	Metal Funnels.....	175
11802 - Used Fluid Drainer.....	166	Tin Funnel.....	175
Parts For Used Fluid Drainer (Part# 11802).....	166	Tractor Funnel.....	175
11804 - Fuel Cart with Pump.....	166	Offset Transmission Funnel.....	175
11806 - Waste Oil Drainer and Charger.....	166	Transmission Funnel.....	175
Grease Couplers • Grease Accessories.....	167	Metal Measurer.....	175
11071A - 360° Swivel Grease Coupler.....	167	Drain Pans.....	176
11072 - Grease Accessory Kit.....	167	Plastic Funnels & Measures.....	176
Needle Nose Dispensers.....	167	14026 - Seal-able Drain Pan.....	176
Needle Nose Adapter.....	167	14028 - Seal-able Oil Drain Pan with Wheels.....	176
Grease Gun Holder.....	167	14032 - Low Profile Oil Drain with Manual Pump.....	176
Grease Injectors.....	167	Truck & Trailer Drain Pan.....	177
Grease Couplers • Grease Hoses.....	168	Drain Pans.....	177
90° Grease Coupler.....	168	Specialty Funnels.....	177
Grease Couplers.....	168	Easy Flow Funnel.....	177
Grease Filler Nipple.....	168	S.A.E. O-rings.....	178
Grease Gun Pipe.....	168	S.A.E. O-rings.....	178-181
Grease Hose - Nylon.....	168	Metric O-rings.....	182
Grease Hose - Steel wire.....	168	Metric O-Rings.....	182
Grease Hose - Steel wire (in display box).....	168	High Pressure O-rings.....	183
Grease Fittings.....	169	High Pressure O-Rings.....	183
Metric Grease Fittings.....	169	Nitrile Data Sheet.....	184
Drive-In Grease Fittings.....	169		
S.A.E. Grease Fittings (Grease Zerk).....	169		



Rechargeable Grease Gun Kit - 19.2 V

PART#	VOLTAGE	MAX. OPERATING PRESSURE	CARTRIDGES PER CHARGE	GREASE OUTPUT @ 1000 PSI
11025	19.2 Volt	8,500 psi	3	3 oz./Minute

Heavy duty. Ideal for Ag Implements, Tractors, Construction, Industrial, Machinery, Automotive or anywhere high volume, portable greasing is required. Comes with two 19.2 V heavy duty NiCd batteries and 19.2V 1 Hour Quick Charger. Ergonomically balanced. 42" heavy duty flexible hose with bend restrictors for added life and durability.

Each kit contains:

- Powered Grease Gun Handle Assembly
- Two 19.2 Volt Heavy Duty NiCd Batteries
- 19.2 Volt 1-Hour Quick Charger
- 42" Heavy Duty Flexible Hose
- Grease Assembly Tube
- Heavy duty, high impact molded plastic carrying case
- 14.5 oz. capacity.



Lubrication



Replacement Grease Hoses

Professional-grade, heavy-duty cordless grease gun replacement parts.

PART#	FEATURES
11024	Specifically designed for replacing 11025 hose. 42" long.



Replacement Batteries

Professional-grade, heavy-duty cordless grease gun replacement parts.

PART#	FEATURES
11021	Suitable for 11025, Rechargeable NiCd. 19.2VDC, 1500 mAh



Replacement Chargers

Professional-grade, heavy-duty cordless grease gun replacement parts.

PART#	FEATURES
11023	Suitable for 11025 Rechargeable Grease Guns. 120V/60HZ input 19.2VDC , 1.3A, 1 hour quick charge, UL/ULC approved.

CHARGING THE BATTERY PACK ON RECHARGEABLE BATTERIES

Before using your Rechargeable Grease Gun for the first time, the NiCad battery pack should be charged for a minimum of 1.5 hours. If the battery pack is already installed in the Rechargeable Grease Gun, remove it by following the instructions under INSTALLING or REMOVING BATTERY PACK in the user manual. As the battery pack approaches the discharged state, you will notice a sharp drop in tool performance. When the tool is unable to perform the task at hand, it is time to recharge the battery pack. **Recharging the NiCad battery pack before this condition is reached will reduce the total work life of the pack.** Discharging the pack beyond this point can damage the pack. NOTE: Battery temperature will increase during and shortly after use. Batteries may not accept a full charge if they are charged immediately after use. Allow the battery pack to cool to room temperature before charging for best results.

Sizes are approximate. Specifications subject to change without notice.





11066 - Pistol Grip Grease Gun

- Premium Heavy duty model.
 - Die cast pump heads for strength and durability.
 - Knurled barrel for a non-slip grip.
 - Convenient one hand operation.
 - Uses standard 14 oz. grease cartridges or can be bulk filled.
 - Working pressure: 4,500 psi,
- develops up to 7500 psi.*
- Locking plunger mechanism holds follower rod firmly in place for easy cartridge replacement.
 - Includes 16" flexible hose, coupler and air release valve.
 - Variable stroke feature.



11084A - Pistol Grip Grease Gun

- Die cast pump heads for strength and durability.
 - Knurled barrel for a non-slip grip.
 - Convenient one hand operation.
 - Uses standard 14 oz. grease cartridges or can be bulk filled.
 - Working pressure: 4,500 psi, develops up to 7,300 psi.
- Locking plunger mechanism holds follower rod firmly in place for easy cartridge replacement.
 - Includes 18" flexible hose, 5" steel extension and grease coupler.
 - 0.7grams/Pump.
 - Includes 18" hose, grease coupler and steel extension.



11087A - Pistol Grip Grease Gun

- Die cast pump heads for strength and durability.
 - Knurled barrel for a non-slip grip.
 - Convenient one hand operation.
 - Uses standard 14 oz. grease cartridges or can be bulk filled.
 - Working pressure: 4,500 psi, develops up to 7,300 psi.
- Locking plunger mechanism holds follower rod firmly in place for easy cartridge replacement.
 - Includes 5" steel extension and grease coupler.
 - 0.7grams/Pump



11089A - Mini Pistol Grip Grease Gun

- Die cast pump head for strength and durability.
 - Knurled barrel for a non-slip grip.
 - Convenient one handed operation
 - Uses standard 3 oz. grease cartridges or can be bulk filled.
 - Working pressure: 2000psi,
- develops up to 4,000 psi.*
- Thumb release catch holds follower rod firmly in place for easy cartridge replacement.
 - Includes a 5" steel extension and grease coupler.

Sizes are approximate. Specifications subject to change without notice.



The lever action design of our heavy duty grease guns facilitate accurate control of grease flow. Fitted with a 6" steel curved extension pipe and coupler, these grease guns provide easy access to lubrication points in cars, trucks, tractors and heavy machinery. These grease guns can be loaded with 14 oz. cartridges, through a dispenser or bulk loaded.

11082C - Premium Heavy Duty Grease Gun

- Premium Heavy duty model with cast iron pump head.
- Variable stroke mechanism.
- Knurled barrel for a non-slip grip.
- Uses standard 14 oz. grease cartridges or can be bulk filled.
- Plunger stop holds follower rod firmly in place for easy cartridge replacement.
- Includes a 6" steel curved extension pipe and coupler.
- Working pressure: 4,500 psi, develops up to 10,000 psi.



11083 - Standard Duty Grease Gun

- Standard duty with die cast head.
- Knurled barrel for a non-slip grip.
- Uses standard 14 oz. grease cartridges or can be bulk filled.
- Includes a 6" steel curved extension pipe and coupler.
- Plunger stop holds follower rod firmly in place for easy cartridge replacement.
- Working pressure: 4,500 psi, develops up to 10,000 psi.



11085A - Heavy Duty Grease Gun

- Heavy duty with die cast pump head.
- Variable stroke feature.
- Vinyl grip handle.
- Knurled barrel for a non-slip grip.
- Uses standard 14 oz. grease cartridges or can be bulk filled.
- Plunger stop holds follower rod firmly in place for easy cartridge replacement.
- Includes a 6" steel curved extension pipe and coupler.
- Working pressure: 4,500 psi, develops up to 10,000 psi.



Multi-Purpose Lithium Grease

An excellent multi-purpose extreme pressure grease for ball joints, steering knuckles, chassis, etc. Very good sealing properties to keep water & dirt out. (Formula EP-2)

PART#	FEATURES	QTY.
11073	3 oz. (85g) grease tubes. Clamshell package.	Pkg. of 3
11070	14 oz. (400g) grease tube	Case of 10



Sizes are approximate. Specifications subject to change without notice.





11090A - Suction Gun

- Robust design for easy draining and filling.
- Capacity: 17 oz. (500 cc)
- Complete with 12" vinyl hose for transmission and differential service
- Powder coated blue paint.
- Precision follower provides superior suction for light grease, water and oil.



11093 - Fluid Transfer Pump

- Designed for the direct transfer of gasoline, oil and other non-corrosive fluids from one container to another.
- Capacity: 16.9 oz. (500 ml)
- Rugged construction.
- Supplied with two 48" clear PVC hoses.



11095 - Self Priming Copper Pump

- Glass ball, stainless steel spring and 6' of ethanol resistant hose
- 1/2" high quality copper pump



11096 - Multi-Use Siphon Pump

- Includes 2 red siphon hoses (4' & 1/4" each) with 2 connectors & 1 adapter
- 1 air pressure hose (15-1/2" long) with 2 piece adapter.
- 1 dipstick tube (47" long)
- 1 liquid/ air pump & siphon



11091 - Lever Action Pail Pump

- For transmission fluid and heavier oils (max. 140 wt.).
- Fits 5 gallon (20 liter) pails.
- Includes drum cover, 48" delivery hose, 46" usable hose length.
- 1L per 12 strokes, 2 oz. per stroke.

Sizes are approximate. Specifications subject to change without notice.



11092A - Lever Action Barrel Pump

Specially designed for the fast transfer of lubricants, solvents, agricultural and industrial chemicals, additives and other non-corrosive liquids from 15 to 55 gallon drums with 2" bung openings.

- Heavy Duty hand operated lever action dispenses approximately 3/4 pint (350 ml) per stroke.
- Equipped with brass rings, self-adjusting telescopic suction tube.
- 2" size bung nut and cushioned vinyl handle tube
- Outlet threaded for standard male garden hose connector or supplied curved spout.
- Zinc-plated corrosion resistant finish.
- **Not for use with anti-freeze**



11094A - Rotary Barrel Pump

- 1" NPT inlet, 1" O.D. discharge spout.
- Heavy duty cast iron construction.
- Smooth easy action.
- 2" NPT threaded bung adapter.
- 3 sections of 1" x 12" suction pipe included
- Compatible with: Diesel, kerosene, machine oil, fuel oil, agricultural fluids, detergents, lube oil, noncorrosive petroleum products
- Delivers 1 gallon per 18 strokes.
- Fits 30 gallon to 55 gallon barrels.



11800 - Diaphragm Fuel Pump

Fast, dual action. Double acting design delivers liquid on both in and out strokes. Recommended for gasoline and diesel fuel. Quickly dispenses gasoline, diesel fuel and light petroleum products.

- 2" bung adapter and manual nozzle (L30-90N).
- 22" to 39" telescoping suction tube with foot valve (L30-99N).
- Fits 15 to 55 gallon drum 8' hose with static wire (L30-95N).
- Dispenses 1 gallon per 8 strokes.
- Lockable handle.
- Airtight valves.
- Heavy duty diaphragm, large action surface.
- Includes check valve to prevent leaking.



11097 - Portable Fluid Pump

- For transmission fluid and heavier oils.
- Enamel painted finish. Rugged construction.
- Supplied with durable polycarbonate wheels and dispenser hose
- Hand operated pump.
- 5 gallon capacity drum.
- 2 oz. per stroke.
- 3/4" outside hose diameter.
- 1/2" inside hose diameter.
- 73" hose length



Sizes are approximate. Specifications subject to change without notice.





11802 - Used Fluid Drainer

Portable, special hose design for faster fluid transfer at any height. Height adjusts from 47-3/4" to 75-3/16" for draining fluids on vehicle lifts. Rugged steel construction.

- Tank capacity: 18 gallons (68.1L).
- Drain bowl capacity: 2.1 gallons (11.4L).
- Heavy duty 13-15/16" diameter drainage funnel with filter screen.
- 2.5 meters long evacuation hose with 1/4" - 18 NPT air coupler.
- Includes regulator and gauge.
- Two large 6" wheels and two 3" swivel casters.
- Working pressure: 10 PSI.
- Gauge: 0-23 PSI in 1/2 PSI increments.
- Drain Hose: 105" long x 1" diameter

Replacement Parts For Used Fluid Drainer (Part# 11802)

PART#	DESCRIPTION	PART#	DESCRIPTION
11802-8	Caster Kit	11802-4	Bowl Kits
11802-7	Wheel Kit	11802-3	Bowl & Ext. Tube Kit
11802-6	Regulator Kit	11802-2	Drain Hose Kit
11802-5	Locking Knob Kit	11802-1	Handle Kit



11804 - Fuel Cart with Pump

25 Gal. fuel caddy with manual rotary pump.

- Fill level gauge
- Ground wire and clamp
- Fire-screened vent and filler neck combination
- 25 Gal. steel tank
- 10' hose with reinforced metal tip
- Dolly handle for ease of moving
- Decal set for contents identification
- Aluminum rotary hand pump

11804-1 Replacement Fluid Transfer hose



11806 - Waste Oil Drainer and Charger

- 90 L tank capacity
- 60-70 L suction capacity
- 7-8 bar (100-115 psi) vacuum air pressure
- 150-180 sec depressurization time
- 78" suction hose
- 18 L collect bowl capacity
- 16" collect bowl diameter
- 80" draining hose length
- 1/4" NPT female
- 24" extension funnel
- 70 L max draining capacity
- 1 bar (14.5 psi) max draining pressure
- 1/4" air inlet quick plug connection

Sizes are approximate. Specifications subject to change without notice.



11071A - 360° Swivel Grease Coupler

- Swivels in full 360° circle & locks at any 45° position.
- Specifically designed for vehicles & equipment with hard-to-reach fittings.
- 1/8" NPT female inlet, 7,000 psi.
- 1 pc. in clamshell package.



11072 - Grease Accessory Kit

11 piece set in a blow case with instruction manual and color sleeve.

- 12" heavy duty extension hose.
- 1/8" NPT, 4,500 PSI working pressure.
- 1/8" NPT 360° swivel.
- 3 jaw heavy duty grease coupler.
- 4 jaw heavy duty grease coupler.
- 90° grease coupler adapter.
- Grease injection needle.
- 4" needle nozzle.
- Seal-off dispenser.
- Grease gun bracket.
- Needle tip adapter.
- Professional narrow needle nose dispenser.



Needle Nose Dispensers

Universal joints, tough to reach areas, 1/8" threads.

PART#	FEATURES	OVERALL LENGTH
11075A	1-1/2" Needle Nose Dispenser. 1 pc. in clamshell package.	2-3/4"
11080A	For dispensing a fine line of grease. 1 pc. in clamshell package.	1-1/2"



Needle Nose Adapter

PART#	FEATURES	OVERALL LENGTH
11076	4" long. For hard-to-reach grease points. Supplied with locking sleeve to fit all grease couplers. In clamshell package.	7-1/4"



Grease Gun Holder

PART#	FEATURES
11077	Holds grease guns and suction guns with 2-1/4" diameter barrel. Easily mounts on most surfaces.



Grease Injectors

For sealed bearings and joints. Supplied in a blister package.

PART#	FEATURES	QTY. PER PKG.
11122	18 gauge x 1-1/2" long.	3
11123A	18 gauge x 1-1/2" long.	1
11124A	18 gauge and 21 gauge, 1-1/2" long	2



Sizes are approximate. Specifications subject to change without notice.



Lubrication

Grease Couplers • Grease Hoses



90° Grease Coupler

PART#	FEATURES
11081A	Can be used where space is a problem or as a general purpose grease coupler. Fits all standard grease guns. 1 piece in clamshell package.



11121

Grease Couplers

With ball check and hex nut on body end. Fits over grease fittings.

PART#	FEATURES	QTY. PER PKG.
11121	6,000 psi. 1/8" NPT Coupler. For light to medium duty applications.	10
11121A	6,000 psi. 1/8" NPT Coupler. For light to medium duty applications.	1 (Dynapak)
11125	10,000 psi. 1/8" NPT Coupler. For heavy duty applications.	5
11125A	10,000 psi. 1/8" NPT Coupler. For heavy duty applications.	1 (Dynapak)



11125



Grease Filler Nipple

Fits into Grease Gun heads.

PART#	FEATURES	QTY. PER PKG.
11079A	Grease filler nipple, in Dynapak.	1 ea.



Grease Gun Pipe

For manual grease guns only.

PART#	LENGTH	ENDS	SAFE WORKING PRESSURE	PACKAGE TYPE
11078	5-1/2"	1/8" NPT	6,000 PSI	Polybag



Grease Hose - Nylon

Reinforced thermoplastic cover with nylon braid:

PART#	LENGTH	ENDS	SAFE WORKING PRESSURE	WORKING TEMPERATURE	PACKAGE TYPE
11140	12"	1/8" NPT	4,500 PSI	-40°C to 95°C	Retail pkg.
11141	18"	1/8" NPT	4,500 PSI	-40°C to 95°C	Retail pkg.



11144

Grease Hose - Steel wire

Reinforced rubber cover with steel wire braid:

PART#	LENGTH	ENDS	SAFE WORKING PRESSURE	WORKING TEMPERATURE	PACKAGE TYPE
11144	24"	1/8" NPT	3,600 PSI	-40°C to 95°C	Bulk with UPC label
11142A	12"	1/8" NPT	3,600 PSI	-40°C to 95°C	Retail pkg
11143A	18"	1/8" NPT	3,600 PSI	-40°C to 95°C	Retail pkg

Grease Hose - Steel wire (in display box)

Reinforced rubber cover with steel wire braid. Working temperature: -40° to 95°C. Each grease hose is individually UPC barcode labeled inside a full colour display box.



PART#	LENGTH	ENDS	SAFE WORKING PRESSURE	WORKING TEMPERATURE	PACKAGE TYPE
11142	12"	1/8" NPT	3,600 PSI	-40°C to 95°C	10/ Package
11143	18"	1/8" NPT	3,600 PSI	-40°C to 95°C	10/ Package

Sizes are approximate. Specifications subject to change without notice.



Lubrication



Metric Grease Fittings

Tested to 8,000 PSI, 08F Carbon Steel. Zinc plated finish.

BULK PACK PART#	QTY.	MINI-PACK PART#	QTY.	DYNAPAK PART#	QTY.	TYPE	THREAD	OVERALL LENGTH (MM)	INDUSTRY NUMBER
11114	100	11414	25	11114A	10	Straight	M6 x 1	15	2106
11115	100	11415	25	11115A	5	45°	M6 x 1	20.50	2107
11116	100	11416	25	11116A	5	90°	M6 x 1	19	2108
11117	100	11417	25	11117A	10	Straight	M8 x 1	15.7	2103
11118	100	11418	25	11118A	10	45°	M8 x 1	20.5	2104
11119	100	11419	25	11119A	5	90°	M8 x 1	19	2105
11120	100	11420	25	11120A	5	Straight	M10 x 1	16	2109
11126	100	11426	25	11126A	5	45°	M10 x 1	22.60	2110
11127	100	11427	25	11127A	5	90°	M10 x 1	21.40	2111



Straight



90°



45°

Drive-In Grease Fittings

Use a drive-in grease fitting tool to tap into desired area.
Tested to 8,000 PSI, 08F Carbon Steel. Zinc plated finish.

BULK PACK PART#	QTY.	MINI-PACK PART#	QTY.	DYNAPAK PART#	QTY.	TYPE	DRILL SIZE	OVERALL LENGTH	INDUSTRY NUMBER
11131	100	11431	25	11131A	5	Drive In	3/16"	33/64"	1728-B
11132	100	11432	25	11132A	5	Drive In	1/4"	35/64"	1743-B
11133	100	11433	25	11133A	5	Drive In	5/16"	35/64"	1608-B
11134	100	11434	25	11134A	5	Drive In	3/8"	37/64"	1666

Drive-In



With Ball Check

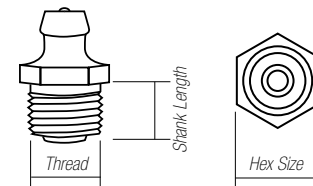

S.A.E. Grease Fittings (Grease Zerks)

Tested to 8,000 PSI, 08F Carbon Steel. Zinc plated finish.

BULK PACK PART#	QTY.	MINI-PACK PART#	QTY.	DYNAPAK PART#	QTY.	TYPE	THREAD	OVERALL LENGTH	SHANK LENGTH (MM)	HEX SIZE (MM)	INDUSTRY NUMBER
11100	100	11400	25	11100A	10	Straight	1/8" NPT*	21/32" (17.52mm)	7.51	11	1610
11102	100	11402	25	11102A	5	45°	1/8" NPT*	7/8" (22.60mm)	7.5	11	1688
11104	100	11404	25	11104A	5	90°	1/8" NPT*	27/32" (21.40mm)	7.5	11	1613
11105	100	11405	25	11105A	10	Straight	1/4" - 28	1/2" (13.97mm)	4.8	8mm	1641
11106	100	11406	25	11106A	10	Straight	1/4" - 28 Long	11/16" (17.5mm)	9.1	8	1652
11107	100	11407	25	11107A	5	45°	1/4" - 28	7/8" (20.57mm)	5.15	9.5	1637
11109	100	11409	25	11109A	5	90°	1/4" - 28	25/32" (19.05mm)	5.15	9.5	1911
11110	50	11410	25	11110A	5	Straight	1/4" NPT*	15/16" (22.35mm)	10.7	14.3	1627
11112	100	11412	25	11112A	5	Straight	5/16" - 24UNF	21/32" (14.30mm)	4	9.50	1711
11113	100	11413	25	11113A	5	Straight	3/8" - 24UNF	9/16" (15.75mm)	6.35	11	1710

* NPT - National Pipe Thread **UNF - Unified National Fine *** Threads Per Inch

Sizes are approximate. Specifications subject to change without notice.



Lubrication

Grease Tube Containers • Oilers



Lubrication



13000 - Grease Box

- A convenient and durable storage container for grease tubes.
- Features snap top lid, grip handles & carry strap.
- Provides safe storage and transportation, preventing spills & contamination.
- Stores 12 tubes upright, dust caps on.



13002 - Grease-2-Go!

- Can be fastened to a wall or equipment.
- Durable plastic material.
- Stores and protects two 14 oz. grease cartridges upright.



Pistol

Thumb Pump

Pump Oilers

Seamless steel body and brass pump mechanism. Durable enamel painted finish. Supplied with flexible and rigid metal spouts.

PART#	TYPE	CAPACITY
13604	Pistol	4.4 oz. (125 cc)
13606	Pistol	6 oz. (180cc)
13607	Thumb Pump	7 oz. (200 cc)
13610	Thumb Pump	10.6 oz. (300 cc)
13617	Thumb Pump	17 oz. (500 cc)
13624	Thumb Pump	24 oz. (700 cc)

Oilers with Base

Ideal for oils, acids, adhesives, etc. Will not rust, leak or dent. Made of flexible, durable polyethylene. Removeable base for easy cleaning.



DYNALINE CLUTHE

PART#	PART#	DESCRIPTION
13030	C30300	3" Nozzle, 6 oz./180 ml capacity, natural
13031	C30310	3" Nozzle, 10 oz./284 ml capacity, natural

Sizes are approximate. Specifications subject to change without notice.



Multi-Purpose Funnels (Single)

Flexible, durable, spark-proof, dent-proof, rust-proof polyethylene. Features a handy hang-up tab.

DYNALINE **CLUTHE**

PART#	PART#	SIZE	CAPACITY	SPOUT DIAMETER	SPOUT LENGTH	OPENING DIAMETER
13504	C35040	4"	8 oz. (237 ml)	1/2"	2-1/2"	3-7/8"
13505	C35050	5"	14 oz. (414 ml)	1/2"	1-1/4"	4-3/4"
13506		6"	32 oz. (946 ml)	5/8"	2"	5-3/4"
13507	C35070	7"	28 oz. (828 ml)	1/2"	2-1/2"	6-3/4"
13508		8"	120 oz. (3.55 L)	1"	3-7/8"	7-5/8"
13510		10"	160 oz. (4.73 L)	1-1/2"	3-7/8"	9-7/8"



3-Piece Funnel Set

PART#	DESCRIPTION
13503	• One each of: 4", 5" and 6" Multi-Purpose Funnels



4-Piece Funnel Set

PART#	DESCRIPTION
13511	• One each of: 2", 3", 4", 5" Multi-Purpose Funnels.



Industrial Funnels

Made of flexible, durable, spark-proof, dent-proof, rust-proof, clear polyethylene. Features a handy hang-up tab. Supplied with one 100 mesh filter.

DYNALINE **CLUTHE**

PART#	PART#	SIZE	CAPACITY	SPOUT DIAMETER	SPOUT LENGTH	OPENING DIAMETER
13003	C30030	3"	6 oz. (177 ml)	3/16"	1-7/8"	3"
13005	C30050	5"	24 oz. (710 ml)	1/2"	2-1/4"	5-3/8"
13009	C30090	9"	144 oz. (4.26 L)	1"	3-3/8"	8-1/2"



Wide Spout Industrial Funnels

Made of flexible, durable, spark-proof, dent-proof, rust-proof, clear polyethylene. Features a handy hang-up tab. Supplied with one 100 mesh filter.

PART#	DESCRIPTION
C30450	• 5-1/2" wide spout, 24 oz. capacity, natural.



Sizes are approximate. Specifications subject to change without notice.





Automotive Funnel

Made of flexible, durable, spark-proof, dent-proof, rust-proof, clear polyethylene. Features a handy hang-up tab. Supplied with one 100 mesh filter.

DYNALINE **CLUTHÉ**

PART#	PART#	SIZE	CAPACITY	SPOUT DIAMETER	SPOUT LENGTH	OPENING DIAMETER
13008	C30080	8"	120 oz. (3.5 L)	7/8"	5-1/4"	7-1/2"



Anti-Splash Funnels

Made of flexible, durable, spark-proof, dent-proof, rust-proof, clear polyethylene. Features a handy hang-up tab. Supplied with anti-splash rim and one 100 mesh filter.

DYNALINE **CLUTHÉ**

PART#	PART#	SIZE	CAPACITY	SPOUT DIAMETER	SPOUT LENGTH	OPENING DIAMETER
13015	C30150	5"	24 oz. (710 ml)	1/2"	2-1/4"	5-1/4"
13019	C30190	9"	144 oz. (4.26 L)	1"	3-3/8"	8-1/4"



2-In-1 Flexible Spout Funnel

Complete with mesh filter. Detachable spout.

PART#	SIZE	SPOUT DIAMETER	SPOUT LENGTH	OPENING DIAMETER
14015	15.6"	3/8"	10"	6-1/2"



15014

Foldable Funnel

- This **moldable rubber** device can be shaped to divert oil or any liquid around engine parts and into your drain pan.
- **Bend it, fold it, mold it** and the shape stays put and the funnel stays in place for hands-free use. Perfect for draining fluids from any vehicle or equipment including cars, trucks, motorcycles, aircraft, boats, generators, snow blowers, mowers and more.
- Made from a thick, pliable **Nitrile rubber** encasing a thin pliable piece of aluminum alloy. Fluids from -30°F to 450°F won't harm the surface.
- Dynaline Foldable Funnel **cleans up easily** with a wipe.
- **Store it flat or roll it up** to fit in any space.
- Sold in **easy to setup merchandiser** (as seen)

PART#	SIZE
15009	9" x 4-3/4"
15014	14-1/2" x 6-1/2"

Sizes are approximate. Specifications subject to change without notice.



Replacement Funnel Filter

Fits industrial, automotive and anti-splash funnels.

PART#	FEATURES	DIAMETER	QTY. PER PKG.
13100	100 Mesh	2"	10



Transmission Funnel

Detachable spout.

PART#	OVERALL LENGTH	SPOUT DIAMETER	SPOUT LENGTH	OPENING DIAMETER
14017	22"	3/8"	16"	5-1/2"



Super Funnel

PART#	OVERALL LENGTH	SPOUT DIAMETER	SPOUT LENGTH	OPENING DIAMETER
14018	18"	3/8"	7"	5"



Dirt Free Funnels

Flexible, durable, spark proof, dent proof, leak proof. Large handle. Removable caps on opening and spout prevent foreign material from entering when not in use.

PART#	OVERALL LENGTH	COLOUR	OPENING DIAMETER	SPOUT DIAMETER
14035	15"	Yellow	4-1/2"	5/8"
14037	17"	Orange	4-1/2"	9/16"



Heavy Duty Flex Spout Funnel

Heavy duty. Complete with metal filter screen.

PART#	OVERALL LENGTH	COLOUR	OPENING DIAMETER	SPOUT DIAMETER
14013	17"	Orange	7"	3/4"



Measurer with Lid & Nozzle

Will not rust, dent or leak. Ideal for handling all kinds of fluids. Embedded lid and nozzle.

PART#	CAPACITY	SPOUT DIAMETER	SPOUT LENGTH
14040	1 gal. (4 L)	5/8"	2-3/4 / 8-14"



Sizes are approximate. Specifications subject to change without notice.



Lubrication

Measuring Containers • Scoops • Fillers



Lubrication



14025/ 13402

Measuring Container

US, Imperial, and Metric graduations. Ideal for fluids and dry material.

DYNALINE **CLUTHÉ**

PART#	PART#	CAPACITY	DESCRIPTION
13402	C34026	84.5 oz./2.5L	Calibrated measurer with detachable lid and nozzle
14025	C34020	84.5 oz./2.5L	Calibrated measurer
14045X	C34046	152 oz./4.5L	Calibrated measurer with detachable lid and nozzle
13404	C34040	152 oz./4.5L	Calibrated measurer



Measurer w/Fixed Lid & Nozzle

US, Imperial, and Metric graduations. Ideal for fluids and dry material.

PART#	CAPACITY	SPOUT DIAMETER	SPOUT LENGTH	LID TYPE
14045	152 oz. (4.5L)	7/16"	5"	Blow molded fixed lid



Portable Measurer

Supplied with shut off valve and cold temperature hose. Used to transport, dispense and measure fluids including motor oil, hydraulic fluids and antifreeze. Common applications are heavy trucks, construction and farm equipment.

PART#	CAPACITY	DIMENSIONS	SPOUT LENGTH	HOSE LENGTH
14047	5L	11-1/4"L x 6-1/2"H	3-1/2"	18"



Measuring Scoops

US, Imperial, and Metric graduations. Ideal for handling dry materials.

DYNALINE **CLUTHÉ**

PART#	PART#	CAPACITY	DESCRIPTION
13311	C33110	52 oz. (1.5L)	7" scoop, 11-1/2" overall length, translucent
13314	C33140	104 oz. (3L)	10" overall length, translucent



Automatic Battery Filler

Safety nozzle/push-in style. Automatic shut-off to help prevent spilling and over filling.

PART#	CAPACITY	SPOUT DIAMETER	SPOUT LENGTH
14024	1/2 gal. (2 L)	7/32"	2-1/2"

Sizes are approximate. Specifications subject to change without notice.



Tin Funnel

Made of lightweight tin coated steel.

PART#	CAPACITY	DIAMETER	SPOUT DIAMETER	SPOUT LENGTH
13550	5 oz. (148 ml)	3-1/2"	2-1/8"	3/8"



Tractor Funnel

Heavy duty galvanized steel. Comes with one gold mesh filter, 11-1/2" high.

PART#	CAPACITY	DIAMETER	TIP OUTSIDE DIAMETER	SPOUT DIAMETER	SPOUT LENGTH
13811	8 qt. (7.5 L)	9-1/2"	1"	1"	3-5/8"



Offset Transmission Funnel

PART#	CAPACITY	DIAMETER	FIXED SPOUT DIAMETER	FLEX SPOUT DIAMETER	FLEX SPOUT LENGTH
14008	2 L	7"	1"	5/8"	17"



Transmission Funnel

Galvanized metal. Complete with mesh filter.

PART#	CAPACITY	DIAMETER	FIXED SPOUT DIAMETER	FLEX SPOUT DIAMETER	FLEX SPOUT LENGTH
14014	1 L	5-1/2"	5/8"	1/2"	14"



Metal Measurer

Made of heavy duty galvanized steel. Complete with flex spout and easy grip handle.

PART#	CAPACITY	SPOUT DIAMETER	SPOUT LENGTH
14140	4 qt. (4 L)	1/2"	7-1/2"



Sizes are approximate. Specifications subject to change without notice.



Lubrication

Drain Pans



14026 - Seal-able Drain Pan

- 10 L capacity
- Seals to keep fluids in during transportation



14028 - Seal-able Oil Drain Pan with Wheels

- 44 L capacity
- Seals to keep fluids in during transportation
- Handles on end for easy transportation



14032 - Low Profile Oil Drain with Manual Pump

- 70 L capacity
- 8' evacuation hose
- 5' suction distance
- 16.5' lift distance
- 0.3 L / rotation flow rate
- caster wheels allow for easy mobility
- Long handle for easy mobility

Dynaline offers merchandisers for almost every product. If you are ordering the products above the you may be interested in the following O-Ring Merchandiser.

Plastic Funnels & Measures

PART#	CONTENTS
00626	Plastic Funnels & Measurer's Backdrop Only , 48" x 48".
00626K	Full Plastic Funnels & Measures Plan-o-gram. Includes 00626 and the most popular products



Your Trusted Source.

Sizes are approximate. Specifications subject to change without notice.



Truck & Trailer Drain Pan

Made of rugged high-density polyethylene. Features easy to use carrying handles.

PART#	DESCRIPTION	CAPACITY
14019	Fits rims 13-3/4" (inside diameter) and larger.	3L



Drain Pans

Made of rugged high-density polyethylene.

PART#	CAPACITY	LENGTH	DEPTH	WIDTH
14022	16L	23"	5-1/2"	18"
14023	24L	32"	7-1/2"	21-1/2"



14022



14023

Easy Flow Funnel

Offset spout for the hard to reach areas. For oils and other engine fluids. Perfect for small engines, lawnmowers, ATV's, Motorcycles, Tractors, Generators, Pressure washers, Trucks and Motorized equipment.

PART#	CAPACITY	LENGTH	SPOUT DIA.	DIAMETER
13007	1L	16"	1/2"	4.5"



Sizes are approximate. Specifications subject to change without notice.



S.A.E. O-rings

Used for petroleum based fuel/oil, water, alcohol, some acids and bases.
 Temperature range -55oC to 120oC. Buna N-70R Nitrile Durometer A.
 Conforms to ASTM D2000 M2BF714, B14, EA14, EF11, EF21, EO14 & EO34.



Reference Chart Available

See end of catalogue

PART#	INDUSTRY NUMBER	THICKNESS	INSIDE DIAMETER	OUTSIDE DIAMETER	QTY PER PKG.
54006	6	1/16"	1/8"	1/4"	Pkg. of 15
54007	7	1/16"	5/32"	9/32"	Pkg. of 15
54008	8	1/16"	3/16"	5/16"	Pkg. of 15
54009	9	1/16"	7/32"	11/32"	Pkg. of 15
54010	10	1/16"	1/4"	3/8"	Pkg. of 15
54011	11	1/16"	5/16"	7/16"	Pkg. of 15
54012	12	1/16"	3/8"	1/2"	Pkg. of 15
54013	13	1/16"	7/16"	9/16"	Pkg. of 10
54014	14	1/16"	1/2"	5/8"	Pkg. of 10
54015	15	1/16"	9/16"	11/16"	Pkg. of 10
54016	16	1/16"	5/8"	3/4"	Pkg. of 10
54017	17	1/16"	11/16"	13/16"	Pkg. of 10
54018	18	1/16"	3/4"	7/8"	Pkg. of 10
54019	19	1/16"	13/16"	15/16"	Pkg. of 10
54020	20	1/16"	7/8"	1"	Pkg. of 10
54021	21	1/16"	15/16"	1-1/16"	Pkg. of 10
54022	22	1/16"	1"	1-1/8"	Pkg. of 10
54023	23	1/16"	1-1/16"	1-3/16"	Pkg. of 10
54024	24	1/16"	1-1/8"	1-1/4"	Pkg. of 10
54025	25	1/16"	1-3/16"	1-5/16"	Pkg. of 10
54026	26	1/16"	1-1/4"	1-3/8"	Pkg. of 10
54027	27	1/16"	1-5/16"	1-7/16"	Pkg. of 10
54028	28	1/16"	1-3/8"	1-1/2"	Pkg. of 10
54110	110	3/32"	3/8"	9/16"	Pkg. of 15
54111	111	3/32"	7/16"	5/8"	Pkg. of 15
54112	112	3/32"	1/2"	11/16"	Pkg. of 15
54113	113	3/32"	9/16"	3/4"	Pkg. of 15
54114	114	3/32"	5/8"	13/16"	Pkg. of 15
54115	115	3/32"	11/16"	7/8"	Pkg. of 15
54116	116	3/32"	3/4"	15/16"	Pkg. of 15
54117	117	3/32"	13/16"	1"	Pkg. of 10
54118	118	3/32"	7/8"	1-1/16"	Pkg. of 10
54119	119	3/32"	15/16"	1-1/8"	Pkg. of 10
54120	120	3/32"	1"	1-3/16"	Pkg. of 10
54121	121	3/32"	1-1/16"	1-1/4"	Pkg. of 10
54122	122	3/32"	1-1/8"	1-5/16"	Pkg. of 10
54123	123	3/32"	1-3/16"	1-3/8"	Pkg. of 10
54124	124	3/32"	1-1/4"	1-7/16"	Pkg. of 10
54125	125	3/32"	1-5/16"	1-1/2"	Pkg. of 10
54126	126	3/32"	1-3/8"	1-9/16"	Pkg. of 10
54127	127	3/32"	1-7/16"	1-5/8"	Pkg. of 10

Sizes are approximate. Specifications subject to change without notice.



S.A.E. O-rings

Used for petroleum based fuel/oil, water, alcohol, some acids and bases.
 Temperature range -55oC to 120oC. Buna N-70R Nitrile Durometer A.
 Conforms to ASTM D2000 M2BF714, B14, EA14, EF11, EF21, EO14 & EO34.

PART#	INDUSTRY NUMBER	THICKNESS	INSIDE DIAMETER	OUTSIDE DIAMETER	QTY PER PKG.
54128	128	3/32"	1-1/2"	1-11/16"	Pkg. of 10
54129	129	3/32"	1-9/16"	1-3/4"	Pkg. of 10
54130	130	3/32"	1-5/8"	1-13/16"	Pkg. of 10
54131	131	3/32"	1-11/16"	1-7/8"	Pkg. of 10
54132	132	3/32"	1-3/4"	1-15/16"	Pkg. of 10
54133	133	3/32"	1-13/16"	2"	Pkg. of 10
54134	134	3/32"	1-7/8"	2-1/16"	Pkg. of 10
54135	135	3/32"	1-15/16"	2-1/8"	Pkg. of 10
54136	136	3/32"	2"	2-3/16"	Pkg. of 10
54137	137	3/32"	2-1/16"	2-1/4"	Pkg. of 10
54138	138	3/32"	2-1/8"	2-5/16"	Pkg. of 10
54139	139	3/32"	2-3/16"	2-3/8"	Pkg. of 10
54140	140	3/32"	2-1/4"	2-7/16"	Pkg. of 10
54141	141	3/32"	2-5/16"	2-1/2"	Pkg. of 10
54142	142	3/32"	2-3/8"	2-9/16"	Pkg. of 10
54143	143	3/32"	2-7/16"	2-5/8"	Pkg. of 10
54144	144	3/32"	2-1/2"	2-11/16"	Pkg. of 10
54145	145	3/32"	2-9/16"	2-3/4"	Pkg. of 10
54146	146	3/32"	2-5/8"	2-13/16"	Pkg. of 10
54147	147	3/32"	2-11/16"	2-7/8"	Pkg. of 10
54148	148	3/32"	2-3/4"	2-15/16"	Pkg. of 10
54149	149	3/32"	2-13/16"	3"	Pkg. of 10
54210	210	1/8"	3/4"	1"	Pkg. of 10
54211	211	1/8"	13/16"	1-1/16"	Pkg. of 10
54212	212	1/8"	7/8"	1-1/8"	Pkg. of 10
54213	213	1/8"	15/16"	1-3/16"	Pkg. of 10
54214	214	1/8"	1"	1-1/4"	Pkg. of 10
54215	215	1/8"	1-1/16"	1-5/16"	Pkg. of 10
54216	216	1/8"	1-1/8"	1-3/8"	Pkg. of 10
54217	217	1/8"	1-3/16"	1-7/16"	Pkg. of 10
54218	218	1/8"	1-1/4"	1-1/2"	Pkg. of 10
54219	219	1/8"	1-5/16"	1-9/16"	Pkg. of 10
54220	220	1/8"	1-3/8"	1-5/8"	Pkg. of 10
54221	221	1/8"	1-7/16"	1-11/16"	Pkg. of 10
54222	222	1/8"	1-1/2"	1-3/4"	Pkg. of 10
54223	223	1/8"	1-5/8"	1-7/8"	Pkg. of 10
54224	224	1/8"	1-3/4"	2"	Pkg. of 10
54225	225	1/8"	1-7/8"	2-1/8"	Pkg. of 10
54226	226	1/8"	2"	2-1/4"	Pkg. of 10
54227	227	1/8"	2-1/8"	2-3/8"	Pkg. of 10
54228	228	1/8"	2-1/4"	2-1/2"	Pkg. of 10



Reference Chart Available

See end of catalogue

Sizes are approximate. Specifications subject to change without notice.



S.A.E. O-rings

Used for petroleum based fuel/oil, water, alcohol, some acids and bases.
 Temperature range -55oC to 120oC. Buna N-70R Nitrile Durometer A.
 Conforms to ASTM D2000 M2BF714, B14, EA14, EF11, EF21, EO14 & EO34.



Reference Chart Available

See end of catalogue

PART#	INDUSTRY NUMBER	THICKNESS	INSIDE DIAMETER	OUTSIDE DIAMETER	QTY PER PKG.
54229	229	1/8"	2-3/8"	2-5/8"	Pkg. of 10
54230	230	1/8"	2-1/2"	2-3/4"	Pkg. of 10
54231	231	1/8"	2-5/8"	2-7/8"	Pkg. of 10
54232	232	1/8"	2-3/4"	3"	Pkg. of 10
54233	233	1/8"	2-7/8"	3-1/8"	Pkg. of 10
54234	234	1/8"	3"	3-1/4"	Pkg. of 10
54235	235	1/8"	3-1/8"	3-3/8"	Pkg. of 10
54236	236	1/8"	3-1/4"	3-1/2"	Pkg. of 10
54237	237	1/8"	3-3/8"	3-5/8"	Pkg. of 10
54238	238	1/8"	3-1/2"	3-3/4"	Pkg. of 10
54239	239	1/8"	3-5/8"	3-7/8"	Pkg. of 10
54240	240	1/8"	3-3/4"	4"	Pkg. of 10
54241	241	1/8"	3-7/8"	4-1/8"	Pkg. of 10
54242	242	1/8"	4"	4-1/4"	Pkg. of 10
54243	243	1/8"	4-1/8"	4-3/8"	Pkg. of 10
54244	244	1/8"	4-1/4"	4-1/2"	Pkg. of 10
54245	245	1/8"	4-3/8"	4-5/8"	Pkg. of 10
54246	246	1/8"	4-1/2"	4-3/4"	Pkg. of 10
54247	247	1/8"	4-5/8"	4-7/8"	Pkg. of 10
54248	248	1/8"	4-3/4"	5"	Pkg. of 10
54249	249	1/8"	4-7/8"	5-1/8"	Pkg. of 5
54250	250	1/8"	5"	5-1/4"	Pkg. of 5
54251	251	1/8"	5-1/8"	5-3/8"	Pkg. of 5
54252	252	1/8"	5-1/4"	5-1/2"	Pkg. of 5
54253	253	1/8"	5-3/8"	5-5/8"	Pkg. of 5
54254	254	1/8"	5-1/2"	5-3/4"	Pkg. of 5
54255	255	1/8"	5-5/8"	5-7/8"	Pkg. of 5
54256	256	1/8"	5-3/4"	6"	Pkg. of 5
54257	257	1/8"	5-7/8"	6-1/8"	Pkg. of 5
54258	258	1/8"	6"	6-1/4"	Pkg. of 5
54325	325	3/16"	1-1/2"	1-7/8"	Pkg. of 5
54326	326	3/16"	1-5/8"	2"	Pkg. of 5
54327	327	3/16"	1-3/4"	2-1/8"	Pkg. of 5
54328	328	3/16"	1-7/8"	2-1/4"	Pkg. of 5
54329	329	3/16"	2"	2-3/8"	Pkg. of 5
54330	330	3/16"	2-1/8"	2-1/2"	Pkg. of 5
54331	331	3/16"	2-1/4"	2-5/8"	Pkg. of 5
54332	332	3/16"	2-3/8"	2-3/4"	Pkg. of 5
54333	333	3/16"	2-1/2"	2-7/8"	Pkg. of 5
54334	334	3/16"	2-5/8"	3"	Pkg. of 5
54335	335	3/16"	2-3/4"	3-1/8"	Pkg. of 5
54336	336	3/16"	2-7/8"	3-1/4"	Pkg. of 5

Sizes are approximate. Specifications subject to change without notice.



Lubrication



S.A.E. O-rings

Used for petroleum based fuel/oil, water, alcohol, some acids and bases.
 Temperature range -55oC to 120oC. Buna N-70R Nitrile Durometer A.
 Conforms to ASTM D2000 M2BF714, B14, EA14, EF11, EF21, EO14 & EO34.

PART#	INDUSTRY NUMBER	THICKNESS	INSIDE DIAMETER	OUTSIDE DIAMETER	QTY PER PKG.
54337	337	3/16"	3"	3-3/8"	Pkg. of 5
54338	338	3/16"	3-1/8"	3-1/2"	Pkg. of 5
54339	339	3/16"	3-1/4"	3-5/8"	Pkg. of 5
54340	340	3/16"	3-3/8"	3-3/4"	Pkg. of 5
54341	341	3/16"	3-1/2"	3-7/8"	Pkg. of 5
54342	342	3/16"	3-5/8"	4"	Pkg. of 5
54343	343	3/16"	3-3/4"	4-1/8"	Pkg. of 5
54344	344	3/16"	3-7/8"	4-1/4"	Pkg. of 5
54345	345	3/16"	4"	4-3/8"	Pkg. of 5
54346	346	3/16"	4-1/8"	4-1/2"	Pkg. of 5
54347	347	3/16"	4-1/4"	4-5/8"	Pkg. of 5
54348	348	3/16"	4-3/8"	4-3/4"	Pkg. of 5
54349	349	3/16"	4-1/2"	4-7/8"	Pkg. of 5
54350	350	3/16"	4-5/8"	5"	Pkg. of 5
54425	425	1/4"	4-1/2"	5"	Pkg. of 2
54426	426	1/4"	4-5/8"	5-1/8"	Pkg. of 2
54427	427	1/4"	4-3/4"	5-1/4"	Pkg. of 2
54428	428	1/4"	4-7/8"	5-3/8"	Pkg. of 2
54429	429	1/4"	5"	5-1/2"	Pkg. of 2
54430	430	1/4"	5-1/8"	5-5/8"	Pkg. of 2
54431	431	1/4"	5-1/4"	5-3/4"	Pkg. of 2
54432	432	1/4"	5-3/8"	5-7/8"	Pkg. of 2
54433	433	1/4"	5-1/2"	6"	Pkg. of 2
54434	434	1/4"	5-5/8"	6-1/8"	Pkg. of 2
54435	435	1/4"	5-3/4"	6-1/4"	Pkg. of 2
54436	436	1/4"	5-7/8"	6-3/8"	Pkg. of 2
54437	437	1/4"	6"	6-1/2"	Pkg. of 2



Reference Chart Available

See end of catalogue



Your Trusted Source.



00154

The products above are also available in convenient and easy-to-stock kits.

See the [Assortments Section](#) in this catalogue for more information on these products.



00150

Sizes are approximate. Specifications subject to change without notice.





Reference Chart Available

See end of catalogue

Metric O-Rings

Buna N-70R Nitrile Durometer A.

Conforms to ASTM D2000 M2BF714, B14, EA14, EF11, EF21, EO14, EO34.

PART#	INSIDE DIAMETER	OUTSIDE DIAMETER	THICKNESS	QTY PER PKG.
54501	3 mm	7 mm	2 mm	Pkg. of 10
54502	5 mm	9 mm	2 mm	Pkg. of 10
54503	6 mm	10 mm	2 mm	Pkg. of 10
54504	8 mm	12 mm	2 mm	Pkg. of 10
54505	10 mm	14 mm	2 mm	Pkg. of 10
54506	13 mm	17 mm	2 mm	Pkg. of 10
54507	10 mm	15 mm	2.5 mm	Pkg. of 10
54508	12 mm	17 mm	2.5 mm	Pkg. of 10
54509	14 mm	19 mm	2.5 mm	Pkg. of 10
54510	15 mm	20 mm	2.5 mm	Pkg. of 10
54511	16 mm	21 mm	2.5 mm	Pkg. of 10
54512	19 mm	23 mm	2.5 mm	Pkg. of 10
54513	20 mm	25 mm	2.5 mm	Pkg. of 10
54514	21 mm	26 mm	2.5 mm	Pkg. of 10
54515	22 mm	27 mm	2.5 mm	Pkg. of 10
54516	18 mm	25 mm	3.5 mm	Pkg. of 10
54517	20 mm	27 mm	3.5 mm	Pkg. of 10
54518	22 mm	29 mm	3.5 mm	Pkg. of 10
54519	23 mm	30 mm	3.5 mm	Pkg. of 10
54520	25 mm	32 mm	3.5 mm	Pkg. of 10
54521	27 mm	34 mm	3.5 mm	Pkg. of 10
54522	28 mm	35 mm	3.5 mm	Pkg. of 10
54523	30 mm	37 mm	3.5 mm	Pkg. of 10
54524	31 mm	38 mm	3.5 mm	Pkg. of 10
54525	32 mm	39 mm	3.5 mm	Pkg. of 10
54526	34 mm	41 mm	3.5 mm	Pkg. of 10
54527	36 mm	43 mm	3.5 mm	Pkg. of 10
54528	38 mm	45 mm	3.5 mm	Pkg. of 10
54529	41 mm	48 mm	3.5 mm	Pkg. of 10
54530	44 mm	51 mm	3.5 mm	Pkg. of 10
54531	46 mm	53 mm	3.5 mm	Pkg. of 10
54532	50 mm	57 mm	3.5 mm	Pkg. of 10

Sizes are approximate. Specifications subject to change without notice.



High Pressure O-Rings

Buna N-90R Nitrile Durometer A, rigid material, stronger. Handles more pressure.

PART#	INDUSTRY NUMBER	THICKNESS	INSIDE DIAMETER	OUTSIDE DIAMETER	QTY PER PKG.
54901	901	1/16"	3/16"	5/16"	Pkg. of 10
54902	902	1/16"	1/4"	3/8"	Pkg. of 10
54903	903	1/16"	5/16"	7/16"	Pkg. of 10
54904	904	1/16"	11/32"	1/2"	Pkg. of 10
54905	905	1/16"	7/16"	9/16"	Pkg. of 10
54906	906	1/16"	15/32"	5/8"	Pkg. of 10
54907	907	1/16"	17/32"	11/16"	Pkg. of 10
54908	908	3/32"	21/32"	13/16"	Pkg. of 10
54909	909	3/32"	23/32"	29/32"	Pkg. of 10
54910	910	3/32"	3/4"	15/16"	Pkg. of 10
54911	911	1/8"	7/8"	1-3/32"	Pkg. of 10
54912	912	1/8"	15/16"	1-5/32"	Pkg. of 10
54913	913	1/8"	1"	1-7/32"	Pkg. of 10
54914	914	1/8"	1-1/16"	1-1/4"	Pkg. of 10
54916	916	1/8"	1-3/16"	1-3/8"	Pkg. of 10
54918	918	1/8"	1-3/8"	1-9/16"	Pkg. of 10
54920	920	1/8"	1-1/2"	1-3/4"	Pkg. of 10
54924	924	1/8"	1-3/4"	2"	Pkg. of 10
54928	928	1/8"	2-3/16"	2-3/8"	Pkg. of 10
54932	932	1/8"	2-3/8"	2-9/16"	Pkg. of 10



Reference Chart Available
See end of catalogue



Lubrication



Your Trusted Source.

Dynaline offers merchandisers for most products and we can help get your stock organized. We offer O-rings on a display merchandiser, as shown, or in tilt bin option.

00318k - O-Rings Merchandiser

PART#	CONTENTS
00318	O-Rings Display Board Only , 24" x 24"
00318K	Full O-Rings Merchandiser . Includes 00318 display board, 110 cornice hooks (65043) and the most popular products.



Sizes are approximate. Specifications subject to change without notice.





What is Nitrile (Buna-N NBR) ?

- Nitrile rubber is the general item for acrylonitrile butadiene terpolymer.
- The acrylonitrile content of the nitrile sealing compounds varies considerably (18% to 50%) and influences the physical properties of the finished material.
- The higher the acrylonitrile content, the better the resistance to oil and fuel.
- At the same time, elasticity and resistance to compression set is adversely affected. In view of these opposing realities, a compromise is often drawn, and a medium acrylonitrile content selected.
- Nitrile has good mechanical properties when compared with other elastomers and high wear resistance.
- Nitrile is not resistant to weathering and ozone.

Impermeability	G
Oil Resistance	E
Ozone Resistance	P
Set Resistance	GE
Tear Resistance	FG
Tensile Strength	GE
Water Resistance	FG
Weather Resistance	F
Abrasion Resistance	G
Acid Resistance	F
Chemical Resistance	FG
Cold Resistance	G
Dynamic Properties	GE
Electrical Properties	F
Flame Resistance	P
Heat Resistance	G

E - Excellent
G - Good
F - Fair
P - Poor

Heat Resistance:

Up to 212° F (100°C) with shorter life at 250°F (121°C).

Cold Flexibility:

Depending on individual compound, between -30°F and -70°F (-34°C and -57°C).

Chemical Resistance:

Aliphatic hydrocarbons (propane, butane, petroleum oil, mineral oil and grease, diesel fuel, fuel oils) vegetable and mineral oils and greases. HFA, HFB and HFC fluids. Dilute acids, alkali and salt solutions at low temperatures. Water (special compounds up to 212°F(100°C))

Not compatible with:

Fuels of high aromatic content (for flex fuels a special compound must be used). Aromatic hydrocarbons (benzene). Chlorinated hydrocarbons (trichlorethylene). Polar solvents (keytone, acetone, acetic acid, ethyleneester). Strong acids. Brake fluid with glycol base. Ozone, weather and atmospheric aging.

Sizes are approximate. Specifications subject to change without notice.



Assortments



- Fuses
- O-rings
- Grease fittings
- Repair kits
- Hardware kits
- Pins



ASSORTMENTS



Assortments



Table of Contents



DynaTrays	186
Metric Grease Fittings, 110 Pieces	187
Grease Fittings Assortments, 70 Pieces.....	187
S.A.E. Grease Fittings Assortments, 100 Pieces.....	187
Hair Pin Assortments, 83 Pieces	188
Mini Plug-In Fuses Assortments, 101 Pieces	188
Standard Plug-In Fuses Assortments, 101 Pieces	188
Metric Socket Set Screws Assortments, 200 Pieces.....	188
Automotive Electric Repair Kit, 285 Pieces	189
Spring Assortments, 200 Pieces	189
O-Ring Assortments, 270 Pieces	190
Cotter Pin Assortments, 560 Pieces	190
Cotter Pin (Large) Assortments, 150 Pieces.....	190
Hair Pin Assortments, 150 Pieces	191
External Retainer Ring Assortments, 300 Pieces	191
Wire Terminals Assortments, 160 Pieces.....	191
Grommet Assortments, 125 Pieces	192
Auto Fuses Assortment, 80 Pieces	192
Wire Connector Assortments, 158 Pieces.....	192
Allen Cap Screw Assortments, 106 Pieces	193
Woodruff Key Assortments, 80 Pieces.....	193
Copper Washer Assortments, 110 Pieces	193
"E" Retainer Ring Assortments, 300 Pieces	193
Rubber Sealing Washer Assortments, 141 Pieces	194
Rivet Assortments, 500 Pieces	194
Fuse Assortments, 92 Pieces	194
DynaKits • Grease Fitting Dynapaks	195
DynaKits	195
Assorted Grease Fittings Dynapaks	195
O-ring Kits	196
O-Ring Flange Kit, 150 Pieces	195
N70 S.A.E. O-Ring Kit, 407 Pieces.....	196
N70 Metric O-Ring Kit, 419 Pieces	196
High Pressure O-Ring Kit, 212 Pieces	196
High Temp V75 O-Ring Kit, 382 Pieces	197
N90 S.A.E. O-Ring Kit, 382 Pieces	197
N70 O-Ring Splicing Kit, 5 Pieces	198
Japanese Metric O-Ring Kit, 380 Pieces	198
N70 Metric O-Ring Kit, 425 Pieces	198



Part# 00108 - Metric Grease Fittings, 110 Pieces

9 popular sizes in a sturdy plastic case.
 Dimensions: 8-1/2" L x 4-1/4" W x 1-1/4" D.
 Contents:

PART#	DESCRIPTION	QTY.	PART#	DESCRIPTION	QTY.
11114	Straight, M6	50	11119	90°, M8	5
11115	45°, M6	10	11120	Straight, M10	10
11116	90°, M6	10	11126	45°, M10	5
11117	Straight, M8	10	11127	90°, M10	5
11118	45°, M8	5			



Part# 10109 - Grease Fittings Assortments, 70 Pieces

9 popular sizes of S.A.E. and Metric grease fittings: 1/8" NPT, 1/4"-28, M6, M8 and M10, both in straight, 45° and 90° types.
 Dimensions: 8-1/2" L x 4-1/4" W x 1-1/4" D.
 Contents:

PART#	DESCRIPTION	QTY.	PART#	DESCRIPTION	QTY.
11100	Straight, 1/8" NPT	10	11109	90°, 1/4"-28	5
11102	45°, 1/8" NPT	5	11114	Straight, M6	10
11104	90°, 1/8" NPT	5	11117	Straight, M8	5
11105	Straight, 1/4"-28	20	11120	Straight, M10	5
11107	45°, 1/4"-28	5			

*NPT - National Pipe Thread Taper



Part# 00112 - S.A.E. Grease Fittings Assortments, 100 Pieces

6 popular sizes in a sturdy plastic case.
 Dimensions: 8-1/2" L x 4-1/4" W x 1-1/4" D.
 Contents:

PART#	DESCRIPTION	QTY.	PART#	DESCRIPTION	QTY.
11100	Straight, 1/8" NPT	20	11105	Straight, 1/4"-28	50
11102	45°, 1/8" NPT	5	11107	45°, 1/4"-28	10
11104	90°, 1/8" NPT	5	11109	90°, 1/4"-28	10

*NPT - National Pipe Thread Taper



Sizes are approximate. Specifications subject to change without notice.





Part# 00113 - Hair Pin Assortments, 83 Pieces

6 popular sizes in a sturdy plastic case.
Dimensions: 10-1/2" L x 4-3/4" W x 1-3/4" D.
Contents:

PART#	DESCRIPTION	QTY.	PART#	DESCRIPTION	QTY.
66301	3/32" x 1-11/16"	25	66305	5/32" x 3-5/16"	15
66302	3/16" x 3-1/4"	10	66306	1/8" x 2-5/8"	20
66304	3/16" x 3-1/4" Long	8	66308	1/4" x 4-1/4"	5



Part# 00119 - Mini Plug-In Fuses Assortments, 101 Pieces

The most popular sizes in a sturdy plastic case. Includes a fuse puller.
Dimensions: 6" L x 3-1/2" W x 1-1/4" D.
Contents:

DESCRIPTION	QTY.	DESCRIPTION	QTY.
2A, 3A, 5A, 7.5A	5 ea.	15A	20
10A, 20A, 25A, 30A	15 ea.	Fuse Puller	1



Part# 00121 Standard Plug-In Fuses Assortments, 101 Pieces

The most popular sizes in a sturdy plastic case. Includes a Fuse Puller.
Dimensions: 6" L x 3-1/2" W x 1-1/4" H.
Contents:

DESCRIPTION	QTY.	DESCRIPTION	QTY.
3A, 5A, 7.5A, 25A	10 ea.	Fuse Puller	1
10A, 15A, 20A, 30A	15 ea.	Fuse Puller	1



Part# 10119 - Metric Socket Set Screws Assortments, 200 Pieces

12 most popular sizes of socket set screws.
Package Dimensions: 8-1/2" L x 4-1/4" W x 1-1/4" D.
Contents:

DESCRIPTION	THREAD	QTY.	DESCRIPTION	THREAD	QTY.
4 x 5 mm	Coarse	10	6 x 6 mm	Coarse	30
8 x 10 mm	Coarse	30	10 x 12 mm	Coarse	10
10 x 10 mm	Coarse	10	6 x 10 mm	Coarse	20
8 x 12 mm	Coarse	20	10 x 10 mm	Fine	10
3 x 5 mm	Coarse	10	8 x 10 mm	Fine	20
5 x 6 mm	Coarse	10	6 x 6 mm	Fine	20

Sizes are approximate. Specifications subject to change without notice.



Part# 00133 - Automotive Electric Repair Kit, 285 Pieces

All the products needed for automotive electrical repairs, conveniently packed in a high impact plastic carry case.

Dimensions: 10-1/4" L x 6-3/4" W x 3" H.

Contents:

DESCRIPTION	SPECIFICATIONS	QTY.
Crimping Tool	8-3/4" length	1
Voltage Tester	6V - 12V - 24V, DC	1
Electrical Tape Roll	10m, UL/CSA approved	1
Primary Wire Roll	1.5m	1
Screwdrivers	Phillips, Flat	2
Rubber Grommets	—	6
Cable Ties	30 of 4", 10 of 6", 10 of 7-1/2"	50
Test Leads	32"	2
Blade Fuses	1 each of 10A, 15A, 20A, 25A, 30A	5
Glass Fuses	1 each of 5A, 15A, 20A; 2 of 10A	5
Cable Clamps	10 of 1/8", 3 of 1/4"	13
Heat Shrink Tubes	6 of 3/16" x 1-1/2", 4 of 1/8" x 1/2"	10
Insulated Terminals	64 Round Rings, 40 Spades, 40 Butts, 27 Wire Connectors, 16 Lugs (M & F)	187
Carrying Case	High impact plastic, translucent lids	1



Part# 10100 - Spring Assortments, 200 Pieces

20 popular sizes of Compression and Expansion Springs.

Dimensions: 8-1/2" L x 4-1/4" W x 1-1/4" D.

Contents:

DESCRIPTION	QTY.	DESCRIPTION	QTY.
Compression, 5/32" x 1/2"	10	Expansion, 3/16" x 1-3/4"	10
Compression, 5/32" x 3/4"	10	Expansion, 5/32" x 1-1/2"	10
Compression, 3/16" x 3/4"	10	Expansion, 5/32" x 2"	10
Compression, 7/32" x 11/16"	10	Expansion, 5/32" x 3-1/2"	10
Compression, 7/32" x 1-1/2"	10	Expansion, 13/64" x 13/16"	10
Compression, 1/4" x 13/32"	10	Expansion, 1/4" x 7/8"	10
Compression, 5/16" x 1-3/4"	10	Expansion, 5/16" x 1-1/8"	10
Compression, 23/64" x 1-3/8"	10	Expansion, 7/32" x 1"	10
Compression, 3/8" x 5/8"	10	Expansion, 11/32" x 1-27/32"	10
Expansion, 3/16" x 1-1/4"	10	Expansion, 11/32" x 1-7/16"	10



Sizes are approximate. Specifications subject to change without notice.





Part# 10101 - O-Ring Assortments, 270 Pieces

18 popular sizes of green HNBR O-Rings for air conditioning applications. Dimensions: 8-1/2" L x 4-1/4" W x 1-1/4" D. Contents:

DESCRIPTION	IND#	QTY.	DESCRIPTION	IND#	QTY.
7/32" I.D. x 1/16" Thick	9	20	9/16" I.D. x 3/32" Thick	113	10
1/4" I.D. x 1/16" Thick	10	20	11/16" I.D. x 1/16" Thick	17	10
9/32" I.D. x 5/64" Thick	--	20	11/16" I.D. x 1/8" Thick	--	10
5/16" I.D. x 1/16" Thick	11	20	8 mm I.D. x 2 mm Thick	54504	20
5/16" I.D. x 5/64" Thick	--	20	10 mm I.D. x 2 mm Thick	54505	10
11/32" I.D. x 5/64" Thick	--	20	11 mm I.D. x 2 mm Thick	--	15
7/16" I.D. x 1/16" Thick	13	15	12 mm I.D. x 2 mm Thick	--	15
7/16" I.D. x 3/32" Thick	111	15	15 mm I.D. x 2 mm Thick	--	10
9/16" I.D. x 1/16" Thick	15	10	17 mm I.D. x 2 mm Thick	--	10

*HNBR - Hydrogenated Nitrile Butadiene Rubber



Part# 10102 - Cotter Pin Assortments, 560 Pieces

The 6 most popular sizes of Cotter Pins, from 1/16" to 5/32" in diameter. Dimensions: 8-1/2" L x 4-1/4" W x 1-1/4" D. Contents:

DESCRIPTION	QTY.	DESCRIPTION	QTY.
1/16" x 1" long	150	1/8" x 1-1/4" long	80
3/32" x 1" long	150	1/8" x 2" long	50
3/32" x 1-1/2" long	100	5/32" x 2-1/2" long	30



Part# 10103 - Cotter Pin (Large) Assortments, 150 Pieces

The 6 most popular sizes of Large Cotter Pins, from 1/8" to 5/16" in diameter. Dimensions: 8-1/2" L x 4-1/4" W x 1-1/4" D. Contents:

DESCRIPTION	QTY.	DESCRIPTION	QTY.
1/8" x 2" long	50	1/4" x 2" long	20
5/32" x 2-1/2" long	30	1/4" x 3" long	20
3/16" x 3" long	20	5/16" x 2-1/2" long	10

Sizes are approximate. Specifications subject to change without notice.



Part# 10105 - Hair Pin Assortments, 150 Pieces

The 6 most popular sizes of Hair Pins, from 3/32" to 5/32" in diameter. Dimensions: 8-1/2" L x 4-1/4" W x 1-1/4" D. Contents:

DESCRIPTION	QTY.	DESCRIPTION	QTY.
3/32" x 1-3/16"	42	3/64" x 1-5/8"	25
5/64" x 1-5/16"	30	9/64" x 1-3/4"	20
5/64" x 1-9/16"	25	5/32" x 2-5/16"	8



Reference Chart Available

See end of catalogue

Part# 10106 - External Retainer Ring Assortments, 300 Pieces

18 popular sizes of Snap Rings, from 1/8" to 1-1/4" in diameter. Dimensions: 8-1/2" L x 4-1/4" W x 1-1/4" D. Contents:

DESCRIPTION	QTY.	DESCRIPTION	QTY.
5/32"	10	9/16"	15
3/16"	15	5/8"	20
1/8"	20	3/4"	25
5/16"	15	13/16"	15
1/4"	25	7/8"	20
3/8"	20	1"	15
7/16"	15	1-1/16"	15
15/32"	15	1-1/8"	10
1/2"	25	1-1/4"	5



Reference Chart Available

See end of catalogue

Part# 10107 - Wire Terminals Assortments, 160 Pieces

The 8 most popular types of wire terminals: Ring, Male, Female, Splice, Spade, Butt, Bullet Male and Bullet Female. Dimensions: 8-1/2" L x 4-1/4" W x 1-1/4" D. Contents:

DESCRIPTION	QTY.	DESCRIPTION	QTY.
Ring Terminals	50	Spade Terminals	10
Male Connectors	5	Butt Connectors	42
Female Disconnectors	5	Bullet Male Connector	20
Quick Splices	8	Bullet Female Disconnectors	20



Sizes are approximate. Specifications subject to change without notice.





Part# 10108 - Grommet Assortments, 125 Pieces

18 popular sizes of solid & hollow grommets, from 1/8" to 1" in diameter.
Dimensions: 8-1/2" L x 4-1/4" W x 1-1/4" D.
Contents:

DESCRIPTION	QTY.	DESCRIPTION	QTY.
1/8" x 9/32"	15	1/2" x 21/32"	4
3/16" x 5/16"	10	5/8" x 1"	3
1/4" x 1/2"	7	3/4" x 15/16"	2
5/16" x 17/32"	3	Solid, 5/16"	20
3/8" x 1/2"	6	Solid, 3/8"	20
3/8" x 9/16"	5	Solid, 1/2"	10
3/8" x 3/4"	3	Solid, 5/8"	5
7/16" x 3/4"	3	Solid, 3/4"	4
7/8"	3	Solid, 1"	2



Part# 10110 - Auto Fuses Assortment, 80 Pieces

Standard and Mini Fuses, from 5 to 30A.
Dimensions 8-1/2" L x 4-1/4" W x 1-1/4"D.
Contents:

DESCRIPTION	QTY.	DESCRIPTION	QTY.
Standard, 5A, Orange	5	Mini, 5A, Orange	5
Standard, 10A, Red	10	Mini, 10A, Red	5
Standard, 15A, Blue	5	Mini, 15A, Blue	5
Standard, 20A, Yellow	10	Mini, 20A, Yellow	10
Standard, 25A, Clear	5	Mini, 25A, Clear	5
Standard, 30A, Green	10	Mini, 30A, Green	5



Part# 10111 - Wire Connector Assortments, 158 Pieces

5 popular sizes of Wire Connectors from 22 to 10 Gauge.
Dimensions: 8-1/2" L x 4-1/4" W x 1-1/4" D.
Contents:

DESCRIPTION	QTY.	DESCRIPTION	QTY.
22 Gauge, Grey	40	14 Gauge, Yellow	18
22 Gauge, Blue	40	10 Gauge, Red	10
16 Gauge, Orange	50		

Sizes are approximate. Specifications subject to change without notice.



Part# 10112 - Allen Cap Screw Assortments, 106 Pieces

9 popular sizes of Allen Cap Screws.
 Dimensions: 8-1/2" L x 4-1/4" W x 1-1/4" D.
 Contents:

DESCRIPTION	QTY.	DESCRIPTION	QTY.
#8 - 32 x 1/12"	25	5/16" - 18 x 1"	5
#10 - 24 x 1/2"	25	5/16" - 18 x 1-1/2"	5
#10 - 24 x 1"	20	3/8" - 16 x 1"	3
1/4" - 20 x 1/2"	10	3/8" - 16 x 1-1/2"	3
1/4" - 20 x 1"	10		



Part# 10113 - Woodruff Key Assortments, 80 Pieces

The 8 most popular sizes of Woodruff Keys.
 Dimensions: 8-1/2" L x 4-1/4" W x 1-1/4" D.
 Contents:

DESCRIPTION	QTY.	DESCRIPTION	QTY.
5/32" x 9/32" x 3/4"	10	1/8" x 1/4" x 5/8"	10
3/16" x 9/32" x 3/4"	10	5/32" x 1/4" x 5/8"	10
1/8" x 3/16" x 1/2"	10	3/16" x 11/32" x 7/8"	10
5/32" x 3/16" x 1/2"	10	1/4" x 11/32" x 7/8"	10



Part# 10114 - Copper Washer Assortments, 110 Pieces

6 popular sizes of Copper Washers, from 1/4" to 5/8" in diameter.
 Dimensions: 8-1/2" L x 4-1/4" W x 1-1/4" D.
 Contents:

DESCRIPTION	QTY.	DESCRIPTION	QTY.
1/4"	30	7/16"	15
5/16"	25	1/2"	10
3/8"	20	5/8"	10



Part# 10104 - "E" Retainer Ring Assortments, 300 Pieces

9 popular sizes of External "E" Retainer Rings from 1/16" to 7/8" in diameter.
 Dimensions: 8-1/2" L x 4-1/4" W x 1-1/4" D.
 Contents:

DESCRIPTION	QTY.	DESCRIPTION	QTY.
1/16"	30	1/2"	40
1/8"	30	5/8"	20
3/16"	40	3/4"	20
1/4"	50	7/8"	20
3/8"	50		



Sizes are approximate. Specifications subject to change without notice.





Part# 10115 - Rubber Sealing Washer Assortments, 141 Pieces

18 popular sizes of Rubber Sealing Washers. Safe for gasoline.
Dimensions: 8-1/2" L x 4-1/4" W x 1-1/4" D.
Contents:

DESCRIPTION	QTY.	DESCRIPTION	QTY.	DESCRIPTION	QTY.
Rubber		Fiber		Kingerit	
1/2" x 16	10	21 x 17	10	1-1/2"-27 x 38	3
3/4" x 15 x 24	10	1/2"	10	1/2"-12 x 18	10
1/2" x 10	5	3/8" x 8	10	1-1/4"-30 x 39	3
3/8" x 8	5	1"	5	3/4"-16 x 24	10
3/4"-11 x 24 x 2	10	3/4"	10		
3/8" x 10	5	3/8"	10		
1/2" x 17	10				
1/2"-9 x 19	5				



Part# 10117 - Rivet Assortments, 500 Pieces

125 pieces each of 1/8" Rivets in 4 popular lengths from 1/4" to 5/8".
Dimensions: 8-1/2" L x 4-1/4" W x 1-1/4" D.
Contents:

DESCRIPTION	QTY.	DESCRIPTION	QTY.
1/8" x 1/4"	125	1/8" x 5/8"	125
1/8" x 3/8"	125	1/8" x 5/16"	125



Part# 10118 - Fuse Assortments, 92 Pieces

15 Standard Fuses in 6 amperages each, plus a fuse puller and a 6-24V tester. Dimensions: 8-1/2" L x 4-1/4" W x 1-1/4" D.
Contents:

DESCRIPTION	QTY.	DESCRIPTION	QTY.
Standard, 5A, Pink	15	Standard, 25A, Clear	15
Standard, 10A, Red	15	Standard, 30A, Green	15
Standard, 15A, Blue	15	Fuse Puller	1
Standard, 20A, Yellow	15	6-24V Tester	1

Sizes are approximate. Specifications subject to change without notice.



DynaKits

Retail assortments of our most popular items with hanging tab and positive locking closures. Made of durable, transparent polypropylene. Dimensions 4-1/4" L x 2-7/8" W x 1-7/16" D.

PART#	CONTENTS	QTY.
00140	Standard Plug-In Fuses	50 pcs. / 5 sizes
00141	Mini Plug-In Fuses	50 pcs. / 5 sizes
00160	Cotter Pins (Small)	215 pcs. / 8 sizes
00161	Cotter Pins (Large)	40 pcs. / 12 sizes
00163	S.A.E. Grease Fittings	40 pcs. / 6 sizes
00164	Hair Pins	28 pcs. / 8 sizes
00173	Spring Pins	62 pcs. / 13 sizes
00174	Woodruff Keys	40 pcs. / 12 sizes
00175	"E" Retainer Rings	70 pcs. / 7 sizes
00176	Internal Retainer Rings	55 pcs. / 11 sizes
00177	External Retainer Rings	70 pcs. / 14 sizes
00178	Clevis Pins	23 pcs. / 14 sizes
00179	S.A.E. O-Rings	95 pcs. / 15 sizes
00180	Keystock	30 pcs. / 5 sizes
00181	Metric Grease Fittings	50 pcs. / 7 sizes
00182	Drive-In Grease Fittings	50 pcs. / 4 sizes
00189	Universal Clevis Pins	11 pcs. / 9 sizes



00140



00179



00180

Assorted Grease Fittings Dynapaks

The most popular sizes and types, in a convenient retail package. Dimensions: 3-3/8" L x 1-3/4" W x 7/8"D.

PART#	CONTENTS	QTY.
11135A	S.A.E. Grease Fittings	10 pcs. / 5 sizes
11136A	Metric Grease Fittings	10 pcs. / 6 sizes



11136A

11135A

Part# 00157 - O-Ring Flange Kit, 150 Pieces

8 sizes of Buna-N 90 durometer O-Ring Seals in a transparent plastic box with dividers and hanging tab. Dimensions: 9" L x 4-3/4" W x 1" H.

Contents:

IND#	QTY.	IND#	QTY.
011	25	018	20
012	25	021	15
014	25	025	10
016	20	029	10



Sizes are approximate. Specifications subject to change without notice.



Assortments

O-ring Kits



Assortments



Reference Chart Available
See end of catalogue

Part# 00150 - N70 S.A.E. O-Ring Kit, 407 Pieces

32 sizes of Buna-N 70 durometer O-Rings in a plastic box with thickness gauge.
Dimensions: 9-3/4" L x 6-1/2" W x 1-3/4" H. Contents:

PART#	IND#	QTY.	LOC.	PART#	IND#	QTY.	LOC.	PART#	IND#	QTY.	LOC.
54006	6	20	R-01	54115	115	13	R-12	54217	217	10	R-23
54008	8	20	R-02	54116	116	13	R-13	54218	218	10	R-24
54010	10	20	R-03	54117	117	13	R-14	54219	219	10	R-25
54011	11	20	R-04	54118	118	13	R-15	54220	220	10	R-26
54012	12	20	R-05	54210	210	10	R-16	54221	221	10	R-27
54014	14	20	R-06	54211	211	10	R-17	54222	222	10	R-28
54110	110	13	R-07	54212	212	10	R-18	54223	223	10	R-29
54111	111	13	R-08	54213	213	10	R-19	54224	224	10	R-30
54112	112	13	R-09	54214	214	10	R-20	54225	225	10	R-31
54113	113	13	R-10	54215	215	10	R-21	54226	226	10	R-32
54114	114	13	R-11	54216	216	10	R-22				

Part# 00151 - N70 Metric O-Ring Kit, 419 Pieces

32 sizes of Buna-N 70 durometer Metric O-Rings in a lockable plastic box.
Dimensions: 9-3/4" L x 6-1/2" W x 1-3/4" H". Contents:



Reference Chart Available
See end of catalogue

PART#	I.D. (MM)	QTY.	LOC.	PART#	I.D. (MM)	QTY.	LOC.	PART#	I.D. (MM)	QTY.	LOC.
54501	3	20	R-01	54512	19	14	R-12	54523	30	10	R-23
54502	5	20	R-02	54513	20	13	R-13	54524	31	10	R-24
54503	6	18	R-03	54514	21	14	R-14	54525	32	10	R-25
54504	8	23	R-04	54515	22	13	R-15	54526	34	10	R-26
54505	10	23	R-05	54516	18	10	R-16	54527	36	10	R-27
54506	13	23	R-06	54517	20	10	R-17	54528	38	10	R-28
54507	10	14	R-07	54518	22	10	R-18	54529	41	10	R-29
54508	12	13	R-08	54519	23	10	R-19	54530	44	10	R-30
54509	14	14	R-09	54520	25	10	R-20	54531	46	10	R-31
54510	15	13	R-10	54521	27	10	R-21	54532	50	10	R-32
54511	16	14	R-11	54522	28	10	R-22				

Part# 00152 - High Pressure O-Ring Kit, 212 Pieces

20 sizes of Buna-N 90 durometer O-Rings (Nitrile Durometer A) in a plastic box.
Dimensions: 9" L x 6-1/2" W x 1-3/4" H". Contents:



Reference Chart Available
See end of catalogue

PART#	I.D. (MM)	QTY.	LOC.	PART#	I.D. (MM)	QTY.	LOC.	PART#	I.D. (MM)	QTY.	LOC.
54901	0.185	10	901	54910	0.755	12	910	54912	0.924	10	912
54902	0.239	10	902	54911	0.863	10	911	54913	0.986	10	913
54903	0.301	10	903	54912	0.924	10	912	54914	1.047	10	914
54904	0.351	10	904	54913	0.986	10	913	54916	1.171	10	916
54905	0.414	12	905	54914	1.047	10	914	54918	1.355	10	918
54906	0.468	12	906	54908	0.644	12	908	54920	1.475	10	920
54907	0.530	12	907	54909	0.706	12	909	54924	1.720	10	924
54908	0.644	12	908	54910	0.755	12	910	54928	2.090	10	928
54909	0.706	12	909	54911	0.863	10	911	54932	2.337	10	932

LOC. = LOCATION

Sizes are approximate. Specifications subject to change without notice.



Part# 00153 - High Temp V75 O-Ring Kit, 382 Pieces

30 sizes of Viton 75 O-Rings, High Temp: -25°C to 200°C. In a plastic box with thickness gauge. Dimensions: 9-3/4" L x 6-1/2" W x 1-3/4" H. Contents:

O.D.	I.D.	QTY.	LOCATION	O.D.	I.D.	QTY.	LOCATION
1/4"	1/8"	20	6	3/4"	9/16"	13	113
9/32"	5/32"	20	7	3/16"	5/8"	13	114
5/16"	3/16"	20	8	7/8"	11/16"	13	115
11/32"	7/32"	20	9	15/16"	3/4"	13	116
3/8"	1/4"	20	10	1"	3/4"	10	210
7/16"	5/16"	20	11	1-1/16"	13/16"	10	211
1/2"	3/8"	20	12	1-1/8"	7/8"	10	212
9/16"	3/8"	13	110	1-3/16"	15/16"	10	213
5/8"	7/16"	13	111	1-1/4"	1"	10	214
11/16"	1/2"	13	112	15/16"	11/16"	10	215
3/4"	9/16"	13	113	1-3/8"	1-1/8"	10	216
3/16"	5/8"	13	114	1-9/16"	1-3/16"	10	217
7/8"	11/16"	13	115	1-1/2"	1-1/4"	10	218
15/16"	3/4"	13	116	1-3/16"	15/16"	10	219
1"	3/4"	10	210	1-5/8"	1-3/8"	10	220
1-1/16"	13/16"	10	211	1-1/2"	1-1/16"	10	221
1-1/8"	7/8"	10	212	1-3/4"	1-1/2"	10	222
1-3/16"	15/16"	10	213	1-7/8"	1-1/2"	7	325
1-1/4"	1"	10	214	2"	1-5/8"	7	326
15/16"	11/16"	10	215	2-1/8"	1-3/4"	7	327

**Part# 00154 - N90 S.A.E. O-Ring Kit, 382 Pieces**

30 sizes of Buna-N 90 durometer O-Rings in a plastic box with thickness gauge. Dimensions: 9-3/4" L x 6-1/2" W x 1-3/4" H. Contents:

O.D.	I.D.	QTY.	LOCATION	O.D.	I.D.	QTY.	LOCATION
1/4"	1/8"	20	6	1-1/16"	13/16"	10	211
9/32"	5/32"	20	7	1-1/8"	7/8"	10	212
5/16"	3/16"	20	8	1-3/16"	15/16"	10	213
11/32"	7/32"	20	9	1-1/4"	1"	10	214
3/8"	1/4"	20	10	15/16"	11/16"	10	215
7/16"	5/16"	20	11	1-3/8"	1-1/8"	10	216
1/2"	3/8"	20	12	1-9/16"	1-3/16"	10	217
9/16"	3/8"	13	110	1-1/2"	1-1/4"	10	218
5/8"	7/16"	13	111	1-3/16"	15/16"	10	219
11/16"	1/2"	13	112	1-5/8"	1-3/8"	10	220
3/4"	9/16"	13	113	1-1/2"	1-1/16"	10	221
3/16"	5/8"	13	114	1-3/4"	1-1/2"	10	222
7/8"	11/16"	13	115	1-7/8"	1-1/2"	7	325
15/16"	3/4"	13	116	2"	1-5/8"	7	326
1"	3/4"	10	210	2-1/8"	1-3/4"	7	327



Buna-N Rubber is also referred to as Nitrile Rubber. Nitrile rubber is a copolymer of butadiene and acrylonitrile. In addition to its excellent elastomeric properties, it is resistant to oil, caustics, and aliphatic hydrocarbons. Nitrile is not suitable for solvents and chlorinated hydrocarbons. Its maximum temperature limit is 212°F.

Viton is a brand of synthetic rubber and fluoropolymer elastomer commonly used in O-rings and other molded or extruded goods. Viton fluoroelastomers are categorized under the ASTM D1418 and ISO 1629 designation of FKM. This class of elastomers is a family comprising copolymers of hexafluoropropylene (HFP) and vinylidene fluoride (VDF or VF2), terpolymers of tetrafluoroethylene (TFE), vinylidene fluoride (VDF) and hexafluoropropylene (HFP) as well as perfluoromethylvinylether (PMVE) containing specialties. The fluorine content of the most common Viton grades varies between 66 and 70%.

Sizes are approximate. Specifications subject to change without notice.





Part# 00155 - N70 O-Ring Splicing Kit, 5 Pieces

5 sizes of Buna-N 70 durometer O-Rings. Cords and all the tools required to produce a perfect O-Ring, in a lockable plastic box. Dimensions: 10-1/2" L x 4-3/4" W x 1-3/4" H. Contents:

DESCRIPTION	LENGTH	DESCRIPTION	LENGTH
1/16" O-Ring Cord	3 ft.	9/32" O-Ring Cord	3 ft.
3/32" O-Ring Cord	3 ft.	Splicing/ Cutting Tool	1
1/8" O-Ring Cord	3 ft.	Cyanocrylate Super Glue, 2g	1
7/32" O-Ring Cord	3 ft.	Razor blade	1

Part# 00156 - Japanese Metric O-Ring Kit, 380 Pieces

36 sizes of Buna-N 70 durometer JIS-2401* Metric O-Rings in a plastic box. Dimensions: 7-3/4" L x 5-1/2" W x 1-3/4" H. Contents:



IND#	SIZE	QTY.	IND#	SIZE	QTY.	IND#	SIZE	QTY.
P3	2.8x1.9	25	P12.5	12.3x2.4	12	P24	23.7x3.5	7
P4	3.8x1.9	20	P14	13.8x2.4	12	V24	23.5x4	6
P5	4.8x1.9	20	P15	14.8x2.4	12	P25	24.7x3.5	7
P6	5.8x1.9	20	P16	15.8x2.4	12	P25.5	25.2x3.5	7
P7	6.8x1.9	15	V15	14.5x4	4	P26	25.7x3.5	7
P8	7.8x1.9	15	P18	17.8x2.4	8	P28	27.7x3.5	7
P9	8.8x1.9	15	P20	19.8x2.4	8	G30	29.4x3.1	7
P10	9.8x1.9	15	P21	20.8x2.4	8	P29	28.7x3.5	6
P10A	9.8x2.4	15	P22	21.8x2.4	8	P29.5	29.2x3.5	6
P11	10.8x2.4	15	P22A	21.7x3.5	5	P30	29.7x3.5	6
P11.2	11x2.4	15	P22.4	22.1x3.5	5	P31	30.7x3.5	6
P12	11.8x2.4	12	G25	24.4x3.1	6	P31.5	31.2x3.5	6

* Japanese Industrial Standard (JIS) 2401 "O-rings." The classification system recommended by this standard is twofold, by material and by size and use.

Part# 00158 - N70 Metric O-Ring Kit, 425 Pieces

30 sizes of Buna-N 70 durometer Metric O-Rings in a plastic box with dividers and transparent lid. Dimensions: 11-1/4" L x 8-3/4" W x 1-3/4" H. Contents:



SIZE	QTY.	SIZE	QTY.	SIZE	QTY.
3.0 x 1.5	20	6.3 x 2.4	15	10.0 x 3.0	10
5.0 x 1.5	20	8.3 x 2.4	15	12.0 x 3.0	10
7.0 x 1.5	20	11.3 x 2.4	15	14.0 x 3.0	10
9.0 x 1.5	20	13.3 x 2.4	15	16.0 x 3.0	10
11.0 x 1.5	20	17.7 x 2.4	15	18.0 x 3.0	10
6.0 x 2.0	20	5.0 x 2.5	15	20.2 x 3.0	5
8.0 x 2.0	20	7.0 x 2.5	15	22.2 x 3.0	5
10.0 x 2.0	20	10.0 x 2.5	15	24.2 x 3.0	5
12.0 x 2.0	20	12.0 x 2.5	15	26.2 x 3.0	5
14.0 x 2.0	20	15.0 x 2.5	15	30.2 x 3.0	5

Sizes are approximate. Specifications subject to change without notice.

Cargo Control



- Cargo winches
- Winch bars
- Cargo bars
- Cargo nets
- Winch straps
- Bungee cords
- Hand winches
- Tie downs
- Ratchet straps
- Mud flaps
- Cargo control acc.
- Rubber straps

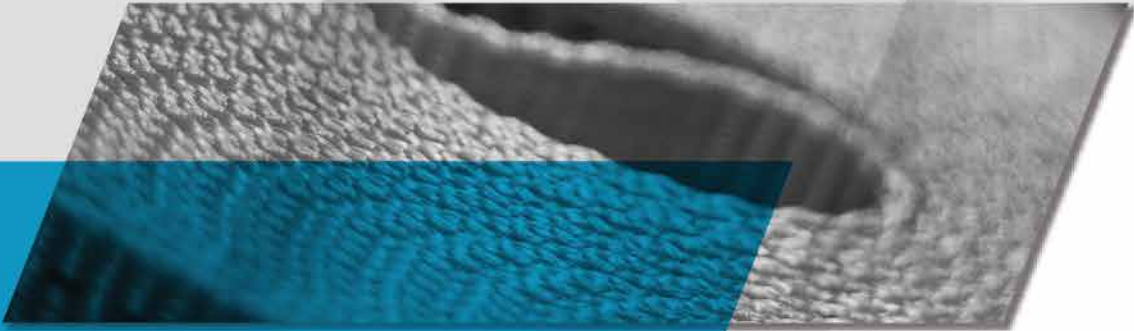

CARGO CONTROL



Table of Contents

Bungee Cords • Cargo Nets	201
Bungee Cord Reels	201
Bungee Cord Hooks	201
Cargo Nets	201
Tarp Straps • Hooks.....	202
Thermoplastic Tarp Straps	201
EPDM Rubber Tarp Straps	202
Tarp Strap Replacement Hook	202
Cam Straps • Ratchet Straps.....	203
Cam Straps	203
Ratchet Straps with S-Hooks (Vinyl-Coated).....	203
Ratchet Straps with Flat Hooks	203
Ratchet Straps • Tie Downs.....	204
Ratchet Straps - Double "J" Hooks.....	204
Ratchet Straps with S-Hooks - Twin Packs	204
Ratchet Straps with S-Hooks - Four Packs	204
Retractable Tie Downs with Hooks	204
Ratchet Straps - Bulk.....	205
Tow Straps	205
Yellow Recovery Straps	205
Recovery Straps • Tow Ropes	206
White Recovery Straps.....	206
Heavy Duty Recovery Straps	206
Tow Ropes	206
Tow Ropes	206
Heavy Duty Tow Ropes	206
Winch Truck Straps.....	207
Winch Truck Straps.....	207
Winch Bars • Winches	207
Winch Bar - Type A.....	207
Winch Bar - Type C.....	207
Cargo Winch - 3 Bar	207
Corner Protectors	207
Corner Protector	207
Hand Winches	208
Hand Winch - Dual Drive	208
Hand Winches - General Purpose	208
Hand Winches - Auto Brake.....	208
Hand Winches - Worm Gear	209
Electric Winches	209
Portable 12V Electric Winch	209
Handles • Winch Repair Kits	210
Replacement Cable Keeper	210
General Purpose Handles	210
General Purpose Repair Kits	210
Auto Brake Repair Kit.....	210
Anchor Points	210
Anchor Points.....	210
Anchor Rings	211
Anchor Rings.....	211
Recessed Anchor Rings.....	211
Heavy Duty Recessed Anchor Rings	211
Standard Recessed Anchor	211
Pop-Up Anchor Point.....	211
Standard Recessed Anchor	211
Load Binders.....	212
Ratchet Type Load Binders	212
Lever Type Load Binders	212
Load Tighteners.....	212
Load Binder Locks.....	212
Cable Type Load Binder Locks	212
Folding Handle Load Binders & Racks.....	213
Fold-Over Handle Load Binders	213
Locking Ratchet Racks.....	213



Bungee Cord Reels

Industrial quality, black polyester sheath with rubber core in a plastic reel.

PART#	DIAMETER	CORD LENGTH	LOAD RATED
11176	1/4"	216' (65.8 m)	55-66 lb
11177	5/16"	216' (65.8 m)	66-77 lb
11178	3/8"	200' (61 m)	77-88 lb



Bungee Cord Hooks

Fits 1/4", 5/16" and 3/8" Bungee Cords.

PART#	DESCRIPTION
11174	Fits 1/4", 5/16" and 3/8" Bungee Cords. Vinyl-coated wire hook. Wire diameter 4 mm. 10 per pkg.



Cargo Nets

Keeps smaller items stationary while driving. Elastic cords & plastic hooks.

PART#	SIZE	PKG. QTY.
12300	15" x 15"	1 ea.
12302	36" x 48"	1 ea.
12303	72" x 96" (Pick-Up)	1 ea.

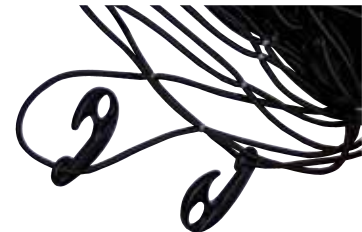

Thermoplastic Tarp Straps

These brand new Heavy Duty tarp straps are made from thermoplastic rubber and supplied with two crimped zinc plated S-hooks. More Load Capacity.

PART#	LENGTH	CAPACITY	HOOKS	PKG. QTY.
11295	Heavy Duty 9"	90 lb	S Hooks	10/pkg.
11296	Heavy Duty 15"	90 lb	S Hooks	10/pkg.
11297	Heavy Duty 21"	90 lb	S Hooks	10/pkg.
11298	Heavy Duty 31"	90 lb	S Hooks	10/pkg.



Sizes are approximate. Specifications subject to change without notice.





11191-11194



11299

EPDM Rubber Tarp Straps

100% EPDM. (See chart below.) Recommended for commercial and industrial applications. Supplied with two zinc plated S-hooks assembled.

PART#	LENGTH	CAPACITY	QTY.
11191	9"	50 lb	10/pkg.
11192	15"	50 lb	10/pkg.
11193	21"	50 lb	10/pkg.
11194	31"	50 lb	10/pkg.
11299	31" adjustable	50 lb	10/pkg.

EPDM (Ethylene Propylene, EPM)

EPM is a copolymer of ethylene and propylene. Ethylene-propylene-diene rubber (EPDM) is produced using a third monomer and is particularly useful when sealing phosphate-ester hydraulic fluids and in brake systems that use fluids having a glycol base.

Heat Resistance:

- ▶ Up to 300° F (149°C) (max. 400° F (204°C) in water and/or steam).

Cold Flexibility:

- ▶ Down to approximately -70°F (-57°C).

Chemical Resistance:

- ▶ Hot water and steam up to 300° F (149°C) with special compounds up to 400° F (204°C).
- ▶ Glycol based brake fluids up to 300° F (149°C).
- ▶ Many organic and inorganic acids.
- ▶ Cleaning agents, soda and potassium alkalis.
- ▶ Phosphate-ester based hydraulic fluids (HFD-R).
- ▶ Silicone oil and grease.
- ▶ Many polar solvents (alcohols, ketones, esters).
- ▶ Ozone, aging and weather resistant.

Not compatible with:

- ▶ Mineral oil products (oils, greases and fuels).

Property

EPDM

Abraision Resistance	GE
Acid Resistance	G
Chemical Resistance	E
Cold Resistance	GE
Dynamic Properties	GE
Electrical Properties	G
Flame Resistance	P
Heat Resistance	E
Impermeability	G
Oil Resistance	P
Ozone Resistance	E
Set Resistance	GE
Tear Resistance	GE
Tensile Strength	GE
Water Resistance	E
Weather Resistance	E

E - Excellent F - Fair
G - Good P - Poor



Reference Chart Available

See end of catalogue

Tarp Strap Replacement Hook

Industrial quality, black polyester sheath with rubber core in a plastic reel.

PART#	DESCRIPTION	QTY.
66241	3/16" clear zinc-plated S-Hook	10/pkg.
66241B	Bulk Pack	500/box

Sizes are approximate. Specifications subject to change without notice.



Cam Straps

Designed for quick and easy operation. High quality, weather-resistant webbing with secure stitching. Vinyl-coated, heat-treated steel hooks.

- Die cast cam buckle.
- One piece per clamshell package.

PART#	SIZE	W.L.L.	U.L.L.	COLOUR	WEBBING
11182	1" x 6'	400 lb	1,200 lb	Blue	Polyester
11185	1" x 10'	400 lb	1,200 lb	Blue	Polyester



Cam Strap Four Packs

Four Cam Straps in a clamshell package.

PART#	SIZE	W.L.L.	U.L.L.	COLOUR	WEBBING
12331	1" x 6'	250 lb	750 lb	Red	Polyester
12332	1" x 6'	250 lb	750 lb	Black	Polyester



Ratchet Straps with S-Hooks (Vinyl-Coated)

Designed for quick and easy operation. High quality, weather-resistant webbing with secure stitching and steel ratchet.

- High Carbon Steel Ratchet.
- One piece per retail package.

PART#	SIZE	W.L.L.	U.L.L.	COLOUR	WEBBING
11183	1" x 15'	400 lb	1,200 lb	Blue	Polyester
12206	1" x 15'	166 lb	500 lb	Red	Polypropylene
12207	1" x 15'	166 lb	500 lb	Black	Polypropylene
11184	1" x 20'	1,000 lb	3,000 lb	Yellow	Polyester



Ratchet Straps with Flat Hooks

PART#	SIZE	W.L.L.	U.L.L.	COLOUR	WEBBING
12353	2" x 20'	3,300 lb	10,000 lb	Yellow	Polyester
12354	2" x 25'	3,300 lb	10,000 lb	Yellow	Polyester
12344	2" x 30'	3,300 lb	10,000 lb	Yellow	Polyester

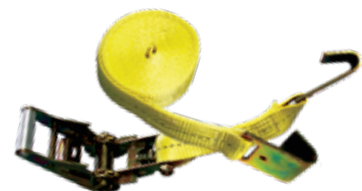

Sizes are approximate. Specifications subject to change without notice.



Cargo Control

Ratchet Straps • Tie Downs



Cargo Control



Ratchet Straps - Double "J" Hooks

PART#	SIZE	W.L.L.	U.L.L.	COLOUR	WEBBING
11189	1" x 15'	600 lb	1,800 lb	Blue	Polyester
12340	1" x 15'	1,000 lb	3,000 lb	Yellow	Polyester
11187	1" x 20'	1,000 lb	3,000 lb	Yellow	Polyester
12341	2" x 15'	1,300 lb	4,000 lb	Yellow	Polyester
12342	2" x 25'	1,300 lb	4,000 lb	Yellow	Polyester
12230	1-1/2" x 15'	2,200 lb	6,600 lb	Yellow	Polyester
11186	1-1/2" x 25'	2,200 lb	6,600 lb	Yellow	Polyester
11190	2" x 27'	3,300 lb	10,000 lb	Yellow	Polyester
12343	2" x 30'	3,300 lb	10,000 lb	Yellow	Polyester
12346	2" x 20'	3,300 lb	10,000 lb	Yellow	Polyester



Ratchet Straps with S-Hooks - Twin Packs

Two medium duty Ratchet Straps in a clamshell package. Vinyl-coated, heat-treated steel hooks.

PART#	SIZE	W.L.L.	U.L.L.	COLOUR	WEBBING
12226	1" x 6'	400 lb	1,200 lb	Black	Polyester



Ratchet Straps with S-Hooks - Four Packs

Four medium duty Ratchet Straps in a clamshell package. Vinyl-coated, heat-treated steel hooks.

PART#	SIZE	W.L.L.	U.L.L.	COLOUR	WEBBING
12320	1" x 15'	400 lb	1,200 lb	Black	Polyester
12321	1" x 15'	400 lb	1,200 lb	Red	Polyester



Retractable Tie Downs with Hooks

Rubber handle. Bulk-pack polybags. Vinyl-coated, heat-treated steel hooks. No more loose ends!

PART#	SIZE	W.L.L.	U.L.L.	COLOR	HOOK TYPE
12370	1" x 15'	500 lb	1,500 lb	Red	"S", vinyl coated
12371	1" x 15'	500 lb	1,500 lb	Black	Double "J"

Sizes are approximate. Specifications subject to change without notice.



Ratchet Straps - Bulk

High quality polyester webbing, secure stitching, steel ratchet, heat treated steel hooks, EZ Release ratchet buckle with caps. Individually shrink wrapped.

PART#	SIZE	W.L.L.	U.L.L.	COLOR	WEBBING & HARDWARE MARKINGS	HOOK TYPE
11183B	1" x 15'	400 lb	1,200 lb	Blue	Yes	"S", vinyl coated
11187B	1" x 20'	1,000 lb	3,000 lb	Yellow	Yes	Double "J"
11189B	1" x 15'	600 lb	1,800 lb	Blue	No	Double "J"
11190B	2" x 27'	3,300 lb	10,000 lb	Yellow	Yes	Double "J"
12343B	2" x 30'	3,300 lb	10,000 lb	Yellow	Yes	Double "J"
12344B	2" x 30'	3,300 lb	10,000 lb	Yellow	Yes	Flat Hook
12229B	1" x 6'	3,300 lb	10,000 lb	Yellow	Yes	Flat Hook
12353B	2" x 20'	3,300 lb	10,000 lb	Yellow	Yes	Flat Hook
12354B	2" x 25'	3,300 lb	10,000 lb	Yellow	Yes	Flat Hook



Tow Straps

Heavy duty yellow nylon webbing. Steel hook with safety latches.

PART#	SIZE	TOWING CAPACITY
11197	2" x 15'	5,000 lb
12297	2" x 15'	8,500 lb



Yellow Recovery Straps

Heavy duty yellow nylon webbing. Loop ends. Reinforced eye.

PART#	SIZE	MAX. VEHICLE WEIGHT	MAX. STRENGTH
12292	6" x 20'	27,500 lb (12,485 kg)	55,000 lb (24,970 kg)



Dynaline offers merchandisers for almost every product. If you are ordering the products above the you may be interested in the following Cargo Control Merchandiser. For more information on this merchandiser see the Merchandising Section at the front of the catalogue.

Cargo Control Plan-0-Gram

PART#	CONTENTS
01052	Cargo Control Backdrop Only , 48" x 48"
01052K	Full Cargo Control Plan-o-gram. Includes 01052 and the most popular products.



Your Trusted Source.



Cargo Control

Recovery Straps • Tow Ropes



White Recovery Straps

White polyester webbing. Reinforced loop ends.

PART#	SIZE	MAX. VEHICLE WEIGHT	MAX. STRENGTH
50915	1" x 15'	3,750 lb (1,703 kg)	7,500 lb (3,504 kg)
50920	2" x 20'	9,000 lb (4,086 kg)	18,000 lb (8,172 kg)
50921	3" x 20'	13,500 lb (6,129 kg)	27,000 lb (12,258 kg)
50922	4" x 20'	17,500 lb (7,945 kg)	35,000 lb (15,890 kg)
50930	4" x 30'	17,500 lb (7,945 kg)	35,000 lb (15,890 kg)



Heavy Duty Recovery Straps

Heavy duty, 2 ply, weather resistant polyester, with reinforced loop ends. Load Capacity imprinted on webbing.

PART#	SIZE	MAX. VEHICLE WEIGHT	MAX. STRENGTH
50935	2" x 20'	18,000 lb (8,165 kg)	36,000 lb (16,329 kg)
50936	4" x 20'	27,000 lb (12,247 kg)	54,000 lb (24,493 kg)
50937	4" x 30'	27,000 lb (12,247 kg)	54,000 lb (24,493 kg)
50938	6" x 20'	40,000 lb (18,144 kg)	80,000 lb (36,287 kg)
50939	6" x 30'	40,000 lb (18,144 kg)	80,000 lb (36,287 kg)



Tow Ropes

20 Feet - White nylon with double end looped connection. Individually banded and shrink wrapped.

PART#	DIAMETER	MAX. VEHICLE WEIGHT	MAX. STRENGTH
12200	3/4"	7,100 lb	14,200 lb
12201	1"	12,500 lb	25,000 lb
12203	1-1/4"	18,750 lb	37,500 lb



Heavy Duty Tow Ropes

30 Feet - Heavy duty tow ropes. Double ended loop connection. 8 white nylon braided strands. Individually packaged.

PART#	DIAMETER	MAX. VEHICLE WEIGHT	MAX. STRENGTH
12208	2-3/8"	56,000 lb	112,000 lb
12209	2-3/4"	75,000 lb	150,000 lb
12210	3-1/8"	97,500 lb	195,000 lb

Sizes are approximate. Specifications subject to change without notice.

Winch Truck Straps

Strong, weather-resistant nylon webbing with secure stitching and a variety of steel hooks. To be used with our Lashing and Cargo Winches. Load Capacity imprinted on webbing.

PART#	SIZE	W.L.L.	MAX. LOAD	COLOR	HOOK TYPE
12242	4" x 30'	5,400 lb	16,200 lb	Yellow	Flat Hook
12243	4" x 30'	5,400 lb	16,200 lb	Yellow	D-Ring
12247	4" x 40'	5,400 lb	16,200 lb	Yellow	D-Ring
12248	4" x 40'	5,400 lb	16,200 lb	Yellow	Flat Hook
12249	4" x 40'	5,400 lb	16,200 lb	Yellow	J-Hook



Winch Bar - Type A

PART#	DESCRIPTION
12245	Features knurled non-slip handle & carbon steel tip. 35" length.



Winch Bar - Type C

PART#	DESCRIPTION
12246	Features knurled handle for safe grip. Hardened, ribbed nose to add strength and prevent slippage. 37" length.



Cargo Winch - 3 Bar

Fits 4" winch straps.

PART#	DESCRIPTION	TYPE	W.L.L.
12284	Standard	Slide On	5,000 lb
12285	Low Profile	Weld-On	5,000 lb



Corner Protector

White plastic corner protector. Individually labeled and wrapped in sealed plastic bag. Accommodates up to 4" straps.

PART#	SIZE	COLOR	BOX QTY
12235	4"	White	90



Sizes are approximate. Specifications subject to change without notice.



Cargo Control

Hand Winches

Hand-cranked manual winches multiply your strength, allowing you to pull a relatively heavy load against gravity.

Larger models have a lower gear ratio to multiply your strength even more.

Winches also have a ratchet to hold the load at any point so it doesn't slide back, allowing a normal person to move a load, using a crank about a foot long and simple gearing.

*** Load Capacity is based on direct line pull on the first layer of line on the drum. Capacity decreases as line builds up on the drum.**

WARNING: WINCHES ARE NOT FOR THE MOVEMENT OF HUMANS OR FOR HOISTING LOADS OVER AREAS OCCUPIED BY HUMANS.



11344

Hand Winch - Dual Drive

Dual drive feature distributes the load evenly on the drum. To be used with steel cable. Winch drums are drilled for use with winch straps.

- Can be mounted vertically or horizontally.
- Solid carbon steel gears.
- Baked enamel painted finish.
- Supplied with grip handle & cable keeper.

PART#	LOAD CAPACITY*	GEAR RATIO
11345	3,700 lb	12 : 1



11300

Hand Winches - General Purpose

- Solid carbon steel gears.
- Embossed frame for added strength.
- Baked black enamel painted finish.
- Supplied with grip handle and cable keeper.
- Two-way Ratchet.

PART#	DESCRIPTION	LOAD CAPACITY*	GEAR RATIO	REPAIR KIT	HANDLE
11300	1-speed	600 lb	3:01	---	---
11301	1-speed	850 lb	3:01	11331	11321
11303	1-speed	1,200 lb	4:01	11333	11323
11304	1-speed	1,400 lb	4:01	11334	11324
11305	2-speed	2,000 lb	4:1 / 10:1	11335	11325
11306	2-speed & hand brake	2,500 lb	5:1 / 12:1	11336	11326



11308

Hand Winches - Auto Brake

Keeps loads automatically locked in position when handle is released. (Note: Minimum load required to activate brake mechanism).

- Baked black enamel painted finish.
- Supplied with grip handle & cable keeper.

PART#	LOAD CAPACITY*	GEAR RATIO	REPAIR KIT	HANDLE
11308	1,400 lb	4:01	11338	11328
11309	2,000 lb	12:1	---	---
11310	2,500 lb	12:1	---	---

Sizes are approximate. Specifications subject to change without notice.

Hand Winches - Worm Gear

Self-braking mechanism prevents loads from accidentally running free. The load remains fixed in position when handle is released.

- Baked enamel painted finish.
- Color box packaging.
- Supplied with cable keeper.

PART#	LOAD CAPACITY*	GEAR RATIO
11312	2,000 lb	41:1



Portable 12V Electric Winch

With 2000 lbs pulling capacity and 16' power cord. 6 Feet per minute loaded line speed. 1/4" Safety slip hook with latch. 8.9" x 4.4" x 1.25"

- Mounting plate
- Manual hand crank
- Wireless remote control

PART#	CABLE DIAMETER	LENGTH	HOOK	MOUNTING PLATE
11350	3/16"	30"	1/4" Safety Slip Hook w/Latch	8.9" x 4.4" x 1.25"

ROLLING CAPACITY	BOAT CAPACITY	PULLING CAPACITY	LOADED LINE SPEED
6,000 lb	5,000 lb	2,000 lb	6'/Minute



Approximate cable lengths based on popular cable diameters.

PART#	DESCRIPTION	1/8"	3/16"	1/4"	5/16"	3/8"
11300	Hand Winch, 600 lb	—	10M/32'	—	—	—
11301	Hand Winch, 800 lb	20M/65'	10M/32'	15M/49'	—	—
11303	Hand Winch, 1200 lb	25M/82'	20M/65'	20M/65'	—	—
11304	Hand Winch, 1400 lb	25M/82'	20M/65'	20M/65'	—	—
11305	Hand Winch, 2000 lb	—	20M/65'	20M/65'	15M/49'	10M/32'
11306	Hand Winch, 2500 lb	—	45M/150'	30M/98'	20M/65'	15M/49'
11308	Auto Brake Winch, 1400 lb	25M/82'	20M/65'	20M/65'	—	—
11309	Auto Brake Winch, 2000 lb	—	45M/150'	30M/98'	20M/65'	15M/49'
11310	Auto Brake Winch, 2500 lb	—	45M/150'	30M/98'	20M/65'	15M/49'
11312	Worm Gear Winch, 2000 lb	—	—	25M/65'	—	—
11345	Hand Winch Dual Drive, 3200 lb	—	45M/150'	30M/98'	20M/65'	15M/49'

Sizes are approximate. Specifications subject to change without notice.



Cargo Control

Handles • Winch Repair Kits • Anchor Points



Replacement Cable Keeper

PART#	DESCRIPTION
11311	Holds steel cable onto winch drum.



General Purpose Handles

PART#	DESCRIPTION	LOAD CAPACITY*	GEAR RATIO	FOR PART#
11321	1-speed	800 lb	3:01	11301
11323	1-speed	1,200 lb	4:01	11303
11324	1-speed	1,400 lb	4:01	11304
11325	2-speed	2,000 lb	4:1 / 10:1	11305
11326	2-speed	2,500 lb	5:1 / 12:1	11306
11328	Auto-Brake	1,400 lb	4:01	11308



General Purpose Repair Kits

PART#	DESCRIPTION	LOAD CAPACITY*	GEAR RATIO	FOR PART#
11331	1-speed	800 lb	3:01	11301
11333	1-speed	1,200 lb	4:01	11303
11334	1-speed	1,400 lb	4:01	11304
11335	2-speed	2,000 lb	4:1 / 10:1	11305
11336	2-speed	2,500 lb	5:1 / 12:1	11306

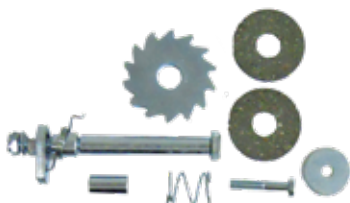

Auto Brake Repair Kit

PART#	DESCRIPTION
11338	Repair kit for Part# 11308



Anchor Points

Fits most full-size and compact light trucks with or without a bed liner. Chrome plated finish.

PART#	DESCRIPTION
11166	Fits most full-size and compact light trucks with or without a bed liner.

*Load capacity is based on direct line pull on the first layer of line on the drum. Capacity decreases as line builds up on the drum. Sizes are approximate. Specifications subject to change without notice.



Anchor Rings

Zinc plated finish.

PART#	LENGTH	WIDTH	CAPACITY	PKG. QTY.
12250	1-1/2"	1"	900 lb	2
12253	2-3/8"	2-3/8"	11,000 lb	1



Recessed Anchor Rings

Surface mount. Zinc plated finish.

PART#	WIDTH	CAPACITY
12251	3-1/2"	1,200 lb



Heavy Duty Recessed Anchor Rings

Surface mount. Zinc plated finish.

PART#	WIDTH	CAPACITY
12252	4-7/16"	5,000 lb



Standard Recessed Anchor

Surface mount. Zinc plated finish.

PART#	WIDTH	CAPACITY
12254	2-3/4"	770 lb



Pop-Up Anchor Point

Surface mount. Zinc plated finish.

PART#	DIAMETER	CAPACITY
12258	4-1/4"	1,200 lb



Standard Recessed Anchor

Surface mount. Chrome plated finish.

PART#	WIDTH	CAPACITY
12259	3-3/8" x 2-1/4"	5,000 lb



Sizes are approximate. Specifications subject to change without notice.



Cargo Control

Load Binders



Ratchet Type Load Binders

Forged steel. Painted finish.

PART#	CHAIN	TAKE UP	W.L.L.	U.L.L.
66196	1/4" – 5/16"	5"	2,600 lb	7,800 lb
66197	5/16" – 3/8"	8"	5,400 lb	19,000 lb
66198	3/8" – 1/2"	8"	9,200 lb	33,000 lb
66199	1/2" – 5/8"	9"	13,000 lb	46,000 lb



Lever Type Load Binders

Forged steel. Painted finish.

PART#	CHAIN	TAKE UP	W.L.L.	U.L.L.
66203	1/4" – 5/16"	3.62	2,600 lb	7,800 lb
66204	5/16" – 3/8"	4.25	5,400 lb	19,000 lb
66202	3/8" – 1/2"	4.25	9,200 lb	33,000 lb



Load Tighteners

Painted finish.

PART#	CHAIN	TAKE UP	HANDLE	W.L.L.	U.L.L.
66200	3/16" – 1/4"	3-3/8"	Dixie Style	375 lb	1,500 lb
66201	3/16" – 1/4"	3-3/8"	Dominion Style	250 lb	1,000 lb



Load Binder Locks

PART#	DESCRIPTION
66205	Eliminates load binder release. Two width adjustments. Orange comes with tabquick pin.
66205-24	Display box. 24 pieces/pkg.
66461	Replacement Pin, 1/4" x 1-3/4".

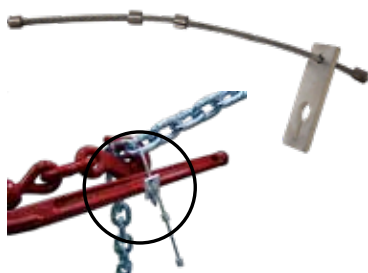

Cable Type Load Binder Locks

Small diameter galvanized cable with aluminum stops and bracket. Lockable with padlock.

PART#	CABLE DIAMETER	LENGTH	PACKAGE QUANTITY
61205	1/8"	10"	400 pieces/carton
62205	3/16"	11"	300 pieces/carton

Sizes are approximate. Specifications subject to change without notice.

Fold-Over Handle Load Binders

Forged folding handle and enclosed ratchet gear casement. Easy operation of finger pull selector allows for ratchet extension, takeup and free spin rapid-ratcheting. Locking feature for long shank locks. WLL and chain grades stamped into handle and hooks.



PART#	CHAIN SIZE G7-G8-G10	TAKE UP	W.L.L.	U.L.L.	WEIGHT
DFX-38	3/8" – 5/16"	8"	8,800 lb	17,600 lb	12.9 lb
DFX-12	1/2" – 3/8"	8"	12,000 lb	24,000 lb	14.6 lb

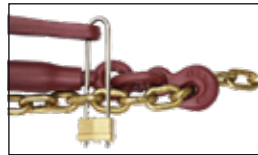

Locking Ratchet Racks

The best solution for ratchet binder storage.

- Available in two sizes: 24" and 48"
- Fast and easy to install
- Includes all hardware for installation
- Fits most ratchet binder sizes
- Laser cut frame for perfect fit
- Two piece construction
- Easy to lockup!
- Made of heavy gauge steel or aluminum
- Can be mounted on trailer bulkheads, trucks, headache boxes, and even in shops and garages.



RRA-L7



RRS-L7



RRA-L11



RRS-L11

PART#	MAX RATCHET HELD	MATERIAL	OVERALL DIMENSIONS	WEIGHT
RRA-L11	11	Aluminum	47.5" x 5.5"	10 lb
RRS-L11	11	Steel	47.5" x 5.5"	19 lb
RRA-L7	7	Aluminum	23.5" x 5.5"	4 lb
RRS-L7	7	Steel	23.5" x 5.5"	10 lb

Sizes are approximate. Specifications subject to change without notice.



Cargo Control

Cargo Control Merchadiser

Dynaline offers merchadisers for almost every product. If you are ordering Cable Pullers and Load Binders then you may be interested in the following Merchadiser. For more information on this merchadiser see the Merchandising Section at the front of the catalogue.

Load Binder/Cable Puller Rack

PART#	CONTENTS
70098	Load Binder Rack Only , 24" wide x 31.8" high x 20.6" deep
70098K	Full Cable Pullers & Load Binder Rack . Includes 24" x 24" Display Board and the most popular products.



Your Trusted Source.

WARNING!

NEVER EXCEED WORKING LOAD LIMITS!

Always inspect load binders prior to use and replace when signs of wear occur.

- Do Not use handle extensions (cheater bars) for tightening.
- Load Binder must not bear against an object while under tension.
- Do Not operate load binders while you or anyone else is standing on the load.
- Always tighten handle in a downward manner, making sure to keep your body clear of moving handle, as it may whip.
- Always secure position of binder by wrapping the loose end of chain around handle.
- Do Not close your hand around handle.

FAILURE TO FOLLOW INSTRUCTIONS CAN RESULT IN SERIOUS INJURY!

Sizes are approximate. Specifications subject to change without notice.



Web: www.dynaline.com

To order call: 1.800.453.3964

Email: mail@dynaline.com

Fax: 780.453.5040



Chain & Rigging



Cable cutters
Cable Sleeves
Chains
Chain hooks
Connectors
Load binders
Shackles
Pulleys
Hooks
Wire rope
Shackles



CHAIN & RIGGING



Chain and Rigging



Table of Contents

Chain	217	Repair Links • Link Locks	226
Transport Chain (Grade 70)	217	Repair Links	226
Grade 30 Proof Coil Chain	217	Link Locks.....	226
Coil Chain (Straight Link)	217	Connecting Links • Quick Links	227
Passing Link Chain	218	“Missing Link” Connecting Links.....	227
Twist Link Machine Chain.....	218	Quick Links - Zinc Plated	227
Double Loop Chain (Tenso Or Lion)	218	Quick Links - Stainless Steel	227
Double Loop Chain	218	D-Rings	227
Sash Chain.....	218	Forged-D-Ring With Weld-On Bracket	227
Furnace Chain	218	Cable • Wire Rope	228
Single Jack Chain	218	Aircraft Cable 7 X 7 Construction	228
Chain Assemblies	219	Aircraft Cable 7 X 19 Construction.....	228
Grade 70 - 5/16” Transport Chain Assemblies	219	Wire Rope Clips	229
Grade 70 -3/8” Transport Chain Assemblies	219	Wire Rope	228
Chain Hooks	220	Malleable Iron Wire Rope Clips	229
Clevis Slip Hooks	220	Forged Steel Wire Rope Clips.....	229
Eye Slip Hooks.....	220	Stainless Steel Wire Rope Clips.....	230
Carbon Clevis Slip Hooks With Latch	220	Thimbles	230
Alloy Clevis Slip Hooks With Latch.....	221	Cable Thimbles.....	230
Clevis Grab Hooks.....	221	Standard Wire Rope Thimbles.....	230
Alloy Clevis Grab Hooks.....	221	Heavy Wire Rope Thimbles	230
Eye Grab Hooks	221	Cable Stops • Cable Sleeves	231
Alloy Clevis Hooks With Latch	222	Cable Stops.....	231
Swivel Eye Hook	222	Cable Sleeves	231
Safety Slip Hooks	222	Cable Cutters • Swagers	232
Safety Winch Hook.....	222	Cable Cutters	232
Eye Hoist Hooks - Carbon Steel (Orange).....	222	Bench Swager.....	232
Chain Hooks & Chain Links	223	Hand Swager.....	232
Eye Hoist Hooks - Alloy Steel (Yellow)	223	Chain Pliers • Tire Chain Hardware	232
Master Links (Grade 80).....	223	Tire Chain Pliers	232
Connecting Links (Grade 80)	223	Tire Chain Hardware	232
Clevis Grab Hooks (Grade 80).....	223		
Clevis Sling Hooks (Grade 80).....	223		
Hooks • Anchor Shackles	224		
Self-Locking Clevis Hooks	224		
Swivel Eye Hoist Hooks	224		
Screw Pin Anchor Shackles	224		
Commercial Grade Anchor Shackles	224		
Anchor Shackles • Mid Links	225		
Stainless Steel Shackles.....	225		
Screw Pin Chain Shackles.....	225		
Bolt Type Anchor Shackles.....	225		
Mid Links	225		
Cold Shuts • Chain Swivels	226		
Cold Shuts	226		
Forged Chain Swivel	226		





Transport Chain (Grade 70)

Alloy steel, Class 7. A high strength, hardened and tempered chain made from alloy steel. For farm and truck load binding applications, towing, construction, and logging. Bright yellow dichromate finish. 4:1 design factor.

- Made to NACM specifications.
- Not to be used in overhead lifting applications.

PART#	CHAIN SIZE	INSIDE LENGTH	INSIDE WIDTH	W.L.L.	WT./100'	PAIL	DRUM
70020	1/4"	1.24"	0.38"	3,150 lb	74 lb	--	800'
70021	5/16"	1.29"	0.44"	4,700 lb	100 lb	--	550'
70022	3/8"	1.38"	0.55"	6,600 lb	145 lb	--	400'
70023	1/2"	1.79"	0.72"	11,300 lb	264 lb	--	200'
70024	1/4"	1.24"	0.38"	3,150 lb	74 lb	130'	--
70025	5/16"	1.29"	0.44"	4,700 lb	100 lb	90'	--
70026	3/8"	1.38"	0.55"	6,600 lb	145 lb	64'	--
70034	1/4"	1.24"	0.38"	3,150 lb	74 lb	65'	--
70035	5/16"	1.29"	0.44"	4,700 lb	100 lb	50'	--
70036	3/8"	1.38"	0.55"	6,600 lb	145 lb	45'	--



Grade 30 Proof Coil Chain

Low carbon steel, Class 3. A durable and economical utility chain manufactured from carbon steel. For pulling stumps, lashing cargo, logging, towing, mooring, pipeline installations, and truck tailgates.

- Zinc plated finish.
- Made to NACM specifications.
- Not to be used in overhead lifting applications.

PART#	CHAIN SIZE	INSIDE LENGTH	INSIDE WIDTH	W.L.L.	WT./100'	PAIL
70003	3/16"	0.98"	0.3"	800 lb	29 lb	250'
70004	1/4"	1.24"	0.38"	1,300 lb	52 lb	141'
70005-A	5/16"	1.29"	0.44"	1,900 lb	86 lb	62'
70005	5/16"	1.29"	0.44"	1,900 lb	86 lb	92'
70006	3/8"	1.38"	0.55"	2,650 lb	124 lb	63'
70007	3/16"	0.98"	0.3"	800 lb	29 lb	100'
70008	1/4"	1.24"	0.38"	1,300 lb	52 lb	65'
70013	3/16"	0.98"	0.3"	800 lb	29 lb	150'
70014	1/4"	1.24"	0.38"	1,300 lb	52 lb	100'
70015	5/16"	1.29"	0.44"	1,900 lb	86 lb	75'
70016	3/8"	1.38"	0.55"	2,650 lb	124 lb	45'



Coil Chain (Straight Link)

Low carbon steel, zinc plated. Used in guard chain applications, animal stakes, and farm implements.

PART#	TRADE SIZE	DIAMETER	INSIDE LENGTH	INSIDE WIDTH	W.L.L.	REEL LENGTH	WEIGHT/100'
70040	#4	0.12"	1.11"	0.21"	205 lb	100'	10 lb



Sizes are approximate. Specifications subject to change without notice. **Not Recommended for overhead lifting.**



Chain and Rigging

Chain



Passing Link Chain

Low carbon steel, zinc plated. General utility chain that resists kinks or knots.

PART#	TRADE SIZE	DIAMETER	INSIDE LENGTH	INSIDE WIDTH	W.L.L.	REEL LENGTH	WEIGHT/100'
70045	#2/0	0.19"	0.88"	0.47"	450 lb	120'	32 lb



Twist Link Machine Chain

Zinc plated. General utility chain that lays flat against a surface. Ideal for tie-down applications.

PART#	TRADE SIZE	DIAMETER	INSIDE LENGTH	INSIDE WIDTH	W.L.L.	REEL LENGTH	WEIGHT/100'
70050	#2/0	0.19"	0.73"	0.28"	520 lb	75'	34 lb
70051	#4	0.12"	0.52"	0.17"	200 lb	100'	13 lb



Double Loop Chain (Tenso Or Lion)

Zinc plated. For animal restraints, swings, door crash stops.

PART#	TRADE SIZE	DIAMETER	INSIDE LENGTH	INSIDE WIDTH	W.L.L.	REEL LENGTH	WEIGHT/100'
70060	#2/0	0.135"	1.82"	0.34"	255 lb	150'	17 lb
70063	#3	0.08"	1.10"	0.187"	90 lb	200'	6 lb



Double Loop Chain

Vinyl covered, blue or green.

PART#	TRADE SIZE	DIAMETER	INSIDE LENGTH	INSIDE WIDTH	W.L.L.	BOX LENGTH	WEIGHT/100'
70062	#2	0.091"	1.33"	0.167"	115 lb	125'	11 lb



Sash Chain

Zinc plated. Specifically designed to operate smoothly over pulleys. Ideal for hanging sash.

PART#	TRADE SIZE	DIAMETER	INSIDE LENGTH	INSIDE WIDTH	W.L.L.	REEL LENGTH	WEIGHT/100'
70075	#35	0.035"	0.57"	--	106 lb	100'	5.7 lb



Furnace Chain

Zinc plated. Light Duty, retainer chain.

PART#	TRADE SIZE	DIAMETER	INSIDE LENGTH	INSIDE WIDTH	W.L.L.	REEL LENGTH	WEIGHT/100'
70080	#1/0	0.022"	0.50"	0.199"	35 lb	250'	2.3 lb



Single Jack Chain

Zinc plated. For animal restraints, swings, door crash stops.

PART#	TRADE SIZE	DIAMETER	INSIDE LENGTH	W.L.L.	REEL LENGTH	WEIGHT/100'
70085	#10T	0.135"	0.093"	43 lb	150'	14 lb
70086	#12	0.105"	0.75"	29 lb	100'	8.5 lb
70087	#14	0.080"	0.63"	16 lb	200'	4.8 lb

Sizes are approximate. Specifications subject to change without notice. **Not Recommended for overhead lifting.**



Grade 70 - 5/16" Transport Chain Assemblies

Assembled with two plated alloy clevis grab hooks. Comes with aluminum capacity tag. Packaged in a plastic pail.

PART#	LENGTH	WLL	ULL
66051	16'	4,700lb	18,800lb
66052	20'	4,700lb	18,800lb



Grade 70 - 3/8" Transport Chain Assemblies

Assembled with two plated alloy clevis grab hooks. Comes with aluminum capacity tag. Packaged in a plastic pail.

PART#	LENGTH	WLL	ULL
66053	16'	6,600lb	26,400lb
66054	20'	6,600lb	26,400lb



Dynaline offers merchandisers for almost every product. If you are ordering the products above then you may be interested in the following Merchandiser. For more information on this merchandiser see the Merchandising Section at the front of the catalogue.

Chain Rack - 4'

PART#	CONTENTS
70099	Chain Rack Only, 47" wide x 73" high x 13" deep
70099K	Full 4' Chain Rack Merchandiser. Includes 12" x 48" Chain Rack Header and the most popular products.

Chain Rack - 2'

PART#	CONTENTS
70010	Chain Rack Only, 23" wide x 73" high x 13" deep
70010K	Full 2' Chain Rack Merchandiser. Includes 9" x 23" Dynaline Distributor sign (00003) and the most popular products.



Your Trusted Source.

Sizes are approximate. Specifications subject to change without notice. **Not Recommended for overhead lifting.**

Chain and Rigging

Chain Hooks



Chain and Rigging

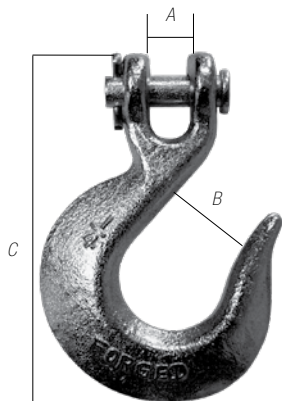

Clevis Slip Hooks

Forged carbon steel. Clear zinc plated finish.
For use with Grade 30 & Grade 40 chains.

PART#	CHAIN DIAMETER	PIN	A	B	C	W.L.L.	U.L.L.
66115	1/4"	3/8"	7/16"	15/16"	4"	1,950 lb	7,800 lb
66116	5/16"	7/16"	1/2"	1-1/16"	4-1/2"	2,875 lb	11,500 lb
66117	3/8"	1/2"	9/16"	1-5/16"	5-3/8"	4,000 lb	16,000 lb
66118	7/16"	9/16"	5/8"	1-9/16"	6"	5,000 lb	20,000 lb
66119	1/2"	5/8"	3/4"	1-11/16"	6-3/4"	6,500 lb	26,000 lb

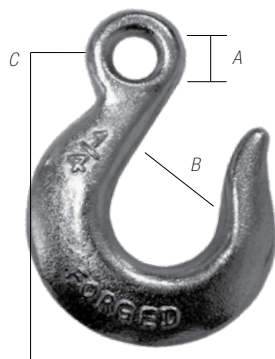

Eye Slip Hooks

Forged carbon steel. Clear zinc plated finish.
For use with Grade 30 & Grade 40 chains.

PART#	CHAIN DIAMETER	A	B	C	W.L.L.	U.L.L.
66129	1/4"	1/2"	15/16"	3-5/8"	1,950 lb	7,800 lb
66130	5/16"	5/8"	1-1/16"	4-3/16"	2,875 lb	11,500 lb
66131	3/8"	11/16"	1-5/16"	4-7/8"	4,000 lb	16,000 lb

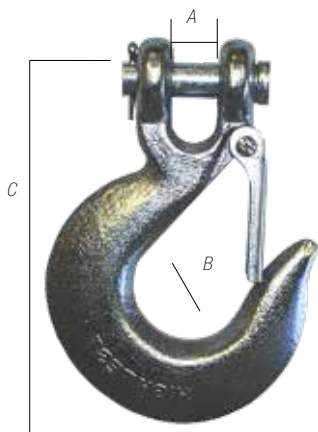

Carbon Clevis Slip Hooks With Latch

Forged carbon steel. Clear zinc plated finish.
For use with Grade 30 & Grade 40 chains.

PART#	CHAIN DIAMETER	PIN	A	B	C	W.L.L.	U.L.L.
66070	1/4"	3/8"	7/16"	15/16"	4"	1,950 lb	7,800 lb
66071	5/16"	3/8"	1/2"	1-1/16"	4-1/2"	2,875 lb	11,000 lb
66072	3/8"	7/16"	5/8"	1-5/8"	5-1/4"	4,000 lb	16,000 lb

Sizes are approximate. Specifications subject to change without notice. **Not Recommended for overhead lifting.**



Alloy Clevis Slip Hooks With Latch

Forged alloy steel. For use with Grade 70 chain.
Yellow zinc dichromate plated finish.

PART#	CHAIN DIAMETER	PIN	A	B	C	W.L.L.	U.L.L.
66073	1/4"	3/8"	7/16"	15/16"	4"	2,750 lb	11,000 lb
66074	5/16"	7/16"	1/2"	1-1/16"	4-1/2"	4,300 lb	17,200 lb
66075	3/8"	7/16"	5/8"	1-5/8"	5-3/16"	5,250 lb	21,000 lb
66076	1/2"	5/8"	3/4"	1-3/4"	6-6/8"	9,000 lb	36,000 lb

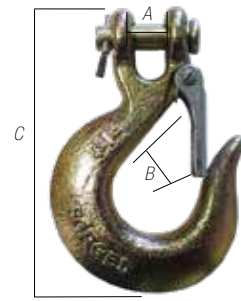

Clevis Grab Hooks

Forged carbon steel. Clear zinc plated finish.
For use with Grade 30 & Grade 40 chain.

PART#	CHAIN DIAMETER	PIN	A	B	C	W.L.L.	U.L.L.
66110	1/4"	3/8"	0.36"	13/32"	3-3/8"	2,600 lb	10,400 lb
66111	5/16"	7/16"	0.40"	7/16"	3-15/16"	3,900 lb	15,600 lb
66112	3/8"	1/2"	0.48"	1/2"	4-1/2"	5,400 lb	21,600 lb
66113	7/16"	9/16"	0.66"	9/16"	5"	7,200 lb	28,800 lb
66114	1/2"	5/8"	0.75"	5/8"	5-3/4"	9,200 lb	36,800 lb

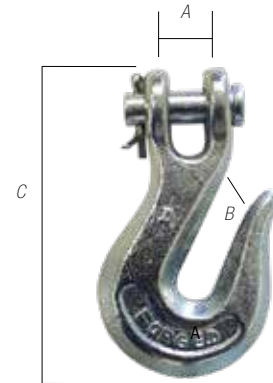

Alloy Clevis Grab Hooks

Forged alloy steel. For use with Grade 70 chain.
Yellow zinc dichromate plated finish.

PART#	CHAIN DIAMETER	PIN	A	B	C	W.L.L.	U.L.L.
66120	1/4"	3/8"	5/16"	13/32"	3-3/8"	3,600 lb	14,400 lb
66121	5/16"	7/16"	3/8"	7/16"	3-15/16"	5,400 lb	21,600 lb
66122	3/8"	15/32"	7/16"	1/2"	4-1/2"	7,500 lb	30,000 lb
66126	7/16"	9/16"	21/32"	9/16"	5"	10,000 lb	40,000 lb
66127	1/2"	5/8"	3/4"	21/32"	5-7/8"	12,750 lb	51,000 lb

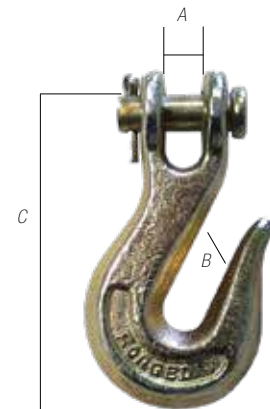

Eye Grab Hooks

Forged carbon steel. Clear zinc plated finish.
For use with Grade 30 chains.

PART#	CHAIN DIAMETER	A	B	C	W.L.L.	U.L.L.
66123	1/4"	1/2"	11/32"	3-1/16"	2,600 lb	10,400 lb
66124	5/16"	9/16"	7/16"	3-9/16"	3,900 lb	15,600 lb
66125	3/8"	13/16"	1/2"	4-1/4"	5,400 lb	21,600 lb

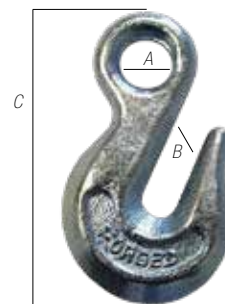

Sizes are approximate. Specifications subject to change without notice. **Not Recommended for overhead lifting.**

Chain and Rigging

Chain Hooks

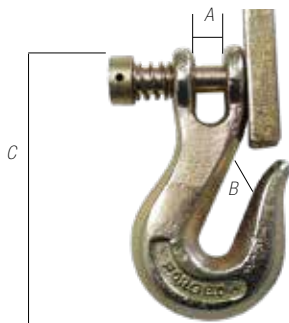

Alloy Clevis Hooks With Latch

Forged alloy steel. For use with Grade 70 chain. Yellow zinc dichromate plated finish.

PART#	CHAIN DIAMETER	A	B	C	W.L.L.	U.L.L.
66080	1/4"	3/8"	3/8"	1-15/16"	3,600 lb	14,400 lb
66081	5/16"	3/8"	7/16"	2-1/4"	5,400 lb	21,000 lb
66082	3/8"	1/2"	1/2"	2-5/8"	7,500 lb	30,000 lb
66083	1/2"	13/16"	11/16"	3-3/16"	12,750 lb	51,000 lb

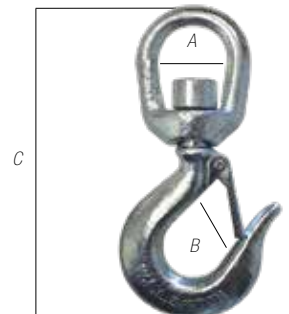

Swivel Eye Hook

Forged carbon steel. Clear zinc plated finish. Not recommended for overhead lifting.

PART#	A	B	C	W.L.L.	U.L.L.
66134	1-1/4"	7/8"	5-9/16"	1,500 lb	7,500 lb

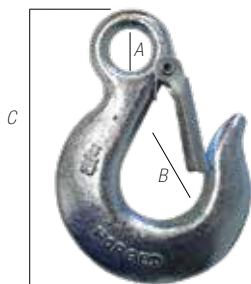

Safety Slip Hooks

Forged carbon steel. Clear zinc plated finish. Not recommended for overhead lifting.

PART#	CHAIN DIAMETER	A	B	C	W.L.L.	U.L.L.
66133	1/4"	1/2"	3/4"	3-5/8"	1,950 lb	7,800 lb
66135	5/16"	5/8"	13/16"	4-3/16"	2,875 lb	11,500 lb

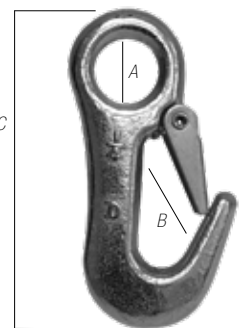

Safety Winch Hook

Forged carbon steel. Clear zinc plated finish. Not recommended for overhead lifting.

PART#	CHAIN DIAMETER	A	B	C	W.L.L.	U.L.L.
66136	1/4"	3/4"	3/4"	3-5/8"	1,500 lb	7,500 lb

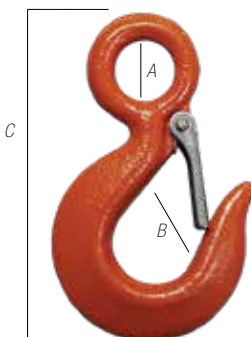

Eye Hoist Hooks - Carbon Steel (Orange)

Complete with latches. Enamel painted finish. 5:1 safety factor.

PART#	A	B	C	W.L.L. (TONS)	U.L.L. (TONS)	LATCH KIT
66145	3/4"	13/16"	4-5/16"	3/4	3-3/4	66151
66146	7/8"	1-1/32"	4-7/8"	1	5	66152
66147	1-1/8"	1-1/16"	5-5/8"	1-1/2	7-1/2	66153
66148	1-1/4"	1-7/32"	6-1/2"	2	10	66154
66149	1-1/2"	1-1/2"	8"	2-1/2	15	66155
66150	2"	1-7/8"	10-1/4"	5	25	66156

Sizes are approximate. Specifications subject to change without notice. **Not Recommended for overhead lifting.**



Eye Hoist Hooks - Alloy Steel (Yellow)

Complete with latches. Enamel painted finish. 5:1 safety factor.

PART#	A	B	C	D	W.L.L. (TONS)	LATCH KIT
67145	5/8"	15/16"	3-7/8"	2-3/4"	3/4	66151
67146	3/4"	1-1/32"	4-3/8"	3-3/16"	1	66152
67147	15/16"	1-1/8"	4-7/8"	3-11/16"	1-1/2	66153
67148	1-1/8"	1-7/32"	5-1/2"	4"	2	66154
67149	1-1/4"	1-3/8"	6-1/2"	4-11/16"	3	66155

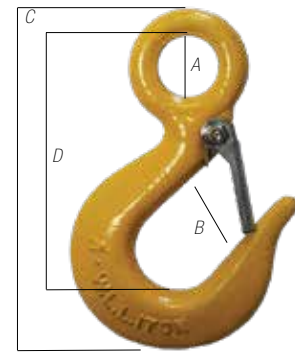

Master Links (Grade 80)

PART#	CHAIN DIAMETER	A	B	C	W.L.L.
67005	1/2"	2-1/2"	5"	6"	7,000 lb
67006	5/8"	3"	6"	7-1/4"	9,000 lb
67007	3/4"	2-3/4"		7"	10,500 lb
67008	1"	3-1/2"	7"	9"	24,350 lb

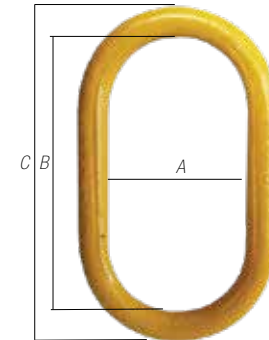

Connecting Links (Grade 80)

PART#	CHAIN DIAMETER	A	B	C	D	W.L.L.
67020	1/4"	3/8"	1-7/8"	1-3/4"	2-1/2"	1.5 T
67021	5/16"	25/64"	2-1/8"	2"	3"	2 T
67022	3/8"	17/32"	2-1/2"	2-1/2"	3-1/2"	3.2 T
67023	1/2"	5/8"	3-7/16"	3-7/32"	4-1/2"	5.4 T

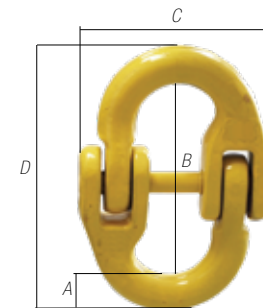

Clevis Grab Hooks (Grade 80)

PART#	CHAIN DIAMETER	A	B	C	W.L.L.
67025	1/4"	3/8"	3/8"	3-11/16"	3,500 lb
67026	3/8"	1/2"	1/2"	5"	7,100 lb
67027	1/2"	5/8"	5/8"	5-13/16"	12,000 lb

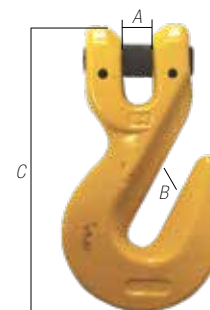

Clevis Sling Hooks (Grade 80)

PART#	CHAIN DIAMETER	A	B	C	W.L.L.	LATCH KIT
67030	1/4"	3/8"	1-3/8"	5-5/16"	3,500 lb	67030-1
67031	3/8"	9/16"	1-11/16"	6-5/16"	6,940 lb	67031-1
67032	1/2"	5/8"	2"	7-5/8"	11,685 lb	67032-1

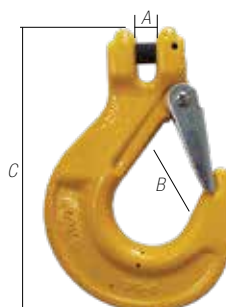

NEVER exceed Working Load Limits! Do not use less than Grade 80 fittings with any application!
Do not use chain or fittings showing signs of wear or deformities!

Sizes are approximate. Specifications subject to change without notice. **Not Recommended for overhead lifting.**

Chain and Rigging

Hooks • Anchor Shackles

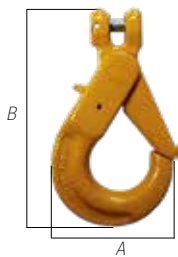

Self-Locking Clevis Hooks

PART#	CHAIN DIAMETER	A	B	W.L.L.	LATCH KIT
67040	9/32"	3-1/2"	6-1/4"	4,500 lb	67040-1
67041	3/8"	4-3/8"	7-1/2"	6,400 lb	67041-1
67042	1/2"	5-7/16"	9-1/2"	10,800 lb	67042-1

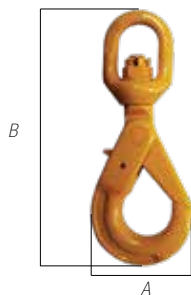

Swivel Eye Hoist Hooks

Design factor 4:1.

PART#	CHAIN DIAMETER	A	B	W.L.L.	LATCH KIT
67050	1/4"	2-3/4"	7"	3,500 lb	67040-1
67051	3/8"	4-3/8"	10-3/4"	7,100 lb	67041-1
67052	1/2"	5-3/8"	12-3/4"	12,000 lb	67042-1

Screw Pin Anchor Shackles

Heat treated alloy forged steel. Oversized alloy pin. Hot dipped galvanized finish. Meets Fed. Spec. RR-C-271D, Type 4A, Class 2, Design factor 6:1. Marked for Traceability: "D" marking for Dynaline.

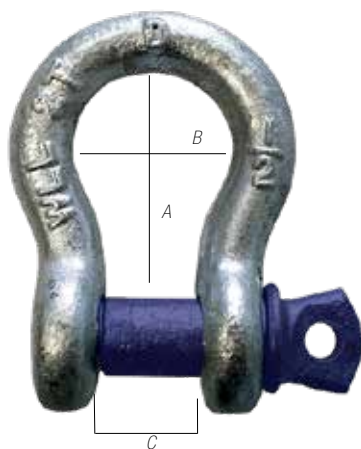

PART#	BODY DIAMETER	PIN DIAMETER	A	B	C	W.L.L. (TONS)
66000	1/4"	5/16"	1-1/8"	3/4"	1/2"	1/2
66001	5/16"	3/8"	1-1/4"	7/8"	1/2"	3/4
66002	3/8"	7/16"	1-7/16"	1"	5/8"	1
66003	7/16"	1/2"	1-11/16"	1-1/8"	3/4"	1-1/2
66004	1/2"	5/8"	1-7/8"	1-5/16"	3/4"	2
66005	5/8"	3/4"	2-3/8"	1-5/8"	1-1/16"	3-1/4
66006	3/4"	7/8"	2-3/4"	2"	1-1/4"	4-3/4
66007	7/8"	1"	3-5/16"	2-1/4"	1-7/16"	6-1/2
66008	1"	1-1/8"	3-3/4"	2-11/16"	1-11/16"	8-1/2
66059	1-1/8"	1-1/4"	4-1/4"	2-5/8"	1-3/4"	9-1/2
66060	1-1/4"	1-3/8"	4-11/16"	3"	2"	12
66061	1-3/8"	1-1/2"	5-1/4"	3-5/8"	2-1/4"	13-1/2
66062	1-1/2"	1-5/8"	5-3/4"	3-7/8"	2-3/8"	17

Commercial Grade Anchor Shackles

Oversized pin. C1010 Carbon Steel, galvanized. For general applications. Design factor 2:1. Not to be used for lifting.

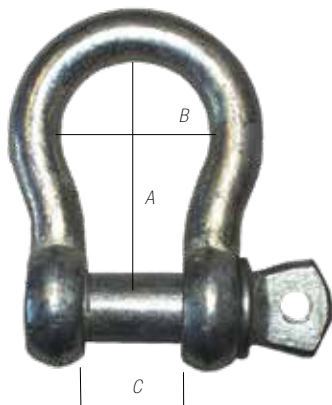

PART#	BODY DIAMETER	PIN DIAMETER	A	B	C	W.L.L.
66010	1/4"	5/16"	1-1/8"	3/4"	1/2"	600 lb
66011	5/16"	3/8"	1-7/32"	13/16"	17/32"	1/2 Ton
66012	3/8"	7/16"	1-7/16"	15/16"	1-7/16"	3/4 Tons
66013	1/2"	5/8"	1-7/8"	1-5/16"	13/16"	1-1/2 Tons
66014	5/8"	3/4"	2-3/8"	1-11/16"	1-1/16"	2-1/4 Tons
66017	7/16"	1/2"	1-11/16"	1-5/32"	11/16"	1-1/4 Tons

Sizes are approximate. Specifications subject to change without notice. **Not Recommended for overhead lifting.**



Chain and Rigging



Stainless Steel Shackles

A151 316 Stainless steel.

PART#	BODY DIAMETER	PIN DIAMETER	A	B	C	W.L.L.
64060	3/16"	1/4"	7/8"	11/16"	3/8"	300 lb
64061	1/4"	5/16"	1-1/8"	3/4"	1/2"	450 lb
64062	5/16"	13/32"	1-3/16"	13/16"	19/32"	650 lb
64063	3/8"	1/2"	1-3/8"	1"	11/16"	1,000 lb

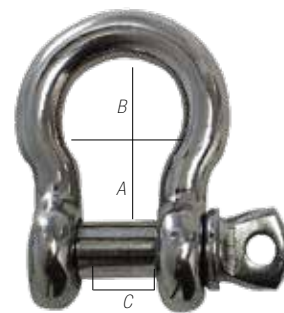

Screw Pin Chain Shackles

High-tensile forged steel. Oversized pin. Hot dipped galvanized finish. Meets Fed. Spec. RR-C-271D, Type 4B, Class 2. Design factor 6:1.

PART#	BODY DIAMETER	PIN DIAMETER	A	B	W.L.L. (TONS)
66020	1/4"	5/16"	7/8"	7/16"	1/2
66021	5/16"	3/8"	1"	9/16"	3/4
66022	3/8"	7/16"	1-1/4"	5/8"	1
66023	7/16"	1/2"	1-7/16"	11/16"	1-1/2
66024	1/2"	5/8"	1-5/8"	3/4"	2



Bolt Type Anchor Shackles

High-tensile forged steel. Oversized pin. Hot dipped galvanized finish. Meets Fed. Spec. RR-C-271D, Type 4A, Class 3. Design factor 6:1.

PART#	BODY DIAMETER	PIN DIAMETER	A	B	C	W.L.L. (TONS)
66900	1/4"	5/16"	1-1/8"	3/4"	1/2"	1/2
66901	5/16"	3/8"	1-1/4"	7/8"	1/2"	3/4
66902	3/8"	7/16"	1-7/16"	1"	5/8"	1
66903	7/16"	1/2"	1-11/16"	1-1/8"	3/4"	1-1/2
66904	1/2"	5/8"	1-7/8"	1-5/16"	3/4"	2
66905	5/8"	3/4"	2-3/8"	1-5/8"	1-1/16"	3-1/4
66906	3/4"	7/8"	2-3/4"	2"	1-1/4"	4-3/4
66907	7/8"	1"	3-5/16"	2-1/4"	1-7/16"	6-1/2
66908	1"	1-1/8"	3-3/4"	2-11/16"	1-11/16"	8-1/2
66959	1-1/8"	1-1/4"	4-1/4"	2-5/8"	1-3/4"	9-1/2
66960	1-1/4"	1-3/8"	4-11/16"	3"	2"	12

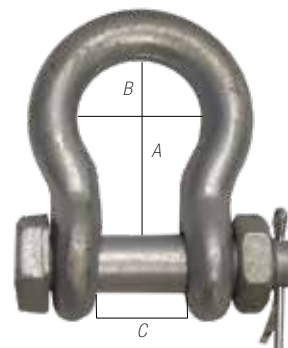

Mid Links

Forged carbon steel body. Alloy steel pins. Yellow zinc dichromate plated finish. For use with Grade 30, 40 & 70 chain.

PART#	CHAIN	PIN DIAMETER	A	B	C	D	W.L.L.	U.L.L.
66138	1/4"-5/16"	3/8"	7/16"	2-1/2"	1-5/8"	1-3/16"	4,700 lb	18,800 lb
66139	3/8"	7/16"	1/2"	2-13/16"	1-13/16"	1-3/8"	6,600 lb	26,400 lb
66140	7/16"-1/2"	9/16"	5/8"	3-5/8"	2-3/16"	1-3/4"	11,250 lb	45,000 lb

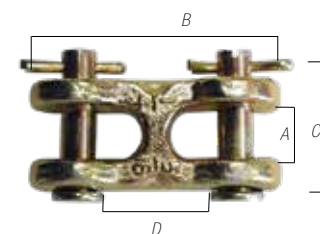

Notice: If pins are difficult to remove after 1/4 turn, it has likely been overloaded, and must be discarded and replaced.

Sizes are approximate. Specifications subject to change without notice. **Not Recommended for overhead lifting.**

Chain and Rigging

Cold Shuts • Chain Swivels • Repair Links • Link Locks



Cold Shuts

Formed steel. Clear zinc plated finish.

PART#	WIRE	W.L.L.	PACKAGE QUANTITY
66440	3/16"	550 lb	10
66441	1/4"	750 lb	10
66442	5/16"	1,250 lb	5
66443	3/8"	1,900 lb	5
66444	7/16"	2,650 lb	5
66445	1/2"	3,500 lb	5

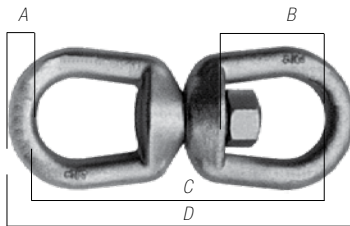

Forged Chain Swivel

Hot dipped, galvanized. Meets Fed. Spec. RR-C-271D-Type 7, Class 2. Not designed to swivel under load!

PART#	A	B	C	D	W.L.L.	U.L.L.
66165	1/4"	1-1/16"	3"	3-7/16"	850 lb	4,250 lb
66166	5/16"	1-1/4"	3-9/16"	4-1/8"	1,250 lb	6,250 lb
66167	3/8"	1-1/2"	4-5/16"	5-7/16"	2,250 lb	11,250 lb
66168	1/2"	2"	5-7/16"	6-7/16"	3,600 lb	18,000 lb

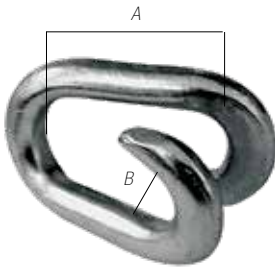

Repair Links

Mild steel. Clear zinc plated finish.

PART#	CHAIN	A	B	W.L.L.	U.L.L.	PACKAGE QUANTITY
66400	1/8"	3/4"	1/4"	150 lb	600 lb	10
66401	3/16"	1"	1/2"	200 lb	800 lb	10
66402	1/4"	1-1/4"	1/2"	400 lb	1,600 lb	10
66403	5/16"	1-1/2"	3/4"	700 lb	2,800 lb	5
66404	3/8"	1-5/8"	3/4"	1,500 lb	6,000 lb	5

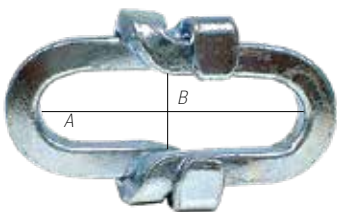

Link Locks

PART#	CHAIN	A	B	W.L.L.	U.L.L.	PACKAGE QUANTITY
66413	1/4"	2-1/4"	5/8"	1,000 lb	3,700 lb	5
66414	5/16"	2-3/4"	3/4"	1,500 lb	6,000 lb	5
66415	3/8"	3-1/8"	3/4"	3,000 lb	12,000 lb	5

Sizes are approximate. Specifications subject to change without notice. **Not Recommended for overhead lifting.**



Chain and Rigging



“Missing Link” Connecting Links

Forged steel, Grade 30.

PART#	CHAIN	A	B	C	W.L.L.	PACKAGE QUANTITY
66416	1/4"	9/32"	7/8"	1-1/2"	1,125 lb	5
66417	5/16"	11/32"	15/16"	1-11/16"	1,700 lb	5
66418	3/8"	13/32"	1-1/8"	2-1/16"	2,325 lb	5

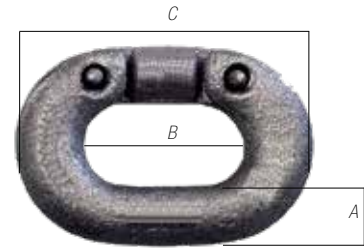

Quick Links - Zinc Plated

Zinc plated. Mild steel.

PART#	A	B	C	W.L.L.	U.L.L.	PACKAGE QUANTITY
66430	1/8"	3/16"	1-7/16"	220 lb	550 lb	10
66431	3/16"	1/4"	2"	660 lb	1,650 lb	10
66432	1/4"	9/32"	2-1/4"	880 lb	2,200 lb	10
66433	5/16"	11/32"	2-15/16"	1,760 lb	4,400 lb	5
66434	3/8"	7/16"	3-9/16"	2,200 lb	5,500 lb	5
66435	7/16"	1/2"	3-11/16"	2,640 lb	6,600 lb	5
66436	1/2"	9/16"	4-1/8"	3,300 lb	8,250 lb	5

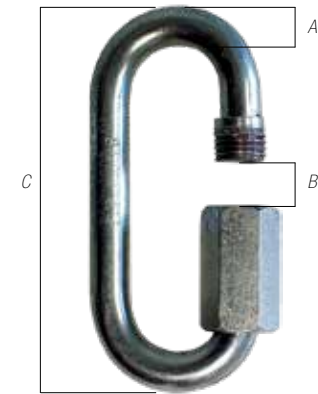

Quick Links - Stainless Steel

A151 316 Stainless Steel.

PART#	A	B	C	W.L.L.	PACKAGE QUANTITY
64000	1/8"	3/16"	1-7/16"	220 lb	5
64001	5/32"	7/32"	1-5/8"	400 lb	5
64002	1/4"	11/32"	2-9/32"	880 lb	5
64003	5/16"	3/8"	2-7/8"	1,600 lb	5
64004	3/8"	1/2"	3-1/2"	2,200 lb	5



Forged-D-Ring With Weld-On Bracket

Forged, hot dipped, galvanized. Comes with weld-on bracket.

PART#	WIRE DIAMETER	A	B	W.L.L.
66185	1/2"	2-1/4"	2-1/2"	12,000 lb
66186	5/8"	3"	3"	18,000 lb
66187	3/4"	3"	3"	26,500 lb
66188	1"	3"	4"	47,000 lb

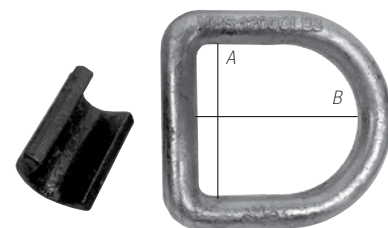

Sizes are approximate. Specifications subject to change without notice. **Not Recommended for overhead lifting.**

Chain and Rigging

Cable • Wire Rope



Aircraft Cable 7 X 7 Construction

Galvanized steel. Supplied on spools.

PART#	CABLE DIAMETER	BREAK STRENGTH	SPOOL LENGTH
77000	1/16"	480 lb	500'
77001	3/32"	920 lb	500'
77002	1/8"	1,700 lb	250'
77010	1/16"	480 lb	1,000'
77011	3/32"	920 lb	1,000'
77012	1/8"	1,700 lb	1,000'

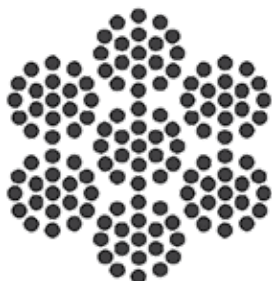

Aircraft Cable 7 X 19 Construction

Galvanized steel. Supplied on spools.

PART#	CABLE DIAMETER	BREAK STRENGTH	SPOOL LENGTH
77003	5/32"	2,800 lb	250'
77004	3/16"	4,200 lb	250'
77005	1/4"	7,000 lb	250'
77006	5/16"	9,800 lb	250'
77007	3/8"	14,400 lb	250'
77013	5/32"	2,800 lb	1,000'
77014	3/16"	4,200 lb	1,000'
77015	1/4"	7,000 lb	1,000'
77016	5/16"	9,800 lb	1,000'
77017	3/8"	14,400 lb	1,000'

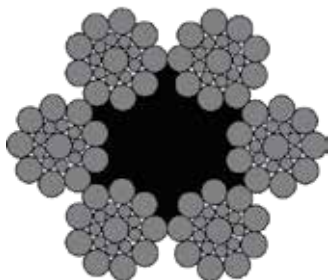

Wire Rope

Supplied in coils. Oily finish. Fibre core.

PART#	ROPE DIAMETER	BREAK STRENGTH	SPOOL LENGTH
77020	1/2"	22,000 lb	100'

Sizes are approximate. Specifications subject to change without notice. **Not Recommended for overhead lifting.**



Chain and Rigging



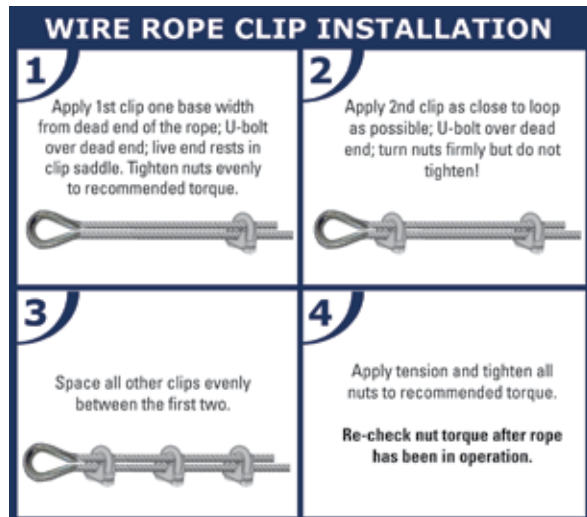

NOTE: Properly swagged cable sleeves are capable of maintaining over 90% of the breaking strength of the cable.

The maximum holding strength of cable stops are approximately 1/3 of the strength of the cable.

To determine the exact holding strength, a pull test must be performed prior to use.

Malleable Iron Wire Rope Clips

Galvanized iron saddles. Meets Fed. Spec. FF-C-450, Type 1, Class 2*, (except 1/8"). Complete with U-bolts and nuts.

PART#	CABLE	PACKAGE QUANTITY
77030	1/8"	10
77031	3/16"	10
77032	1/4"	10
77033	5/16"	10
77034	3/8"	5
77035	1/2"	5
77036	5/8"	1
77037	3/4"	1
77038	7/8"	1
77039	1"	1



Forged Steel Wire Rope Clips

Forged steel body. Zinc plated finish. Meets Fed. Spec. FF-C-450, Type 1, Class 1**. Complete with U-bolts and nuts.

PART#	CABLE	PACKAGE QUANTITY
77040	1/8"	5
77041	3/16"	5
77042	1/4"	5
77043	5/16"	5
77044	3/8"	5
77045	1/2"	5
77046	5/8"	1
77047	3/4"	1
77048	7/8"	1
77049	1"	1



Sizes are approximate. Specifications subject to change without notice. **Not Recommended for overhead lifting.**

Chain and Rigging

Wire Rope Clips • Thimbles



Stainless Steel Wire Rope Clips

Metric thread. Stainless Steel Grade 304***.

PART#	CABLE	PACKAGE QUANTITY
64020	1/8"	5
64021	3/16"	5
64022	1/4"	5
64023	5/16"	5
64024	3/8"	5

* **Type 1** - Single grip, single saddle, with U-bolts and nuts (MS16842).
Class 2 - Assembled with separate hex headed bolts and nuts (MS51868).

** **Type 1** - Single grip, single saddle, with U-bolts and nuts (MS16842).
Class 1 - Steel saddle.

*** **Grade 304** - is the standard "18/8" stainless; it is the most versatile and most widely used stainless steel, available in a wider range of products, forms and finishes than any other. It has excellent forming and welding characteristics.

Cable Thimbles

Stainless Steel.



Wire Rope Clip



PART#	CABLE	PACKAGE QUANTITY
64040	1/8"	5
64041	3/16"	5
64042	1/4"	5
64043	5/16"	5
64044	3/8"	5

Standard Wire Rope Thimbles

Zinc plated steel. Meets Fed. Spec. FF-T-276B, Type 2.



Wire Rope Clip



PART#	CABLE	PACKAGE QUANTITY	PART#	CABLE	PACKAGE QUANTITY
77050	1/8"	10	77054	3/8"	10
77051	3/16"	10	77055	1/2"	5
77052	1/4"	10	77056	5/8"	1
77053	5/16"	10			

Heavy Wire Rope Thimbles

Hot dipped galvanized steel. Meets Fed. Spec. FF-T-276B, Type 3.



Wire Rope Clip



PART#	CABLE	PACKAGE QUANTITY	PART#	CABLE	PACKAGE QUANTITY
77060	1/4"	10	77065	3/4"	1
77061	5/16"	10	77066	7/8"	1
77062	3/8"	10	77067	1"	1
77063	1/2"	5	77068	1-1/8"	1
77064	5/8"	1			

Warning: Thimbles are not designed to support loads.

Sizes are approximate. Specifications subject to change without notice. **Not Recommended for overhead lifting.**



Chain and Rigging



Cable Stops

Aluminum.

PART#	CABLE	LENGTH	PACKAGE QUANTITY	DYNAPAK	PACKAGE QUANTITY
77070	1/16"	3/16"	10	97070	10 x 77070
77071	3/32"	5/16"	10	97071	10 x 77071
77072	1/8"	5/16"	10	97072	10 x 77072
77073	5/32"	5/16"	10	97073	10 x 77073
77074	3/16"	3/8"	10	97074	10 x 77074
77075	1/4"	11/16"	5	97075	5 x 77075



Cable Sleeves

Aluminum.

PART#	CABLE	LENGTH	PACKAGE QUANTITY	DYNAPAK	PACKAGE QUANTITY
77080	1/16"	3/8"	10	97080	10 x 77080
77081	3/32"	1/2"	10	97081	10 x 77081
77082	1/8"	5/8"	10	97082	10 x 77082
77083	5/32"	9/16"	10	97083	10 x 77083
77084	3/16"	1"	10	97084	6 x 77084
77085	1/4"	1-1/8"	10	97085	5 x 77085
77086	5/16"	1-1/4"	10		
77087	3/8"	1-1/2"	10		



NOTE:

Properly swagged cable sleeves are capable of maintaining over 90% of the breaking strength of the cable.

The maximum holding strength of cable stops are approximately 1/3 of the strength of the cable.

To determine the exact holding strength, a pull test must be performed prior to use.

Dynaline offers merchandisers for almost every product. If you are ordering the products above then you may be interested in the following Merchandiser. For more information on this merchandiser see the Merchandising Section at the front of the catalogue.

Wire Rope Accessories Merchandiser 24" x 24"

PART#	CONTENTS
00567K	Full Wire Rope Accessories Merchandiser.

Wire Rope Accessories Merchandiser 12" x 24"

PART#	CONTENTS
00566K	Full Wire Rope Accessories Merchandiser.



Your Trusted Source.

Sizes are approximate. Specifications subject to change without notice. **Not Recommended for overhead lifting.**

Chain and Rigging

Cable Cutters • Swagers • Chain Pliers • Tire Chain Hardware



Chain and Rigging



Cable Cutters

Aluminum drop-forged handles. Heat-treated blades (HRC 56-63). SK-5 cutter material.

PART#	REFERENCE#	CUTTING CAPACITY	OVERALL LENGTH
77107	C-7	Up to 5/32" Diameter Cable	7-1/2"
77116	C-16	Up to 5/8" Diameter Cable	23"



Bench Swager

For in-shop, one location jobs. Multi-compression jaws swager for 1/16", 3/32", 1/8", 5/32" & 3/16" oval/stop sleeves.

PART#	LENGTH	HEIGHT (OPEN)	WEIGHT
77101	22-1/2"	24"	3 kg



Hand Swager

For installing aluminum or copper sleeves & stops. Heat-treated alloy jaws.

PART#	CRIMPING CAPACITY	LENGTH
77100	1/16" to 3/16" Diameter	24"



Tire Chain Pliers

Opens & closes chain hardware easily. Alloy steel jaws. Steel handles with rubber hand grips.

PART#	OVERALL LENGTH	JAW OPENING
68100	32"	2"



Tire Chain Hardware

Made from C-1020 carbon steel.

PART#	DESCRIPTION	OVERALL LENGTH
68010	Boomer	7"
68011	Clevis & Thumbscrew	2"
68012	C-Hook	4"
68013	Boomer	6-1/2"
68014	C-Link	2-1/2"
68015	C-Hook	3-1/2"

Sizes are approximate. Specifications subject to change without notice. **Not Recommended for overhead lifting.**



General Hardware



Tarp Hooks
S-hooks
Gate hooks
Bushings
Screw hooks
U-bolts

Snaps
Snap links
Rings
Eye-bolts
Lag screws
Carabiners



**GENERAL
HARDWARE**



Table of Contents

Pulleys.....235	Snaps.....245
Solid - Die Cast Aluminum Pulleys..... 235	Stainless Steel Bolt Snaps..... 245
Spoked - Die Cast Aluminum Pulleys..... 235	Stainless Steel Security Snaps..... 245
Variable Speed - Die Cast Aluminum Pulleys..... 235	Stainless Steel Spring Snaps..... 245
Single Fixed - Die Cast Awning Pulleys..... 235	Stainless Steel Boat Snaps..... 245
Double Fixed - Die Cast Awning Pulleys..... 236	Aluminum Spring Snap..... 245
Single Swivel - Die Cast Awning Pulleys..... 236	Safety Lanyard Snaps..... 245
Double Swivel - Die Cast Awning Pulleys..... 236	Bull Snap..... 246
Pulley Blocks.....236	Solid Snap Hook..... 246
Swivel - Steel Pulley Blocks..... 236	Cap Snap..... 246
Fixed - Steel Pulley Blocks..... 236	Swivel Eye Snaps..... 246
Swivel Eye - Steel Pulley Blocks (Deuer Type)..... 237	Dog Lead Snap..... 246
Fixed Eye - Steel Pulley Blocks (Deuer Type)..... 237	Panic Snap..... 246
Double Hook With Swivel Eye - Steel Pulley Blocks..... 237	Trigger Snaps..... 247
Single Hook - Steel Pulley Blocks (Deuer Type)..... 237	Bolt Snaps..... 247
Replacement Sheaves - Steel Pulley Blocks..... 237	Bolt Snaps..... 247
Replacement Sheaves - Steel Pulley Blocks..... 238	Bolt Snaps..... 247
Stake Rack Hardware.....238	Open Eye Snaps..... 248
Stake Hooks - Stake Rack Hardware..... 238	Loop Snaps..... 248
Stake Eye - Stake Rack Hardware..... 238	Swivel Loop Snaps..... 248
Hooks.....238	Open Decoy Snaps..... 248
S-Hooks..... 238	Spring Snap..... 248
Tarp Hooks..... 239	Baby Square Eye Snaps..... 249
Cornice Hooks..... 239	Swivel Snaps..... 249
Screw Hooks..... 239	Lever Snaps..... 249
Screw Eyes..... 239	Security Snaps..... 249
Eyebolts.....240	Swivel Security Snaps..... 249
Lagscrew Eyebolts..... 240	Eye Bull Snaps..... 249
Shoulder Eyebolts..... 240	Flat Spring Snap - Simplex..... 250
Eyebolts..... 240	Bronze Animal Snap..... 250
U-Bolts • Mounting Rings.....241	Snap Links.....250
U-Bolts - Round..... 241	Steel Snap Links..... 250
U-Bolts - Square..... 241	Aluminum Snap Links..... 250
Mounting Rings..... 241	Stainless Steel Snap Links..... 250
D-Rings • Rings.....242	Carabiner with Magnet..... 250
D-Rings..... 242	
Heavy Duty D-Rings..... 242	
Split Key Rings..... 242	
Harness Ring..... 242	
Welded Steel Ring..... 242	
Turnbuckles.....242	
Hook & Eye Turnbuckles (Wire Formed Ends)..... 242	
Hook & Hook Turnbuckles (Wire Formed Ends)..... 243	
Eye & Eye..... 243	
Hook & Eye Turnbuckles (Malleable Iron)..... 243	
Hook & Hook Turnbuckles (Forged Steel)..... 243	
Hook & Eye Turnbuckles (Forged Steel)..... 244	
Eye & Eye Turnbuckles (Forged Steel)..... 244	
Jaw & Jaw Turnbuckles (Forged Steel)..... 244	



Solid - Die Cast Aluminum Pulleys

Single groove for 3L, 4L or "A" belts. Supplied with 5/16" x 1/2" UNC set screws.

PART#	OUTSIDE DIAMETER	BORE	KEYWAY	PART#	OUTSIDE DIAMETER	BORE	KEYWAY
55400	1-1/2"	1/2"	No	55413	3"	3/4"	Yes
55401	1-1/2"	5/8"	No	55414	3-1/2"	1/2"	No
55402	2"	1/2"	No	55415	3-1/2"	5/8"	Yes
55403	2"	5/8"	Yes	55416	3-1/2"	3/4"	Yes
55404	2"	3/4"	Yes	55417	4"	1/2"	No
55405	2-1/4"	1/2"	No	55418	4"	5/8"	Yes
55406	2-1/4"	5/8"	Yes	55419	4"	3/4"	Yes
55407	2-1/4"	3/4"	Yes	55420	4-1/2"	1/2"	No
55408	2-1/2"	1/2"	No	55421	4-1/2"	5/8"	Yes
55409	2-1/2"	5/8"	Yes	55422	4-1/2"	3/4"	Yes
55410	2-1/2"	3/4"	Yes	55423	5"	1/2"	No
55411	3"	1/2"	No	55424	5"	5/8"	Yes
55412	3"	5/8"	Yes	55425	5"	3/4"	Yes



Spoked - Die Cast Aluminum Pulleys

PART#	OUTSIDE DIAMETER	BORE	KEYWAY	PART#	OUTSIDE DIAMETER	BORE	KEYWAY
55426	6"	1/2"	No	55430	7"	5/8"	Yes
55427	6"	5/8"	Yes	55431	7"	3/4"	Yes
55428	6"	3/4"	Yes	55433	8"	5/8"	Yes
55429	7"	1/2"	No	55434	8"	3/4"	Yes



Variable Speed - Die Cast Aluminum Pulleys

Solid type. For "A" & "B" belts. Opening the pulley increases the speed at which it rotates. Supplied with set screws.

PART#	OUTSIDE DIAMETER	BORE	KEYWAY
55490	3-1/4"	1/2"	No
55491	3-1/4"	5/8"	Yes
55492	3-1/4"	3/4"	Yes



Single Fixed - Die Cast Awning Pulleys

PART#	PULLEY DIAMETER	ROPE DIAMETER	EYE DIAMETER	W.L.L.
55900	3/4"	up to 3/16"	3/16"	65 lb
55901	1"	up to 1/4"	1/4"	110 lb
55902	1-1/4"	up to 3/8"	3/8"	165 lb
55903	1-1/2"	up to 3/8"	3/8"	220 lb
55904	2"	up to 1/2"	1/2"	330 lb



Sizes are approximate. Specifications subject to change without notice.

General Hardware

Pulleys • Pulley Blocks



Double Fixed - Die Cast Awning Pulleys

PART#	PULLEY DIAMETER	ROPE DIAMETER	EYE DIAMETER	W.L.L.
55906	3/4"	up to 3/16"	3/16"	65 lb
55907	1"	up to 1/4"	3/16"	110 lb
55908	1-1/2"	up to 3/8"	3/8"	220 lb
55909	2"	up to 1/2"	1/2"	330 lb



Single Swivel - Die Cast Awning Pulleys

PART#	PULLEY DIAMETER	ROPE DIAMETER	EYE DIAMETER	W.L.L.
55915	3/4"	up to 3/16"	1/2"	65 lb
55916	1"	up to 1/4"	7/16"	110 lb
55917	1-1/4"	up to 3/8"	13/16"	165 lb
55918	1-1/2"	up to 3/8"	13/16"	220 lb
55919	2"	up to 1/2"	13/16"	330 lb



Double Swivel - Die Cast Awning Pulleys

PART#	PULLEY DIAMETER	ROPE DIAMETER	EYE DIAMETER	W.L.L.
55925	3/4"	up to 3/16"	7/16"	65 lb
55926	1"	up to 1/4"	7/16"	110 lb
55927	1-1/4"	up to 3/8"	13/16"	165 lb
55928	1-1/2"	up to 3/8"	13/16"	220 lb



Swivel - Steel Pulley Blocks

PART#	SHEAVE DIAMETER	LENGTH	ROPE DIAMETER	EYE DIAMETER	W.L.L.
55800	1-1/2"	3-1/2"	up to 3/8"	3/8"	460 lb
55801	2"	4"	up to 3/8"	3/8"	480 lb
55802	2-1/2"	4-1/2"	up to 3/8"	3/8"	550 lb
55803	3"	4-3/4"	up to 1/2"	3/8"	650 lb



Fixed - Steel Pulley Blocks

PART#	SHEAVE DIAMETER	LENGTH	ROPE DIAMETER	EYE DIAMETER	W.L.L.
55810	1-1/2"	3-1/4"	up to 3/8"	1/2"	420 lb
55811	2"	3-3/4"	up to 3/8"	1/2"	480 lb
55812	2-1/2"	4-1/4"	up to 3/8"	1/2"	550 lb
55813	3"	4-3/4"	up to 3/8"	3/4"	650 lb

Sizes are approximate. Specifications subject to change without notice.



General Hardware

Swivel Eye - Steel Pulley Blocks (Deuer Type)

PART#	DIAMETER	LENGTH	MAXIMUM CABLE DIAMETER	EYE DIAMETER	W.L.L.
55850	1-1/2"	3-1/2"	3/16"	3/8"	460 lb
55851	2"	4-1/2"	3/16"	3/8"	480 lb
55852	2-1/2"	5"	1/4"	3/8"	550 lb
55853	3"	4-3/4"	1/4"	3/8"	650 lb



Fixed Eye - Steel Pulley Blocks (Deuer Type)

PART#	DIAMETER	LENGTH	MAXIMUM CABLE DIAMETER	EYE DIAMETER	W.L.L.
55860	1-1/2"	3-1/4"	3/16"	1/2"	420 lb
55861	2"	3-3/4"	3/16"	1/2"	480 lb
55862	2-1/2"	4-1/4"	1/4"	1/2"	550 lb
55863	3"	4-3/4"	1/4"	3/4"	650 lb



Double Hook With Swivel Eye - Steel Pulley Blocks (Deuer Type)

PART#	DIAMETER	LENGTH	MAXIMUM CABLE DIAMETER	W.L.L.
55870	1-1/2"	5"	3/16"	460 lb
55871	2"	5-1/2"	3/16"	480 lb
55872	2-1/2"	6"	1/4"	550 lb
55873	3"	7-1/2"	1/4"	650 lb



Single Hook - Steel Pulley Blocks (Deuer Type)

PART#	DIAMETER	LENGTH	MAXIMUM CABLE DIAMETER	W.L.L.
55880	1-1/2"	5"	3/16"	460 lb
55881	2"	5-1/2"	3/16"	480 lb
55882	2-1/2"	6"	1/4"	550 lb
55883	3"	7-1/2"	1/4"	650 lb



Replacement Sheaves - Steel Pulley Blocks (Deuer Type)

PART#	DIAMETER	BORE SIZE	W.L.L.
55840	1-1/2"	5/16"	420 lb
55841	2"	5/16"	480 lb
55842	2-1/2"	5/16"	550 lb
55843	3"	7/16"	650 lb



Sizes are approximate. Specifications subject to change without notice.

General Hardware

Pulley Blocks • Stake Rack Hardware • S-Hooks



Replacement Sheaves - Steel Pulley Blocks (Deuer Type)

For heavy duty pulley blocks.

PART#	SHEAVE DIAMETER	W.L.L.
55890	1-1/2"	460 lb
55891	2"	480 lb
55892	2-1/2"	550 lb
55893	3"	650 lb



Stake Hooks - Stake Rack Hardware

Ductile iron. Clear zinc plated finish. Rockwell hardness: 5.4 – 18 (HRC).

PART#	DESCRIPTION	PIN LENGTH	PIN DIAMETER
23050	Left-Hand	3"	9/16"
23051	Right-Hand	3"	9/16"
23052	Left-Hand	6"	9/16"
23053	Right-Hand	6"	9/16"



Stake Eye - Stake Rack Hardware

PART#	EYE INSIDE DIAMETER
23054	5/8"



S-Hooks

Clear zinc plated finish.

BAG PACKAGE		DYNAPAK PACKAGE		WIRE DIAMETER	OVERALL LENGTH
PART#	PACKAGE QUANTITY	PART #	PACKAGE QUANTITY		
66230	10	96230	10	0.093" (3/32")	1"
66232	10	96232	10	0.105" (7/64")	1-3/32"
66234	10	96234	10	0.120" (1/8")	1-3/8"
66235	10	96235	10	0.162" (5/32")	1-1/2"
66236	10	96236	6	0.141" (9/64")	2-1/8"
66238	10	96238	6	0.250" (1/4")	2-5/8"
66239	10	96239	6	0.188" (3/16")	3"

Reference Chart Available

See end of catalogue

Sizes are approximate. Specifications subject to change without notice.



General Hardware

Tarp Hooks

Zinc plated formed steel.

PART#	WIRE DIAMETER	OVERALL LENGTH	PACKAGE QUANTITY
66423	3/8"	3-1/2"	10
66424	1/4"	2-1/2"	10



Cornice Hooks

Clear zinc plated finish.

PART#	A	B	C	D	PACKAGE QUANTITY
65040	9/32"	1-3/4"	1"	3-1/16"	10
65041	3/16"	1-5/8"	7/8"	2-5/8"	10
65042	5/32"	1-3/8"	13/16"	2-1/4"	10
65043	1/8"	1-1/8"	11/16"	1-13/16"	10
65044	3/32"	3/4"	1/2"	1-3/8"	10

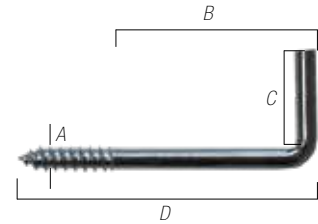

Screw Hooks

Clear zinc plated finish.

PART#	A	A (DECIMAL)	B	C	C (MM)	D	PACKAGE QUANTITY
65070	1/4"	0.25"	3-1/16"	1-1/32"	1.03	4-5/16"	10
65071	7/32"	0.21"	3-3/16"	1"	25.4	4-7/16"	10
65072	3/16"	0.19"	2-5/8"	27/32"	84.38	3-7/8"	10
65073	5/32"	0.158"	2-1/8"	11/16"	17.44	3-3/8"	10
65074	1/8"	0.138"	2-9/16"	1/2"	13.2	2-9/16"	10
65075	7/64"	0.112"	2-1/16"	13/32"	0.41	2-1/16"	10
65076	3/32"	0.086"	1-1/16"	9/32"	0.28	1-11/16"	10
65077	5/64"	0.073"	3/4"	15/16"	0.94	1-5/16"	10

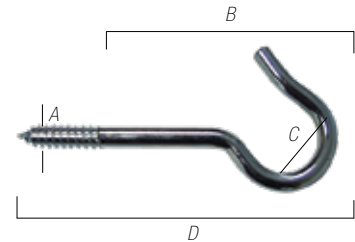

Screw Eyes

Clear zinc plated finish.

PART#	A	B	C	D	E	PACKAGE QUANTITY
65006	0.216"	15/16"	1"	1-15/16"	17/32"	10
65017	0.190"	13/16"	5/8"	1-9/16"	25/64"	10
65018	0.158"	11/16"	5/8"	1-5/16"	21/64"	10
65019	.138"	7/16"	1/4"	3/4"	1/8"	10
65024	0.250"	1-1/8"	7/8"	1-5/16"	19/64"	10
65031	.250"	3/4"	1/2"	1-1/8"	5/16"	10

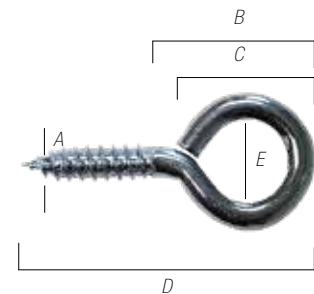

Sizes are approximate. Specifications subject to change without notice.



General Hardware

Eyebolts

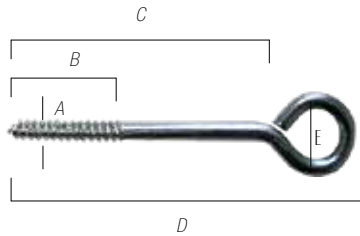

Lagscrew Eyebolts

Clear zinc plated finish.

PART#	A	B	C	D	E	PACKAGE QUANTITY
65161	1/4"	1-5/16"	2-3/4"	3-3/4"	1/2"	10
65162	1/4"	1-7/8"	4"	5"	1/2"	10
65163	5/16"	1-7/8"	2-3/4"	4"	5/8"	10
65164	5/16"	1-7/8"	4-3/4"	6"	5/8"	10
65165	3/8"	1-15/16"	3"	4-1/2"	3/4"	10
65166	3/8"	2-7/8"	6-1/2"	8"	3/4"	10

Shoulder Eyebolts

Forged steel. Galvanized finish. Supplied with nut. Sold individually.

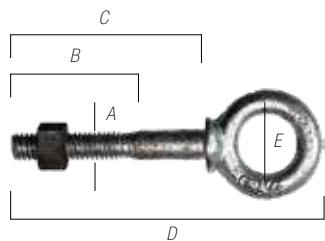

PART#	A	B	C	D	E	W.L.L.
66100	1/4"	1-1/2"	2"	3"	1/2"	500 lb
66101	5/16"	1-1/2"	2-1/4"	3-1/2"	5/8"	800 lb
66102	3/8"	1-1/2"	2-1/2"	4"	3/4"	1,200 lb
66103	1/2"	1-1/2"	3-1/4"	5-1/4"	1"	2,200 lb
66104	5/8"	1-3/4"	4"	6-1/2"	1-1/4"	3,500 lb
66105	1/4"	2-1/2"	4"	5"	1/2"	500 lb
66106	5/16"	2-1/2"	4-1/4"	5-1/2"	5/8"	800 lb
66107	3/8"	2-1/2"	6"	7-1/2"	3/4"	1,200 lb
66108	1/2"	3"	6"	7-3/4"	1"	2,200 lb

Eyebolts

Wire Formed. Supplied with Nut. Zinc plated finish.

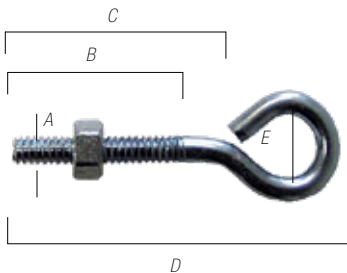

PART#	A	B	C	D	E	PACKAGE QUANTITY
65102	3/16"	1"	1-3/8"	2"	3/8"	10
65104	3/16"	1-5/8"	1-3/4"	2-1/2"	3/8"	10
65106	1/4"	1"	1"	2"	9/16"	10
65107	1/4"	1-3/8"	1-1/2"	2-1/2"	9/16"	10
65108	1/4"	1-3/4"	2"	3"	9/16"	10
65109	1/4"	2-3/4"	3"	4"	9/16"	10
65110	1/4"	3"	4"	5"	9/16"	10
65111	1/4"	3"	5"	6"	9/16"	10
65112	5/16"	1-3/4"	2"	3-1/4"	3/4"	10
65113	5/16"	2-3/16"	2-1/2"	4"	3/4"	10
65114	5/16"	3"	3-1/2"	5"	3/4"	10
65115	5/16"	3"	4-1/2"	6"	3/4"	10
65117	3/8"	2"	2-1/4"	4"	1"	10
65118	3/8"	3"	3-1/4"	5"	1"	10
65119	3/8"	3"	4-1/4"	6"	1"	10
65120	3/8"	3"	6-1/4"	8"	1"	10
65123	1/2"	3"	3-3/4"	6"	1-1/4"	10
65124	1/2"	3"	5-3/4"	8"	1-1/4"	10

Sizes are approximate. Specifications subject to change without notice.



U-Bolts - Round

Supplied with 3/32" mounting plate & nuts. Clear zinc plated. 10 pieces per package. UNC threading (coarse).

PART#	A	B	C	D	THREADS / INCH	PIPE
65140	1/4"	1-1/8"	2"	1"	20	3/4"
65141	1/4"	1-3/8"	2-3/4"	1-1/4"	20	1"
65142	1/4"	2"	3-1/2"	1-3/4"	20	1-1/2"
65143	5/16"	1-3/8"	2-1/2"	1"	18	1"
65144	5/16"	1-3/8"	3-11/16"	2-3/8"	18	1"
65145	5/16"	1-3/4"	3"	1-1/2"	18	1-1/4"
65146	5/16"	1-3/4"	4-3/16"	2-3/4"	18	1-1/4"
65147	5/16"	2"	3"	1-1/2"	18	1-1/2"
65148	5/16"	2"	3-3/4"	2-1/8"	18	1-1/2"
65149	5/16"	2-1/2"	3-1/2"	1-1/2"	18	2"
65150	5/16"	2-1/2"	4-3/16"	2-3/8"	18	2"
65151	3/8"	2-1/2"	3-5/8"	1-3/4"	16	2"
65152	3/8"	3"	4-1/8"	1-3/4"	16	2-1/2"
65153	3/8"	3-1/2"	4-5/8"	2"	16	3"

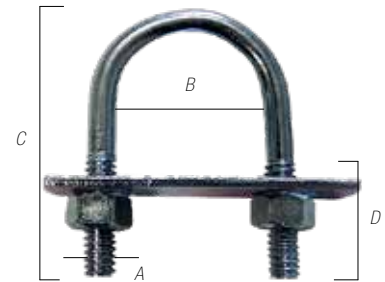

U-Bolts - Square

Supplied with 3/32" mounting plate & nuts. Clear zinc plated. 5 pieces per package.

PART#	A	B	C	D
65181	3/8"	2"	3"	1-1/2"
65182	3/8"	2"	5"	3"
65184	3/8"	4"	3"	1-1/2"
65185	3/8"	4"	5"	3"
65187	3/8"	6"	5"	3"
65188	3/8"	6"	7"	3-3/4"

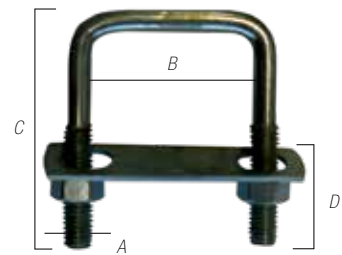

Mounting Rings

Supplied with 3/32" mounting plate & nuts. Clear zinc plated. 10 pieces per package.

PART#	DESCRIPTION	PIN DIAMETER	THREAD LENGTH	RING I.D.	ADDITIONAL INFORMATION
65172	2-1/2" Eyebolt	3/8"	2-3/8"	2"	Mounting holes are 1/4" Diameter
65177	4-1/2" Lagscrew Eyebolt	5/16"	1-3/4"	2"	Mounting holes are 1/4" Diameter
65178	2" x 1-9/16" Mounting Plate			2"	Mounting holes are 1/4" Diameter



Sizes are approximate. Specifications subject to change without notice.



General Hardware

D-Rings • Rings • Turnbuckles

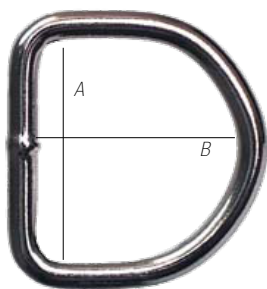

D-Rings

PART#	WIRE DIAMETER	A	B	PACKAGE QUANTITY
66173	1/8"	1"	7/8"	10
66174	1/8"	1-1/8"	7/8"	10
66175	5/32"	1-5/16"	1"	10
66176	5/32"	1-5/8"	1-1/8"	10

Heavy Duty D-Rings

PART#	WIRE DIAMETER	A	B	PACKAGE QUANTITY
66178	5/16"	2"	1-3/4"	10
66179	3/8"	2"	1-7/8"	10

Split Key Rings

PART#	WIRE DIAMETER	INSIDE DIAMETER	OUTSIDE DIAMETER	PACKAGE QUANTITY
66180	0.066"	5/8"	3/4"	10
66182	0.075"	27/32"	1"	10
66184	0.087"	1-5/64"	1-1/4"	10

Harness Ring

PART#	WIRE DIAMETER	INSIDE DIAMETER	OUTSIDE DIAMETER	PACKAGE QUANTITY
66390	3/16"	1-1/4"	1-5/8"	5

Welded Steel Ring

PART#	WIRE DIAMETER	INSIDE DIAMETER	OUTSIDE DIAMETER	W.L.L.	PACKAGE QUANTITY
66410	1/4"	1"	1-1/2"	200 lb	10
66411	5/16"	1-1/8"	1-3/4"	250 lb	10
66412	7/32"	1-9/16"	2"	200 lb	10

Hook & Eye Turnbuckles (Wire Formed Ends)

For light duty applications. Zinc die cast bodies. Zinc plated steel wire formed ends. 10 pieces per package.

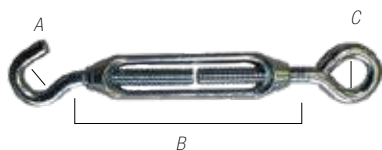

PART#	THREAD	OVERALL LENGTH CLOSED	OVERALL LENGTH OPEN	A	B	C	W.L.L.	U.L.L.
66206	7/32"	4-1/2"	6-1/2"	3/8"	5/16"	2"	120 lb	350 lb
66207	1/4"	5-3/8"	7-11/16"	7/16"	3/8"	2-3/8"	190 lb	570 lb
66208	5/16"	6-1/2"	9-5/16"	7/16"	9/16"	2-13/16"	290 lb	875 lb
66209	3/8"	7-1/2"	10-5/8"	5/8"	9/16"	3-1/8"	375 lb	1,125 lb

Sizes are approximate. Specifications subject to change without notice.



General Hardware

Hook & Hook Turnbuckles (Wire Formed Ends)

For light duty applications. Zinc die cast bodies. Zinc plated steel wire formed ends. 10 pieces per package.

PART#	THREAD	OVERALL LENGTH CLOSED	OVERALL LENGTH OPEN	A, B	C	W.L.L.	U.L.L.
66216	7/32"	4-1/2"	6-1/2"	5/16"	2"	120 lb	350 lb
66217	1/4"	5-1/2"	7-9/16"	7/16"	2-3/8"	190 lb	570 lb
66218	5/16"	6-1/2"	6-1/4"	7/16"	2-13/16"	340 lb	1,020 lb
66219	3/8"	7"	10-5/8"	1/2"	3-1/8"	400 lb	1,200 lb

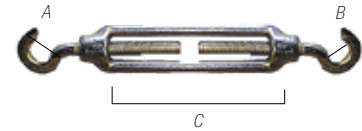

Eye & Eye

For light duty applications. Zinc die cast bodies. Zinc plated steel wire formed ends. 10 pieces per package.

PART#	THREAD	OVERALL LENGTH CLOSED	OVERALL LENGTH OPEN	A, B	C	W.L.L.	U.L.L.
66226	3/16"	4-1/2"	6-1/2"	3/8"	2"	120 lb	350 lb
66227	1/4"	5-1/2"	7-9/16"	3/8"	2-3/8"	190 lb	570 lb
66228	5/16"	6-1/2"	9-1/4"	7/16"	2-3/4"	340 lb	1,020 lb
66229	3/8"	7"	10-5/8"	1/2"	3-1/8"	400 lb	1,200 lb

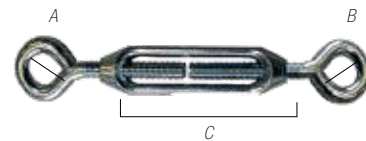

Hook & Eye Turnbuckles (Malleable Iron)

Malleable iron bodies and forged steel ends. Hot dipped galvanized finish.

PART#	THREAD	OVERALL LENGTH CLOSED	OVERALL LENGTH OPEN	A, B	C	W.L.L.	U.L.L.
66210	6mm	5-1/2"	8-1/4"	3/8"	2-3/4"	220 lb	660 lb
66211	8mm	6-7/8"	10-13/32"	7/16"	3-17/32"	440 lb	1,320 lb
66212	10mm	7-1/2"	11-7/16"	15/32"	3-15/16"	660 lb	1,980 lb
66213	12mm	10-1/4"	15-11/16"	19/32"	5-7/16"	1,210 lb	3,630 lb
66214	16mm	12-13/16"	20-3/32"	3/4"	7-9/32"	2,200 lb	6,600 lb
66215	20mm	15-3/4"	24"	1"	8-1/4"	3,300 lb	9,900 lb

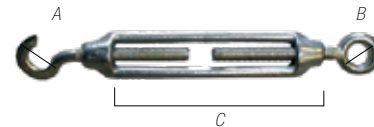

Hook & Hook Turnbuckles (Forged Steel)

Forged steel bodies & ends. Hot dipped galvanized finish. Features a lock nut on each end. Meets Spec. FF-T791b, Type 1, Form 1, Class 5.

PART#	THREAD	OVERALL LENGTH CLOSED	OVERALL LENGTH OPEN	A, B	C	W.L.L.	U.L.L.
66800	1/4"	8"	12"	7/16"	4"	400 lb	2,000 lb
66801	5/16"	9-1/4"	13-3/4"	1/2"	4-1/2"	700 lb	3,500 lb
66802	3/8"	11-3/4"	17-3/4"	9/16"	6"	1,000 lb	5,000 lb
66803	1/2"	13-3/8"	20-3/8"	11/16"	6"	1,500 lb	7,500 lb
66804	1/2"	16-3/8"	26-3/8"	11/16"	9"	1,500 lb	7,500 lb
66805	1/2"	19-3/8"	32-3/8"	11/16"	12"	1,500 lb	7,500 lb
66806	5/8"	15-1/4"	22-1/2"	7/8"	6"	2,250 lb	11,250 lb
66807	5/8"	18-1/4"	28-1/2"	7/8"	9"	2,250 lb	11,250 lb
66808	5/8"	21-1/4"	34-1/2"	7/8"	12"	2,250 lb	11,250 lb
66809	3/4"	17-1/4"	24-3/4"	1"	6"	3,000 lb	15,000 lb
66810	3/4"	20-1/4"	30-3/4"	1"	9"	3,000 lb	15,000 lb
66811	3/4"	23-1/4"	36-3/4"	1"	12"	3,000 lb	15,000 lb

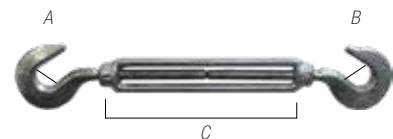

Sizes are approximate. Specifications subject to change without notice.

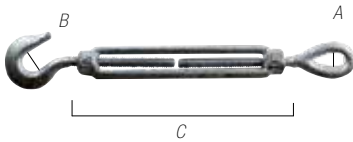

Hook & Eye Turnbuckles (Forged Steel)

Meets Spec. FF-T791b, Type 1, Form 1, Class 6.

PART#	THREAD	OVERALL LENGTH CLOSED	OVERALL LENGTH OPEN	A	B	C	W.L.L.	U.L.L.
66820	1/4"	8"	12"	11/32"	7/16"	3-3/4"	400 lb	2,000 lb
66821	5/16"	9-1/2"	13-1/2"	7/16"	1/2"	4-1/2"	700 lb	3,500 lb
66822	3/8"	12"	18"	17/32"	9/16"	6"	1,000 lb	5,000 lb
66823	1/2"	13-5/8"	20-5/8"	23/32"	11/16"	6"	1,500 lb	7,500 lb
66824	1/2"	16-5/8"	26-5/8"	23/32"	11/16"	9"	1,500 lb	7,500 lb
66825	1/2"	19-5/8"	32-5/8"	23/32"	11/16"	12"	1,500 lb	7,500 lb
66826	5/8"	15-1/2"	22-3/4"	7/8"	29/32"	6"	2,250 lb	11,250 lb
66827	5/8"	18-1/2"	28-3/4"	7/8"	29/32"	9"	2,250 lb	11,250 lb
66828	5/8"	21-1/2"	34-3/4"	7/8"	29/32"	12"	2,250 lb	11,250 lb
66829	3/4"	17-1/2"	25"	1"		6"	3,000 lb	15,000 lb
66880	3/4"	20-1/2"	31"	1"		9"	3,000 lb	15,000 lb
66881	3/4"	23-1/2"	31"	1"		12"	3,000 lb	15,000 lb

Eye & Eye Turnbuckles (Forged Steel)

Meets Spec. FF-T791b, Type 1, Form 1, Class 4.

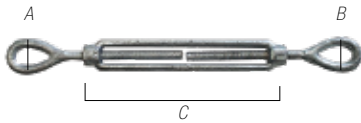

PART#	THREAD	OVERALL LENGTH CLOSED	OVERALL LENGTH OPEN	A, B	C	W.L.L.	U.L.L.
66830	1/4"	8-1/4"	12-1/4"	11/32"	4"	500 lb	2,500 lb
66831	5/16"	9-5/8"	14-1/8"	7/16"	4-1/2"	800 lb	4,000 lb
66832	3/8"	12-1/8"	18-1/8"	17/32"	6"	1,200 lb	6,000 lb
66833	1/2"	14"	21"	23/32"	6"	2,200 lb	11,000 lb

Jaw & Jaw Turnbuckles (Forged Steel)

Meets Spec. FF-T791b, Type 1, Form 1, Class 6.

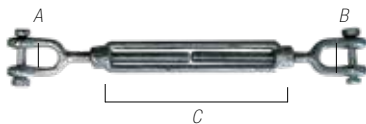

PART#	THREAD	OVERALL LENGTH CLOSED	OVERALL LENGTH OPEN	A, B	C	W.L.L.	U.L.L.
66840	1/4"	8"	12"	7/16"	4"	500 lb	2,500 lb
66841	5/16"	9-1/2"	14"	1/2"	4-1/2"	800 lb	4,000 lb
66842	3/8"	11-3/8"	17-3/8"	17/32"	6"	1,200 lb	6,000 lb
66843	1/2"	13"	20"	21/32"	6"	2,200 lb	11,000 lb
66844	1/2"	16"	26"	21/32"	9"	2,200 lb	11,000 lb
66845	1/2"	19"	32"	21/32"	12"	2,200 lb	11,000 lb
66846	5/8"	14-7/8"	22-1/8"	25/32"	6"	3,500 lb	17,500 lb
66847	5/8"	17-7/8"	28-1/8"	25/32"	9"	3,500 lb	17,500 lb
66848	5/8"	20-7/8"	34-1/8"	25/32"	12"	3,500 lb	17,500 lb
66849	3/4"	16-5/8"	24-1/8"	15/16"	6"	5,200 lb	26,000 lb
66850	3/4"	19-5/8"	30-1/8"	15/16"	9"	5,200 lb	26,000 lb
66851	3/4"	22-5/8"	36-1/8"	15/16"	12"	5,200 lb	26,000 lb

Sizes are approximate. Specifications subject to change without notice.

Stainless Steel Bolt Snaps

PART#	EYE INSIDE DIAMETER	GAP	OVERALL LENGTH	PACKAGE QUANTITY
64100	1/2"	9/32"	3-3/16"	5
64101	3/4"	11/32"	3-1/2"	5



Stainless Steel Security Snaps

PART#	EYE INSIDE DIAMETER	GAP	OVERALL LENGTH	W.L.L.	PACKAGE QUANTITY
64102	5/8"	3/8"	3-3/8"	100 lb	5
64103	3/4"	1/2"	3-7/8"	200 lb	5
64104	7/8"	1/2"	4-5/8"	300 lb	5



Stainless Steel Spring Snaps

PART#	EYE INSIDE DIAMETER	OVERALL LENGTH	PACKAGE QUANTITY
64105	1/4"	1-7/8"	5
64106	3/8"	2-5/8"	5
64107	1/2"	3-7/8"	5



Stainless Steel Boat Snaps

PART#	EYE INSIDE DIAMETER	GAP	OVERALL LENGTH	PACKAGE QUANTITY
64108	1/2"	1/4"	2"	5
64109	5/8"	7/16"	2-3/4"	5
64110	3/4"	9/16"	3-1/4"	5
64111	3/4"	5/8"	3-7/8"	5



Aluminum Spring Snap

Zinc plated.

PART#	EYE INSIDE DIAMETER	GAP	OVERALL LENGTH	PACKAGE QUANTITY
64112	1/2"	1/4"	2-3/8"	5



Safety Lanyard Snaps

PART#	TYPE	A	B	W.L.L.	U.L.L.
66137	Single latch	1-1/16"	3/4"	1,000 lb	5,000 lb
66137S	Double latch	1-1/16"	1"	1,000 lb	5,000 lb

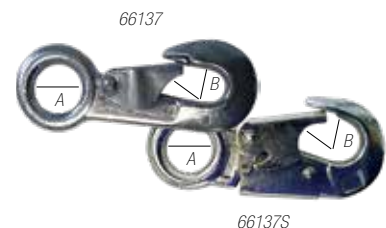

Sizes are approximate. Specifications subject to change without notice.



General Hardware

Snaps



Bull Snap

Zinc die cast and nickel plated.

PART#	EYE INSIDE DIAMETER	GAP	OVERALL LENGTH	PACKAGE QUANTITY
66330	1"	5/8"	4-1/8"	5



Solid Snap Hook

Forged steel.

PART#	EYE INSIDE DIAMETER	GAP	OVERALL LENGTH	PACKAGE QUANTITY
66331	11/16"	5/8"	3-1/2"	5



Cap Snap

Zinc plated.

PART#	EYE INSIDE DIAMETER	GAP	OVERALL LENGTH	PACKAGE QUANTITY
66332	1"	3/8"	3-5/8"	5



Swivel Eye Snaps

Zinc plated.

PART#	EYE INSIDE DIAMETER	GAP	OVERALL LENGTH	PACKAGE QUANTITY
66334	3/4"	7/16"	3-1/4"	5
66335	7/8"	7/16"	3-1/2"	5



Dog Lead Snap

Zinc plated.

PART#	EYE INSIDE DIAMETER	GAP	OVERALL LENGTH	PACKAGE QUANTITY
66336	3/8"	1/4"	2-1/2"	5



Panic Snap

Zinc plated.

PART#	EYE INSIDE DIAMETER	GAP	OVERALL LENGTH	PACKAGE QUANTITY
66338	1"	1/2"	4-1/16"	5

Sizes are approximate. Specifications subject to change without notice.



General Hardware

Trigger Snaps

Zinc plated.

PART#	EYE INSIDE DIAMETER	GAP	OVERALL LENGTH	PACKAGE QUANTITY
66339	5/8"	1/2"	2-1/2"	5
66344	3/4"	1/2"	2-3/4"	5
66348	3/4"	3/8"	2-1/2"	5
66349	3/4"	1	3-1/2"	5
66350	3/4"	3/4"	3-7/8"	5



Bolt Snaps

Zinc plated.

PART#	EYE INSIDE DIAMETER	GAP	OVERALL LENGTH	PACKAGE QUANTITY
66340	1/2"	11/16"	3-3/8"	5
66343	1/2"	3/4"	3-1/2"	5
66354	1/4"	7/16"	2-1/8"	5
66342	3/8"	7/16"	3-1/2"	5



Bolt Snaps

Solid Brass.

PART#	EYE INSIDE DIAMETER	GAP	OVERALL LENGTH	PACKAGE QUANTITY
66360	1/2"	9/16"	3"	5



Bolt Snaps

Brass.

PART#	EYE INSIDE DIAMETER	GAP	OVERALL LENGTH	PACKAGE QUANTITY
66361	1"	1/2"	3-1/2"	5



Bolt Snaps

Nickel Plated.

PART#	EYE INSIDE DIAMETER	GAP	OVERALL LENGTH	PACKAGE QUANTITY
66366	9/16"	3/4"	3-1/4"	5



Sizes are approximate. Specifications subject to change without notice.



Open Eye Snaps

Zinc Plated.

PART#	EYE INSIDE DIAMETER	GAP	OVERALL LENGTH	PACKAGE QUANTITY
66341	13/16"	1/2"	3-9/16"	5



Loop Snaps

Zinc Plated.

PART#	EYE INSIDE DIAMETER	GAP	OVERALL LENGTH	PACKAGE QUANTITY
66346	3/4"	1/2"	3-1/8"	5
66347	1"	1/2"	2-15/16"	5



Swivel Loop Snaps

Nickel Plated.

PART#	EYE INSIDE DIAMETER	GAP	OVERALL LENGTH	PACKAGE QUANTITY
66352	3/4"	3/8"	3-1/4"	5
66353	1"	3/8"	3-1/4"	5



Open Decoy Snaps

Zinc Die Cast.

PART#	EYE INSIDE DIAMETER	GAP	OVERALL LENGTH	PACKAGE QUANTITY
66355	1/2"	1/4"	2-1/2"	5



Spring Snap

Zinc Die Cast.

PART#	EYE INSIDE DIAMETER	GAP	OVERALL LENGTH	PACKAGE QUANTITY
66351	1"	7/16"	3-1/8"	5

Sizes are approximate. Specifications subject to change without notice.



Baby Square Eye Snaps

PART#	EYE INSIDE DIAMETER	GAP	OVERALL LENGTH	PACKAGE QUANTITY
66365	5/8"	1/4"	1-7/8"	5



Swivel Snaps

Zinc.

PART#	EYE INSIDE DIAMETER	SNAP EYE	OVERALL LENGTH	PACKAGE QUANTITY
66367	1/2"	--	2"	5
66368	5/8"	--	2-7/16"	5
66369	3/4"	--	2-5/8"	5
66370	1"	--	3"	5
66371	3/8"	--	1-3/4"	5
66372	3/8"	11/16"	2-3/8"	5



Lever Snaps

Nickel Plated.

PART#	EYE INSIDE DIAMETER	GAP	OVERALL LENGTH	PACKAGE QUANTITY
66374	5/8"	1/2"	3-1/4"	5
66375	3/4"	7/16"	3-1/2"	5
66376	1"	3/8"	3-1/2"	5
66377	1-1/8"	9/16"	4-7/16"	5



Security Snaps

PART#	EYE INSIDE DIAMETER	GAP	OVERALL LENGTH	PACKAGE QUANTITY
66380	7/8"	9/16"	3-7/8"	5
66381	1"	9/16"	5-1/16"	5



Swivel Security Snaps

PART#	EYE INSIDE DIAMETER	GAP	OVERALL LENGTH	PACKAGE QUANTITY
66394	1"	1"	4-1/8"	5



Eye Bull Snaps

Nickel Plated.

PART#	EYE INSIDE DIAMETER	GAP	OVERALL LENGTH	PACKAGE QUANTITY
66385	3/4"	9/16"	3-3/4"	5



Sizes are approximate. Specifications subject to change without notice.

General Hardware

Snaps • Snap Links



Flat Spring Snap - Simplex

PART#	EYE INSIDE DIAMETER	GAP	OVERALL LENGTH	PACKAGE QUANTITY
66356	1 1/16"	5/16"	4-3/8"	5
66387	1/2"	1/4"	2-3/4"	5



Bronze Animal Snap

PART#	EYE INSIDE DIAMETER	GAP	OVERALL LENGTH	PACKAGE QUANTITY
66392	1"	9/16"	4-1/2"	5



Steel Snap Links

Formed steel with clear zinc plated finish.

PART#	WIRE DIAMETER	GAP	LENGTH	W.L.L.	U.L.L.	PACKAGE QUANTITY
66419	3/16"	1/4"	2"	220 lb	550 lb	10
66420	1/4"	5/16"	2-3/8"	260 lb	650 lb	10
66421	5/16"	3/8"	3-1/8"	500 lb	1,250 lb	10
66422	3/8"	1/2"	4"	770 lb	1,925 lb	10
66425	7/16"	5/8"	4-3/4"	900 lb	2,250 lb	5
66426	1/2"	3/4"	5-3/8"	1,200 lb	3,000 lb	5



Aluminum Snap Links

For decorative and light applications. Multi-coloured.

PART#	WIRE DIAMETER	GAP	LENGTH	PACKAGE QUANTITY
66427	3/16"	1/2"	1-5/16"	10
66428	1/4"	5/8"	2-7/16"	10
66429	5/16"	7/8"	3-1/8"	10



Stainless Steel Snap Links

304 Stainless steel material.

PART#	WIRE DIAMETER	GAP	LENGTH	W.L.L.	PACKAGE QUANTITY
64070	3/16"	1/4"	1-15/16"	100 lb	5
64071	1/4"	5/16"	2-3/8"	140 lb	5
64072	5/16"	3/8"	3-1/8"	250 lb	5
64073	3/8"	1/2"	4"	400 lb	5



Carabiner with Magnet

PART#	BASE DIAMETER	GAP	BREAKAWAY CAPACITY	MATERIAL
66700	1-1/4"	9/16"	75 lbs	Stainless Steel

Sizes are approximate. Specifications subject to change without notice.



General Hardware

Farm Hardware



Quick pins
Safety pins
Hitch pins
Linch pins
Hair pins
Top links



FARM HARDWARE



Farm Hardware



Table of Contents

Weather Caps.....	253
Weather Caps.....	253
Muffler Clamps • Stroke Control	253
Universal Tail Pipe Hanger	253
Muffler Clamps.....	253
Stroke Control Segment Kits.....	253
Stroke Control Segments.....	253
Stroke Control.....	254
Stroke Control Stopper Blocks	254
Cylinder Pins	254
Cylinder Pins	254
Tractor Hooks • Clevises	254
Tractor Drawbar Hook	254
Straight Clevises.....	254
Steering Wheel Spinners	254
Safety Pins • Release Pins	255
Industrial Safety Pins	255
Wire Ring Quick Release Pins.....	255
Quick Release Pins	255
Hitch Pins	255
Hitch Pin - Round Ring Grip.....	255
Hitch Pins - Fold Over Handle With Chain	256
Hitch Pins - Fold Over Handle	256
Hitch Pins - E-Grip	256
High Strength Hitch Pins - Grade 5	257
High Strength Hitch Pins - Grade 8	257
Forged Steel Hitch Pins	258
Lynch Pins • Spring Lock Pins	258
Lynch Pins - Packaged.....	258
Spring Lock Pins.....	258
Quick Pins	259
Round Quick Pins	259
Square Quick Pins	259
Round Tab Type Quick Pins.....	259
Hair Pin Clips.....	260
Hair Pin Clips - Internal	260
Hair Pin Clips - External	260
Bronze Bushings.....	261
Bronze Bushings.....	261
Bushings.....	262
Lift Arm Bushings	262
Top Link Bushings	262
Top Links.....	262
Top Links	262
Top Link Repair Ends	262
Top Link Pins • Lift Arm Pins.....	263
Top Link Pins.....	263
Lift Arm Pins	263
Ratchet Jacks.....	263
Ratchet Jacks.....	263
Document Holders	264
Document Holders	264



Weather Caps

Clear zinc plated steel. Single bolt installation, silencer block, heat resistant rivets and bushings.

PART#	FITS PIPE DIAMETER	PART#	FITS PIPE DIAMETER
11200	1-1/2" – 1-11/16"	11206	3" – 3-3/16"
11201	1-3/4" – 1-15/16"	11207	3-1/2" – 3-11/16"
11202	2" – 2-3/16"	11208	4" – 4-3/16"
11203	2-1/4" – 2-7/16"	11209	4-1/2" – 4-11/16"
11204	2-1/2" – 2-11/16"	11210	5" – 5-1/4"
11205	2-3/4" – 2-15/16"		



Universal Tail Pipe Hanger

PART#	DESCRIPTION
11220	Open end design for use with assembled clamps.



Muffler Clamps

Clear zinc plated. 3/8" (8.3 mm) wire diameter.

PART#	SIZE	PART#	SIZE	PART#	SIZE
11225	1-1/2"	11231	2-1/4"	11236	4"
11226	1-5/8"	11232	2-1/2"	11237	4-1/2"
11227	1-3/4"	11233	2-3/4"	11238	5"
11228	1-7/8"	11234	3"	11239	5-1/2"
11229	2"	11235	3-1/2"	11240	6"
11230	2-1/8"				



Stroke Control Segment Kits

For air & hydraulic cylinders. Cast aluminum alloy.

PART#	FITS SHAFT DIAMETER	SPACER WIDTH (1 EACH)	PACKAGING
55000	1-1/8" to 1-1/4"	3/4", 1", 1-1/4" & 1-1/2"	Clamshell
55001	1-3/8" to 1-1/2"	3/4", 1", 1-1/4" & 1-1/2"	Clamshell
55002	2"	1", 1-1/2", 2", 4-1/4"	Polybag



Stroke Control Segments

PART#	FITS SHAFT DIAMETER	WIDTH	PART#	FITS SHAFT DIAMETER	WIDTH
55003	1-1/8" – 1-1/4"	3/4"	55009	1-3/8" – 1-1/2"	1-1/4"
55004	1-1/8" – 1-1/4"	1"	55011	2"	1"
55005	1-1/8" – 1-1/4"	1-1/4"	55012	2"	1-1/2"
55007	1-3/8" – 1-1/2"	3/4"	55013	2"	2"
55008	1-3/8" – 1-1/2"	1"	55014	2"	4-1/4"



Sizes are approximate. Specifications subject to change without notice.



Farm Hardware

Stroke Control • Cylinder Pins • Tractor Hooks • Clevises



Farm Hardware



Stroke Control Stopper Blocks

PART#	SIZE	FITS SHAFT DIAMETER
56006	1/2"	1" to 1-1/2"
56010	3/8"	1-1/2" to 2"



Cylinder Pins

For air & hydraulic cylinders. Supplied with clips. S.A.E. 1018-1020 carbon steel hot rolled formed. Includes #66311 Hair Pin.

PART#	PIN DIAMETER	USABLE LENGTH
55030	1"	2-3/4"
55031	1"	3"



Tractor Drawbar Hook

Forged steel. Black enamel painted body & zinc plated T-Pin. Supplied with #66305 Hair Pin.

PART#	CHAIN	A	PIN DIAMETER	PIN LENGTH	OVERALL LENGTH	W.L.L.
66040	5/16"-1/2"	1-5/8"	3/4"	3"	7"	9,200 lb

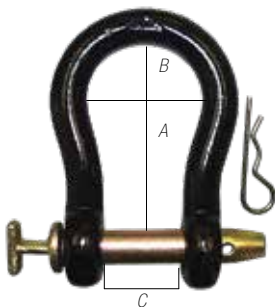

Straight Clevises

Forged steel. Black enamel painted body & zinc plated T-Pin. Supplied with Hair Pin.

PART#	BODY DIAMETER	PIN DIAMETER	A	B	C	W.L.L.	U.L.L.
66029	5/8"	1/2"	3-1/4"	2"	7/8"	6,000 lb	18,000 lb
66030	3/4"	5/8"	3-3/4"	2-1/4"	1-5/16"	12,000 lb	36,000 lb
66031	7/8"	3/4"	4-1/4"	2-3/4"	1-5/16"	16,000 lb	48,000 lb
66032	15/16"	7/8"	4-5/8"	3-1/8"	1-7/16"	20,000 lb	60,000 lb
66033	1"	1"	5-5/16"	3-5/16"	2-1/8"	25,000 lb	75,000 lb



Steering Wheel Spinners

Vinyl coated aluminum knob with chrome plated base. Ball bearing insert for long life. Safe and easy for use with most off-road vehicles.

Not for highway use.

PART#	COLOR	QUANTITY
28327	Red	12 pieces per display box
28329	Black	12 pieces per display box

Sizes are approximate. Specifications subject to change without notice.



Industrial Safety Pins

Oil tempered steel. Clear zinc plated finish.

PART#	WIRE	A	B	PACKAGE QUANTITY
66470	1/8"	3-1/8"	1-1/16"	10
66472	3/16"	3-3/8"	1-1/2"	5
66474	1/4"	5-1/4"	1-3/4"	5
66489	3/32"	1-11/16"	5/8"	10
66490	1/8"	2-13/16"	13/16"	10
66491	3/16"	3"	1-1/2"	5
66492	5/32"	3-3/4"	1-1/8"	5
66493	15/64"	5"	1-5/8"	5
66494	15/64"	5"	2-1/4"	5

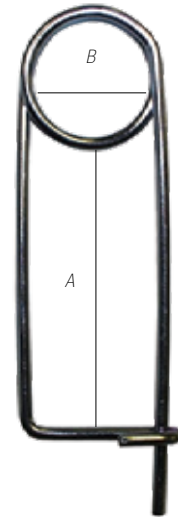

Wire Ring Quick Release Pins

Spring-loaded ball locks pin into place. C-1144 zinc plated carbon steel pin (detent pin).

PART#	A	B	PACKAGE QUANTITY	PART#	A	B	PACKAGE QUANTITY
66499	1/4"	1"	5	66515	3/8"	1-1/2"	5
66500	1/4"	1-1/2"	5	66516	3/8"	2"	5
66501	1/4"	2"	5	66518	3/8"	2-1/2"	5
66503	1/4"	2-1/2"	5	66519	3/8"	3"	5
66505	1/4"	3"	5	66520	3/8"	3-1/2"	5
66507	5/16"	1"	5	66524	1/2"	1"	5
66508	5/16"	1-1/2"	5	66525	1/2"	1-1/2"	5
66509	5/16"	2"	5	66526	1/2"	2"	5
66510	5/16"	2-1/2"	5	66527	1/2"	2-1/2"	5
66511	5/16"	3"	5	66528	1/2"	3"	5
66514	3/8"	1"	5	66530	1/2"	3-1/2"	5

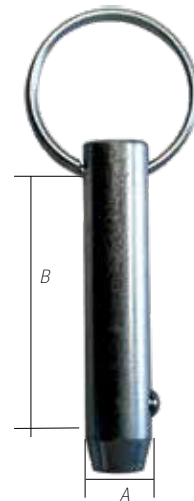

Quick Release Pins

Red vinyl coated, solid handle.

PART#	A	B	PART#	A	B
66760	1/2"	3"	66768	3/4"	1-1/2"
66762	5/8"	1-1/2"	66769	3/4"	2"
66763	5/8"	2"	66770	3/4"	2-1/2"
66764	5/8"	2-1/2"	66771	3/4"	3"
66765	5/8"	3"	66772	3/4"	4"
66767	5/8"	5"	66773	3/4"	5"

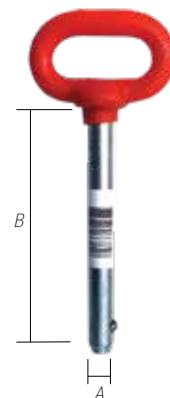

Hitch Pin - Round Ring Grip

S.A.E. 1020 high strength stress-proof steel. Clear zinc plated finish. Supplied with hair pin clip.

PART#	PIN DIAMETER (A)	USABLE LENGTH (B)	MIN. BREAK LOAD	HAIR PIN CLIP
66250	3/8"	3"	10,521 lbs	66301

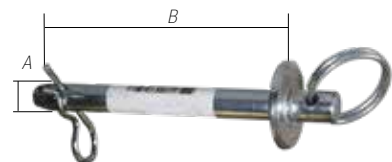

Sizes are approximate. Specifications subject to change without notice.



Farm Hardware

Hitch Pins

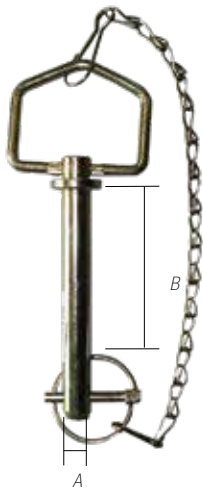

Hitch Pins - Fold Over Handle With Chain

C-1045 stress-proof steel. Heat-treated. Rockwell hardness 25-34 (HRC) Yellow zinc dichromate plated finish. Supplied with 66451 lynch pin & tenso chain.

PART#	PIN DIAMETER (A)	USABLE LENGTH (B)	M.B.L. (MIN. BREAK LOAD)
66280	1/2"	4-1/4"	20,100 lb
66281	5/8"	4-1/4"	28,400 lb
66282	5/8"	6-1/4"	28,400 lb
66283	3/4"	4-1/4"	40,000 lb
66284	3/4"	6-1/4"	40,000 lb
66285	7/8"	6-1/4"	58,364 lb
66286	1"	6-1/4"	81,170 lb
66287	1-1/8"	6-1/4"	97,701 lb
66288	1-1/4"	6-1/4"	124,198 lb



Hitch Pins - Fold Over Handle

C-1045 stress-proof steel. Heat-treated. Rockwell Hardness 25-34 (HRC) Yellow zinc dichromate plated finish. Supplied with hair pin.

PART#	PIN DIAMETER (A)	USABLE LENGTH (B)	M.B.L. (MIN. BREAK LOAD)	HAIR PIN CLIP #
66780	1/2"	4-1/4"	20,100 lb	66303
66781	5/8"	4-1/4"	28,400 lb	66305
66782	5/8"	6-1/4"	28,400 lb	66305
66783	3/4"	4-1/4"	40,000 lb	66302
66784	3/4"	6-1/4"	40,000 lb	66302
66785	7/8"	6-1/4"	58,364 lb	66302
66786	1"	6-1/4"	81,170 lb	66304
66787	1-1/8"	6-1/4"	97,701 lb	66304
66788	1-1/4"	6-1/4"	124,198 lb	66304



Hitch Pins - E-Grip

One piece solid hot forged alloy steel pin and handle. Wider ergonomic handle. Clip pin is included. Bright orange powder coat finish.

PART#	PIN DIAMETER (A)	USABLE LENGTH (B)	HAIR PIN CLIP #
66872	1/2"	3-1/2"	66303
66873	5/8"	3-3/4"	66305
66874	3/4"	4"	66302
66875	5/8"	6"	66305
66876	3/4"	6-1/4"	66302
66877	7/8"	6-1/2"	66304
66878	1"	6-3/4"	66304

Sizes are approximate. Specifications subject to change without notice.



Farm Hardware



High Strength Hitch Pins - Grade 5

S.A.E. 1040 stress-proof steel. Grade 5 specification. Rockwell Hardness 25-34 (HRC). Black powder-coated enamel pin. Red vinyl dipped handle. Supplied with hair pin clip.

PART#	PIN DIAMETER (A)	USABLE LENGTH (B)	STEEL TYPE (S.A.E.)	STEEL GRADE	MIN. BREAK LOAD	HAIR PIN CLIP #
66251	1/2"	3-5/8"	1040	MS	33,586 lb	66303
66252	5/8"	4"	1040	EN-8	38,779 lb	66305
66253	3/4"	4-1/2"	1040	EN-8	38,064 lb	66302
66254	7/8"	4-1/2"	1040	EN-8	47,021 lb	66304
66255	1"	4-1/2"	1040	EN-8	63,814 lb	66304
66256	5/8"	5-1/2"	1040	EN-8	38,779 lb	66305
66257	3/4"	6-1/2"	1040	EN-8	38,064 lb	66302
66258	7/8"	6-1/2"	1040	EN-8	47,021 lb	66302
66259	1"	7-1/2"	1040	EN-8	63,814 lb	66304
66260	1-1/8"	8-1/2"	1040	EN-8	69,412 lb	66304
66261	1-1/4"	8-1/2"	1040	EN-8	75,010 lb	66304
66263	1-1/2"	8-1/2"	1040	EN-8	78,368 lb	66304
66886	1"	12"	1040	EN-8	64,934 lb	66304
66887	1-1/8"	12"	1040	EN-8	73,890 lb	66304
66888	1-1/4"	12"	1040	EN-8	76,129 lb	66304
66889	1-1/2"	13"	1040	EN-8	80,607 lb	66304
66890	1-3/4"	13"	1040	EN-8	85,086 lb	66455 (Linch pin)

MS = Mild Steel

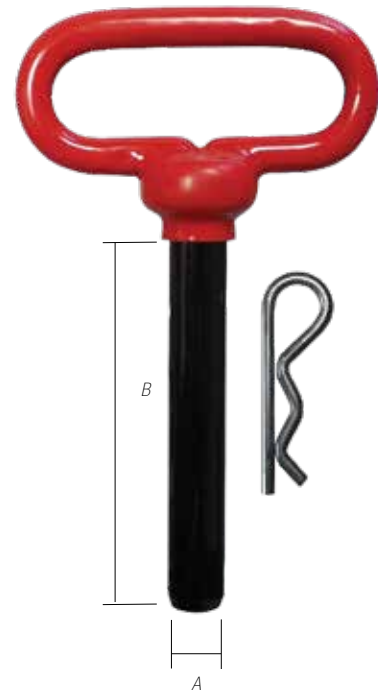

High Strength Hitch Pins - Grade 8

Grade 8 forged blue head hitch pins. Chromium and molybdenum alloy steel and heat treated to Grade 8 specification. Superior black powder coated finish on pin. Blue vinyl coating on head and handle. Hair pin clip is included.

PART#	PIN DIAMETER (A)	USABLE LENGTH (B)	STEEL TYPE (S.A.E.)	STEEL GRADE	MIN. BREAK LOAD	HAIR PIN CLIP #
66860	1/2"	3-5/8"	1040	EN-8	36,945 lb	66303
66861	5/8"	4"	1040	EN-8	38,064 lb	66305
66862	5/8"	6"	1040	EN-8	39,184 lb	66305
66863	3/4"	4"	1040	EN-8	45,901 lb	66302
66864	3/4"	6-1/2"	1040	EN-8	47,021 lb	66302
66865	7/8"	4-1/4"	1040	EN-8	52,619 lb	66304
66866	7/8"	6-1/2"	1040	EN-8	51,499 lb	66304
66867	1"	4-3/4"	1040	EN-8	61,575 lb	66304
66868	1"	7"	1040	EN-8	62,695 lb	66304
66869	1-1/8"	7"	1040	EN-8	72,770 lb	66304
66870	1-1/4"	7"	1040	EN-8	76,129 lb	66304
66871	1-1/2"	8-1/2"	1040	EN-8	80,607 lb	66304

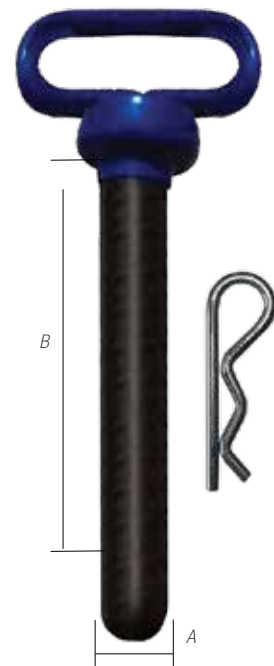

Sizes are approximate. Specifications subject to change without notice.



Farm Hardware

Hitch Pins • Lynch Pins • Spring Lock Pins



Farm Hardware

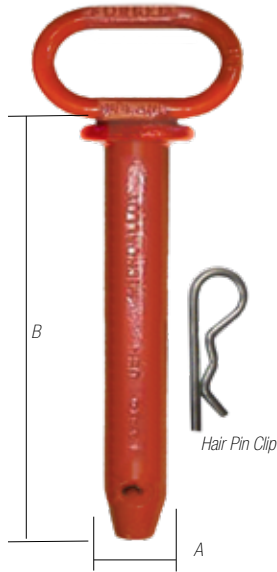

Forged Steel Hitch Pins

Hot forged, heat treated Grade 8, SAE-1541H steel. Solid handle. Bright orange powder coat finish. Supplied with clip. (Sold individually)

PART#	PIN DIAMETER (A)	USABLE LENGTH (B)	STEEL TYPE (S.A.E.)	STEEL GRADE	MIN. BREAK LOAD	COMPATIBLE HAIR PIN CLIP #
66882	1-1/8"	7"	1040	EN-8	73,890 lb	66304
66883	1-1/4"	7"	1040	EN-8	77,249 lb	66304
66884	1-3/8"	7"	1040	EN-8	82,846 lb	66455 (Linch pin)
66885	1-1/2"	8"	1040	EN-8	80,607 lb	66455 (Linch pin)

4 Piece Dynapak

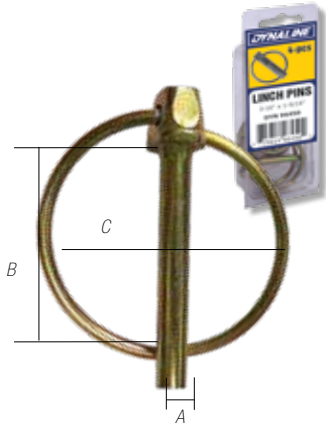

Lynch Pins - Packaged

Forged C-1010 steel pin. Rockwell hardness RA 50-60. Yellow zinc dichromate plated finish. Two package options: 10 piece bag and 4 piece Dynapak.

PART# (10 PIECE BAG)	PART # (4 PIECE DYNAPAK)	PIN DIAMETER (A)	USABLE LENGTH (B)	RING DIAMETER (C)
66450	96450	3/16"	1-1/8"	1-3/8"
66451	96451	1/4"	1-1/2"	1-11/16"
66452	96452	5/16"	1-7/16"	1-3/4"
66453	96453	3/8"	1-7/16"	1-11/16"
66454	96454	7/16"	1-9/16"	1-5/8"
66455	96455	7/16"	1-7/8"	2-1/8"

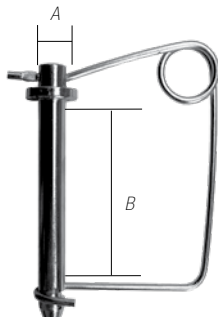

Spring Lock Pins

C-1144 stress-proof steel. Clear zinc plated finish. (Sold Individually)

PART#	PIN DIAMETER (A)	USABLE LENGTH (B)
66244	1/2"	4-1/4"
66245	5/8"	4-1/4"
66246	3/4"	4-1/4"

Sizes are approximate. Specifications subject to change without notice.



Round Quick Pins

C-10105 Grade 5 steel. Clear zinc plated finish. Available in two package types: Bag and Dynapak (quantities in each are seen below)

BAG PACK		DYNAPAK					
PART#	PACKAGE QUANTITY	PART #	PACKAGE QUANTITY	PIN DIAMETER (A)	USABLE LENGTH (B)	C	D
66460	5	96460	2	1/4"	1-3/8"	1-5/8"	1-5/8"
66461	5	96461	2	1/4"	1-3/4"	1-5/8"	2"
66463	5	96463	2	5/16"	1-3/8"	1-5/8"	1-5/8"
66464	5	96464	2	5/16"	1-3/4"	1-5/8"	2"
66466	5	96466	2	3/8"	1-3/8"	1-5/8"	1-5/8"
66469	1	96469	1	5/8"	3-1/8"	2"	3-1/2"

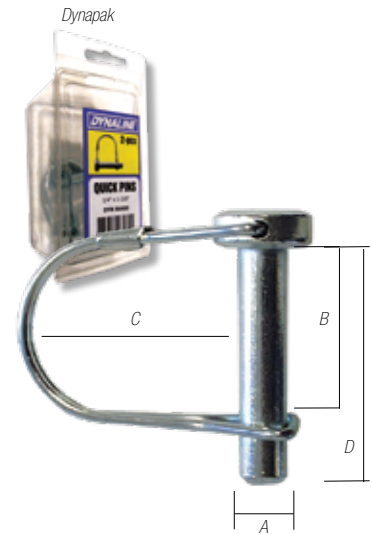

Square Quick Pins

BAG PACK		DYNAPAK					
PART#	PACKAGE QUANTITY	DYNAPAK	PACKAGE QUANTITY	PIN DIAMETER (A)	USABLE LENGTH (B)	C	D
66462	5	96462	2	1/4"	2-1/2"	1-5/8"	2-3/4"
66465	5	96465	2	5/16"	2-1/2"	1-5/8"	2-3/4"
66467	5	96467	2	3/8"	2-1/4"	1-5/8"	2-1/2"
66468	5	96468	2	3/8"	2-1/2"	1-5/8"	2-3/4"

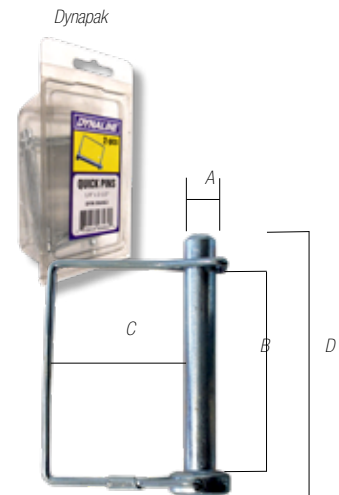

Round Tab Type Quick Pins

Easier to use than standard wire lock pins. C-1010 steel. Clear zinc plated finish.

PART#	PACKAGE QUANTITY	PIN DIAMETER (A)	USABLE LENGTH (B)	C	D
66531	5	1/4"	1-5/8"	1-5/8"	2-1/8"
66532	5	1/4"	2"	1-5/8"	2-3/16"
66533	5	1/4"	2-3/4"	1-5/8"	3-1/8"
66534	5	5/16"	1-5/8"	1-5/8"	2-1/8"
66535	5	5/16"	2"	1-5/8"	2-3/16"
66536	5	5/16"	2-3/4"	1-5/8"	3-1/8"
66537	5	3/8"	1-5/8"	1-5/8"	2-1/2"
66538	5	3/8"	2-1/2"	1-5/8"	2-11/16"
66539	5	3/8"	2-3/4"	1-5/8"	3-1/8"

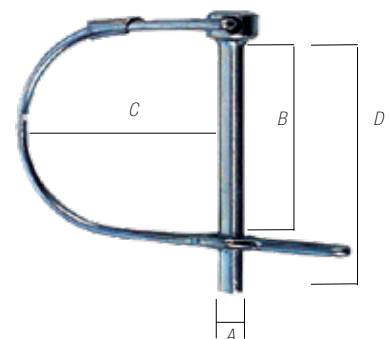

Sizes are approximate. Specifications subject to change without notice.



Farm Hardware

Hair Pin Clips

Hair Pin Clips - Internal

Oil tempered MB spring wire. Clear zinc plated finish. Available in two package types: Bag and Dynapak (quantities in each are seen below)

BAG PACK		DYNAPAK		IND.#	WIRE DIAMETER	DRILL HOLE SIZE	MIN. SHAFT DIAMETER	MAX. SHAFT DIAMETER	OVERALL LENGTH	INSIDE EYE DIAMETER
PART#	PACKAGE QUANTITY	PART #	PACKAGE QUANTITY							
66300	25	96300	10	22	1/16"	5/64"	1/4"	1/2"	1-3/8"	1/4"
66301	25	96301	10	3	3/32"	7/64"	1/4"	1/2"	1-11/16"	7/16"
66302	25	96302	4	6	3/16"	3/16"	5/8"	1"	3-1/4"	7/8"
66303	25	96303	10	7	3/32"	7/64"	3/8"	5/8"	2-5/16"	5/8"
66304	25	96304	5	8	3/16"	3/16"	7/8"	1-1/4"	3-3/4"	7/8"
66305	25	96305	5	9	5/32"	5/32"	3/4"	1-1/8"	3-5/16"	3/4"
66306	25	96306	5	11	1/8"	9/64"	7/16"	3/4"	2-5/8"	9/16"
66307	25	96307	10	16	1/8"	9/64"	1/2"	3/4"	2"	1/2"
66308	10	96308	3	19	1/4"	17/64"	3/4"	1"	4-1/4"	3/4"
66309	25	NA	10	1	5/32"	5/32"	1/2"x5/8"	5/8"x1"	3"	1/2"
66310*	25	NA	10	2	1/8"	9/64"	3/4"	1-1/8"	3-1/4"	1"
66313	25	NA	4	4	11/64"	3/16"	1/2"x3/4"	5/8"x1"	3"	5/8"
66317	25	NA	10	17	3/32"	3/32"	3/8"	1/2"	1-9/16"	5/16"
66318	25	NA	5	18	1/16"	5/64"	3/8"	1/2"	1-9/16"	5/16"
66320	10	NA	5	20	5/16"	21/64"	7/8"	1"	4"	7/8"
66325	25	NA	5	25	5/64"	5/64"	5/16"	3/8"	1-3/32"	9/64"
66326	25	NA	10	10	5/32"	5/32"	5/8"	1"	2-15/16"	3/4"
66328	25	NA	3	14	3/32"	7/64"	1/2"	3/4"	2-1/2"	5/8"

*66310 - Rounded head, see image below.

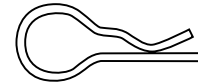

Reference Chart Available

See end of catalogue



Hair Pin Clips - External

Oil tempered MB spring wire. Clear zinc plated finish. Available in two package types: Bag and Dynapak (quantities in each are seen below)

BAG PACK		DYNAPAK		IND.#	WIRE DIAMETER	OVERALL LENGTH	INSIDE EYE DIAMETER
PART#	PACKAGE QUANTITY	DYNAPAK	PACKAGE QUANTITY				
66311	25	96311	5	7XX	7/64"	2-1/16"	7/16"
66312	25	96312	4	10X	11/64"	2-5/8"	3/4"

Sizes are approximate. Specifications subject to change without notice.



Farm Hardware





Bronze Bushings

S.A.E. 841 Bronze material. Oil impregnated.

PART#	THICKNESS	INNER DIAMETER	OUTER DIAMETER	LENGTH	PART#	THICKNESS	INNER DIAMETER	OUTER DIAMETER	LENGTH
55300	1/32"	1/4"	5/16"	3/4"	55326	1/16"	7/8"	1"	1-1/4"
55301	1/16"	1/4"	3/8"	1"	55327	1/8"	7/8"	1-1/8"	1-1/4"
55302	3/32"	1/4"	7/16"	1"	55328	3/16"	7/8"	1-1/4"	1-1/4"
55303	1/8"	1/4"	1/2"	1"	55329	5/32"	15/16"	1-1/4"	1-1/4"
55304	1/32"	5/16"	3/8"	1"	55330	1/8"	1"	1-1/4"	1-1/2"
55305	1/16"	5/16"	7/16"	1"	55331	3/16"	1"	1-3/8"	1-1/2"
55306	1/16"	3/8"	1/2"	1"	55332	1/4"	1"	1-1/2"	1-1/2"
55307	1/8"	3/8"	5/8"	1"	55333	1/8"	1-1/16"	1-5/16"	1-1/2"
55308	3/16"	3/8"	3/4"	1"	55334	1/16"	1-1/8"	1-1/4"	1-1/2"
55309	1/16"	7/16"	9/16"	1"	55335	1/8"	1-1/8"	1-3/8"	1-1/2"
55310	3/32"	7/16"	5/8"	1"	55336	3/16"	1-1/8"	1-1/2"	1-1/2"
55311	1/16"	1/2"	5/8"	1"	55337	1/8"	1-3/16"	1-7/16"	1-1/2"
55312	3/32"	1/2"	11/16"	1"	55338	5/32"	1-3/16"	1-1/2"	1-1/2"
55313	1/8"	1/2"	3/4"	1"	55339	1/8"	1-1/4"	1-1/2"	1-1/2"
55314	5/32"	1/2"	13/16"	1"	55340	3/16"	1-1/4"	1-5/8"	1-1/2"
55315	3/16"	1/2"	7/8"	1"	55341	1/8"	1-3/8"	1-5/8"	1-1/2"
55316	3/32"	9/16"	3/4"	1"	55342	3/16"	1-3/8"	1-3/4"	1-1/2"
55317	1/8"	9/16"	13/16"	1"	55343	5/32"	1-7/16"	1-3/4"	1-1/2"
55318	1/16"	5/8"	3/4"	1-1/4"	55344	1/8"	1-1/2"	1-3/4"	1-1/2"
55319	3/32"	5/8"	13/16"	1-1/4"	55345	3/16"	1-1/2"	1-7/8"	1-1/2"
55320	1/8"	5/8"	7/8"	1-1/4"	55346	3/16"	1-5/8"	2"	1-1/2"
55321	3/16"	5/8"	1"	1-1/4"	55347	1/8"	1-3/4"	2"	1-1/2"
55322	1/16"	3/4"	7/8"	1-1/4"	55348	3/16"	1-3/4"	2-1/8"	1-1/2"
55323	3/32"	3/4"	15/16"	1-1/4"	55349	3/16"	2"	2-1/4"	1-1/2"
55324	1/8"	3/4"	1"	1-1/4"	55350	3/16"	2"	2-3/8"	1-1/2"
55325	3/32"	13/16"	1"	1-1/4"					

Sizes are approximate. Specifications subject to change without notice.



Farm Hardware

Bushings • Top Links



Lift Arm Bushings

Carbon steel. Yellow zinc dichromate plated finish.

PART#	REFERENCE#	CATEGORY	INSIDE DIAMETER	OUTSIDE DIAMETER	OVERALL LENGTH
66608	0351	1 to 2	7/8"	1-1/8"	1-3/4"
66610	3009	2 to 3	1-1/8"	1-7/16"	1-3/4"
66612	3010	2 to 3	1-1/8"	1-7/16"	2-1/2"



Top Link Bushings

Carbon steel. Yellow zinc dichromate plated finish.

PART#	REFERENCE#	CATEGORY	INSIDE DIAMETER	OUTSIDE DIAMETER	OVERALL LENGTH
66602	0353	1 to 2	3/4"	1"	2"
66604	3008	2 to 3	1"	1-1/4"	2"



Top Links

Carbon steel, forged & welded. With grease fitting, nut welded. Yellow zinc dichromate plated finish. UNC Coarse Thread.

PART#	REFERENCE#	CATEGORY	HOLE DIAMETER	THREAD DIAMETER	ADJUSTMENT
66619	480	0	5/8"	3/4"	11" – 16"
66620	331	1	3/4"	1-1/8"	21" – 31"
66621	338	1 & 2	3/4" & 1"	1-1/8" & 1-1/4"	21" – 32"
66622	337	2	1"	1-1/8"	25" – 36"
66624	336	2	1"	1-1/8"	21" – 32"
66619EM	--	0	5/8"	3/4"	11" – 16"
66619EA	--	0	5/8"	1-1/8"	9-1/2" - 9-1/2"



66619EM



66619EA

Top Link Repair Ends

Carbon steel, forged & welded. Yellow zinc dichromate plated finish. UNC Coarse Thread.

PART#	REFERENCE#	CATEGORY	HOLE DIAMETER	THREAD DIAMETER	THREAD LENGTH
66625	342	1	3/4"	1-1/8" LH	6"
66626	343	1	3/4"	1-1/8" RH	6"
66627	346	2	1"	1-1/8" LH	6-1/2"
66628	347	2	1"	1-1/8" RH	6-1/2"



Sizes are approximate. Specifications subject to change without notice.



Farm Hardware



Ratchet Jack

Heavy duty. Replace hydraulic cylinders or old screw jacks in those applications where infrequent adjustment is needed. Clip pins and handle included.

PART#	A	B	C	THREAD DIAMETER	LENGTH CLOSED	LENGTH EXTENDED
66642	1-1/2"	1"	2-3/4"	1-1/4"	20"	28"



Top Link Pins

Carbon steel, forged & welded. Yellow zinc dichromate plated finish. UNC Coarse Thread.

PART#	REFERENCE#	CATEGORY	PIN DIAMETER	USABLE LENGTH	OVERALL LENGTH
66560	73	1	3/4"	2-3/4"	4-1/2"
66561	74	1	3/4"	3-7/8"	5-1/2"
66562	76	2	1"	3-9/16"	5-1/4"
66563	7715	1	3/4"	4-3/4"	6-3/8"
66565	3011	2	1"	4-5/16"	6"
66566	7711	3	1/4"	4-5/8"	6-1/2"
66567	7706	0	5/8"	3"	4-7/16"



Lift Arm Pins

Carbon steel. Yellow zinc dichromate plated finish.

PART#	REFERENCE#	CATEGORY	PIN DIAMETER	THREAD DIAMETER	USABLE LENGTH	OVERALL LENGTH
66580	200	1	7/8"	7/8"	2-1/4"	5-1/2"
66581	3000	1	7/8"	7/8"	Adjustable	6-1/4"
66582	3004	1	7/8"	7/8"	2-1/4"	6-1/2"
66583	3001	1 to 2	1-1/8"	7/8"	Adjustable	5-3/16"
66584	7243	2 to 3	1-7/16"	1-1/8" NF*	1-7/8"	5-3/4"
66585	202	1 to 2	1-1/8"	7/8"	1-3/4"	5-1/4"
66586	7249	1 to 2	1-1/16"	1" NF*	1-1/8"	8"
66587	3022	2 to 1	7/8"	1-1/8"	1-3/4"	5-3/4"
66588	3006	2	1-1/8"	1-1/8"	1-3/4"	6-1/4"
66589	3002	2	1-1/8"	1-1/8"	Adjustable	6-1/4"
66590	211	1	7/8"	7/8"	Adjustable	5-5/16"
66591	7220	0	5/8"	5/8" NF*	Adjustable	3-7/8"
66592	7246	1 to 2	1-1/8"	7/8" NF*	2-1/4"	6-5/16"



*NF - National Fine

Sizes are approximate. Specifications subject to change without notice.



Farm Hardware

Document Holders



17720



17731



17740

Document Holder (Plastic)

Molded from high density polypropylene, weather and impact resistant. Protects documents from damage. Mounts onto machines for easy access. O-Ring sealed. Screw top lid.

PART#	DESCRIPTION
17720	2" diameter x 12-1/2" long
17730	3-1/4" diameter x 12-1/2" long
17731	Plastic tether that prevents lid loss on manual holders. Simply drill 5/16" hole in center of lid to attach one end of tether.

Document Holder (Aluminum)

Made from corrosion resistant aluminum, Protects documents from the elements.

PART#	DESCRIPTION
17740	1.5" inside diameter x 9" long
17740-1	Rubber cap replacement for 17740



Dynaline offers merchandisers for almost every product. If you are ordering Farm Hardware products then you may be interested in the following Merchandiser. For more information on this merchandiser see the Merchandising Section at the front of the catalogue.

Pins Merchandiser

PART#	CONTENTS
00557	Pins Display Board Only , 24" x 24"
00557K	Full Pins Merchandiser. Includes 00557 display board and 53 pegs and the most popular products.

Hitch Pins Merchandiser

PART#	CONTENTS
00435	Hitch Pins Display Board Only , 24" x 24"
00435K	Full Hitch Pins Merchandiser. Includes 00435 display board and 23 pegs and the most popular products.

Farm packs Merchandiser

PART#	CONTENTS
00620	Farm Packs Display Board Only , 24" x 24"
00620K	Full Farm Packs Merchandiser. Includes 00620 display board and 37 pegs and the most popular products.



Sizes are approximate. Specifications subject to change without notice.



Farm Hardware



Shop Supplies



- Hose reels
- Chain hoist
- Level hoist
- Beam clamps
- Caster wheels
- Wheels
- Springs
- Retainer rings
- Hose reel
- Jack stands
- Snatch blocks
- Cable pullers



SHOP SUPPLIES



Shop Supplies



Table of Contents

Hose Reels • Jack Stands.....	267
Air Hose Reels - Heavy Duty Steel Frame	267
Industrial Hose Reel	267
Retractable Hose Reel - Silver Series	267
Dual Bracket Heavy Duty Grease Hose Reel.....	267
Replacement Parts for Hose Reels	267
Pulleys	268
Standard Single Pulley Block	268
Standard Double Pulley Block	268
Single Pulley Block With Eye.....	268
Jack Stands	267
Jack Stands	268
Snatch Blocks.....	269
Heavy Duty Snatch Block With Hook	269
Heavy Duty Snatch Block With Shackle	269
Heavy Duty Snatch Block Tail Boards.....	269
Trolleys • Beam Clamps • Cable Pullers ...	269
Trolleys	269
Beam Clamps	269
Cable Pullers	269
Hoists.....	270
Lever Hoists	270
Chain Hoists	270
Replacement Wheels	271
Pneumatic Wheel	271
Flat Free Wheels	271
Semi-Pneumatic Wheel	271
Replacement Bearings For Wheels	271
Caster Wheels.....	272
Caster Wheels With Rigid Top Plate	272
Caster Swivel Wheels	272
Caster Wheel With Side Locking Brake	272
Pneumatic Caster Wheel With Rigid Top Plate.....	273
Pneumatic Caster Swivel Wheel.....	273
Flat Free Caster Wheel With Rigid Top Plate.....	273
Flat Free Caster Swivel Wheel.....	273
Wheel Merchandisers	274
Wheel Rack Merchandiser.....	274
Keystocks	275
Square Keystock.....	275
Rectangular Keystock.....	275
Step Keystock	275
Clevis Pins	276
Clevis Pins	276
Clevis Pin Dynapaks.....	276
Adjustable Clevis Pins	276
Machinery Bushings.....	277
Machinery Bushings	277
Bulk Springs Merchandiser	278
Bulk Springs Merchandiser.....	278 - 279
Extension Springs.....	280
Packaged Extension Springs.....	280 - 282
Drawbar Spring	282
Drawbar Spring	282
Compression Springs.....	283
Packaged Compression Springs	283- 285
E-Retainer Rings.....	286
E Retainer Rings	286
Internal Retainer Rings.....	287
Internal Retainer Rings	287
External Retainer Rings.....	288
External Retainer Rings (Basic)	288



Air Hose Reels - Heavy Duty Steel Frame

Corrosion resistant powder coat finish. Features spring tension brake and solid brass swivel. Mounts on floor, wall or workbench.

PART#	REEL CAPACITY	HOSE DIAMETER	INLET DIAMETER	HOUSE OUTLET
11362	100 ft.	3/8"	3/8" NPT	3/8" NPT
11363	50 ft.	3/8"	3/8" NPT	3/8" NPT



11363

Industrial Hose Reel

Heavy duty steel assembly. Corrosion resistant powder coat finish. Ratchet gear locks reel at desired hose length. 3/8" heavy duty industrial grade rubber hose. Use for **air and water**, 3/8" NPT brass fitting.

PART#	HOSE LENGTH	HOSE DIAMETER	MAXIMUM PRESSURE	COLOUR
11369	50 ft.	3/8"	300 PSI	Red
11371	100 ft.	3/8"	300 PSI	Black & Yellow



Retractable Hose Reel - Silver Series

Auto rewind, heavy duty steel assembly. Powder coated finish. Self locking mechanism, heavy duty springs. Robust for commercial use. Industrial grade hose for **water, oil and air**.

PART#	HOSE LENGTH	HOSE DIAMETER	MAXIMUM PRESSURE
11359	35 ft.	1/4"	300 PSI
11360	50 ft.	3/8"	300 PSI
11361	50 ft.	1/2"	300 PSI



11359

Dual Bracket Heavy Duty Grease Hose Reel

Heavy duty **grease** hose reel with 1/4" hose diameter and a 50' hose length. It features a heavy duty spring and gauge for retraction.

PART#	HOSE LENGTH	HOSE DIAMETER	MAXIMUM PRESSURE
11373	50 ft.	1/4"	5,000 PSI



Replacement Parts for Hose Reels

PART#	DESCRIPTION	FOR SERIES	PART#	DESCRIPTION	FOR SERIES
11359-1	1/4" Hose stopper	11359	11359-3	1/4" FNPT swivel	11359,11360
11369-1	3/8" Hose stopper	11360,11369,11371	11361-2	1/2" FNPT swivel	11361
11361-1	1/2" Hose stopper	11361	11369-4	LD Locking pawl accessory	11369
11369-2	4-way Roller bracket assembly	11369	11371-2	LD Locking pawl accessory	11371
11371-1	4-way roller bracket assembly	11371	11359-4	HD Locking pawl accessory	11359,11360,11361
11359-2	4-way roller bracket assembly	11359	11373-1	1/4" NPT Swivel replacement	11373
11360-1	4-way roller bracket assembly	11360	11373-2	Hose roller guide accessories	11373
11369-3	1/4" FNPT swivel	11369,11371	11373-3	1/4" Hose stopper	11373
11362-1	3/8" FNPT swivel	11362,11363			

Sizes are approximate. Specifications subject to change without notice.





Standard Single Pulley Block

PART#	SIZE	W.L.L.	ROPE DIAMETER	OVERALL LENGTH	DESCRIPTION
80335	3"	1/2 Ton	8 mm (5/16")	11"	Loop, Safety Latch, Access Latch & Grease Fitting



Standard Double Pulley Block

PART#	SIZE	W.L.L.	ROPE DIAMETER	OVERALL LENGTH	DESCRIPTION
80350	3"	1/2 Ton	8 mm (5/16")	11"	Loop
80355	4"	1 Ton	10 mm (3/8")	13"	Loop

80350



Single Pulley Block With Eye

PART#	SIZE	W.L.L.	ROPE DIAMETER	OVERALL LENGTH	DESCRIPTION
80360	3"	1/2 Ton	8 mm (5/16")	11"	Eye, Access Latch, Safety Latch & Grease Fitting

80360



Access Latch



Grease Fitting



Jack Stands

Made of A3 steel. Meets ANSI 2009 Specs. Powder coated finish. Ratchet locking gear. Ideal for auto, home, and shop. 2 per box.

PART#	CAPACITY	ADJUSTABLE HEIGHTS	BASE DIMENSIONS
11548	6,000 lb/ea. stand	11-7/32" to 16-7/8"	7-5/8" x 6-7/8"
11549	13,200 lb/ea. stand	15-1/2" to 23-3/4"	10-13/16" x 9-5/8"
11550	26,400 lb/ea. stand	19-3/8" to 28-1/8"	11-1/2" x 12-5/8"

Sizes are approximate. Specifications subject to change without notice.



Heavy Duty Snatch Block With Hook

PART#	PULLEY DIAMETER	ROPE DIAMETER	W.L.L.	TON
80270	3"	3/8"	4,000 lb	2
80271	4-1/2"	1/2"	8,000 lb	4
80272	6"	3/4"	16,000 lb	8
80273	8"	3/4"	16,000 lb	8



Heavy Duty Snatch Block With Shackle

PART#	PULLEY DIAMETER	ROPE DIAMETER	W.L.L.	TON
80280	3"	3/8"	4,000 lb	2
80281	4-1/2"	1/2"	8,000 lb	4
80282	6"	3/4"	16,000 lb	8
80283	8"	3/4"	16,000 lb	8



Heavy Duty Snatch Block Tail Boards

PART#	PULLEY DIAMETER	ROPE DIAMETER	W.L.L.	TON
80290	3"	3/8"	4,000 lb	2
80291	4-1/2"	1/2"	8,000 lb	4
80292	6"	3/4"	16,000 lb	8
80293	8"	3/4"	16,000 lb	8



Trolleys

Rugged steel construction. Lifetime lubricated & sealed bearings. Proof tested and certified. Built-in bumper guards. Use on straight or curved tracks. Adjustable to various beams.

PART#	CAPACITY	BEAM WIDTH
80301	1 Ton	2-15/16 - 4-15/16"
80302	2 Ton	3-15/16 - 5-15/16"
80303	3 Ton	3-15/16 - 5-15/16"
80305	5 Ton	4-15/16 - 6-7/8"



Beam Clamps

Rugged steel construction. Proof tested & certified. Use on straight or curved tracks. Adjustable to various beams.

PART#	CAPACITY	BEAM WIDTH
80320	1 Ton	2-15/16 - 8-11/16"
80321	2 Ton	3-1/8 - 12-5/8"
80322	3 Ton	3-1/8 - 12-5/8"
80323	5 Ton	3-9/16 - 12-5/8"



Cable Pullers

Designed to lift, stretch, lower or pull heavy loads. Features double ratchet wheel brake system, and hooks with safety latches. Snatch block included.

PART#	SAFE WORKING CAPACITY	MAX. RATED CAPACITY	HOOK SIZE	CABLE DIAMETER	CABLE LENGTH	WEIGHT
11351	1/2 Ton	1 Ton	3/8"	5/32"	6.0 ft.	1.9 kg
11352	1 Ton	2 Ton	3/8"	5/32"	7.21 ft.	2.5 kg
11354	2 Ton	4 Ton	5/16"	7/32"	9.84 ft.	5.2 kg



Sizes are approximate. Specifications subject to change without notice.



Lever Hoists

Lightweight, compact and portable. Impact-resistant, rugged steel body construction. Features short, low effort, 360°rotating handle. Equipped with Easy Free chain, Latch-type swivel hooks, and high-tensile alloy chain.

PART#	RATED CAPACITY (TONS)	CHAIN DIA	LIFT	MINIMUM CLEARANCE	LENGTH	TEST LOAD (TONS)	REPLACEMENT HOOKS TOP PART#	REPLACEMENT HOOKS BOTTOM PART#
80259	1/4	3/16"	59"	10-5/8"	10-13/32"	1-5/8	80259-1	80259-2
80260	1/2	3/16"	59"	10-5/8"	10-13/32"	1-5/8	80260-1	80260-2
80261	3/4	7/32"	59"	11-13/32"	10-7/16"	1-1/8	80261-1	80261-2
80262	1	1/4"	59"	12-13/16"	10-7/16"	1-1/2	80262-1	80262-2
80263	1-1/2	9/32"	59"	14-3/16"	16-1/8"	2-1/4	80263-1	80263-2
80264	3	11/32"	59"	18-1/2"	16-1/8"	4-1/2	80264-1	80264-2

Chain Hoists

Lightweight, compact and portable. Impact-resistant, rugged steel body construction. Features short, low effort, 360°rotating handle. Equipped with Easy Free chain, Latch-type swivel hooks, and high-tensile alloy chain.

- *Steel Formed Case to protect both gear and hand chain wheel slides against external shock.*
- *Double Cover Protection to stop moisture and dirt from entering into the hand chain wheel case and the brake cover.*
- *Break Mechanism will activate instantly when operation is stopped, whether the load is light or heavy.*
- *Double Ratchet Pawls for extra safety. Should one pawl fail, the other restrains the load.*
- *Powder Metal Bushing to increase mechanical efficiency and reduce the hand chain pull strength.*
- *Load Chain Guide & Stripper to assure proper fit of load chain to load sheave. Also protects against dirt and moisture gathering in the load sheave.*
- *Slack End Anchorage that serves as a limit stopper to prevent any accidents caused by over-lowering heavy loads.*
- *Grade 80 Alloy Load Chain specially calibrated for hand chain block usage. All of the load chain meets or exceeds ISO and DIN standards.*
- *Hot forged, heat treated, swivel hooks with safety latches to ensure proper hooking to the load or sling.*



80251

PART#	STANDARD RATED W.L.L.	LIFT	HEADROOM	HANDLE EFFORT	TEST LOAD (TONS)	REPLACEMENT HOOKS TOP	REPLACEMENT HOOKS BOTTOM
80250	1/2 Ton	8.2'	10-3/4"	48 lb	3/4	80260-1	80260-2
80251	1 Ton	8.2'	11-3/4"	57 lb	1-1/2	80262-1	80262-2
80252	1-1/2 Ton	9.8'	14-3/4"	66 lb	2-1/4	80263-1	80263-2
80253	2 Ton	9.8'	14-3/4"	77 lb	3	80264-1	80264-2
80254	3 Ton	9.8'	20-3/4"	77 lb	4-1/2	---	---

Sizes are approximate. Specifications subject to change without notice.





Pneumatic Wheel

Rugged steel construction. Proof tested & certified. Use on straight or curved tracks. Adjustable to various beams. **Axel bore is 5/8" (except Part# 80117 which has an axle bore of 3/4").**

PART#	TIRE SIZE	HUB WIDTH	WHEEL DIA.	TIRE WIDTH	RIM DIA.	HUB TYPE	TREAD PATTERN	LOAD RATING
80101	2.50-4	1.75"	8.5"	2.275"	4.8"	Offset	Lug	180 lb
80105	4.10/3.50-4	2.28"	10"	3.25"	4.9"	Offset	Sawtooth	280 lb
80109	3.00-4	1.53"	10"	3"	4.8"	Offset	Diamond	260 lb
80113	5.00-6	3.15"	13"	4.45"	6.79"	Offset	Jag	390 lb
80116	4.80/4.00-8	6"	15.08"	3.66"	8.8"	Center	Smooth	390 lb
80117	4.80/4.00-8	6"	15.08"	3.66"	8.8"	Center	Smooth	390 lb



Flat Free Wheels

Axle bore size is 5/8". Steel rims. Tubeless. Comes with bearings and grease zerks.

PART#	TIRE SIZE	HUB WIDTH	WHEEL DIA.	TIRE WIDTH	RIM DIA.	HUB TYPE	TREAD PATTERN	LOAD RATING
80102	2.50-4	1.75"	8.5"	2.275"	4.8"	Offset	Lug	160 lb
80107	4.10/3.50-4	2.28"	10"	3.25"	4.9"	Offset	Jag	260 lb
80111	3.00-4	1.53"	10"	3"	4.8"	Offset	Diamond	240 lb
80112	3.00-4	2.59"	10"	3"	4.8"	Center	Diamond	240 lb
80115	5.00-6	3.15"	13"	4.45"	6.79"	Offset	Jag	370 lb
80118	4.80/4.00-8	6"	15"	3.66"	8.8"	Center	Smooth	370 lb



Semi-Pneumatic Wheel

Semi-pneumatic wheel with a durable plastic lightweight rim and hub. Axle bore size is 1/2".

PART#	TIRE SIZE	HUB WIDTH	WHEEL DIA.	TIRE WIDTH	RIM DIA.	HUB TYPE	TREAD PATTERN	LOAD RATING
80229	4.10/3.50-4	2.28"	10"	3.25"	4.67"	Offset	Jag	260 lb



Replacement Bearings For Wheels

PART#	AXLE BORE DIAMETER	OUTSIDE DIAMETER
80121	5/8"	1-15/32"
80122	1/2"	1-15/32"
80123	3/4"	1-15/32"



Sizes are approximate. Specifications subject to change without notice.





Castor Wheels With Rigid Top Plate

For general use in hardware, factory and warehouse. Strong, durable, economical. Corrosion resistant zinc finish. Hard rubber wheels, black.

PART#	WHEEL DIA.	WHEEL WIDTH	OVERALL HEIGHT	AXLE SIZE	MOUNTING HOLE DIA.	LOAD RATING (LB)	PLATE SIZE (IN.)
31015	1-1/2"	7/8"	2"	1/4"	1/4"	77 lb	2-3/8" x 1-1/2"
31020	2"	1"	2-1/2"	1/4"	1/4"	110 lb	1-6/8" x 2-5/8"
31025	2-1/2"	1-1/8"	3-3/16"	5/16"	5/16"	165 lb	2-1/8" x 3-6/8"
31030	3"	1-1/4"	3-13/16"	3/8"	5/16"	210 lb	2-1/2" x 4"
31040	4"	1-5/16"	5"	7/16"	3/8"	240 lb	2-1/4" x 5"
31050	5"	1-1/4"	6-3/16"	3/8"	5/16"	220 lb	3-5/8" x 2-1/2"
31060	6"	2"	7-1/2"	15/32"	7/16"	660 lb	4-1/2" x 4"
31080	8"	2"	9-1/2"	15/32"	7/16"	700 lb	4-1/2" x 4"

Castor Swivel Wheels

For general use in hardware, factory and warehouse. Strong, durable, economical. Corrosion resistant zinc finish. Hard rubber wheels, black.



PART#	WHEEL DIA.	WHEEL WIDTH	OVERALL HEIGHT	AXLE SIZE	MOUNTING HOLE DIA.	LOAD RATING (LB)	PLATE SIZE (IN.)
32015	1-1/2"	7/8"	2"	1/4"	1/4"	77 lb	2-3/8" x 1-3/4"
32020	2"	1"	2-1/2"	1/4"	1/4"	110 lb	1-7/8" x 2-9/16"
32025	2-1/2"	1-1/8"	3-3/16"	5/16"	5/16"	165 lb	2-3/4" x 3-13/16"
32030	3"	1-1/4"	3-13/16"	3/8"	5/16"	210 lb	3-1/8" x 4-1/8"
32040	4"	1-5/16"	5"	7/16"	3/8"	240 lb	4" x 5-1/8"
32050	5"	1-1/4"	6-3/16"	3/8"	5/16"	220 lb	3-5/8" x 2-1/2"
32060	6"	2"	7-1/2"	15/32"	7/16"	660 lb	4-1/2" x 4"
32080	8"	2"	9-1/2"	15/32"	7/16"	700 lb	4-1/2" x 4"

Castor Wheel With Side Locking Brake

For general use in hardware, factory and warehouse. Strong, durable, economical. Corrosion resistant zinc finish. Hard rubber wheels, black.



PART#	WHEEL DIA.	WHEEL WIDTH	OVERALL HEIGHT	AXLE SIZE	MOUNTING HOLE DIA.	LOAD RATING (LB)	PLATE SIZE (IN.)
33015	1-1/2"	7/8"	2"	1/4"	1/4"	77 lb	2-3/8" x 1-3/4"
33020	2"	1"	2-1/2"	1/4"	1/4"	110 lb	1-7/8" x 2-9/16"
33025	2-1/2"	1-1/8"	3-3/16"	5/16"	5/16"	165 lb	2-3/4" x 3-13/16"
33030	3"	1-1/4"	3-13/16"	3/8"	5/16"	210 lb	3-1/8" x 4-1/8"
33040	4"	1-5/16"	5"	7/16"	3/8"	240 lb	4 x 5-1/8"
33050	5"	1-1/4"	6-3/16"	3/8"	5/16"	220 lb	3-5/8" x 2-1/2"
33060	6"	2"	7-1/2"	15/32"	7/16"	660 lb	4-1/2" x 4"
33080	8"	2"	9-1/2"	15/32"	7/16"	700 lb	4-1/2" x 4"

Sizes are approximate. Specifications subject to change without notice.



Pneumatic Caster Wheel With Rigid Top Plate

Rigid caster wheel with 4.10/3.50-4 pneumatic tube tire. 50 PSI, 4-ply sawtooth tread. 3-piece split 1.8mm rim with curled edges. 4" centered hub with valve stem and grease fitting on same side of rim. 5/8" precision ball bearing. Frame thickness is 5.5 mm.

PART#	WHEEL DIAMETER	WHEEL WIDTH	OVERALL HEIGHT	AXLE SIZE	MOUNTING HOLE DIA.	LOAD RATING (LB)	PLATE SIZE (IN.)
31100	10"	3-3/8"	12"	5/8"	7/16"	500 lb	4" x 4-1/2"



Pneumatic Caster Swivel Wheel

Swivel caster wheel with 4.10/3.50-4 pneumatic tube tire. Premium 50 PSI, 4-ply sawtooth tread. 3-piece split 1.8mm rim with curled edges. 4" centered hub with valve stem and grease fitting on same side of rim. 5/8" precision ball bearing. Frame thickness is 5.5 mm.

PART#	WHEEL DIAMETER	WHEEL WIDTH	OVERALL HEIGHT	AXLE SIZE	MOUNTING HOLE DIA.	LOAD RATING (LB)	PLATE SIZE (IN.)
31101	10"	3-3/8"	12"	5/8"	7/16"	500 lb	4" x 4-1/2"



Flat Free Caster Wheel With Rigid Top Plate

Rigid caster wheel with flat free tire. 1.8 mm rim, 5/8" ball bearing.

PART#	WHEEL DIAMETER	WHEEL WIDTH	OVERALL HEIGHT	AXLE SIZE	MOUNTING HOLE DIA.	LOAD RATING (LB)	PLATE SIZE (IN.)
31102	10"	3-3/8"	12"	5/8"	7/16"	360 lb	4" x 4-1/2"



Flat Free Caster Swivel Wheel

Swivel caster wheel with flat free tire. 1.8 mm rim, 5/8" ball bearing.

PART#	WHEEL DIAMETER	WHEEL WIDTH	OVERALL HEIGHT	AXLE SIZE	MOUNTING HOLE DIA.	LOAD RATING (LB)	PLATE SIZE (IN.)
31103	10"	3-3/8"	12"	5/8"	7/16"	360 lb	4" x 4-1/2"



Sizes are approximate. Specifications subject to change without notice.





Wheel Rack Merchandiser

PART#	CONTENTS
-------	----------

80103 1 Small Freestanding **Wheel Rack Only**, 21" wide x 72" high x 21" deep.

80103K Full Wheel Rack Merchandiser An assortment of pneumatic and flat free wheels on this space saving wheel rack. Rack is individually boxed, complete with hardware. All metal construction with black enamel painted finish. Includes: 10" x 3" Dynaline "Replacement Wheels" decal.

PART#	DESCRIPTION	QTY.
80101	Pneumatic Wheel - 8.5"-2.50 R4	2 ea.
80102	Flat Free Wheel - 8.5"-2.50 R4	2 ea.
80105	Pneumatic Hand Truck Wheel, 10.18"	2 ea.
80107	Flat Free Hand Truck Wheel, 10.18"	2 ea.
80109	Pneumatic Outdoor Hand Truck Wheel, 10.08"	2 ea.
80111	Flat Free Outdoor Hand Truck Wheel, 10.23"	2 ea.
80113	Pneumatic H.D. Hand Truck Wheel, 12.25"	2 ea.
80115	Flat Free H.D. Hand Truck Wheel, 13"	2 ea.
80116	Pneumatic Wheel Barrow Wheel, 15.08"	2 ea.
80118	Flat Free Wheel Barrow Wheel, 15.3"	2 ea.

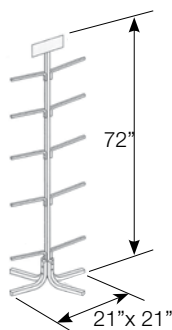

80103K Full Merchandiser includes a laminated wheel reference chart (7" x 5.5") for customer convenience.

Gondola Wheel Merchandiser

PART#	CONTENTS
-------	----------

80100 Wheel Rack Only, 46" wide x 64" high x 24" deep

80100L Signage and Labels only (44" x 12" header and rack labels)

80100K Full Wheels Merchandiser. Includes 44" x 12" Dynaline "Wheels" Sign and labels (80100L) and the products listed below:

PART#	DESCRIPTION	QTY.	PART#	DESCRIPTION	QTY.
80101	Pneumatic Wheel - 10" -2.50 R4	2 ea.	80116	Pneumatic Wheel Barrow Wheel, 4.80/4 R8	2 ea.
80102	Flat Free Wheel - 10" -2.50 R4	3 ea.	80118	Flat Free Wheel Barrow Wheel, 4.80/4 R8	2 ea.
80105	Pneumatic Hand Truck Wheel - 10" - 4.10/3.50 R4	2 ea.	80120	High Speed Trailer Wheel, 4.80 x 12	1 ea.
80107	Flat Free Hand Truck Wheel - 10" - 4.10/3.50 R4	3 ea.	80124	High Speed Trailer Wheel, 5.30 x 12	2 ea.
80109	Pneumatic Outdoor Hand Truck Wheel - 3.00 R4	2 ea.	80128	High Speed Trailer Wheel - ST205/75 D13	2 ea.
80111	Flat Free Outdoor Hand Truck Wheel - 3.00 R4	3 ea.	80130	High Speed Trailer Wheel - ST205/75 D14	1 ea.
80113	Pneumatic H.D. Hand Truck Wheel, 13x5 R6	2 ea.	80132	High Speed Trailer Wheel - ST205/75 D15	1 ea.
80115	Flat Free H.D. Hand Truck Wheel, 13x5 R6	3 ea.			

Sizes are approximate. Specifications subject to change without notice.

Square Keystock

Supplied in 12" lengths only. Cold-drawn C-1018 steel. Zinc plated finish. Rockwell "C" hardness: 60. Thickness tolerance ± 0.1 mm; length tolerance ± 0.3 mm.

PART#	WIDTH	HEIGHT	QTY.	PART#	WIDTH	HEIGHT	QTY.
22750	1/8"	1/8"	Pkg. of 5	22756	1/2"	1/2"	Pkg. of 5
22751	3/16"	3/16"	Pkg. of 5	22758	5/8"	5/8"	Pkg. of 2
22752	1/4"	1/4"	Pkg. of 5	22760	3/4"	3/4"	Pkg. of 2
22753	5/16"	5/16"	Pkg. of 5	22761	7/8"	7/8"	Pkg. of 1
22754	3/8"	3/8"	Pkg. of 5	22763	1"	1"	Pkg. of 1
22755	7/16"	7/16"	Pkg. of 5				



Rectangular Keystock

Supplied in 12" lengths only. Cold-drawn C-1018 steel. Zinc plated finish. Rockwell "C" hardness: 60. Thickness tolerance ± 0.1 mm; length tolerance ± 0.1 mm.

PART#	WIDTH	HEIGHT	QTY.	PART#	WIDTH	HEIGHT	QTY.
22782	1/4"	3/16"	Pkg. of 5	22791	3/8"	7/16"	Pkg. of 5
22785	1/4"	5/16"	Pkg. of 5	22792	3/8"	1/2"	Pkg. of 5
22786	1/4"	3/8"	Pkg. of 5	22795	7/16"	1/2"	Pkg. of 5
22789	5/16"	3/8"	Pkg. of 5	22796	1/2"	5/8"	Pkg. of 2



Step Keystock

Supplied in 12" lengths only. Cold-drawn C-1018 steel. Zinc plated finish. Rockwell "C" hardness: 60. Thickness tolerance ± 0.1 mm; length tolerance ± 0.1 mm.

PART#	A	B	C	D	QTY.
22821	3/16"	3/32"	1/4"	3/32"	Pkg. of 2
22822	1/4"	1/8"	5/16"	1/8"	Pkg. of 2
22823	1/4"	1/8"	3/8"	3/16"	Pkg. of 2
22824	5/16"	5/32"	3/8"	3/16"	Pkg. of 2
22825	3/8"	3/16"	7/16"	5/32"	Pkg. of 2
22826	3/8"	3/16"	1/2"	3/16"	Pkg. of 2
22827	7/16"	5/32"	1/2"	1/4"	Pkg. of 2
22828	1/2"	1/4"	5/8"	1/4"	Pkg. of 2

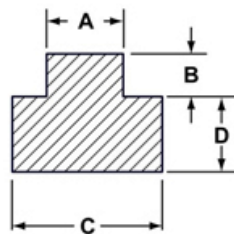

Dynaline offers merchandisers for almost every product. If you are ordering Keystock products then you may be interested in the following Merchandiser. For more information on this merchandiser see the Merchandising Section at the front of the catalogue.



Your Trusted Source.

Sizes are approximate. Specifications subject to change without notice.





Clevis Pins

Yellow zinc dichromate finish. Hole is 1/4" from end of pin.
Package quantity 10 pcs. Made of C1020 steel*.

PART#	PIN DIA.	HOLE DIA.	A	B	PART#	PIN DIA.	HOLE DIA.	A	B
22500	1/4"	1/4"	1"	1-1/4"	22521	3/8"	3/8"	1-3/4"	2"
22501	1/4"	1/4"	1-1/4"	1-1/2"	22522	3/8"	3/8"	2"	2-1/4"
22502	1/4"	1/4"	1-1/2"	1-3/4"	22523	3/8"	3/8"	2-1/4"	2-1/2"
22503	1/4"	1/4"	1-3/4"	2"	22528	7/16"	7/16"	1-1/4"	1-1/2"
22504	1/4"	1/4"	2"	2-1/4"	22529	7/16"	7/16"	1-1/2"	1-3/4"
22505	1/4"	1/4"	2-1/4"	2-1/2"	22530	7/16"	7/16"	1-3/4"	2"
22509	5/16"	5/16"	1"	1-1/4"	22531	7/16"	7/16"	2"	2-1/4"
22510	5/16"	5/16"	1-1/4"	1-1/2"	22532	7/16"	7/16"	2-1/4"	2-1/2"
22511	5/16"	5/16"	1-1/2"	1-3/4"	22536	1/2"	1/2"	1"	1-1/4"
22512	5/16"	5/16"	1-3/4"	2"	22537	1/2"	1/2"	1-1/4"	1-1/2"
22513	5/16"	5/16"	2"	2-1/4"	22538	1/2"	1/2"	1-1/2"	1-3/4"
22514	5/16"	5/16"	2-1/4"	2-1/2"	22539	1/2"	1/2"	1-3/4"	2"
22518	3/8"	3/8"	1"	1-1/4"	22540	1/2"	1/2"	2"	2-1/4"
22519	3/8"	3/8"	1-1/4"	1-1/2"	22541	1/2"		2-1/4"	2-1/2"
22520	3/8"	3/8"	1-1/2"	1-3/4"					



Clevis Pin Dynapaks

PART#	CONTENTS	QTY.	PART#	CONTENTS	QTY.
92500	22500	Pkg. of 5	92518	22518	Pkg. of 3
92502	22502	Pkg. of 5	92520	22520	Pkg. of 3
92504	22504	Pkg. of 5	92522	22522	Pkg. of 3
92509	22509	Pkg. of 5	92529	22529	Pkg. of 2
92511	22511	Pkg. of 5	92538	22538	Pkg. of 2
92513	22513	Pkg. of 5	92540	22540	Pkg. of 2

Adjustable Clevis Pins

A quick replacement pin, the universal clevis pin features a series of holes making it adaptable to varying lengths. Use the diameter that fits your application and cut off the excess length. Easily replaces bolts, cotter pins or rivets on all types of equipment. Yellow zinc dichromate finish. First pin hole is 1/4" from the end of the pin.



PART#	PIN DIAMETER	OVERALL LENGTH	QTY.	PART#	PIN DIAMETER	OVERALL LENGTH	QTY.
22545	1/4"	2"	Pkg. of 5	22551	1/2"	2-1/2"	Pkg. of 5
22546	5/16"	2"	Pkg. of 5	22552	7/16"	3"	Pkg. of 5
22547	3/8"	2"	Pkg. of 5	22553	1/2"	3"	Pkg. of 5
22548	7/16"	2"	Pkg. of 5	22554	5/8"	3"	Pkg. of 5
22549	1/2"	2"	Pkg. of 5	22555	3/4"	3"	Pkg. of 5
22550	7/16"	2-1/2"	Pkg. of 5				

* 1020 is a general purpose low tensile low hardenability carbon steel generally supplied in the cold drawn or turned and polished condition, with a typical tensile strength range 410 - 790 Mpa, and Brinell hardness range 119 - 235. Characterized by excellent weldability, very good machinability with reasonable strength and very good ductility.

Sizes are approximate. Specifications subject to change without notice.



Machinery Bushings

Machinery bushings reduce wear between moving parts, prevent marring of fine finishes and can be used as spacers for sprockets, pulleys and gears on new or old equipment. Made of low carbon, mild steel with plain finish.



- 18 Gauge (l = light) = 0.042/0.054, 3/64"
- 14 Gauge (m = medium) = 0.068/0.082, 5/64"
- 10 Gauge (h = heavy) = 0.126/0.142, 1/8"
- Tolerances - O.D. +0.010/-0.010 I.D. +0.010 / -0.000

Reference Chart Available

See end of catalogue

PART#	IND#	INSIDE DIA.	OUTSIDE DIA.	GAUGE	QTY.	PART#	IND#	INSIDE DIA.	OUTSIDE DIA.	GAUGE	QTY.
22700	M-16L	9/16"	1"	18	Pkg. of 10	22720	M-36L	1-1/2"	2-1/4"	18	Pkg. of 10
22701	M-18L	5/8"	1-1/8"	18	Pkg. of 10	22721	M-36M	1-1/2"	2-1/4"	14	Pkg. of 10
22702	M-18M	5/8"	1-1/8"	14	Pkg. of 10	22722	M-36H	1-1/2"	2-1/4"	10	Pkg. of 10
22703	M-20L	3/4"	1-1/4"	18	Pkg. of 10	22723	M-38M	1-5/8"	2-3/8"	14	Pkg. of 10
22704	M-20M	3/4"	1-1/4"	14	Pkg. of 10	22724	M-38H	1-5/8"	2-3/8"	10	Pkg. of 10
22705	M-20H	3/4"	1-1/4"	10	Pkg. of 10	22725	M-40M	1-3/4"	2-1/2"	14	Pkg. of 10
22706	M-22L	7/8"	1-3/8"	18	Pkg. of 10	22726	M-40H	1-3/4"	2-1/2"	10	Pkg. of 10
22707	M-22M	7/8"	1-3/8"	14	Pkg. of 10	22727	M-46M	1-7/8"	2-7/8"	14	Pkg. of 10
22708	M-24L	1"	1-1/2"	18	Pkg. of 10	22728	M-46H	1-7/8"	2-7/8"	10	Pkg. of 10
22709	M-24M	1"	1-1/2"	14	Pkg. of 10	22729	M-48M	2"	3"	14	Pkg. of 10
22710	M-24H	1"	1-1/2"	10	Pkg. of 10	22730	M-48H	2"	3"	10	Pkg. of 10
22711	M-28L	1-1/8"	1-3/4"	18	Pkg. of 10	22731	M-50M	2-1/8"	3-1/8"	14	Pkg. of 10
22712	M-28M	1-1/8"	1-3/4"	14	Pkg. of 10	22732	M-50H	2-1/8"	3-1/8"	10	Pkg. of 10
22713	M-28H	1-1/8"	1-3/4"	10	Pkg. of 10	22733	M-52M	2-1/4"	3-1/4"	14	Pkg. of 10
22714	M-30L	1-1/4"	1-7/8"	18	Pkg. of 10	22734	M-52H	2-1/4"	3-1/4"	10	Pkg. of 10
22715	M-30M	1-1/4"	1-7/8"	14	Pkg. of 10	22735	M-54M	2-3/8"	3-3/8"	14	Pkg. of 10
22716	M-30H	1-1/4"	1-7/8"	10	Pkg. of 10	22736	M-54H	2-3/8"	3-3/8"	10	Pkg. of 10
22717	M-34L	1-3/8"	2-1/8"	18	Pkg. of 10	22737	M-56M	2-1/2"	3-1/2"	14	Pkg. of 10
22718	M-34M	1-3/8"	2-1/8"	14	Pkg. of 10	22738	M-56H	2-1/2"	3-1/2"	10	Pkg. of 10
22719	M-34H	1-3/8"	2-1/8"	10	Pkg. of 10						

Dynaline offers merchandisers for almost every product. If you are ordering Keystock products then you may be interested in the following Merchandiser. For more information on this merchandiser see the Merchandising Section at the front of the catalogue.

Machinery Bushings Merchandiser

PART#	CONTENTS
00235	Machinery Bushings Display Board Only , 12" x 24"
00235K	Full Machinery Bushings Merchandiser . Includes 00235 display board, 39 pegs (80004) and the fastest selling products.



Your Trusted Source.

Sizes are approximate. Specifications subject to change without notice.





00243C

- Drawers with lids easily pull open
- Bulk springs Merchandisers takes up less space than packaged springs
- Cabinet holds 100 types of springs.
- Illustrations or photos may not be exactly as shown.

Bulk Springs Merchandiser

PART#	CONTENTS
00243	Bulk Springs Display Board Only 24" x 24" Photo Board (features actual size photos)
00243K	Full Bulk Springs Assortment Merchandiser - A complete (900 pieces). Also includes cabinet, 4 drawers and 00243 Photo Display Board, 24" x 24".
00243C	Cabinet Only - Cabinet size is 20" wide x 14-1/2" high x 15-3/4" deep.

PART#	REF#	TYPE	MEASUREMENTS	WIRE DIA.	ASSORT. QTY.	REFILL QTY.
26001	1	Ext.	5/32" x 1-7/8"	0.02"	11	12
26002	2	Ext.	1/4" x 2-1/2"	0.035"	11	12
26003	3	Ext.	1/4" x 2-1/4"	0.032"	11	12
26004	4	Ext.	5/16" x 2-11/16"	0.041"	11	12
26005	5	Ext.	1/2" x 2-5/16"	0.062"	8	12
26006	6	Ext.	3/8" x 2"	0.035"	11	12
26007	7	Cone C	13/32"x11/16"x1"	0.041"	11	12
26008	8	Ext.	15/32" x 2-7/16"	0.054"	5	12
26009	9	Ext.	7/16" x 2-15/16"	0.062"	5	12.
26010	10	Ext.	13/32" x 2-3/4"	0.041"	5	12
26011	11	Ext.	3/8" x 2-11/16"	0.047"	5	12
26012	12	Brl C	7/16"x 11/16"x2"	0.047"	8	12
26013	13	Comp.	1/2" x 1-3/4"	0.054"	8	12
26014	14	Comp.	5/8" x 1-3/4"	0.091"	5	12
26015	15	Torsion	1/16" x 1/2"	0.072"	8	12
26016	16	Comp.	5/8" x 2"	0.072"	8	12
26017	17	Comp.	5/16" x 1-3/8"	0.041"	11	12
26018	18	Comp.	5/16" x 1-1/2"	0.02"	11	12
26019	19	Comp.	13/64" x 2-1/4"	0.032"	23	12
26020	20	Comp.	7/32" x 1-5/8"	0.015"	23	12
26021	21	Comp.	3/16" x 1-5/16"	0.022"	17	12
26022	22	Comp.	7/32" x 1-1/4"	0.032"	23	12
26023	23	Comp.	5/16" x 1-7/8"	0.026"	23	12
26024	24	Comp.	5/16" x 1-7/8"	0.041"	11	12
26025	25	Comp.	1/4" x 2"	0.023"	29	12
26026	26	Comp.	7/16" x 3"	0.047"	8	12
26027	27	Ext.	1/2" x 3-5/8"	0.062"	8	12
26028	28	Ext.	3/4" x 2-5/16"	0.105"	8	12
26029	29	Ext.	7/16" x 3-11/16"	0.047"	8	12
26030	30	Ext.	1/2" x 3-13/16"	0.041"	11	12
26031	31	Ext.	3/4" x 1-15/16"	0.105"	11	12
26032	32	Comp.	7/16" x 3-1/4"	0.062"	23	12
26033	33	Comp.	21/64" x 3-5/16"	0.047"	8	12
26034	34	Ext.	3/4" x 1-3/4"	0.105"	11	12
26035	35	Comp.	15/32" x 2-3/8"	0.08"	8	12
26036	36	Ext.	5/16" x 3-7/16"	0.041"	8	12

continued on next page

Sizes are approximate. Specifications subject to change without notice.

Bulk Springs Merchandiser cont...

PART#	REF#	TYPE	MEASUREMENTS	WIRE DIA.	ASSORT. QTY.	REFILL QTY.
26037	37	Comp.	15/32" x 1-1/8"	0.047"	11	12
26038	38	Ext.	9/32" x 6-1/2"	0.041"	8	12
26039	39	Comp.	11/16" x 1-1/8"	0.08"	11	12
26040	40	Ext.	5/8" x 5-3/8"	0.062"	3	6
26041	41	Comp.	1/2" x 2-13/16"	0.062"	8	6
26042	42	Ext.	1/2" x 6"	0.08"	3	6
26043	43	Comp.	11/16" x 3"	0.062"	5	6
26044	44	Ext.	5/8" x 5-7/8"	0.08"	3	6
26045	45	Comp.	3/4" x 3-3/8"	0.047"	8	6
26046	46	Ext.	21/32" x 4-7/8"	0.041"	3	6
26047	47	Comp.	7/8" x 3-7/16"	0.08"	3	6
26048	48	Comp.	7/16" x 5"	0.08"	3	6
26049	49	Comp.	31/32" x 3-3/4"	0.105"	3	6
26050	50	Ext.	15/32" x 6-3/4"	0.047"	3	6
26051	51	Ext.	11/32" x 5"	0.035"	3	6
26052	52	Ext.	7/16" x 5"	0.047"	3	6
26053	53	Ext.	9/16" x 3-15/16"	0.072"	5	6
26054	54	Comp.	15/32" x 5-1/4"	0.041"	8	6
26055	55	Comp.	13/16" x 3-1/4"	0.062"	5	6
26056	56	Comp.	1-1/32" x 5-3/8"	0.120"	2	6
26057	57	Comp.	3/4X3"	0.105"	5	6
26058	58	Comp.	1-1/4" x 4-5/8"	0.120"	2	6
26059	59	Comp.	1" x 3-3/4"	0.135"	2	6
26060	60	Comp.	11/16" x 9-1/2"	0.072"	2	6
26061	61	Comp.	15/16" x 9-7/8"	0.120"	2	6
26062	62	Ext.	1/2" x 9-3/4"	0.062"	2	6
26063	63	Ext.	3/4"x10-1/4"	.091"	2	6
26064	64	Ext.	3/4"x8"	.105"	2	6
26065	65	Ext.	5/8"x2-11/16"	.041"	11	12
26066	66X	Ext.	3/8"x2-3/16"	.062"	8	12
26067	67X	Comp.	21/64" x 1-1/8"	0.028"	14	12
26068	68X	Ext.	5/16"x2-3/16"	.041"	8	12
26069	69X	Comp.	1/4"x2"	.020"	11	12
26070	70X	Ext.	5/16"x2-1/8"	.032"	11	12
26071	71X	Comp.	3/16"x1-1/2"	.020"	11	12
26072	72X	Comp.	1/4"x1-7/8"	.022"	11	12
26073	73X	Ext.	7/16" x 1-15/16"	0.054"	8	12
26074	74X	Comp.	5/16" x 1-7/16"	0.025"	11	12
26075	75X	Ext.	15/64"x1-1/2"	.028"	11	12
26076	76X	Comp.	5/16"x2"	.041"	11	12
26077	77X	Comp.	3/8" x 1-7/16"	0.035"	11	12
26078	78X	Ext.	5/16" x 1-11/16"	0.041"	11	12
26079	79X	Comp.	3/8" x 1-15/16"	0.041"	11	12
26080	80X	Comp.	1/2" x 1-7/16"	0.062"	11	12



Detail of 00243K open drawer

PART#	REF#	TYPE	MEASUREMENTS	WIRE DIA.	ASSORT. QTY.	REFILL QTY.
26081	81X	Ext.	3/16" x 1-11/16"	0.028"	8	12
26082	82X	Comp.	1/12" x 1-3/4"	0.047"	8	12
26083	83X	Ext.	7/32" x 2"	0.032"	8	12
26084	84X	Comp.	7/16" x 1-7/16"	0.041"	11	12
26085	85X	Comp.	5/8" x 1-9/16"	0.054"	11	12
26086	86X	Ext.	3/16" x 2"	0.035"	8	12
26087	87X	Comp.	15/64"x1-3/4"	.032"	11	12
26088	88X	Ext.	3/8"x2"	.041"	8	12
26089	89X	Comp.	5/8"x2"	.062"	11	12
26090	90X	Comp.	5/16"x1-1/2"	.035"	11	12
26091	91X	Ext.	9/32"x2-7/16"	.035"	8	12
26092	92X	Comp.	5/16"x1-11/16"	.032"	11	12
26093	93X	Ext.	1/4"x2-5/16"	.020"	8	12
26094	94X	Comp.	1/4" x 2"	0.025"	11	12
26095	95X	Comp.	5/16" x 1-1/2"	0.047"	14	12
26096	96X	Comp.	3/8" x 1-1/2"	0.047"	11	12
26097	97X	Ext.	3/8" x 2-3/16"	0.047"	8	12
26098	98X	Comp.	1/4" x 1-7/16"	0.032"	11	12
26099	99X	Comp.	3/8" x 1-7/8"	0.025"	11	12
26100	100X	Ext.	15/32" x 2-1/4"	0.041"	8	12

Sizes are approximate. Specifications subject to change without notice.



Packaged Extension Springs

S.A.E. 1060-1090 spring steel. Phosphate and oil finish.
Retail package with UPC barcode label.



PART#	REF#	WIRE DIA.	OUTSIDE DIA.	OVERALL LENGTH	BODY LENGTH	MAXIMUM STRETCH	LOAD RATE (LB/IN)	MAX LOAD (LB)	PKG. QTY.
24001	C-1	0.015"	0.125"	1.5"	0.125"	2"	0.65	1.4	2
24005	C-5	0.02"	0.156"	1.5"	1.188"	1.7"	1.50	2.7	2
24013	C-13	0.023"	0.218"	1.5"	1.064"	2.4"	1.10	2.9	2
24019	C-19	0.035"	0.25"	1.5"	1"	1.1"	6.40	8.4	2
24023	C-23	0.025"	0.281"	1.5"	0.938"	3.4"	0.74	2.8	2
24025	C-25	0.02"	0.312"	1.5"	0.876"	7.7"	0.17	1.4	2
24029	C-29	0.028"	0.343"	1.5"	0.814"	3.2"	0.81	3.6	2
24031	C-31	0.028"	0.437"	1.5"	0.626"	4.4"	0.54	2.5	2
24033	C-33	0.047"	0.437"	1.5"	0.626"	1.6"	6.20	11	2
24051	C-51	0.014"	0.125"	1.875"	1.625"	3.3"	0.35	1.3	2
24055	C-55	0.02"	0.156"	1.875"	1.563"	2.7"	1.10	2.2	2
24063	C-63	0.023"	0.218"	1.875"	1.439"	3.4"	0.79	2.9	2
24067	C-67	0.02"	0.25"	1.875"	1.375"	6.4"	0.25	1.7	2
24069	C-69	0.035"	0.25"	1.875"	1.375"	1.5"	4.70	8.4	2
24073	C-73	0.025"	0.281"	1.875"	1.313"	2.8"	0.54	4.7	2
24077	C-77	0.025"	0.313"	1.875"	1.189"	6.8"	0.31	2.3	2
24081	C-81	0.028"	0.437"	1.875"	1"	7.8"	0.30	2.5	2
24083	C-83	0.047"	0.437"	1.875"	1"	2.3"	4.30	11	2
24103	C-103	0.018"	0.125"	2.5"	2.25"	2.2"	0.96	2.5	2
24105	C-105	0.02"	0.156"	2.5"	2.188"	3"	0.81	2.7	2
24111	C-111	0.025"	0.187"	2.5"	2.126"	2.5"	1.50	4.2	2
24115	C-115	0.016"	0.25"	2.5"	2"	15"	0.50	0.87	2
24117	C-117	0.02"	0.25"	2.5"	2"	9"	0.17	1.7	2
24119	C-119	0.035"	0.25"	2.5"	2"	2.1"	3.50	8.4	2
24131	C-131	0.028"	0.437"	2.5"	1.626"	13"	0.18	2.5	2
24133	C-133	0.047"	0.437"	2.5"	1.665"	3.4"	3.00	11	2
24135	C-135	0.062"	0.437"	2"	1.126"	0.87"	17.00	19	2
24139	C-139	0.054"	0.437"	3.5"	2.626"	2.5"	4.00	12	2
24141	C-141	0.072"	0.625"	2.5"	1.375"	1.5"	10.00	19	2
24143	C-143	0.054"	0.562"	3"	1.875"	3.4"	2.30	9.2	2
24155	C-155	0.028"	0.312"	3"	2.375"	7.8"	0.41	3.5	2
24157	C-157	0.025"	0.25"	3.25"	2.75"	6.4"	0.44	3.1	2
24161	C-161	0.035"	0.437"	2.75"	1.875"	5.9"	5.00	3.3	2
24163	C-163	0.047"	0.437"	3.5"	2.626"	3.6"	2.00	8.4	2
24165	C-165	0.08"	0.5"	1.625"	0.625"	2"	66.00	35	2
24171	C-171	0.105"	0.75"	2"	0.5"	2.59"	92.00	60	2
24173	C-173	0.105"	0.75"	2.25"	0.75"	3"	68.00	60	2
24175	C-175	0.105"	0.75"	2.437"	0.9375"	3.3"	47.00	50	2

continued on next page

Sizes are approximate. Specifications subject to change without notice.



Packaged Extension Springs cont...

PART#	REF#	WIRE DIA.	OUTSIDE DIA.	OVERALL LENGTH	BODY LENGTH	MAXIMUM STRETCH	LOAD RATE (LB/IN)	MAX LOAD (LB)	PKG. QTY.
24177	C-177	0.105"	0.75"	2.625"	1.125"	3.625"	38.00	50	2
24179	C-179	0.072"	0.562"	2.875"	1.75"	4.475"	11.00	22	2
24181	C-181	0.072"	0.625"	3.25"	2"	5.6"	6.40	19	2
24183	C-183	0.047"	0.562"	4"	2.91"	11.6"	0.76	6.5	2
24185	C-185	0.062"	0.75"	3.5"	2"	9"	1.70	11	2
24187	C-187	0.105"	0.75"	2.875"	1.375"	N/A	39.00	60	2
24189	C-189	0.105"	0.75"	3.125"	1.625"	4.3"	33.00	50	2
24191	C-191	0.105"	0.75"	3.75"	2.25"	6"	26.00	50	2
24193	C-193	0.035"	0.375"	4"	3.25"	11.3"	0.47	3.9	2
24205	C-205	0.035"	0.25"	5"	4.5"	8.5"	1.40	6	2
24209	C-209	0.028"	0.375"	4.5"	3.75"	18"	0.15	2.9	2
24215	C-215	0.041"	0.375"	3.75"	3"	7.5"	1.40	6.5	2
24219	C-219	0.041"	0.468"	4.5"	3.564"	13"	0.54	5.2	2
24221	C-221	0.062"	0.5"	4.5"	3.5"	7.7"	4.10	16	2
24223	C-223	0.072"	0.5"	5"	4"	7.3"	8.20	25	2
24227	C-227	0.091"	0.687"	4.75"	3.875"	7.25"	11.00	35	2
24231	C-231	0.072"	0.562"	6"	4.876"	9.8"	4.60	22	2
24233	C-233	0.035"	0.25"	6"	5.5"	10.3"	1.10	6	2
24235	C-235	0.028"	0.312"	6"	5.375"	21"	0.23	3.9	2
24239	C-239	0.047"	0.375"	6.5"	5.75"	11.5"	1.60	10	2
24243	C-243	0.054"	0.625"	6.5"	5.25"	17.5"	0.65	8.3	2
24251	C-251	0.105"	1.125"	16"	13.75"	38"	1.20	31	1
24253	C-253	0.054"	0.562"	16.5"	15.375"	41.5"	0.32	9.2	1
24257	C-257	0.091"	0.812"	4.5"	3.375"	7.8"	7.10	29	2
24259	C-259	0.12"	0.812"	4"	2.375"	1.3"	39.00	66	2
24261	C-261	0.12"	1.062"	5.5"	3.375"	9.7"	9.50	49	1
24263	C-263	0.091"	0.785"	6"	4.875"	11.6"	3.90	26	1
24265	C-265	0.105"	1.062"	7"	4.875"	14.5"	3.70	33	1
24267	C-267	0.162"	1.25"	6.5"	4"	9.5"	26.00	100	1
24269	C-269	0.135"	1"	7"	5"	10"	18.00	75	1
24271	C-271	0.08"	1.062"	8.5"	6.375"	27.5"	0.69	15	1
24273	C-273	0.148"	1.125"	8.5"	6.25"	12.9"	15.00	87	1

continued on next page

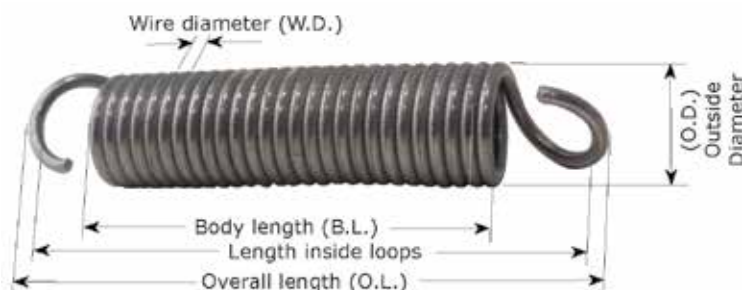

Sizes are approximate. Specifications subject to change without notice.





Packaged Extension Springs cont...

PART#	REF#	WIRE DIA.	OUTSIDE DIA.	OVERALL LENGTH	BODY LENGTH	MAXIMUM STRETCH	LOAD RATE (LB/IN)	MAX LOAD (LB)	PKG. QTY.
24275	C-275	0.091"	1.125"	7.5"	6.312"	20.5"	1.30	20	1
24277	C-277	0.091"	0.65"	6.5"	5.5"	10.5"	5.90	31	1
24281	C-281	0.062"	0.375"	5.5"	5"	7.4"	8.90	23	2
24285	C-285	0.035"	0.375"	5"	4.25"	16"	0.43	5.4	2
24287	C-287	0.032"	0.312"	5"	4.375"	14.8"	0.48	5.2	2
24289	C-289	0.035"	0.312"	5"	4.375"	12.4"	0.79	6.6	2
24293	C-293	0.062"	0.375"	6.75"	6"	2.5"	6.80	23	1
24301	C-301	0.135"	1.5"	11.5"	8.5"	26.5"	2.70	47	1
24303	C-303	0.105"	1"	12"	10"	24"	2.40	35	1
24307	C-307	0.135"	1.062"	12"	9.875"	19"	7.70	69	1
24311	C-311	0.041"	0.437"	10.25"	9.375"	27"	0.28	5.5	1
24313	C-313	0.047"	0.5"	8.5"	7.5"	22.5"	0.46	7.2	1
24315	C-315	0.047"	0.437"	8.5"	7.626"	18"	0.73	8.4	1
24317	C-317	0.091"	0.625"	8.5"	7.25"	12.3"	7.70	39	1
24319	C-319	0.054"	0.562"	8.5"	7.376"	20"	0.64	9.2	1
24321	C-321	0.062"	0.625"	8.5"	7.75"	19.5"	0.95	13	1
24323	C-323	0.08"	0.625"	8.5"	7.25"	14"	3.90	27	1
24325	C-325	0.062"	0.875"	8.5"	6.75"	32"	0.33	8.8	1
24329	C-329	0.105"	0.875"	8.5"	6.75"	14"	5.40	41	1
24333	C-333	0.135"	0.875"	9"	7.25"	12"	20.00	87	1
24337	C-337	0.12"	1"	8.5"	6.5"	13"	7.70	52	1
24339	C-339	0.148"	1.25"	10"	7.5"	16.5"	9.20	77	1



Drawbar Spring

S.A.E. 1060-1090 Spring steel. Phosphate & oil finish, UPC barcode label.

PART#	REF#	WIRE DIAMETER	OUTSIDE DIAMETER	OVERALL LENGTH	LOAD RATE (LB/IN)	MAXIMUM LOAD (LB)
24900	4001	0.227"	1-9/16"	7-1/4"	152.78	330.31

Sizes are approximate. Specifications subject to change without notice.



Packaged Compression Springs

S.A.E. 1060-1090 spring steel. Phosphate and oil finish.
Retail package with UPC barcode label.

PART#	REF#	WIRE DIA.	OUTSIDE DIA.	OVERALL LENGTH	SOLID HEIGHT	TOTAL COILS	LOAD RATE (LB/IN)	MAX LOAD (LB)	PKG. QTY.
24500	C-500	0.023"	0.156"	0.562"	0.28	11	19.00	4.5	6
24510	C-510	0.035"	0.25"	0.5"	0.26	7	42.00	6.2	6
24516	C-516	0.011"	0.156"	1"	0.14	12	0.73	0.57	6
24520	C-520	0.016"	0.187"	0.875"	0.27	16	1.30	0.81	6
24526	C-526	0.028"	0.187"	1"	0.48	17	15.00	6.3	6
24530	C-530	0.02"	0.218"	1"	0.24	11	3.30	2.2	6
24532	C-532	0.013"	0.187"	1"	0.14	10	0.99	0.78	6
24550	C-550	0.016"	0.187"	1"	0.2	12	2.00	1.3	6
24554	C-554	0.02"	0.25"	1"	0.2	9	2.80	1.9	6
24556	C-556	0.026"	0.312"	0.625"	0.18	7	7.00	3.1	6
24562	C-562	0.035"	0.25"	1"	0.46	12	21.00	8.9	6
24566	C-566	0.032"	0.375"	0.75"	0.22	6	7.70	3.2	6
24570	C-570	0.014"	0.125"	1.375"	0.34	27	1.60	1.4	6
24576	C-576	0.016"	0.156"	1.375"	0.35	21	1.80	1.6	6
24578	C-578	0.013"	0.187"	1.375"	0.18	12	0.71	0.78	6
24580	C-580	0.028"	0.187"	1.375"	0.65	23	11.00	6.3	6
24582	C-582	0.016"	0.187"	1.375"	0.26	15	1.40	1.3	6
24600	C-600	0.02"	0.218"	1.375"	0.31	15	2.40	2.2	4
24604	C-604	0.023"	0.218"	1.375"	0.39	16	3.90	3.3	4
24608	C-608	0.02"	0.25"	1.375"	0.25	12	2.00	1.9	4
24612	C-612	0.028"	0.281"	1.375"	0.43	15	4.40	4.1	4
24614	C-614	0.041"	0.312"	1.25"	0.62	15	17.00	8.3	4
24624	C-624	0.041"	0.375"	1.125"	0.46	10	13.00	7	4
24632	C-632	0.041"	0.437"	1.062"	0.36	8	11.00	6.1	4
24650	C-650	0.013"	0.218"	1.75"	0.247	18	0.29	0.44	4
24652	C-652	0.028"	0.218"	1.375"	0.53	18	8.10	5.5	4
24660	C-660	0.016"	0.312"	1.75"	0.2	12	0.39	0.61	4
24664	C-664	0.047"	0.343"	1.5"	0.71	15	23.00	11	4
24668	C-668	0.026"	0.375"	1.5"	0.26	10	1.70	2.2	4
24672	C-672	0.035"	0.375"	1.75"	0.54	16	3.70	4.2	4
24676	C-676	0.032"	0.437"	2.125"	0.39	12	2.00	2.8	4
24680	C-680	0.047"	0.312"	2"	1.14	24	18.00	12	4
24690	C-690	0.041"	0.437"	2.25"	0.67	16	4.90	6.1	2
24692	C-692	0.041"	0.625"	1.5"	0.37	9	3.40	3.8	2



Sizes are approximate. Specifications subject to change without notice.





Packaged Compression Springs cont...

PART#	REF#	WIRE DIA.	OUTSIDE DIA.	OVERALL LENGTH	SOLID HEIGHT	TOTAL COILS	LOAD RATE (LB/IN)	MAX LOAD (LB)	PKG. QTY.
24500	C-500	0.023"	0.156"	0.562"	0.28	11	19.00	4.5	6
24510	C-510	0.035"	0.25"	0.5"	0.26	7	42.00	6.2	6
24516	C-516	0.011"	0.156"	1"	0.14	12	0.73	0.57	6
24520	C-520	0.016"	0.187"	0.875"	0.27	16	1.30	0.81	6
24526	C-526	0.028"	0.187"	1"	0.48	17	15.00	6.3	6
24530	C-530	0.02"	0.218"	1"	0.24	11	3.30	2.2	6
24532	C-532	0.013"	0.187"	1"	0.14	10	0.99	0.78	6
24550	C-550	0.016"	0.187"	1"	0.2	12	2.00	1.3	6
24554	C-554	0.02"	0.25"	1"	0.2	9	2.80	1.9	6
24556	C-556	0.026"	0.312"	0.625"	0.18	7	7.00	3.1	6
24562	C-562	0.035"	0.25"	1"	0.46	12	21.00	8.9	6
24566	C-566	0.032"	0.375"	0.75"	0.22	6	7.70	3.2	6
24570	C-570	0.014"	0.125"	1.375"	0.34	27	1.60	1.4	6
24576	C-576	0.016"	0.156"	1.375"	0.35	21	1.80	1.6	6
24578	C-578	0.013"	0.187"	1.375"	0.18	12	0.71	0.78	6
24580	C-580	0.028"	0.187"	1.375"	0.65	23	11.00	6.3	6
24582	C-582	0.016"	0.187"	1.375"	0.26	15	1.40	1.3	6
24600	C-600	0.02"	0.218"	1.375"	0.31	15	2.40	2.2	4
24604	C-604	0.023"	0.218"	1.375"	0.39	16	3.90	3.3	4
24608	C-608	0.02"	0.25"	1.375"	0.25	12	2.00	1.9	4
24612	C-612	0.028"	0.281"	1.375"	0.43	15	4.40	4.1	4
24614	C-614	0.041"	0.312"	1.25"	0.62	15	17.00	8.3	4
24624	C-624	0.041"	0.375"	1.125"	0.46	10	13.00	7	4
24632	C-632	0.041"	0.437"	1.062"	0.36	8	11.00	6.1	4
24650	C-650	0.013"	0.218"	1.75"	0.247	18	0.29	0.44	4
24652	C-652	0.028"	0.218"	1.375"	0.53	18	8.10	5.5	4
24660	C-660	0.016"	0.312"	1.75"	0.2	12	0.39	0.61	4
24664	C-664	0.047"	0.343"	1.5"	0.71	15	23.00	11	4
24668	C-668	0.026"	0.375"	1.5"	0.26	10	1.70	2.2	4
24672	C-672	0.035"	0.375"	1.75"	0.54	16	3.70	4.2	4
24676	C-676	0.032"	0.437"	2.125"	0.39	12	2.00	2.8	4
24680	C-680	0.047"	0.312"	2"	1.14	24	18.00	12	4

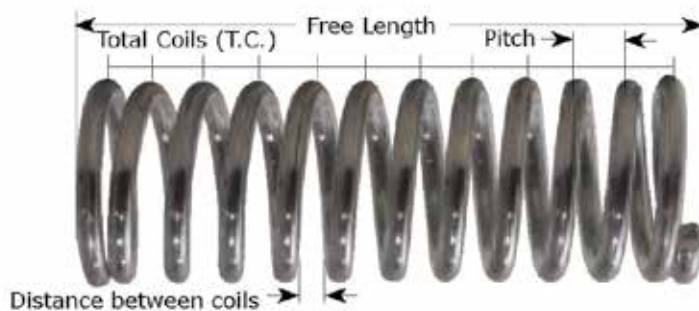
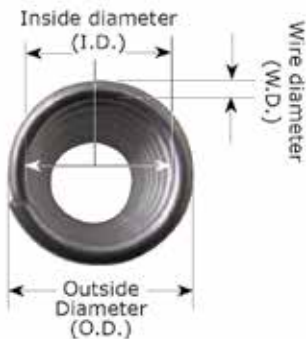

Sizes are approximate. Specifications subject to change without notice.

Packaged Compression Springs cont...

PART#	REF#	WIRE DIA.	OUTSIDE DIA.	OVERALL LENGTH	SOLID HEIGHT	TOTAL COILS	LOAD RATE (LB/IN)	MAX LOAD (LB)	PKG. QTY.
24690	C-690	0.041"	0.437"	2.25"	0.67	16	4.90	6.1	2
24692	C-692	0.041"	0.625"	1.5"	0.37	9	3.40	3.8	2
24700	C-700	0.062"	0.5"	1"	0.54	8	45.00	17	2
24702	C-702	0.054"	0.562"	1"	0.38	7	16	9.5	2
24704	C-704	0.041"	0.5"	1.5"	0.45	10	5.30	5.4	2
24706	C-706	0.072"	0.562"	1.375"	0.74	10	45	22	2
24712	C-712	0.091"	0.687"	1.25"	0.75	8	89	35	2
24714	C-714	0.062"	0.375"	2.25"	1.46	22	34	22	2
24720	C-720	0.062"	0.5"	1.75"	0.85	14	24	17	2
24722	C-722	0.047"	0.5"	2"	0.635	13	7.19	N/A	2
24724	C-724	0.054"	0.437"	2"	0.89	16	16	13	2
24730	C-730	0.047"	0.406"	2.75"	1.12	23	7.30	9.7	2
24736	C-736	0.072"	0.5"	2.75"	1.48	19	28	25	2
24740	C-740	0.08"	0.625"	2.5"	1.14	14	32	27	2
24742	C-742	0.054"	0.625"	2.75"	0.77	14	5.80	9.1	2
24750	C-750	0.08"	0.75"	2"	0.78	10	25	23	2
24752	C-752	0.08"	0.937"	2"	0.67	8	17	19	2
24756	C-756	0.041"	0.718"	3.5"	0.47	11	1.50	3.8	2
24766	C-766	0.054"	0.562"	3"	0.96	17	6.30	10	2
24768	C-768	0.105"	0.812"	2.25"	1.26	11	54.94	N/A	2
24782	C-782	0.08"	0.625"	3"	1.34	16	26	27	2
24792	C-792	0.105"	0.875"	3"	1.39	14	34	43	2
24802	C-802	0.148"	1.375"	4.375"	1.83	13	36	72	1
24806	C-806	0.148"	1.5"	3.25"	1.26	9	43	67	1
24814	C-814	0.135"	1.375"	2.5"	0.98	8	48	55	1
24818	C-818	0.12"	1.125"	4"	1.72	13	26	48	1
24822	C-822	0.148"	0.937"	4"	2.63	12	89	103	2
24826	C-826	0.12"	1"	3.5"	1.71	15	36	54	2
24830	C-830	0.12"	1.125"	3"	1	10	22	34	2
24832	C-832	0.12"	1"	3"	1.41	12	45	54	2
24834	C-834	0.12"	1.187"	2.75"	1.2	9	35	46	2
24836	C-836	0.08"	0.875"	4"	1.28	15	9	20	2
24838	C-838	0.08"	0.75"	3.5"	1.38	16	14	23	2
24850	C-850	0.091"	0.625"	5"	2.64	29	29	38	2
24856	C-856	0.091"	0.75"	6"	2.78	30	13	32	2
24858	C-858	0.072"	0.687"	6"	2.16	29	6.20	18	2
24864	C-864	0.091"	0.875"	6"	2.18	23	9.30	28	1
24874	C-874	0.12"	1.375"	6"	1.08	14	13	40	1
24878	C-878	0.08"	0.625"	9"	3.72	45	8.40	27	1
24892	C-892	0.162"	1.125"	7"	4	24	49	111	1



Sizes are approximate. Specifications subject to change without notice.



What are retaining rings?

Retaining Rings are precision engineered components that are designed to be applied on shafts or in bores and provide a shoulder that accurately positions, locates and retains other parts of an assembly. Many different types of retaining rings have been developed over the years, each a solution to a specific problem. Different types of rings are available to solve issues such as: tolerance take-up, clearance diameter, thrust load capacity, flexible installation, rpm capacity, impact loading, non-removable lock-rings, groove-less push-on fastening and radial installation.

As an engineering concept, the retaining ring is still relatively young and has certainly not yet reached its peak of utilization as a retaining device.

How are retaining rings used?

Retaining Rings work by creating a shoulder that can hold components in place. The retaining shoulder is created when the ring attaches itself to the bore or shaft, typically by snapping into a groove. Ordinarily (however not always) a groove is dug into the shaft or bore, and this groove becomes the seat for the retaining ring.

Retaining rings are designed such that their contact diameter has some interference fit with the groove in which they fit. This creates a “snug” fit between the ring and groove. The term used to describe the amount of interference fit is “cling”.

Cling causes the retaining ring to fit tightly and securely against its groove bottom. Without cling a ring would have a loose fit and would “rattle” in its groove. This lack of cling would decrease the retention capacity of the ring because a “cling-less” ring is free to move radially, creating weak retention points that will ultimately cause the assembly to fail.

Another key factor is the width of the groove. The groove width is slightly larger than the rings thickness, thus creating a snug axial fit. The tight axial fit along with the cling to the groove bottom create a rigid shoulder which can retain thrust loads.



E Retainer Rings

The universally used radially assembled circlip for shafts. The groove is gripped by 3 tabs. Applications in vehicle construction, optical and electronic industry, and light mechanical industry. Cross reference to 1000, 1500, 5133,ms-16633 series. S.A.E. 1060-1090 Spring steel. Phosphate & oil finish. 10 pieces per pkg.



Reference Chart Available

See end of catalogue

PART#	IND#	SHAFT DECIMAL	SHAFT FRACTION	RING OUTSIDE DIA.	RING THICKNESS	GROOVE DIA.	GROOVE DEPTH	GROOVE WIDTH	WEIGHT (LB) /100 PIECES
22860	12	0.125	1/8"	0.23	0.015	0.10	0.02	0.02	0.0087
22861	18	0.188	3/16"	0.335	0.025	0.15	0.02	0.029	0.029
22862	25	0.25	1/4"	0.527	0.025	0.21	0.02	0.029	0.076
22863	31	0.312	5/16"	0.5	0.025	0.25	0.03	0.029	0.057
22864	37	0.375	3/8"	0.66	0.035	0.30	0.04	0.039	0.15
22865	43	0.438	7/16"	0.687	0.035	0.34	0.05	0.039	0.15
22866	50	0.5	1/2"	0.8	0.042	0.40	0.05	0.046	0.25
22867	62	0.625	5/8"	0.94	0.042	0.49	0.07	0.046	0.32
22868	75	0.75	3/4"	1.12	0.05	0.58	0.09	0.056	0.58
22869	87	0.875	7/8"	1.3	0.05	0.68	0.10	0.056	0.76
22870	98	0.984	1"	1.5	0.05	0.84	0.08	0.056	0.92
22871	118	1.188	1-3/16"	1.626	0.062	1.08	0.05	0.068	1.13
22872	137	1.375	1-3/8"	1.875	0.062	1.23	0.07	0.068	1.54

Sizes are approximate. Specifications subject to change without notice.



Internal Retainer Rings

The universally applicable rings for shafts and bores. Applications in all branches of industry and machine, instrument and vehicle construction. Cross reference to 1300, 3000, 5000, HO, MS-16625 series. S.A.E. 1060-1090 Spring steel. Phosphate and oil finish.

PART#	IND#	BORE DECIMAL	BORE FRACTION	RING OUTSIDE DIAMETER	RING THICKNESS	GROOVE DIAMETER	GROOVE DEPTH	GROOVE WIDTH	PKG. QTY.
22873	25	0.25	1/4"	0.28	0.015	0.27	0.01	0.02	10
22874	31	0.312	5/16"	0.346	0.015	0.33	0.01	0.02	10
22875	37	0.375	3/8"	0.415	0.025	0.40	0.01	0.029	10
22876	43	0.438	7/16"	0.482	0.025	0.46	0.01	0.029	10
22878	50	0.5	1/2"	0.548	0.035	0.53	0.02	0.039	10
22879	56	0.562	9/16"	0.62	0.035	0.60	0.02	0.039	10
22880	62	0.625	5/8"	0.694	0.035	0.67	0.02	0.039	10
22881	68	0.688	11/16"	0.763	0.035	0.73	0.02	0.039	10
22882	75	0.75	3/4"	0.831	0.035	0.80	0.02	0.039	10
22884	87	0.875	7/8"	0.971	0.042	0.93	0.03	0.046	10
22885	93	0.938	15/16"	1.041	0.042	1.00	0.03	0.046	10
22886	100	1	1"	1.111	0.042	1.07	0.03	0.046	10
22888	106	1.062	1-1/16"	1.18	0.05	1.13	0.03	0.056	10
22889	112	1.125	1-1/8"	1.249	0.05	1.20	0.04	0.056	10
22890	118	1.188	1-3/16"	1.319	0.05	1.26	0.04	0.056	10
22891	125	1.25	1-1/4"	1.388	0.05	1.33	0.04	0.056	10
22892	131	1.312	1-5/16"	1.456	0.05	1.40	0.04	0.056	10
22893	137	1.375	1-3/8"	1.526	0.05	1.46	0.04	0.056	10
22894	143	1.438	1-7/16"	1.596	0.05	1.53	0.05	0.056	10
22895	150	1.5	1-1/2"	1.66	0.05	1.59	0.05	0.056	10
22896	156	1.562	1-9/16"	1.734	0.062	1.66	0.05	0.068	10
22897	162	1.625	1-5/8"	1.804	0.062	1.73	0.05	0.068	10
22900	175	1.75	1-3/4"	1.942	0.062	1.86	0.05	0.068	10
22901	181	1.812	1-13/16"	2.012	0.062	1.92	0.06	0.068	10
22902	187	1.875	1-7/8"	2.072	0.062	1.99	0.06	0.068	10
22903	193	1.938	1-15/16"	2.141	0.062	2.06	0.06	0.068	10
22904	200	2	2"	2.21	0.062	2.12	0.06	0.068	10
22905	206	2.062	2-1/16"	2.28	0.078	2.19	0.06	0.086	5
22906	212	2.125	2-1/8"	2.35	0.078	2.25	0.06	0.086	5
22907	225	2.25	2-1/4"	2.49	0.078	2.38	0.07	0.086	5
22908	237	2.375	2-3/8"	2.63	0.078	2.52	0.07	0.086	5
22909	244	2.44	2-7/16"	2.702	0.078	2.58	0.07	0.086	5
22910	250	2.5	2-1/2"	2.775	0.078	2.65	0.07	0.086	5
22911	262	2.625	2-5/8"	2.91	0.093	2.78	0.08	0.103	5
22912	268	2.688	2-11/16"	2.98	0.093	2.85	0.08	0.103	5
22913	275	2.75	2-3/4"	3.05	0.093	2.91	0.08	0.103	5
22914	281	2.812	2-13/16"	3.121	0.093	2.98	0.08	0.103	5
22915	287	2.875	2-7/8"	3.191	0.093	3.05	0.09	0.103	2
22916	300	3	3"	3.325	0.093	3.18	0.09	0.103	2
22917	325	3.25	3-1/4"	3.623	0.109	3.45	0.10	0.12	2
22918	350	3.5	3-1/2"	3.89	0.109	3.71	0.11	0.12	2
22919	400	4	4"	4.424	0.109	4.24	0.12	0.12	2
22920	450	4.5	4-1/2"	4.94	0.109	4.74	0.12	0.12	2
22921	500	5	5"	5.485	0.109	5.26	0.13	0.12	2
22922	550	5.5	5-1/2"	6.066	0.125	5.77	0.14	0.139	2
22923	600	6	6"	6.62	0.125	6.27	0.14	0.139	2

Sizes are approximate. Specifications subject to change without notice.



Reference Chart Available

See end of catalogue



External Retainer Rings (Basic)

The universally applicable rings for shafts and bores. Applications in all branches of industry and machine, instrument and vehicle construction. Cross reference to 1300, 3000, 5000, HO, MS-16625 series. S.A.E. 1060-1090 spring steel. Phosphate and oil finish.

PART#	IND#	SHAFT DECIMAL	SHAFT FRACTION	RING OUTSIDE DIAMETER	RING THICKNESS	GROOVE DIAMETER	GROOVE DEPTH	GROOVE WIDTH	PKG. QTY.
22924	18	0.188	3/16"	0.168	0.015	0.18	0.01	0.018	10
22925	25	0.25	1/4"	0.225	0.025	0.23	0.01	0.029	10
22926	31	0.312	5/16"	0.281	0.025	0.29	0.01	0.029	10
22928	37	0.375	3/8"	0.338	0.025	0.35	0.01	0.029	10
22929	43	0.438	7/16"	0.395	0.025	0.41	0.01	0.029	10
22931	50	0.5	1/2"	0.461	0.035	0.47	0.02	0.039	10
22932	56	0.562	9/16"	0.521	0.035	0.53	0.02	0.039	10
22933	59	0.594	19/32"	0.55	0.035	0.56	0.02	0.039	10
22934	62	0.625	5/8"	0.579	0.035	0.59	0.02	0.039	10
22935	66	0.672	43/64"	0.621	0.035	0.63	0.02	0.039	10
22936	68	0.688	11/16"	0.635	0.042	0.65	0.02	0.046	10
22937	75	0.75	3/4"	0.693	0.042	0.70	0.02	0.046	10
22938	81	0.812	13/16"	0.751	0.042	0.76	0.03	0.046	10
22939	87	0.875	7/8"	0.81	0.042	0.82	0.03	0.046	10
22940	93	0.938	15/16"	0.867	0.042	0.88	0.03	0.046	10
22942	100	1	1"	0.925	0.042	0.94	0.03	0.046	10
22944	106	1.062	1-1/16"	0.982	0.05	1.00	0.03	0.056	10
22945	112	1.125	1-1/8"	1.041	0.05	1.06	0.03	0.056	10
22946	118	1.188	1-3/16"	1.098	0.05	1.12	0.04	0.056	10
22947	125	1.25	1-1/4"	1.156	0.05	1.18	0.04	0.056	10
22948	131	1.312	1-5/16"	1.214	0.05	1.23	0.04	0.056	10
22949	137	1.375	1-3/8"	1.272	0.05	1.29	0.04	0.056	10
22950	143	1.438	1-7/16"	1.333	0.05	1.35	0.04	0.056	10
22951	150	1.5	1-1/2"	1.387	0.05	1.41	0.05	0.056	10
22952	156	1.562	1-9/16"	1.446	0.062	1.47	0.05	0.068	10
22953	162	1.625	1-5/8"	1.503	0.062	1.53	0.05	0.068	10
22954	168	1.688	1-11/16"	1.56	0.062	1.59	0.05	0.068	10
22955	175	1.75	1-3/4"	1.618	0.062	1.65	0.05	0.068	10
22956	187	1.875	1-7/8"	1.735	0.062	1.77	0.05	0.06	10
22957	196	1.969	1-31/32"	1.819	0.062	1.86	0.06	0.068	10
22958	200	2	2"	1.85	0.062	1.89	0.06	0.068	10
22960	212	2.125	2-1/8"	1.964	0.078	2.00	0.06	0.086	5
22962	225	2.25	2-1/4"	2.081	0.078	2.12	0.07	0.086	5
22963	237	2.375	2-3/8"	2.197	0.078	2.24	0.07	0.086	5
22964	243	2.438	2-7/16"	2.255	0.078	2.30	0.07	0.086	5
22965	250	2.5	2-1/2"	2.313	0.078	2.36	0.07	0.086	5
22966	262	2.625	2-5/8"	2.428	0.078	2.48	0.07	0.086	5
22967	275	2.75	2-3/4"	2.543	0.093	2.60	0.07	0.103	2
22968	287	2.875	2-7/8"	2.659	0.093	2.72	0.08	0.1	2
22970	300	3	3"	2.775	0.093	2.84	0.08	0.1	2
22971	350	3.5	3-1/2"	3.237	0.109	3.32	0.09	0.12	2
22972	400	4	4"	3.7	0.109	3.79	0.10	0.12	2
22973	450	4.5	4-1/2"	4.223	0.109	4.31	0.10	0.12	2
22974	500	5	5"	4.692	0.109	4.79	0.11	0.12	2
22975	600	6	6"	5.631	0.125	5.75	0.13	0.139	2

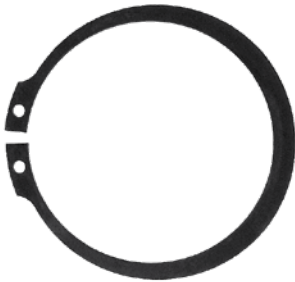

Reference Chart Available

See end of catalogue

Sizes are approximate. Specifications subject to change without notice.

Reference Charts

O-Rings - Reference Chart 290-292
Machinery Bushings 292-294
E Retainer Rings 294-295
Internal Retainer Rings..... 295-299
External Retainer Rings 300-301
Hair Pins 302-303
S-Hooks 303

Reference Charts

REFERENCE
CHARTS



Reference Charts

O-Rings

Reference Charts

O-RINGS - REFERENCE CHART

1-16 in. 1.588 mm

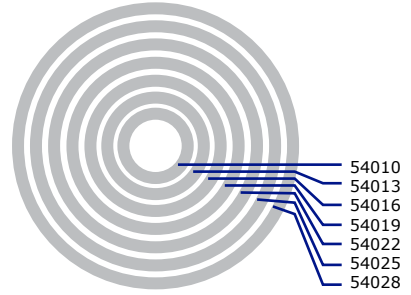
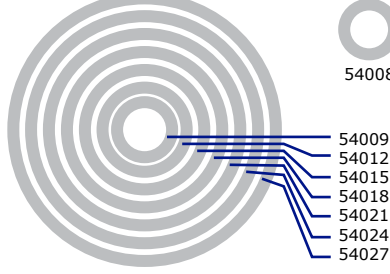
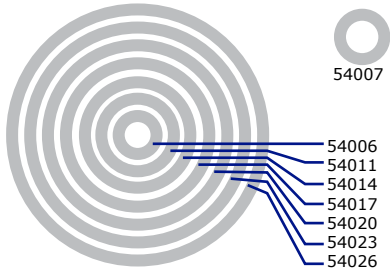

3/32 in. 2.382 mm

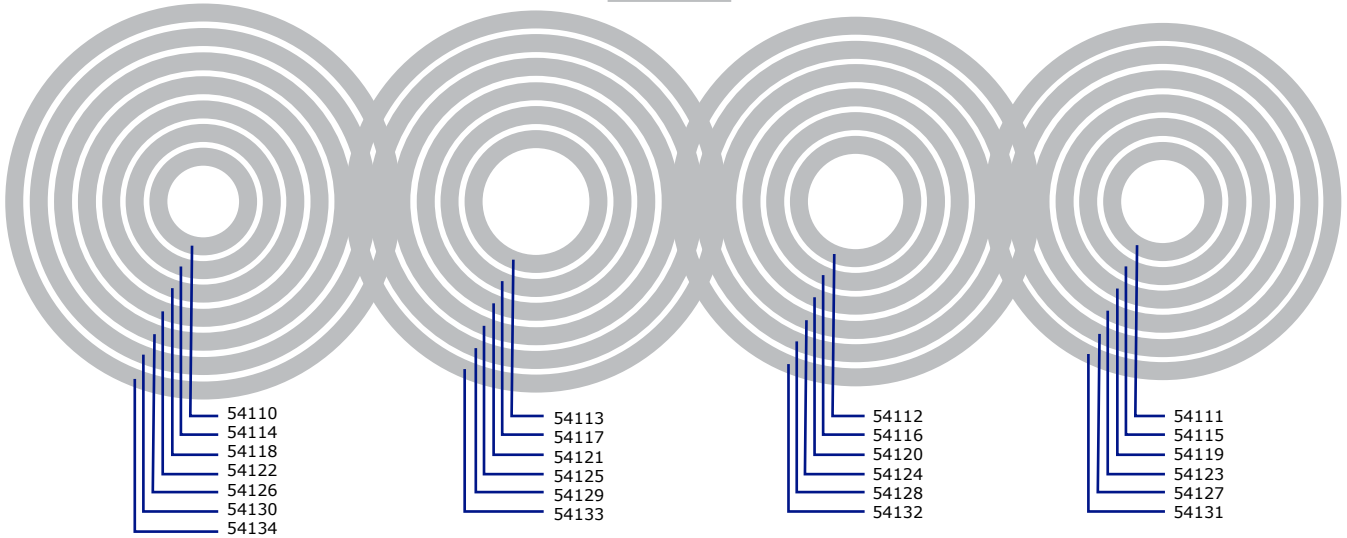

3/32 in. 2.382 mm

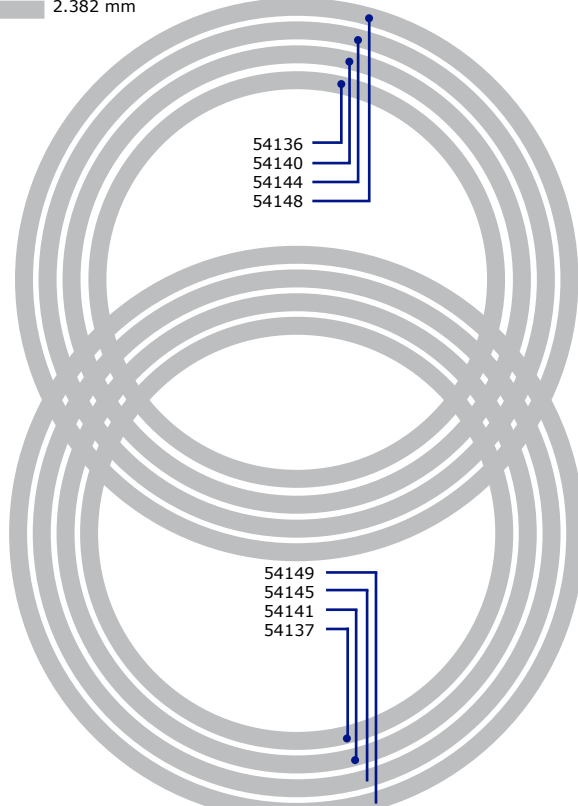
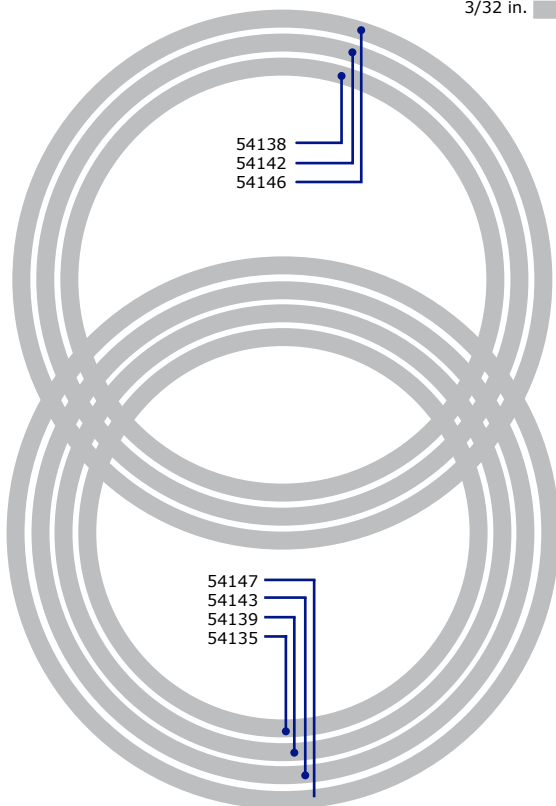

O-RINGS - REFERENCE CHART

1/8 in.  3.175 mm

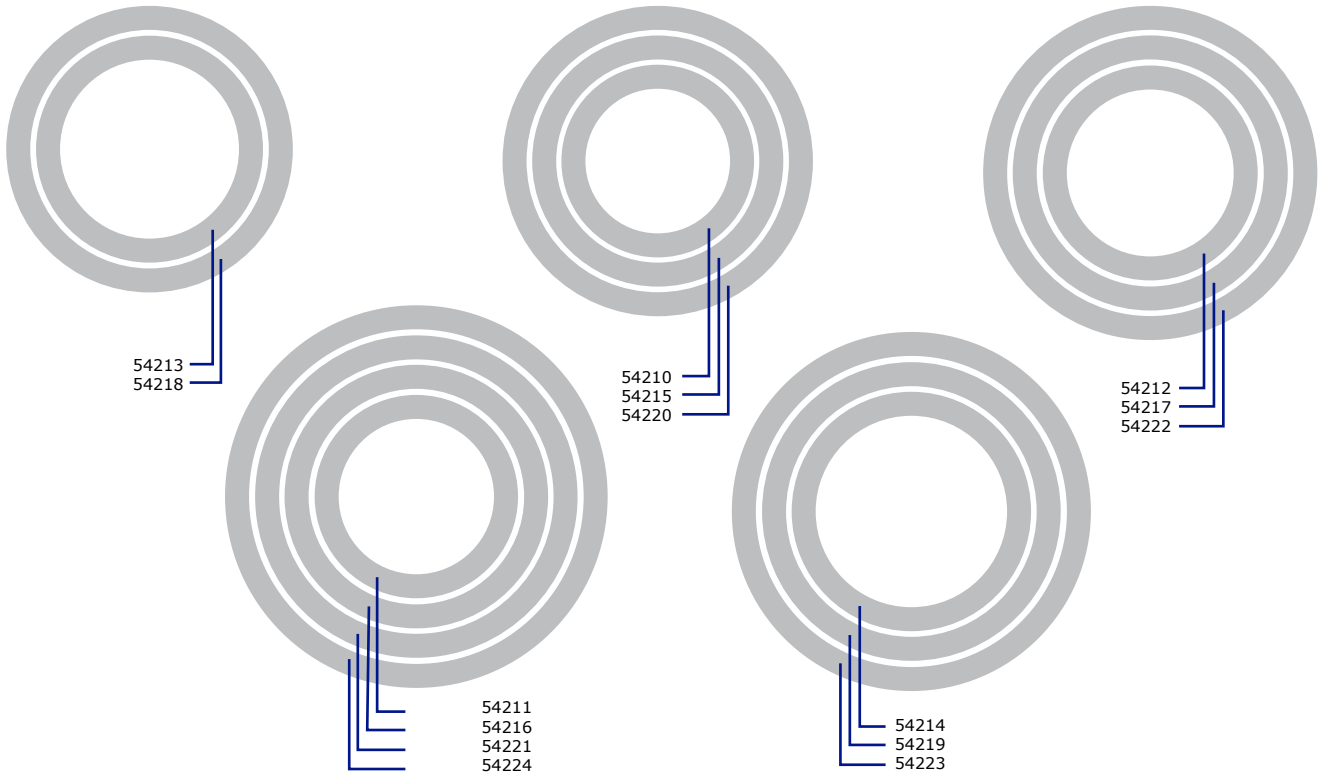

1/8 in.  3.175 mm

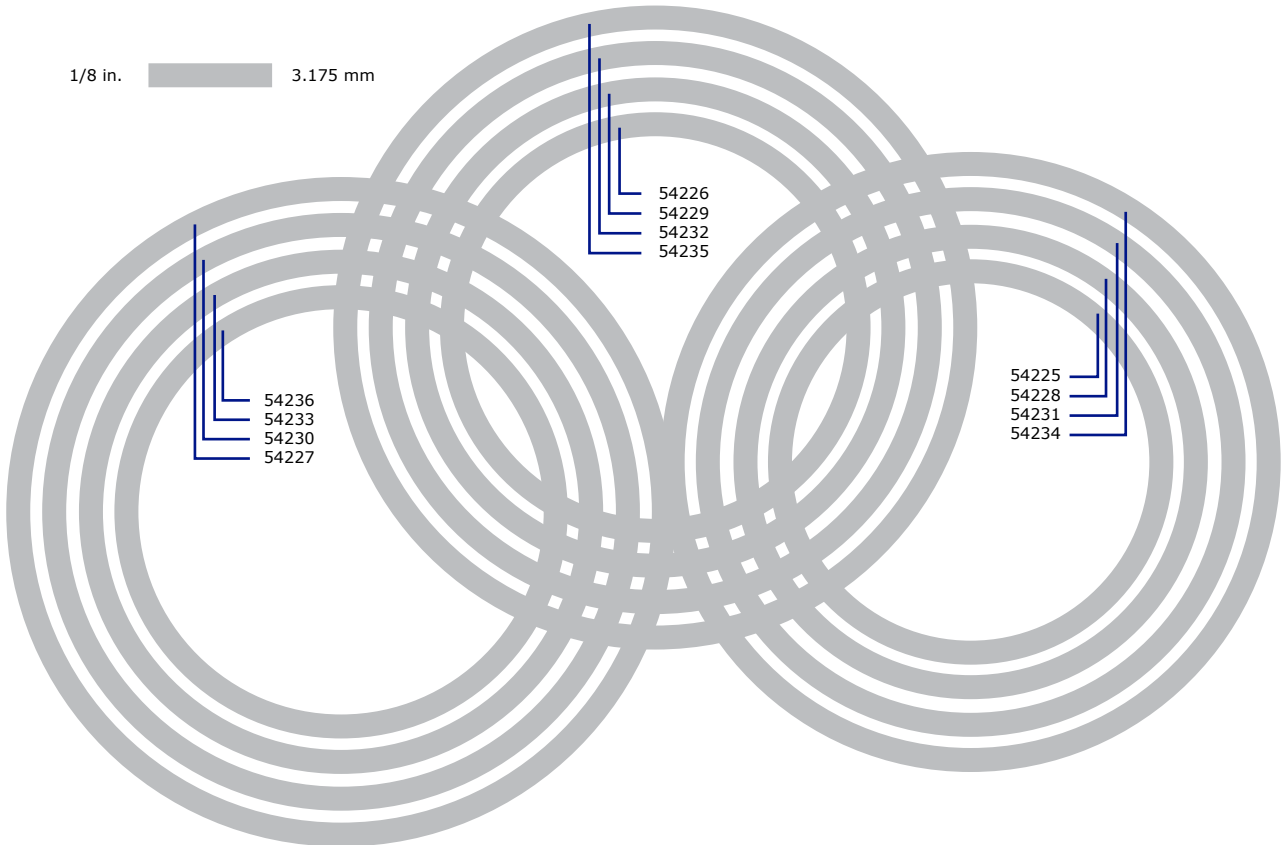

Reference Charts

O-Rings • Machinery Bushings

Reference Charts

O-RINGS - REFERENCE CHART

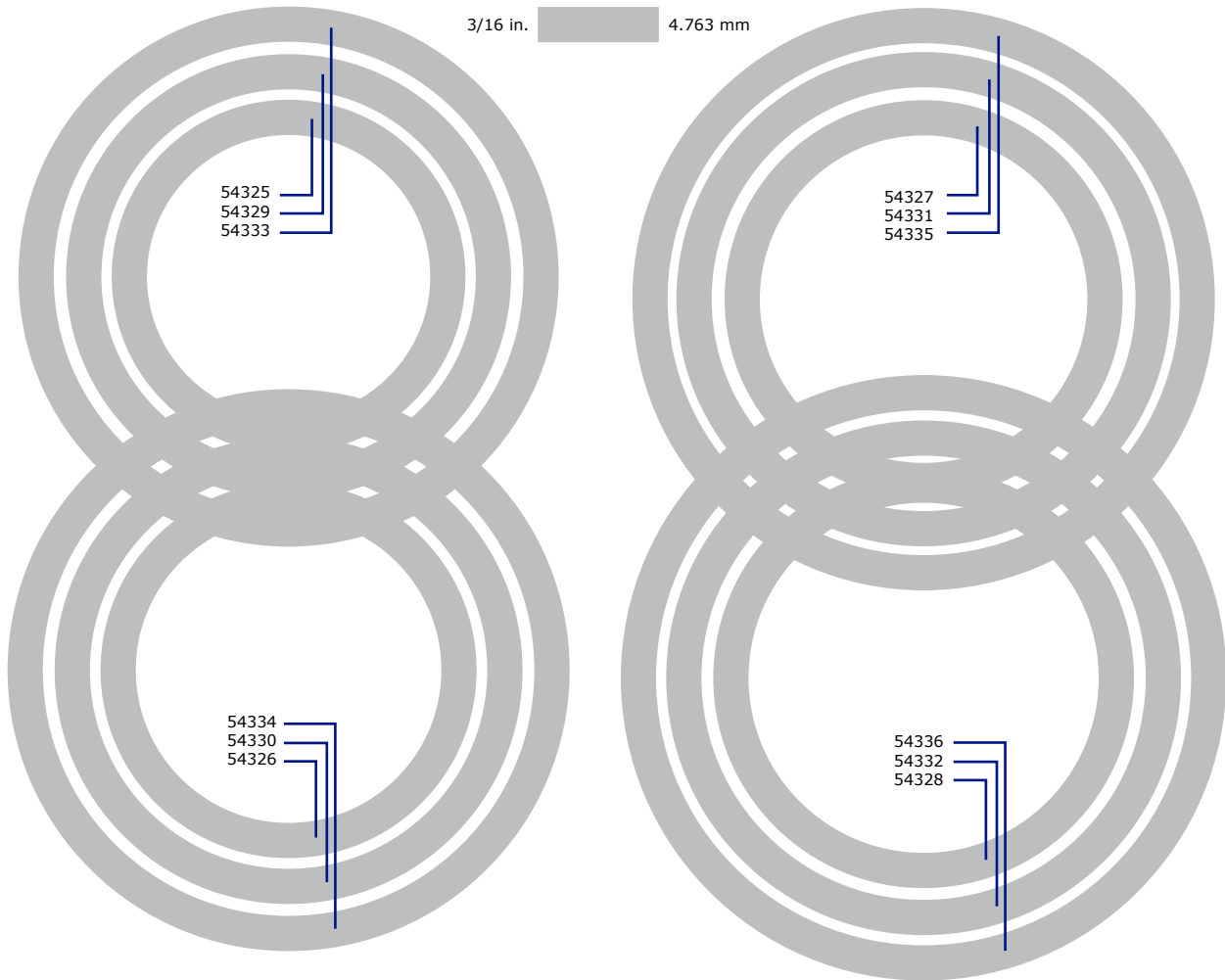

MACHINERY BUSHINGS - REFERENCE CHART

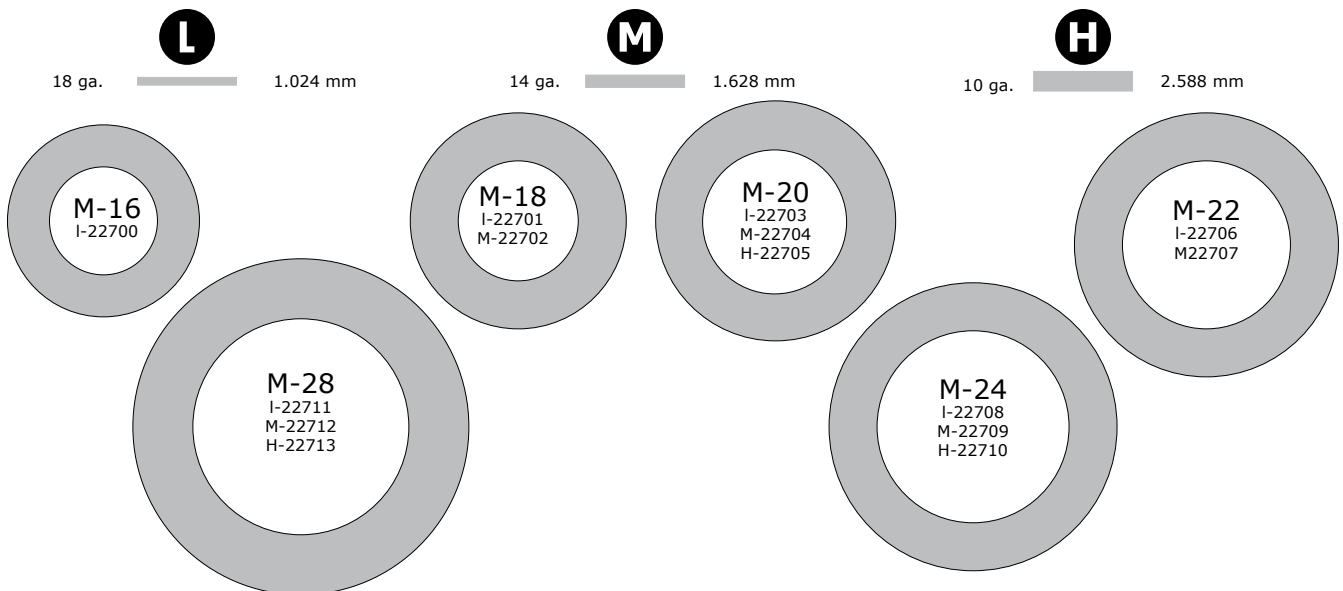

MACHINERY BUSHINGS - REFERENCE CHART

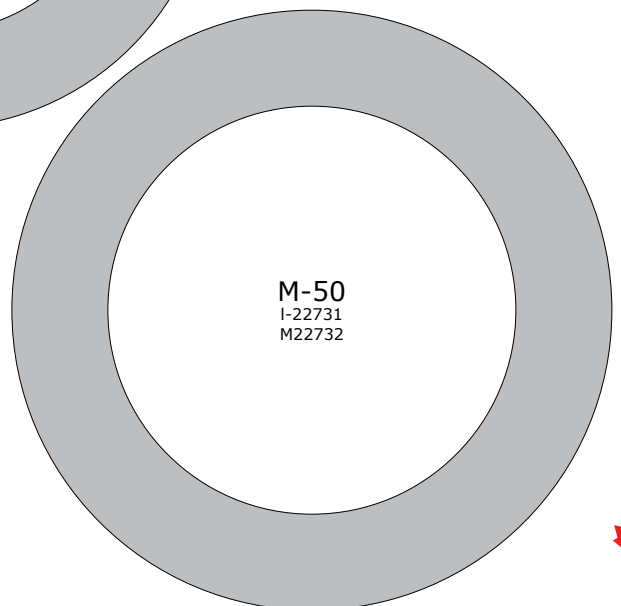
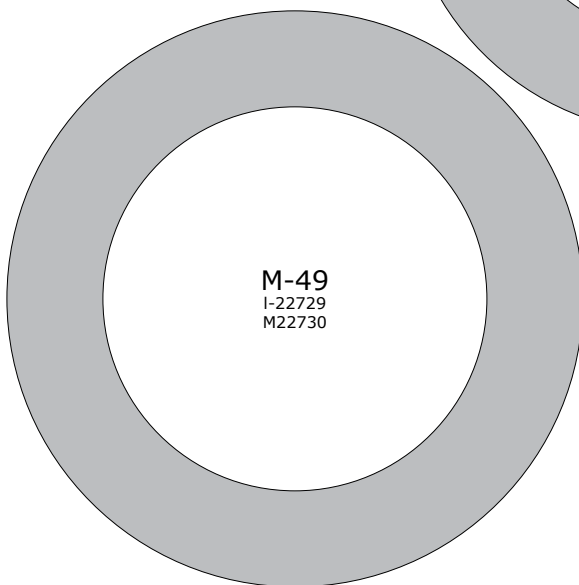
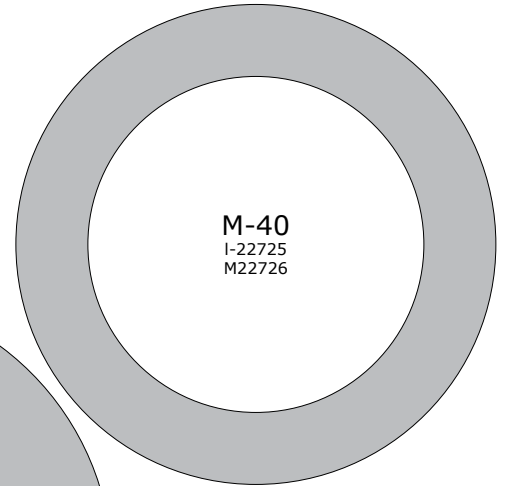
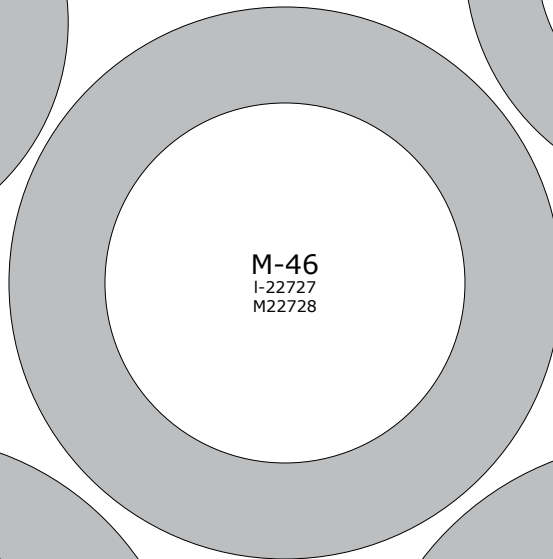
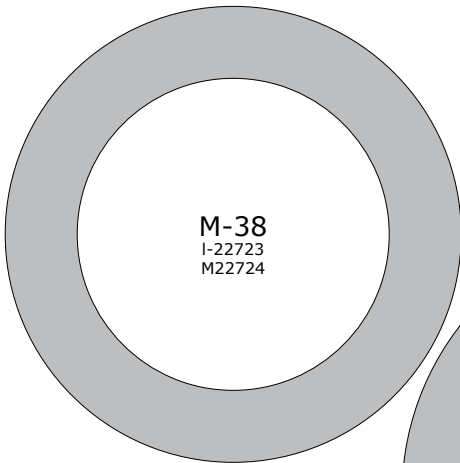
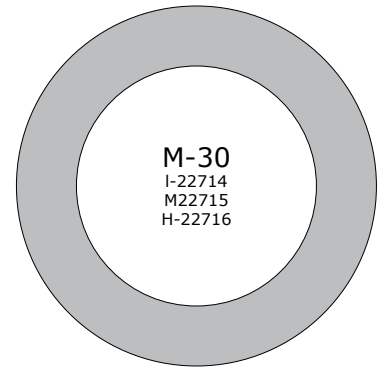
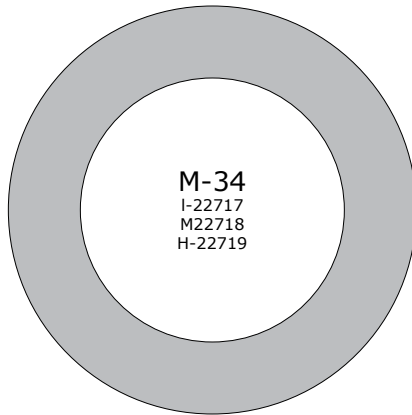
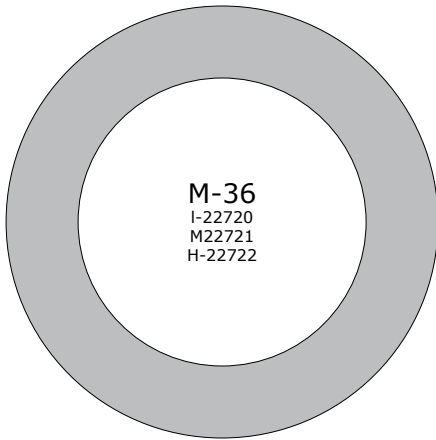

Reference Charts



Reference Charts

Machinery Bushings • E-Retainer Rings

Reference Charts

MACHINERY BUSHINGS - REFERENCE CHART

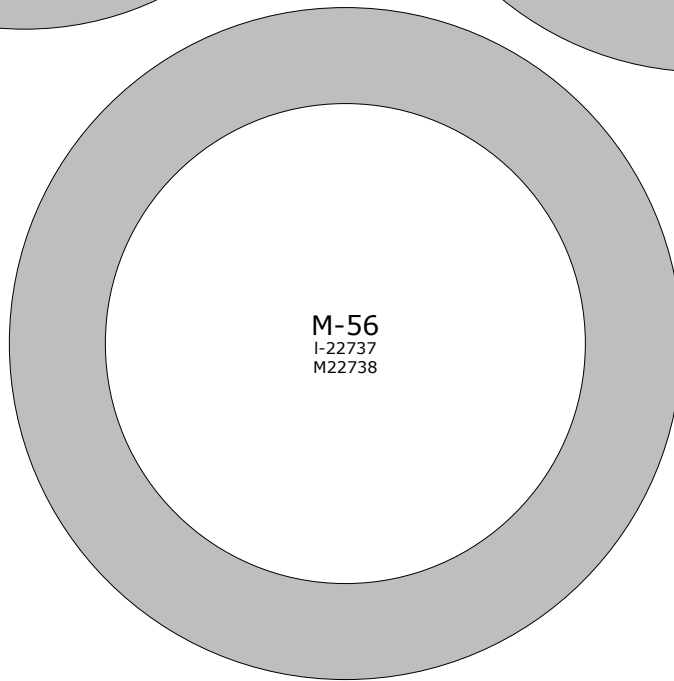
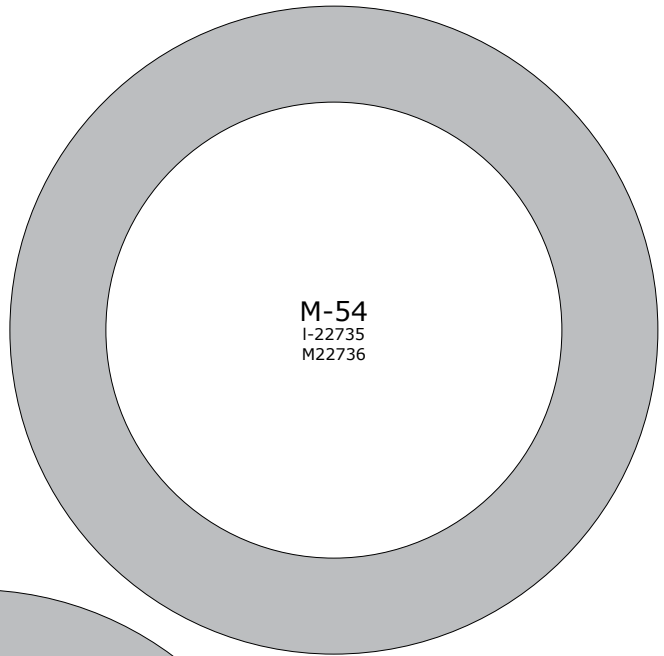
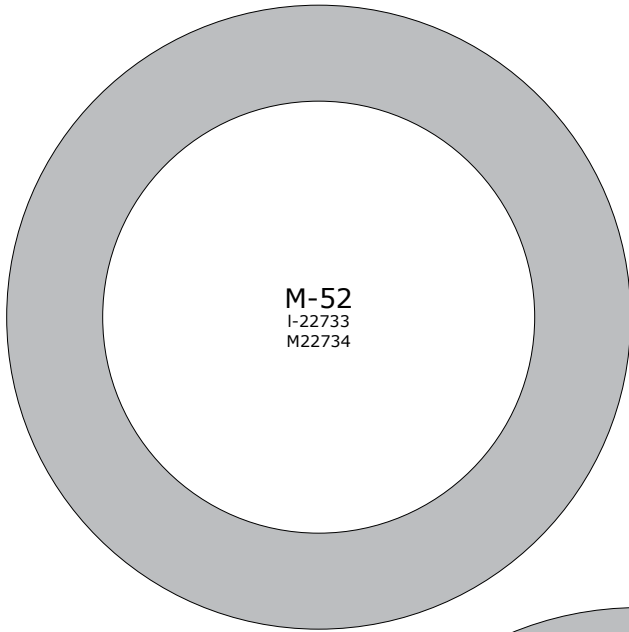

E RETAINER RINGS - REFERENCE CHART

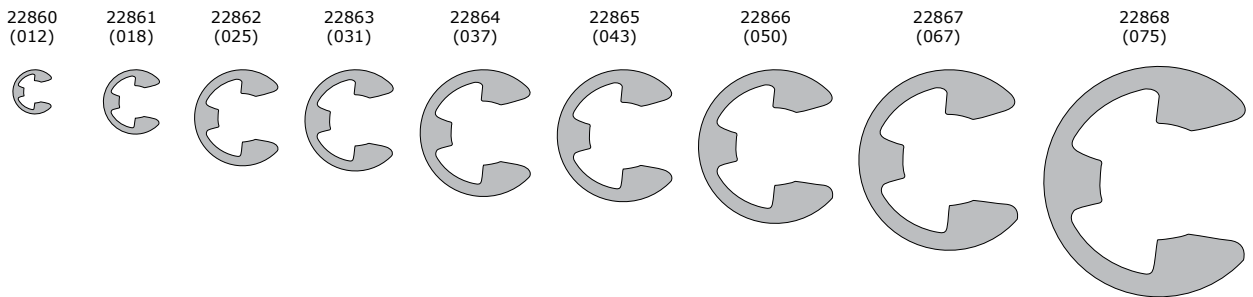

E RETAINER RINGS - REFERENCE CHART

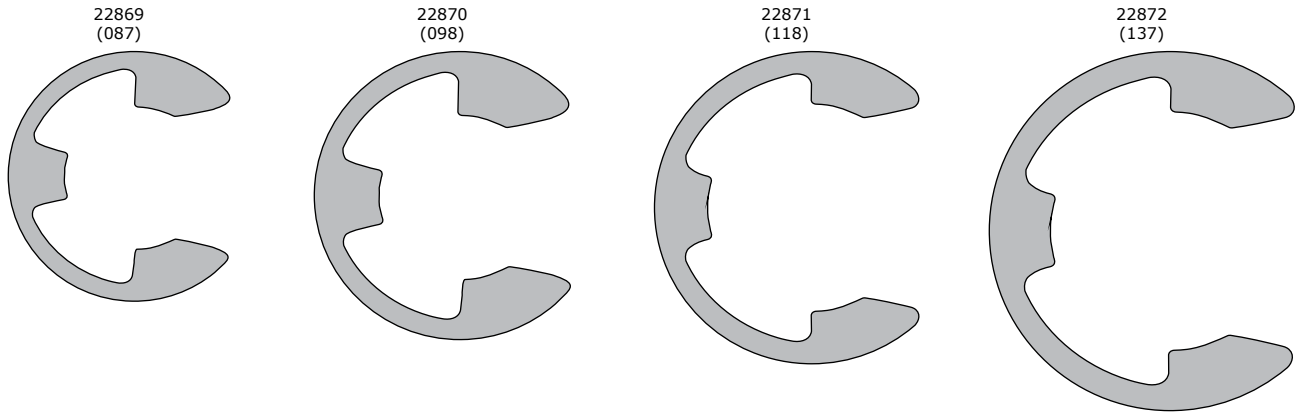

INTERNAL RETAINER RINGS - REFERENCE CHART

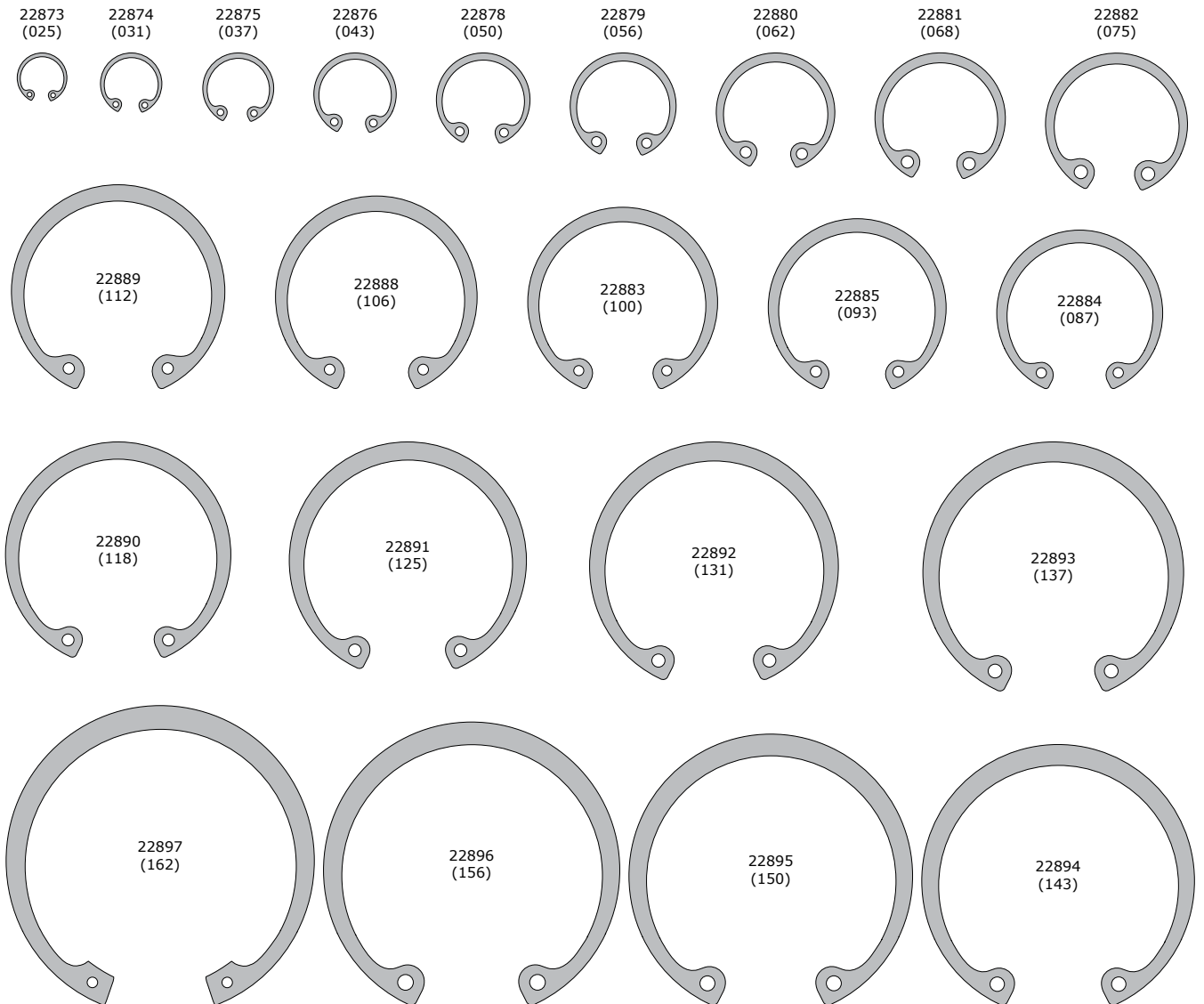

Reference Charts



Reference Charts

Internal Retainer Rings

INTERNAL RETAINER RINGS - REFERENCE CHART

Reference Charts

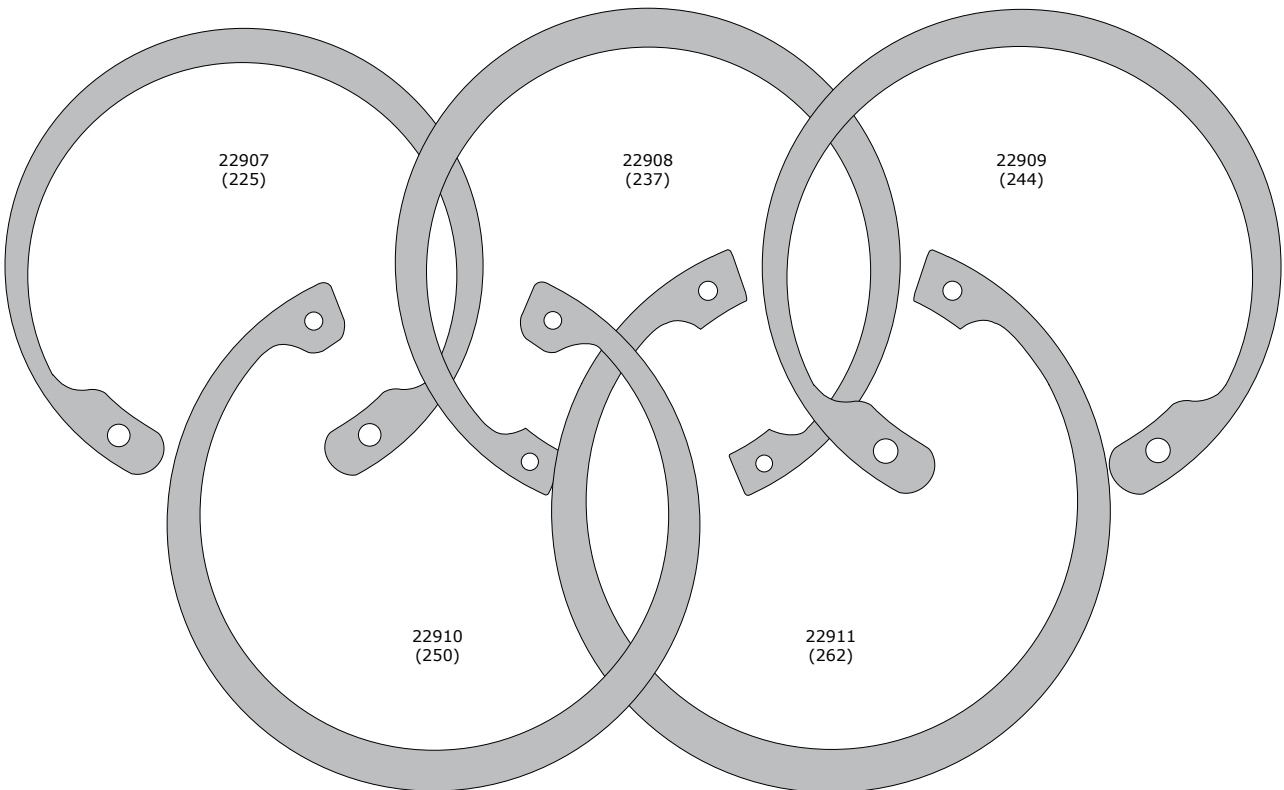
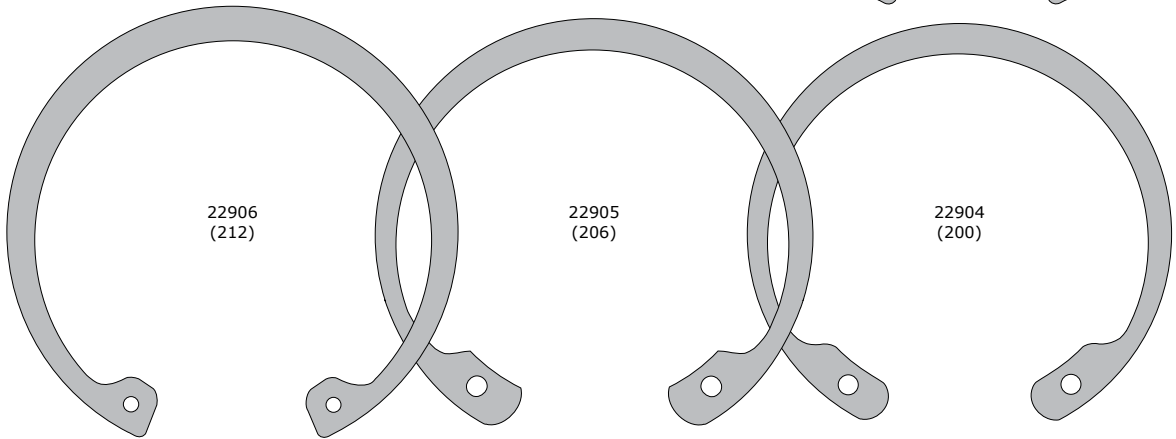
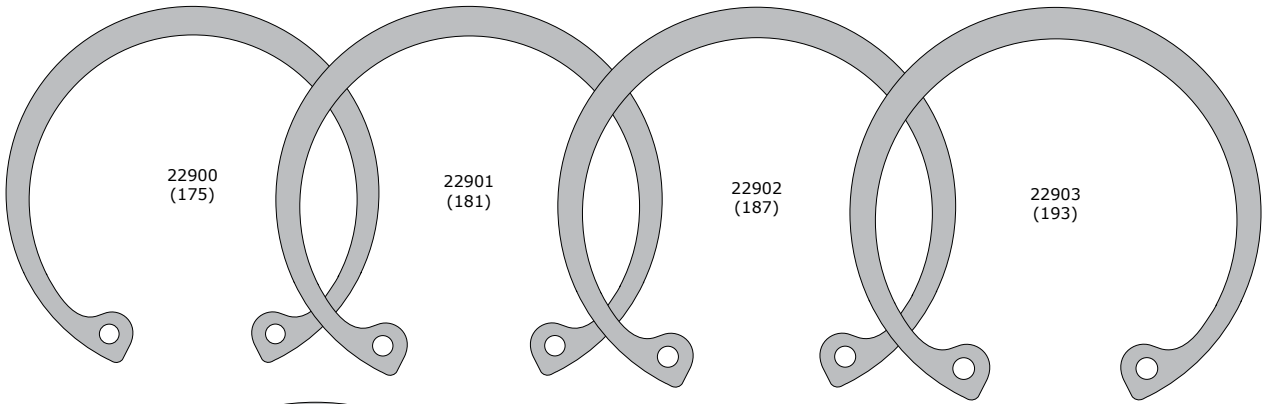

INTERNAL RETAINER RINGS - REFERENCE CHART

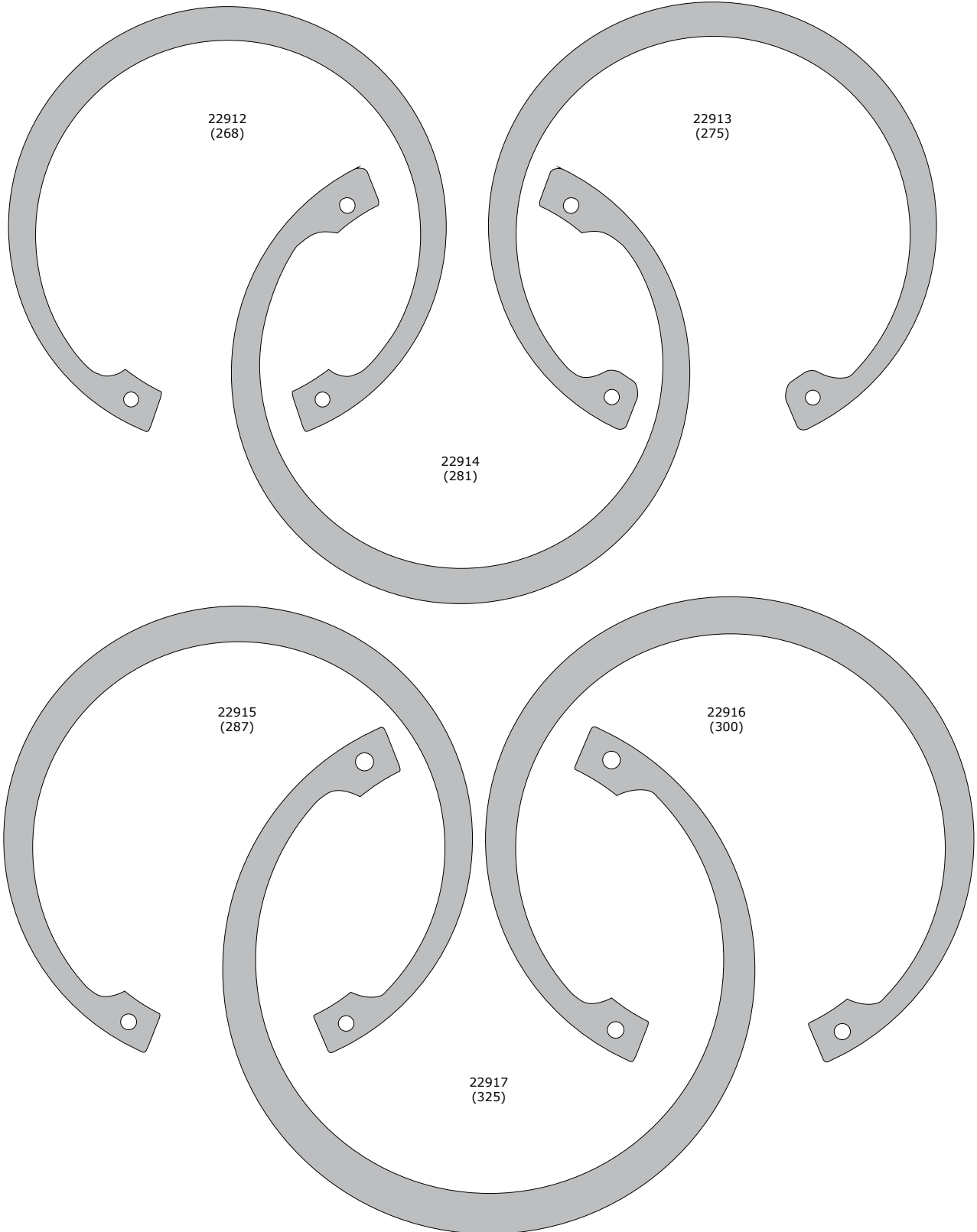

Reference Charts



Reference Charts

Internal Retainer Rings

INTERNAL RETAINER RINGS - REFERENCE CHART

Reference Charts

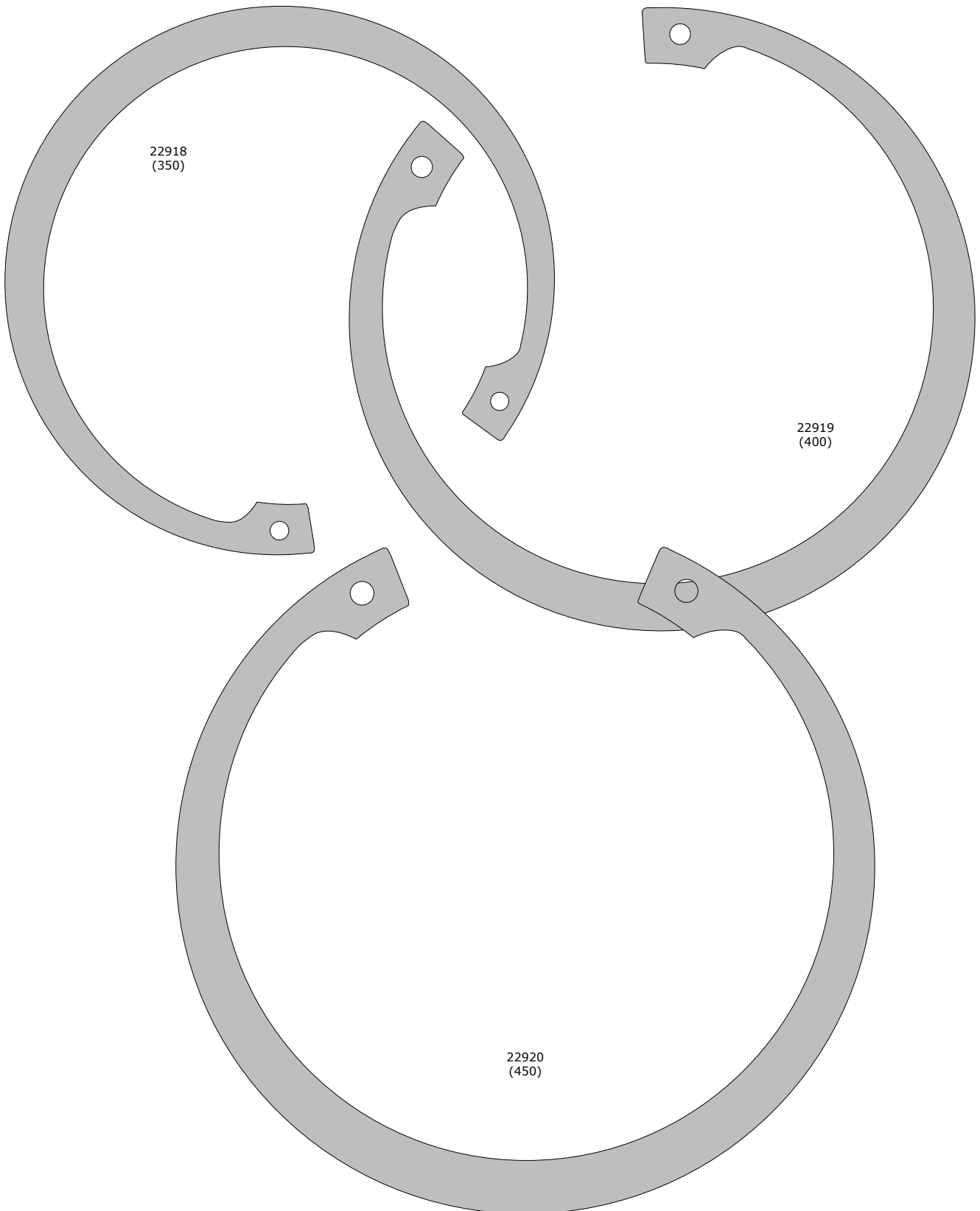

INTERNAL RETAINER RINGS - REFERENCE CHART

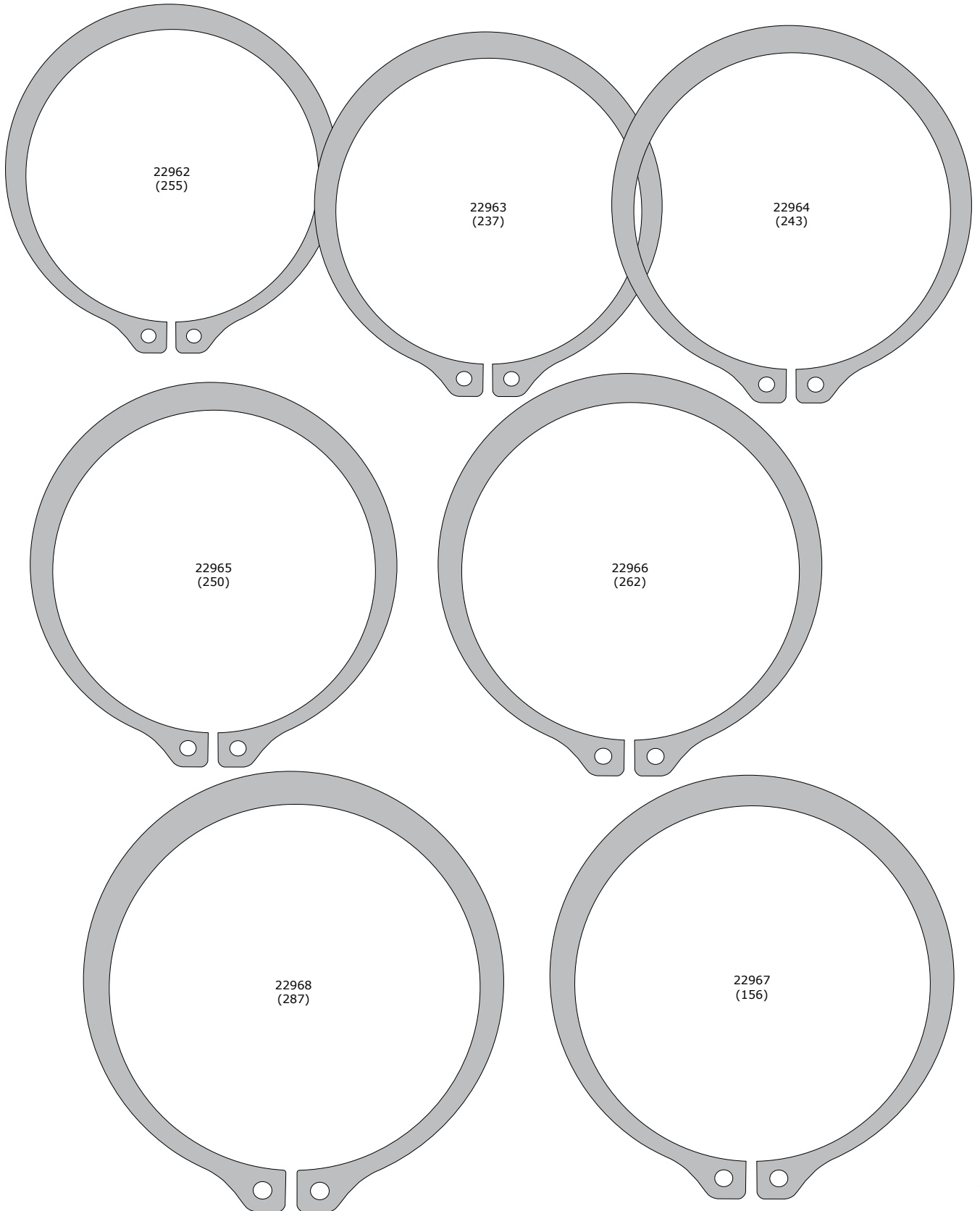

Reference Charts



Reference Charts

External Retainer Rings

EXTERNAL RETAINER RINGS - REFERENCE CHART

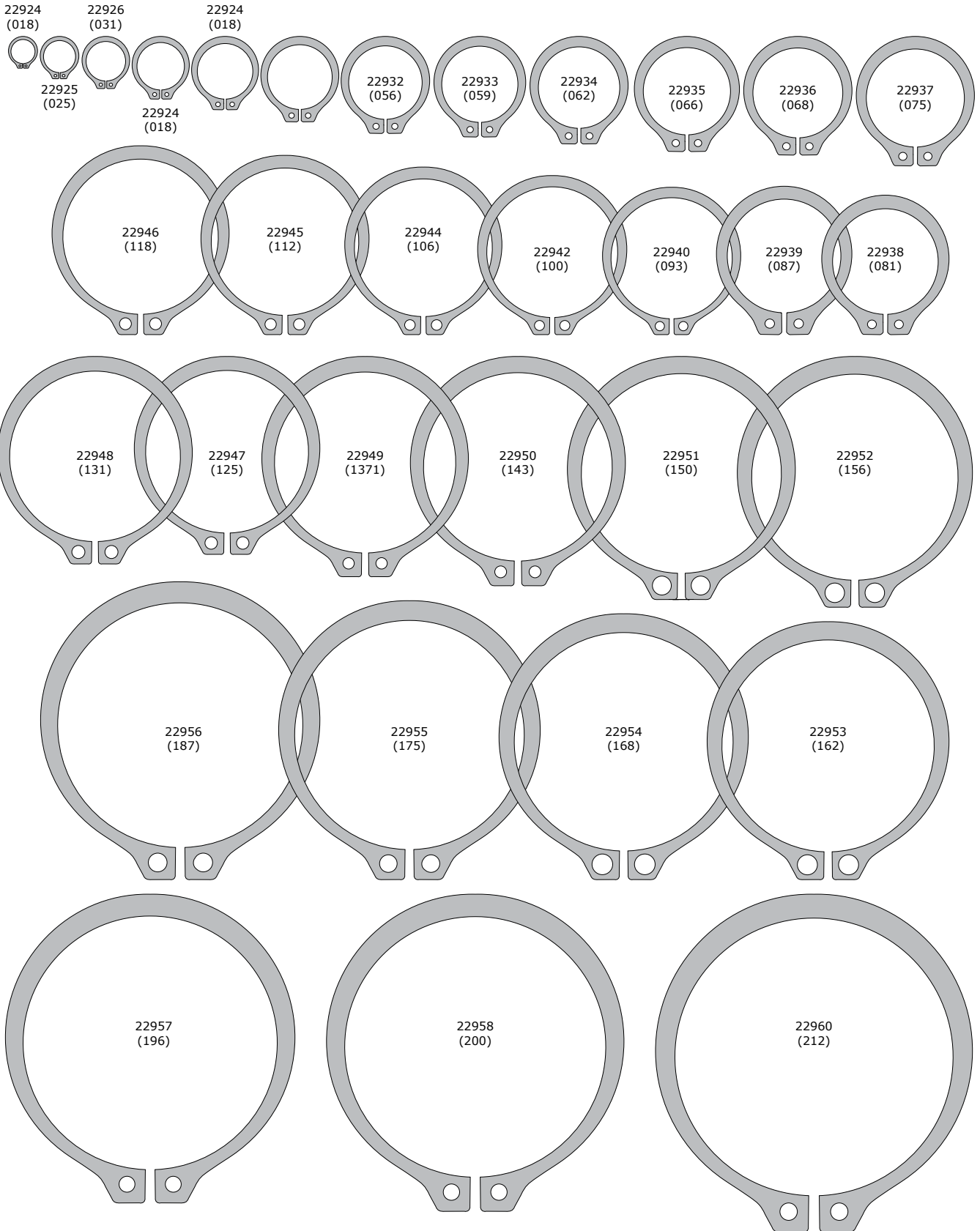

Reference Charts



EXTERNAL RETAINER RINGS - REFERENCE CHART

Reference Charts

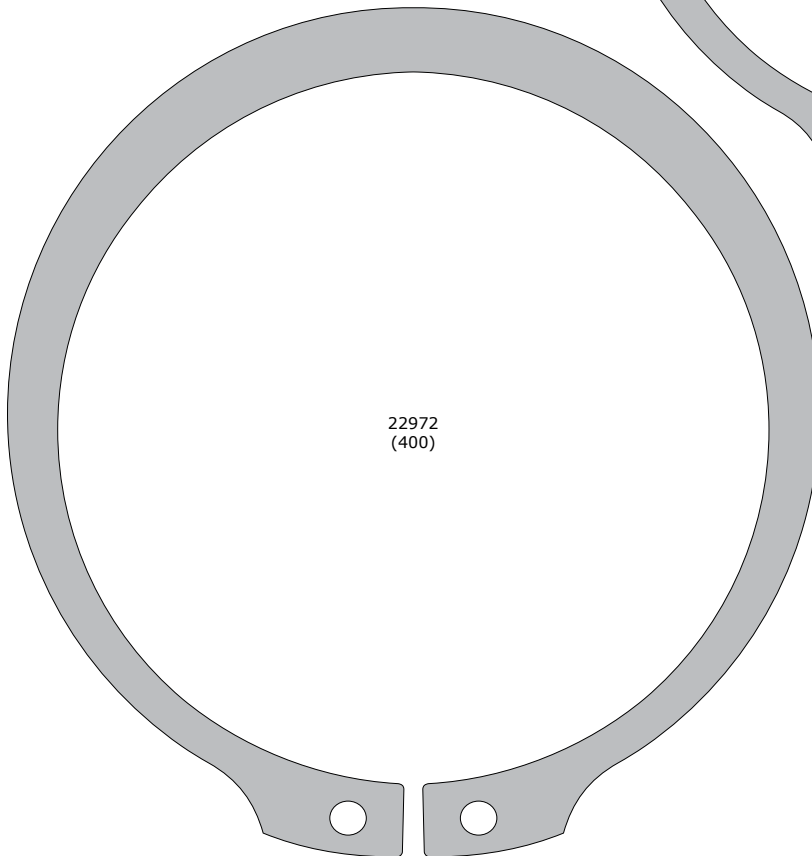
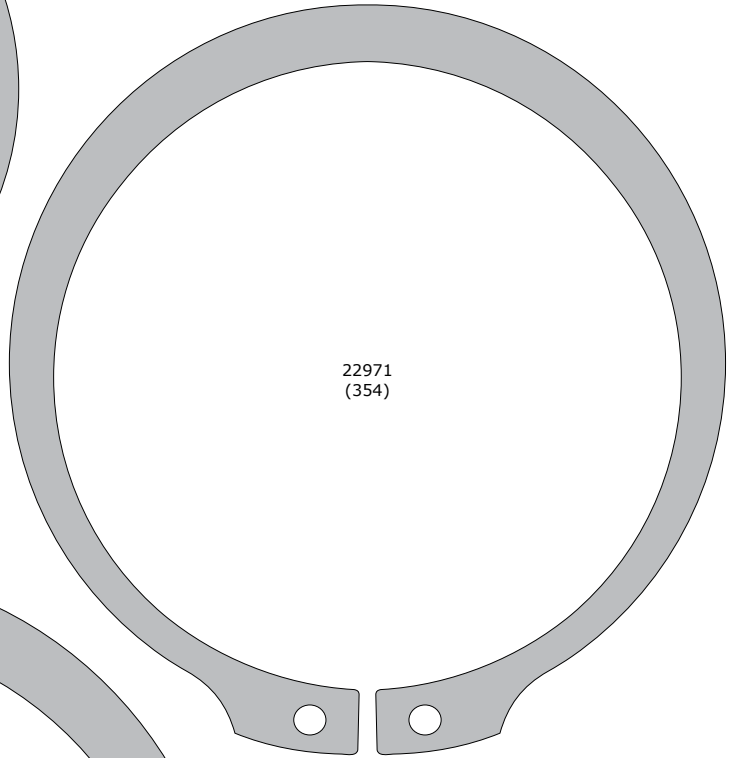
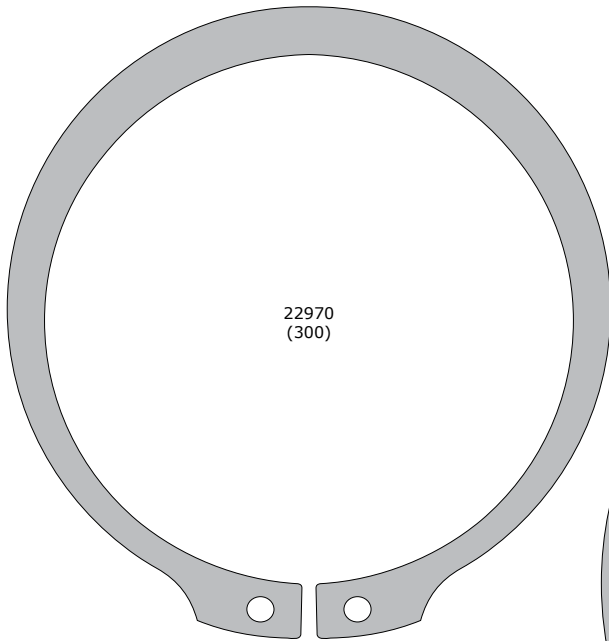

HAIR PINS - REFERENCE CHART

Reference Charts

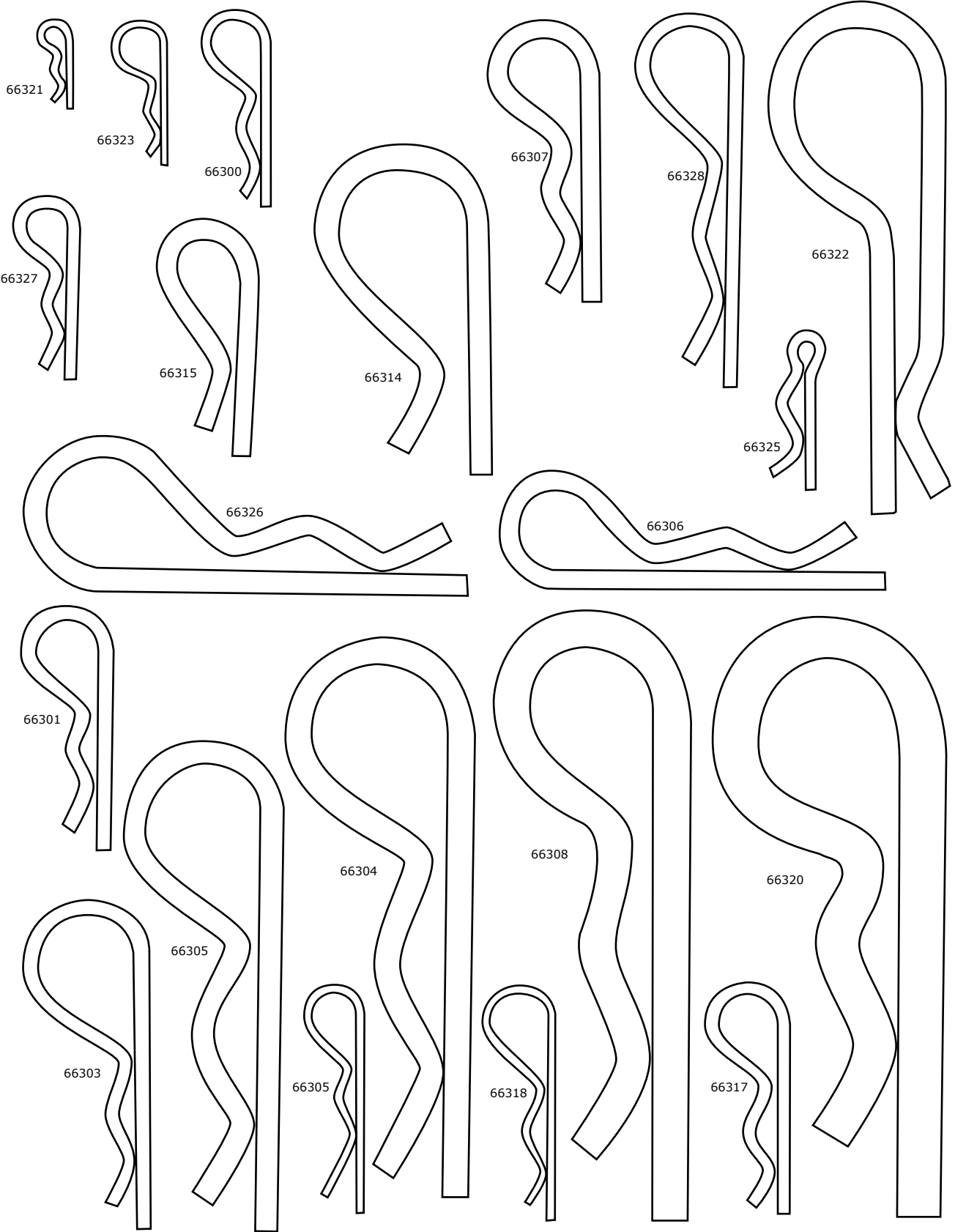

HAIR PINS - REFERENCE CHART

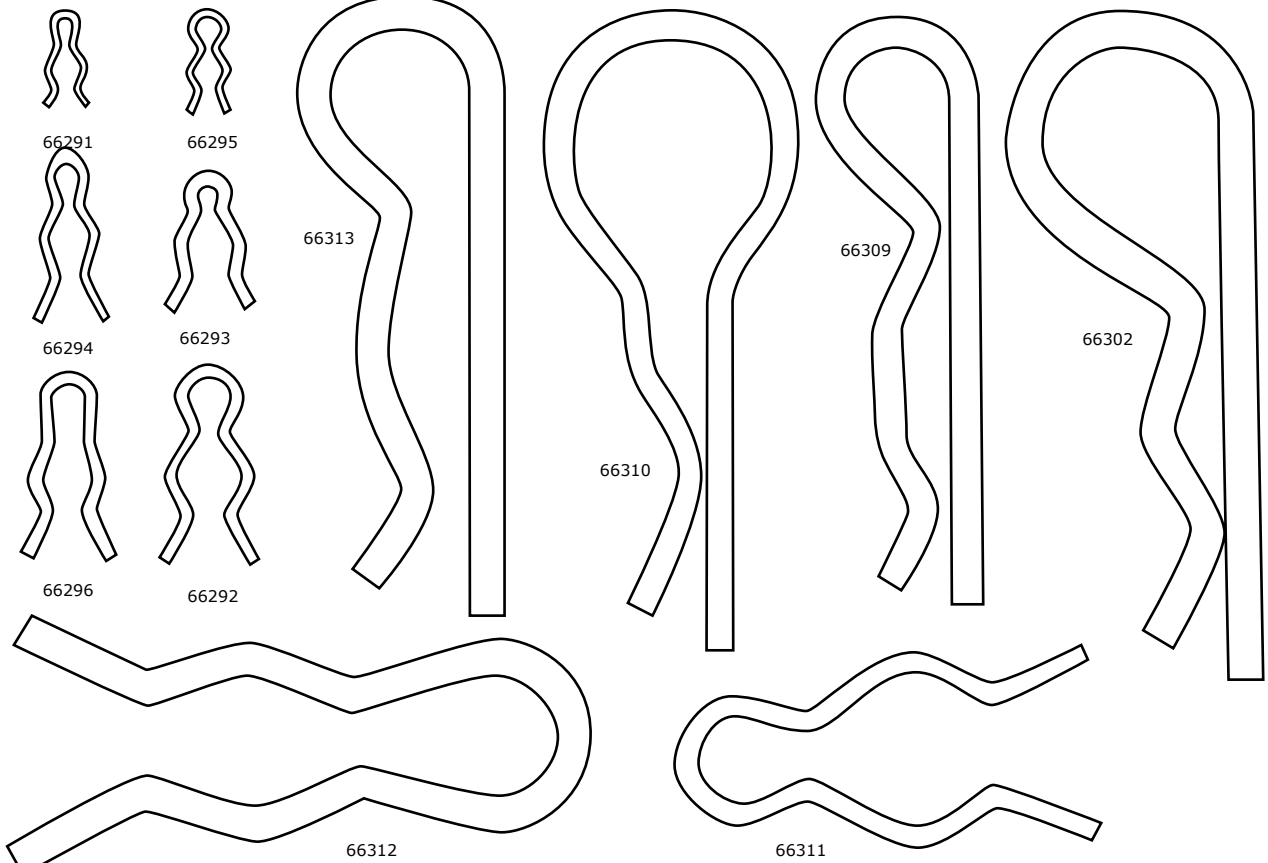

S-HOOKS

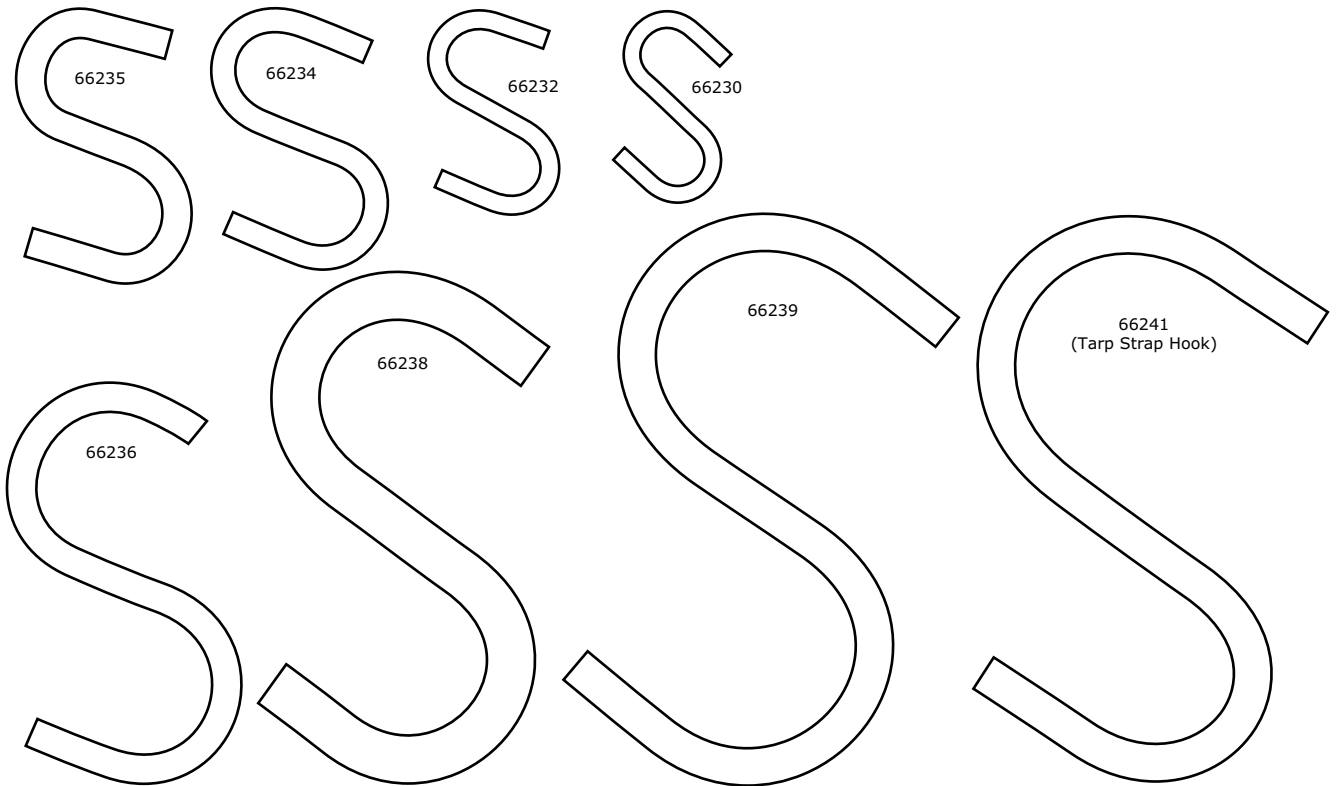

Reference Charts



Index

Part # Index



INDEX



Part # Index

PART #	PAGE #	PART #	PAGE #	PART #	PAGE #	PART #	PAGE #	PART #	PAGE #
00007	64	00215K	6	00435	43	01032K	15	11078	168
00024	4	00225	54	00435K	43	01041	9	11079A	168
00024-1	4	00225K	54	00436	43	01041K	9	11080A	167
00031	19	00226	45	00436K	43	01042	7	11081A	168
00031K	19	00226K	45	00438	44	01042K	7	11082C	163
00057	8	00235	49	00438K	44	01052	22	11083	163
00057K	8	00235K	49	00439	42	01052K	22	11084A	162
00063	17	00242	46	00439K	42	01081	30	11085A	163
00063K	17	00242K	46	00441	42	01081K	30	11087A	162
00108	187	00243	51, 278	00441K	42	01101	41	11089A	162
00112	187	00243C	51, 278	00447	39	01101K	41	11090A	164
00113	188	00243K	51, 278	00447K	39	100811	55	11091	164
00119	188	00244	47	00448	32	100854	58	11092A	165
00121	188	00244K	47	00448K	32	100859	58	11093	164
00133	189	00245	48	00465K	29	10100	189	11094	165
00140	195	00245K	48	00527	13	10101	190	11095	164
00141	195	00248	47	00527K	13	10102	190	11096	164
00150	196	00248K	47	00557	40	10103	190	11097	165
00151	196	00255K	51	00557K	40	10104	193	11100	169, 187
00152	196	00265K	51	00566	23	10105	191	11100A	169
00153	197	00275K	51	00566K	23	10106	191	11102	169, 187
00154	197	00285	51	00567	27	10107	191	11102A	169
00155	198	00296	19	00567K	27	10108	192	11104	169, 187
00156	198	00296K	19	00611	33	10109	187	11104A	169
00157	195	00297	44	00611K	33	10110	192	11105	169, 187
00158	198	00297K	44	00612	34	10111	192	11105A	169
00160	195	00300K	52	00612K	34	10112	193	11106	169
00161	195	00302K	53	00614	25	10113	193	11106A	169
00163	195	00307	34	00614K	25	10114	193	11107	169, 187
00164	195	00307K	34	00619	24	10115	194	11107A	169
00173	195	00318	12, 183	00619K	24	10117	194	11109	169, 187
00174	195	00318K	12, 183	00620	45	10118	194	11109A	169
00175	195	00325	38	00620K	45	10119	188	11110	169
00176	195	00325K	38	00626	16, 176	11020	99	11110A	169
00177	195	00334	35	00626K	16, 176	11021	161	11112	169
00178	195	00334K	35	00637	11	11023	161	11112A	169
00179	195	00335	36	00637K	11	11024	161	11113	169
00180	195	00335K	36	00716K	18	11025	161	11113A	169
00181	195	00386	26	00746K	50	11066	162	11114	169, 187
00182	195	00386K	26	00800	61	11070	163	11114A	169
00189	195	00408	26	00801	61	11071A	167	11115	169, 187
00208	6	00408K	26	01021	21	11072	167	11115A	169
00208K	6	00416	37	01021K	21	11073	163	11116	169, 187
00210	10	00416K	37	01031	14	11075A	167	11116A	169
00210K	10	00417	37	01031K	14	11076	167	11117	169, 187
00215	6	00417K	37	01032	15	11077	167	11117A	169



Part # Index

Part # Index

PART #	PAGE #	PART #	PAGE #	PART #	PAGE #	PART #	PAGE #	PART #	PAGE #
11118	169, 187	11154	133	11204	253	11303	208, 209	11371-2	267
11118A	169	11154P	134	11205	253	11304	208, 209	11373	267
11119	169, 187	11155	133	11206	253	11305	208, 209	11373-1	267
11119A	169	11155H	133	11207	253	11306	208, 209	11373-2	267
11120	169, 187	11155HP	134	11208	253	11308	208, 209	11373-3	267
11120A	169	11155P	134	11209	253	11309	208, 209	11400	169
11121	168	11155X	133	11210	253	11310	208, 209	11402	169
11121A	168	11155XP	134	11220	253	11311	210	11404	169
11122	167	11156	135	11225	253	11312	209	11405	169
11123A	167	11157	135	11226	253	11321	210	11406	169
11124A	167	11158	135	11227	253	11323	210	11407	169
11125	168	11159	135	11228	253	11324	210	11409	169
11125A	168	11159N	135	11229	253	11325	210	11410	169
11126	169, 187	11160	135	11230	253	11326	210	11412	169
11126A	169	11161	135	11231	253	11328	210	11413	169
11127	169, 187	11162	135	11232	253	11331	210	11414	169
11127A	169	11163	135	11233	253	11333	210	11415	169
11131	169	11164	135	11234	253	11334	210	11416	169
11131A	169	11166	210	11235	253	11335	210	11417	169
11132	169	11170	134	11236	253	11336	210	11418	169
11132A	169	11171	134	11237	253	11338	210	11419	169
11133	169	11174	201	11238	253	11345	208, 209	11420	169
11133A	169	11176	201	11239	253	11350	209	11426	169
11134	169	11177	201	11240	253	11351	269	11427	169
11134A	169	11178	201	11250	133	11352	269	11431	169
11135A	195	11182	203	11251	133	11354	269	11432	169
11136A	195	11183	203	11251P	134	11359	267	11433	169
11140	168	11183B	205	11252	133	11359-1	267	11434	169
11141	168	11184	203	11252P	134	11359-2	267	11463	153
11142	168	11185	203	11253	133	11359-3	267	11466	152
11142A	168	11186	204	11254	133	11359-4	267	11467	153
11143	168	11187	204	11255	133	11360	267	11468	154
11143A	168	11187B	205	11256	133	11360-1	267	11469	154
11144	168	11189	204	11257	133	11361	267	11470	154
11147	133	11189B	205	11258	133	11361-1	267	11471	154
11147P	134	11190	204	11259	133	11361-2	267	11472	154
11148	133	11190B	205	11260	133	11362	267	11473	154
11148P	134	11191	202	11261	133	11362-1	267	11474	154
11149	133	11192	202	11263	133	11363	267	11475	154
11149P	134	11193	202	11295	201	11369	267	11477	152
11151	133	11194	202	11296	201	11369-1	267	11477-1	157
11151P	134	11197	205	11297	201	11369-2	267	11479	154
11152	133	11200	253	11298	201	11369-3	267	11480	155
11152P	134	11201	253	11299	202	11369-4	267	11484	153
11153	133	11202	253	11300	208, 209	11371	267	11486	153
11153P	134	11203	253	11301	208, 209	11371-1	267	11487	155



PART #	PAGE #	PART #	PAGE #	PART #	PAGE #	PART #	PAGE #	PART #	PAGE #
11488	155	11595	143	11718	145	11988	158	12343	204
11488-1	157	11600	140	11719	145	11991	157	12343B	205
11490	156	11601	140	11720	145	11992	157	12344	203
11491	157	11602	140	11770	145	11993	157	12344B	205
11492	153	11603	140	11771	145	12052	99	12346	204
11492-1	153	11604	142	11772	145	12200	206	12353	203
11493	153	11605	142	11773	145	12201	206	12353B	205
11494	156	11606	143	11774	145	12203	206	12354	203
11495	156	11607	143	11775	145	12206	203	12354B	205
11498TC	99	11610	146	11780	144	12207	203	12370	204
11500	157	11611	140	11782	144	12208	206	12371	204
11501	157	11612	140	11784	144	12209	206	12713	99
11502	157	11618	145	11785	145	12210	206	12714	99
11505	157	11619	145	11786	145	12220TC	99	13000	170
11509	157	11620	145	11787	145	12226	204	13002	170
11510	155	11621	145	11788	145	12229B	205	13003	171
11513	157	11622	145	11789	145	12230	204	13005	171
11515	155	11630	146	11794	157	12235	207	13007	177
11520	155	11634	146	11800	165	12242	207	13008	172
11525	155	11635	146	11802	166	12243	207	13009	171
11526	155	11636	146	11802-1	166	12245	207	13015	172
11535	155	11641	141	11802-2	166	12246	207	13019	172
11540	155	11644	142	11802-3	166	12247	207	13030	170
11545	155	11645	142	11802-4	166	12248	207	13031	170
11548	268	11647	142	11802-5	166	12249	207	13100	173
11549	268	11648	142	11802-6	166	12250	211	13311	174
11550	268	11650	143	11802-7	166	12251	211	13314	174
11560	144	11652	143	11802-8	166	12252	211	13402	174
11561	144	11655	141	11804	166	12253	211	13404	174
11562	144	11660	140	11804-1	166	12254	211	13503	171
11563	136	11661	140	11806	166	12258	211	13504	171
11564	136	11662	140	11864	136	12259	211	13505	171
11565	136	11670	140	11865	136	12284	207	13506	171
11565TC	99	11671	140	11866	137	12285	207	13507	171
11566	136	11672	140	11867	137	12292	205	13508	171
11567	136	11686	141	11870	137	12297	205	13510	171
11568	136	11687	141	11880	137	12300	201	13511	171
11569	136	11688	141	11891	156	12302	201	13550	175
11579	143	11690	141	11895	156	12303	201	13604	170
11585	141	11691	141	11978	147	12320	204	13606	170
11586	140	11692	141	11980	147	12321	204	13607	170
11587	140	11693	143	11981	157	12331	203	13610	170
11588	140	11694	143	11982	157	12332	203	13617	170
11590	141	11715	146	11984	158	12340	204	13624	170
11591	141	11716	146	11985	158	12341	204	13811	175
11592	141	11717	146	11986	158	12342	204	14008	175



Part # Index

Part # Index

PART #	PAGE #	PART #	PAGE #	PART #	PAGE #	PART #	PAGE #	PART #	PAGE #
14013	173	22505	276	22548	276	22738	277	22879	287
14014	175	22509	276	22549	276	22750	275	22880	287
14015	172	22510	276	22550	276	22751	275	22881	287
14017	173	22511	276	22551	276	22752	275	22882	287
14018	173	22512	276	22552	276	22753	275	22884	287
14019	177	22513	276	22553	276	22754	275	22885	287
14022	177	22514	276	22554	276	22755	275	22886	287
14023	177	2251525	127	22555	276	22756	275	22888	287
14024	174	2251526	127	22700	277	22758	275	22889	287
14025	174	2251530	127	22701	277	22760	275	22890	287
14026	176	2251531	127	22702	277	22761	275	22891	287
14028	176	2251540	127	22703	277	22763	275	22892	287
14032	176	2251541	127	22704	277	22782	275	22893	287
14035	173	2251550	127	22705	277	22785	275	22894	287
14037	173	2251551	127	22706	277	22786	275	22895	287
14040	173	2251560	127	22707	277	22789	275	22896	287
14045	174	2251561	127	22708	277	22791	275	22897	287
14045X	174	2251740	127	22709	277	22792	275	22900	287
14047	174	2251741	127	22710	277	22795	275	22901	287
14140	175	22518	276	22711	277	22796	275	22902	287
15009	172	2251840	127	22712	277	22821	275	22903	287
15014	172	2251841	127	22713	277	22822	275	22904	287
16100	99	2251850	127	22714	277	22823	275	22905	287
16113	99	2251851	127	22715	277	22824	275	22906	287
16169	99	22519	276	22716	277	22825	275	22907	287
16170	99	22520	276	22717	277	22826	275	22908	287
17002	99	22521	276	22718	277	22827	275	22909	287
17004	99	22522	276	22719	277	22828	275	22910	287
17005	99	22523	276	22720	277	22860	286	22911	287
17008	99	22528	276	22721	277	22861	286	22912	287
17327	100	22529	276	22722	277	22862	286	22913	287
17328	100	22530	276	22723	277	22863	286	22914	287
17373	100	22531	276	22724	277	22864	286	22915	287
17374	100	22532	276	22725	277	22865	286	22916	287
17720	158, 264	2253540	127	22726	277	22866	286	22917	287
17722	147	2253541	127	22727	277	22867	286	22918	287
17730	158, 264	2253554	127	22728	277	22868	286	22919	287
17731	158, 264	22536	276	22729	277	22869	286	22920	287
17740	158, 264	22537	276	22730	277	22870	286	22921	287
17740-1	158, 264	22538	276	22731	277	22871	286	22922	287
19402	100	22539	276	22732	277	22872	286	22923	287
22500	276	22540	276	22733	277	22873	287	22924	288
22501	276	22541	276	22734	277	22874	287	22925	288
22502	276	22545	276	22735	277	22875	287	22926	288
22503	276	22546	276	22736	277	22876	287	22928	288
22504	276	22547	276	22737	277	22878	287	22929	288



Part # Index

PART #	PAGE #	PART #	PAGE #	PART #	PAGE #	PART #	PAGE #	PART #	PAGE #
22931	288	23058	139	24185	281	24329	282	24724	285
22932	288	23171	100	24187	281	24333	282	24730	285
22933	288	234439	126	24189	281	24337	282	24736	285
22934	288	234440	126	24191	281	24339	282	24740	285
22935	288	24001	280	24193	281	24500	283, 284	24742	285
22936	288	24005	280	24205	281	24510	283, 284	24750	285
22937	288	24013	280	24209	281	24516	283, 284	24752	285
22938	288	24019	280	24215	281	24520	283, 284	24756	285
22939	288	24023	280	24219	281	24526	283, 284	24766	285
22940	288	24025	280	24221	281	24530	283, 284	24768	285
22942	288	24029	280	24223	281	24532	283, 284	24782	285
22944	288	24031	280	24227	281	24550	283, 284	24792	285
22945	288	24033	280	24231	281	24554	283, 284	24802	285
22946	288	24051	280	24233	281	24556	283, 284	24806	285
22947	288	24055	280	24235	281	24562	283, 284	24814	285
22948	288	24063	280	24239	281	24566	283, 284	24818	285
22949	288	24067	280	24243	281	24570	283, 284	24822	285
22950	288	24069	280	24251	281	24576	283, 284	24826	285
22951	288	24073	280	24253	281	24578	283, 284	24830	285
22952	288	24077	280	24257	281	24580	283, 284	24832	285
22953	288	24081	280	24259	281	24582	283, 284	24834	285
22954	288	24083	280	24261	281	24600	283, 284	24836	285
22955	288	24103	280	24263	281	24604	283, 284	24838	285
22956	288	24105	280	24265	281	24608	283, 284	24850	285
22957	288	24111	280	24267	281	24612	283, 284	24856	285
22958	288	24115	280	24269	281	24614	283, 284	24858	285
22960	288	24117	280	24271	281	24624	283, 284	24864	285
22962	288	24119	280	24273	281	24632	283, 284	24874	285
22963	288	24131	280	24275	282	24650	283, 284	24878	285
22964	288	24133	280	24277	282	24652	283, 284	24892	285
22965	288	24135	280	24281	282	24660	283, 284	24900	282
22966	288	24139	280	24285	282	24664	283, 284	2550008	121
22967	288	24141	280	24287	282	24668	283, 284	2550009	121
22968	288	24143	280	24289	282	24672	283, 284	2550100	121
22970	288	24155	280	24293	282	24676	283, 284	2550151	121
22971	288	24157	280	24301	282	24680	283, 284	2550200	121
22972	288	24161	280	24303	282	24690	283, 285	2550406	120
22973	288	24163	280	24307	282	24692	283, 285	2550425	119
22974	288	24165	280	24311	282	24700	285	2550430	120
22975	288	24171	280	24313	282	24702	285	2550488	122
23050	238	24173	280	24315	282	24704	285	2551802	122
23051	238	24175	280	24317	282	24706	285	2553208	122
23052	238	24177	281	24319	282	24712	285	2554003	123
23053	238	24179	281	24321	282	24714	285	2554033	123
23054	238	24181	281	24323	282	24720	285	2554303	123
23057	139	24183	281	24325	282	24722	285	2554305	124

Part # Index



Part # Index

Part # Index

PART #	PAGE #	PART #	PAGE #	PART #	PAGE #	PART #	PAGE #	PART #	PAGE #
2554333	123	26007	278	26053	279	26099	279	31030	272
2554402	124	26008	278	26054	279	26100	279	31040	272
2554403	123	26009	278	26055	279	27002	148	31050	272
2554404	124	26010	278	26056	279	27004	148	31060	272
2554405	124	26011	278	26057	279	27006	148	31080	272
2554407	121	26012	278	26058	279	27008	148	31100	273
2554433	123	26013	278	26059	279	27010	148	31101	273
2555010	123	26014	278	26060	279	27015	148	31102	273
2555050	123	26015	278	26061	279	27020	148	31103	273
2555110	124	26016	278	26062	279	27022	148	32015	272
2555403	124	26017	278	26063	279	27024	148	32020	272
2555413	124	26018	278	26064	279	27030	149	32025	272
2558066	118	26019	278	26065	279	27034	149	32030	272
2558067	118	26020	278	26066	279	27036	149	32040	272
2558068	118	26021	278	26067	279	27040	149	32050	272
2558129	121	26022	278	26068	279	27042	149	32060	272
2558130	121	26023	278	26069	279	27044	149	32080	272
2558228	118	26024	278	26070	279	27046	149	33015	272
2558229	118	26025	278	26071	279	27048	149	33020	272
2558230	118	26026	278	26072	279	27050	149	33025	272
2558231	118	26027	278	26073	279	27052	149	33030	272
2558232	118	26028	278	26074	279	27054	150	33040	272
2558233	118	26029	278	26075	279	27056	150	33050	272
2558234	118	26030	278	26076	279	27060	150	33060	272
2558806	118	26031	278	26077	279	27062	150	33080	272
2558807	118	26032	278	26078	279	27064	150	33105	125
2558808	118	26033	278	26079	279	27066	150	33670	125
2560008	121	26034	278	26080	279	27068	150	33788	125
2560009	121	26035	278	26081	279	27075	150	33801	125
2560100	121	26036	278	26082	279	27076	151	33810	125
2560151	121	26037	279	26083	279	27078	151	33820	125
2560200	121	26038	279	26084	279	27080	151	33830	125
2560406	120	26039	279	26085	279	27082	151	33840	125
2560425	119	26040	279	26086	279	27084	151	33850	125
2560430	120	26041	279	26087	279	27086	151	33860	125
2560488	122	26042	279	26088	279	27088	151	33870	125
2561802	122	26043	279	26089	279	27090	151	33880	125
2562600	119	26044	279	26090	279	27092	151	33890	125
2563208	122	26045	279	26091	279	27093	151	33900	125
2568208	122	26046	279	26092	279	27096	151	38200	128
26001	278	26047	279	26093	279	27098	151	38220	128
26002	278	26048	279	26094	279	28327	254	38316	128
26003	278	26049	279	26095	279	28329	254	38325	128
26004	278	26050	279	26096	279	31015	272	38425	128
26005	278	26051	279	26097	279	31020	272	38450	128
26006	278	26052	279	26098	279	31025	272	38475	128



Part # Index

PART #	PAGE #	PART #	PAGE #	PART #	PAGE #	PART #	PAGE #	PART #	PAGE #
441802	126	51165	85	51338	88	51941	93	54129	179
441806	126	51166	85	51339	88	51948	93	54130	179
45274	100	51167	85	51340	88	52700	152	54131	179
50915	206	51170	85	51345	88	53945	93	54132	179
50920	206	51171	85	51353	88	54006	178, 196	54133	179
50921	206	51177	85	51360	88	54007	178	54134	179
50922	206	51178	85	51432	88	54008	178, 196	54135	179
50930	206	51181	85	51441	88	54009	178	54136	179
50935	206	51182	85	51443	88	54010	178, 196	54137	179
50936	206	51184	85	51445	88	54011	178, 196	54138	179
50937	206	51185	85	51446	88	54012	178, 196	54139	179
50938	206	51202	85	51451	88	54013	178	54140	179
50939	206	51214	85	51452	89	54014	178, 196	54141	179
51078-08	60, 91	51217	85	51453	89	54015	178	54142	179
51078-09	60, 82	51222	85	51456	89	54016	178	54143	179
51078-22	60, 98	51225	86	51459	89	54017	178	54144	179
51101	83, 100	51239	86	51472	89	54018	178	54145	179
51102	83	51241	86	51473	89	54019	178	54146	179
51103	83	51244	86	51474	89	54020	178	54147	179
51108	83	51245	86	51478	89	54021	178	54148	179
51111	83	51252	86	51479	89	54022	178	54149	179
51112	83	51262	86	51480	89	54023	178	54210	179, 196
51113	83	51265	86	51481	89	54024	178	54211	179, 196
51114	83	51270	86	51482	89	54025	178	54212	179, 196
51120	83	51275	86	51483	89	54026	178	54213	179, 196
51123	83	51277	86	51485	89	54027	178	54214	179, 196
51124	83	51282	86	51486	89	54028	178	54215	179, 196
51125	83	51283	86	51487	90	54110	178, 196	54216	179, 196
51126	83	51284	86	51489	90	54111	178, 196	54217	179, 196
51127	83	51285	86	51490	90	54112	178, 196	54218	179, 196
51130	83	51291	87	51493	90	54113	178, 196	54219	179, 196
51131	84	51292	87	51494	90	54114	178, 196	54220	179, 196
51135	84	51295	87	51495	90	54115	178, 196	54221	179, 196
51140	84	51296	87	51496	90	54116	178, 196	54222	179, 196
51141	84	51299	87	51498	90	54117	178, 196	54223	179, 196
51142	84	51301	87	51499	90	54118	178, 196	54224	179, 196
51146	84	51303	87	51590	87	54119	178	54225	179, 196
51150	84	51309	87	51631	88	54120	178	54226	179, 196
51157	84	51317	87	51657	93	54121	178	54227	179
51158	84	51318	87	51677	93	54122	178	54228	179
51159	84	51327	87	51682	93	54123	178	54229	180
51160	84	51328	87	51684	97	54124	178	54230	180
51161	84	51330	87	51691	93	54125	178	54231	180
51162	84	51331	87	51692	93	54126	178	54232	180
51163	84	51333	88	51694	93	54127	178	54233	180
51164	84	51334	88	51902	93	54128	179	54234	180

Part # Index



Part # Index

Part # Index

PART #	PAGE #	PART #	PAGE #	PART #	PAGE #	PART #	PAGE #	PART #	PAGE #
54235	180	54347	181	54530	182, 196	550470	120	55307	261
54236	180	54348	181	54531	182, 196	550480	120	55308	261
54237	180	54349	181	54532	182, 196	55050	70	55309	261
54238	180	54350	181	546750	119	55051	70	55310	261
54239	180	54425	181	546760	119	55052	70	55311	261
54240	180	54426	181	546900	119	55054	71	55312	261
54241	180	54427	181	546920	119	55055	71	55313	261
54242	180	54428	181	548687	119	55056	71	55314	261
54243	180	54429	181	548688	119	55057	70	55315	261
54244	180	54430	181	54901	183, 196	55058	70	55316	261
54245	180	54431	181	54902	183, 196	55080	69	55317	261
54246	180	54432	181	54903	183, 196	55081	69	55318	261
54247	180	54433	181	54904	183, 196	55082	69	55319	261
54248	180	54434	181	54905	183, 196	55083	69	55320	261
54249	180	54435	181	54906	183, 196	55100	59, 69	55321	261
54250	180	54436	181	54907	183, 196	55100K	59, 69	55322	261
54251	180	54437	181	54908	183, 196	55110	72	55323	261
54252	180	54501	182, 196	54909	183, 196	55111	72	55324	261
54253	180	54502	182, 196	54910	183, 196	55112	72	55325	261
54254	180	54503	182, 196	54911	183, 196	55113	72	55326	261
54255	180	54504	182, 196	54912	183, 196	55114	72	55327	261
54256	180	54505	182, 196	54913	183, 196	55120	73	55328	261
54257	180	54506	182, 196	54914	183, 196	55121	73	55329	261
54258	180	54507	182, 196	54916	183, 196	55122	73	55330	261
54325	180	54508	182, 196	54918	183, 196	55123	73	55331	261
54326	180	54509	182, 196	54920	183, 196	55124	73	55332	261
54327	180	54510	182, 196	54924	183, 196	55130	74	55333	261
54328	180	54511	182, 196	54928	183, 196	55131	74	55334	261
54329	180	54512	182, 196	54932	183, 196	55132	74	55335	261
54330	180	54513	182, 196	55000	253	55133	74	55336	261
54331	180	54514	182, 196	55001	253	55134	74	55337	261
54332	180	54515	182, 196	55002	253	55135	74	55338	261
54333	180	54516	182, 196	55003	253	55140	75	55339	261
54334	180	54517	182, 196	55004	253	55141	75	55340	261
54335	180	54518	182, 196	55005	253	55142	75	55341	261
54336	180	54519	182, 196	55007	253	55143	75	55342	261
54337	181	54520	182, 196	55008	253	55144	75	55343	261
54338	181	54521	182, 196	55009	253	55150	71	55344	261
54339	181	54522	182, 196	55011	253	55151	71	55345	261
54340	181	54523	182, 196	55012	253	55300	261	55346	261
54341	181	54524	182, 196	55013	253	55301	261	55347	261
54342	181	54525	182, 196	55014	253	55302	261	55348	261
54343	181	54526	182, 196	55030	254	55303	261	55349	261
54344	181	54527	182, 196	55031	254	55304	261	55350	261
54345	181	54528	182, 196	550440	120	55305	261	55400	235
54346	181	54529	182, 196	550460	121	55306	261	55401	235



Part # Index

PART #	PAGE #	PART #	PAGE #	PART #	PAGE #	PART #	PAGE #	PART #	PAGE #
55402	235	55813	236	56026	129	56221	96	64108	245
55403	235	55840	237	56027	129	56222	96	64109	245
55404	235	55841	237	56102	93	56223	96	64110	245
55405	235	55842	237	56111	93	56224	96	64111	245
55406	235	55843	237	56122	93	56225	96	64112	245
55407	235	55850	237	56123	93	56227	96	65006	239
55408	235	55851	237	56125	93	56229	97	65017	239
55409	235	55852	237	56126	94	56230	97	65018	239
55410	235	55853	237	56128	94	56231	97	65019	239
55411	235	55860	237	56130	94	568687	119	65024	239
55412	235	55861	237	56131	94	568688	119	65031	239
55413	235	55862	237	56143	94	60743	100	65040	239
55414	235	55863	237	56144	94	61205	212	65041	239
55415	235	55870	237	56146	94	62120	100	65042	239
55416	235	55871	237	56147	94	62205	212	65043	239
55417	235	55872	237	56150	94	64000	227	65044	239
55418	235	55873	237	56160	94	64001	227	65070	239
55419	235	55880	237	56162	94	64002	227	65071	239
55420	235	55881	237	56163	94	64003	227	65072	239
55421	235	55882	237	56168	94	64004	227	65073	239
55422	235	55883	237	56169	94	64020	230	65074	239
55423	235	55890	238	56170	94	64021	230	65075	239
55424	235	55891	238	56172	95	64022	230	65076	239
55425	235	55892	238	56175	95	64023	230	65077	239
55426	235	55893	238	56181	95	64024	230	65085	138
55427	235	55900	235	56188	95	64040	230	65086	138
55428	235	55901	235	56189	95	64041	230	65087	138
55429	235	55902	235	56191	95	64042	230	65088	158
55430	235	55903	235	56193	95	64043	230	65089	158
55431	235	55904	235	56197	95	64044	230	65090	158
55433	235	55906	236	56199	95	64060	225	65091	139
55434	235	55907	236	56200	95	64061	225	65092	139
55490	235	55908	236	56201	95	64062	225	65093	139
55491	235	55909	236	56203	95	64063	225	65102	240
55492	235	559110	122	56205	95	64070	250	65104	240
556750	119	55915	236	56206	95	64071	250	65106	240
556760	119	55916	236	56208	95	64072	250	65107	240
556900	119	55917	236	56209	96	64073	250	65108	240
556920	119	55918	236	56210	96	64100	245	65109	240
55800	236	55919	236	56213	96	64101	245	65110	240
55801	236	55925	236	56215	96	64102	245	65111	240
55802	236	55926	236	56216	96	64103	245	65112	240
55803	236	55927	236	56217	96	64104	245	65113	240
55810	236	55928	236	56218	96	64105	245	65114	240
55811	236	56006	254	56219	96	64106	245	65115	240
55812	236	56010	254	56220	96	64107	245	65117	240

Part # Index



Part # Index

Part # Index

PART #	PAGE #	PART #	PAGE #	PART #	PAGE #	PART #	PAGE #	PART #	PAGE #
65118	240	66013	224	66114	221	66178	242	66241B	202
65119	240	66014	224	66115	220	66179	242	66244	258
65120	240	66017	224	66116	220	66180	242	66245	258
65123	240	66020	225	66117	220	66182	242	66246	258
65124	240	66021	225	66118	220	66184	242	66250	255
65140	241	66022	225	66119	220	66185	227	66251	257
65141	241	66023	225	66120	221	66186	227	66252	257
65142	241	66024	225	66121	221	66187	227	66253	257
65143	241	66029	254	66122	221	66188	227	66254	257
65144	241	66030	254	66123	221	66196	212	66255	257
65145	241	66031	254	66124	221	66197	212	66256	257
65146	241	66032	254	66125	221	66198	212	66257	257
65147	241	66033	254	66126	221	66199	212	66258	257
65148	241	66040	254	66127	221	66200	212	66259	257
65149	241	66051	219	66129	220	66201	212	66260	257
65150	241	66052	219	66130	220	66202	212	66261	257
65151	241	66053	219	66131	220	66203	212	66263	257
65152	241	66054	219	66133	222	66204	212	66265	139
65153	241	66059	224	66134	222	66205	212	66266	139
65161	240	66060	224	66135	222	66205-24	212	66267	139
65162	240	66061	224	66136	222	66206	242	66268	139
65163	240	66062	224	66137	245	66207	242	66269	139
65164	240	66070	220	66137S	245	66208	242	66270	139
65165	240	66071	220	66138	225	66209	242	66270P	139
65166	240	66072	220	66139	225	66210	243	66271	139
65172	241	66073	221	66140	225	66211	243	66271P	139
65177	241	66074	221	66145	222	66212	243	66272	139
65178	241	66075	221	66146	222	66213	243	66274	138
65181	241	66076	221	66147	222	66214	243	66275	138
65182	241	66080	222	66148	222	66215	243	66276	138
65184	241	66081	222	66149	222	66216	243	66277	138
65185	241	66082	222	66150	222	66217	243	66280	256
65187	241	66083	222	66151	222, 223	66218	243	66281	256
65188	241	66100	240	66152	222, 223	66219	243	66282	256
66000	224	66101	240	66153	222, 223	66226	243	66283	256
66001	224	66102	240	66154	222, 223	66227	243	66284	256
66002	224	66103	240	66155	222, 223	66228	243	66285	256
66003	224	66104	240	66156	222	66229	243	66286	256
66004	224	66105	240	66165	226	66230	238	66287	256
66005	224	66106	240	66166	226	66232	238	66288	256
66006	224	66107	240	66167	226	66234	238	66300	260
66007	224	66108	240	66168	226	66235	238	66301	188, 260
66008	224	66110	221	66173	242	66236	238	66302	188, 260
66010	224	66111	221	66174	242	66238	238	66303	260
66011	224	66112	221	66175	242	66239	238	66304	188, 260
66012	224	66113	221	66176	242	66241	202	66305	188, 260



Part # Index

PART #	PAGE #	PART #	PAGE #	PART #	PAGE #	PART #	PAGE #	PART #	PAGE #
66306	188, 260	66371	249	66441	226	66524	255	66624	262
66307	260	66372	249	66442	226	66525	255	66625	262
66308	188, 260	66374	249	66443	226	66526	255	66626	262
66309	260	66375	249	66444	226	66527	255	66627	262
66310	260	66376	249	66445	226	66528	255	66628	262
66311	260	66377	249	66450	258	66530	255	66642	263
66312	260	66380	249	66451	258	66531	259	66700	250
66313	260	66381	249	66452	258	66532	259	66760	255
66317	260	66385	249	66453	258	66533	259	66762	255
66318	260	66387	250	66454	258	66534	259	66763	255
66320	260	66390	242	66455	258	66535	259	66764	255
66325	260	66392	250	66460	259	66536	259	66765	255
66326	260	66394	249	66461	212, 259	66537	259	66767	255
66328	260	66400	226	66462	259	66538	259	66768	255
66330	246	66401	226	66463	259	66539	259	66769	255
66331	246	66402	226	66464	259	66560	263	66770	255
66332	246	66403	226	66465	259	66561	263	66771	255
66334	246	66404	226	66466	259	66562	263	66772	255
66335	246	66410	242	66467	259	66563	263	66773	255
66336	246	66411	242	66468	259	66565	263	66780	256
66338	246	66412	242	66469	157, 259	66566	263	66781	256
66339	247	66413	226	66470	255	66567	263	66782	256
66340	247	66414	226	66472	255	66580	263	66783	256
66341	248	66415	226	66474	255	66581	263	66784	256
66342	247	66416	227	66489	255	66582	263	66785	256
66343	247	66417	227	66490	255	66583	263	66786	256
66344	247	66418	227	66491	255	66584	263	66787	256
66346	248	66419	250	66492	255	66585	263	66788	256
66347	248	66420	250	66493	255	66586	263	66800	243
66348	247	66421	250	66494	255	66587	263	66801	243
66349	247	66422	250	66499	255	66588	263	66802	243
66350	247	66423	239	66500	255	66589	263	66803	243
66351	248	66424	239	66501	255	66590	263	66804	243
66352	248	66425	250	66503	255	66591	263	66805	243
66353	248	66426	250	66505	255	66592	263	66806	243
66354	247	66427	250	66507	255	66602	262	66807	243
66355	248	66428	250	66508	255	66604	262	66808	243
66356	250	66429	250	66509	255	66608	262	66809	243
66360	247	66430	227	66510	255	66610	262	66810	243
66361	247	66431	227	66511	255	66612	262	66811	243
66365	249	66432	227	66514	255	66619	262	66820	244
66366	247	66433	227	66515	255	66619EM	262	66821	244
66367	249	66434	227	66516	255	66619REA	262	66822	244
66368	249	66435	227	66518	255	66620	262	66823	244
66369	249	66436	227	66519	255	66621	262	66824	244
66370	249	66440	226	66520	255	66622	262	66825	244

Part # Index



Part # Index

Part # Index

PART #	PAGE #	PART #	PAGE #	PART #	PAGE #	PART #	PAGE #	PART #	PAGE #
66826	244	66887	257	68010	232	711103	114	72232	106
66827	244	66888	257	68011	232	711201	114	72233	106
66828	244	66889	257	68012	232	711221	114	72241	106
66829	244	66890	257	68013	232	711245	114	72242	106
66830	244	66900	225	68014	232	711252	113	72243	106
66831	244	66901	225	68015	232	711269	113	72251	106
66832	244	66902	225	68100	232	711276	114	72252	106
66833	244	66903	225	70003	217	711294	114	72253	106
66840	244	66904	225	70004	217	711306	115	72282	106
66841	244	66905	225	70005	217	712228	115	73110	111
66842	244	66906	225	70005-A	217	717186	115	73111	111
66843	244	66907	225	70006	217	72100	105	73112	111
66844	244	66908	225	70007	217	72101	105	73113	111
66845	244	66959	225	70008	217	72102	105	73114	111
66846	244	66960	225	70010	28, 29	72103	105	73115	111
66847	244	67005	223	70010K	28	72120	105	73210	111
66848	244	67006	223	70013	217	72121	105	73211	111
66849	244	67007	223	70014	217	72122	105	73212	111
66850	244	67008	223	70015	217	72123	105	73213	111
66851	244	67020	223	70016	217	72130	105	73214	111
66860	257	67021	223	70020	217	72131	105	74121	106
66861	257	67022	223	70021	217	72132	105	74122	106
66862	257	67023	223	70022	217	72133	105	74123	106
66863	257	67025	223	70023	217	721374	116	75121	106
66864	257	67026	223	70024	217	721386	116	75122	106
66865	257	67027	223	70025	217	72141	105	75123	106
66866	257	67030	223	70026	217	72142	105	75131	106
66867	257	67030-1	223	70034	217	72143	105	75132	106
66868	257	67031	223	70035	217	72151	105	75133	106
66869	257	67031-1	223	70036	217	72152	105	75141	106
66870	257	67032	223	70040	217	72153	105	75142	106
66871	257	67032-1	223	70045	218	72181	105	75143	106
66872	256	67040	224	70050	218	72182	105	75151	106
66873	256	67040-1	224	70051	218	72183	105	75152	106
66874	256	67041	224	70060	218	72200	106	75153	106
66875	256	67041-1	224	70062	218	72201	106	77000	228
66876	256	67042	224	70063	218	72202	106	77001	228
66877	256	67042-1	224	70075	218	72203	106	77002	228
66878	256	67050	224	70080	218	72220	106	77003	228
66880	244	67051	224	70085	218	72221	106	77004	228
66881	244	67052	224	70086	218	72222	106	77005	228
66882	258	67145	223	70087	218	72223	106	77006	228
66883	258	67146	223	70098	22	72228	109	77007	228
66884	258	67147	223	70098K	22	72229	109	77010	228
66885	258	67148	223	70099	28	72230	106	77011	228
66886	257	67149	223	70099K	28	72231	106	77012	228



Part # Index

PART #	PAGE #	PART #	PAGE #	PART #	PAGE #	PART #	PAGE #	PART #	PAGE #
77013	228	77074	231	77328	102	78230	107	78431	108
77014	228	77075	231	77329	102	78231	107	78432	108
77015	228	77080	231	774202	113	78232	107	78433	108
77016	228	77081	231	774208	115	78233	107	78434	108
77017	228	77082	231	774219	113	78234	107	78435	108
77020	228	77083	231	774440	130	78241	107	78436	108
77030	229	77084	231	777586	115	78242	107	78450	109
77031	229	77085	231	77799	58	78243	107	78451	109
77032	229	77086	231	77810	54	78251	107	78452	109
77033	229	77087	231	77810K	54	78252	107	78453	109
77034	229	77100	232	77890	55	78253	107	78454	109
77035	229	77101	232	78100	105	78300	107	78455	109
77036	229	77107	232	78101	105	78301	107	78456	109
77037	229	77116	232	78102	105	78302	107	78500	108
77038	229	771225	113	78103	105	78303	107	78501	108
77039	229	771395	130	78120	105	78320	107	78502	108
77040	229	771400	130	78121	105	78321	107	78503	108
77041	229	771410	130	78122	105	78322	107	78504	108
77042	229	771500	130	78123	105	78323	107	78505	108
77043	229	77300	100	78130	105	78331	107	78506	108
77044	229	77301	100	78131	105	78332	107	78507	108
77045	229	77302	100	78132	105	78341	107	78520	108
77046	229	77303	100	78133	105	78342	107	78521	108
77047	229	77304	100	78134	105	78351	107	78522	108
77048	229	77305	101	78141	105	78352	107	78523	108
77049	229	77306	101	78142	105	78400	108	78524	108
77050	230	77307	101	78143	105	78401	108	78525	108
77051	230	77308	101	78151	105	78402	108	78526	108
77052	230	77309	101	78152	105	78403	108	78527	108
77053	230	77310	101	78153	105	78404	108	78530	108
77054	230	77311	101	78182	105	78405	108	78531	108
77055	230	77312	101	78200	107	78406	108	78532	108
77056	230	77314	101	78201	107	78417	108	78533	108
77060	230	77315	101	78202	107	78418	108	78534	108
77061	230	77316	101	78203	107	78419	108	78535	108
77062	230	77317	101	78205	109	78420	108	78536	108
77063	230	77318	101	78210	107	78421	108	78537	108
77064	230	77319	101	78211	107	78422	108	78551	110
77065	230	77320	101	78212	107	78423	108	78552	110
77066	230	77321	102	78213	107	78424	108	78553	110
77067	230	77322	102	78220	107	78425	108	78554	110
77068	230	77323	102	78221	107	78426	108	78555	110
77070	231	77324	102	78222	107	78427	108	78556	110
77071	231	77325	102	78223	107	78428	108	78557	110
77072	231	77326	102	78228	109	78429	108	78558	110
77073	231	77327	102	78229	109	78430	108	78600	109

Part # Index



Part # Index

Part # Index

PART #	PAGE #	PART #	PAGE #	PART #	PAGE #	PART #	PAGE #	PART #	PAGE #
78601	109	79268	112	80121	271	851002	117	900870	125
78602	109	79284	112	80122	271	851004	117	900880	125
78603	109	79310	111	80123	271	851006	117	9008806	118
78620	109	79311	111	80124	157, 274	851008	117	9008807	118
78621	109	79312	111	80128	157, 274	851010	117	9008808	118
78622	109	79313	111	80130	157, 274	851012	117	900890	125
78623	109	79314	111	80132	157, 274	851014	117	900900	125
78630	109	79352	111	80228	109	851016	117	92500	276
78631	109	793520	130	80229	271	851018	117	92502	276
78632	109	79353	111	80250	270	851020	117	92504	276
78633	109	79410	111	80251	270	851022	117	92509	276
78700	110	79411	111	80252	270	851024	117	92511	276
78701	110	79412	111	80253	270	851026	117	92513	276
78702	110	79413	111	80254	270	851028	117	92518	276
78703	110	79440	112	80259	270	851030	117	92520	276
78705	110	79560	111	80260	270	851032	117	92522	276
78806	110	79580	111	80261	270	851034	117	92529	276
78808	110	79660	111	80262	270	851036	117	92538	276
78810	110	79664	111	80263	270	851038	117	92540	276
78812	110	79707	111	80264	270	851040	117	938220	128
78920	110	79708	111	80270	269	851042	117	938316	128
78921	110	79709	111	80271	269	851044	117	938325	128
78922	110	79710	111	80272	269	851046	117	938425	128
78923	110	79712	111	80273	269	851048	117	938450	128
78924	110	79715	111	80280	269	851050	117	938475	128
78925	110	79717	111	80281	269	851052	117	96230	238
78A22	105	79860	111	80282	269	851054	117	96232	238
79050	111	79864	111	80283	269	851056	117	96234	238
79110	111	80100	53, 274	80290	269	900801	125	96235	238
79111	111	80100K	53, 274	80291	269	9008066	118	96236	238
79112	111	80100L	53, 274	80292	269	9008067	118	96238	238
79113	111	80101	271, 274	80293	269	9008068	118	96239	238
79114	111	80102	271, 274	80301	269	900810	125	96266	139
79150	111	80103	52, 274	80302	269	900820	125	96300	260
79151	111	80103K	52, 274	80303	269	9008228	118	96301	260
79152	111	80105	271, 274	80305	269	9008229	118	96302	260
79153	111	80107	271, 274	80320	269	9008230	118	96303	260
79210	111	80109	271, 274	80321	269	9008231	118	96304	260
79211	111	80111	271, 274	80322	269	9008232	118	96305	260
79212	111	80112	271	80323	269	9008233	118	96306	260
79213	111	80113	271, 274	80335	268	9008234	118	96307	260
79214	111	80115	271, 274	80350	268	900830	125	96308	260
79258	112	80116	271, 274	80355	268	900840	125	96311	260
79260	112	80117	271	80360	268	900850	125	96312	260
79262	112	80118	271, 274	82122	112	900860	125	96450	258
79264	112	80120	157, 274	851000	117	9008687	119	96451	258



PART #	PAGE #	PART #	PAGE #	PART #	PAGE #	PART #	PAGE #	PART #	PAGE #
96452	258	9711103	114	9774219	113	C30450	171	RRA-L7	213
96453	258	9711201	114	9777586	115	C33110	174	RRS-L11	213
96454	258	9711221	114	9B54024	56, 129	C33140	174	RRS-L7	213
96455	258	9711245	114	B54024	56, 129	C34020	174	TB001	134
96460	259	9711252	113	B54027	129	C34026	174	TB002	134
96461	259	9711269	113	B54124	129	C34040	174	TF306	64
96462	259	9711276	114	B54135	129	C34046	174	TF308	64
96463	259	9711294	114	C30030	171	DFX-12	213	TF604	64
96464	259	9711306	115	C30050	171	DFX-38	213	TF605	64
96465	259	9712228	115	C30080	172	HB1218	64	WRC-4	60, 82, 91, 98
96466	259	9717186	115	C30090	171	HB1525	64	WRD-3030	60, 82, 91, 98
96467	259	9721286	116	C30150	172	HB2035	64	WRD-3048	60, 82, 91, 98
96468	259	9721374	116	C30190	172	HB2045	64		
96469	259	9771225	113	C30300	170	HB3045	64		
97005	102	9774202	113	C30310	170	RRA-L11	213		

ALPHABETIC INDEX BY PRODUCT NAME

PRODUCT NAME	PAGE #
00024 - Merchandiser Rack	4
1 lb Dead Blow Hammer	93
1/2" Drive Breaker Bar, 18" length	100
1/4" & 3/8" Drive Offset Ratchet	99
1/4" Drive Extension Set, 3 pcs	89
1/4" Drive Socket Set, 22 pcs	92
1/4" Ratchet Set	130
10" Adjustable Wrench	92
12" Groove Joint Pliers	100
12mm Carpenter Pencils	80, 125
13.5" Led Light Bar (Curved / Double Row)	75
13.5" Led Light Bar (Straight / Double Row)	74
13" Led Light Bar (Curved / Single Row)	73
14' Tow Rope, 6500lb capacity	93
14" Led Light Bar (Straight / Single Row)	72
15' Ratchet Tie Down	87
15-in-1 Multi Tool with Pouch	85
15mm Carpenter Pencils	56, 80, 125
18 " Bolt Cutters	102
180° Tubing Bender	101
2 in 1 Flashlight Work Light	69
2 Notch Safety Utility Blade - .6mm Thickness	124
2 Notch Utility Hook Blades - .5mm Thickness	124
2 Way Flat Connector	148
20' x 1" Ratchet Tie Down Set, 2 pcs	93
20" Led Light Bar (Curved / Single Row)	73
21.5" Led Light Bar (Curved / Double Row)	75
21.5" Led Light Bar (Straight / Double Row)	74
22" Led Light Bar (Straight / Single Row)	72
23" Magnetic Pick up Tool with Light	94
2-in-1 COB Work Flashlight	59

PRODUCT NAME	PAGE #
2-in-1 COB Work Flashlight	79
2-In-1 Flexible Spout Funnel	172
2-Pack Head Light COMBO KIT	71
3 lb Fiberglass Sledgehammer	92
3 Piece Socket Adapter Set	130
3/8" and 1/2" Drive Offset Ratchet	102
3/8" Drive Extension Set, 2 pcs	87
3/8" Ratchet Driver	83
3" Long Power Bit Set, 29 pcs	94
3" Tubular Mount Ease-Guide Trailer Couplers	136
30" Led Light Bar (Straight / Single Row)	72
30-in-1 Micro Precision Bit Set	94
31.5" Led Light Bar (Curved / Double Row)	75
31.5" Led Light Bar (Straight / Double Row)	74
31" Led Light Bar (Curved / Single Row)	73
360° Swivel Grease Coupler	167
3-Pack COMBO KIT	71
3-Piece Funnel Set	171
4 Pole Flat Connectors	148
4 Pole Flat Loop Trailer Connector - Heavy Duty	148
4 Pole Round Plug & Socket	148
4 Way And 5 Way Flat Tester With LEDs	151
4 Way Flat Connector (Adapter)	151
4 Way Flat Tester With LEDs	151
4 Way In-Line Adapter	151
4 Way Lug Wrench	96
4" Power Grip Vacuum Cup	89
41.5" Led Light Bar (Curved / Double Row)	75
41.5" Led Light Bar (Straight / Double Row)	74
42" Led Light Bar (Curved / Single Row)	73
42" Led Light Bar (Straight / Single Row)	72



Alphabetic Index

Alphabetic Index

PRODUCT NAME	PAGE #	PRODUCT NAME	PAGE #
48" Elastic Cord with Hook, 2 pcs	90	Air Hose Reels - Heavy Duty Steel Frame	267
4-Hole Mounting Lunette Ring	146	Air Tool Coupler Set, 4 pcs	85
4-in-1 Brush	88	Aircraft Cable 7 X 19 Construction	228
4-Piece Funnel Set	171	Aircraft Cable 7 X 7 Construction	228
5 Pole Flat Connector- Heavy Duty	148	Allen Cap Screw Assortments, 106 Pieces	193
5 Pole Flat Connectors	148	Alloy Clevis Grab Hooks	221
50' PVC Air Hose, 3/8" dia	101	Alloy Clevis Hooks With Latch	222
50" Led Light Bar (Curved / Double Row)	75	Alloy Clevis Slip Hooks With Latch	221
50" Led Light Bar (Straight / Double Row)	73	Aluminum Pulleys Merchandiser	36
50" Led Light Bar (Straight / Double Row)	74	Aluminum Snap Links	250
50° A-Frame Ease-Guide Trailer Couplers	136	Aluminum Spring Snap	245
51" Led Light Bar (Straight / Single Row)	72	Anchor Points	210
6 Outlet Power Strip	96	Anchor Rings	211
6 Way Round Plug & Socket	149	Anti-Splash Funnels	172
6 Way Socket, 4 Way Plug With LEDs (Adapter)	150	Artist Brush, 15 pcs set	83
6' x 1" Cam Buckle Set, 2 pcs	93	Assorted Electrical Terminals, 48 pcs	86
6" Plastic Dial Caliper	94	Assorted Grease Fittings Dynapaks	195
6" Plier Set, 4 pcs	101	Assorted Impact Bit Bar	115
7 Way Blade Plug	149	Assorted Rob. Bit Bar	114
7 Way Blade Tester With LEDs	151	Assorted Robertson & Phillips Bit Bar	114
7 Way Plug	149-150	Assorted Robertson & Phillips Bit Bar	114
7 Way Plug - Heavy Duty	150	Assorted Robertson Bit Bar,	113
7 Way Plug And Socket	149	Assortments Plan-O-Gram	21
7 Way Socket	149-150	ATV Ball Mount Kit	141
7 Way Socket - Heavy Duty	150	Auto Brake Repair Kit	210
7 Way Socket / 4-Way Plug Set	149	Auto Fuses Assortment, 80 Pieces	192
7 Way Socket Led & 4-Way Plug With LEDs	150	Auto Loading Cutter with Holster, 3/4" Blade	120
7.5" Led Light Bar (Straight / Double Row)	74	Auto Loading Cutter, 3/8" Blade	120
8 LED Light with Laser Pointer	57,79	Auto Loading Ergonomic Cutter	120
9 Piece Allen Set - Ball Point S2	130	Auto Loading Ergonomic Cutter, 25mm" Blade	120
9" Pocket Level	86	Automatic Battery Filler	174
90° Grease Coupler	168	Automotive Electric Repair Kit, 285 Pieces	189
AC / DC Multi Tester	93	Automotive Funnel	172
AC / DC Mutli Tester	85	Automotive Fuse Assortment, 75 pcs	93
Adapter and U-Joint Set, 7 pcs	100	Automotive Fuse Kit, 25 pcs	85
Adapter and U-Joint Set, 7 pcs	101	Automotive Tester, 6v and 12v	86
Adhesive Felt Pads, 50 pcs	90	Baby Square Eye Snaps	249
Adjustable 3-Position Lunette Ring	146	Ball Hex and Star Driver Set, 16 pcs	94
Adjustable Ball Mounts (Single Platform)	143	Ball Mount Kits	141
Adjustable Brackets	137	Ball Mount Rack	10
Adjustable Clevis Pins	276	Beam Clamps	269
Adjustable Double Ball Mount	144	Bench Swager	232
Adjustable Hacksaw	83	Big Handle Screwdriver Set, 2 pcs	89
Adjustable Height Led Work Light with Tripod	71	Bit Holder and Extension Set, 6 pcs	96
Adjustable Tow Bar	137	Black Impulse Buy Products	98 - 102
Adjustable Trailer Couplers	136	Black Impulse Buy Table	60
Adjustable Triple Ball Mounts	143	Black Impulse Buy Table	98
Adjustable Wrench, 8"	84	Blow Gun with Venturi Tip	100
A-Frame Trailer Couplers	135	Blue Impulse Buy Products	91- 97
Air Blow Gun Set, 3 pcs	85	Blue Impulse Buy Table	60
Air Blow Gun, Pistol Type	89	Blue Impulse Buy Table	91



PRODUCT NAME	PAGE #	PRODUCT NAME	PAGE #
Bolt Snaps	247	Class 4 Forged Steel Ball Mounts	140
Bolt Snaps	247	Class 5 Forged Steel Ball Mounts	141
Bolt Snaps	247	Claw Hammer	95
Bolt Type Anchor Shackles	225	Claw Hammer, 16 oz	88
BOSS Padlock Merchandiser	54	Clevis Ball Mount	143
BOSS Quality Cutters and Blades Merchandiser	54	Clevis Grab Hooks	221
Breakaway Switch With Lanyard	151	Clevis Grab Hooks (Grade 80)	223
Bronze Animal Snap	250	Clevis Pin Dynapaks	276
Bronze Bushings	261	Clevis Pins	276
Bronze Bushings Merchandiser	38	Clevis Sling Hooks (Grade 80)	223
Brush Set, 3 pcs	85	Clevis Slip Hooks	220
Brush Set, 7 pcs	96	Close Quarter Hacksaw	86
Bulk Plastic Cutters, 3/8" Blade	121	Clutch Tamper Proof - Plain Finish Bits	110
Bulk Springs Merchandiser	278	Cobalt Drill Bits feat. Grizzly Tip	117
Bulk Springs Merchandiser cont...	279	Coil Chain (Straight Link)	217
Bull Snap	246	Cold Shuts	226
Bungee Cord Hooks	201	Combination Padlock - 1 / Package	127
Bungee Cord Reels	201	Combination Pintle Hooks	146
Cable Cutters	232	Combination Pintle Hooks - 1 Piece	146
Cable Manager Set, 31 pcs	90	Comfort Grip Cutter, 3/4" Blade	119
Cable Pullers	269	Commercial Grade Anchor Shackles	224
Cable Sleeves	231	Composite Digital Caliper	100
Cable Stops	231	Compound Action Cable Cutters	102
Cable Thimbles	230	Connecting Links	227
Cable Tie Set	93	Connecting Links (Grade 80)	223
Cable Ties Set, 150 pcs	86	Contractor's Screwdriver Set, 8 pcs	95
Cable Type Load Binder Locks	212	Copper Washer Assortments, 110 Pieces	193
Cam Straps	203	Corner Protector	207
Cap Snap	246	Cornice Hooks	239
Carabiner with Magnet	250	Cotter Pin (Large) Assortments, 150 Pieces	190
Carbon Clevis Slip Hooks With Latch	220	Cotter Pin Assortments, 560 Pieces	190
Cargo Control Plan-O-Gram	22	Counter-top BOSS Compact Driver Bit Display	58, 112
Cargo Nets	201	Counter-top BOSS Driver Bit Kit Display	58
Cargo Winch - 3 Bar	207	Coupler Lock	138
Carpenter Pencil Accessories	125	Coupler Lock & Receiving Set	138
Carpenter Pencils	56, 80, 125	Cree LED 3W Focusing Light	57, 79, 126
Caster Swivel Wheels	272	Crimping Tool and Terminal Kit, 101 pcs	94
Caster Wheel With Side Locking Brake	272	Crimping Tool with Terminals	84
Caster Wheels Plan-O-Gram	52	Cross Pein Hammer, 3 lb	101
Caster Wheels With Rigid Top Plate	272	Cushion Grip Screwdriver Set, 5 pcs	95
Castor & Assorted Wheels Merchandiser	53	Customized Assorted Robertson Bit Bar	113
Ceiling Bit Holder	112	Customized Phillips Bit Bar	115
Chain & Steel Cable Rack Merchandiser	29	Customized Robertson Impact Round Body	114
Chain Connectors Merchandiser	25	Customized Assorted Impact Bit Bar	115
Chain Hoists	270	Customized Assorted Rob. & Ph. Bit Bar	114
Chain Hooks Merchandiser	26	Customized Assorted Rob. Bit Bar	114
Chain Rack - 2'	28	Customized Magnetic Nut Drivers Bit Bar	115
Chain Rack - 4'	28	Customized Magnetic Nut Drivers Bit Bar	114
Channel Trailer Couplers	135	Customized Metric Magnetic Nut Drivers Bit Bar	115
Class 1 Ball Mounts	140	Customized Robertson Impact Bit Bar	113
Class 3-4 Ball Mounts	140	Customized Robertson Sq# Bit Bar	113



Alphabetic Index

Alphabetic Index

PRODUCT NAME	PAGE #	PRODUCT NAME	PAGE #
Customized Robertson Sq#2 Bit Bar	114	Ergonomic Auto Loading Cutter, 3/4" Blade	120
Customized Tamper Proof Bit Bar	113	Ergonomic Serrated Blade Cutter, 3/4" Blade	119
Customized Torque Bit Bar	113	Extended Scraper	88
Cylinder Pins	254	External Retainer Ring Assortments, 300 Pieces	191
Damaged Screw Remover	130	External Retainer Rings (Basic)	288
Deck Driver with Stopper	112	External Thread Trailer Balls	133
Deep Hole Nut Drivers - Colour Coded	111	External Thread Trailer Balls - Retail Packaged	134
Deep Hole Nut Drivers - Plain Finish	111	Extra Lift External Thread Trailer Balls	133
Deluxe Door Mount Towing Mirror	147	Extra Long Needle Nose Pliers	94
Diagonal Pliers, 7-1/2"	85	Extra Long Ratchet, 1/2" drive	101
Diaphragm Fuel Pump	165	Extra Long Screwdriver Set, 2 pcs	89
Dirt Free Funnels	173	Extra Long Socket Adapter, 3 pcs	87
Dog Lead Snap	246	Eye & Eye	243
Double Face Mallet	88	Eye & Eye Turnbuckles (Forged Steel)	244
Double Fixed - Die Cast Awning Pulleys	236	Eye Bull Snaps	249
Double Hook With Swivel Eye	237	Eye Grab Hooks	221
Double Loop Chain	218	Eye Hoist Hooks - Alloy Steel (Yellow)	223
Double Loop Chain (Tenso Or Lion)	218	Eye Hoist Hooks - Carbon Steel (Orange)	222
Double Swivel - Die Cast Awning Pulleys	236	Eye Slip Hooks	220
Drain Pans	177	Eyebolts	240
Drawbar Spring	282	Eyebolts & Rings Merchandiser	33
Drill Bit Display	55	EZ-Clips	139
Drill Bit Set, 13 pcs	86	Farm Hardware Merchandiser	41
D-Rings	242	Farm packs Merchandiser	45
Drive-In Grease Fittings	169	Fifth Wheel King Pin Stabilizer	157
Driver Socket Set, 10 pcs	92	File Set with Handles, 6 pcs	85
Drywall - Plain / Brass Finish Bits	109	Fixed - Steel Pulley Blocks	236
Drywall Saw	90	Fixed Eye - Steel Pulley Blocks	237
Drywall Saws	129	Flat Free Caster Swivel Wheel	273
Dual Bracket Heavy Duty Grease Hose Reel	267	Flat Free Caster Wheel With Rigid Top Plate	273
Dual Head Stubby Ratchet	57, 81, 126	Flat Free Wheels	271
Dual Head Tire Gauge	96	Flat Spring Snap - Simplex	250
Dual Hitch Extension	144	Flex Scraper Set, 3 pcs	87
Dust Mask Set, 100 pcs	96	Flexible Extensions	86
Dust Mask Set, 3 pcs	88	Fluid Transfer Pump	164
Dynakit Assortments Merchandiser	19	Foldable Funnel	56, 81, 172
DynaKits	195	Folding Utility Knife	94
Dynaline Bin Box	64	Folding Utility Knife, 2 pack	99
Dynaline Custom Banner	61	Fold-Over Handle Load Binders	213
Dynaline Custom Signs	61	Forged Aluminum Ball Mounts - Solid Shank	141
Dynatray Assortments Merchandiser	19	Forged Chain Swivel	226
E Retainer Rings	286	Forged Steel Hitch Pins	258
Ear Muffs and Safety Glasses	96	Forged Steel Wire Rope Clips	229
Easy Flow Funnel	177	Forged-D-Ring With Weld-On Bracket	227
Easy Out and Drill Bit Set, 12 pcs	95	Framing Hammer, 24 oz	92
Economy Blades DIY - 3/4" Blade	123	Free Standing Customizable Merchandiser	4
E-Grip & Forged Steel Hitch Pins Merchandiser	42	Fuel Cart with Pump	166
Electrical Test Kit, 3 pcs	84	Funnels & Lubrication Merchandiser	15
EPDM Rubber Tarp Straps	202	Furnace Chain	218
E-Retainer Ring Assortments, 300 Pieces	193	Fuse Assortments, 92 Pieces	194
Ergo Grip Cutter, 3/4" Blade	119	General Hardware Continued	31

<i>PRODUCT NAME</i>	<i>PAGE #</i>	<i>PRODUCT NAME</i>	<i>PAGE #</i>
General Hardware Merchandiser	30	Heavy Duty Plastic Cutter w/ Metal Head	118
General Purpose Handles	210	Heavy Duty Plastic Cutter, 3/4" Blade	80, 118
General Purpose Repair Kits	210	Heavy Duty Recessed Anchor Rings	211
Glass Breaker/Seatbelt Cutter	90	Heavy Duty Recovery Straps	206
Gooseneck Ease-Guide Trailer Coupler	136	Heavy Duty Snatch Block Tail Boards	269
Grade 30 Proof Coil Chain	217	Heavy Duty Snatch Block With Hook	269
Grade 70 - 5/16" Transport Chain Assemblies	219	Heavy Duty Snatch Block With Shackle	269
Grade 70 -3/8" Transport Chain Assemblies	219	Heavy Duty Tire Repair Kit	96
Grade 8 Hitch Pins Merchandiser	42	Heavy Duty Tow Ropes	206
Grease Accessories Merchandiser	13	Heavy Duty Voltage Tester	95
Grease Accessory Kit	167	Heavy Wire Rope Thimbles	230
Grease Box	170	Hex / Allen - Plain Finish	108
Grease Couplers	168	Hex Key Set, 9 pcs s Metric	83
Grease Filler Nipple	168	Hex Key Set, 9 pcs s S.A.E.	83
Grease Fittings Assortments, 70 Pieces	187	Hex Tamper Proof - Plain Finish Bits	110
Grease Gun Holder	167	Hi Carbon Heavy Duty - 3/4" Blade	123
Grease Gun Pipe	168	High Pressure O-Ring Kit, 212 Pieces	196
Grease Guns	163-164	High Pressure O-Rings	183
Grease Hose - Nylon	168	High Speed Drill Bit Set, 16 pcs	95
Grease Hose - Steel wire	168	High Strength Hitch Pins - Grade 5	257
Grease Hose - Steel wire (in display box)	168	High Strength Hitch Pins - Grade 8	257
Grease Injectors	167	High Temp V75 O-Ring Kit, 382 Pieces	197
Grease-2-Go!	170	High Torque Ratcheting Drive	99
Grommet Assortments, 125 Pieces	192	Hitch Adapters	145
Groove Joint Pliers	84	Hitch Box Extension	144
Groove Joint Pliers	93	Hitch Lock	139
H.D. Long Stretch Cord Set, 16 pcs	93	Hitch Pin - Round Ring Grip	255
Hacksaw Blade Set, 12 pcs	89	Hitch Pins - E-Grip	256
Hair Pin Assortments, 150 Pieces	191	Hitch Pins - Fold Over Handle	256
Hair Pin Assortments, 83 Pieces	188	Hitch Pins (Fold Over Handle (Merchandiser)	43
Hair Pin Clips - External	260	Hitch Pins Merchandiser	43
Hair Pin Clips - Internal	260	Hobby Knife Set, 16 pcs	83
Hand Saw	87	Hole Saw Set, 5 pcs	84
Hand Swager	232	Hollow Punch Set, 6 pcs	95
Hand Winch - Dual Drive	208	Hollow Shaft Nut Driver Set, 5 pcs	93
Hand Winches - Auto Brake	208	Hook & Eye Turnbuckles (Forged Steel)	244
Hand Winches - General Purpose	208	Hook & Eye Turnbuckles (Malleable Iron)	243
Hand Winches - Worm Gear	209	Hook & Eye Turnbuckles (Wire Formed Ends)	242
Handy Key Chain Cutter, 3/8" Blade	121	Hook & Hook Turnbuckles (Forged Steel)	243
Harness Ring	242	Hook & Hook Turnbuckles (Wire Formed Ends)	243
Head Scraper with Thumb Lock	122	Impact Reducer Adapter Set, 3 pcs	102
Heat Gun	100	Industrial Funnels	171
Heat Shrink Tube Kit, 171 pcs	102	Industrial Hose Reel	267
Heavy Duty - Quick Change Adapter	112	Industrial Safety Pins	255
Heavy Duty D-Rings	242	Industrial Security Set	130
Heavy Duty External Thread Trailer Balls	133	Inspection Mirror, 2"	89
Heavy Duty Flex Spout Funnel	173	Internal Pipe Wrench Set, 3 pcs	99
Heavy Duty Grease Gun	163	Internal Retainer Rings	287
Heavy Duty Hacksaw	93	Internal Thread Trailer Balls	133
Heavy Duty Knob Lock Cutter, 3/4" Blade	119	Internal Thread Trailer Balls - Retail Packaged	134
Heavy Duty Magnifying Glass	86	Iron Padlock, 75 mm	95



Alphabetic Index

PRODUCT NAME	PAGE #	PRODUCT NAME	PAGE #
Jack Rack	11	Malleable Iron Wire Rope Clips	229
Jack Replacement Parts And Accessories	157	Manual Holders	158
Jack Stands	268	Manual Holders	264
Japanese Metric O-Ring Kit, 380 Pieces	198	Master Auto Fuse Assrt, 88 pcs	100
Jaw & Jaw Turnbuckles (Forged Steel)	244	Master Links (Grade 80)	223
Keystock	51	Maxi Fuse Set, 7 pcs	89
L.E.D. Head Lamp	88	Measurer w/Fixed Lid & Nozzle	174
L.E.D. Light Set, 3 pcs	95	Measurer with Lid & Nozzle	173
L.E.D. Stick-on Tap Lights, 2 pcs	88	Measuring Container	174
Lagscrew Eyebolts	240	Measuring Scoops	174
Leather Work Gloves	89	Measuring Tape, 25" x 1" S.A.E	83
LED Magnetic Towing Light Kit	147	Mechanics Gloves, Large	94
Led Work Light with Handle (Corded)	70	Mechanics Gloves, X-large	94
Led Work Light with Tripod	71	Mechanics Pick, Hook and Driver Set	95
Levelling Scissor Jacks	156	Mega Blade Cutters, 1" Blade	119
Lever Action Barrel Pump	165	Merchandiser Rack	4
Lever Action Pail Pump	164	Metal Blade, 3/8" Blade	121
Lever Hoists	270	Metal Measurer	175
Lever Snaps	249	Metal Pick and Hook Set, 4 pcs	85
Lever Type Load Binders	212	Metal Utility Cutter with Thumb Lock	122
Lift Arm Bushings	262	Metric Combination Wrench Set, 4 pcs	85
Lift Arm Pins	263	Metric Combo Wrench Set, 11 pcs	100
Lifter Coupler Handle	137	Metric Deep Socket Drive Set, 7 pcs	92
Light Bars	72-75	Metric Deep Socket Set, 4 pcs	83
Linesman Pliers / Cutter	84	Metric Drive Hex Bit Socket Set	95
Link Locks	226	Metric Grease Fitting Assrt, 110 pcs	100
Load Binder Locks	212	Metric Grease Fittings	169
Load Binder/Cable Puller Rack	22	Metric Grease Fittings, 110 Pieces	187
Load Tighteners	212	Metric Hex Bit Socket Set, 10 pcs	99
Locking Pliers, 10"	84	Metric Magnetic Nut Drivers - Plain Finish	111
Locking Ratchet Racks	213	Metric Magnetic Nut Drivers Bit Bar	115
Long Blade Aviation Tin Snip	97	Metric Non-Slip Hex Key Set, 9 pcs s	99
Long Needle Nose Pliers, 6"	89	Metric Nut Driver Set, 4 pcs	84
Long Shank External Thread Trailer Balls	133	Metric O-Ring Assortment, 419 pcs	102
Loop Snaps	248	Metric O-Rings	182
Low Profile Oil Drain with Manual Pump	176	Metric Socket Set Screws Assortments	188
Lubrication Plan-O-Gram	14, 17	Metric Socket Set with Rail, 7 pcs	83
Lynch Pins - Packaged	258	Metric Stubby Wrench Set, 7 pcs	100
Machinery Bushings	277	Micro Fuse Set, 32 pcs	89
Machinery Bushings Merchandiser	49	Micro Fuse Set, 80 pcs	95
Magnetic Base Work Light with Hook	69	Micro-driver Bit Set, 10 pcs	88
Magnetic Bit Holders	112	Mid Links	225
Magnetic Insert Holder	112	Mini Auto Fuse Set, 32 pcs	87
Magnetic Nut Drivers - Colour Coded	111	Mini Car Fuse Assortment, 80 pcs	94
Magnetic Nut Drivers - Plain Finish	111	Mini Pistol Grip Grease Gun	162
Magnetic Nut Drivers Bit Bar	114-115	Mini Plier Set, 3 pcs	92
Magnetic Nut Setter, 3 pcs	88	Mini Plug-In Fuses Assortments, 101 Pieces	188
Magnetic Parts Dish	88	Mini Precision Plier Set, 5 pcs	100
Magnetic T-Bar Driver	83	Mini Stubby Screwdriver Set, 6 pcs	86
Magnetic Utility Light with Hook	59, 79	Mini Tool Accessory Set, 72 pcs	93
Magnetizer / Demagnetizer	130	Mini Tubing Cutter	86

PRODUCT NAME	PAGE #	PRODUCT NAME	PAGE #
Mirror and Magnet Set, 2 pcs	92	Phillips - Colour Coded Bits	106
Mount Fixed Lunette Ring	146	Phillips - Plain Finish Bits	107
Mounted Stone Set, 10 pcs	87	Phillips Bit Bar	115
Mounting Bracket For 7 Way Trailer Connectors	149	Pick-up Tool Set, 2 pcs	84
Mounting Rings	241	Pins Merchandiser	40
Mud Flaps	157	Pintle Hooks	145
Muffler Clamps	253	Pintle Hooks - Solid Shank	145
Muffler Clamps Merchandiser	34	Pintle Mounts	146
Multi Purpose Large Glove Set, 3 pcs	96	Pistol Grip Grease Gun	162
Multi Purpose Razor Scraper Set	99	Pistol Grip Grease Gun	162
Multi Purpose Scissors, 2 pcs	86	Pistol Grip Grease Gun	162
Multi Purpose X-Large Glove Set, 3 pcs	96	Plastic Cutter, 3/4" Blade	56, 80, 118
Multi Use Power Bit Set, 45 pcs	102	Plastic Cutters, 3/8" Blade	121
Multi-Purpose Funnels (Single)	171	Plastic Funnels & Measures	176
Multi-Purpose Lithium Grease	163	Plastic Funnels & Measures Merchandiser	16
Multi-Use Ball Mount	144	Plastic Window Scraper	122
Multi-Use Siphon Pump	164	Plastic Window Scraper with Thumb Lock	122
N70 Metric O-Ring Kit, 419 Pieces	196	Plier Set, 2 pcs	89
N70 Metric O-Ring Kit, 425 Pieces	198	Plier Set, 2 pcs	92
N70 O-Ring Splicing Kit, 5 Pieces	198	Pneumatic Caster Swivel Wheel	273
N70 S.A.E. O-Ring Kit, 407 Pieces	196	Pneumatic Caster Wheel With Rigid Top Plate	273
N90 S.A.E. O-Ring Kit, 382 Pieces	197	Pneumatic Wheel	271
Needle Nose Adapter	167	Pocket Calculator	85
Needle Nose Dispensers	167	Pocket Work Light and Spot Light	59, 69, 79
Needle Nose Pliers, 8"	84	Pop-Up Anchor Point	211
New Assortments Merchandisers	20	Portable 12V Electric Winch	209
Nylon Scraper Set, 4 pcs	99	Portable Flood Led Work Light (Corded)	70
Offset Micro Bit Driver with Bits	102	Portable Fluid Pump	165
Offset Transmission Funnel	175	Portable Led Work Light (Corded)	70
Oilers with Base	170	Portable Measurer	174
Open Decoy Snaps	248	Power Bit Set, 10 pcs	85
Open Eye Snaps	248	Power Jack	152
O-Ring Assortment, 50 pcs	87	Power Nut driver and Bit Set, 13 pcs	88
O-Ring Assortments, 270 Pieces	190	Pozi - Plain Finish Bits	109
O-Ring Flange Kit, 150 Pieces	195	Precision Screwdriver Set, 12 pcs	84
O-Ring Set, 225 pcs	94	Premium Heavy Duty Grease Gun	163
O-Ring Tilt Bins Merchandiser	18	Professional Assortment Bits and Nut Drive Set	116
O-Rings Merchandiser	183	Professional Assortment Impact Driver Bits	116
O-Rings Merchandiser	12	Professional Grade - 12/Box	56, 128
Overtime Saw Blades	56	Pry Bar Set, 4 pcs	92
Overtime Saw Blades	129	Pry Bar Set, 4 pcs	100
Packaged Compression Springs	283	Pulley Blocks Merchandiser	35
Packaged Extension Springs	280	Pump Oilers	170
Padlocks	127	Punch and Chisel Set, 7 pcs	92
Paint Brush Set, 10 pcs	96	PVC Pipe Cutter	92
Paint Brush, 5 pcs s set	83	Quality Grade - 12/Box	80
Paladin Work Light Merchandiser	59, 69	Quick Links - Stainless Steel	227
Panic Snap	246	Quick Links - Zinc Plated	227
Parts Cleaning Brush Set, 5 pcs	86	Quick Release - 6" Holder	112
Parts For Used Fluid Drainer (Part# 11802)	166	Quick Release Pins	255
Passing Link Chain	218	Ratchet Jack	263



Alphabetic Index

Alphabetic Index

PRODUCT NAME	PAGE #	PRODUCT NAME	PAGE #
Ratchet Straps - Bulk	205	Round Tube Mount Jacks, Top Wind	154
Ratchet Straps - Double "J" Hooks	204	Round Tube Swivel Bracket Mount Jacks	154
Ratchet Straps with Flat Hooks	203	Rubber Mallet	88
Ratchet Straps with S-Hooks - Four Packs	204	Rubber Mallet, 32 oz	96
Ratchet Straps with S-Hooks - Twin Packs	204	Rubber Sealing Washer Assortments, 141 Pieces	194
Ratchet Straps with S-Hooks (Vinyl-Coated)	203	Rubber Tie Down Strap Set, 10 pcs	93
Ratchet Type Load Binders	212	RV, Marine & Utility LED Lighting Kit	147
Ratchet with S.A.E. Sockets, 1/4" Drive	87	S.A.E. Ball Hex Key Set	97
Ratcheting Tie Down 2" x 27'	92	S.A.E. Combination Wrench Set, 4 pcs	85
Ratcheting Wire Terminal Crimper	101	S.A.E. Combination Wrench Set, 6 pcs	94
Razor Folding Utility Cutter	57, 81, 122	S.A.E. Combo Wrench Set, 11 pcs	100
Read Easy Tape Measure	93	S.A.E. Deep Socket Drive Set, 7 pcs	92
Receiver Lock Pins	138	S.A.E. Deep Socket Set, 4 pcs	83
Receiver Pull Pins	139	S.A.E. Drive Hex Bit Socket, 10 pcs	95
Receiver Tubes	145	S.A.E. Grease Fittings (Grease Zerks)	169
Receptacle Tester	90	S.A.E. Grease Fittings Assortments, 100 Pieces	187
Recessed Anchor Rings	211	S.A.E. Hex Bit Socket Set, 10 pcs	99
Rechargeable Grease Gun Kit - 19.2 V	161	S.A.E. Non-Slip Hex Key Set, 13 pcs	99
Rechargeable Led Work Light w/ Magnetic Base	70	S.A.E. Nut Driver Set, 4 pcs	84
Rectangular Keystock	275	S.A.E. O-Ring Assortment, 407 pcs	101
Red Impulse Buy Products	82 - 90	S.A.E. O-rings	178-181
Red Impulse Buy Table	60, 82	S.A.E. O-Rings Merchandiser	12
Repair Links	226	S.A.E. Socket Set with Rail, 7 pcs	83
Replacement Batteries	161	S.A.E. Stubby Wrench Set, 7 pcs	100
Replacement Bearings For Wheels	271	Safety Cutter, 2 Notch Utility Blade	121
Replacement Cable Keeper	210	Safety Glasses and Ear Plug Set	89
Replacement Chargers	161	Safety Lanyard Snaps	245
Replacement Funnel Filter	173	Safety Slip Hooks	222
Replacement Grease Hoses	161	Safety Vest	90
Replacement Parts for Hose Reels	267	Safety Winch Hook	222
Replacement Power Cord End Set	89	Samuri Heavy Duty - 3/4" Blade	123
Replacement Safety Utility Blade For 550460	121	Samuri Mega Heavy Duty Blades - 1" Blade	124
Replacement Sheaves - Steel Pulley Blocks	237	Samuri Serrated Heavy Duty - 3/4" Blade	123
Retainer Rings Merchandiser	48	Sash Chain	218
Retainer Rings Tilt Bins Merchandiser	50	Scraper Set, 22 pcs	99
Retractable Collar - Magnetic Rim	112	Screw Extractor / Left Hand Drill Bit, 10 pcs	102
Retractable Hose Reel - Silver Series	267	Screw Eyes	239
Retractable Tie Downs with Hooks	204	Screw Hooks	239
Rivet Assortments, 500 Pieces	194	Screw Pin Anchor Shackles	224
Robertson - Branded Impact Bits	106	Screw Pin Chain Shackles	225
Robertson - Color Coded Bits	105	Screwdriver Bit Set with Holders, 33 pcs	86
Robertson - Magnetic Impact Bits	106	Screwdriver Bit Set, 30 pcs	94
Robertson - Plain Finish Bits	105	Screwdriver Bit Set, 61 pcs	101
Robertson Impact Bit Bar	113	Screwdriver Set with Rack, 6 pcs	85
Robertson Impact Round Body Bit Bar	114	Screwdriver Set, 10 pcs	101
Robertson Sq#2 Bit Bar	114	Screwdriver Set, 8 pcs	92
Rotary Barrel Pump	165	Seal and O-Ring Remover Set, 4 pcs	99
Round Quick Pins	259	Seal-able Drain Pan	176
Round Shank - Reversible	142	Seal-able Oil Drain Pan with Wheels	176
Round Shank - Triple	142	Security Bit Set, 100 pcs	99
Round Tab Type Quick Pins	259	Security Snaps	249



PRODUCT NAME	PAGE #	PRODUCT NAME	PAGE #
Self Adjusting Wire Stripper	101	Square Straight Shank - Reversible	142
Self Feeding Utility Knife	88	Square Tube "Drop Legs" Jack	155
Self Priming Copper Pump	164	Square Tube "Drop Legs" Jacks - Heavy Duty	156
Self-Locking Clevis Hooks	224	Square Tube A-Frame Jack	153
Semi-Pneumatic Wheel	271	Square Tube Jack - Heavy Duty	156
Serrated Utility Blade	124	Square Tube Trailer Jack	155
Shackle (Tow Strap) Ball Mount	143	Stabilizer Jack	156
Shackles & Clevises Merchandiser	26	Stainless Steel Boat Snaps	245
Shock Cord Set, 8 pcs	85	Stainless Steel Hardware Merchandiser	24
S-Hooks	238	Stainless Steel Pry Bar Set, 2 pcs	99
Shoulder Eyebolts	240	Stainless Steel Security Snaps	245
Side Wind With Wheel	153	Stainless Steel Shackles	225
Side Wind Without Wheel	153	Stainless Steel Snap Links	250
Side Wind, Round Tube Mount (7-1/2" x 4" Base)	154	Stainless Steel Spring Snaps	245
Side Wind, Round Tube Mount	154	Stainless Steel Wire Rope Clips	230
Side Wind, Square Tube Mount	155	Stake Eye - Stake Rack Hardware	238
Single Edge Blade	124	Stake Hooks - Stake Rack Hardware	238
Single Fixed - Die Cast Awning Pulleys	235	Standard Double Pulley Block	268
Single Hook - Steel Pulley Blocks	237	Standard Duty Grease Gun	163
Single Jack Chain	218	Standard Plug-In Fuses Assortments	188
Single Pulley Block With Eye	268	Standard Recessed Anchor	211
Single Swivel - Die Cast Awning Pulleys	236	Standard Single Pulley Block	268
Sink and Drain Cleaner	90	Standard Wire Rope Thimbles	230
Slip Join Pliers, 8"	84	Standary Duty Blade - 3/8" Blade	124
Slotted - Plain Finish Bits	107	Staple Gun	96
Small Wheel Rack Merchandiser	52	Star Socket Bit Set, 9 pcs	102
Snap Ring Plier Set, 3 pcs	94	Steel Snap Links	250
Snaps Merchandiser	32, 39	Steering Wheel Spinners	254
Socket Adapter Set, 4 pcs	87	Step Bumper Receiver	144
Socket Holders - Plain Finish	111	Step Keystock	275
Socket Holders Set, 2 pcs	87	Storage Bins	64
Socket Set, 52 pcs	101	Straight Aviation Snips	86
Solid - Die Cast Aluminum Pulleys	235	Straight Clevises	254
Solid Snap Hook	246	Stroke Control Merchandiser	44
Spanner Tamper Proof - Plain Finish Bits	110	Stroke Control Segment Kits	253
Spark Plug Socket Set	83	Stroke Control Segments	253
Split Key Rings	242	Stroke Control Stopper Blocks	254
Spoked - Die Cast Aluminum Pulleys	235	Stubby Claw Hammer	57, 81, 126
Spring Assortments, 200 Pieces	189	Suction Gun	164
Spring Latches	139	Super Duty Steel Ball Mounts	141
Spring Lock Pins	258	Super Funnel	173
Spring Snap	248	Swing-Way Jacks With Caster Wheels	152
Springs - Expanded Selection 1	47	Swivel - Steel Pulley Blocks	236
Springs - Expanded Selection 2	47	Swivel Eye - Steel Pulley Blocks	237
Springs Merchandiser - Bulk Springs Cabinet	51	Swivel Eye Hoist Hooks	224
Springs Merchandiser - Retail Packaged	46	Swivel Eye Hook	222
Square Drop Shank - Reversible	142	Swivel Eye Snaps	246
Square Keystock	275	Swivel Loop Snaps	248
Square Quick Pins	259	Swivel Security Snaps	249
Square Shank - Triple Ball Size	143	Swivel Snaps	249
Square Shank - Triple Ball Size with Tow Hook	143	Tamper Proof Bit Bar	113



Alphabetic Index

Alphabetic Index

PRODUCT NAME	PAGE #	PRODUCT NAME	PAGE #
Tamper Proof Star Bit Set, 13 pcs	86	Truck & Trailer Drain Pan	177
Tamper Proof Star Key Set, 10 pcs	88	Tubing Cutter, Large	84
Tamper Proof Star Socket Set, 9 pcs	93	Turnbuckles Merchandiser - Forged Steel	37
Tamper Resistant Star Bit, 13 pcs	99	Turnbuckles Merchandiser - General Purpose	37
Tap Set, 8 pcs	97	Twin Head Led Work Light with Tripod	71
Tape Measure Set, 4 pcs	101	Twine Assortment, 4pcs	90
Tarp Hooks	239	Twist Link Machine Chain	218
Tarp Strap Replacement Hook	202	U-Bolts - Round	241
Telescoping Magnet, 8 lb	89	U-Bolts - Square	241
Thermoplastic Tarp Straps	201	U-Bolts Merchandiser	34
Tilt Bins	64	Universal Display Boards	61
Tin Funnel	175	Universal Tail Pipe Hanger	253
Tire Chain Hardware	232	Universal Trailer Coupler Locks	138
Tire Chain Pliers	232	Used Fluid Drainer	166
Tire Inflator and Dial Gauge	101	Utility Bar	96
Tire Repair Kit	87	Utility Bar, 15"	87
Tire Tape Measure	128	Utility Grade - 6/Box	56, 80, 128
Titanium Drill Bit Set, 22 pcs	100	Utility Knife Blade Dispenser	84
Tool Bag with Pockets	87	Utility Knife Set, 26 pcs	95
Top Link Bushings	262	Utility Light with Hook and Magnetic Backing	69
Top Link Pins	263	Utility Pick-up Tool Set, 3 pcs	101
Top Link Repair Ends	262	Variable Speed - Die Cast Aluminum Pulleys	235
Top Links	262	Vertical Channel Mount Ease-Guide Trailer Couplers	136
Top Wind with Wheel	153	Warning Triangle	96
Top Wind Without Base or Wheel	153	Waste Oil Drainer and Charger	166
Top Wind, Square Tube Mount	155	Waterproof Padlocks - 1 / Package	127
Torque Bit Bar	113	Weather Caps	253
Torque Tamper Proof - Plain Finish Bits	109	Weather Caps Merchandiser	45
TORX - Plain Finish Bits	108	Welded Steel Ring	242
Tow Ropes	206	Wheel Chocks	158
Tow Straps	205	Wheel Locks	158
Tractor Drawbar Hook	254	Wheel Merchandiser	53
Tractor Funnel	175	Wheel Rack Merchandiser	274
Tractor Linkage Parts Merchandiser	44	White Recovery Straps	206
Trailer & Towing Plan-O-Gram 48"	9	Wide Spout Industrial Funnels	171
Trailer & Towing Plan-O-Gram 72"	8	Winch Bar - Type A	207
Trailer Ball Reducer Bushings	134	Winch Bar - Type C	207
Trailer Ball Replacement Holder	134	Winch Truck Straps	207
Trailer Balls Merchandiser	6	Wire Brush Set, 6 pcs	95
Trailer Connector Adapters	151	Wire Brush, 2 pcs s set	83
Trailer Connectors Merchandiser	7	Wire Connector Assortments, 158 Pieces	192
Trailer Coupler Repair Kits	135	Wire Ring Quick Release Pins	255
Trailer Couplers Merchandiser	6	Wire Rope	228
Trailer Lock Kit	138	Wire Rope Accessories Merchandiser	23, 27
Trailer Wheels - High Speed	157	Wire Terminals Assortments, 160 Pieces	191
Transmission Funnel	173, 175	Wire Wheel Set, 3 pcs	87
Transport Chain (Grade 70)	217	Woodruff Key Assortments, 80 Pieces	193
Trigger Snaps	247	Yellow Recovery Straps	205
Tri-Tap Extension Cord	97	Zip Pouch Set, 3 pcs	88
Tri-Wing Tamper Proof - Plain Finish Bits	110		
Trolleys	269		

