

BrassCraft®

Retail Catalog

Water & Gas Products

THIS IS OUR CRAFT.™

WATER SUPPLIES

GAS PRODUCTS

WATER HEATER CONNECTORS

FITTINGS

REPAIR PARTS



BrassCraft®, the brand of plumbing products you rely on because it offers the highest quality plumbing products manufactured today. We stand behind our products because we understand reputation and reliability are the only things that matter when the job is finished. Our products are designed for the pro and DIYers alike, never losing sight of what they really need to get the job done right the first time.

American Ingenuity, World-Class Performance.

Brasscraft Manufacturing Company, renowned for innovative products, continually goes beyond the performance of our world-class products with an equally high standard for customer service. We're committed to providing industry-leading merchandising, and a variety of packaging options, all delivered through the latest electronic commerce, on-time delivery and world-class distribution.

Water

1/4 Turn Supply Valves.....	6-8
Multi-Turn Supply Valves.....	9-11
Dual Outlet Supply Valves	12-13
Needle & IceMaker/Humidifier Valves.....	14
Water Supply Connectors.....	15-23
Water Supply One-Piece	24
Water Supply Kit	25
Water Supply Fittings	26-31
Components and Accessories	32-33
Water Heater Connectors	34-38

Gas

Gas Connectors	39-47
Installation Kits	48-49
Gas Ball Valves	50-51
Gas Fittings.....	52-53
Gas Components and Accessories.....	54
Point of Purchase.....	55-57
Specifications	58-73
Index	74-77



BrassCraft®

Designed, Machined and Assembled in the USA

Founded in 1946 by Robert Zell in Detroit, Michigan, Brasscraft Manufacturing Company pioneered the one-piece water supply valve and the flexible water supply tube. Today these products have become the industry standard for residential and commercial plumbing projects. Brasscraft Mfg. Co. has headquarters and manufacturing facilities across the U.S. We continue to remain competitive through major investments in our manufacturing facilities and by employing American workers.

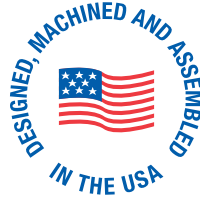

Products

Brasscraft Mfg. Co. makes many of the products we offer in our own North American manufacturing facilities. Many of these products are the same as those used by professional plumbers. In addition to being a prime manufacturer of plumbing supplies, Brasscraft Mfg. Co. also has its own Research & Development and Testing facilities, so you can be assured of top quality when you see the BrassCraft® logo. Our product offering continues to grow, as we continuously add new, innovative products to serve new customers and changing market needs.

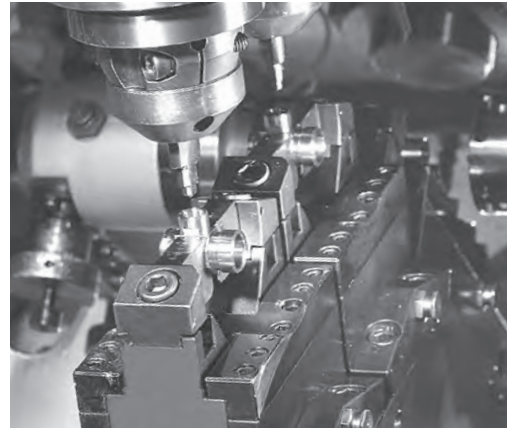

Packaging

Brasscraft packaging is designed to be appealing and user friendly. Our bright blue and yellow packaging catches the customer's attention, and each package contains complete, detailed installation instructions to make installing the products quick and easy. Our products are available in different packages such as cards, bags, boxes and bulk to serve a variety of customer needs. Our packaging is space efficient, allowing retailers to place more product in less space. This space savings results in more sales and profit dollars per square foot of valuable space. Reorder cards, the same size as the package, are available for each product, which makes display sets and restocking quick, easy and convenient.



Merchandising

BrassCraft® merchandising materials are designed to educate and sell more products. Our merchandising is appealing and informative, acting as a "silent sales person" to provide retailers and consumers with the information they need to locate and select the right products. We offer dynamic and informative department headers, aisle dividers, sizing guides, product displays and consumer take with brochures that make the plumbing department an easy to shop, self-sell aisle.



BrassCraft®

Product Assortments

Brasscraft Manufacturing Company offers 15 pre-made product assortments, available in various sizes for each product category. These assortments allow retailers to customize their plumbing department, according to their specific needs. The assortments are developed based on market research and analysis, so they contain the right products that consumers need. Each assortment comes complete with product, merchandising materials, reorder cards and planograms for easy display setup. BrassCraft® product assortments are an easy way to start a profitable plumbing department today!



The Latest Technology

When it comes to technology, Brasscraft Mfg. Co. has consistently led the industry. We understand the benefits of electronic commerce, and are constantly striving to implement the latest technologies to serve you better.

technology,
shipment,



EDI System

Saves time and helps ensure order accuracy by electronic order submission through our EDI (Electronic Data Interchange) system.

SureCount™ Verification

Our SureCount™ shipping verification system improves efficiency in the distribution stream and helps reduce your receiving costs. Using state-of-the-art bar code we verify outbound shipments to help eliminate the need to double-check the saving you time and money.

ROA Interface

BrassCraft Manufacturing's Remote Order Access system helps enable you to:

- Perform order entry and confirmation
- Check order status and ship dates
- Access invoices and packing slips
- Print packing lists
- Track shipments
- Online proof of delivery

Interactive Web

The streamlined, user-friendly site provides detailed information on the growing range of BrassCraft® plumbing supplies. Our website can be used with most handheld devices from smart phones, feature phones to tablet computers.

Compliant Solutions for the 2014 No Lead Law

As of January 4, 2014, Federal Public Law 111-380 prohibits the sale of plumbing fixtures with a wetted surface area containing more than a weighted average of 0.25% lead. This law virtually eliminates the lead content of pipes, pipe fittings, plumbing fittings and fixtures intended to convey or dispense water for drinking or cooking.

BrassCraft products meet the no-lead law with a comprehensive range of compliant products including brass stops, braided water connectors, brass fittings, and hot water heater connectors.

Look for the checkmark  on packaging to verify that the product meets the no-lead legislation requirements.

Terms and Abbreviations

The following list of terms and abbreviations are used throughout this catalog. For your convenience, we have included a brief definition or explanation for each of these terms. Thank you for choosing the best. Thank you for choosing BrassCraft®!



Fig. 1
Bell Escutcheon



Fig. 2
Faucet Riser



Fig. 3
Braided Flexible
One-Piece Supplies

Comp: Compression.

CPVC: Chlorinated Polyvinyl Chloride, a plastic used in plumbing systems.

CSA: Canadian Standards Association.

Escutcheon: Wall flange, or trim. (Fig. 1)

FIP: Female Iron Pipe.

IAPMO: International Association of Plumbing & Mechanical Officials.

ID: Inside Diameter.

IPS: Iron Pipe Size.

MIP: Male Iron Pipe.

Nom: Nominal measurement is 1/8" less than OD of the tube.

NSF: National Sanitation Foundation.

OD: Outside Diameter.

PEX: Cross-linked Polyethylene, a plastic used in plumbing systems.

Riser: A water supply tube to a faucet or a toilet. (Fig. 2)

Braided Flexible One-Piece Supplies: One-piece water supply featuring Brasscraft Manufacturing Co. patented engineered polymer braid connector and reinforced PVC flexible connector. Connector is factory attached. (Fig. 3)

Stop: Turns water supply on/off.

UPC: Uniform Plumbing Code.

Quality That Runs in the Family

BrassCraft® valves, machined from solid brass, offer the highest quality and most reliable connections. The finished valves are offered for a variety of connections including Compression, Sweat, CPVC and Push Connect™. Options include metal stems, lock shields, dual outlets, dual shut-offs, stuffing boxes and handles.

BrassCraft® valves are designed, machined and assembled in the USA for reliability, consistently exceeding industry standards while offering superior performance, and are delivered with exceptional customer service. As the leading manufacturer of water valves for more than 70 years, Brasscraft Mfg. Co. has the valve to meet your needs.



B1-30A F, B1-9DL F, B8-30A F,
excluded from Designed, Machined
and Assembled in the U.S.A.



✓ No Lead

Multi-Turn Valves

Multi-turn valves are the industry standard with proven performance. Available in a wide variety of configurations.



G2™ Series 1/4 Turn Valves

1/4 turn valves offer durable construction and innovation. Available with a full range of options, including push connect technology.



1/4 Turn Water Supply Valves

G2™ Series

1/4 turn technology offers durable construction and proven performance. Additional features and benefits include:

- Positive 1/4 turn shut off
- One-piece shut off mechanism provides smooth operation without freeze ups even after long periods of non-use
- Machined one-piece brass body provides strength, durability, and long lasting performance
- Easy-to-remove handle protects against accidental stop operation during rough-ins
- 100% leak tested

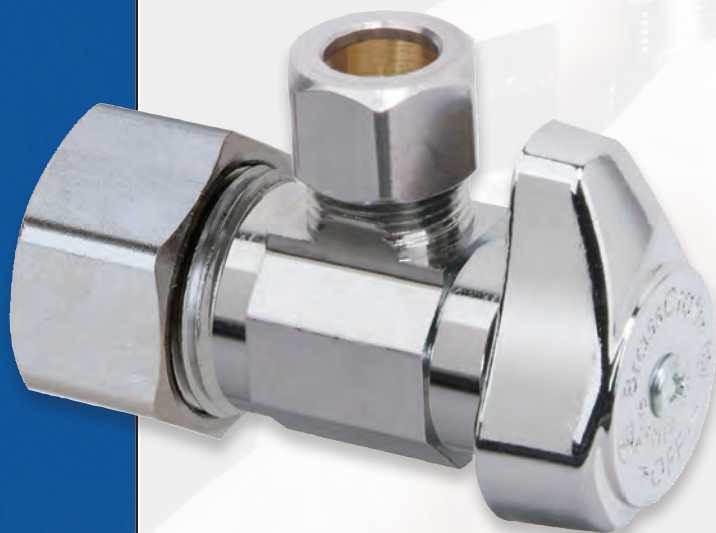

Push Connect Technology

Connect with Confidence. Fast. Reliable. Durable.
Additional features and benefits include:

- Installation ready with pre-assembled tube insert
- No special installation tools required
- Smooth 1/4 turn operation
- Compatible with copper, PEX and CPVC
- 100% leak tested

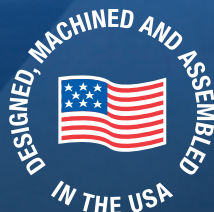

B1-30A F, B1-9DL F, B8-30A F,
excluded from Designed, Machined
and Assembled in the U.S.A.



 **No Lead**

Part No. UPC	Description Package Size	Finish	Shelf Qty	Case Qty
-----------------	-----------------------------	--------	--------------	-------------

Compression x Compression - Angle

G2CR09X CD 026613138046	1/2" Nom Comp x 1/4" OD Comp 1 Per Card. 3.875"L x 3.875"W x 1.175"D	Chrome	5	25
G2CR19X CD 026613138091	1/2" Nom Comp x 3/8" OD Comp 1 Per Card. 3.875"L x 3.875"W x 1.175"D	Chrome	5	25
G2CR39X CD 026613139777	1/2" Nom Comp x 1/2" OD Comp 1 Per Card. 3.875"L x 3.875"W x 1.175"D	Chrome	5	25



Compression x Compression - Straight

G2CR11X CD 026613139753	1/4" Nom Comp x 3/8" OD Comp 1 Per Card. 3.875"L x 3.875"W x 1.175"D	Chrome	5	25
G2CR14X CD 026613137902	1/2" Nom Comp x 3/8" OD Comp 1 Per Card. 3.875"L x 3.875"W x 1.18"D	Chrome	5	25
G2CR34X CD 026613139760	1/2" Nom Comp x 1/2" OD Comp 1 Per Card. 3.875"L x 3.875"W x 1.175"D	Chrome	5	25



Compression x Slip-Joint - Angle

G23341X CD 026613139739	1/2" Nom Comp x 7/16" & 1/2" OD Slip-Joint 1 Per Card. 3.875"L x 3.875"W x 1.175"D	Chrome	5	25
----------------------------	---	--------	---	----



Compression x Slip-Joint - Straight

G23345X CD 026613139746	1/2" Nom Comp x 7/16" & 1/2" OD Slip-Joint 1 Per Card. 3.875"L x 3.875"W x 1.175"D	Chrome	5	25
----------------------------	---	--------	---	----



FIP x Compression - Angle

G2R07X CD 026613138107	1/2" FIP x 1/4" OD Comp 1 Per Card. 3.875"L x 3.875"W x 1.175"D	Chrome	5	25
G2R15X CD 026613139791	3/8" FIP x 1/4" OD Comp 1 Per Card. 3.875"L x 3.875"W x 1.175"D	Chrome	5	25
G2R17X CD 026613137933	1/2" FIP x 1/4" OD Comp 1 Per Card. 3.875"L x 3.875"W x 1.175"D	Chrome	5	25
G2R37X CD 026613139807	1/2" FIP x 1/2" OD Comp 1 Per Card. 3.875"L x 3.875"W x 1.175"D	Chrome	5	25



FIP x Compression - Straight

G2R10X CD 026613139784	3/8" FIP x 3/8" OD Comp 1 Per Card. 3.875"L x 3.875"W x 1.175"D	Chrome	5	25
G2R12X CD 026613138114	1/2" FIP x 3/8" OD Comp 1 Per Card. 3.875"L x 3.875"W x 1.175"D	Chrome	5	25



FIP x Slip-Joint - Angle

G23301X CD 026613138022	1/2" FIP x 7/16" & 1/2" OD Slip-Joint 1 Per Card. 3.875"L x 3.875"W x 1.175"D	Chrome	5	25
----------------------------	--	--------	---	----





Part No. UPC	Description Package Size	Finish	Shelf Qty	Case Qty
FIP x Slip-Joint - Straight				
G23305X CD 026613138039	1/2" FIP x 7/16" & 1/2" OD Slip-Joint 1 Per Card. 3.875"L x 3.875"W x 1.175"D	Chrome	5	25



ΔCPVC Solvent Weld x Compression - Angle				
G2PR19X CD 026613149639	1/2" Nom CPVC x 3/8" OD Comp 1 Per Card. 3.875"L x 3.875"W x 1.175"D	Chrome	5	25



ΔCPVC Solvent Weld x Compression - Straight				
G2PR14X CD 026613149622	1/2" Nom CPVC x 3/8" OD Comp 1 Per Card. 3.875"L x 3.875"W x 1.175"D	Chrome	5	25



Push Connect x Compression - Angle				
G2PS19X CD 026613159966	1/2" Nom Push Connect x 3/8" OD Comp 1 Per Clamshell. 4.8125"L x 2.6875"W x 1.25"D	Chrome	5	25



Push Connect x Compression - Straight				
G2PS14X CD 026613159973	1/2" Nom Push Connect x 3/8" OD Comp 1 Per Clamshell. 4.8125"L x 2.6875"W x 1.25"D	Chrome	5	25



Push Connect Combination Removal Tool				
PCT-10-6 026613142197	1/2" Nom and 1/4" Nom Combination Removal Tool 1 Per Bag. 5"L x 3"W x 0.31"D	-	-	10

Anatomy of a BrassCraft® Supply Valve

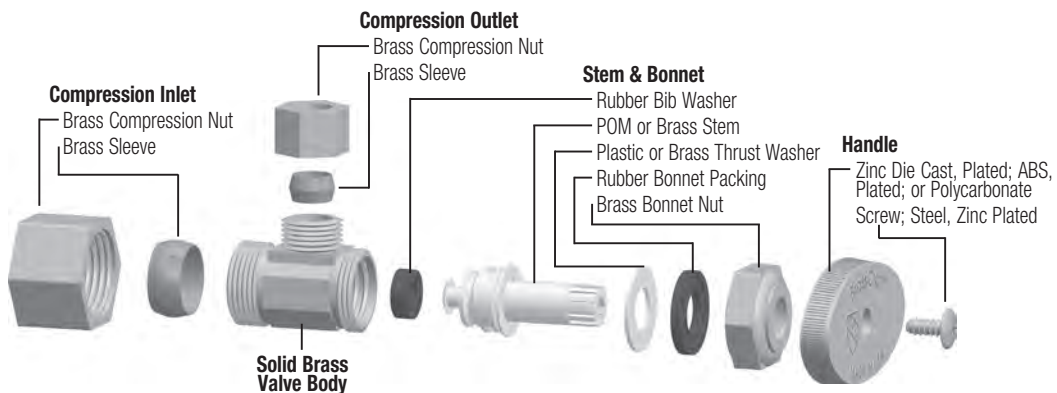

Δ CPVC pre-torqued fittings eliminate the need for tightening on the job.

Multi-Turn Water Supply Valves

The Industry Standard for Quality and Reliability.

Features and benefits include:

- Machined one-piece brass body provides strength, durability and long-lasting performance
- Easy-to-remove handle protects against accidental stop operation during rough-ins
- Oval knurled handle provides a secure grip and smooth on/off operation
- Dual outlet configurations available

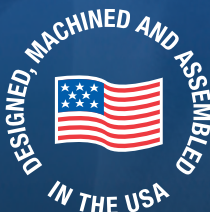
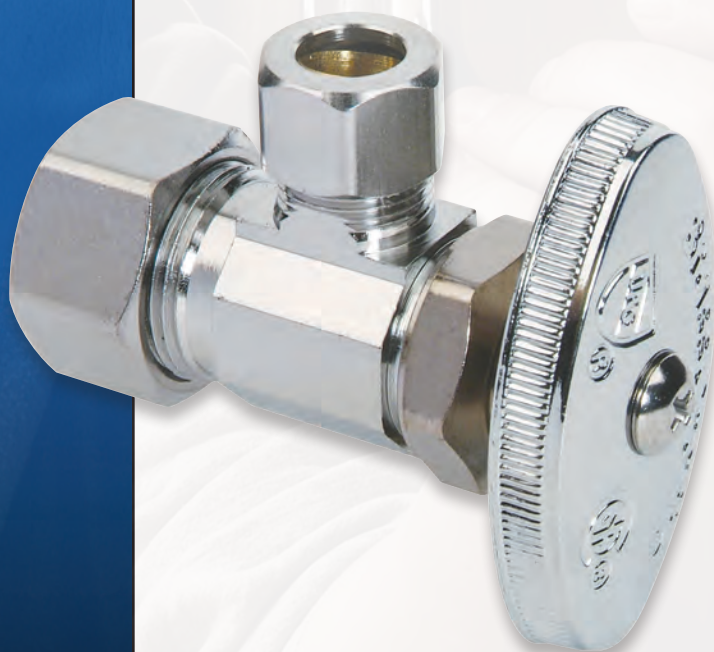

B1-30A F, B1-9DL F, B8-30A F,
excluded from Designed, Machined
and Assembled in the U.S.A.



 **No Lead**



Part No. UPC	Description Package Size	Finish	Shelf Qty	Case Qty
-----------------	-----------------------------	--------	--------------	-------------

Compression x Compression - Angle

OCR19X C1 026613135786	1/2" Nom Comp x 3/8" OD Comp 1 Per Tray. 2.75"L x 2.25"W x 1.1875"D	Chrome	-	20
---------------------------	--	--------	---	----



Compression x Compression - Straight

OCR14X C1 026613135977	1/2" Nom Comp x 3/8" OD Comp 1 Per Tray. 2.75"L x 2.25"W x 1.1875"D	Chrome	-	20
---------------------------	--	--------	---	----



FIP x Compression - Straight

OR32X CD 026613157818	1/2" FIP x 1/2" OD Comp 1 Per Card. 3.875"L x 3.875"W x 1.175"D	Chrome	5	25
--------------------------	--	--------	---	----



FIP x Flare - Angle

OFR17X CD 026613150512	1/2" FIP x 3/8" OD Flare 1 Per Card. 3.875"L x 3.875"W x 1.175"D	Chrome	5	25
---------------------------	---	--------	---	----



FIP x Flare - Straight

OFR12X C1 026613156132	1/2" FIP x 1/2" OD Flare 1 Per Tray. 2.75"L x 2.25"W x 1.1875"D	Chrome	-	20
---------------------------	--	--------	---	----



Sweat x Compression - Angle

R19X CD 026613151489	1/2" Nom Sweat x 3/8" OD Comp 1 Per Card. 3.875"L x 3.875"W x 1.175"D	Chrome	5	25
-------------------------	--	--------	---	----



Sweat x Compression - Straight

R14X CD 026613151410	1/2" Nom Sweat x 1/4" OD Comp 1 Per Card. 3.875"L x 3.875"W x 1.175"D	Chrome	5	25
-------------------------	--	--------	---	----

Part No. UPC	Description Package Size	Finish	Shelf Qty	Case Qty
-----------------	-----------------------------	--------	--------------	-------------

Sweat x Compression - Angle With 5" Sweat Extension Tube

CS40BX CD 026613149349	1/2" Nom Sweat x 3/8" OD Comp With Bell Escutcheon 1 Per Clamshell. 7.4375"L x 5.0625"W x 1.25"D	Chrome	-	5
---------------------------	---	--------	---	---



Sweat x Compression - Straight With 5" Sweat Extension Tube

CS41BX CD 026613149400	1/2" Nom Sweat x 3/8" OD Comp With Bell Escutcheon 1 Per Clamshell. 7.4375"L x 5.0625"W x 1.25"D	Chrome	-	5
---------------------------	---	--------	---	---



PEX Tube Compression Connection

For PEX Tube 3/8" OD and smaller, use plastic compression sleeve.

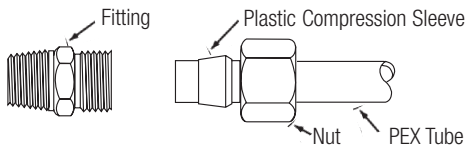

For PEX Tube larger than 3/8" OD, use brass compression sleeve with stainless steel tube insert.

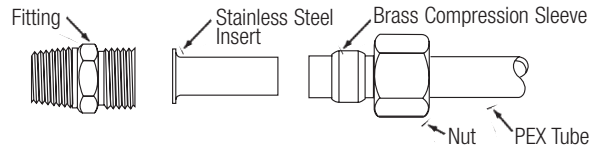

NOTE: All 3/8" OD PEX Risers come with plastic compression sleeve.
All 1/2" OD PEX Risers come with stainless steel tube insert.

Part No. UPC	Description Package Size	Finish	Shelf Qty	Case Qty
-----------------	-----------------------------	--------	--------------	-------------

Compression x Compression x Compression - Angle



CR1900DVX C 026613137384	1/2" Nom Comp x 3/8" OD Comp x 1/4" OD Comp 1 Per Bag. 6"L x 6"W	Chrome	-	30
-----------------------------	---	--------	---	----



CR1901DVX CD 026613160375	1/2" Nom Comp x 3/8" OD Comp x 3/8" OD Comp 1 Per Card. 5.875"L x 3.875"W x 2.375"D	Chrome	-	5
------------------------------	--	--------	---	---

FIP x Compression x Compression - Angle



R1700DVX RD 026613160399	1/2" FIP x 3/8" OD Comp x 1/4" OD Comp 1 Per Card. 5.875"L x 3.875"W x 2.375"D	Rough	-	5
-----------------------------	---	-------	---	---



R1701DVX RD 026613160405	1/2" FIP x 3/8" OD Comp x 3/8" OD Comp 1 Per Card. 5.875"L x 3.875"W x 2.375"D	Rough	-	5
-----------------------------	---	-------	---	---

Part No. UPC	Description Package Size	Finish	Shelf Qty	Case Qty
-----------------	-----------------------------	--------	--------------	-------------

Compression x Compression x Compression

CR1901LRX RD 026613137889	1/2" Nom Comp x 3/8" OD Comp x 3/8" OD Comp 1 Per Card. 5.875"L x 3.875"W x 2.375"D	Rough	5	25
------------------------------	--	-------	---	----



FIP x Compression x Compression

R1700RX RD 026613138633	1/2" FIP x 3/8" OD Comp x 1/4" OD Comp 1 Per Card. 5.875"L x 3.875"W x 2.375"D	Rough	5	25
R1701LRX RD 026613138138	1/2" FIP x 3/8" OD Comp x 3/8" OD Comp 1 Per Card. 5.875"L x 3.875"W x 2.375"D	Rough	5	25
R3701RX RD 026613138121	1/2" FIP x 1/2" OD Comp x 3/8" OD Comp 1 Per Card. 5.875"L x 3.875"W x 2.375"D	Rough	5	25
R3703LRX RD 026613151687	1/2" FIP x 1/2" OD Comp x 1/2" OD Comp 1 Per Card. 5.875"L x 3.875"W x 2.375"D	Rough	5	25



Brass Needle & Icemaker/Humidifier Valves

Product Applications

- For use on most instrumentation, hydraulic and pneumatic systems.
- Designed for automotive or industrial use. Not intended for natural gas, LPG, nuclear or aircraft applications.

Product Advantages

- BrassCraft® Needle Valves have metal-to-metal seats with fine thread adjustment.
- Provide positive sealing and flow adjustment up to the capacity of the valve.
- Backed by Brasscraft Mfg. Co.'s 70 plus year history and reputation for quality and service.

*Compliant offering available

Part No. UPC	Description Package Size	Finish	Shelf Qty	Case Qty
Compression Needle Valves				
 NV105-4X D 026613158341	1/4" OD Comp x 1/4" OD Comp 1 Per Card. 3.875"L x 2.875"W x 1.175"D	Rough	5	25

Self-Piercing Needle Valve Kits				
 PNEV-NCVX D 026613158969	For 3/8" to 1" OD Tube w/1/4" OD Comp , Inc. Saddle Clamp With Self-Locking Nuts, Brass Sleeve & Insert, & Delrin Sleeve 1 Per Card. 3.875"L x 3.875"W x 1.175"D	Rough	5	25

 BC96X 026613148977	For 3/8" to 1" OD Tube w/1/4" OD Comp Incl. Saddle Clamp With Self-Locking Nuts, 1/4" OD x 25' Polyethylene Tube, Brass Sleeve & Inserts & Delrin Sleeve, & 1/4" OD Union 1 Per Clamshell. 9.5"L x 6"W x 1.75"D	Rough	-	5
---	--	-------	---	---

 BC97X 026613148984	For 3/8" to 1" OD Tube w/1/4" OD Comp Incl. Saddle Clamp With Self-Locking Nuts, 1/4" OD x 25' Copper Tube, Brass Sleeve & 1/4" OD Union 1 Per Clamshell. 11.1875"L x 8.625"W x 1.125"D	Rough	-	5
---	--	-------	---	---

 BC2466 L 026613164243	For 3/8" to 1" OD Tube w/1/4" OD Comp Incl. Saddle Clamp With Self-Locking Nuts, 1/4" OD x 15' Copper Tube, Brass Sleeve & 1/4" OD Union, PLACON	Rough	-	5
--	--	-------	---	---

Part No. UPC	Description Package Size	Length	Shelf Qty	Case Qty
Faucet - PEX				
P1-12A H 026613160030	3/8" OD 1 Per Hang Tag. 1.9375"L x 1.875"W x 0.75"D	12"	5	50
P1-12A 026613044859	3/8" OD Bulk Box. 6.62"L x 4.12"W x 12.88"D	12"	-	100
P1-20A 026613044910	3/8" OD Bulk Box. 6.62"L x 4.12"W x 20.88"D	20"	-	100
P1-30A 026613044958	3/8" OD Bulk Box. 4.12"L x 3.12"W x 30.38"D	30"	-	50
P1-36A H 026613160054	3/8" OD 1 Per Hang Tag. 1.9375"L x 1.875"W x 0.75"D	36"	5	25
P1-36A 026613044965	3/8" OD Bulk Box. 4.12"L x 3.12"W x 36.38"D	36"	-	50



Toilet - PEX				
P1-12DL H 026613160061	3/8" OD 1 Per Hang Tag. 1.9375"L x 1.875"W x 0.875"D	12"	5	50
P1-12DL F 026613046471	3/8" OD Bulk w/ Flag Label in Box. 15.375"L x 5.75"W x 4"D	12"	-	25
P1-12DL 026613044873	3/8" OD Bulk Box. 6.62"L x 4.12"W x 12.88"D	12"	-	100
P1-20DL F 026613046488	3/8" OD Bulk w/ Flag Label in Box. 21.125"L x 6.5"W x 3.5625"D	20"	-	25
P1-20DL 026613044934	3/8" OD Bulk Box. 6.62"L x 4.12"W x 20.88"D	20"	-	100



Faucet - Copper				
1-12A CH 026613159980	3/8" OD 1 Per Hang Tag. 1.9375"L x 1.875"W x 0.63"D	12"	5	50
1-20A CH 026613159997	3/8" OD 1 Per Hang Tag. 1.9375"L x 1.875"W x 0.63"D	20"	5	50
1-20A CF 026613046396	3/8" OD Bulk w/ Flag Label in Box. 21.125"L x 6.5"W x 3.5625"D	20"	-	25
1-36A CH 026613160009	3/8" OD 1 Per Hang Tag. 1.9375"L x 1.875"W x 0.63"D	36"	5	25



Toilet - Copper				
1-12DL CH 026613160016	3/8" OD 1 Per Hang Tag. 1.9375"L x 1.875"W x 0.875"D	12"	5	50
1-12DL CF 026613046426	3/8" OD Bulk w/ Flag Label in Box. 13"L x 4.125"W x 4.25"D	12"	-	25
1-20DL CH 026613160023	3/8" OD 1 Per Hang Tag.	20"	5	50
1-20DL CF 026613046433	3/8" OD Bulk w/ Flag Label in Box. 20.375"L x 5.75"W x 3.75"D	20"	-	25



NOTE: Actual riser length to connect less 1/2"

BrassCraft®

The Speedi Plumb® PLUS Connector is the most Corrosion Resistant Water Connector.

- Corrosion Resistant
- No Kinking or Crimping
- Superior Performance



B1-30A F, B1-9DL F, B8-30A F,
excluded from Designed, Machined
and Assembled in the U.S.A.



 No Lead

 No Lead

FLEXIBLE POLYMER BRAIDED CONNECTORS

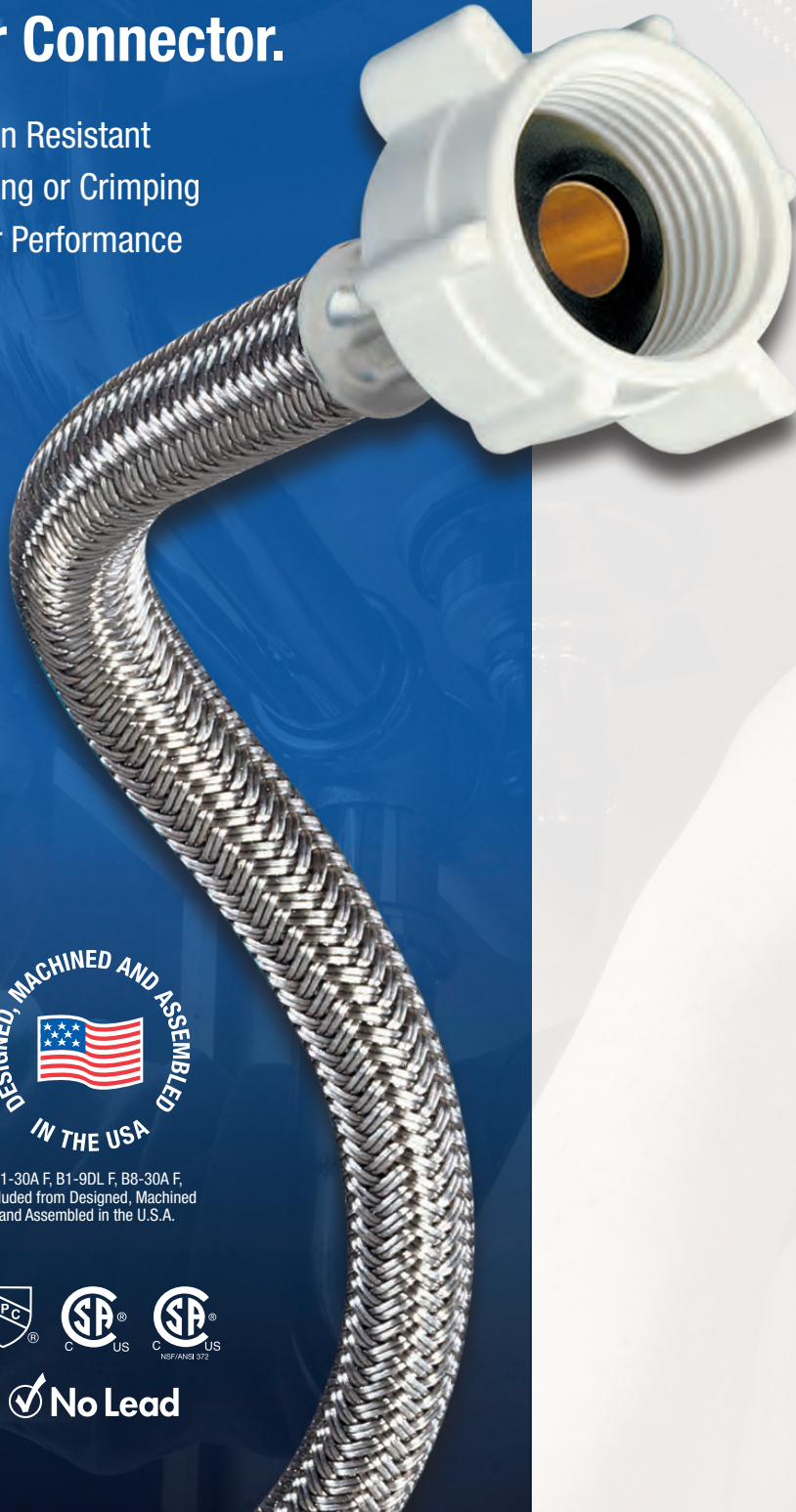

Speedi Plumb® PLUS Connector

BrassCraft® Speedi Plumb® PLUS connectors offer superior performance, with advanced construction and appeal.

The BrassCraft® Speedi Plumb PLUS® connector is the most corrosion resistant water connector. Designed for longer life under the harshest conditions, the BrassCraft® Speedi Plumb® PLUS connector features tough polymer-coated fibers tightly braided around a strong PVC inner hose. The result is a corrosion resistant, highly flexible, extremely reliable water supply connector for use with faucets, toilets, dishwashers, washing machines, water heaters, icemakers and humidifiers.

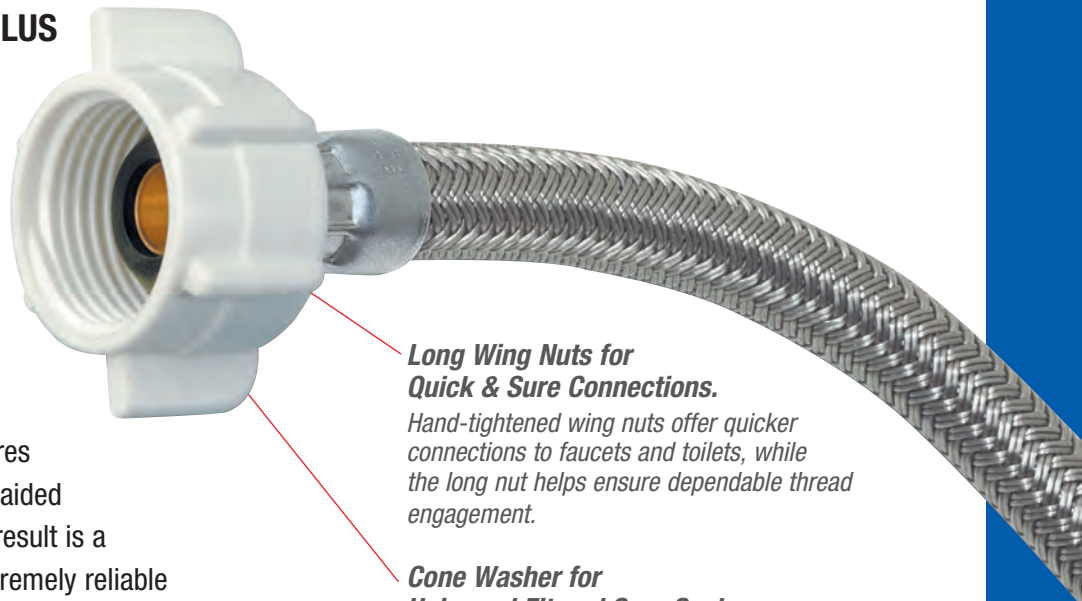

Long Wing Nuts for Quick & Sure Connections.

Hand-tightened wing nuts offer quicker connections to faucets and toilets, while the long nut helps ensure dependable thread engagement.

Cone Washer for Universal Fit and Sure Seal.

The cone washer's large sealing surface helps ensure a secure connection and a universal fit.

BrassCraft® Speedi Plumb® PLUS Connectors Resist Corrosion.

The braided polymer-coated fibers in BrassCraft® Speedi Plumb® PLUS connectors are specially engineered to resist corrosion caused by most chemicals found in common household tile and glass cleaners including:

- Ammonia
- Phosphoric Acid
- Sodium Hypochlorite
- Hydrogen Chloride
- Muriatic Acid
- Dimethyl Benzyl Ammonium Chloride



The BrassCraft® Speedi Plumb® PLUS engineered polymer-braided jacket also resists corrosion from solder flux from installation and repair, and completely helps protect the inner tube, even in a harsh chemical environment.

The Brasscraft Manufacturing Co. Commitment to Compliance. ✓

As an industry leader, we are continuously developing solutions for the ever-changing marketplace. In 2009, we were one of the first manufacturers to introduce no-lead products compliant with California's low-lead legislation. As this legislation expanded to a nationwide implementation in January 2014, we continued our commitment to provide a full range of high quality compliant products, including Speedi Plumb® connectors.

BrassCraft® Speedi Plumb® PLUS connectors are IAPMO and CSA listed to ASME A112.18.6-2009/CSA B125.6-2009, the only national standard for flexible water connectors and NSF/ANSI 372-Drinking Water System Components-Lead Content.



THE MOST CORROSION RESISTANT CONNECTOR

Allows for Speedier Connections.

The braided polymer-coated fibers bend freely, without kinking or crimping. Installation is easier, especially in cramped quarters.

Patented Engineered Polymer Braid and PVC Hose Resist Leaks.

The BrassCraft® Speedi Plumb® PLUS connector's exclusive, patented construction features a high tenacity, multi-filament core yarn, protected by a special polymer coating. The result is optimum corrosion resistance and durability. Inside, our tough PVC tubing resists attack by chlorine and chloramine.

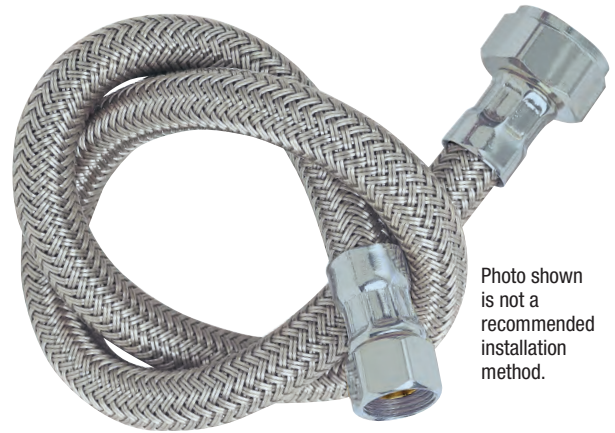

Photo shown is not a recommended installation method.

Stop End Provides More Secure Connections.

Deep threads in the compression nut assure secure engagement, while the elastomer rubber seal eliminates metal-to-metal connections which have been known to damage water stops.

8-Sided Pneumatic Crimp for Greater Dependability.

Precise 8-sided crimp helps ensure reliable nut-to-hose connections.



BrassCraft® Speedi Plumb® PLUS Connectors for Every Application.

Choose from our complete inventory of BrassCraft® Speedi Plumb® PLUS connectors for faucet, toilet, dishwasher, washing machine, ice-maker and humidifier hook-ups, and supply kits for dishwashers and “Low Boy” toilets.

Water heater connectors are also available, featuring specially coated fibers for continuous exposure to high heat. Choose from a full line of end fitting configurations.



Part No. UPC	Description Package Size	Length	Shelf Qty	Case Qty
-----------------	-----------------------------	--------	--------------	-------------

Faucet - Compression

PSB830 039166029716	3/8" Comp x 1/2" FIP Bulk w/ Flag Label in Box. 14"L x 4.75"W x 3"D	12"	-	10
PSB832 039166029723	3/8" Comp x 1/2" FIP Bulk w/ Flag Label in Box. 21"L x 4"W x 3.5"D	16"	-	10
PSB836 039166029730	3/8" Comp x 1/2" FIP Bulk w/ Flag Label in Box. 21"L x 4"W x 3.5"D	20"	-	10
PS838 039166030194	3/8" Comp x 1/2" FIP 1 Per Clamshell. 9.5"L x 6"W x 1.75"D	36"	-	5
PSB838 039166032822	3/8" Comp x 1/2" FIP Bulk w/ Flag Label in Box. 38"L x 4.75"W x 3.75"D	36"	-	10
PSB863 039166029846	1/2" Comp x 1/2" FIP Bulk w/ Flag Label in Box. 14"L x 4.75"W x 3"D	12"	-	10
PSB866 039166029938	1/2" Comp x 1/2" FIP Bulk w/ Flag Label in Box. 21"L x 4"W x 3.5"D	20"	-	10



Faucet - FIP

PSB840 039166029891	1/2" FIP x 1/2" FIP Bulk w/ Flag Label in Box. 14"L x 4.75"W x 3"D	12"	-	10
PSB846 039166029914	1/2" FIP x 1/2" FIP Bulk w/ Flag Label in Box. 21"L x 4"W x 3.5"D	20"	-	10



Universal Faucet - FIP

B1-20AU D 026613106762	3/8" Comp x 1/2" FIP With 1/2" IP and 1/2" Comp Valve Adaptor 1 Per Clamshell. 9.5"L x 6"W x 1.75"D	20"	-	5
---------------------------	--	-----	---	---



Faucet - Compression x KC Nosepiece

PSB873 039166029747	3/8" Comp x 3/8" Comp Bulk w/ Flag Label in Box. 14"L x 4.75"W x 3"D	12"	-	10
PSB877 039166029853	3/8" Comp x 3/8" Comp Bulk w/ Flag Label in Box. 21"L x 4"W x 3.5"D	20"	-	10



Toilet - Compression

PSB855 039166029952	3/8" Comp x 7/8" Ballcock Bulk w/ Flag Label in Box. 14"L x 4.75"W x 3"D	9"	-	10
PSB856 039166029969	3/8" Comp x 7/8" Ballcock Bulk w/ Flag Label in Box. 14"L x 4.75"W x 3"D	12"	-	10
PSB857 039166029976	3/8" Comp x 7/8" Ballcock Bulk w/ Flag Label in Box. 21"L x 4"W x 3.5"D	20"	-	10
PSB860 039166030019	1/2" Comp x 7/8" Ballcock Bulk w/ Flag Label in Box. 21"L x 4"W x 3.5"D	20"	-	10



Toilet - FIP

PSB858 039166030033	1/2" FIP x 7/8" Ballcock Bulk w/ Flag Label in Box. 14"L x 4.75"W x 3"D	12"	-	10
------------------------	--	-----	---	----





Part No. UPC	Description Package Size	Length	Shelf Qty	Case Qty
PSB833	1/2" Comp x 7/8" Ballcock	12"	-	10
039166030774	Bulk w/ Flag Label in Box. 6.9375"L x 2"W x 6.9375"D			

Toilet - Compression For Low Boy Toilets



Part No.	Description	Length	Shelf Qty	Case Qty
B1-12DLU D	3/8" Comp x 7/8" Ballcock With 1/2" IP and 1/2" Comp Valve Adaptor	12"	-	5
026613106731	1 Per Clamshell. 9.5"L x 6"W x 1.75"D			

Universal Toilet - Compression



Part No.	Description	Length	Shelf Qty	Case Qty
BL12-48WA P	3/4" Female Hose Thread x 3/4" Female Hose Thread	48"	-	10
026613142043	1 Per Bag. 12"L x 10.5"W x 1.5"D			
BL12-60WA P	3/4" Female Hose Thread x 3/4" Female Hose Thread	60"	-	10
026613142050	1 Per Bag. 12"L x 10.5"W x 1.5"D			
BL12-60WA P2	3/4" Female Hose Thread x 3/4" Female Hose Thread	60"	-	5
026613160429	2 Per Bag. ?			
BL12-72WA P	3/4" Female Hose Thread x 3/4" Female Hose Thread	72"	-	10
026613142067	1 Per Bag. 12"L x 10.5"W x 1.5"D			
BL12-72WA B	3/4" Female Hose Thread x 3/4" Female Hose Thread	72"	-	25
026613966113	Bulk Box. 20.375"L x 15.75"W x 13.375"D			

Washing Machine - Female Hose Thread



Part No.	Description	Length	Shelf Qty	Case Qty
B1-48DW6 P	3/8" Comp x 3/8" Comp With 3/8" MIP Elbow	48"	-	10
026613141787	1 Per Bag. 12"L x 10.5"W x 1.375"D			

Dishwasher - Compression



Part No.	Description	Length	Shelf Qty	Case Qty
B1-48DW12 P	3/8" Comp x 3/8" Comp With 3/4" Garden Hose Elbow	48"	-	10
026613141756	1 Per Bag. 12"L x 10.5"W x 1.75"D			

Dishwasher - Garden Hose Elbow



Part No.	Description	Length	Shelf Qty	Case Qty
B1-60DW6 P	3/8" Comp x 3/8" Comp With 3/8" MIP Elbow	60"	-	10
026613141794	1 Per Bag. 12"L x 10.5"W x 1.5"D			
B1-72DW6 P	3/8" Comp x 3/8" Comp With 3/8" MIP Elbow	72"	-	10
026613141800	1 Per Bag. 12"L x 10.5"W x 1.5"D			

Dishwasher - Compression



Part No.	Description	Length	Shelf Qty	Case Qty
B1-72DW F	3/8" Comp x 3/8" Comp	72"	-	10
026613104430	Bulk w/ Flag Label in Box. 15.8125"L x 12.75"W x 8.375"D			

Bulk w/ Flag Label in Box. 15.8125"L x 12.75"W x 8.375"D



Part No.	Description	Length	Shelf Qty	Case Qty
B1U-48DW612 D	3/8" Comp x 3/8" Comp With 1/2" IP and 1/2" Comp Stop Adaptors, 3/8" MIP and 3/4" Garden Hose Elbows	48"	-	10
026613140797	1 Per Card. 9.5"L x 7.75"W x 1.75"D			
B1U-72DW612 D	3/8" Comp x 3/8" Comp With 1/2" IP and 1/2" Comp Stop Adaptors, 3/8" MIP and 3/4" Garden Hose Elbows	72"	-	5
026613160528				

Universal Dishwasher - Compression

Part No. UPC	Description Package Size	Length	Shelf Qty	Case Qty
Dishwasher - Compression				
BL3-48DW F 026613104461	1/2" Comp x 1/2" Comp Bulk w/ Flag Label in Box. 8.875"L x 8.875"W x 5.25"D	48"	-	10
BL3-60DW F 026613104478	1/2" Comp x 1/2" Comp Bulk w/ Flag Label in Box. 8.875"L x 8.875"W x 5.25"D	60"	-	10
BL3-72DW F 026613104485	1/2" Comp x 1/2" Comp Bulk w/ Flag Label in Box. 8.875"L x 8.875"W x 5.25"D	72"	-	10



Dishwasher - Garden Hose Elbow				
B1-60DW1 P 026613141169	3/8" Comp x 3/4" Garden Hose Elbow (Crimped) 1 Per Bag. 12"L x 10.5"W x 1.5"D	60"	-	10



Dishwasher - FIP				
B8-60DW6 P 026613141824	1/2" FIP x 3/8" Comp With 3/8" MIP Elbow 1 Per Bag. 12"L x 10.5"W x 0.875"D	60"	-	10



Ice Maker/Humidifier/Water Filter				
B0-12IM F 026613104836	1/4" Comp x 1/4" Comp Bulk w/ Flag Label in Box. 15.375"L x 5.75"W x 4"D	12"	-	25
B0-60IM P 026613142005	1/4" Comp x 1/4" Comp 1 Per Bag. 12"L x 10.5"W x 1.5"D	60"	-	10
B0-72IM P 026613142012	1/4" Comp x 1/4" Comp 1 Per Bag. 12"L x 10.5"W x 1.5"D	72"	-	10
B0-96IM P 026613142036	1/4" Comp x 1/4" Comp 1 Per Bag. 12"L x 10.5"W x 1.5"D	96"	-	10
B0-120IM P 026613141992	1/4" Comp x 1/4" Comp 1 Per Bag. 12"L x 10.5"W x 1.5"D	120"	-	10



Part No. UPC	Description Package Size	Length	Shelf Qty	Case Qty
-----------------	-----------------------------	--------	--------------	-------------

Faucet - Compression

PSB130 039166601301	3/8" Comp x 1/2" FIP Bulk w/ Flag Label in Box. 14"L x 4.75"W x 3"D	12"	-	10
PSB132 039166601325	3/8" Comp x 1/2" FIP Bulk w/ Flag Label in Box. 21"L x 4"W x 3.5"D	16"	-	10
PS136 039166001361	3/8" Comp x 1/2" FIP 1 Per Clamshell. 9.5"L x 6"W x 1.875"D	20"	-	10
PSB136 039166601363	3/8" Comp x 1/2" FIP Bulk w/ Flag Label in Box. 21"L x 4"W x 3.5"D	20"	-	10
PS138 039166001385	3/8" Comp x 1/2" FIP 1 Per Clamshell. 9.5"L x 6"W x 1.75"D	36"	-	5
PSB138 039166010554	3/8" Comp x 1/2" FIP Bulk w/ Flag Label in Box. 38"L x 4.75"W x 3.75"D	36"	-	10



Faucet - FIP

PSB141 039166601417	1/2" FIP x 1/2" FIP Bulk w/ Flag Label in Box. 14"L x 4.75"W x 3"D	12"	-	10
PSB143 039166601431	1/2" FIP x 1/2" FIP Bulk w/ Flag Label in Box. 21"L x 4"W x 3.5"D	16"	-	10
PSB145 039166601455	1/2" FIP x 1/2" FIP Bulk w/ Flag Label in Box. 21"L x 4"W x 3.5"D	20"	-	10



Faucet - Compression x KC Nosepiece

PSB173 039166601738	3/8" Comp x 3/8" OD Comp Bulk w/ Flag Label in Box. 14"L x 4.75"W x 3"D	12"	-	10
PSB175 039166601752	3/8" Comp x 3/8" OD Comp Bulk w/ Flag Label in Box. 21"L x 4"W x 3.5"D	16"	-	10
PSB177 039166601776	3/8" Comp x 3/8" OD Comp Bulk w/ Flag Label in Box. 21"L x 4"W x 3.5"D	20"	-	10



Toilet - Compression

PSB155 039166601554	3/8" Comp x 7/8" Ballcock Bulk w/ Flag Label in Box. 14"L x 4.75"W x 3"D	9"	-	10
PSB156 039166601561	3/8" Comp x 7/8" Ballcock Bulk w/ Flag Label in Box. 14"L x 4.75"W x 3"D	12"	-	10
PSB157 039166601578	3/8" Comp x 7/8" Ballcock Bulk w/ Flag Label in Box. 21"L x 4"W x 3.5"D	16"	-	10
PSB168 039166601684	1/2" Comp x 7/8" Ballcock Bulk w/ Flag Label in Box. 14"L x 4.75"W x 3"D	12"	-	10



Toilet - FIP

PSB171 039166601714	1/2" FIP x 7/8" Ballcock Bulk w/ Flag Label in Box. 14"L x 4.75"W x 3"D	12"	-	10
------------------------	--	-----	---	----



Part No. UPC	Description Package Size	Length	Shelf Qty	Case Qty
-----------------	-----------------------------	--------	--------------	-------------

Washing Machine - Female Hose Thread

BC2456	3/4" Female Hose Thread x 3/4" Female Hose Thread, Red/Blue Fill Hose	60"	-	10
026613160504	2 Per Bag. 11" x 13.5" x 1.5"			



Part No. UPC	Description Package Size	Length	Shelf Qty	Case Qty
-----------------	-----------------------------	--------	--------------	-------------



Faucet - 1/4 Turn One-Piece Supply - Angle Valve Braided Connector

G2PS19B200AX F 026613158525	1/2" Nom Push Connect x 1/2" FIP Bulk w/ Flag Label in Box. 21.5"L x 6.5"W x 5.3125"D	20"	-	25
G2PS19B200HX D 026613160467	1/2" Nom Push Connect x 1/2" FIP 1 Per Card.	20"	-	5



Faucet - 1/4 Turn One-Piece Supply - Straight Valve Braided Connector

G2PS14B200HX F 026613170473	1/2" Nom Push Connect x 1/2" FIP Bulk w/ Flag Label in Box. 21.5"L x 6.5"W x 5.3125"D	20"	-	25
--------------------------------	--	-----	---	----



Toilet - 1/4 Turn One-Piece Supply - Angle Valve Braided Connector

G2PS19B120DLX F 026613158532	1/2" Nom Push Connect x 7/8" Ballcock Bulk w/ Flag Label in Box. 15.375"L x 6.5"W x 5.3125"D	12"	-	25
---------------------------------	---	-----	---	----



G2PS19B120DLX D 026613160450	1/2" Nom Push Connect x 7/8" Ballcock 1 Per Card.	12"	-	5
---------------------------------	--	-----	---	---



Toilet - 1/4 Turn One-Piece Supply - Straight Valve Braided Connector

G2PS14B120DLX F 026613170480	1/2" Nom Push Connect x 7/8" Ballcock Bulk w/ Flag Label in Box. 15.375"L x 6.5"W x 5.3125"D	12"	-	25
---------------------------------	---	-----	---	----

Part No. UPC	Description Package Size	Length	Shelf Qty	Case Qty
Low Boy Toilet - Multi-Turn FIP x Compression Angle Valve Braided Connector Compression x Ballcock				
PS8754	1/2" FIP x 3/8" OD Comp	12"	-	5
039166030903	3/8" Comp x 7/8" Ballcock With 1/2" Nom x 1/2" MIP Adaptor 1 Per Clamshell. 9.5"L x 6"W x 1.75"D			



Iron Pipe Fittings

Product Applications

- For use with brass, copper or iron pipe.
- Designed for up to 1,200 PSI.
- Typically used in water and refrigeration systems.



Product Advantages

- All pipe fitting threads meet the standards developed by the Society of Automotive Engineers (SAE).
- Backed by Brasscraft Manufacturing's 70 plus year history and reputation for quality and service.

*Compliant offering available



Part No. UPC	Description Package Size	Finish	Shelf Qty	Case Qty
Pipe Nipples				
113-06-4-CX D 026613158310	3/8" MIP x 4" 2 Per Card. 5.625"L x 3"W x 0.875"D	Chrome	5	25
113-06-6-CX D 026613158242	3/8" MIP x 6" 2 Per Card. 7.75"L x 3"W x 0.875"D	Chrome	5	25
113-08-3-CX D 026613158211	1/2" MIP x 3" 2 Per Card. 5.625"L x 3"W x 0.875"D	Chrome	5	25
113-08-4-CX D 026613158457	1/2" MIP x 4" 2 Per Card. 5.625"L x 3"W x 0.875"D	Chrome	5	25

Brass Compression Fittings

Product Applications

- For use with potable water, instrumentation, hydraulic and pneumatic systems.
- Designed to be used with aluminum, copper and plastic tubing. Not recommended for steel tubing. Plastic tubing requires 63PT insert and 60PT sleeve.
- *Compliant offering available

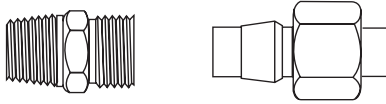

▲ WARNING: Do not use compression fittings for gas connections of any kind.

Product Advantages

- BrassCraft® compression fittings do not require any flaring, soldering or other type of tubing preparation.
- Available in a broad range of sizes and styles.
- Manufactured from brass rod.
- Backed by Brasscraft Manufacturing's 70 plus year history and reputation for quality and service.

Working Pressure Ranges

- Operating temperatures and tubing type are important factors. The following table (73° F temperature with copper tubing) is a good guide to use for proper selection.

PSI	Tube OD (IN)	Tube Wall (IN)
400	1/8	.030
400	3/16	.030
300	1/4	.030
300	5/16	.032
200	3/8	.032
200	1/2	.032
150	5/8	.035
100	3/4	.035
75	7/8	.035

How to Order

- Ordered as complete assemblies (body, nut, sleeve). Nuts and sleeves can also be ordered separately by part number.

Special Orders

- Special fitting configurations and sizes may be ordered. Please furnish a print or sketch of your needs with your inquiry.
- Fittings are available in bulk quantities on request. Contact your sales representative for details.



PEX Tube Compression Connection

For PEX Tube 3/8" OD and smaller, use plastic compression sleeve.

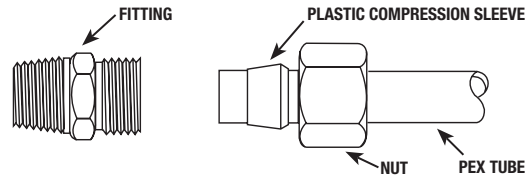

For PEX Tube larger than 3/8" OD, use brass compression sleeve with stainless steel tube insert.

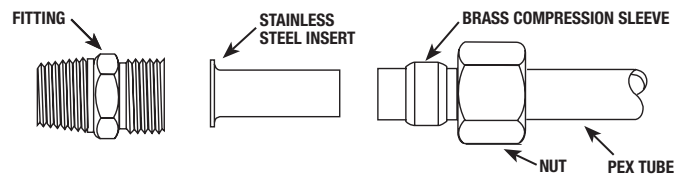

Part No. UPC	Description Package Size	Finish	Shelf Qty	Case Qty
-----------------	-----------------------------	--------	--------------	-------------



Compression Nuts & Sleeves

P81 039166021222	For 3/8" OD Tube 2 Each Per Card. 3.875"L x 1.875"W x 1.1"D	Chrome	5	25
---------------------	--	--------	---	----



Compression Female Adaptors

10X CD 026613158297	3/8" OD Tube, Drill Through (No Tube Stop) x 3/8" FIP 2 Per Card. 3.875"L x 2.875"W x 1.22"D	Chrome	5	25
12X CD 026613158198	3/8" OD Tube, Drill Through (No Tube Stop) x 1/2" FIP 2 Per Card. 3.875"L x 2.875"W x 1.22"D	Chrome	5	25



Compression Male Adaptors

11X CD 026613158259	3/8" OD Tube, Drill Through (No Tube Stop) x 3/8" MIP 2 Per Card. 3.875"L x 2.875"W x 1.22"D	Chrome	5	25
13X CD 026613158266	3/8" OD Tube, Drill Through (No Tube Stop) x 1/2" MIP 2 Per Card. 3.875"L x 2.875"W x 1.22"D	Chrome	5	25



Compression Sweat Adaptor

14X CD 026613158167	1/2" Nom Sweat x 3/8" OD Tube, Drill Through (No Tube Stop) 2 Per Card. 3.875"L x 2.875"W x 1.22"D	Chrome	5	25
------------------------	---	--------	---	----



Compression Speedi Adaptors

462-6-6-1X CD 026613158334	3/8" Female Flare x 3/8" OD Tube, Washer Included 1 Per Card. 3.875"L x 1.875"W x 1.1"D	Chrome	5	50
462-8-6-1X CD 026613158327	1/2" Female Flare x 3/8" OD Tube, Washer Included 1 Per Card. 3.875"L x 1.875"W x 1.1"D	Chrome	5	50
63-6-8WX CD 026613158273	1/2" Female Comp x 3/8" OD Tube, Rib Washer Included 1 Per Card. 3.875"L x 1.875"W x 1.1"D	Chrome	5	50
66-6-8WX CD 026613158129	1/2" FIP x 3/8" OD Tube, Rib Washer Included 1 Per Card. 3.875"L x 1.875"W x 1.1"D	Chrome	5	50



Compression Male Elbow

69-6-6X CD 026613158136	3/8" OD Tube x 3/8" MIP 2 Per Card. 3.875"L x 2.875"W x 1.22"D	Chrome	5	25
----------------------------	---	--------	---	----



Compression Reducing Union

C14X CD 026613158303	5/8" OD Tube x 3/8" OD Tube, Drill Through (No Tube Stop) 2 Per Card. 3.875"L x 2.875"W x 1.22"D	Chrome	5	25
-------------------------	---	--------	---	----



Valve Adaptors

CT2-664X P 026613140933	3/8" OD Tube x 3/8" OD Tube x 1/4" Female Comp Nut 1 Per Bag 6"L x 3.5"W x 0.625"D	Rough	-	10
CT2-664X D 026613140308	3/8" OD Tube x 3/8" OD Tube x 1/4" Female Comp Nut 1 Per Card.	Rough	5	25
CT2-666X P 026613140926	3/8" OD Tube x 3/8" OD Tube x 3/8" Female Comp Nut 1 Per Bag 6"L x 3.5"W x 0.625"D	Rough	-	10
CT2-666X D 026613140292	3/8" OD Tube x 3/8" OD Tube x 3/8" Female Comp Nut 1 Per Card.	Rough	5	25

Part No. UPC	Description Package Size	Finish	Shelf Qty	Case Qty
-----------------	-----------------------------	--------	--------------	-------------

Valve Adaptors (cont.)

ST1-SS4X D 026613140322	1/2" FIP & 7/16" OD Slip Joint x 1/2" MIP x 1/4" OD Tube 1 Per Card.	Rough	5	50
ST1-SS6X D 026613140315	1/2" FIP & 7/16" OD Slip Joint x 1/2" MIP x 3/8" OD Tube 1 Per Card.	Rough	5	50



Part No. UPC	Description Package Size	Finish	Shelf Qty	Case Qty
-----------------	-----------------------------	--------	--------------	-------------

△CPVC Compression Reducing Adaptors



P14CX CD 026613158280	1/2" Nom CPVC x 3/8" OD Tube 1 Per Card. 3.875"L x 1.875"W x 1.1"D	Chrome	5	25
--------------------------	---	--------	---	----

P44CX RD 026613158143	1/2" Nom CPVC x 5/8" OD Tube 1 Per Card. 5.875"L x 3.875"W x 2.375"D	Rough	5	25
--------------------------	---	-------	---	----

P77CX RD 026613158150	1/2" Nom CPVC x 7/8" OD Tube 1 Per Card. 5.875"L x 3.875"W x 2.375"D	Rough	-	5
--------------------------	---	-------	---	---

△CPVC Compression Reducing Elbows



P19CX CD 026613158228	1/2" Nom CPVC x 3/8" OD Tube 1 Per Card. 3.875"L x 2.875"W x 1.22"D	Chrome	5	25
--------------------------	--	--------	---	----

△CPVC Female 90° Drop-Ear Elbows



P48WX RD 026613158235	1/2" Nom CPVC x 1/2" FIP 1 Per Card. 5.875"L x 3.875"W x 2.375"D	Rough	5	25
--------------------------	---	-------	---	----

△ CPVC pre-torqued fittings eliminate the need for tightening on the job.

Brass Garden Hose Fittings

Product Applications

- For use with residential and commercial-grade garden hose.

Product Advantages

- Connectors, unions, nuts, elbows and tees machined from brass rod.
- Backed by Brasscraft Manufacturing's 70 plus year history and reputation for quality and service.

*Compliant offering available

Assembly Instructions

- All female hose connections require a rubber washer inserted prior to installation.



Part No. UPC	Description Package Size	Finish	Shelf Qty	Case Qty
Garden Hose Dishwasher Elbows				
HES-6-12X 026613160184	3/4" Female Hose Thread x 3/8" OD Comp, Hose Washer Included 1 Per Bag 5.81"L x 3"W x 1.625"D	Rough	-	50
HES-6-12X D 026613160207	3/4" Female Hose Thread x 3/8" OD Comp, Hose Washer Included 1 Per Card. 5.625"L x 3"W x 1.625"D	Rough	-	10
HES-6-12X B 026613160191	3/4" Female Hose Thread x 3/8" OD Comp, Hose Washer Included Bulk Packed. 1.875"L x 1.125"W x 1.625"D	Rough	-	200
HES-6-12WNMX D 026613160443	3/8" OD Comp x 3/4" Garden Hose, Comp Nut & Sleeve, Hose Washer Included 1 Per Card.	Rough	-	10
HES-8-12X 026613160221	3/4" Female Hose Thread x 1/2" OD Comp, Hose Washer Included Bulk Bag. 8.66"L x 6.69"W x 0.00"D	Rough	25	200
Vacuum Breaker				
PS612X 039166121038	1"-20 Fine Thread IP To Garden Hose Backflow Preventer 1 Per Card. 3.875"L x 3.875"W x 1.552"D	Rough	5	25



Part No. UPC	Description Package Size	Finish	Shelf Qty	Case Qty
-----------------	-----------------------------	--------	--------------	-------------

Multi-Turn Supply Stop Components



S15-10 CD 026613172477	Loose Key 1 Per Card.	Chrome	-	10
---------------------------	--------------------------	--------	---	----



X15-10 CD 026613160337	Cross Handle 1 Per Card.	Chrome	5	25
---------------------------	-----------------------------	--------	---	----

Multi-Turn Repair Kit



BCSR01 026613141527	Stem/Bib Washer R15S-2P+5 and Two Washers R15-78F & R15-6P included		-	5
------------------------	---	--	---	---

Water Supply Connector Washer Assortment



BCRP01 D 026613160085	Cone Washer Assortment 1 Set Per Card. 3.875"L x 2.875"W x 1.22"D		10	100
--------------------------	--	--	----	-----

Shallow Escutcheons



PS30 039166000302	3/8" IP Shallow (.680 ID) 2 Per Card. 3.875"L x 3.875"W x 0.804"D	Chrome	5	25
----------------------	--	--------	---	----

PS31 039166000319	1/2" IP Shallow (.840 ID) 2 Per Card 3.875"L x 3.875"W x 0.804"D	Chrome	5	25
----------------------	---	--------	---	----



PS32 039166000326	3/4" IP Shallow (1.050 ID) 2 Per Card 3.875"L x 3.875"W x 0.804"D	Chrome	5	25
----------------------	--	--------	---	----

Bell Escutcheons



PS33 039166000333	3/8" IP (11/16" OD) Bell (.687 ID) 2 Per Card 3.875"L x 3.875"W x 1.508"D	Chrome	5	25
----------------------	--	--------	---	----

PS34 039166000340	1/2" IP Bell (.844 ID) 1 Per Card 3.875"L x 3.875"W x 1.508"D	Chrome	5	25
----------------------	--	--------	---	----

PS40 039166000401	1/2" Nom (5/8" OD) Bell (.630 ID) 1 Per Card. 3.875"L x 3.875"W x 1.508"D	Chrome	5	25
----------------------	--	--------	---	----

Chrome Plated Brass Cover Tubes



8489 CD 026613160320	3-1/2" Length for 1/2" Nom Copper Tube Use 650 C Bell Escutcheon 1 Per Card.		5	25
-------------------------	---	--	---	----

Multi-Turn Supply Valve Components



R15-9 CD 026613160344	Screw for Stop Handles 1 Per Card.		5	25
--------------------------	---------------------------------------	--	---	----

Part No. UPC	Description Package Size	Finish	Shelf Qty	Case Qty
-----------------	-----------------------------	--------	--------------	-------------

Multi-Turn Supply Valve Components (cont.)

R15-10T CD 026613144696	Oval Handle 1 Per Card. 3.875"L x 1.875"W x 1.1"D	Chrome	-	5
----------------------------	--	--------	---	---



R15-5 026613041643	Bib Washer Bulk Bag. 5.00"L x 5.00"W x 0.50"D	Rubber	25	1,000
-----------------------	--	--------	----	-------



Faucet Supply Components

P89 039166021826	1/2" Brass Faucet Nuts With 3/8" and 1/2" Friction Rings & Cone Washers 2 Sets Per Card. 3.875"L x 1.875"W x 1.1"D	Rough	10	100
---------------------	---	-------	----	-----



Water Heater Connector Washers

BCRP02 D 026613160092	Fits Most Water Heater Connectors. Nitrile Rubber 2 Per Card. 3.875"L x 1.875"W x 1.1"D	Rubber	5	25
--------------------------	--	--------	---	----



WWCD 026613051970	Washer .940" OD x .675" ID x .218" Thick. For Copper Connectors with an External Dielectric Sleeve Bulk Bag. 8.00"L x 6.00"W x 0.22"D	Rubber	25	1,000
----------------------	--	--------	----	-------



Water Heater Nipples

PS43 039166000432	3/4" MIP x 3/4" MIP x 3" Length. Plastic Lined 2 Per Card. 5.625"L x 3"W x 1.625"D	Steel	-	5
----------------------	---	-------	---	---



Speedi Plumb® PLUS Polymer Braided Water Heater Connectors

Superior Flexibility, Superior Corrosion Resistance

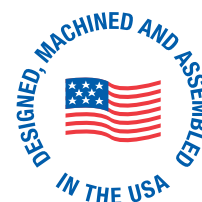

No Kinking, No Crimping

The patented polymer braided jacket is specially engineered to allow the connector to bend freely without kinking or crimping. Easy to install, the connector won't work harden with repeated bending.

Advanced Corrosion Resistance

The polymer braid is specially engineered to resist corrosion from most harsh household cleaning and repair products.

No Dielectric Union Needed*

The engineered polymer braid and rubber core are non-conductive materials and therefore eliminate the need for a dielectric union.

Less Torque to Seal

Rubber washer is easier to install on rough nipple surfaces.

Longer Connector Nuts

A greater number of thread-to-thread contact provides a better seal to lined nipples.



No Lead

Part No. UPC	Description Package Size	Length	Shelf Qty	Case Qty
.57" ID Tube - FIP X FIP				
BWB0-12 026613965321	3/4" FIP x 3/4" FIP Bulk w/Flag Label. 14"L x 4.75"W x 3"D	12"	-	10
BWB0-15 026613965406	3/4" FIP x 3/4" FIP Bulk w/Flag Label. 20"L x 4.75"W x 2.875"D	15"	-	10
BWB0-18 026613965413	3/4" FIP x 3/4" FIP Bulk w/Flag Label. 20"L x 4.75"W x 2.875"D	18"	-	10
BWB0-24 026613965420	3/4" FIP x 3/4" FIP Bulk w/Flag Label. 26"L x 4.75"W x 2.875"D	24"	-	10
.57" ID Tube - FIP X PEX				
BWB0-18PX 026613107141	3/4" FIP x 3/4" Nom PEX Barb Bulk w/Flag Label. 20"L x 4.75"W x 2.875"D	18"	-	10
.57" ID Tube - FIP X Compression				
BWB05-18 026613120836	3/4" FIP x 5/8" OD Comp Bulk w/Flag Label. 21"L x 5"W x 4.5"D	18"	-	10
BWB08-12 026613965369	3/4" FIP x 7/8" OD Comp Bulk w/Flag Label. 14"L x 4.75"W x 3"D	12"	-	10
BWB08-18 026613965383	3/4" FIP x 7/8" OD Comp Bulk w/Flag Label. 20"L x 4.75"W x 2.875"D	18"	-	10
BWB08-24 026613965390	3/4" FIP x 7/8" OD Comp Bulk w/Flag Label. 26"L x 4.75"W x 2.875"D	24"	-	10

*Check your local inspection office for applicable code requirements.

Part No. UPC	Description Package Size	Length	Shelf Qty	Case Qty
.57" ID Tube - MIP X FIP				
BWB20-12 026613965437	3/4" MIP x 3/4" FIP Bulk w/Flag Label. 14"L x 4.75"W x 3"D	12"	-	10
BWB20-15 026613965444	3/4" MIP x 3/4" FIP Bulk w/Flag Label. 20"L x 4.75"W x 2.875"D	15"	-	10
BWB20-18 026613965451	3/4" MIP x 3/4" FIP Bulk w/Flag Label. 21"L x 5"W x 4.5"D	18"	-	10
BWB20-24 026613965468	3/4" MIP x 3/4" FIP Bulk w/Flag Label. 26"L x 4.75"W x 2.875"D	24"	-	10



.57" ID Tube - MIP x Compression				
BWB25-18 026613100333	3/4" MIP X 5/8" OD Comp Bulk w/Flag Label. 20"L x 4.75"W x 2.875"D	18"	-	10
BWB28-18 026613965345	3/4" MIP x 7/8" OD Comp Bulk w/Flag Label. 20"L x 4.75"W x 2.875"D	18"	-	10
BWB28-24 026613965352	3/4" MIP x 7/8" OD Comp Bulk w/Flag Label. 26"L x 4.75"W x 2.875"D	24"	-	10



Copper-Flex™ Water Heater Connectors

Patented Resistance Against Galvanic Corrosion

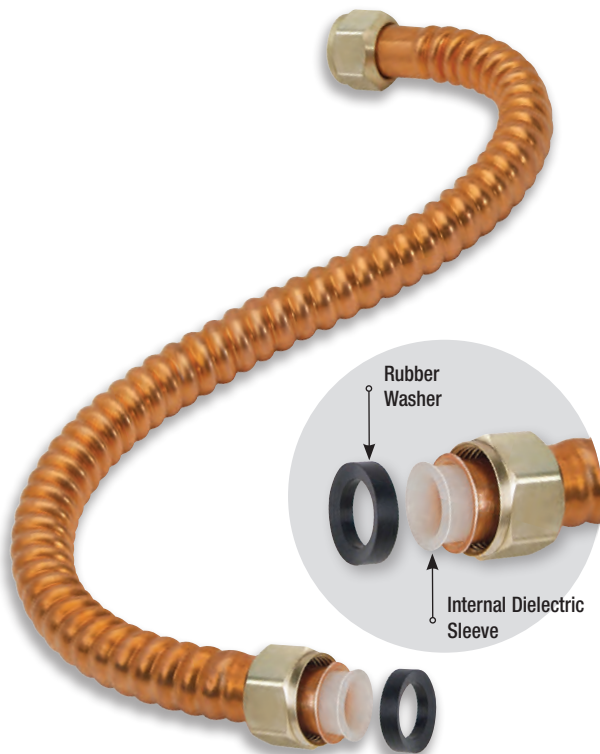

Patented Internal Dielectric Sleeve

Effectively separates dissimilar metals within the waterway to help prevent galvanic corrosion.

No Dielectric Union Needed*

Dielectric sleeve eliminates the need for a dielectric union (plastic lined nipple).

Less Torque to Seal

Rubber washer is more resilient than PEX and easier to install on rough nipple surfaces.

Longer Connector Nuts

A greater number of thread-to-thread contact provides a better seal to lined nipples.

Available for PEX connections



No Lead

Part No. UPC	Description Package Size	Length	Shelf Qty	Case Qty
7/8" OD Tube - FIP X FIP				
PSC00-12 039166080007	3/4" FIP x 3/4" FIP 1 Per Bag w/Cut-Case Display Box. 18.25"L x 5.8125"W x 7.6875"D	12"	-	25
WB00-12N 026613089287	3/4" FIP x 3/4" FIP Bulk w/Wrap Around Label. 13.5"L x 6"W x 5.38"D	12"	-	25
PSC00-15 039166080014	3/4" FIP x 3/4" FIP 1 Per Bag w/Cut-Case Display Box. 18.25"L x 5.8125"W x 7.6875"D	15"	-	25
WB00-15N 026613089300	3/4" FIP x 3/4" FIP Bulk w/Wrap Around Label. 16.5"L x 6"W x 5.375"D	15"	-	25
PSC00-18 039166080021	3/4" FIP x 3/4" FIP 1 Per Bag w/Cut-Case Display Box. 24.125"L x 5.8125"W x 7.6875"D	18"	-	20
WB00-18N 026613089331	3/4" FIP x 3/4" FIP Bulk w/Wrap Around Label. 18.75"L x 6"W x 6.25"D	18"	-	25
PSC00-24 039166080038	3/4" FIP x 3/4" FIP 1 Per Bag w/Cut-Case Display Box. 24.125"L x 5.8125"W x 7.6875"D	24"	-	15
WB00-24N 026613089348	3/4" FIP x 3/4" FIP Bulk w/Wrap Around Label. 25.5"L x 6"W x 5.375"D	24"	-	25
7/8" OD Tube - FIP x Male/Female Sweat				
PSC034-18 039166080045	3/4" FIP x 3/4" Nom Male/Female Sweat (7/8" ID) 1 Per Bag w/Cut-Case Display Box 18.25"L x 5.8125"W x 7.6875"D	18"	-	20
WB034-18N 026613089423	3/4" FIP x 3/4" Nom Male/Female Sweat (7/8" ID) Bulk w/Wrap Around Label 18.75"L x 6"W x 6.25"D	18"	-	25

▲ WARNING: For use with water in accessible locations only. DO NOT use with gas – gas will cause corrosion and leakage.

*Check your local inspection office for applicable code requirements.

Part No. UPC	Description Package Size	Length	Shelf Qty	Case Qty
7/8" OD Tube - FIP x Male/Female Sweat (cont.)				
PSC034-24 039166080052	3/4" FIP x 3/4" Nom Male/Female Sweat (7/8" ID) 1 Per Bag w/Cut-Case Display Box 24.125"L x 5.8125"W x 7.6875"D	24"	-	15
WB034-24N 026613093710	3/4" FIP x 3/4" Nom Male/Female Sweat (7/8" ID) Bulk w/Wrap Around Label. 25.5"L x 6"W x 5.375"D	24"	-	25
WB034-12N 026613089409	3/4" FIP x 3/4" Nom Male/Female Sweat (7/8" ID) Bulk w/Wrap Around Label. 13.5"L x 6"W x 5.38"D	12"	-	25
WB034-15N 026613089416	3/4" FIP x 3/4" Nom Male/Female Sweat (7/8" ID) Bulk w/Wrap Around Label. 16.5"L x 6"W x 5.375"D	15"	-	25



7/8" OD Tube - FIP x PEX Barb				
WB07-18 026613048871	3/4" FIP x 3/4" PEX Barb (brass, pre-torqued) Bulk w/Wrap Around Label. 21.5"L x 6"W x 6.25"D	18"	-	25



7/8" OD Tube - FIP/MIP x PEX Barb				
WB27-18 026613107950	3/4" FIP/MIP x 3/4" PEX Barb (brass, pre-torqued) Bulk w/Wrap Around Label. 22"L x 6"W x 6.5"D	18"	-	25



ProCoat® Coated Stainless Steel Water Heater Connectors

Greater Flexibility, Superior Corrosion Resistance

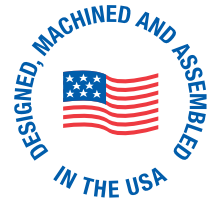
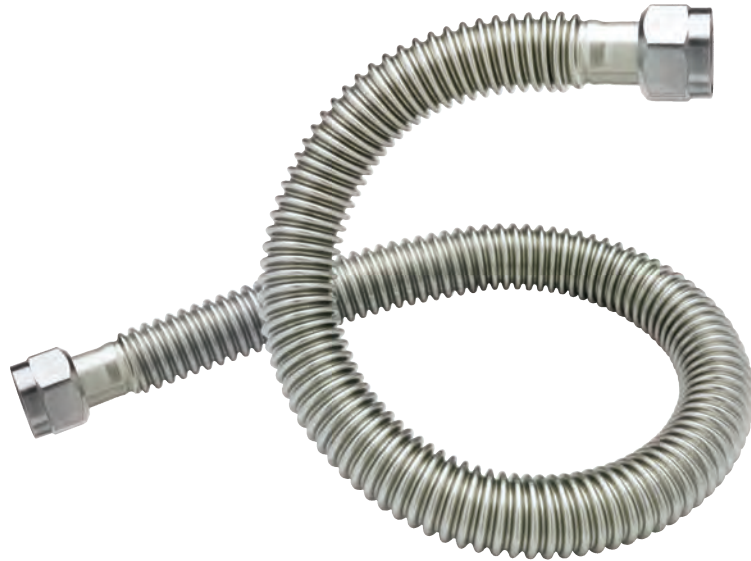

Exclusive ProCoat® Clear Coat

Provides superior corrosion resistance to deterioration from most harsh chemicals that can cause pinhole leaks.

Full Flow, Maximum Performance

With 3/4" full flow internal diameter, our connectors provide greater water flow without obstruction.

Integrated Dielectric Sleeve

Isolates dissimilar metals within the waterway, where galvanic and electrolytic corrosion have their greatest potential.

No Dielectric Union Needed*

Integrated dielectric sleeve eliminates the need to install an additional dielectric union, reducing time and installation costs.

100% Leak Tested

Each connector is leak tested to help ensure connector performance and reliability.



No Lead

Part No. UPC	Description Package Size	Length	Shelf Qty	Case Qty
3/4" ID Tube - FIP x FIP				
SWB00-12N 026613142562	(3/4" ID) 3/4" FIP x 3/4" FIP Bulk w/Wrap Around Label. 13.5"L x 6"W x 5.38"D	12"	-	25
SWB00-15N 026613142579	(3/4" ID) 3/4" FIP x 3/4" FIP Bulk w/Wrap Around Label. 16.5"L x 6"W x 5.375"D	15"	-	25
SWB00-18N 026613142586	(3/4" ID) 3/4" FIP x 3/4" FIP Bulk w/Wrap Around Label. 18.75"L x 6"W x 6.25"D	18"	-	25
SWB00-24N 026613142593	(3/4" ID) 3/4" FIP x 3/4" FIP Bulk w/Wrap Around Label. 25.5"L x 6"W x 5.375"D	24"	-	25



⚠ WARNING: For use with water in accessible locations only. DO NOT use with gas – gas will cause corrosion and leakage.

*Check your local inspection office for applicable code requirements.

Dimensional Data

Connector Series	Size				
	CSST	CSSL	CSSD	CSSC	CSSB
"A" Diameter Nom OD Tube	3/8"	3/8"	1/2"	5/8"	7/8"
"B" Diameter Nom ID Tube	1/4"	1/4"	3/8"	1/2"	3/4"
Flare Nut Thread	3/8" OD Tube 9/16-24 Thread	3/8" OD Tube 5/8-18 Thread	1/2" OD Tube 3/4-16 Thread	5/8" OD Tube 15/16-16 Thread	7/8" OD Tube 1-1/16-16 Thread

Connector Flow Capacity – Per ANSI Z21.24 • CSA 6.10*

Connectors should be sized based upon the appliance gas consumption rate. Select a connector with a capacity equal to or greater than appliance input rate.

Connector Series	Nominal Connector (Inch)		STRAIGHT LENGTH CAPACITY - NATURAL GAS BTU PER HOUR							
	ID	OD	12"	18"	24"	30"	36"	48"	60"	72"
CSSL/CSST/BCSSL	1/4	3/8	48,000	43,800	40,000	36,400	33,400	28,300	24,900	23,100
CSSD/BCSSD	3/8	1/2	102,000	93,100	85,000	77,100	71,100	60,500	53,200	49,100
CSSC	1/2	5/8	180,000	164,200	150,000	136,000	125,000	106,000	93,200	86,000
CSSB	3/4	7/8	290,900	290,900	290,900	270,500	255,900	215,000	197,400	173,900

Connector Series	Nominal Connector (Inch)		STRAIGHT LENGTH CAPACITY - LPG (PROPANE) BTU PER HOUR							
	ID	OD	12"	18"	24"	30"	36"	48"	60"	72"
CSSL/CSST/BCSSL	1/4	3/8	76,800	70,080	64,000	58,240	53,440	45,280	39,840	36,960
CSSD/BCSSD	3/8	1/2	163,200	148,960	136,000	123,360	113,760	96,800	85,120	78,560
CSSC	1/2	5/8	288,000	262,720	240,000	217,600	200,000	169,600	149,120	137,600
CSSB	3/4	7/8	465,440	465,440	465,440	432,800	409,440	344,000	315,840	278,240

Connector Series	Nominal Connector (Inch)		STRAIGHT LENGTH CAPACITY - WATTS							
	ID	OD	0.31m	0.46m	0.61m	0.76m	0.92m	1.22m	1.53m	1.83m
CSSL/CSST/BCSSL	1/4	3/8	14,067	12,837	11,723	10,668	9,789	8,294	7,297	6,770
CSSD/BCSSD	3/8	1/2	29,893	27,285	24,911	22,596	20,837	17,731	15,591	14,390
CSSC	1/2	5/8	52,752	48,122	43,961	39,858	36,634	31,066	27,314	25,380
CSSB	3/4	7/8	85,254	85,254	85,254	79,276	74,997	63,010	57,852	50,965

0.64 Sp Gr, 1000 Btu per cu. ft. (37.2 MJ/m³) gas at 0.5 inch water column (124Pa) pressure drop. Per ANSI Z21.24 • CSA 6.10 for use with pressures not to exceed 1/2 PSI.

*The flow capacities in the above charts are the minimum performance criterion established in ANSI Z21.24 • CSA 6.10 & ANSI Z21.75 • CSA 6.27.

Steel Fitting Torque Values – Per ANSI Z21.24 • CSA 6.10

Tube	Torque (inch pounds)**	
	Minimum	Maximum
CSSL	150	250
CSSD	200	390
CSSC	250	520
CSSB	400	780

**Torque range recommended to tighten gas connector

Part No. UPC	Description Package Size	Length	Shelf Qty	Case Qty
1/2" ID (5/8" OD) - MIP x FIP				
CSSC12R-24 P 026613167114	3/4" MIP (1/2" FIP Tap) x 3/4" FIP 1 Per Bag. 14.375"L x 9.25"W x 1.25"D	24"	-	5
CSSC12R-36 P 026613167121	3/4" MIP (1/2" FIP Tap) x 3/4" FIP 1 Per Bag. 12"L x 9.25"W x 1.25"D	36"	-	5
CSSC12R-48 P 026613167138	3/4" MIP (1/2" FIP Tap) x 3/4" FIP 1 Per Bag. 12"L x 10.25"W x 1.25"D	48"	-	5
CSSC12R-60 P 026613167145	3/4" MIP (1/2" FIP Tap) x 3/4" FIP 1 Per Bag. 15.125"L x 10.25"W x 1.25"D	60"	-	5
CSSC12R-72 P 026613167152	3/4" MIP (1/2" FIP Tap) x 3/4" FIP 1 Per Bag. 15.125"L x 10.25"W x 1.25"D	72"	-	5
CSSC45R-24 P 026613167336	1/2" MIP EFV x 1/2" FIP 1 Per Bag. 14.375"L x 9.25"W x 1.25"D	24"	-	5
CSSC45R-36 P 026613167343	1/2" MIP EFV x 1/2" FIP 1 Per Bag. 14.375"L x 9.25"W x 1.25"D	36"	-	5
CSSC45R-48 P 026613167367	1/2" MIP EFV x 1/2" FIP 1 Per Bag. 15.125"L x 10.25"W x 1.25"D	48"	-	5
CSSC45R-60 P 026613167381	1/2" MIP EFV x 1/2" FIP 1 Per Bag. 15.125"L x 10.25"W x 1.25"D	60"	-	5
1/2" ID (5/8" OD) - FIP x MIP				
CSSC21R-48 P 026613167978	3/4" FIP EFV x 3/4" MIP (1/2" FIP) 1 Per Bag. 14.25"L x 10.25"W x 1.25"D	48"	-	5
1/2" ID (5/8" OD) - FIP x FIP				
CSSC22R-24 P 026613167183	3/4" FIP EFV x 3/4" FIP 1 Per Bag. 13.5"L x 9.25"W x 1.2"D	24"	-	5
CSSC22R-36 P 026613167190	3/4" FIP EFV x 3/4" FIP 1 Per Bag. 13.5"L x 9.25"W x 1.2"D	36"	-	5
CSSC22R-48 P 026613167213	3/4" FIP EFV x 3/4" FIP 1 Per Bag. 12"L x 10.25"W x 1.2"D	48"	-	5
CSSC22R-60 P 026613167220	3/4" FIP EFV x 3/4" FIP 1 Per Bag. 12"L x 10.25"W x 1.2"D	60"	-	5
1/2" ID (5/8" OD) - MIP x MIP				
CSSC44R-18 P 026613169507	1/2" MIP EFV x 1/2" MIP (3/8" FIP Tap) 1 Per Bag. 13.5"L x 9.25"W x 1.125"D	18"	-	5
CSSC44R-24 P 026613167237	1/2" MIP EFV x 1/2" MIP (3/8" FIP Tap) 1 Per Bag. 13.5"L x 9.25"W x 1.125"D	24"	-	5
CSSC44R-36 P 026613167251	1/2" MIP EFV x 1/2" MIP (3/8" FIP Tap) 1 Per Bag. 12"L x 9.25"W x 1.125"D	36"	-	5
CSSC44R-48 P 026613167275	1/2" MIP EFV x 1/2" MIP (3/8" FIP Tap) 1 Per Bag. 12"L x 10.25"W x 1.125"D	48"	-	5
CSSC44R-60 P 026613167305	1/2" MIP EFV x 1/2" MIP (3/8" FIP Tap) 1 Per Bag. 12"L x 10.25"W x 1.125"D	60"	-	5



Part No. UPC	Description Package Size	Length	Shelf Qty	Case Qty	
1/2" ID (5/8" OD) - Female Flare x MIP					
CSSC91R-36 P 026613167435	5/8" OD Female Flare EFV x 3/4" MIP (1/2" FIP Tap) 1 Per Bag. 14.375"L x 9.25"W x 1.25"D	36"	-	5	
CSSC91R-48 P 026613167442	5/8" OD Female Flare EFV x 3/4" MIP (1/2" FIP Tap) 1 Per Bag. 15.125"L x 10.25"W x 1.25"D	48"	-	5	

3/8" ID (1/2" OD) - MIP x MIP					
CSSD44R-12 P 026613167534	1/2" MIP EFV x 1/2" MIP (3/8" FIP Tap) 1 Per Bag. 19.125"L x 3.1875"W x 1.25"D	12"	-	5	
CSSD44R-18 P 026613167558	1/2" MIP EFV x 1/2" MIP (3/8" FIP Tap) 1 Per Bag. 12"L x 9.25"W x 1.25"D	18"	-	5	
CSSD44R-24 P 026613167565	1/2" MIP EFV x 1/2" MIP (3/8" FIP Tap) 1 Per Bag. 12"L x 9.25"W x 1.25"D	24"	-	5	
CSSD44R-36 P 026613167602	1/2" MIP EFV x 1/2" MIP (3/8" FIP Tap) 1 Per Bag. 12"L x 9.25"W x 1.25"D	36"	-	5	
CSSD44R-48 P 026613167633	1/2" MIP EFV x 1/2" MIP (3/8" FIP Tap) 1 Per Bag. 12"L x 9.25"W x 1.25"D	48"	-	5	
CSSD44R-60 P 026613167640	1/2" MIP EFV x 1/2" MIP (3/8" FIP Tap) 1 Per Bag. 12"L x 10.25"W x 1.25"D	60"	-	5	
CSSD44R-72 P 026613167657	1/2" MIP EFV x 1/2" MIP (3/8" FIP Tap) 1 Per Bag. 12.875"L x 10.25"W x 1.25"D	72"	-	5	

3/8" ID (1/2" OD) - MIP x FIP					
CSSD45R-12 P 026613167664	1/2" MIP EFV x 1/2" FIP 1 Per Bag. 19.125"L x 3.1875"W x 1.25"D	12"	-	5	
CSSD45R-18 P 026613167671	1/2" MIP EFV x 1/2" FIP 1 Per Bag. 12.875"L x 9.25"W x 1.25"D	18"	-	5	
CSSD45R-24 P 026613167688	1/2" MIP EFV x 1/2" FIP 1 Per Bag. 12.875"L x 9.25"W x 1.25"D	24"	-	5	
CSSD45R-36 P 026613167695	1/2" MIP EFV x 1/2" FIP 1 Per Bag. 12.875"L x 9.25"W x 1.25"D	36"	-	5	
CSSD45R-48 P 026613167701	1/2" MIP EFV x 1/2" FIP 1 Per Bag. 12.875"L x 9.25"W x 1.25"D	48"	-	5	
CSSD45R-60 P 026613167718	1/2" MIP EFV x 1/2" FIP 1 Per Bag. 12"L x 10.25"W x 1.25"D	60"	-	5	
CSSD45R-72 P 026613167725	1/2" MIP EFV x 1/2" FIP 1 Per Bag. 15.125"L x 10.25"W x 1.25"D	72"	-	5	

3/8" ID (1/2" OD) - Female Flare x FIP					
CSSD105R-36 P 026613167497	3/4" MIP (1/2" Female Flare) EFV x 1/2" FIP 1 Per Bag. 12.875"L x 9.25"W x 1.25"D	36"	-	5	
CSSD105R-48 P 026613167503	3/4" MIP (1/2" Female Flare) EFV x 1/2" FIP 1 Per Bag. 12.875"L x 9.25"W x 1.25"D	48"	-	5	

1/4" ID (3/8" OD) - Female Flare x FIP					
CSSL115R-24 P 026613167770	1/2" MIP (3/8" Female Flare) EFV X 1/2" FIP 1 Per Bag. 12.875"L x 9.25"W x 1.25"D	24"	-	5	
CSSL115R-36 P 026613167787	1/2" MIP (3/8" Female Flare) EFV X 1/2" FIP 1 Per Bag. 12.875"L x 9.25"W x 1.25"D	36"	-	5	

COATED GAS CONNECTORS WITH EXCESS FLOW VALVE



Part No. UPC	Description Package Size	Length	Shelf Qty	Case Qty
1/4" ID (3/8" OD) - MIP x MIP				
CSSL44R-24 P 026613167817	1/2" MIP (3/8" FIP) EFV x 1/2" MIP (3/8" FIP) 1 Per Bag. 12"L x 9.25"W x 1.25"D	24"	-	5
CSSL44R-36 P 026613167824	1/2" MIP (3/8" FIP) EFV x 1/2" MIP (3/8" FIP) 1 Per Bag. 12"L x 9.25"W x 1.25"D	36"	-	5
CSSL44R-48 P 026613167831	1/2" MIP (3/8" FIP) EFV x 1/2" MIP (3/8" FIP) 1 Per Bag. 12"L x 9.25"W x 1.25"D	48"	-	5
CSSL44R-60 P 026613167848	1/2" MIP (3/8" FIP) EFV x 1/2" MIP (3/8" FIP) 1 Per Bag. 12.875"L x 9.25"W x 1.25"D	60"	-	5
CSSL47R-24 P 026613167916	1/2" MIP (3/8" FIP) EFV x 3/8" MIP (1/8" FIP) 1 Per Bag. 12"L x 9.25"W x 1.25"D	24"	-	5
CSSL47R-36 P 026613167923	1/2" MIP (3/8" FIP) EFV x 3/8" MIP (1/8" FIP) 1 Per Bag. 12"L x 9.25"W x 1.25"D	36"	-	5
CSSL47R-48 P 026613167930	1/2" MIP (3/8" FIP) EFV x 3/8" MIP (1/8" FIP) 1 Per Bag. 12.875"L x 9.25"W x 1.25"D	48"	-	5
CSSL47R-60 P 026613167947	1/2" MIP (3/8" FIP) EFV x 3/8" MIP (1/8" FIP) 1 Per Bag. 12"L x 9.25"W x 1.35"D	60"	-	5

1/4" ID (3/8" OD) - MIP x FIP



CSSL45R-12 P 026613167855	1/2" MIP EFV x 1/2" FIP 1 Per Bag. 19.125"L x 3.1875"W x 1.25"D	12"	-	5
CSSL45R-18 P 026613167862	1/2" MIP EFV x 1/2" FIP 1 Per Bag. 12.875"L x 9.25"W x 1.25"D	18"	-	5
CSSL45R-24 P 026613167879	1/2" MIP EFV x 1/2" FIP 1 Per Bag. 12"L x 9.25"W x 1.35"D	24"	-	5
CSSL45R-36 P 026613167091	1/2" MIP EFV x 1/2" FIP 1 Per Bag. 12"L x 9.25"W x 1.35"D	36"	-	5
CSSL45R-48 P 026613167886	1/2" MIP EFV x 1/2" FIP 1 Per Bag. 12.875"L x 9.25"W x 1.25"D	48"	-	5
CSSL45R-60 P 026613167893	1/2" MIP EFV x 1/2" FIP 1 Per Bag. 12.875"L x 9.25"W x 1.25"D	60"	-	5
CSSL45R-72 P 026613167909	1/2" MIP EFV x 1/2" FIP 1 Per Bag. 12.875"L x 9.25"W x 1.25"D	72"	-	5

ProCoat® Coated Stainless Steel Gas Connectors

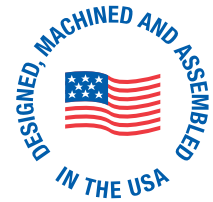

The ProCoat® coating helps protect the stainless steel connector from corrosion due to prolonged exposure to harsh chemicals found in common household cleaning, plumbing repair and building products (ammonia, chlorine, solder flux and muriatic acid). Designed for indoor and outdoor use, the ProCoat® coating

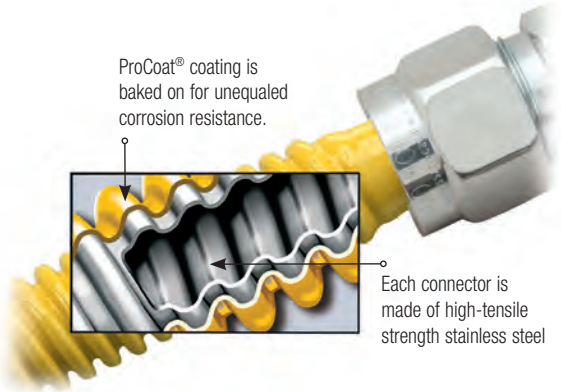

- Superior Corrosion Resistance
- Greater Strength & Flexibility
- Approved for Indoor & Outdoor Use
- 100% Leak Tested
- CSA Certified

Available in Black



Part No. UPC	Description Package Size	Length	Shelf Qty	Case Qty
-----------------	-----------------------------	--------	-----------	----------

3/4" ID (7/8" OD) - FIP x MIP

CSSB21-24 P 026613131511	3/4" FIP x 3/4" MIP (1/2" FIP Tap) 1 Per Bag. 14.25"L x 10.25"W x 1.5"D	24"	-	5
-----------------------------	--	-----	---	---



3/4" ID (7/8" OD) - FIP x FIP

S126624 669771037884	3/4" FIP x 3/4" FIP Bulk w/Flag Label. Includes Mobile Home Instructions 24"L x 1.06"W x 1.06"D	24"	-	10
S126636 669771037891	3/4" FIP x 3/4" FIP Bulk w/Flag Label. Includes Mobile Home Instructions 36"L x 1.25"W x 1.25"D	36"	-	10
S126648 669771037907	3/4" FIP x 3/4" FIP Bulk w/Flag Label. Includes Mobile Home Instructions 48"L x 1.25"W x 1.25"D	48"	-	5



1/2" ID (5/8" OD) - FIP x FIP

CSSC22-24 P 026613114194	3/4" FIP x 3/4" FIP 1 Per Bag. 13.5"L x 9.25"W x 1.2"D	24"	-	5
CSSC22-36 P 026613114422	3/4" FIP x 3/4" FIP 1 Per Bag. 12"L x 9.25"W x 1.2"D	36"	-	5
CSSC22-48 P 026613114200	3/4" FIP x 3/4" FIP 1 Per Bag. 12"L x 10.25"W x 1.2"D	48"	-	5
CSSC22-60 P 026613114217	3/4" FIP x 3/4" FIP 1 Per Bag. 12"L x 10.25"W x 1.2"D	60"	-	5
CSSC22-72 P 026613121024	3/4" FIP x 3/4" FIP 1 Per Bag. 14.25"L x 10.25"W x 1.2"D	72"	-	5



COATED GAS CONNECTORS



Part No. UPC	Description Package Size	Length	Shelf Qty	Case Qty
-----------------	-----------------------------	--------	--------------	-------------

1/2" ID (5/8" OD) - FIP x FIP (cont.)

CSSC25-36 P 026613116099	3/4" FIP x 1/2" FIP 1 Per Bag. 13.5"L x 9.25"W x 1.2"D	36"	-	5
CSSC25-48 P 026613116105	3/4" FIP x 1/2" FIP 1 Per Bag. 14.25"L x 10.25"W x 1.2"D	48"	-	5
CSSC55-24 P 026613121772	1/2" FIP x 1/2" FIP 1 Per Bag. 13.5"L x 9.25"W x 1.12"D	24"	-	5
CSSC55-36 P 026613115832	1/2" FIP x 1/2" FIP 1 Per Bag. 12"L x 9.25"W x 1.125"D	36"	-	5
CSSC23-48 P 026613116075	3/4" FIP x 3/4" FIP Elbow 1 Per Bag. 14.25"L x 10.25"W x 1.38"D	48"	-	5

1/2" ID (5/8" OD) - MIP x MIP



CSSC14-24 P 026613121499	3/4" MIP (1/2" FIP Tap) x 1/2" MIP (3/8" FIP Tap) 1 Per Bag. 13.5"L x 9.25"W x 1.125"D	24"	-	5
CSSC14-36 P 026613121505	3/4" MIP (1/2" FIP Tap) x 1/2" MIP (3/8" FIP Tap) 1 Per Bag. 13.5"L x 9.25"W x 1.125"D	36"	-	5
CSSC14-48 P 026613121475	3/4" MIP (1/2" FIP Tap) x 1/2" MIP (3/8" FIP Tap) 1 Per Bag. 14.25"L x 10.25"W x 1.125"D	48"	-	5
CSSC14-60 P 026613121512	3/4" MIP (1/2" FIP Tap) x 1/2" MIP (3/8" FIP Tap) 1 Per Bag. 14.25"L x 10.25"W x 1.125"D	60"	-	5
CSSC14-72 P 026613121017	3/4" MIP (1/2" FIP Tap) x 1/2" MIP (3/8" FIP Tap) 1 Per Bag. 14.25"L x 10.25"W x 1.125"D	72"	-	5
CSSC44-24 P 026613121765	1/2" MIP (3/8" FIP Tap) x 1/2" MIP (3/8" FIP Tap) 1 Per Bag. 13.5"L x 9.25"W x 1.125"D	24"	-	5
CSSC44-36 P 026613114224	1/2" MIP (3/8" FIP Tap) x 1/2" MIP (3/8" FIP Tap) 1 Per Bag. 12"L x 9.25"W x 1.125"D	36"	-	5
CSSC44-48 P 026613114231	1/2" MIP (3/8" FIP Tap) x 1/2" MIP (3/8" FIP Tap) 1 Per Bag. 12"L x 10.25"W x 1.125"D	48"	-	5
CSSC44-60 P 026613121062	1/2" MIP (3/8" FIP Tap) x 1/2" MIP (3/8" FIP Tap) 1 Per Bag. 14.25"L x 10.25"W x 1.125"D	60"	-	5
CSSC44-72 P 026613127583	1/2" MIP (3/8" FIP Tap) x 1/2" MIP (3/8" FIP Tap) 1 Per Bag. 14.25"L x 10.25"W x 1.125"D	72"	-	5

1/2" ID (5/8" OD) - FIP x MIP



CSSC21-24 P 026613115740	3/4" FIP x 3/4" MIP (1/2" FIP Tap) 1 Per Bag. 13.5"L x 9.25"W x 1.2"D	24"	-	5
CSSC21-36 P 026613114163	3/4" FIP x 3/4" MIP (1/2" FIP Tap) 1 Per Bag. 12"L x 9.25"W x 1.2"D	36"	-	5
CSSC21-48 P 026613114170	3/4" FIP x 3/4" MIP (1/2" FIP Tap) 1 Per Bag. 12"L x 10.25"W x 1.2"D	48"	-	5
CSSC21-60 P 026613114187	3/4" FIP x 3/4" MIP (1/2" FIP Tap) 1 Per Bag. 14.25"L x 10.25"W x 1.25"D	60"	-	5
CSSC21-72 P 026613120911	3/4" FIP x 3/4" MIP (1/2" FIP Tap) 1 Per Bag. 14.25"L x 10.25"W x 1.2"D	72"	-	5
CSSC54-24 P 026613115900	1/2" FIP x 1/2" MIP (3/8" FIP Tap) 1 Per Bag. 13.5"L x 9.25"W x 1.125"D	24"	-	5
CSSC54-36 P 026613114248	1/2" FIP x 1/2" MIP (3/8" FIP Tap) 1 Per Bag. 12"L x 9.25"W x 1.125"D	36"	-	5
CSSC54-48 P 026613114255	1/2" FIP x 1/2" MIP (3/8" FIP Tap) 1 Per Bag. 12"L x 10.25"W x 1.125"D	48"	-	5

Part No. UPC	Description Package Size	Length	Shelf Qty	Case Qty
-----------------	-----------------------------	--------	--------------	-------------

1/2" ID (5/8" OD) - FIP x MIP (cont.)

CSSC54-60 P 026613115566	1/2" FIP x 1/2" MIP (3/8" FIP Tap) 1 Per Bag. 14.25"L x 10.25"W x 1.125"D	60"	-	5
CSSC54-72 P 026613125374	1/2" FIP x 1/2" MIP (3/8" FIP Tap) 1 Per Bag. 14.25"L x 10.25"W x 1.125"D	72"	-	5



1/2" ID (5/8" OD) - Nut x Nut (Not CSA Certified)

CSSCNN-16N 026613118345	5/8" OD Flare Nuts (15/16-16 Thread), Both Ends Bulk w/Flag Label. 16.23"L x 1.125"W x 1.125"D	16"	-	25
CSSCNN-22N 026613113296	5/8" OD Flare Nuts (15/16-16 Thread), Both Ends Bulk w/Flag Label. 22.23"L x 1.125"W x 1.125"D	22"	-	25
CSSCNN-28N 026613118185	5/8" OD Flare Nuts (15/16-16 Thread), Both Ends Bulk w/Flag Label. 28.23"L x 1.125"W x 1.125"D	28"	-	25
CSSCNN-34N 026613113302	5/8" OD Flare Nuts (15/16-16 Thread), Both Ends Bulk w/Flag Label. 34.23"L x 1.125"W x 1.125"D	34"	-	25
CSSCNN-46N 026613113319	5/8" OD Flare Nuts (15/16-16 Thread), Both Ends Bulk w/Flag Label. 46.23"L x 1.125"W x 1.125"D	46"	-	25
CSSCNN-58N 026613117720	5/8" OD Flare Nuts (15/16-16 Thread), Both Ends Bulk w/Flag Label. 58.23"L x 1.125"W x 1.125"D	58"	-	12



3/8" ID (1/2" OD) FIP x MIP

CSSD54-12 P 026613114279	1/2" FIP x 1/2" MIP (3/8" FIP Tap) 1 Per Bag. 18.25"L x 3.1875"W x 1.125"D	12"	-	5
CSSD54-18 P 026613114286	1/2" FIP x 1/2" MIP (3/8" FIP Tap) 1 Per Bag. 13.5"L x 9.25"W x 1.125"D	18"	-	5
CSSD54-24 P 026613114293	1/2" FIP x 1/2" MIP (3/8" FIP Tap) 1 Per Bag. 12"L x 9.25"W x 1.25"D	24"	-	5
CSSD54-36 P 026613114309	1/2" FIP x 1/2" MIP (3/8" FIP Tap) 1 Per Bag. 12"L x 9.25"W x 1.25"D	36"	-	5
CSSD54-48 P 026613114316	1/2" FIP x 1/2" MIP (3/8" FIP Tap) 1 Per Bag. 12"L x 9.25"W x 1.25"D	48"	-	5
CSSD54-60 P 026613114323	1/2" FIP x 1/2" MIP (3/8" FIP Tap) 1 Per Bag. 12"L x 9.25"W x 1.125"D	60"	-	5
CSSD54-72 P 026613121482	1/2" FIP x 1/2" MIP (3/8" FIP Tap) 1 Per Bag. 14.25"L x 10.25"W x 1.125"D	72"	-	5



3/8" ID (1/2" OD) - Nut x Nut (Not CSA Certified)

CSSDNN-10N 026613122038	1/2" OD Flare Nuts, Both Ends Bulk w/Flag Label. 10.1"L x 1.125"W x 1.125"D	10"	-	25
CSSDNN-16N 026613113487	1/2" OD Flare Nuts, Both Ends Bulk w/Flag Label. 16"L x 1.125"W x 1.125"D	16"	-	25
CSSDNN-22N 026613113494	1/2" OD Flare Nuts, Both Ends Bulk w/Flag Label. 22"L x 1.125"W x 1.125"D	22"	-	25
CSSDNN-28N 026613113500	1/2" OD Flare Nuts, Both Ends Bulk w/Flag Label. 28"L x 1.125"W x 1.125"D	28"	-	25
CSSDNN-34N 026613113517	1/2" OD Flare Nuts, Both Ends Bulk w/Flag Label. 34"L x 1.125"W x 1.125"D	34"	-	25
CSSDNN-46N 026613113524	1/2" OD Flare Nuts, Both Ends Bulk w/Flag Label. 46"L x 1.125"W x 1.125"D	46"	-	25
CSSDNN-58N 026613121826	1/2" OD Flare Nuts, Both Ends Bulk w/Flag Label. 58"L x 1.125"W x 1.125"D	58"	-	12





Part No. UPC	Description Package Size	Length	Shelf Qty	Case Qty
-----------------	-----------------------------	--------	--------------	-------------

3/8" ID (1/2" OD) - Nut x Nut (Not CSA Certified) (cont.)

CSSDNN-70N 026613122045	1/2" OD Flare Nuts, Both Ends Bulk w/Flag Label. 70"L x 1.125"W x 1.125"D	70"	-	12
----------------------------	--	-----	---	----

1/4" ID (3/8" OD) - FIP x MIP



CSSL54-12 P 026613115924	1/2" FIP x 1/2" MIP (3/8" FIP Tap) 1 Per Bag. 18.25"L x 3.1875"W x 1"D	12"	-	5
CSSL54-18 P 026613114330	1/2" FIP x 1/2" MIP (3/8" FIP Tap) 1 Per Bag. 12"L x 9.25"W x 1"D	18"	-	5
CSSL54-24 P 026613114347	1/2" FIP x 1/2" MIP (3/8" FIP Tap) 1 Per Bag. 12"L x 9.25"W x 1"D	24"	-	5
CSSL54-30 P 026613118970	1/2" FIP x 1/2" MIP (3/8" FIP Tap) 1 Per Bag. 13.5"L x 9.25"W x 1"D	30"	-	5
CSSL54-36 P 026613114354	1/2" FIP x 1/2" MIP (3/8" FIP Tap) 1 Per Bag. 12"L x 9.25"W x 1"D	36"	-	5
CSSL54-48 P 026613114361	1/2" FIP x 1/2" MIP (3/8" FIP Tap) 1 Per Bag. 12"L x 9.25"W x 1"D	48"	-	5
CSSL54-60 P 026613114378	1/2" FIP x 1/2" MIP (3/8" FIP Tap) 1 Per Bag. 14.25"L x 10.25"W x 1"D	60"	-	5
CSSL54-72 P 026613120546	1/2" FIP x 1/2" MIP (3/8" FIP Tap) 1 Per Bag. 14.25"L x 10.25"W x 1"D	72"	-	5
CSSL87-24 P 026613114392	3/8" FIP x 3/8" MIP (1/8" FIP Tap) 1 Per Bag. 12"L x 9.25"W x 0.93"D	24"	-	5
CSSL87-36 P 026613114408	3/8" FIP x 3/8" MIP (1/8" FIP Tap) 1 Per Bag. 12"L x 9.25"W x 0.85"D	36"	-	5
CSSL87-48 P 026613114415	3/8" FIP x 3/8" MIP (1/8" FIP Tap) 1 Per Bag. 13.5"L x 9.25"W x 0.85"D	48"	-	5
CSSL87-60 P 026613119274	3/8" FIP x 3/8" MIP (1/8" FIP Tap) 1 Per Bag. 14.25"L x 10.25"W x 0.85"D	60"	-	5

1/4" ID (3/8" OD) - Nut x Nut (Not CSA Certified)



CSSLNN-10N 026613121949	3/8" OD Flare Nuts, Both Ends Bulk w/Flag Label. 10"L x 1"W x 1"D	10"	-	25
CSSLNN-16N 026613120249	3/8" OD Flare Nuts, Both Ends Bulk w/Flag Label. 16"L x 1"W x 1"D	16"	-	25
CSSLNN-22N 026613117744	3/8" OD Flare Nuts, Both Ends Bulk w/Flag Label. 22"L x 1"W x 1"D	22"	-	25
CSSLNN-28N 026613121956	3/8" OD Flare Nuts, Both Ends Bulk w/Flag Label. 28"L x 1"W x 1"D	28"	-	25
CSSLNN-34N 026613113838	3/8" OD Flare Nuts, Both Ends Bulk w/Flag Label. 34"L x 1"W x 1"D	34"	-	25
CSSLNN-46N 026613113845	3/8" OD Flare Nuts, Both Ends Bulk w/Flag Label. 46"L x 1"W x 1"D	46"	-	25
CSSLNN-58N 026613113852	3/8" OD Flare Nuts, Both Ends Bulk w/Flag Label. 58"L x 1"W x 1"D	58"	-	12
CSSLNN-70N 026613113869	3/8" OD Flare Nuts, Both Ends Bulk w/Flag Label. 70"L x 1"W x 1"D	70"	-	12

Part No. UPC	Description Package Size	Length	Shelf Qty	Case Qty
-----------------	-----------------------------	--------	--------------	-------------

1/4" ID (3/8" OD) w/ 9/16-24 Fine Thread - Nut x Nut (Not CSA Certified)

CSSTNN-10N P 026613130323	3/8" OD Flare Nuts (9/16-24 Fine Thread), Both Ends 1 Per Bag. 11"L x 8.5"W x 0.85"D	10"	-	5
CSSTNN-10N 026613113876	3/8" OD Flare Nuts (9/16-24 Fine Thread), Both Ends Bulk w/Flag Label. 10.5"L x 1"W x 1"D	10"	-	25
CSSTNN-16N P 026613121536	3/8" OD Flare Nuts (9/16-24 Fine Thread), Both Ends 1 Per Bag. 12.375"L x 9.25"W x 0.85"D	16"	-	5
CSSTNN-16N 026613113883	3/8" OD Flare Nuts (9/16-24 Fine Thread), Both Ends Bulk w/Flag Label. 16.5"L x 0.85"W x 0.85"D	16"	-	25
CSSTNN-22N P 026613121543	3/8" OD Flare Nuts (9/16-24 Fine Thread), Both Ends 1 Per Bag. 12.375"L x 9.25"W x 0.85"D	22"	-	5
CSSTNN-22N 026613112534	3/8" OD Flare Nuts (9/16-24 Fine Thread), Both Ends Bulk w/Flag Label. 22.5"L x 0.85"W x 0.85"D	22"	-	25
CSSTNN-28N P 026613126029	3/8" OD Flare Nuts (9/16-24 Fine Thread), Both Ends 1 Per Bag. 12.375"L x 9.25"W x 0.85"D	28"	-	5
CSSTNN-28N 026613113890	3/8" OD Flare Nuts (9/16-24 Fine Thread), Both Ends Bulk w/Flag Label. 28"L x 0.8"W x 0.8"D	28"	-	25
CSSTNN-34N P 026613121550	3/8" OD Flare Nuts (9/16-24 Fine Thread), Both Ends 1 Per Bag. 12.375"L x 9.25"W x 0.85"D	34"	-	5
CSSTNN-34N 026613113906	3/8" OD Flare Nuts (9/16-24 Fine Thread), Both Ends Bulk w/Flag Label. 34"L x 0.85"W x 0.85"D	34"	-	25
CSSTNN-46N P 026613126036	3/8" OD Flare Nuts (9/16-24 Fine Thread), Both Ends 1 Per Bag. 12.375"L x 9.25"W x 0.85"D	46"	-	5
CSSTNN-46N 026613113913	3/8" OD Flare Nuts (9/16-24 Fine Thread), Both Ends Bulk w/Flag Label. 46"L x 0.85"W x 0.85"D	46"	-	25
CSSTNN-58N P 026613126043	3/8" OD Flare Nuts (9/16-24 Fine Thread), Both Ends 1 Per Bag. 12.375"L x 9.25"W x 0.85"D	58"	-	5
CSSTNN-58N 026613113920	3/8" OD Flare Nuts (9/16-24 Fine Thread), Both Ends Bulk w/Flag Label. 58"L x 0.85"W x 0.85"D	58"	-	12
CSSTNN-70N P 026613126050	3/8" OD Flare Nuts (9/16-24 Fine Thread), Both Ends 1 Per Bag. 12.375"L x 9.25"W x 0.85"D	70"	-	5
CSSTNN-70N 026613113937	3/8" OD Flare Nuts (9/16-24 Fine Thread), Both Ends Bulk w/Flag Label. 70"L x 0.85"W x 0.85"D	70"	-	12



Gas Installation Kits

Designed to Fit Most New and Older Appliances

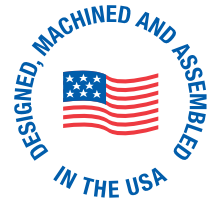

Kits contain everything needed to make a quick and EZ gas connection.

- ProCoat® Coated Stainless Steel Gas Connector
- Safety+PLUS® Excess Flow Valve*
- Multiple Steel Gas Fittings to Fit Most Appliances
- Pipe Thread Sealant
- Leak Detection Solution

*Included with PSC1106 K5, PSC1107 K5 and PSC1108X L kits only.



Part No. UPC	Description Package Size	Length	Shelf Qty	Case Qty
-----------------	-----------------------------	--------	--------------	-------------

Black ProCoat® Gas Installation Kit for Gas Log & Space Heater



PSC1079 026613114439	(1) BCSSD54-24 1/2" OD x 24" black coated gas connector (1) AU2-8S 1/2" MIP (3/8" FIP) steel fitting (1) AU1-8S 1/2" FIP steel fitting (1) AU2-8-6S 3/8" MIP steel fitting (1) 3mil tube of pipe thread sealant (1) 3mil tube of leak detection solution 1 Kit Per Box. 9"L x 6.6875"W x 1.25"D	24"	-	5
-------------------------	---	-----	---	---

Safety+PLUS® Gas Installation Kit for Range & Dryer



PSC1106 K5 039166123889	(1) CSSD44R-48 1/2" OD x 48" yellow coated gas connector (1) RU2-8L Safety+PLUS EFV (1/2" MIP) (1) AU2-8S 1/2" MIP (3/8" FIP) steel fitting (1) AU1-8S 1/2" FIP steel fitting (1) AU2-8-6S 3/8" MIP steel fitting (1) 3mil tube of pipe thread sealant (1) 3mil tube of leak detection solution 1 Kit Per Box. 9" L x 9.25" W x 2.25" D	48"	-	5
----------------------------	--	-----	---	---

Part No. UPC	Description Package Size	Length	Shelf Qty	Case Qty
-----------------	-----------------------------	--------	--------------	-------------

Safety+PLUS® Gas Installation Kit for Pro-Grade Range & Furnace (cont.)

PSC1107 K5 039166123896	(1) CSSC54R-48 5/8" OD (15/16-16 Thread) x 48" yellow coated gas connector (1) MRU2-10-12 Safety+PLUS EFV 3/4" MIP (1/2" FIP) (1) MAU2-10-12S 3/4" MIP (1/2" FIP) steel fitting (1) MAU2-10-8S 1/2" MIP steel fitting (1) 3mil tube of pipe thread sealant (1) 3mil tube of leak detection solution 1 Kit Per Box. 9" L x 9.25" W x 2.25" D	48"	-	5
----------------------------	---	-----	---	---



Electric Water Heater Installation Kit

PSC1085X L 039166111619	(2) BWB20-15 3/4" MIP x 3/4" FIP x 15" flexible polymer braided water heater connector (2) 68-14-12X B compression x male adaptor (1) 3mil tube of pipe thread sealant 1 Kit Per Box. 9.0"L x 9.25"W x 2.25"D	15"	-	5
----------------------------	--	-----	---	---



Safety+PLUS® Gas Water Heater Installation Kit

PSC1108X L 039166123902	(2) BWB20-15 3/4" MIP x 3/4" FIP x 15" flexible polymer braided water heater connector (2) 68-14-12X B compression x male adaptor (1) CSSD44R-18 1/2" OD x 18" yellow coated gas connector (1) RU2-8 Safety+PLUS EFV (1/2" MIP) (1) AU2-8-6S 3/8" MIP steel fitting (1) AU1-8S 1/2" FIP steel fitting (1) 3mil tube of pipe thread sealant (1) 3mil tube of leak detection solution 1 Kit Per Box. 9.0"L x 9.25"W x 2.25"D		-	5
----------------------------	--	--	---	---

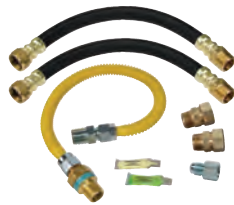

ProCoat® Gas Water Heater Installation Kit

PSC1098 L 039166108558	(1) CSSD44-18 1/2" OD x 18" yellow coated gas connector (2) AU2-8S 1/2" MIP (3/8" FIP) steel fitting (1) AU1-8S 1/2" FIP steel fitting (2) BWB020-15 x 15" braided water heater connector (2) 68-14-12X B compression x male adaptor (1) 3mil tube of pipe thread sealant (1) 3mil tube of leak detection solution 1 Kit Per Box. 10.25"L x 9.25"W x 2.25"D		-	5
---------------------------	--	--	---	---



ProCoat® Tankless Water Heater Installation Kit

PSB1096 L 039166108497	(1) CSSB21-24 7/8" OD x 24" yellow coated gas connector (1) AU2-14-12 1/2" FIP steel fitting (1) AU2-14-16 1" MIP steel fitting (1) AU1-14-12 3/4" FIP steel fitting (1) AU1-14-16 1" FIP steel fitting (1) 3mil tube of pipe thread sealant (2) 3mil tube of leak detection solution 1 Kit Per Bag. 15.125"L x 10.25"W x 1.275"D	24"	-	5
---------------------------	--	-----	---	---



Gas Ball Valves

Superior Performance and Reliability



Forged Brass Body

Eliminates pinhole leaks commonly associated with cast products.

Specially Designed Seat Rings

PTFE seats assure longer life.

Quarter-Turn Design

For easy on/off operation.

Blow-Out Proof Stem

Assembled from the inside with double o-rings to help ensure safe, reliable performance.

100% Leak Tested

Each valve is leak tested to help ensure reliability.

Patented Design Handle

Integrates "T" and lever handles into one, saving inventory SKUs and dollars.

Made in Italy*



Part No. UPC	Description Package Size	Finish	Shelf Qty	Case Qty
-----------------	-----------------------------	--------	--------------	-------------

FIP x FIP



TBV8 026613099415	1/2" FIP x 1/2" FIP Bulk Packed. 2.25"L x 2"W x 1"D		10	50
TBV12 026613099422	3/4" FIP x 3/4" FIP Bulk Packed. 2.69"L x 2.25"W x 1.31"D		10	50
TBV16 026613099439	1" FIP x 1" FIP Bulk Packed. 2.56"L x 2.5"W x 1.62"D		6	36

FIP x FIP - (China)



PSBV503-8 039166081783	1/2" FIP x 1/2" FIP 1 Per Bag. 6"L x 5"W x 1.035"D		-	5
LBV8 026613122052	1/2" FIP x 1/2" FIP Bulk Packed. 2.12"L x 1.985"W x 1.035"D		10	50
PSBV503-12 039166081790	3/4" FIP x 3/4" FIP 1 Per Bag. 8.1875"L x 5"W x 1.375"D		-	5
LBV12 026613122069	3/4" FIP x 3/4" FIP Bulk Packed. 2.38"L x 2.25"W x 1.31"D		10	50

Flare x FIP



PSSC-60 039166055272	5/8" OD Flare (15/16-16 Thread) x 3/4" FIP 1 Per Bag. 6"L x 5"W x 0.75"D		-	5
TBV10-12 026613099385	5/8" OD Flare (15/16-16 Thread) x 3/4" FIP Bulk Packed. 2.5"L x 2.12"W x 1.25"D		10	60
PSSC-68 039166011070	5/8" OD Flare (15/16-16 Thread) x 1/2" FIP 1 Per Bag. 8.1875"L x 5"W x 1.125"D		-	5

*Except where noted

Part No. UPC	Description Package Size	Finish	Shelf Qty	Case Qty
Flare x FIP (cont.)				
TBV10-8 026613099378	5/8" OD Flare (15/16-16 Thread) x 1/2" FIP Bulk Packed. 2.5"L x 2"W x 1"D		10	60
PSSD-41 039166055210	1/2" OD Flare x 1/2" FIP 1 Per Bag. 6"L x 5"W x 1.25"D		-	5
TBV8-8 026613099361	1/2" OD Flare x 1/2" FIP Bulk Packed. 1.96"L x 1.8"W x 1.25"D		10	50
PSSL-12 039166055203	3/8" OD Flare x 1/2" FIP 1 Per Bag. 6"L x 5"W x 0.9375"D		-	5
TBV6-8 026613099347	3/8" OD Flare x 1/2" FIP Bulk Packed. 2.5"L x 1"W x 2"D		10	50
TBV6F-8 026613099354	3/8" OD Flare (9/16-24 Fine Thread) x 1/2" FIP Bulk Packed. 2.38"L x 2"W x 1"D		10	50



Flare x FIP - Angle

PSSC-61 039166055142	5/8" OD Flare (15/16-16 Thread) x 3/4" FIP 1 Per Bag. 6"L x 5"W x 1.875"D		-	5
TBVA10-12 026613099392	5/8" OD Flare (15/16-16 Thread) x 3/4" FIP Bulk Packed. 2"L x 2.5"W x 2.25"D		10	60



Flare x Flare

TBVF6 026613099316	3/8" OD Flare x 3/8" OD Flare Bulk Packed. 2.63"L x 2"W x 1"D		10	50
-----------------------	--	--	----	----





Part No. UPC	Description Package Size	Finish	Shelf Qty	Case Qty
-----------------	-----------------------------	--------	--------------	-------------

Flare Caps

M40-10 P 026613155715	5/8" OD Flare (15/16-16 Thread) 1 Per Bag. 5"L x 5"W x 0.82"D		-	50
--------------------------	--	--	---	----



Flare x FIP

MAU1-10-12 K5 026613084251	5/8" OD Flare (15/16-16 Thread) x 3/4" FIP Bulk Bag. 8.00"L x 6.00"W x 1.10"D		5	100
-------------------------------	--	--	---	-----

MAU1-10-12S 026613082660	5/8" OD Flare (15/16-16 Thread) x 3/4" FIP Bulk Bag. 10.00"L x 8.00"W x 1.25"D	Rough	25	150
-----------------------------	---	-------	----	-----



MAU1-10-8 K5 026613084275	5/8" OD Flare (15/16-16 Thread) x 1/2" FIP Bulk Bag. 8.00"L x 6.00"W x 1.10"D		5	200
------------------------------	--	--	---	-----



MAU1-10-8S 026613088570	5/8" OD Flare (15/16-16 Thread) x 1/2" FIP Bulk Bag. 10.00"L x 8.00"W x 2.50"D	Rough	25	150
----------------------------	---	-------	----	-----



Flare x MIP

MAU2-10-12 K5 026613084282	5/8" OD Flare (15/16-16 Thread) x 3/4" MIP (1/2" FIP) Bulk Bag. 8.00"L x 6.00"W x 1.10"D		5	120
-------------------------------	---	--	---	-----

MAU2-10-12S 026613082677	5/8" OD Flare (15/16-16 Thread) x 3/4" MIP (1/2" FIP) Bulk Bag. 12.50"L x 9.00"W x 1.19"D	Rough	25	125
-----------------------------	--	-------	----	-----

MAU2-10-8 K5 026613084299	5/8" OD Flare (15/16-16 Thread) x 1/2" MIP (3/8" FIP) Bulk Bag. 6.00"L x 6.00"W x 1.10"D		5	100
------------------------------	---	--	---	-----

MAU2-10-8S 026613082684	5/8" OD Flare (15/16-16 Thread) x 1/2" MIP (3/8" FIP) Bulk Bag. 12.50"L x 9.00"W x 1.13"D	Rough	25	150
----------------------------	--	-------	----	-----



Fine Thread Female Flare Adaptors

PSFT-12 039166105311	3/8" OD Flare (9/16-24 Fine Thread) x 1/2" MIP (3/8" FIP) w/Yellow Chromate Coating 1 Per Bag. 7.4375"L x 3.1875"W x 1.22"D		5	50
-------------------------	--	--	---	----

PSCFT-10 039166082964	3/8" OD Flare (9/16-24 Fine Thread) x 3/8" MIP w/Yellow Chromate Coating 1 Per Card. 2.82"L x 2.75"W x 1.375"D		-	10
--------------------------	---	--	---	----



PSCFT-11 039166082971	3/8" OD Flare (9/16-24 Fine Thread) x 1/2" FIP w/Yellow Chromate Coating 1 Per Card. 2.82"L x 2.75"W x 1.375"D		-	10
--------------------------	---	--	---	----



Flare x FIP

PSSL-13 039166081769	3/8" OD Flare x 3/8" FIP 1 Per Bag. 6.8"L x 3.188"W x 1.22"D		5	50
-------------------------	---	--	---	----

PSSL-15 039166081813	3/8" OD Flare x 1/2" FIP 1 Per Bag. 6.8"L x 3.188"W x 1.22"D		5	50
-------------------------	---	--	---	----

PSSD-42 039166081745	1/2" OD Flare x 1/2" FIP 1 Per Bag. 6.8"L x 3.188"W x 1.22"D		5	50
-------------------------	---	--	---	----

PSSC-62 039166081707	5/8" OD Flare (15/16-16 Thread) x 1/2" FIP 1 Per Bag. 6.8"L x 3.188"W x 1.22"D		5	50
-------------------------	---	--	---	----

PSSC-66 039166081806	5/8" OD Flare (15/16-16 Thread) x 3/4" FIP 1 Per Bag. 6.8"L x 3.188"W x 1.22"D		5	50
-------------------------	---	--	---	----

Part No. UPC	Description Package Size	Finish	Shelf Qty	Case Qty
Flare x FIP Elbow				
PSSC-65 039166081752	5/8" OD Flare (15/16-16 Thread) x 3/4" FIP 1 Per Bag. 7.4375"L x 3.1875"W x 1.22"D		5	50



Flare x MIP				
PSSC-63 039166081714	5/8" OD Flare (15/16-16 Thread) x 1/2" MIP (3/8" FIP) 1 Per Bag. 6.8"L x 3.188"W x 1.22"D		5	50
PSSC-64 039166081721	5/8" OD Flare (15/16-16 Thread) x 3/4" MIP (1/2" FIP) 1 Per Bag. 6.8"L x 3.188"W x 1.22"D		5	50
PSSD-43 039166081738	1/2" OD Flare x 1/2" MIP (3/8" FIP) 1 Per Bag. 6.8"L x 3.188"W x 1.375"D		5	50
PSSD-44 039166105304	1/2" OD Flare x 3/4" MIP 1 Per Bag. 6.8"L x 3.188"W x 1.22"D		5	50
PSSL-14 039166081776	3/8" OD Flare x 3/8" MIP (1/8" FIP) 1 Per Bag. 6.8"L x 3.188"W x 1.22"D		5	50
PSSL-16 039166081820	3/8" OD Flare x 1/2" MIP (3/8" FIP) 1 Per Bag. 6.8"L x 3.188"W x 1.22"D		5	50



Female Flare x MIP				
AU6-8-6 P 026613159348	1/2" Female Flare x 3/8" MIP 1 Per Bag. 7.4375"L x 3.1875"W x 0.875"D		-	5



Female Flare x FIP				
AU7-10-8 P 026613159355	5/8" Female Flare x 1/2" FIP 1 Per Bag.		-	5



Part No. UPC	Description Package Size	Finish	Shelf Qty	Case Qty
-----------------	-----------------------------	--------	--------------	-------------

Seal'n Check Kit



PS1087 039166094714	Includes (3mil) Pipe Thread Sealant & (3mil) Leak Test Solution 1 Kit Per Clamshell. 3.625"L x 0.25"W x 0.75"D		10	50
------------------------	---	--	----	----



PS1087 XL 026613172620	Includes (1 oz) Pipe Thread Sealant & (2 oz) Leak Test Solution 1 Kit Per Slide Pack 5.875"L x 2.5"W x 1.375"D		-	5
---------------------------	---	--	---	---



PSC1094 L 039166105298	(2 oz) Leak Test Solution 1 Bottle per Bag. 6"L x 4"W x 1.25"D		-	5
---------------------------	---	--	---	---

Part No. UPC	Description Package Size
-----------------	-----------------------------

Brochures

BC8470	How to Select & Install Water Supply Stops and Connectors Brochure - 8.5" High x 3.5" Wide
BC8472	How to Select & Install Gas Appliance Connectors Brochure - 8.5" High x 3.5" Wide
BC8473	Procoat Gas Connector Take-With Brochure - 9" High x 10.75" Wide
BC8471	Safety+PLUS Gas Connector Take-With Brochure - 9" High x 11" Wide



Signage

BC8500	Flexible Water Supply Connectors Faucet and Toilet Double Sided Header With Rack - Horizontal - 8" High x 18" Wide
BC8480	Flexible Water Supply Connectors Faucet Divider - Vertical - 24" High x 6" Wide
BC8483	Flexible Water Supply Connectors Toilet Divider - Vertical - 24" High x 6" Wide



Part No. UPC	Description Package Size
-----------------	-----------------------------

Signage (cont.)



BC8491	Polymer Braided Water Heater Connector Header for Rack - 6.5" High x 5.5" Wide
--------	--



BC203	Water Heater Connector Rack w/ProCoat and Copper-Flex Header - 6.5" High x 5.5" Wide
-------	--



BC8501	Gas Connector Rack with ProCoat Header - 11" High x 18" Wide
--------	--



BC8502	Gas Connector Rack with Safety+PLUS Header - 11" High x 18" Wide
--------	--



BC8492	Procoat Aisle Header - Horizontal - 8" High x 24" Wide
--------	--



BC8493	Procoat Aisle Header - Vertical - 24" High x 6" Wide
--------	--



BC8481	Safety+PLUS Aisle Header - Horizontal - 8" High x 24" Wide
--------	--



BC8482	Safety+PLUS Advantage Divider - Vertical - 24" High x 6" Wide
--------	---



BC8503	ProCoat Large Diameter Gas Connector Rack - 6.5" High x 5.5" Wide
--------	---

Part No. UPC	Description Package Size
-----------------	-----------------------------

Sizing Guide

BC8510 Flexible Water Supply Connectors and Faucet and Toilet Sizing Guide - Vertical - 19.5" High x 6.25" Wide



BC8511 Gas Appliance Connector Sizing Guide - 19.5" High x 6.25" Wide



Merchandising Aides

DIH824 Aisle Header Plastic Mounting Frame - 8.5" High x 24.25" Wide
1 Per Each.



PS8024 Metal Vertical Divider Holder - 24" High x 6" Wide
1 Per Each.

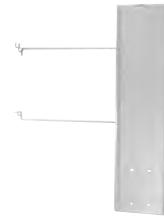

DD6000 Wire Brochure Holder - 5" High x 4.25" Wide x 2.75" Deep
1 Per Each.



1/4 TURN SUPPLY VALVES – G2™ SERIES

Use: For use only in potable water distribution systems. Not intended for recirculating water systems that produce continuous use temperatures above 115° F.

Design Features:

- **One-piece shut-off mechanism** provides smooth on-off operation without freeze ups even after long periods of non use
- **Machined one-piece brass body** provides strength, durability, and long-lasting performance
- **Positive 1/4 turn shut off**
- **Easy-to-remove handle** helps protect against accidental valve operation during rough-ins
- **100% leak tested**
-  **No Lead**

Operating Specifications:

Temperature: 40° - 140° F

Pressure: 125 PSI maximum

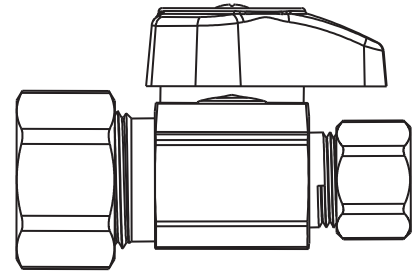
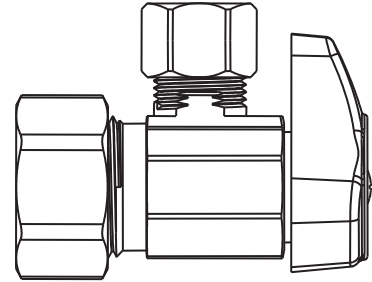
**VALVE MATERIAL SPECIFICATIONS**

Body	No-lead brass, chrome plated
Handle	Zinc die cast
Handle Screw	Zinc-plated steel
O-ring	Rubber
Stem Shaft	Polypropylene
Stem Barrel	Santoprene
Compression Sleeve	Brass
Compression Nut	Brass, chrome plated

Listings & Certifications:

- IAPMO listed to ASME A112.18.1 / CSA B125.1 (File # 0645)
- CSA listed to ASME A112.18.1 / CSA B125.1 (File # 204593)
- No-lead product CSA listed to NSF 372 (Class 6853-01)



1/4 TURN SUPPLY VALVES – PUSH CONNECT

Use: For use only in potable water distribution systems. Not intended for recirculating water systems that produce continuous use temperatures above 115° F.

Design Features:

- **One-piece shut-off mechanism** provides smooth on-off operation without freeze ups even after long periods of non use
- **Compatible** with PEX, copper, and CPVC tubing
- **Pre-assembled tube insert** is “installation ready” for a faster connection
- **Fast**, reliable, and secure connection
- **Positive** 1/4 turn shut off
- **Easy-to-remove handle** helps protect against accidental valve operation during rough-ins
- **Compact, machined** one-piece body design
- **100% leak tested**
-  **No Lead**

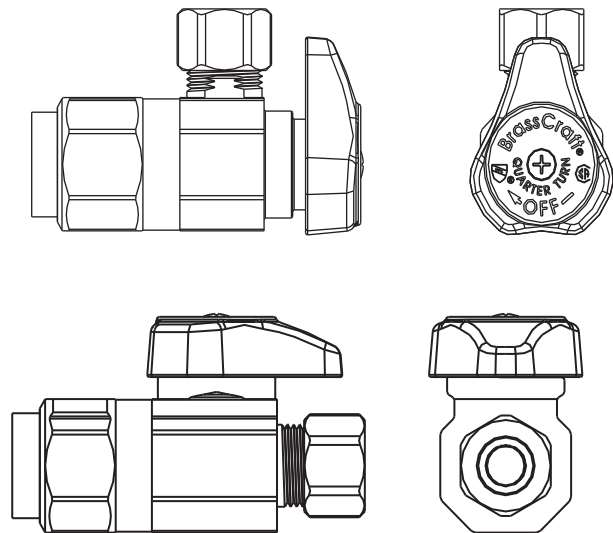

Operating Specifications:

Temperature: 40° - 140° F
Pressure: 125 PSI maximum

VALVE MATERIAL SPECIFICATIONS	
Body	No-lead brass, chrome plated
Handle	Zinc die cast
Handle Screw	Zinc-plated steel
O-ring	Rubber
Stem Shaft	Polypropylene
Stem Barrel	Santoprene
Removal Flange	Polypropylene
Tube Insert	POM
Gripper Ring	Stainless steel
Push Connect Retainer	Nylon
Compression Sleeve	Brass
Compression Nut	Brass, chrome plated

Listings & Certifications:

- IAPMO listed to ASME A112.18.1 / CSA B125.1 and ASSE 1061 (File # 0645)
- CSA listed to ASME A112.18.1 / CSA B125.1 and ASSE 1061 (File # 204593)
- No-lead product CSA listed to NSF 372 (Class 6853-01)



1/4 TURN SUPPLY VALVES – PUSH CONNECT WITH LOCKING CLIP

Use: For use only in potable water distribution systems. Not intended for recirculating water systems that produce continuous use temperatures above 115° F.

Design Features:

- **One-piece shut-off mechanism** provides smooth on-off operation without freeze ups even after long periods of non-use
- **Compatible** with PEX, copper, and CPVC tubing
- **Pre-assembled tube insert** is “installation ready” for a faster connection
- **Fast**, reliable, and secure connection
- **Positive** 1/4 turn shut off
- **Easy-to-remove handle** helps protect against accidental valve operation during rough-ins
- **Locking clip** adds security to connection while allowing removal if needed
- **Captive removal flange** permits easy removal from tube
- **100% leak tested**
-  **No Lead**

Operating Specifications:

Temperature: 40° - 140° F

Pressure: 125 PSI maximum

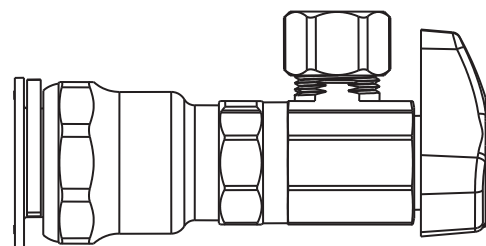
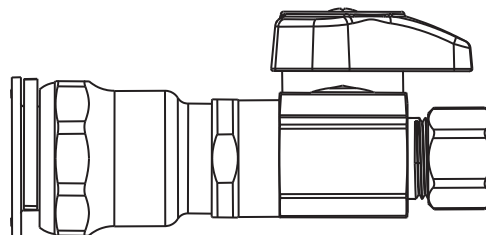

VALVE MATERIAL SPECIFICATIONS

Body	No-lead brass, chrome plated
Handle	Zinc die cast
Handle Screw	Zinc-plated steel
O-ring	Rubber
Stem Shaft	Polypropylene
Stem Barrel	Santoprene
Removal Flange	Nylon
Tube Insert	Stainless steel
Gripper Ring	Stainless steel
Locking Clip	Nylon
Compression Sleeve	Brass
Compression Nut	Brass, chrome plated

Listings & Certifications:

- IAPMO listed to ASME A112.18.1 / CSA B125.1 and ASSE 1061 (File # 0645)
- CSA listed to ASME A112.18.1 / CSA B125.1 and ASSE 1061 (File # 204593)
- No-lead product CSA listed to NSF 372 (Class 6853-01)



MULTI-TURN SUPPLY VALVES

Use: For use only in potable water distribution systems. Not intended for recirculating water systems that produce continuous use temperatures above 115° F.

Design Features:

- **Machined one-piece brass body** provides strength, durability, and long-lasting performance
- **Easy-to-remove handle** helps protect against accidental valve operation during rough-ins
- **Oval knurled handle** provides a secure grip and smooth on/off operation
- **Handle variations** available for specific configurations – see variations page
- **Dual outlet and dual outlet/dual shut-off** configurations available
-  **No Lead**

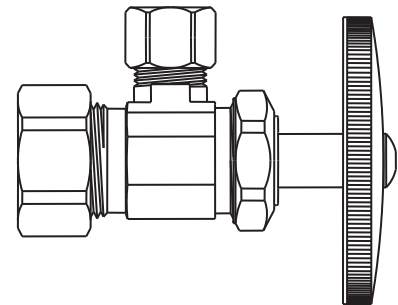
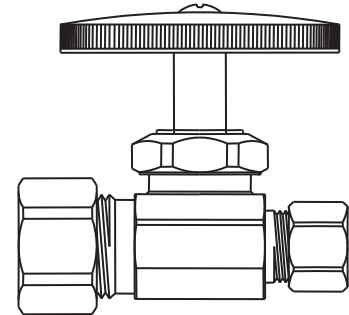

Operating Specifications:

Temperature: 40° - 140° F
Pressure: 125 PSI maximum

VALVE MATERIAL SPECIFICATIONS	
Body	No-lead brass or No-lead brass, chrome plated
Stem	POM; brass; or brass, chrome plated
Handle	Zinc die cast; ABS, plated; or Polycarbonate
Handle Screw	Zinc-plated steel
Bib & Packing Washer	Rubber
Packing Nut	Brass or brass, chrome plated
Compression Sleeve	Brass
Compression Nut	Brass or brass, chrome plated

Listings & Certifications:

- IAPMO listed to ASME A112.18.1 / CSA B125.1 (File # 0645)
- CSA listed to ASME A112.18.1 / CSA B125.1 (File # 204593)
- No-lead product CSA listed to NSF 372 (Class 6853-01)



WATER SUPPLY CONNECTORS – SUPPLY RISERS, COPPER OR PEX

Use: For use only in potable water distribution systems in accessible locations.

Design Features:

- **One-piece** construction
- **Cut-to-length** for clean, professional installation
-  **No Lead**

Operating Specifications:

Temperature 40° - 180° F
Pressure: 125 PSI maximum

Tubing Diameter: 3/8" OD or 1/2" OD

CONNECTOR MATERIAL SPECIFICATIONS

Tube	Cross-linked Polyethylene (PEX) or Copper per ASTM B-68
Compression Sleeve (3/8"OD)	POM (PEX only)
Insert	POM (Copper only)
Optional Brass Nosepiece	No-lead brass
Optional Cone Washer	Rubber
Optional Brass Ring	Brass

Listings & Certifications:

- IAPMO listed to ASME A112.18.1 / CSA B125.1 (File # 0645)
- CSA listed to ASME A112.18.1 / CSA B125.1 (File # 204593)
- No-lead product CSA listed to NSF 372 (Class 6853-01)

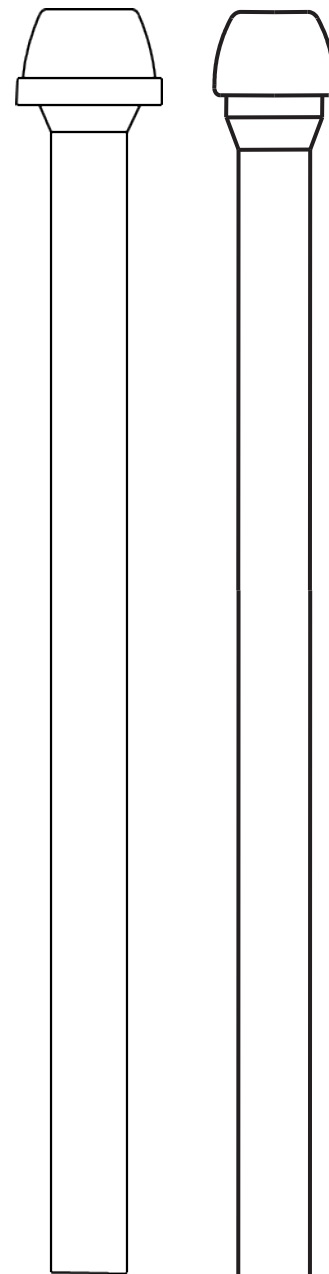

WATER SUPPLY CONNECTORS – SPEEDI PLUMB® PLUS – FLEXIBLE POLYMER BRAIDED

Use: For use only in potable water distribution systems in accessible locations.

Design Features:

- **Superior corrosion resistance** to harsh chemicals found in most common household cleaning and plumbing repair products
- **Braided polymer-coated fibers** bend freely without kinking or crimping
- **Tough inner core** is reinforced to help resist deterioration from chlorine and chloramine contact
- **Rubber washers** provide a large pliable sealing surface and ensure a long lasting water-tight connection
- **8-sided pneumatic crimp** provides greater dependability for reliable nut-to-hose connections
- **Deep threaded wing nut** for quick and secure connections
-  **No Lead**

Operating Specifications:

Temperature: 40° - 140° F, intermittent to 180° F
Pressure: 125 PSI maximum

CONNECTOR MATERIAL SPECIFICATIONS	
Inner Hose	Reinforced PVC
Braiding	PVC coated polyester yarn
Barb	Brass
Ferrule	Zinc-plated steel
Nut	Brass or polypropylene
Washer	Rubber

Listings & Certifications:

- IAPMO listed to ASME A112.18.6 / CSA B125.6 (File # 0452)
- CSA listed to ASME A112.18.6 / CSA B125.6 (File # 204593)
- No-lead product CSA listed to NSF 372 (Class 6853-01)

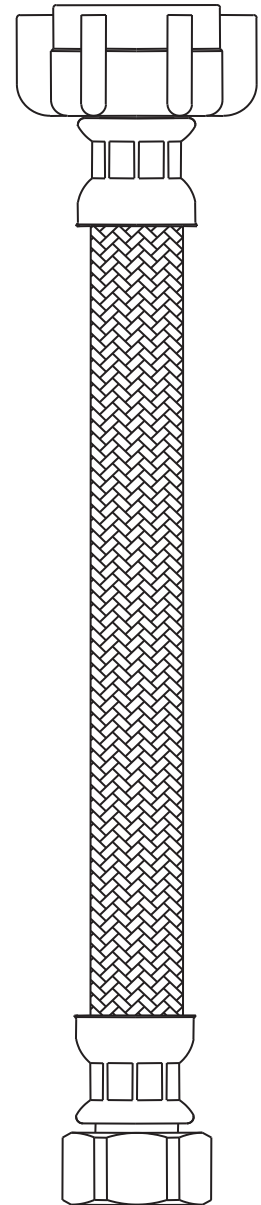

WATER SUPPLY CONNECTORS – SPEEDI PLUMB® – VINYL

Use: For use only in potable water distribution systems in accessible locations.

Design Features:

- **No kink hose.** The specially engineered reinforced PVC hose provides unique flexibility to prevent kinking and crimping
- **Greater strength and durability** with a tighter weave and two-layer bonded construction, outperforms conventional vinyl connectors
- **Rubber washers** provide a large pliable sealing surface and help ensure a long lasting water-tight connection
- **8-sided pneumatic crimp** provides greater dependability for reliable nut-to-hose connections
- **Deep threaded wing nut** for quick and secure connections
- **Tough inner core** is reinforced to help resist deterioration from chlorine and chloramine contact
-  **No Lead**

Operating Specifications:

Temperature: 40°- 140° F, intermittent to 180° F

Pressure: 125 PSI maximum

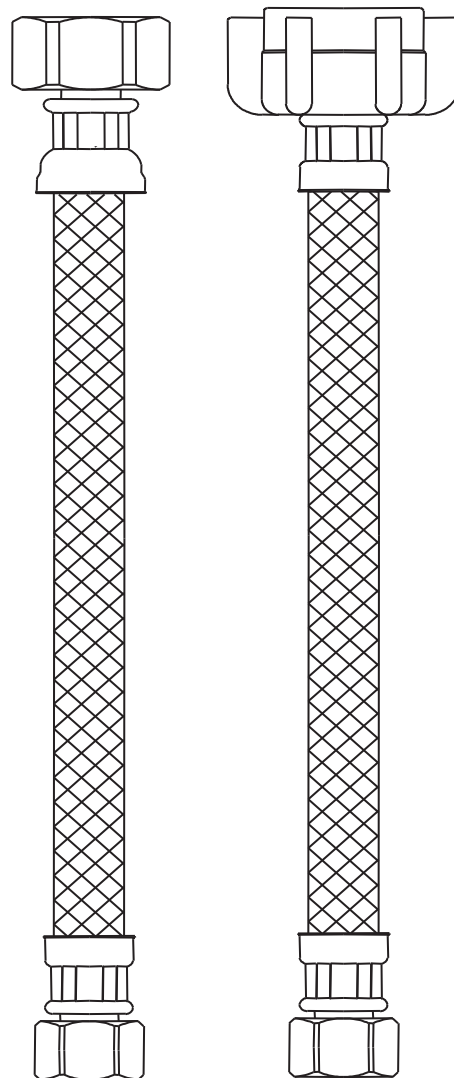

CONNECTOR MATERIAL SPECIFICATIONS

Hose	<i>PVC with polyester braid reinforcement</i>
Barb	<i>Brass</i>
Ferrule	<i>Zinc-plated steel</i>
Nut	<i>Brass or polypropylene</i>
Washer	<i>Rubber</i>

Listings & Certifications:

- IAPMO listed to ASME A112.18.6 / CSA B125.6 (File # 0452)
- CSA listed to ASME A112.18.6 / CSA B125.6 (File # 204593)
- No-lead product CSA listed to NSF 372 (Class 6853-01)



SPEEDI PLUMB® PLUS POLYMER BRAIDED WATER HEATER CONNECTORS

Use: For use only in exposed locations to connect water heaters and other water connected devices to the water supply. Not intended for use with recirculating water systems that produce continuous use temperatures above 115° F. For those applications use the BrassCraft® CopperFlex™ or ProCoat® series connectors.

Design Features:

- **Superior corrosion resistance** to harsh chemicals found in most common household cleaning and plumbing repair products
- **Greater strength & flexibility.** The patented polymer braid exhibits superior elasticity, significantly increasing the flexibility of the connector
- **No kinking, no crimping.** The polymer braided jacket is specially engineered to bend freely without kinking or crimping the connector
- **Won't work harden** even with repeated bending
- **No dielectric union needed** with installation as the braiding and rubber are constructed of non-conductive materials*
- **Longer connector nuts** allow a greater number of thread-to-thread contact and a better seal
-  **No Lead**

Operating Specifications:

Temperature: 40° - 140° F, intermittent to 180° F
Pressure: 125 PSI maximum

OPERATING SPECIFICATION				
	12"	15"	18"	24"
Flow Coefficient (Cv)	5.9	5.8	5.6	5.4

ΔP (Pressure Drop) = GPM^2 / Cv^2 for Example: 24" length connector @ 10 GPM
 $\Delta P = 10^2 / 5.4^2 = 100 / 29.16 = 3.43$ psi

CONNECTOR MATERIAL SPECIFICATIONS	
Inner Hose	Rubber
Braiding	Coated polyester yarn
Barb	Brass
Ferrule	Brass
Nut	Brass
End Fitting	Brass
Washer	Rubber



Listings & Certifications:

- IAPMO listed to ASME A112.18.6 / CSA B125.6 (File # 0452)
- CSA listed to ASME A112.18.6 / CSA B125.6 (File # 204593)
- No-lead product CSA listed to NSF 372 (Class 6853-01)



*Check with your local inspection office for applicable code requirements

COPPER-FLEX™ CORRUGATED WATER HEATER CONNECTORS

Use: For use only in exposed locations to connect water heaters and other water connected devices to the water supply.

Design Features:

- **Superior galvanic corrosion resistance.** Patented internal dielectric sleeve effectively isolates dissimilar metals within the waterway to prevent galvanic corrosion
- **No dielectric union needed** with installation. Dielectric is built into the design of the connector*
- **Less torque to seal** against the pliable rubber washer, especially on rough nipple surfaces
- **Longer connector nuts** allow a greater number of thread-to-thread contacts and a better seal
-  **No Lead** (WB & WC Series only)

Operating Specifications:

Temperature: 40° - 180° F

Pressure: 125 PSI maximum

CONNECTOR MATERIAL SPECIFICATIONS	
 tubing	<i>Copper</i>
 Dielectric Sleeve	<i>Polypropylene</i>
 Nut	<i>Brass</i>
 End Fitting	<i>Brass</i>
 Washer	<i>Rubber</i>

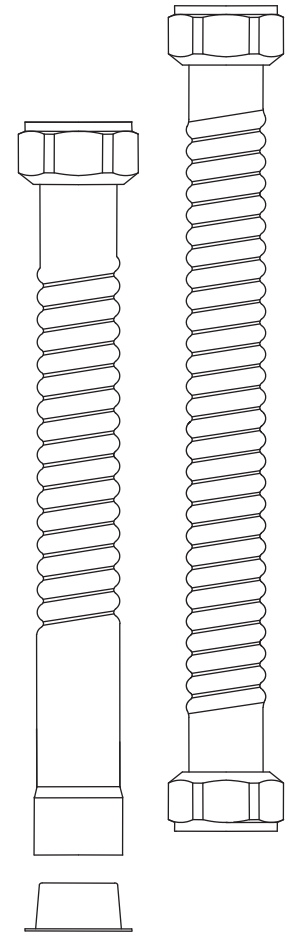

Listings & Certifications:

- IAPMO listed to ASME A112.18.6 / CSA B125.6 (File # 0452)
- CSA listed to ASME A112.18.6 / CSA B125.6 (File # 204593)
- No-lead product CSA listed to NSF 372 (Class 6853-01)



*Check with your local inspection office for applicable code requirements

PROCOAT® STAINLESS STEEL WATER HEATER CONNECTORS

Use: For use only in exposed locations to connect water heaters, water softeners, and other water connected devices to the water supply.

Design Features:

- **Superior corrosion resistance** coating to protect against harsh chemicals found in common household cleaning, plumbing repair, and masonry products
- **Full flow, maximum performance.** 3/4" internal diameter provides greater water flow without obstruction
- **Integrated dielectric sleeve** effectively isolates dissimilar metals within the waterway to help prevent galvanic and electrolytic corrosion
- **No dielectric union needed** with installation. Dielectric is built into the design of the connector*
- **Less torque to seal** against the pliable rubber washer, especially on rough nipple surfaces
- **Longer connector nuts** allow a greater number of thread-to-thread contacts and a better seal
- **100% leak tested** prior to coating application to help ensure connector performance and reliability
-  **No Lead**

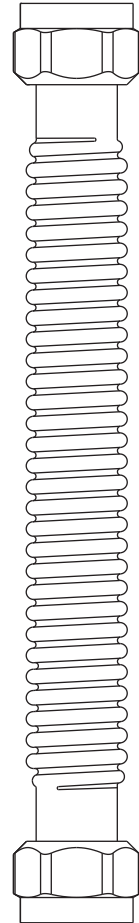

Operating Specifications:

Temperature: 40° - 180° F
Pressure: 125 PSI maximum

MATERIAL SPECIFICATIONS	
Tube	<i>Stainless steel</i>
Dielectric Sleeve	<i>Polypropylene</i>
Nut	<i>Brass, chrome plated</i>
Washer	<i>Rubber</i>

Listings & Certifications:

- IAPMO listed to ASME A112.18.6 / CSA B125.6 (File # 0452)
- CSA listed to ASME A112.18.6 / CSA B125.6 (File # 204593)
- No-lead product CSA listed to NSF 372 (Class 6853-01)



*Check with your local inspection office for applicable code requirements

PROCOAT® COATED GAS CONNECTORS

Use: For use with indoor and outdoor connections of gas appliances to gas piping system. May be used with natural, manufactured, mixed and liquefied petroleum (LP or propane) gases, and LP gas-air mixtures.

Design Features:

- **Superior corrosion resistance** coating to protect against harsh chemicals found in common household cleaning, plumbing repair, and masonry products
- **UV rays and salt resistant**, ProCoat® gas connectors are certified for indoor and outdoor use
- **100% performance tested**

Operating Specifications:

Temperature: -40° - 150° F
Pressure: 1/2 PSI maximum

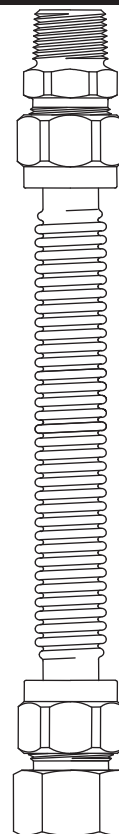

CONNECTOR MATERIAL SPECIFICATIONS

Tubing	<i>Stainless steel</i>
Coating	<i>Polymer blend</i>
Nut	<i>Steel</i>
Fitting	<i>Steel</i>

CONNECTOR FLOW CAPACITY – NATURAL GAS (Straight Length)

MODEL	ID	12"	18"	24"	30"	36"	48"	60"	72"
CSSB	3/4"	290,900	290,900	290,900	270,500	255,900	215,000	197,400	173,900
CSSC	1/2"	180,000	164,200	150,000	136,000	125,000	106,000	93,200	86,000
CSSD	3/8"	102,000	93,100	85,000	77,100	71,100	60,500	53,200	49,100
CSSL	1/4"	48,000	43,800	40,000	36,400	33,400	28,300	24,900	23,100

CONNECTOR FLOW CAPACITY - LPG (PROPANE) (Straight Length)

MODEL	ID	12"	18"	24"	30"	36"	48"	60"	72"
CSSB	3/4"	465,440	465,440	465,440	432,800	409,440	344,000	315,840	278,240
CSSC	1/2"	288,000	262,720	240,000	217,600	200,000	169,600	149,120	137,600
CSSD	3/8"	163,200	148,960	136,000	123,360	113,760	96,800	85,120	78,560
CSSL	1/4"	76,800	70,080	64,000	58,240	53,440	45,280	39,840	36,960

Listings & Certifications:

- CSA listed to ANSI Z21.24 / CSA 6.10 standard "Connectors for Gas Appliances" (file #204593)
- CSA listed to ANSI Z21.75 / CSA 6.27 standard "Connectors for Outdoor Gas Appliances & Manufactured Homes" (file #204593)
- The Commonwealth of Massachusetts



GAS BALL VALVES

Use: For use with natural, manufactured, mixed, liquefied petroleum (LP) gas, and LP gas-air mixtures.

The National Fuel Gas Code requires a gas shut-off valve installed upstream, within “easy reach” or 6 feet of the gas appliance

Design Features:

- **Heavy duty forged brass body** eliminates pinhole leaks commonly associated with cast products
- **Blow-out resistant stem** is assembled from the inside with double o-rings for reliable performance
- **Right-sized handles to help** ensure on/off operation even in tight installations
- **Quarter turn operation** for easy on/off flow control
- **PTFE seat** for longer life and consistent performance
- **Approved for indoor/outdoor use**
- **100% leak tested**

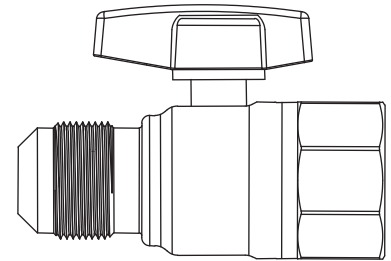
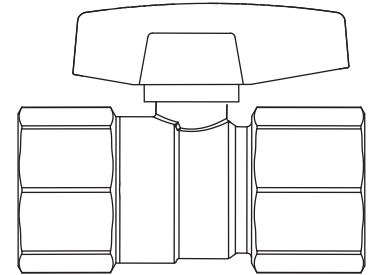

Operating Specifications:

Temperature: -40° - 125° F*
Pressure: 5 PSI maximum

* TBV6F-8, TBV10-12, and TBVA10-12 are rated for 32°-125° F

MATERIAL SPECIFICATIONS	
Valve Body	Forged brass
Retainer	Forged brass
Ball	Brass, chrome plated
Seat	PTFE
Stem	Brass
O-ring	High-temperature rubber
Handle	Aluminum, coated
Screw	Steel, zinc plated

Listings and Certifications:

- CSA listed to ANSI Z21.15 / CSA 9.1, ANSI / ASME B16.44 and CGA CR91-002



PIPE NIPPLES

Use: For use with water, grease, fuels, LP and natural gas, refrigeration, instrumentation, and hydraulic systems in low and medium pressure pipe line connections. Use in combination with brass, copper, and iron pipe.

Design Features:

- **Designed and manufactured** to SAE (Society of Automotive Engineers) thread standards
- **Also meets** ASME and ASA requirements
- **Available** in a broad range of sizes
- **100%** No-lead product available

Operating Specifications:

Temperature: -65°- 250° F
Working Pressure: Up to 1200 PSI
Vibration: Fair resistance to vibration and pipe movement depending on conditions

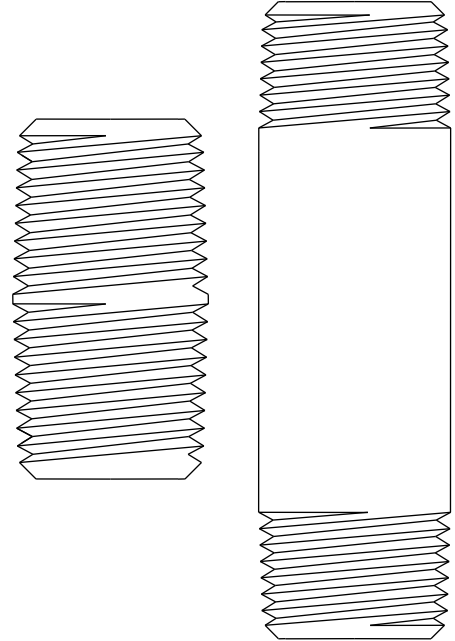
**NIPPLE MATERIAL SPECIFICATIONS**

Nipple	Yellow or No-lead brass
---------------	-------------------------

Listings & Certifications:

- No-lead product CSA listed to NSF 372 (Class 6853-01)



✓ **No Lead**

COMPRESSION FITTINGS

Use: For use only with potable water, instrumentation, hydraulic, and pneumatic systems. Designed for use with aluminum, copper, and plastic tubing. Not intended for use with steel tubing.

* Plastic tubing requires a plastic insert and sleeve (see 60PT & 63PT).

Design Features:

- **Little to no tube preparation.** Compression fittings do not require flaring, soldering, or other types of tube preparation
- **Available in** a broad range of sizes
- **100%** No-lead product available

Operating Specifications:

Temperature: -65° - 250° F at maximum operating pressures
Working Pressure: See chart below
Vibration: Fair vibration resistance

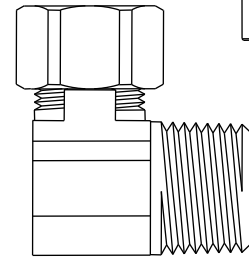
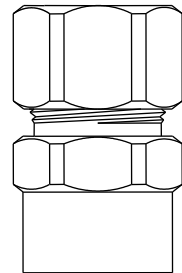
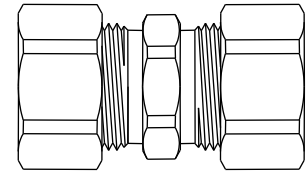

WORKING PRESSURE		
PSI	Tube OD	Tube Wall (Inches)
400	1/8	0.030
400	3/16	0.030
300	1/4	0.030
300	5/16	0.032
200	3/8	0.032
200	1/2	0.032
150	5/8	0.035
100	3/4	0.035
75	7/8	0.035

Standard Product

FITTING MATERIAL SPECIFICATIONS	
Fitting Body	Brass
Compression Sleeve	Brass
Compression Nut	Brass
Option	Chrome plating

No-lead Product

FITTING MATERIAL SPECIFICATIONS	
Fitting Body	No-lead brass
Compression Sleeve	Brass
Compression Nut	Brass

Listings & Certifications:

- No-lead product CSA listed to NSF 372 (Class 6853-01)



CPVC TRANSITION FITTINGS

Use: For use with water, grease, fuels, LP and natural gas, refrigeration, instrumentation, and hydraulic systems in low and medium pressure pipe line connections. Use in combination with brass, copper, and iron pipe.

Design Features:

- **Designed and manufactured** to SAE (Society of Automotive Engineers) thread standards
- **Also meets** ASME and ASA requirements
- **Available in** a broad range of sizes
- **100% No-lead** product available

Operating Specifications:

Temperature:	See Catalog
Working Pressure:	Up to 400 PSI – See Catalog
Vibration:	Fair resistance to vibration and pipe movement depending on conditions

Standard Product**No-lead Product**

FITTING MATERIAL SPECIFICATIONS	
Fitting Body	Brass
CPVC Insert	CPVC
CPVC Washer	Rubber
CPVC Nut	Brass
Compression Sleeve	Brass
Compression Nut	Brass

FITTING MATERIAL SPECIFICATIONS	
Fitting Body	No-lead brass
CPVC Insert	CPVC
CPVC Washer	Rubber
CPVC Nut	Brass
Compression Sleeve	Brass
Compression Nut	Brass

Standard Product**No-lead Product**

FITTING MATERIAL SPECIFICATIONS	
Fitting Body	Brass
CPVC Insert	CPVC
CPVC Washer	Rubber
CPVC Nut	Brass

FITTING MATERIAL SPECIFICATIONS	
Fitting Body	No-lead brass
CPVC Insert	CPVC
CPVC Washer	Rubber
CPVC Nut	Brass

Listings & Certifications:

- No-lead product CSA listed to NSF 372 (Class 6853-01)



✓ **No Lead**

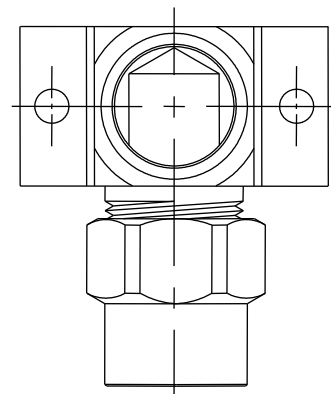
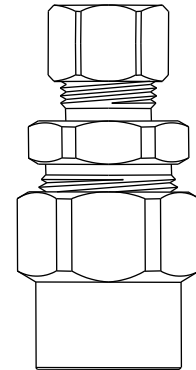

GARDEN HOSE FITTINGS

Use: For use with residential and commercial grade garden hose. All female hose thread connections require a rubber washer inserted prior to installation.

Design Features:

- Available in a broad range of configurations
- 100% No-lead product available

Operating Specifications:

Temperature: -35° - 100°F at maximum operating pressures

Working Pressure: 75 PSI maximum, intermittent to 150 PSI

Standard Product

FITTING MATERIAL SPECIFICATIONS	
Fitting Body	Brass
Hose Washer	Rubber

No-lead Product

FITTING MATERIAL SPECIFICATIONS	
Fitting Body	No-lead brass
Hose Washer	Rubber

Listings & Certifications:

- No-lead product CSA listed to NSF 372 (Class 6853-01)

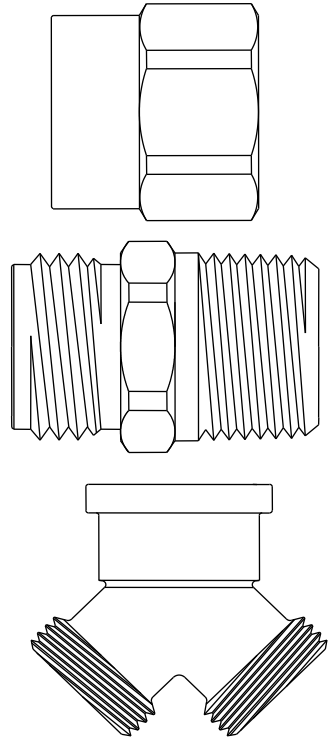

PART NO.	PAGE	PART NO.	PAGE	PART NO.	PAGE
10X CD.....	28	BC8472.....	55	CR1901DVX CD.....	12
1-12A CH.....	15	BC8473.....	55	CR1901LRX RD.....	13
1-12DL CF.....	15	BC8480.....	55	CS40BX CD.....	11
1-12DL CH.....	15	BC8481.....	56	CS41BX CD.....	11
113-06-4-CX D.....	26	BC8482.....	56	CSSB21-24 P.....	43
113-06-6-CX D.....	26	BC8483.....	55	CSSC12R-24 P.....	40
113-08-3-CX D.....	26	BC8491.....	56	CSSC12R-36 P.....	40
113-08-4-CX D.....	26	BC8492.....	56	CSSC12R-48 P.....	40
11X CD.....	28	BC8493.....	56	CSSC12R-60 P.....	40
1-20A CF.....	15	BC8500.....	55	CSSC12R-72 P.....	40
1-20A CH.....	15	BC8501.....	56	CSSC14-24 P.....	44
1-20DL CF.....	15	BC8502.....	56	CSSC14-36 P.....	44
1-20DL CH.....	15	BC8503.....	56	CSSC14-48 P.....	44
12X CD.....	28	BC8510.....	57	CSSC14-60 P.....	44
1-36A CH.....	15	BC8511.....	57	CSSC14-72 P.....	44
13X CD.....	28	BC96X.....	14	CSSC21-24 P.....	44
14X CD.....	28	BC97X.....	14	CSSC21-36 P.....	44
462-6-6-1X CD.....	28	BCRP01 D.....	32	CSSC21-48 P.....	44
462-8-6-1X CD.....	28	BCRP02 D.....	33	CSSC21-60 P.....	44
63-6-8WX CD.....	28	BCSR01.....	32	CSSC21-72 P.....	44
66-6-8WX CD.....	28	BL12-48WA P.....	20	CSSC21R-48 P.....	40
69-6-6X CD.....	28	BL12-60WA P.....	20	CSSC22-24 P.....	43
8489 CD.....	32	BL12-60WA P2.....	20	CSSC22-36 P.....	43
AU6-8-6 P.....	53	BL12-72WA B.....	20	CSSC22-48 P.....	43
AU7-10-8 P.....	53	BL12-72WA P.....	20	CSSC22-60 P.....	43
B0-120IM P.....	21	BL3-48DW F.....	21	CSSC22-72 P.....	43
B0-12IM F.....	21	BL3-60DW F.....	21	CSSC22R-24 P.....	40
B0-60IM P.....	21	BL3-72DW F.....	21	CSSC22R-36 P.....	40
B0-72IM P.....	21	BWB0-12.....	34	CSSC22R-48 P.....	40
B0-96IM P.....	21	BWB0-15.....	34	CSSC22R-60 P.....	40
B1-12DLU D.....	20	BWB0-18.....	34	CSSC23-48 P.....	44
B1-20AU D.....	19	BWB0-18PX.....	34	CSSC25-36 P.....	44
B1-48DW12 P.....	20	BWB0-24.....	34	CSSC25-48 P.....	44
B1-48DW6 P.....	20	BWB05-18.....	34	CSSC44-24 P.....	44
B1-60DW1 P.....	21	BWB08-12.....	34	CSSC44-36 P.....	44
B1-60DW6 P.....	20	BWB08-18.....	34	CSSC44-48 P.....	44
B1-72DW F.....	20	BWB08-24.....	34	CSSC44-60 P.....	44
B1-72DW6 P.....	20	BWB20-12.....	35	CSSC44-72 P.....	44
B1U-48DW612 D.....	20	BWB20-15.....	35	CSSC44R-18 P.....	40
B1U-72DW612 D.....	20	BWB20-18.....	35	CSSC44R-24 P.....	40
B8-60DW6 P.....	21	BWB20-24.....	35	CSSC44R-36 P.....	40
BC203.....	56	BWB25-18.....	35	CSSC44R-48 P.....	40
BC2456.....	23	BWB28-18.....	35	CSSC44R-60 P.....	40
BC2466 L.....	14	BWB28-24.....	35	CSSC45R-24 P.....	40
BC8470.....	55	C14X CD.....	28	CSSC45R-36 P.....	40
BC8471.....	55	CR1900DVX C.....	12	CSSC45R-48 P.....	40

PART NO.	PAGE	PART NO.	PAGE	PART NO.	PAGE
CSSC45R-60 P	40	CSSDNN-70N	46	CSSTNN-34N	47
CSSC54-24 P	44	CSSL115R-24 P	41	CSSTNN-34N P	47
CSSC54-36 P	44	CSSL115R-36 P	41	CSSTNN-46N	47
CSSC54-48 P	44	CSSL44R-24 P	42	CSSTNN-46N P	47
CSSC54-60 P	45	CSSL44R-36 P	42	CSSTNN-58N	47
CSSC54-72 P	45	CSSL44R-48 P	42	CSSTNN-58N P	47
CSSC55-24 P	44	CSSL44R-60 P	42	CSSTNN-70N	47
CSSC55-36 P	44	CSSL45R-12 P	42	CSSTNN-70N P	47
CSSC91R-36 P	41	CSSL45R-18 P	42	CT2-664X D	28
CSSC91R-48 P	41	CSSL45R-24 P	42	CT2-664X P	28
CSSCNN-16N	45	CSSL45R-36 P	42	CT2-666X D	28
CSSCNN-22N	45	CSSL45R-48 P	42	CT2-666X P	28
CSSCNN-28N	45	CSSL45R-60 P	42	DD6000	57
CSSCNN-34N	45	CSSL45R-72 P	42	DIH824	57
CSSCNN-46N	45	CSSL47R-24 P	42	G23301X CD	7
CSSCNN-58N	45	CSSL47R-36 P	42	G23305X CD	8
CSSD105R-36 P	41	CSSL47R-48 P	42	G23341X CD	7
CSSD105R-48 P	41	CSSL47R-60 P	42	G23345X CD	7
CSSD44R-12 P	41	CSSL54-12 P	46	G2CR09X CD	7
CSSD44R-18 P	41	CSSL54-18 P	46	G2CR11X CD	7
CSSD44R-24 P	41	CSSL54-24 P	46	G2CR14X CD	7
CSSD44R-36 P	41	CSSL54-30 P	46	G2CR19X CD	7
CSSD44R-48 P	41	CSSL54-36 P	46	G2CR34X CD	7
CSSD44R-60 P	41	CSSL54-48 P	46	G2CR39X CD	7
CSSD44R-72 P	41	CSSL54-60 P	46	G2PR14X CD	8
CSSD45R-12 P	41	CSSL54-72 P	46	G2PR19X CD	8
CSSD45R-18 P	41	CSSL87-24 P	46	G2PS14B120DLX F	24
CSSD45R-24 P	41	CSSL87-36 P	46	G2PS14B200HX F	24
CSSD45R-36 P	41	CSSL87-48 P	46	G2PS14X CD	8
CSSD45R-48 P	41	CSSL87-60 P	46	G2PS19B120DLX D	24
CSSD45R-60 P	41	CSSLNN-10N	46	G2PS19B120DLX F	24
CSSD45R-72 P	41	CSSLNN-16N	46	G2PS19B200AX F	24
CSSD54-12 P	45	CSSLNN-22N	46	G2PS19B200HX D	24
CSSD54-18 P	45	CSSLNN-28N	46	G2PS19X CD	8
CSSD54-24 P	45	CSSLNN-34N	46	G2R07X CD	7
CSSD54-36 P	45	CSSLNN-46N	46	G2R10X CD	7
CSSD54-48 P	45	CSSLNN-58N	46	G2R12X CD	7
CSSD54-60 P	45	CSSLNN-70N	46	G2R15X CD	7
CSSD54-72 P	45	CSSTNN-10N	47	G2R17X CD	7
CSSDNN-10N	45	CSSTNN-10N P	47	G2R37X CD	7
CSSDNN-16N	45	CSSTNN-16N	47	HES-6-12WNMX D	31
CSSDNN-22N	45	CSSTNN-16N P	47	HES-6-12X	31
CSSDNN-28N	45	CSSTNN-22N	47	HES-6-12X B	31
CSSDNN-34N	45	CSSTNN-22N P	47	HES-6-12X D	31
CSSDNN-46N	45	CSSTNN-28N	47	HES-8-12X	31
CSSDNN-58N	45	CSSTNN-28N P	47	LBV12	50

PART NO.	PAGE	PART NO.	PAGE	PART NO.	PAGE
LBV8.....	50	PS43	33	PSC1085X L	49
M40-10 P	52	PS612X	31	PSC1094 L	54
MAU1-10-12 K5	52	PS8024	57	PSC1098 L	49
MAU1-10-12S	52	PS838	19	PSC1106 K5	48
MAU1-10-8 K5	52	PS8754	25	PSC1107 K5	49
MAU1-10-8S	52	PSB1096 L	49	PSC1108X L	49
MAU2-10-12 K5	52	PSB130	22	PSCFT-10	52
MAU2-10-12S	52	PSB132	22	PSCFT-11	52
MAU2-10-8 K5	52	PSB136	22	PSFT-12	52
MAU2-10-8S	52	PSB138	22	PSSC-60.....	50
NV105-4X D.....	14	PSB141	22	PSSC-61.....	51
OCR14X C1	10	PSB143	22	PSSC-62.....	52
OCR19X C1	10	PSB145	22	PSSC-63.....	53
OFR12X C1	10	PSB155	22	PSSC-64.....	53
OFR17X CD.....	10	PSB156	22	PSSC-65.....	53
OR32X CD.....	10	PSB157	22	PSSC-66.....	52
P1-12A.....	15	PSB168	22	PSSC-68.....	50
P1-12A H.....	15	PSB171	22	PSSD-41.....	51
P1-12DL.....	15	PSB173	22	PSSD-42.....	52
P1-12DL F	15	PSB175	22	PSSD-43.....	53
P1-12DL H.....	15	PSB177	22	PSSD-44.....	53
P1-20A.....	15	PSB830	19	PSSL-12	51
P1-20DL.....	15	PSB832	19	PSSL-13	52
P1-20DL F	15	PSB833	20	PSSL-14	53
P1-30A.....	15	PSB836	19	PSSL-15.....	52
P1-36A.....	15	PSB838	19	PSSL-16.....	53
P1-36A H.....	15	PSB840	19	R14X CD.....	10
P14CX CD.....	30	PSB846	19	R15-10T CD.....	33
P19CX CD.....	30	PSB855	19	R15-5.....	33
P44CX RD.....	30	PSB856	19	R15-9 CD	32
P48WX RD.....	30	PSB857	19	R1700DVX RD.....	12
P77CX RD.....	30	PSB858	19	R1700RX RD.....	13
P81.....	28	PSB860	19	R1701DVX RD.....	12
P89.....	33	PSB863	19	R1701LRX RD.....	13
PCT-10-6.....	8	PSB866	19	R19X CD.....	10
PNEV-NCVX D	14	PSB873	19	R3701RX RD.....	13
PS1087	54	PSB877	19	R3703LRX RD.....	13
PS1087 XL.....	54	PSBV503-12.....	50	S126624	43
PS136	22	PSBV503-8.....	50	S126636	43
PS138	22	PSC00-12.....	36	S126648	43
PS30	32	PSC00-15.....	36	S15-10 CD.....	32
PS31	32	PSC00-18.....	36	ST1-SS4X D.....	29
PS32	32	PSC00-24.....	36	ST1-SS6X D.....	29
PS33	32	PSC034-18.....	36	SWB00-12N.....	38
PS34	32	PSC034-24.....	37	SWB00-15N.....	38
PS40	32	PSC1079	48	SWB00-18N.....	38

PART NO.	PAGE	PART NO.	PAGE	PART NO.	PAGE
SWB00-24N.....	38				
TBV10-12.....	50				
TBV10-8.....	51				
TBV12.....	50				
TBV16.....	50				
TBV6-8.....	51				
TBV6F-8.....	51				
TBV8.....	50				
TBV8-8.....	51				
TBVA10-12.....	51				
TBVF6.....	51				
WB00-12N.....	36				
WB00-15N.....	36				
WB00-18N.....	36				
WB00-24N.....	36				
WB034-12N.....	37				
WB034-15N.....	37				
WB034-18N.....	36				
WB034-24N.....	37				
WB07-18.....	37				
WB27-18.....	37				
WWCD.....	33				
X15-10 CD.....	32				



BrassCraft®



Brasscraft Manufacturing Co.
39600 Orchard Hill Place
Novi, Michigan 48375-5331
TOLL-FREE: (877) 272-7755
FAX: (248) 305-6011

350 South Edgeware Road
St. Thomas, Ontario Canada N4P 4C4
TOLL-FREE: (800) 265-4322
FAX: (800) 567-9100