

# DRILLING AND FASTENING

# SCREW GUNS

FEEL THE DIFFERENCE. SEE THE RESULTS.



DRILLING AND FASTENING  
SCREW GUNS

Center of Gravity

1"

**APPROXIMATELY 1" SHORTER**

**COMPACT DESIGN**  
Provides better tool balance and improved comfort when driving screws all day

64 mm

64 mm

Bosch

Leading Competitor

Pressure

**ERGONOMIC GRIP**  
Contoured grip is designed to maximize comfort and minimize fatigue with evenly distributed pressure

**LOCKING DETENTS**

**POSI-LOK™ NOSE PIECE**  
Unique nose piece design is both easy to use and remove, and securely locks the depth setting when removed

## TEK SCREW GUN SG250



- ▶ Compact Ergonomic Design—Contoured grip increases comfort and control to drive screws all day
- ▶ Posi-Lok™ Nose Piece Design—Retains depth setting when removed and eliminates time-consuming depth readjustments
- ▶ High-Torque Gearbox—For driving screws into hardwoods and engineered materials
- ▶ Interchangeable Drywall and TEK Nose Piece/Depth Controls—Versatility for multiple jobs with a single tool

### INCLUDES

- 3" Bit Tip Holder **3603008500**
- #2 Phillips® Tip **2608674975**
- Drywall Posi-Lok™ Nose Piece/Depth Control **2600460049**
- TEK Posi-Lok™ Nose Piece/Depth Control **2600460050**

Specifications	
Rating	120V
Amperage	7.0
No Load RPM	2,500
Torque	177 in.-lbs.
Length	11-5/8"
Weight	3.3 lbs.



## DRYWALL SCREW GUN SG450



Cordless option available on pages 99 and 128.



- ▶ Compact Ergonomic Design—Contoured grip increases comfort and control to drive screws all day
- ▶ Posi-Lok™ Nose-Piece Design—Retains depth setting when removed and eliminates time-consuming depth readjustments
- ▶ Plastic Gear Housing—Provides improved balance and lightweight design
- ▶ Strong Bit Tip Magnet—Maximizes control when driving long screws

### INCLUDES

3" Bit Tip Holder **3603008500**  
 #2 Phillips® Tip **2608674975**  
 Drywall Posi-Lok™ Nose Piece/Depth Control **2600460049**

### Specifications

<b>Rating</b>	120V
<b>Amperage</b>	7.0
<b>No Load RPM</b>	4,500
<b>Torque</b>	106 in.-lbs.
<b>Length</b>	11-5/8"
<b>Weight</b>	3.1 lbs.

## AUTO-FEED ATTACHMENT MA55



- ▶ Enhances the efficiency of Bosch drywall screw guns
- ▶ Enables precise driving of rows of screws at top speed
- ▶ For use with Bosch SGH182, SG450 and SG250 screw guns
- ▶ For use with widely-distributed strips of collated screws with lengths between 1" and 2-1/8" (25mm and 55mm), screw shank diameters up to 0.2" (5mm), and screw head diameters up to 3/8" (9.5mm)

### INCLUDES

SG450P2 P2R Long Phillips® Screwdriving Bit

### Specifications

<b>Height</b>	4.75"
<b>Length</b>	7.9"
<b>Weight</b>	0.88 lbs.

## SCREW SETTING ACCESSORIES



D60498

Dimpler® for professional screw setting precision if a screw gun is not available.

NOTE: For use with a drill only. Do not use with an impact driver.

Item #	Description
<b>D60498</b>	Dimpler® drywall driver
<b>DWS2</b>	Drywall insert bit
<b>DWS60497</b>	Drywall screw setter, #2 Phillips®



**BOSCH**  
Invented for life

# DRILLS AND DRILL/MIXER



## DRILLING AND FASTENING CORDED DRILLS



3/8" CORDED DRILL  
**1006VSR**



- ▶ One-Handed Keyless Chuck—For quick, easy and secure accessory changes
- ▶ Excellent Power-to-Weight Ratio—Maximum power at minimum weight
- ▶ Ergonomic Handle with Soft Grip—For increased comfort
- ▶ Two-Finger Trigger with Lock-On—For ease of operation

Specifications	
<b>Rating</b>	120V
<b>Amperage</b>	6.3
<b>No Load RPM</b>	0–2,600
<b>Torque</b>	177 in.-lbs.
<b>Chuck</b>	3/8"
<b>Length</b>	10.1"
<b>Weight</b>	3.4 lbs.





## 5/8" MIXER

### GBM9-16

**NEW**



- ▶ Variable-speed Motor—Provides high-torque power to match speed to mixing application
- ▶ Powerful 9.0-amp Motor—Generates outstanding torque for mixing materials such as cement plaster and epoxy resin
- ▶ Rotatable 360° D Handle—Allows user to hold the mixer in the best position
- ▶ Heavy-duty Keyed Chuck—Supports a wide variety of accessories
- ▶ Variable-speed and Reversing Switch—For greater user control

#### INCLUDES

Auxiliary Handle **1619PA7850**  
 Chuck Key **2610348635**

#### Specifications

<b>Rating</b>	120V
<b>Amperage</b>	9.0
<b>No Load RPM</b>	0-700
<b>Torque</b>	82 in.-lbs.
<b>Chuck Size</b>	5/8"
<b>Stirrer Capacity</b>	5/8"
<b>Weight</b>	6.6 lbs.



**DRILLING AND FASTENING**  
**CORDED DRILLS**



**BOSCH**  
 Invented for life

## 1/2" HIGH-TORQUE DRILL

### 1033VSR



- ▶ Heavy-Duty Keyed Chuck—For increased durability
- ▶ Ergonomic Handle with Soft Grip—For increased comfort
- ▶ Two-Finger Trigger with Lock-On—For ease of operation
- ▶ Variable-Speed Trigger with Reverse Switch—For greater control

#### INCLUDES

Auxiliary Handle **2602025094**  
Chuck Key **2610348635**

Specifications	
Rating	120V
Amperage	8.0
No Load RPM	0-850
Torque	472 in.-lbs.
Spindle Size	1/2"-20
Maximum Hole Diameter in Wood: Paddle Bit	1-1/2"
Maximum Hole Diameter in Wood: Self-Feed Bit	2-9/16"
Maximum Hole Diameter in Wood: Hole Saw	3-5/8"
Maximum Hole Diameter in Wood: Auger Bit	1-1/2"
Maximum Hole Diameter in Steel: Twist Drill Bit	1/2"
Maximum Hole Diameter in Steel: Hole Saw	2-1/2"
Length	11.1"
Weight	5.3 lbs.



## DRILLING AND FASTENING CORDED DRILLS

## 1/2" HIGH-TORQUE DRILL

### 1034VSR



- ▶ Heavy-Duty Keyed Chuck—For increased durability
- ▶ Ergonomic Handle with Soft Grip—For increased comfort
- ▶ Two-Finger Trigger with Lock-On—For ease of operation
- ▶ Variable-Speed Trigger with Reverse Switch—For greater control

#### INCLUDES

Auxiliary Handle **2602025094**  
Chuck Key **2610348635**

Specifications	
Rating	120V
Amperage	8.0
No Load RPM	0-550
Torque	767 in.-lbs.
Spindle Size	1/2"-20
Maximum Hole Diameter in Wood: Paddle Bit	1-1/2"
Maximum Hole Diameter in Wood: Self-Feed Bit	2-9/16"
Maximum Hole Diameter in Wood: Hole Saw	4-1/2"
Maximum Hole Diameter in Wood: Auger Bit	1-1/2"
Maximum Hole Diameter in Steel: Twist Drill Bit	1/2"
Maximum Hole Diameter in Steel: Hole Saw	3"
Length	11.1"
Weight	5.3 lbs.

# WOOD DRILLING ACCESSORIES

## Wood Drilling Selection Guide

Bit Type	Application	Speed	Hole Quality	Durability (Hits Nails)
Daredevil® Spade Bits	Fast drilling in wood	●	⦿	○
Daredevil® Auger Bits	Heavy-duty drilling in thick wood with nails	⦿	●	●
Self-Feed Bits	Fast, large diameter rough-in for electrical and plumbing	●	○	⦿
Bellhanger Bits	Low-voltage wiring installation. Use flute hole for wire pulling	⦿	●	○
Brad Point Bits	Precise, small diameter hole making	⦿	●	○
Forstner Bits	Precise flat-bottom holes	⦿	●	○
Hinge Boring Bits	Precise, small diameter holes in cabinetry	⦿	●	○

●=Recommended ⦿=Acceptable ○=Not Recommended



**DRILLING AND FASTENING**  
WOOD DRILLING ACCESSORIES



**BOSCH**  
Invented for life



# Daredevil®



**DRILLING AND FASTENING**  
WOOD DRILLING ACCESSORIES



## DARE TO BE...BEST IN CLASS

Bosch Daredevil® brand power tool accessories are designed to answer the needs of electricians, plumbers and other professional tradesmen. Based on independent testing, Bosch ensures that each Daredevil accessory is market best in speed, ease of use or durability—or it's not a Daredevil.

The key to this best-in-class performance is found in a commitment to use premium materials and incorporating patented designs and advanced engineering. No power tool accessory manufacturer does more to ensure users experience the benefit of a superior power tool accessory:

- ▶ Saving up to 30-minutes a day on the job
- ▶ Better finish quality on every task
- ▶ Maximum sharpness for teeth and cutting surfaces

Bosch Daredevil is dedicated to saving time and money. Dare to put improved accessory performance in your tool box with Daredevil.



# DARE TO DRILL FASTER

UP TO 10× FASTER  
IN WOOD

 **Daredevil.**



Daredevil® spade bits lead the industry in speed, ease of use and hole quality for good reason—because trade professionals demand it. While other bits may come with standard tip threads, Bosch has incorporated a full-cone threaded tip that increases both bit speed and drilling ease.

Then there's the Daredevil contoured paddle. The wave shape improves chip removal to further increase bit speed. And a Bosch-exclusive spur and reamer design not only scores the wood for clean hole entry, but offers angled cutting edges for reduced breakout.

Bosch Daredevil. Dare to drill faster.



**BOSCH**  
Invented for life



## DARE TO DRILL FASTER

Bosch Daredevil® spade bits offer superior performance versus any other spade bit



DRILLING AND FASTENING  
WOOD DRILLING ACCESSORIES

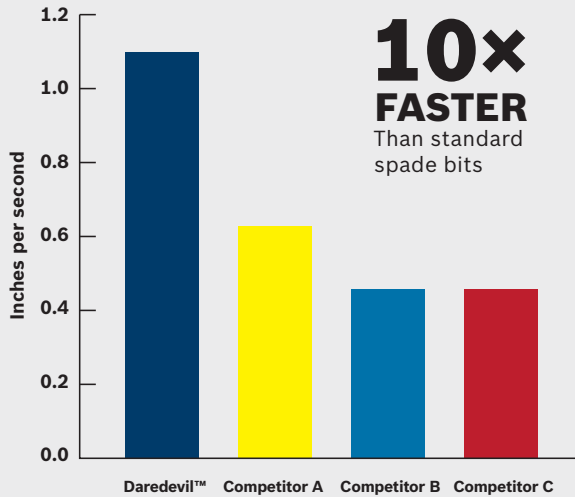

### WHAT USERS SAY ABOUT DAREDEVIL SPADE BITS

★★★★★ Anonymous  
"Whoa Nelly!"

As a builder and remodeler for 30 years, I have seen products evolve and witnessed many "better mouse traps." Often disappointed by bits and blades wearing out quickly or just plain failing, I was pleasantly surprised by the tough build and aggressive performance of this spade bit.

Traditional spade bits require a push to do their job, but the DSB dives right in and you just go along for the ride. That's great news for us "more seasoned" tradesmen.

Thanks Bosch!!

⊕ **Pros: High quality, durable, makes work easier, faster holes**  
⊖ **Yes, I recommend this product.**

Originally posted on DSB1009

from boschtools.com

**SPUR AND REAMER**  
Provide cleaner holes

**SPEEDWAVE™ PADDLE**  
For faster chip removal

**HEX SHANK WITH POWER GROOVE**  
Reduces slippage

**FULLTHREAD™ TIP**  
For fast and effortless drilling

Available in 4" stubby for tight spaces and 16" extra long for overhead work

\*Based on independent testing vs. standard spade bit

## DAREDEVIL® SPADE BITS

Item #	Diameter	Overall Length	Qty.	Bulk Item #	Bulk Qty.
DSBS1003	3/8"	4"	5	DSBS1003B	60
DSBS1005	1/2"	4"	5	DSBS1005B	60
DSBS1007	5/8"	4"	5	DSBS1007B	60
DSBS1009	3/4"	4"	5	DSBS1009B	50
DSBS1011	7/8"	4"	5	DSBS1011B	50
DSBS1013	1"	4"	5	DSBS1013B	40
DSBS1015	1-1/8"	4"	5	DSBS1015B	40
DSBS1017	1-1/4"	4"	5	DSBS1017B	40
DSBS1021	1-1/2"	4"	5	DSBS1021B	30
DSB1001	1/4"	6"	5	DSB1001B	60
DSB1002	5/16"	6"	5	DSB1002B	60
DSB1003	3/8"	6"	5	DSB1003B	50
DSB1004	7/16"	6"	5	DSB1004B	50
DSB1005	1/2"	6"	5	DSB1005B	50
DSB1006	9/16"	6"	5	DSB1006B	50
DSB1007	5/8"	6"	5	DSB1007B	50
DSB1008	11/16"	6"	5	DSB1008B	40
DSB1009	3/4"	6"	5	DSB1009B	40
DSB1010	13/16"	6"	5	DSB1010B	40
DSB1011	7/8"	6"	5	DSB1011B	40
DSB1012	15/16"	6"	5	DSB1012B	30
DSB1013	1"	6"	5	DSB1013B	30
DSB1015	1-1/8"	6"	5	DSB1015B	25
DSB1017	1-1/4"	6"	5	DSB1017B	25
DSB1019	1-3/8"	6"	5	DSB1019B	20
DSB1021	1-1/2"	6"	5	DSB1021B	20
DLSB1003	3/8"	16"	5	DLSB1003B	30
DLSB1005	1/2"	16"	5	DLSB1005B	30
DLSB1007	5/8"	16"	5	DLSB1007B	30
DLSB1009	3/4"	16"	5	DLSB1009B	30
DLSB1011	7/8"	16"	5	DLSB1011B	30
DLSB1013	1"	16"	5	DLSB1013B	30

## DAREDEVIL® QUICK CHANGE™ EXTENSIONS

Item #	Description	Qty.
DQCE1006	6" extension	5
DQCE1012	12" extension	1

## DAREDEVIL® SPADE BIT SETS

Item #	# of Pieces	Includes	Case Type
DSB5003	3	(1) 1/2" x 6", (1) 3/4" x 6", (1) 1" x 6"	—
DSB5005	6	(1) 3/8" x 6", (1) 1/2" x 6", (1) 5/8" x 6", (1) 3/4" x 6", (1) 7/8" x 6", (1) 1" x 6" plus 6" extension	—
DSB5006	6	(1) 3/8" x 6", (1) 1/2" x 6", (1) 5/8" x 6", (1) 3/4" x 6", (1) 7/8" x 6", (1) 1" x 6"	—
DSB5006P	6	(1) 3/8" x 6", (1) 1/2" x 6", (1) 5/8" x 6", (1) 3/4" x 6", (1) 7/8" x 6", (1) 1" x 6"	Pouch
DSB5008P	8	(1) 3/8" x 6", (1) 1/2" x 6", (1) 5/8" x 6", (1) 3/4" x 6", (1) 7/8" x 6", (1) 1" x 6", (1) 1-1/8" x 6", (1) 1-1/4" x 6"	Pouch
DSB5013P	13	(1) 1/4" x 6", (1) 3/8" x 6", (1) 1/2" x 6", (1) 9/16" x 6", (1) 5/8" x 6", (1) 11/16" x 6", (1) 3/4" x 6", (1) 7/8" x 6", (1) 1" x 6", (1) 1-1/8" x 6", (1) 1-1/4" x 6", (1) 1-3/8" x 6", (1) 1-1/2" x 6"	Pouch
DSB5010	10	(1) 3/8" x 6", (1) 1/4" x 6", (1) 1/2" x 6", (1) 5/8" x 6", (1) 3/4" x 6", (1) 9/16" x 6", (1) 7/8" x 6", (1) 1" x 6", (1) 1-1/8" x 6", (1) 1-1/4" x 6"	—
DSBS5003	3	(1) 1/2" x 4", (1) 3/4" x 4", (1) 1" x 4"	—
DSBS5007P	6	(1) 1/2" x 4", (1) 5/8" x 4", (1) 3/4" x 4", (1) 7/8" x 4", (1) 1" x 4", (1) 6" extension	Pouch

NOTE: Drill bits (or extension + drill bit) in excess of 8" should never exceed 600 RPM



**DRILLING AND FASTENING**  
WOOD DRILLING ACCESSORIES



**BOSCH**  
Invented for life



# DAREDEVIL® AUGER BITS



**REINFORCED TIP**  
Withstands nail hits

**REAMER EDGE**  
Improves entry- and exit-hole quality

**DUAL CUTTING EDGES**  
Provide easier nail cutting and balanced drilling

**REINFORCED SPINE**  
Adds strength for heavy-duty applications

## 3x LONGER LIFE

\*Based on independent testing vs. standard auger bit

## DAREDEVIL® AUGER BITS

Item #	Diameter	Overall Length	Flute Length	Shank Size	Qty.	Bulk Item #	Bulk Qty.
NKST04	1/4"	7-1/2"	4"	3/16"	1	NKSB04	5
NKST05	5/16"	7-1/2"	4"	1/4"	1	NKSB05	5
NKST06	3/8"	7-1/2"	4"	1/4"	1	NKSB06	5
NKST07	7/16"	7-1/2"	4"	1/4"	1	NKSB07	5
NKST08	1/2"	7-1/2"	4"	5/16"	1	NKSB08	5
NKST09	9/16"	7-1/2"	4"	7/16"	1	NKSB09	5
NKST10	5/8"	7-1/2"	4"	7/16"	1	NKSB10	5
NKST11	11/16"	7-1/2"	4"	7/16"	1	NKSB11	5
NKST12	3/4"	7-1/2"	4"	7/16"	1	NKSB12	5
NKST13	13/16"	7-1/2"	4"	7/16"	1	NKSB13	5
NKST14	7/8"	7-1/2"	4"	7/16"	1	NKSB14	5
NKST15	15/16"	7-1/2"	4"	7/16"	1	NKSB15	5
NKST16	1"	7-1/2"	4"	7/16"	1	NKSB16	5
NKST18	1-1/8"	7-1/2"	4"	7/16"	1	NKSB18	3
NKST20	1-1/4"	7-1/2"	4"	7/16"	1	NKSB20	3
NKST22	1-3/8"	7-1/2"	4"	7/16"	1	NKSB22	3
NKST24	1-1/2"	7-1/2"	4"	7/16"	1	NKSB24	3
NKMT06	3/8"	13"	9"	1/4"	1	—	—
NKMT07	7/16"	13"	9"	1/4"	1	—	—
NKMT08	1/2"	13"	9"	5/16"	1	—	—
NKMT09	9/16"	13"	9"	7/16"	1	—	—
NKMT10	5/8"	13"	9"	7/16"	1	—	—
NKMT11	11/16"	13"	9"	7/16"	1	—	—
NKMT12	3/4"	13"	9"	7/16"	1	—	—
NKMT13	13/16"	13"	9"	7/16"	1	—	—
NKMT14	7/8"	13"	9"	7/16"	1	—	—
NKMT15	15/16"	13"	9"	7/16"	1	—	—
NKMT16	1"	13"	9"	7/16"	1	—	—
NKMT18	1-1/8"	13"	9"	7/16"	1	—	—
NKMT20	1-1/4"	13"	9"	7/16"	1	—	—
NKMT22	1-3/8"	13"	9"	7/16"	1	—	—
NKMT24	1-1/2"	13"	9"	7/16"	1	—	—
NKLT06	3/8"	17-1/2"	13-1/2"	1/4"	1	NKLB06	5
NKLT07	7/16"	17-1/2"	13-1/2"	1/4"	1	NKLB07	5
NKLT08	1/2"	17-1/2"	13-1/2"	5/16"	1	NKLB08	5
NKLT09	9/16"	17-1/2"	13-1/2"	7/16"	1	NKLB09	5
NKLT10	5/8"	17-1/2"	13-1/2"	7/16"	1	NKLB10	5
NKLT11	11/16"	17-1/2"	13-1/2"	7/16"	1	NKLB11	5
NKLT12	3/4"	17-1/2"	13-1/2"	7/16"	1	NKLB12	5
NKLT13	13/16"	17-1/2"	13-1/2"	7/16"	1	NKLB13	5
NKLT14	7/8"	17-1/2"	13-1/2"	7/16"	1	NKLB14	5
NKLT15	15/16"	17-1/2"	13-1/2"	7/16"	1	NKLB15	5
NKLT16	1"	17-1/2"	13-1/2"	7/16"	1	NKLB16	5
NKLT17	1-1/16"	17-1/2"	13-1/2"	7/16"	1	NKLB17	3
NKLT18	1-1/8"	17-1/2"	13-1/2"	7/16"	1	NKLB18	3
NKLT20	1-1/4"	17-1/2"	13-1/2"	7/16"	1	NKLB20	3
NKLT22	1-3/8"	17-1/2"	13-1/2"	7/16"	1	NKLB22	3
NKLT24	1-1/2"	17-1/2"	13-1/2"	7/16"	1	NKLB24	3

## DAREDEVIL® AUGER BIT SET

Item #	# of Pieces	Includes	Case Type
NKST5003	3	(1) 5/8" x 7-1/2", (1) 3/4" x 7-1/2", (1) 1" x 7-1/2"	—

NOTE: Drill bits (or extension + drill bit) in excess of 8" should never exceed 600 RPM



## SELF-FEED BITS

These Bosch bits are designed for the professional plumber and electrician who need to make large, rough holes in wood.

Each bit features:

- ▶ 7/16" hex shank for reduced slippage (3" and larger three-flat shank)
- ▶ Chip lifters and spurs that can be resharpened to maximize bit life
- ▶ Deep cutter gullets prevent stalling and provide smoother drilling
- ▶ Replaceable threaded tip and hex key included



Item #	Diameter	Replacement Kit Item #
SF1001	1"	SF5018
SF1121	1-1/8"	SF5018
SF1251	1-1/4"	SF5018
SF1371	1-3/8"	SF5018
SF1501	1-1/2"	SF5018
SF1751	1-3/4"	SF5018
SF2001	2"	SF5018
SF2121	2-1/8"	SF5018
SF2251	2-1/4"	SF5018
SF2561	2-9/16"	SF5018
SF3001	3"	SF5032
SF3621	3-5/8"	SF5032
SF4621	4-5/8"	SF5032

## SELF-FEED BIT EXTENSIONS



Item #	Length	Shank
EX1006	6"	7/16"
EX1012	12"	7/16"

## SELF-FEED BIT REPLACEMENT KITS



Item #	# of Pieces	Includes	Case Type
SF5018	3	(1) screw tip, (1) set screw, (1) 1/8" hex wrench	—
SF5032	3	(1) screw tip, (1) set screw, (1) 5/32" hex wrench	—

## BELL HANGER/INSTALLER BITS

Bosch Bell Hanger bits are made for the professional electrician or low-voltage cable installer.

Each bit features:

- ▶ Hole-in-flute design for fishing cable through drilled holes
- ▶ Three-flat shank for reduced slippage
- ▶ Extra length for deep drilling



Item #	Diameter	Overall Length	Bulk Item #	Bulk Qty.
BH1001	1/4"	12"	BH1001B	6
BH1002	5/16"	12"	BH1002B	6
BH1003	3/8"	12"	BH1003B	6
BH1005	1/2"	12"	BH1005B	6
BH2001	1/4"	18"	BH2001B	6
BH2002	5/16"	18"	BH2002B	6
BH2003	3/8"	18"	BH2003B	6
BH2005	1/2"	18"	BH2005B	6
BH3001	1/4"	24"	—	—
BH3002	5/16"	24"	BH3002B	6
BH3003	3/8"	24"	BH3003B	6
BH3005	1/2"	24"	—	—



**DRILLING AND FASTENING**  
WOOD DRILLING ACCESSORIES



**BOSCH**  
Invented for life

## BRAD POINT BITS

Brad Point bits from Bosch are made to deliver accurate, clean holes every time.

Each bit features:

- ▶ Easy tip positioning and accurate starts
- ▶ Design for both portable drills and drill presses



Item #	Diameter	Shank	Overall Length	Usable Length
B14601	1/8"	1/8"	2-3/4"	1-5/8"
B14602	3/16"	3/16"	3-1/2"	2-5/16"
B14603	1/4"	1/4"	3-5/16"	2-1/4"
B14604	5/16"	5/16"	4-7/16"	2-3/4"
B14605	3/8"	5/16"	5-3/16"	3-1/4"
B14606	7/16"	5/16"	5-9/16"	3-1/2"
B14607	1/2"	5/16"	5-15/16"	3-1/2"
B14609	5/8"	3/8"	7"	4-1/4"

## BRAD POINT BIT SET

Item #	# of Pieces	Includes	Case Type
B14616	5	(1) 1/4", (1) 5/16", (1) 3/8", (1) 7/16", (1) 1/2"	—

## FORSTNER BITS

The Bosch line of Forstner bits produces consistently smooth, flat-bottomed holes.

Item #	Diameter
FB004	1/4"
FB006	3/8"
FB008	1/2"
FB010	5/8"
FB012	3/4"
FB014	7/8"
FB016	1"
FB018	1-1/8"
FB020	1-1/4"
FB022	1-3/8"
FB024	1-1/2"
FB026	1-5/8"
FB028	1-3/4"
FB030	1-7/8"
FB032	2"
FB034	2-1/8"



## HINGE BORING BITS

Hinge Boring bits from Bosch meet European-type hinge specifications.

Each bit features:

- ▶ Centering point and outside scoring tips
- ▶ 10mm shank with locking flat and adjustable screw top for automatic and semi-automatic boring machines
- ▶ Not for use with three-jaw chucks



Item #	Diameter	Description
T15005	5mm	Right twist
T15015	5mm	Left twist
T15008	8mm	Right twist
T15018	8mm	Left twist
T15010	10mm	Right twist
T15110	10mm	Left twist
T15215	15mm	For European-type hinges
T15020	20mm	For European-type hinges
T15025	25mm	For European-type hinges
T15030	30mm	For European-type hinges
T15035	35mm	For European-type hinges
T15040	40mm	For European-type hinges



## FORSTNER BIT SETS



Item #	# of Pieces	Includes	Case Type
FB1600	16	(1) 1/4", (1) 3/8", (1) 1/2", (1) 5/8", (1) 3/4", (1) 7/8", (1) 1", (1) 1-1/8", (1) 1-1/4", (1) 1-3/8", (1) 1-1/2", (1) 1-5/8", (1) 1-3/4", (1) 1-7/8", (1) 2", (1) 2-1/8"	Wood
FB700	7	(1) 1/4", (1) 3/8", (1) 1/2", (1) 5/8", (1) 3/4", (1) 7/8", (1) 1"	Wood

# HOLE SAWS



Bosch provides more innovative features and advanced design in hole saws than any other brand. From the introduction of the first AutoStart™ pilot for diamond drilling to cups that cut more materials—from wood to hard tile—Bosch has the right hole saw solution for virtually any application.

## HOLE SAW SELECTION CHART

	Wood	Drywall	Laminate	Plastic	Fiber Glass	Cement Board	Sheet Metal	Metal	Stainless Steel	Masonry	Ceramic Tile	Porcelain Tile PE5	Stone
<b>HOLE SAWS</b>													
Daredevil® Carbide	●	●	●	●	◐	●	○	○	○	●	●	○	◐
Daredevil® Recessed	●	—	●	●	◐	●	○	○	○	●	●	○	◐
Daredevil® Wood	●	●	◐	◐	○	○	○	○	○	○	○	○	○
Diamond	○	—	○	○	○	○	○	○	○	●	●	●	●
Impact Tough™ Thin Wall	○	—	○	◐	○	○	●	○	○	○	○	○	○
Bi-Metal	●	—	●	●	◐	◐	●	●	●	○	○	○	○
Sheet Metal	○	—	○	◐	○	○	●	●	●	○	○	○	○
<b>PILOT BITS</b>													
High-Speed Steel	●	—	●	●	◐	◐	◐	◐	◐	○	○	○	○
Cobalt	◐	—	◐	◐	◐	◐	●	●	●	○	○	○	○
Carbide Tipped	◐	—	◐	◐	●	●	○	○	○	●	●	○	○
AutoStart™	○	—	○	○	○	○	○	○	○	●	●	●	●

●=Recommended ◐=Acceptable ○=Not Recommended



**DRILLING AND FASTENING**  
HOLE SAWS



**BOSCH**  
Invented for life



# DARE TO DRILL FASTER

UP TO 10× FASTER  
IN WOOD



 **Daredevil.**

The premium carbide teeth on the Bosch Daredevil® Carbide Hole Saw provide greater speed and better results on the job. These hole saws drill up to 10× faster in wood than bi-metal hole saws and they deliver fast, clean holes in multiple materials, including vinyl, wood, drywall, tile, brick, block and cement.



**BOSCH**  
Invented for life



# DAREDEVIL® HOLE SAWS

## DAREDEVIL® CARBIDE HOLE SAWS



**50% DEEPER CUP**  
Drills through thicker materials and makes the job easier

**DAREDEVIL® SPINLOCK™ ARBOR**  
Fits Quick Change™ cups and 1/4" hex pilot bits



**MULTI-MATERIAL PILOT BIT**  
Drills through multiple materials

**PREMIUM CARBIDE TEETH**  
Provide greater speed and longer life for increased productivity on the job

**LARGE GULLETS**  
Facilitates plug removal and quickly clears debris

### DAREDEVIL® CARBIDE HOLE SAWS

Item#	Diameter	Cut Depth	SpinLock™ Universal Arbor	
			Mandrel	Pilot Bit
HMD100	1"	2-3/8"	HSA-MD	HTTCP-C
HMD112	1-1/8"	2-3/8"		HTTCP-C
HMD125	1-1/4"	2-3/8"		HTTCP-C
HMD137	1-3/8"	2-3/8"		HTTCP-C
HMD150	1-1/2"	2-3/8"		HTTCP-C
HMD175	1-3/4"	2-3/8"		HTTCP-C
HMD200	2"	2-3/8"		HTTCP-C
HMD212	2-1/8"	2-3/8"		HTTCP-C
HMD225	2-1/4"	2-3/8"		HTTCP-C
HMD250	2-1/2"	2-3/8"		HSP-MD, HSP-HS
HMD256	2-9/16"	2-3/8"		HSP-MD, HSP-HS
HMD275	2-3/4"	2-3/8"		HSP-MD, HSP-HS
HMD300	3"	2-3/8"	HSP-MD, HSP-HS	
HMD350	3-1/2"	2-3/8"	HSP-MD, HSP-HS	
HMD363	3-5/8"	2-3/8"	HSP-MD, HSP-HS	
HMD412	4-1/8"	2-3/8"	HSP-MD, HSP-HS	
HMD450	4-1/2"	2-3/8"	HSP-MD, HSP-HS	



**DRILLING AND FASTENING HOLE SAWS**

### TOOLLESS CHANGES

SpinLock™



**1. ATTACH**



**2. SPIN**



**3. LOCK**

## DAREDEVIL® SPINLOCK™ ARBOR



### DAREDEVIL® ARBOR

Fits all sizes and brands

### TOOLLESS CHANGE

Means greater speed on the job

### ROBUST DESIGN

For professional applications



### UNIVERSAL 1/4" QUICK CHANGE™

Easily and quickly switch out pilot bits



### SMALL CUP ADAPTER

For sizes 5/8" up to 1-3/16"



**BOSCH**  
Invented for life



# DAREDEVIL® RECESSED LIGHTING HOLE SAWS



HMD636RL

**COMPATIBLE WITH DAREDEVIL® SPINLOCK™ ARBOR**  
Fits all sizes and brands



**PREMIUM CARBIDE TEETH**  
For long life and 10× faster performance

**1-1/4" SHALLOW DEPTH CUP**  
Is optimized for drilling recessed lighting in ceilings and concealed spaces

**LARGE GULLETS**  
Facilitates plug removal and quickly clears debris

## DAREDEVIL® RECESSED LIGHTING HOLE SAWS

Item#	Diameter	Cut Depth	SpinLock™ Universal Arbor	
			Mandrel	Pilot Bit
HMD436RL	4-3/8"	1-1/4"	HSA-HS, HSA-MD	HSP-HS, HSP-MD
HMD636RL	6-3/8"	1-1/4"		

# DAREDEVIL® WOOD HOLE SAWS



**DEEP CUP DESIGN**  
Perfect for drilling through thick materials

**EXTRA LARGE GULETS**  
Large clearance slots for fast drilling and easy plug removal

**1/4" HEX SHANK**  
Use with 1/4" Quick Change™ chuck

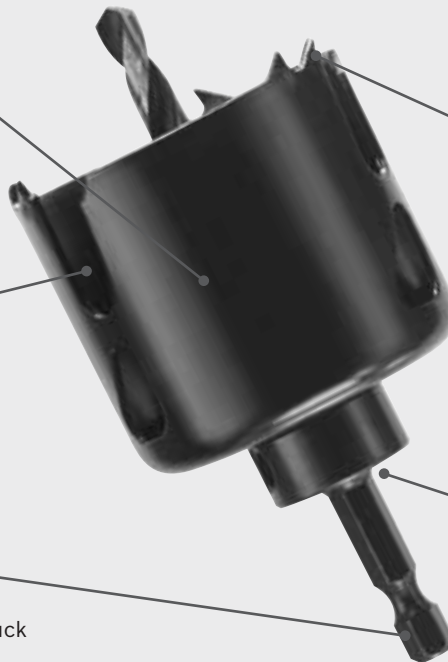

**TURBO-TEETH™ DESIGN**

- ▶ Bosch-exclusive two-tooth design for high-speed performance and long life
- ▶ 5x faster performance than a standard wood hole saw

**INTEGRATED ARBOR AND PILOT BIT**  
One-piece design for ease of use



**DRILLING AND FASTENING  
HOLE SAWS**

## DAREDEVIL® WOOD HOLE SAWS

Item#	Diameter	Cut Depth
HCD100	1"	1-7/8"
HCD125	1-1/4"	1-7/8"
HCD150	1-1/2"	1-7/8"
HCD175	1-3/4"	1-7/8"
HCD200	2"	1-7/8"
HCD212	2-1/8"	1-7/8"
HCD225	2-1/4"	1-7/8"
HCD250	2-1/2"	1-7/8"

## DAREDEVIL® WOOD HOLE SAW SETS

Item #	# of Pieces	Includes	Case Type
HCD005	5	Hole saws: (1) 1", (1) 1-1/2", (1) 2", (1) 2-1/2"; (1) arbor with pilot bit	—
HCD007	7	Hole saws: (1) 1", (1) 1-1/4", (1) 1-1/2", (1) 1-3/4", (1) 2", (1) 2-1/2"; (1) arbor with pilot bit	—



**BOSCH**  
Invented for life

# DARE TO DRILL FASTER

TURBO-TEETH™ TECHNOLOGY  
FOR 5× FASTER DRILLING  
AND LONGER LIFE



 **Daredevil.**

## DAREDEVIL® WOOD HOLE SAWS

Engineered to be 5× faster than standard wood hole saws, Daredevil® Wood Hole Saws employ Bosch's exclusive Turbo-Teeth™ design. This exclusive two-tooth pattern delivers faster drilling and longer life for best-in-class results in wood and plywood applications.



**BOSCH**  
Invented for life



# BI-METAL HOLE SAWS

## FASTER, LONGER LIFE

**PROGRESSOR™ TOOTH DESIGN**  
Cuts faster and lasts longer

**REINFORCED SHOULDER**  
For added strength and longer life



**8% COBALT ALLOY**  
For longer life and greater heat resistance

**WORKS WITH UNIVERSAL OR QUICK CHANGE™ MANDRELS\***  
\*Quick Change™ requires adapters

Progressive tooth and 10° cutting angle for high performance.



## BI-METAL HOLE SAWS

Item#	Diameter	Cut Depth	Standard		SpinLock™ Universal Arbor				
			Mandrel	Pilot Bit	Mandrel	Pilot Bit			
HB062	9/16"	1.6"	HSBAM						
HB063	5/8"	1.6"							
HB069	11/16"	1.6"							
HB075	3/4"	1.6"							
HB081	13/16"	1.6"							
HB087	7/8"	1.6"							
HB094	15/16"	1.6"							
HB100	1"	1.6"							
HB106	1-1/16"	1.6"							
HB112	1-1/8"	1.6"							
HB119	1-3/16"	1.6"							
HB125	1-1/4"	1.54"							
HB131	1-5/16"	1.54"					HSPB	HSA-HS	HSP-HS
HB136	1-3/8"	1.54"							
HB144	1-7/16"	1.54"							
HB150	1-1/2"	1.6"							
HB156	1-9/16"	1.6"							
HB163	1-5/8"	1.6"							
HB169	1-11/16"	1.6"							
HB175	1-3/4"	1.6"							
HB181	1-13/16"	1.6"							
HB187	1-7/8"	1.6"							
HB200	2"	1.6"	HSBAM, HSBAL, HSBAMP						
HB206	2-1/16"	1.6"							
HB212	2-1/8"	1.6"							



**DRILLING AND FASTENING**  
HOLE SAWS



**BOSCH**  
Invented for life

# BI-METAL HOLE SAWS (CONTINUED)

Item#	Diameter	Cut Depth	Standard		SpinLock™ Universal Arbor	
			Mandrel	Pilot Bit	Mandrel	Pilot Bit
HB225	2-1/4"	1-5/8"	HSBAM, HSBAL, HSBAMP	HSPB	HSA-HS	HSP-HS
HB231	2-5/16"	1-5/8"				
HB236	2-3/8"	1-5/8"				
HB250	2-1/2"	1-5/8"				
HB256	2-9/16"	1-5/8"				
HB263	2-5/8"	1-5/8"				
HB269	2-11/16"	1-5/8"				
HB275	2-3/4"	1-5/8"				
HB287	2-7/8"	1-5/8"				
HB300	3"	1-5/8"				
HB312	3-1/8"	1-5/8"				
HB325	3-1/4"	1-5/8"				
HB338	3-3/8"	1-5/8"				
HB350	3-1/2"	1-5/8"				
HB363	3-5/8"	1-5/8"				
HB375	3-3/4"	1-5/8"				
HB387	3-7/8"	1-5/8"				
HB400	4"	1-5/8"				
HB412	4-1/8"	1-5/8"				
HB425	4-1/4"	1-5/8"				
HB436	4-3/8"	1-5/8"				
HB450	4-1/2"	1-5/8"				
HB475	4-3/4"	1-5/8"				
HB500	5"	1-5/8"				
HB550	5-1/2"	1-5/8"				
HB575	5-3/4"	1-5/8"				
HB600	6"	1-5/8"				



**DRILLING AND FASTENING  
HOLE SAWS**

## BI-METAL HOLE SAW SETS



Item #	# of Pieces	Includes	Case Type
HB17PL	17 (plumber's kit)	Hole saws: (1) 3/4", (1) 7/8", (1) 1-1/8", (1) 1-3/8", (1) 1-3/4", (1) 2-1/4", (1) 2-9/16"; (3) small adapters (AN01); (4) large adapters (AN02); (1) Quick Change™ mandrel (PCM38); (2) pilot bits (HB85PB)	Plastic
HB19EL	19 (electrician's kit)	Hole saws: (1) 3/4", (1) 7/8", (1) 1-1/8", (1) 1-3/8", (1) 1-3/4", (1) 2", (1) 2-9/16", (1) 3"; (3) small adapters (AN01); (5) large adapters (AN02); (1) Quick Change™ mandrel (PCM38); (2) pilot bits (HB85PB)	Plastic
HB25M	25 (master kit)	Hole saws: (1) 3/4", (1) 7/8", (1) 1", (1) 1-1/8", (1) 1-3/8", (1) 1-1/2", (1) 1-3/4", (1) 2", (1) 2-1/8", (1) 2-1/2", (1) 3"; (4) small adapters (AN01); (7) large adapters (AN02); (1) Quick Change™ mandrel (PCM38); (2) pilot bits (HB85PB)	Plastic
HE1	2	(1) PCM38 adapter for hole saws; (1) adapter for hole saw enlargement plus; (3) washers	—
HBUSKIT	8	Hole saws: (1) 1", (1) 1-1/2", (1) 2-1/8", (1) 2-1/2"; (1) small adapter (AN01); (1) large adapter (AN02); (1) Quick Change™ mandrel (PCM38); (1) pilot bit (HB85PB)	—

# DIAMOND HOLE SAWS WITH AUTOSTART™

**FAST AND EASY STARTS,  
EVEN IN THE HARDEST TILE**

**AUTOSTART™ PILOT BIT**

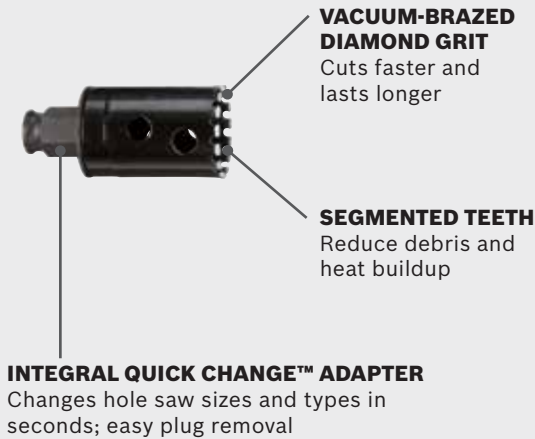

## DIAMOND HOLE SAWS

Item #	Diameter*	Use with Mandrel	Pilot Bit
HDG316	3/16"	-	-
HDG14	1/4"		
HDG516	5/16"		
HDG38	3/8"		
HDG12	1/2"		
HDG58	5/8"		
HDG34	3/4"		
HDG78	7/8"		
HDG1	1"		
HDG118	1-1/8"		
HDG114	1-1/4"		
HDG138	1-3/8"		
HDG112	1-1/2"		
HDG158	1-5/8"		
HDG134	1-3/4"		
HDG2	2"		
HDG218	2-1/8"		
HDG214	2-1/4"		
HDG212	2-1/2"		
HDG234	2-3/4"		
HDG3	3"		
HDG318	3-1/8"		
HDG314	3-1/4"		
HDG312	3-1/2"		
HDG358	3-5/8"		
HDG334	3-3/4"		
HDG4	4"		
HDG418	4-1/8"		

## DIAMOND HOLE SAW SETS



Item #	# of Pieces	Includes	Case Type
HDG138QA	3	(1) mandrel; (1) AutoStart™ pilot bit; (1) 1-3/8" hole saw	-
HDG7	7	(1) mandrel; (1) AutoStart™ pilot bit; hole saws: (1) 5/8", (1) 1", (1) 1-3/8", (1) 2", (1) 2-1/4"	Plastic
HDG11	11	(1) mandrel; (1) AutoStart™ pilot bit; hole saws: (1) 1/4", (1) 5/16", (1) 3/8", (1) 5/8", (1) 1", (1) 1-3/8", (1) 2", (1) 2-1/4", (1) 2-1/2"	Plastic
HDGM	3	(1) 3/16", (1) 1/4", (1) 1/2"	-

\*\* ⚠️ WARNING: Use only with machines designed for wet sawing and on a GFCI-protected circuit (if the machine is electrical)

## COMMON MATERIALS FOR DIAMOND GRIT HOLE SAWS

Use water for longer life

	Porcelain Tile		Ceramic Tile
	Limestone		Travertine
	Granite		Marble
	Slate		

\* = 1" maximum recommended cutting depth



**DRILLING AND FASTENING  
HOLE SAWS**



## IMPACT TOUGH™ THIN-WALL HOLE SAWS

**CLEAN, FAST CUTTING EVEN IN IMPACT MODE**

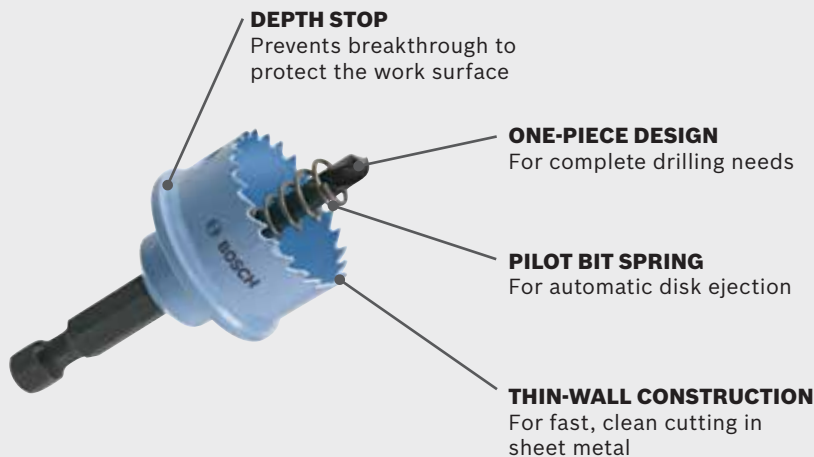

HTW1



HTW112

### IMPACT TOUGH™ THIN-WALL HOLE SAWS

Item #	Diameter	Pilot Bit
HTW34	3/4"	
HTW78	7/8"	
HTW1	1"	
HTW118	1-1/8"	HTWP
HTW114	1-1/4"	
HTW138	1-3/8"	
HTW112	1-1/2"	

### IMPACT TOUGH™ THIN-WALL HOLE SAW SET

Item #	# of Pieces	Includes	Case Type
HTWS	3	(1) 7/8", (1) 1-1/8", (1) 1-3/8"	Plastic



HTWS



# SHEET METAL HOLE SAWS

**VARIABLE-TOOTH PITCH**  
For fast, precise cutting in sheet metal

**DEPTH STOP**  
Prevents breakthrough to protect the work surface

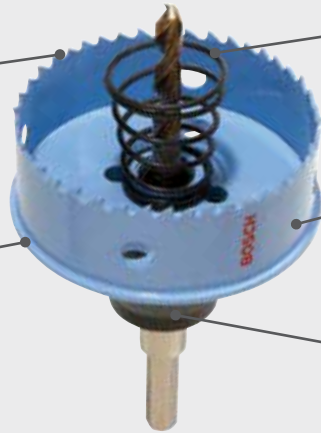

**REMOVABLE SPRING**  
For automatic disk ejection (1-3/4" and larger)

**EXTENDED REINFORCED THREADS**  
For maximum cup strength

**WORKS WITH STANDARD OR QUICK CHANGE™ MANDRELS**  
(Quick Change™ requires adapters)

## SHEET METAL HOLE SAWS

Item #	Diameter	Cut Depth	Standard		SpinLock™ Universal Arbor	
			Mandrel	Pilot Bit	Mandrel	Pilot Bit
HSM075	3/4"	7/8"	HSBAM			
HSM087	7/8"	7/8"				
HSM112	1-1/8"	7/8"				
HSM125	1-1/4"	7/8"	HSBAM, HSBAMP, HSBAL	HSPB	HSA-HS	HSA-HS
HSM136	1-3/8"	7/8"				
HSM150	1-1/2"	7/8"				
HSM200	2"	7/8"				
HSM250	2-1/2"	7/8"				
HSM256	2-9/16"	7/8"				
HSM263	2-5/8"	7/8"				
HSM275	2-3/4"	7/8"				
HSM363	3-5/8"	7/8"				

\* = 1/4" maximum recommended cutting depth

## SHEET METAL HOLE SAW SET



Item #	# of Pieces	Includes	Case Type
HSM23PCM	23	Hole saws: (1) 3/4", (1) 7/8", (1) 1-1/8", (1) 1-3/8", (1) 1-1/2", (1) 1-3/4", (1) 2", (1) 2-1/8", (1) 2-1/2", (1) 3"; (1) 3-3/8" cobalt pilot bit; (7) large adapters (AN02); (3) small adapters (AN01); (1) 3/8" Quick Change™ mandrel; springs for hole saws from 1-3/4"-6"	Plastic



**DRILLING AND FASTENING**  
HOLE SAWS



**BOSCH**  
Invented for life

# STANDARD ARBORS AND ACCESSORIES

## ARBORS

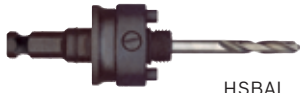

HSBAL



HSBAMP



HSBAM

Item #	Description	Shank Diameter
HSBAL	Large two-pin mandrel for hole saws 1-1/4"-6"	7/16"
HSBAMP	Large two-pin mandrel for hole saws 1-1/4"-6"	3/8"
HSBAM	Medium mandrel for hole saws 9/16"-6"	3/8"

## PILOT BIT



Item #	Description	Use with Mandrel	Hole Saw Series
HSPB	3-1/8" high-speed steel pilot bit	HSBAM, HSBAMP, HSBAL	Bi-metal, sheet metal

# DIAMOND HOLE SAW ARBOR AND ACCESSORY

## ARBOR



Item #	Shank Diameter	Fits Hole Saw Sizes	Pilot Bit	Adapter
HDGQA	3/8"	3/4"-4-1/8"	AutoStart™ carbide	Use with AN01 or AN02

## PILOT BIT



Item #	Description	Use with Mandrel	Hole Saw Series
HDGPB6	AutoStart™ (for diamond hole saws 3/4"-4-1/8")	HSA-HS, HSA-MD	Diamond

# SPINLOCK™ UNIVERSAL ARBORS AND ACCESSORIES

## ARBORS



HSA-MD



HSA-HS

Item #	Description	Shank Diameter
<b>HSA-MD</b>	SpinLock™ arbor with Daredevil® multipurpose pilot bit	3/8"
<b>HSA-HS</b>	SpinLock™ arbor with high-speed steel pilot bit	3/8"

## PILOT BITS



PCPD4  
Cobalt pilot bit



HTCTCP  
Carbide pilot bit



HSP-HS  
High-speed steel pilot bit



HB85PB  
High-speed steel pilot bit



HSM80PB  
Cobalt pilot bit



HSP-MD  
Daredevil® high-speed steel pilot bit

Item#	Description	Use with Mandrel	Hole Saw Series
<b>HSP-HS</b>	1/4" hex 100mm high-speed steel pilot bit	HSA-HS, HSA-MD	Daredevil®, bi-metal
<b>HSP-MD</b>	1/4" hex 100mm Daredevil® multipurpose pilot bit		Daredevil®, bi-metal
<b>PCPD4</b>	4-3/4" cobalt pilot bit		Daredevil®, bi-metal
<b>HTCTCP</b>	4-3/4" carbide tipped pilot bit		Daredevil®
<b>HS85PB</b>	3-3/8" high-speed steel pilot bit		Bi-metal, sheet metal
<b>HSM80PB</b>	3-1/8" cobalt pilot bit		Sheet metal

## EXTENSIONS



PCMEX38



PCMEX12

Item #	Length	Shank Diameter	Use with Mandrel
<b>PCMEX38</b>	12"	3/8"	PCM38, HSBAMP, HSBAM
<b>PCMEX12</b>	12"	1/2"	PCM12, HSBAL



**DRILLING AND FASTENING**  
HOLE SAWS



**BOSCH**  
Invented for life

# HARDENED TO THE CORE

ENGINEERED FOR  
HIGH TORQUE



Bosch Impact Tough™ screwdriver bits are engineered with an Xtended Torsion Zone, which helps to absorb torque peaks and to provide greater life over standard impact bits. The manufacturing process incorporates heat-treated high-quality materials to improve the strength of the bit. This Bosch-exclusive method provides ultimate torque and increases bit life.

Bosch Impact Tough™ bits—enhanced to handle a new generation of higher torque impact drills and drivers.



**BOSCH**  
Invented for life



# SCREWDRIVER BITS

## BIT DESIGN

### DRYWALL BIT



Reduced-diameter head is designed to reduce cam out when used in a drywall gun.

### DECKING BIT



Bits are designed for repetitive drives to minimize damage to the work surface or materials.

### ROUND BODY

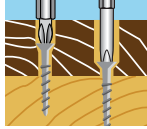

Allows screw to be set below the work surface without damaging the work as a full-hex body could.

## GRIPPING POWER

### TITANIUM (TiN) COATED



Titanium coating offers superior gripping power in tough applications.

### RIBBED TIP



Increases the gripping power between the bit and screw head, reducing the force to drive the screw.

## HARDNESS



Impact Tough™ bits are designed to withstand the high torque associated with today's more powerful impact drivers. Machined tips create a stronger and more flexible torsion zone reducing breakage and extending bit life.

### EXTRA HARD

Fully hardened and tempered for extended bit life under constant heavy-duty use. The tip is precision formed for proper fit. Use when driving heat-treated or case-hardened screws such as sheet metal, self-tapping or self-drilling.

### MEDIUM HARD

Made from high-quality steel, recommended for general-purpose driving.

## APPLICATION GUIDE

	Phillips®	Square Recess	Slotted	Torx®	Torx® Security	Torx® Align	Allen®	Allen® Security	Pozidriv®	Torq-Set®	Tri-Wing®	Spanner	Clutch G	Freonson®
Appliance	●	●	●	●	-	●	-	-	●	-	-	-	-	-
Automotive	●	-	●	●	-	●	●	-	●	-	-	-	-	-
Aviation	●	-	●	-	-	-	-	-	-	●	●	-	-	●
Cabinetry	●	●	●	-	-	-	-	-	-	-	-	-	-	●
Construction	●	-	●	-	-	-	-	-	●	-	-	-	-	-
Control panels	●	-	-	-	-	-	●	-	-	-	-	●	-	-
Decking	●	●	●	-	-	-	-	-	●	-	-	-	-	-
Drywall	●	●	-	-	-	-	-	-	-	-	-	-	-	-
Electronics	●	-	●	●	●	●	●	-	-	●	●	-	-	-
Furniture	●	●	●	-	-	-	●	-	-	-	-	-	-	-
Hobby	●	-	●	-	-	-	●	-	-	-	-	-	●	●
HVAC	●	●	●	-	-	-	●	-	-	-	-	-	-	-
Machine Tools/ Metal	●	-	●	-	-	-	●	●	-	-	-	-	-	-
Manufactured Housing	-	-	-	-	-	-	-	-	-	-	-	-	●	-
Marine	●	-	●	-	-	-	-	-	-	-	-	-	-	●
Recreation	●	-	●	-	-	-	●	●	-	-	-	-	●	●
Security	-	●	-	-	●	-	●	●	-	●	●	●	-	-
Subfloor	●	●	-	-	-	-	-	-	-	-	-	-	-	-



DRILLING AND FASTENING  
SCREWDRIVER BITS



**BOSCH**  
Invented for life

# IMPACT TOUGH™



## TAKES THE IMPACT AND COMPLETES THE JOB

### Engineered for high torque

Bosch has engineered a line of screwdriving bits, nutsetters and sockets that can handle torque generated from today's high-powered impact drivers.

#### SCREWDRIVER BITS AVAILABLE IN



PHILLIPS®



SQUARE



TORX®

**MACHINED TIP**  
Reduces breakage

**EXTENDED TORSION ZONE**  
Absorbs torque peaks  
reducing stress at the tip

**HARDENED CORE**  
Increases bit strength,  
reduces fracture



#### INSERT BITS



Pkg. Item #	Point	Length	Shank	Hardness	Pkg. Qty.	Bulk Item #
ITPH1102	P1	1"	1/4"	Impact Tough™	2	ITPH11B
ITPH1105	P1	1"	1/4"	Impact Tough™	5	ITPH21B
ITPH2102	P2	1"	1/4"	Impact Tough™	2	—
ITPH2105	P2	1"	1/4"	Impact Tough™	5	—
ITPH2115	P2	1"	1/4"	Impact Tough™	15	—
ITPH2R102	P2R	1"	1/4"	Impact Tough™	2	ITPH2R1B
ITPH3102	P3	1"	1/4"	Impact Tough™	2	ITPH31B
ITPH3105	P3	1"	1/4"	Impact Tough™	5	—
ITP2R2102	P2R2	1"	1/4"	Impact Tough™	2	ITP2R21B
ITP2R2105	P2R2	1"	1/4"	Impact Tough™	5	—
ITSQ1102	R1	1"	1/4"	Impact Tough™	2	ITSQ11B
ITSQ1105	R1	1"	1/4"	Impact Tough™	5	—
ITSQ2102	R2	1"	1/4"	Impact Tough™	2	ITSQ21B
ITSQ2105	R2	1"	1/4"	Impact Tough™	5	—
ITSQ2115	R2	1"	1/4"	Impact Tough™	15	—
ITSQ3102	R3	1"	1/4"	Impact Tough™	2	ITSQ31B
ITT15102	T15	1"	1/4"	Impact Tough™	2	ITT151B
ITT20102	T20	1"	1/4"	Impact Tough™	2	ITT201B
ITT25102	T25	1"	1/4"	Impact Tough™	2	ITT251B
ITT30102	T30	1"	1/4"	Impact Tough™	2	ITT301B
ITT40102	T40	1"	1/4"	Impact Tough™	2	ITT401B

NOTE: Impact Tough™ bulk items can only be ordered in multiples of 5 or 10 depending on the item. Minimum quantities may apply.



# POWER BITS



Pkg. Item #	Point	Length	Shank	Hardness	Pkg. Qty.	Bulk Item #
ITPH1201	P1	2"	1/4"	Impact Tough™	1	ITPH12B
ITPH2201	P2	2"	1/4"	Impact Tough™	1	ITPH22B
ITPH2205	P2	2"	1/4"	Impact Tough™	5	—
ITPH2215	P2	2"	1/4"	Impact Tough™	15	—
ITPH3201	P3	2"	1/4"	Impact Tough™	1	ITPH32B
ITSQ1201	R1	2"	1/4"	Impact Tough™	1	ITSQ12B
ITSQ2201	R2	2"	1/4"	Impact Tough™	1	ITSQ22B
ITSQ2205	R2	2"	1/4"	Impact Tough™	5	—
ITSQ2215	R2	2"	1/4"	Impact Tough™	15	—
ITSQ3201	R3	2"	1/4"	Impact Tough™	1	ITSQ32B
ITP2R2201	P2R2	2"	1/4"	Impact Tough™	1	ITP2R22B
ITP2R2205	P2R2	2"	1/4"	Impact Tough™	5	—
ITT15201	T15	2"	1/4"	Impact Tough™	1	ITT152B
ITT20201	T20	2"	1/4"	Impact Tough™	1	ITT202B
ITT20205	T20	2"	1/4"	Impact Tough™	5	—
ITT25201	T25	2"	1/4"	Impact Tough™	1	ITT252B
ITT25205	T25	2"	1/4"	Impact Tough™	5	—
ITT25215	T25	2"	1/4"	Impact Tough™	15	—
ITT30201	T30	2"	1/4"	Impact Tough™	1	ITT302B
ITT40201	T40	2"	1/4"	Impact Tough™	1	ITT402B
ITPH13501	P1	3.5"	1/4"	Impact Tough™	1	ITPH135B
ITPH23501	P2	3.5"	1/4"	Impact Tough™	1	ITPH235B
ITPH33501	P3	3.5"	1/4"	Impact Tough™	1	ITPH335B
ITSQ13501	R1	3.5"	1/4"	Impact Tough™	1	ITSQ135B
ITSQ23501	R2	3.5"	1/4"	Impact Tough™	1	ITSQ235B
ITSQ33501	R3	3.5"	1/4"	Impact Tough™	1	ITSQ335B
ITT153501	T15	3.5"	1/4"	Impact Tough™	1	ITT1535B
ITT203501	T20	3.5"	1/4"	Impact Tough™	1	ITT2035B
ITT253501	T25	3.5"	1/4"	Impact Tough™	1	ITT2535B
ITT303501	T30	3.5"	1/4"	Impact Tough™	1	ITT3035B
ITT403501	T40	3.5"	1/4"	Impact Tough™	1	ITT4035B
ITPH1601	P1	6"	1/4"	Impact Tough™	1	ITPH16B
ITPH2601	P2	6"	1/4"	Impact Tough™	1	ITPH26B
ITPH3601	P3	6"	1/4"	Impact Tough™	1	ITPH36B
ITSQ1601	R1	6"	1/4"	Impact Tough™	1	ITSQ16B
ITSQ2601	R2	6"	1/4"	Impact Tough™	1	ITSQ26B
ITSQ3601	R3	6"	1/4"	Impact Tough™	1	ITSQ36B
ITT15601	T15	6"	1/4"	Impact Tough™	1	ITT156B
ITT20601	T20	6"	1/4"	Impact Tough™	1	ITT206B
ITT25601	T25	6"	1/4"	Impact Tough™	1	ITT256B
ITT30601	T30	6"	1/4"	Impact Tough™	1	ITT306B
ITT40601	T40	6"	1/4"	Impact Tough™	1	ITT406B



## DRILLING AND FASTENING SCREWDRIVER BITS

NOTE: Impact Tough™ bulk items can only be ordered in multiples of 5 or 10 depending on the item. Minimum quantities may apply.



**BOSCH**  
Invented for life

## DOUBLE-ENDED BITS



Pkg. Item #	Point	Length	Shank	Hardness	Pkg. Qty.	Bulk Item #
ITDEPH12503	P1/P1	2.5"	1/4"	Impact Tough™	3	ITDEPH125B
ITDEPH22503	P2/P2	2.5"	1/4"	Impact Tough™	3	ITDEPH225B
ITDEPH32503	P3/P3	2.5"	1/4"	Impact Tough™	3	ITDEPH325B
ITDEPHV2503	P1/P1, P2/P2, P3/P3	2.5"	1/4"	Impact Tough™	3	—
ITDESQ12503	R1/R1	2.5"	1/4"	Impact Tough™	3	ITDESQ125B
ITDESQ22503	R2/R2	2.5"	1/4"	Impact Tough™	3	ITDESQ225B
ITDESQ32503	R3/R3	2.5"	1/4"	Impact Tough™	3	ITDESQ325B
ITDESQV2503	R1/R1, R2/R2, R3/R3	2.5"	1/4"	Impact Tough™	3	—
ITDEP2R22503	P2R2/P2R2	2.5"	1/4"	Impact Tough™	3	ITDEP2R225B
ITDET152503	T15/T15	2.5"	1/4"	Impact Tough™	3	ITDET1525B
ITDET202503	T20/T20	2.5"	1/4"	Impact Tough™	3	ITDET2025B
ITDET252503	T25/T25	2.5"	1/4"	Impact Tough™	3	ITDET2525B
ITDET302503	T30/T30	2.5"	1/4"	Impact Tough™	3	ITDET3025B
ITDETV2503	T20/T20, T25/T25, T30/T30	2.5"	1/4"	Impact Tough™	3	—
ITDEV2503	P2/P2, R2/R2, T25/T25	2.5"	1/4"	Impact Tough™	3	—
ITDEPH13501	P1/P1	3.5"	1/4"	Impact Tough™	1	ITDEPH135B
ITDEPH23501	P2/P2	3.5"	1/4"	Impact Tough™	1	ITDEPH235B
ITDEPH33501	P3/P3	3.5"	1/4"	Impact Tough™	1	ITDEPH335B
ITDESQ13501	R1/R1	3.5"	1/4"	Impact Tough™	1	ITDESQ135B
ITDESQ23501	R2/R2	3.5"	1/4"	Impact Tough™	1	ITDESQ235B
ITDESQ33501	R3/R3	3.5"	1/4"	Impact Tough™	1	ITDESQ335B
ITDEP2R23501	P2R2/P2R2	3.5"	1/4"	Impact Tough™	1	ITDEP2R235B
ITDET153501	T15/T15	3.5"	1/4"	Impact Tough™	1	ITDET1535B
ITDET203501	T20/T20	3.5"	1/4"	Impact Tough™	1	ITDET2035B
ITDET253501	T25/T25	3.5"	1/4"	Impact Tough™	1	ITDET2535B
ITDET303501	T30/T30	3.5"	1/4"	Impact Tough™	1	ITDET3035B
ITDEPH1601	P1/P1	6"	1/4"	Impact Tough™	1	ITDEPH16B
ITDEPH2601	P2/P2	6"	1/4"	Impact Tough™	1	ITDEPH26B
ITDEPH3601	P3/P3	6"	1/4"	Impact Tough™	1	ITDEPH36B
ITDESQ1601	R1/R1	6"	1/4"	Impact Tough™	1	ITDESQ16B
ITDESQ2601	R2/R2	6"	1/4"	Impact Tough™	1	ITDESQ26B
ITDESQ3601	R3/R3	6"	1/4"	Impact Tough™	1	ITDESQ36B
ITDEP2R2601	P2R2/P2R2	6"	1/4"	Impact Tough™	1	ITDEP2R26B
ITDET15601	T15/T15	6"	1/4"	Impact Tough™	1	ITDET156B
ITDET20601	T20/T20	6"	1/4"	Impact Tough™	1	ITDET206B
ITDET25601	T25/T25	6"	1/4"	Impact Tough™	1	ITDET256B
ITDET30601	T30/T30	6"	1/4"	Impact Tough™	1	ITDET306B

## DRILLING AND FASTENING SCREWDRIVER BITS

## BIT HOLDERS



Pkg. Item #	Description	Length	Shank	Hardness	Pkg. Qty.	Bulk Item #
ITBH201	Impact Tough™ 2" Bit Holder 1pk	2"	1/4"	Impact Tough™	1	ITBH201B
ITBHC201	Impact Tough™ 2" Quick Change Bit Holder 1pk	2"	1/4"	Impact Tough™	1	ITBHC201B

## NUTSETTERS



Pkg. Item #	Point	Length	Shank	Hardness	Pkg. Qty.	Bulk Item #
ITNS14	1/4"	1-7/8"	1/4"	Impact Tough™	1	ITNS14B
ITNS516	5/16"	1-7/8"	1/4"	Impact Tough™	1	ITNS516B
ITNS38	3/8"	1-7/8"	1/4"	Impact Tough™	1	ITNS38B
ITNS716	7/16"	1-7/8"	1/4"	Impact Tough™	1	ITNS716B
ITNS12	1/2"	1-7/8"	1/4"	Impact Tough™	1	ITNS12B
ITNS2490	1/4", 5/16", 3/8"	1-7/8"	1/4"	Impact Tough™	3	—
ITNS142	1/4"	2-9/16"	1/4"	Impact Tough™	1	ITNS142B
ITNS5162	5/16"	2-9/16"	1/4"	Impact Tough™	1	ITNS5162B
ITNS382	3/8"	2-9/16"	1/4"	Impact Tough™	1	ITNS382B
ITNS7162	7/16"	2-9/16"	1/4"	Impact Tough™	1	ITNS7162B
ITNS122	1/2"	2-9/16"	1/4"	Impact Tough™	1	ITNS122B
ITNS2492	1/4", 5/16", 3/8"	2-9/16"	1/4"	Impact Tough™	3	—

NOTE: Impact Tough™ bulk items can only be ordered in multiples of 5 or 10 depending on the item. Minimum quantities may apply.



## SOCKETS



Item #	Size	Well Depth	Shank	Hardness	Pkg. Qty.	Bulk Item #
ITSO14316*	3/16"	—	1/4"	Impact Tough™	1	—
ITSO1414*	1/4"	—	1/4"	Impact Tough™	1	—
ITSO14516*	5/16"	—	1/4"	Impact Tough™	1	—
ITSO1438*	3/8"	—	1/4"	Impact Tough™	1	—
ITSO14716*	7/16"	—	1/4"	Impact Tough™	1	—
ITSO1412*	1/2"	—	1/4"	Impact Tough™	1	—
ITSO14916*	9/16"	—	1/4"	Impact Tough™	1	—
27251	5/16"	Deep well	3/8"	Impact Tough™	1	—
27254	3/8"	Deep well	3/8"	Impact Tough™	1	—
27258	7/16"	Deep well	3/8"	Impact Tough™	1	—
27259	1/2"	Deep well	3/8"	Impact Tough™	1	—
27260	9/16"	Deep well	3/8"	Impact Tough™	1	—
27261	5/8"	Deep well	3/8"	Impact Tough™	1	—
27262	11/16"	Deep well	3/8"	Impact Tough™	1	—
27263	3/4"	Deep well	3/8"	Impact Tough™	1	—
27264	13/16"	Deep well	3/8"	Impact Tough™	1	—
27268	7/8"	Deep well	3/8"	Impact Tough™	1	—
27269	15/16"	Deep well	3/8"	Impact Tough™	1	—
27271	5/16"	Deep well	1/2"	Impact Tough™	1	—
27273	3/8"	Deep well	1/2"	Impact Tough™	1	—
27274	7/16"	Deep well	1/2"	Impact Tough™	1	—
27275	1/2"	Deep well	1/2"	Impact Tough™	1	—
27276	9/16"	Deep well	1/2"	Impact Tough™	1	—
27279	5/8"	Deep well	1/2"	Impact Tough™	1	—
27280	11/16"	Deep well	1/2"	Impact Tough™	1	—
27281	3/4"	Deep well	1/2"	Impact Tough™	1	—
27282	13/16"	Deep well	1/2"	Impact Tough™	1	—
27283	7/8"	Deep well	1/2"	Impact Tough™	1	—
27284	15/16"	Deep well	1/2"	Impact Tough™	1	—
ITSA14	1/4" hex to 1/4" socket adapter	—	1/4"	Impact Tough™	1	ITSA14B
ITSA38	1/4" hex to 3/8" socket adapter	—	1/4"	Impact Tough™	1	ITSA38B
ITSA12	1/4" hex to 1/2" socket adapter	—	1/4"	Impact Tough™	1	ITSA12B

\*Available spring 2017

## SOCKET SETS



Item #	# of Pieces	Includes	Hardness	Case Type
27285	8	3/8" drive: (1) 5/16", (1) 3/8", (1) 7/16", (1) 1/2", (1) 9/16", (1) 5/8", (1) 11/16", (1) 3/4"	Impact Tough™	Brute Tough™
27286	9	1/2" drive: (1) 7/16", (1) 1/2", (1) 9/16", (1) 5/8", (1) 11/16", (1) 3/4", (1) 13/16", (1) 7/8", (1) 15/16"	Impact Tough™	Brute Tough™

## SET

Item #	# of Pieces	Includes	Hardness	Case Type
SBID32	32	<b>Insert Bits:</b> (2) P1, (5) P2, (1) P2R, (3) P3, (1) R1, (3) R2, (1) R3, (1) T15, (2) T20, (2) T25, (1) T30; <b>2" Power Bits:</b> (3) P2, (1) P3, (2) R2, (2) T25; <b>3.5" Power Bits:</b> (1) P2R2 (1) Magnetic bit holder	Impact Tough™	Hard plastic

NOTE: Impact Tough™ bulk items can only be ordered in multiples of 5 or 10 depending on the item. Minimum quantities may apply.



**BOSCH**  
Invented for life



**DRILLING AND FASTENING**  
SCREWDRIVER BITS

# TITANIUM

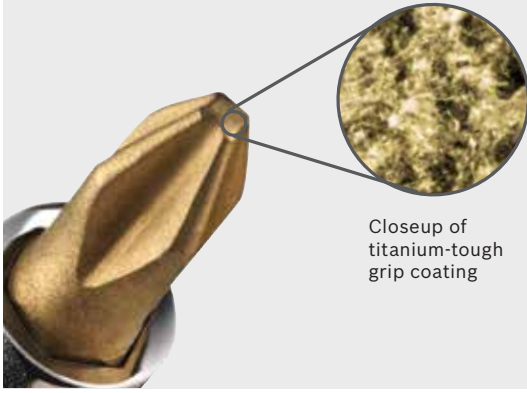

Closeup of titanium-tough grip coating

## 75% MORE GRIPPING POWER REDUCES STRIPPING

Titanium-tough grip screwdriver bits significantly reduce slippage (cam out) and the need to replace bits as often as standard screwdriver bits.

### DRILLING AND FASTENING SCREWDRIVER BITS

#### INSERT BITS



Pkg. Item #	Point	Length	Shank	Hardness	Pkg. Qty.
<b>TDP2106</b>	P2	1"	1/4"	Extra-TiN coated	6
<b>TDP2108</b>	P2	1"	1/4"	Extra-TiN coated	8
<b>TDP2110</b>	P2	1"	1/4"	Extra-TiN coated	10
<b>TDR2102</b>	R2	1"	1/4"	Extra-TiN coated	2
<b>TDR2106</b>	R2	1"	1/4"	Extra-TiN coated	6
<b>TDSL1012102</b>	10-12	1"	1/4"	Extra-TiN coated	2

#### POWER BITS



Pkg. Item #	Point	Length	Shank	Hardness	Pkg. Qty.
<b>TDP1201</b>	P1	2"	1/4"	Extra-TiN coated	1
<b>TDP2201</b>	P2	2"	1/4"	Extra-TiN coated	2
<b>TDP2203</b>	P2	2"	1/4"	Extra-TiN coated	3
<b>TDP2205</b>	P2	2"	1/4"	Extra-TiN coated	5
<b>TDP3201</b>	P3	2"	1/4"	Extra-TiN coated	1
<b>TDP123203</b>	P1, P2, P3	2"	1/4"	Extra-TiN coated	3
<b>TDR2203</b>	R2	2"	1/4"	Extra-TiN coated	3
<b>TDSL68201</b>	6-8	2"	1/4"	Extra-TiN coated	1
<b>TDSL1012201</b>	10-12	2"	1/4"	Extra-TiN coated	1
<b>TDSL681012</b>	6-8, 8-10, 10-12	2"	1/4"	Extra-TiN coated	3

#### MULTI-PACKS



Pkg. Item #	Point	Length	Shank	Hardness	Pkg. Qty.	Pkg. Type
<b>BCLIP15</b>	P2	1"	1/4"	Extra-TiN coated	15	Ammo clip
<b>TDP210250</b>	P2	1"	1/4"	Extra-TiN coated	250	Cookie jar

NOTE: Bulk items can be ordered in multiples of one where quantity is not noted. Minimum quantities may apply.

# 2-IN-1 BIT FOR PHILLIPS® AND ROBERTSON SCREWS

**BIT GEOMETRY**  
Allows user to drive Phillips® (P2) and Robertson (square drive) (R2) screw heads

**HIGH-QUALITY S2M TOOL STEEL**  
For longer bit life

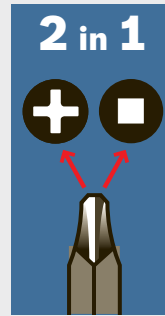
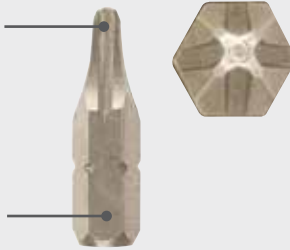

DIN/ANSI ratings to meet U.S. and European standards

## INSERT BITS



Pkg. Item #	Point	Length	Shank	Hardness	Pkg. Qty.	Bulk Item #
<b>P2R2102</b>	P2R2	1"	1/4"	Extra	2	27026
<b>ITP2R2102</b>	P2R2	1"	1/4"	Impact Tough™	2	ITP2R21B
<b>ITP2R2105</b>	P2R2	1"	1/4"	Impact Tough™	5	—

## POWER BITS



Pkg. Item #	Point	Length	Shank	Hardness	Pkg. Qty.	Bulk Item #
<b>P2R2201</b>	P2R2	2"	1/4"	Extra	1	27028
<b>P2R2205</b>	P2R2	2"	1/4"	Extra	5	27028
<b>ITP2R2201</b>	P2R2	2"	1/4"	Impact Tough™	1	ITP2R22B
<b>ITP2R2205</b>	P2R2	2"	1/4"	Impact Tough™	5	—

## MULTI-PACKS



Item #	Point	Length	Shank	Hardness	Pkg. Qty.	Pkg. Type
<b>43074</b>	P2R2	1"	1/4"	Extra	250	Cookie jar
<b>43075</b>	P2R2	2"	1/4"	Extra	100	Cookie jar
<b>P2R2115TCB</b>	P2R2	1"	1/4"	Extra	15	Tic-tac

## DOUBLE-ENDED BITS



Item #	Point	Length	Shank	Hardness	Pkg. Qty.	Bulk Item #
<b>ITDEP2R22503</b>	P2R2/ P2R2	2.5"	1/4"	Impact Tough™	3	ITDEP2R225B
<b>ITDEP2R223501</b>	P2R2/ P2R2	3.5"	1/4"	Impact Tough™	1	ITDEP2R235B
<b>ITDEP2R2601</b>	P2R2/ P2R2	6"	1/4"	Impact Tough™	1	ITDEP2R26B

NOTE: Bulk items can be ordered in multiples of one where quantity is not noted. Minimum quantities may apply.





INSERT BITS



Pkg. Item #	Point	Length	Shank	Hardness	Pkg. Qty.	Bulk Item #
P0102	P0	1"	1/4"	Extra	2	27019
P1102	P1 ribbed	1"	1/4"	Extra	2	46004
P1102G	P1	1"	1/4"	Extra	2	27035
P1102GX	P1	1"	1/4"	Extra	2	27020
P1102M	P1	1"	1/4"	Medium	2	25020
-	P1 ribbed	1"	1/4"	Medium	-	45912
P1R102	P1R reduced	1"	1/4"	Extra	2	27035
P2102	P2 ribbed	1"	1/4"	Extra	2	46005
P2102G	P2	1"	1/4"	Extra	2	27021
-	P2 ribbed	1"	1/4"	Medium	-	45913
P2102M	P2	1"	1/4"	Medium	2	25021
P2D105	P2R reduced	1"	1/4"	Extra	5	27036
P3102	P3	1"	1/4"	Extra	2	16768
P3102R	P3 ribbed	1"	1/4"	Extra	2	16768
P3102G	P3	1"	1/4"	Extra	2	27022
-	P3 ribbed	1"	1/4"	Medium	-	45914
-	P2	1-1/2"	1/4"	Extra	-	27023
-	P2	2"	1/4"	Extra	-	27024
-	P2	2-1/2"	1/4"	Extra	-	27025
-	P1	1-1/4"	5/16"	Extra	-	27205
P2516102	P2	1-1/4"	5/16"	Extra	2	27206
-	P3	1-1/4"	5/16"	Extra	-	27207
-	P4	1-1/4"	5/16"	Extra	-	27208

DRILLING AND FASTENING  
SCREWDRIVER BITS

POWER BITS



Pkg. Item #	Point	Length	Shank	Hardness	Pkg. Qty.	Bulk Item #
P1201	P1	1-15/16"	1/4"	Extra	1	37659
P3201	P3	1-15/16"	1/4"	Extra	1	-
P3D201	P3D deck	1-15/16"	1/4"	Extra	1	37663
CCP1201	P1	2"	1/4"	Extra	1	-
-	P1	2"	1/4"	Medium	-	37659MH
CCP2201	P2	2"	1/4"	Extra	1	-
CCP2205	P2	2"	1/4"	Extra	5	-
-	P2	2"	1/4"	Medium	-	37661MH
CCP3201	P3	2"	1/4"	Extra	1	-
-	P3	2"	1/4"	Medium	-	37663MH
CCP1301	P1	3-1/2"	1/4"	Extra	1	-
P2D23501	P2D deck	3-1/2"	1/4"	Extra	1	-
CCP2301	P2	3-1/2"	1/4"	Extra	1	-
P2401	P2	4"	1/4"	Extra	1	-
CCP2601	P2	6"	1/4"	Extra	1	27370

NOTE: Bulk items can be ordered in multiples of one where quantity is not noted. Minimum quantities may apply.



## POWER BITS ROUND BODY



Pkg. Item #	Point	Length	Shank	Hardness	Pkg. Qty.	Bulk Item #
-	P2	2-3/4"	1/4"	Extra	-	27364
-	P3	2-3/4"	1/4"	Extra	-	27365
-	P2	3"	1/4"	Extra	-	28311
-	P1	3-1/2"	1/4"	Extra	-	27366
-	P3	3-1/2"	1/4"	Extra	-	27368
-	P1	4"	1/4"	Extra	-	28313
-	P2	4"	1/4"	Extra	-	28314
-	P3	4"	1/4"	Extra	-	28315
-	P1	6"	1/4"	Extra	-	45794
-	P2	6"	1/4"	Extra	-	45625
-	P3	6"	1/4"	Extra	-	45626

## MULTI-PACKS



Item #	Point	Length	Shank	Hardness	Qty.	Pkg. Type
<b>SQZRP2110</b>	P2	1"	1/4"	Extra	10	Pinch-pack
<b>SQZRP2125</b>	P2	1"	1/4"	Extra	25	Pinch-pack
<b>SQZRP2R125</b>	P2 reduced diameter	1"	1/4"	Extra	25	Pinch-pack
<b>SQZRP225</b>	P2	2"	1/4"	Extra	5	Pinch-pack
<b>P2115TCB</b>	P2	1"	1/4"	Extra	15	Tic-tac
<b>BBT25P2</b>	P2	1"	1/4"	Extra	25	Big-tac
<b>BBT25P2R</b>	P2R reduced diameter	1"	1/4"	Extra	25	Big-tac

**DRILLING AND FASTENING**  
SCREWDRIVER BITS

NOTE: Bulk items can be ordered in multiples of one where quantity is not noted. Minimum quantities may apply.



**BOSCH**  
Invented for life

# SQUARE AND SQUARE RECESS



## INSERT BITS



Pkg. Item #	Point	Length	Shank	Hardness	Pkg. Qty.	Bulk Item #
<b>SQ0102</b>	R0	1"	1/4"	Extra	2	38509
<b>SQ1102</b>	R1	1"	1/4"	Extra	2	29049
<b>SQ1102M</b>	R1	1"	1/4"	Medium	2	45195
<b>SQ2102</b>	R2	1"	1/4"	Extra	2	29050
—	R2	1"	1/4"	Medium	—	45196
<b>SQ3102</b>	R3	1"	1/4"	Extra	2	29051
—	R3	1"	1/4"	Medium	—	45197

## POWER BITS



Pkg. Item #	Point	Length	Shank	Hardness	Pkg. Qty.	Bulk Item #
<b>SQ1201M</b>	R1	1-15/16"	1/4"	Medium	5	45184
<b>SQR2D201</b>	R2-deck	1-15/16"	1/4"	Extra	5	24314
—	R3	1-15/16"	1/4"	Medium	—	45186
<b>CCSQ1201</b>	R1	2"	1/4"	Extra	1	29052
<b>CCSQ2201</b>	R2	2"	1/4"	Extra	1	29053
<b>CCSQ2205</b>	R2	2"	1/4"	Extra	5	29053
<b>CCSQ3201</b>	R3	2"	1/4"	Extra	1	29054
<b>SQ22701</b>	R2	2-3/4"	1/4"	Extra	1	29056
<b>SQ1301</b>	R1	3"	1/4"	Extra	1	—
<b>SQ2301</b>	R2	3"	1/4"	Extra	1	29059
<b>SQ13501</b>	R1	3-1/2"	1/4"	Extra	1	—
—	R2	3-1/2"	1/4"	Extra	—	39947
<b>SQ33501</b>	R3	3-1/2"	1/4"	Extra	1	39949
—	R1	4"	1/4"	Extra	—	44136
<b>SQ2401</b>	R2	4"	1/4"	Extra	1	39953
—	R3	4"	1/4"	Extra	—	44138
—	R1	6"	1/4"	Extra	—	39957
<b>CCSQ2601</b>	R2	6"	1/4"	Extra	1	39959
<b>SQ3601</b>	R3	6"	1/4"	Extra	1	39961

## MULTI-PACKS



Item #	Point	Length	Shank	Hardness	Pkg. Qty.	Pkg. Type
<b>SQZRR2110</b>	R2	1"	1/4"	Extra	10	Pinch-pack
<b>SQZRR2125</b>	R2	1"	1/4"	Extra	25	Pinch-pack
<b>SQZRR225</b>	R2	2"	1/4"	Extra	5	Pinch-pack
<b>BBT25R2</b>	R2	2"	1/4"	Extra	25	Big-tac

NOTE: Bulk items can be ordered in multiples of one where quantity is not noted. Minimum quantities may apply.

# SLOTTED



## INSERT BITS



Pkg. Item #	Point	Length	Shank	Hardness	Pkg. Qty.	Bulk Item #
<b>SL0102</b>	0-1	1"	1/4"	Extra	2	41175
<b>SL1102</b>	1-2	1"	1/4"	Extra	2	41176
<b>SL2102</b>	2-3	1"	1/4"	Extra	2	41177
<b>SL3102</b>	3-4	1"	1/4"	Extra	2	41178
<b>SL4102</b>	4-5	1"	1/4"	Extra	2	39534
<b>SL5102</b>	5-6	1"	1/4"	Extra	2	39535
<b>SL6102</b>	6-8	1"	1/4"	Extra	2	39536
<b>SL8102</b>	8-10	1"	1/4"	Extra	2	39537
-	12-14	1"	1/4"	Extra	-	39539
<b>T2643</b>	6-8, 8-10, 10-12	1"	1/4"	Extra	3	-

## POWER BITS



Pkg. Item #	Point	Length	Shank	Hardness	Pkg. Qty.	Bulk Item #
-	1-2	1-15/16"	1/4"	Extra	-	27460
-	2-3	1-15/16"	1/4"	Extra	-	27461
-	3-4	1-15/16"	1/4"	Extra	-	27462
-	4-5	1-15/16"	1/4"	Extra	-	27463
<b>SL56201</b>	5-6	1-15/16"	1/4"	Extra	1	27464
<b>CCSL68201</b>	6-8	1-15/16"	1/4"	Extra	1	27465
-	6-8	3-1/2"	1/4"	Extra	-	27483
<b>SL8103501</b>	8-10	3-1/2"	1/4"	Extra	1	27484
-	10-12	3-1/2"	1/4"	Extra	-	27485
-	6-8	6"	1/4"	Extra	-	27501
-	8-10	6"	1/4"	Extra	-	27502
-	10-12	6"	1/4"	Extra	-	27503

## MULTI-PACK

Pkg. Item #	Point	Length	Shank	Hardness	Pkg. Qty.	Pkg. Type
<b>SQZRSL8110</b>	8-10	1"	1/4"	Extra	10	Pinch-pack

NOTE: Bulk items can be ordered in multiples of one where quantity is not noted. Minimum quantities may apply.



**BOSCH**  
Invented for life



**INSERT BITS**



Pkg. Item #	Point	Length	Shank	Hardness	Pkg. Qty.	Bulk Item #
—	T9	1"	1/4"	Medium	—	35013
—	T10	1"	1/4"	Medium	—	45147
<b>TX1015102</b>	T10, T15	1"	1/4"	Extra	2	—
<b>TX20102G</b>	T20	1"	1/4"	Extra	2	37161
<b>TX20102M</b>	T20	1"	1/4"	Medium	2	45149
<b>TX2025102</b>	T20, T25	1"	1/4"	Extra	2	—
<b>TX25102G</b>	T25	1"	1/4"	Extra	2	37163
<b>TX25102M</b>	T25	1"	1/4"	Medium	2	45150
<b>TX27102G</b>	T27	1"	1/4"	Extra	2	37165
—	T27	1"	1/4"	Medium	—	45468
<b>TX30102G</b>	T30	1"	1/4"	Extra	2	37167
—	T30	1"	1/4"	Medium	—	45151
—	T40	1"	1/4"	Extra	—	37169
—	T40	1"	1/4"	Medium	—	45152
<b>TX3040102</b>	T30, T40	1"	1/4"	Extra	2	—
<b>CC90396</b>	T10, T15, T20, T25, T30, T40	1"	1/4"	Extra	6	—

Pkg. Item #	Point	Length	Shank	Hardness	Pkg. Qty.	Bulk Item #
—	T30	1-1/4"	5/16"	Extra	—	37171
—	T40	1-1/4"	5/16"	Extra	—	37173
—	T45	1-1/4"	5/16"	Extra	—	37175
—	T50	1-1/4"	5/16"	Extra	—	37177
—	T55	1-1/4"	5/16"	Extra	—	38333

**INSERT BITS  
5/16" SHANK**

**DRILLING AND FASTENING  
SCREWDRIVER BITS**

NOTE: Bulk items can be ordered in multiples of one where quantity is not noted. Minimum quantities may apply.

## POWER BITS



Pkg. Item #	Point	Length	Shank	Hardness	Pkg. Qty.	Bulk Item #
—	T6	1-15/16"	1/4"	Extra	—	41751
—	T7	1-15/16"	1/4"	Extra	—	39931
—	T9	1-15/16"	1/4"	Extra	—	39933
<b>TX15201</b>	T15	1-15/16"	1/4"	Extra	1	37717
<b>TX20201M</b>	T20	1-15/16"	1/4"	Extra	1	37719
<b>TX25201M</b>	T25	1-15/16"	1/4"	Extra	1	37721
—	T27	1-15/16"	1/4"	Extra	—	37723
—	T30	1-15/16"	1/4"	Extra	—	37725
<b>TX40201</b>	T40	1-15/16"	1/4"	Extra	1	37727
—	T8	2-3/4"	1/4"	Extra	—	37729
—	T10	2-3/4"	1/4"	Extra	—	37731
—	T15	2-3/4"	1/4"	Extra	—	37733
—	T20	2-3/4"	1/4"	Extra	—	37735
—	T25	2-3/4"	1/4"	Extra	—	37737
—	T30	2-3/4"	1/4"	Extra	—	37741
—	T40	2-3/4"	1/4"	Extra	—	37743
—	T8	3-1/2"	1/4"	Extra	—	37745
—	T10	3-1/2"	1/4"	Extra	—	37747
—	T15	3-1/2"	1/4"	Extra	—	37749
—	T20	3-1/2"	1/4"	Extra	—	37751
—	T25	3-1/2"	1/4"	Extra	—	37753
—	T27	3-1/2"	1/4"	Extra	—	37755
—	T30	3-1/2"	1/4"	Extra	—	37757
—	T40	3-1/2"	1/4"	Extra	—	37759
<b>TX10601</b>	T10	6"	1/4"	Extra	1	37763
<b>TX15601</b>	T15	6"	1/4"	Extra	1	37765
<b>TX20601</b>	T20	6"	1/4"	Extra	1	37767
—	T25	6"	1/4"	Extra	—	37769
<b>TX27601</b>	T27	6"	1/4"	Extra	1	37771
—	T30	6"	1/4"	Extra	—	37773

## MULTI-PACKS



Pkg. Item #	Point	Length	Shank	Hardness	Pkg. Qty.	Pkg. Type
<b>SQZRT15110</b>	T15	1"	1/4"	Extra	10	Pinch-pack
<b>SQZRT20110</b>	T20	1"	1/4"	Extra	10	Pinch-pack
<b>SQZRT25110</b>	T25	1"	1/4"	Extra	10	Pinch-pack
<b>SQZRT27110</b>	T27	1"	1/4"	Extra	10	Pinch-pack
<b>SQZRT30110</b>	T30	1"	1/4"	Extra	10	Pinch-pack

NOTE: Bulk items can be ordered in multiples of one where quantity is not noted. Minimum quantities may apply.



**DRILLING AND FASTENING**  
SCREWDRIVER BITS



**BOSCH**  
Invented for life



# TORX® SECURITY



## INSERT BITS



Pkg. Item #	Point	Length	Shank	Hardness	Pkg. Qty.	Bulk Item #
—	T7H	1"	1/4"	Extra	—	38911
—	T8H	1"	1/4"	Extra	—	38338
—	T9H	1"	1/4"	Extra	—	38340
<b>TXH10102</b>	T10H	1"	1/4"	Extra	2	38342
<b>TXH15102</b>	T15H	1"	1/4"	Extra	2	38344
<b>TXH20102</b>	T20H	1"	1/4"	Extra	2	38346
<b>TXH25102</b>	T25H	1"	1/4"	Extra	2	38348
<b>TXH27102</b>	T27H	1"	1/4"	Extra	2	38350
<b>TXH30102</b>	T30H	1"	1/4"	Extra	2	38352
<b>TXH40102</b>	T40H	1"	1/4"	Extra	2	38354
<b>CC60391</b>	T10H, T15H, T20H, T25H, T27H, T30H	1"	1/4"	Extra	6	—

# TORX® ALIGN (WEDGE)



## INSERT BITS



Pkg. Item #	Point	Length	Shank	Hardness	Pkg. Qty.	Bulk Item #
—	T6W	1"	1/4"	Extra	—	38763
—	T7W	1"	1/4"	Extra	—	38765
—	T8W	1"	1/4"	Extra	—	38767
—	T9W	1"	1/4"	Extra	—	38769
—	T10W	1"	1/4"	Extra	—	38771
—	T20W	1"	1/4"	Extra	—	38367

## POWER BITS



Pkg. Item #	Point	Length	Shank	Hardness	Pkg. Qty.	Bulk Item #
—	T8W	1-15/16"	1/4"	Extra	—	38732
—	T9W	1-15/16"	1/4"	Extra	—	38734
—	T15W	1-15/16"	1/4"	Extra	—	38375
—	T20W	1-15/16"	1/4"	Extra	—	38377
—	T25W	1-15/16"	1/4"	Extra	—	38379
—	T27W	1-15/16"	1/4"	Extra	—	38381
—	T30W	1-15/16"	1/4"	Extra	—	38383

NOTE: Bulk items can be ordered in multiples of one where quantity is not noted. Minimum quantities may apply.

# TORX® FEMALE SOCKET DRIVE



## SOCKET DRIVE SCREW BITS



Pkg. Item #	Point	Length	Socket	Hardness	Pkg. Qty.	Bulk Item #
-	T10	1"	1/4"	Extra	-	38689
-	T15	1"	1/4"	Extra	-	38690
-	T20	1"	1/4"	Extra	-	38691
-	T25	1"	1/4"	Extra	-	38692
-	T27	1"	1/4"	Extra	-	38693
-	T30	1"	1/4"	Extra	-	38694
-	T40	1"	3/8"	Extra	-	38695
-	T45	1"	3/8"	Extra	-	38696
-	T47	1"	3/8"	Extra	-	40651
-	T50	1"	3/8"	Extra	-	38697
-	T55	1"	3/8"	Extra	-	38860
-	T60	1"	1/2"	Extra	-	44217



**DRILLING AND FASTENING**  
SCREWDRIVER BITS

NOTE: Bulk items can be ordered in multiples of one where quantity is not noted. Minimum quantities may apply.



**BOSCH**  
Invented for life



INSERT BITS



Pkg. Item #	Point	Length	Shank	Hardness	Pkg. Qty.	Bulk Item #
—	1/16"	1"	1/4"	Extra	—	27095
<b>AL564102</b>	5/64"	1"	1/4"	Extra	2	27096
—	5/64"	1"	1/4"	Medium	—	27096MH
<b>AL332102</b>	3/32"	1"	1/4"	Extra	2	27097
—	3/32"	1"	1/4"	Medium	—	27097MH
<b>AL764102</b>	7/64"	1"	1/4"	Extra	2	37475
—	7/64"	1"	1/4"	Medium	—	37475MH
—	1/8"	1"	1/4"	Medium	—	27098MH
<b>AL964102</b>	9/64"	1"	1/4"	Extra	2	37476
—	9/64"	1"	1/4"	Medium	—	37476MH
<b>AL532102</b>	5/32"	1"	1/4"	Extra	2	27099
—	5/32"	1"	1/4"	Medium	—	27099MH
<b>AL316102</b>	3/16"	1"	1/4"	Extra	2	27100
—	3/16"	1"	1/4"	Medium	—	27100MH
<b>AL732102</b>	7/32"	1"	1/4"	Extra	2	27101
—	7/32"	1"	1/4"	Medium	—	27101MH
<b>AL14102</b>	1/4"	1"	1/4"	Extra	2	27102
—	1/4"	1"	1/4"	Medium	—	27102MH
<b>AL516102</b>	5/16"	1"	1/4"	Extra	2	27103
—	3/8"	1"	1/4"	Extra	—	27104
—	.050mm	1"	1/4"	Extra	—	27094
—	2mm	1"	1/4"	Extra	—	36538
—	3mm	1"	1/4"	Extra	—	36539
—	4mm	1"	1/4"	Extra	—	36540
—	5mm	1"	1/4"	Extra	—	36541
—	6mm	1"	1/4"	Extra	—	36542
<b>CC60392</b>	5/64", 3/32", 1/8", 5/32", 3/16", 7/64"	1"	1/4"	Extra	—	—

POWER BITS



Pkg. Item #	Point	Length	Shank	Hardness	Pkg. Qty.	Bulk Item #
—	1/16"	1-15/16"	1/4"	Extra	—	27420
—	5/64"	1-15/16"	1/4"	Extra	—	27421
—	3/32"	1-15/16"	1/4"	Extra	—	27422
—	7/64"	1-15/16"	1/4"	Extra	—	37563
—	1/8"	1-15/16"	1/4"	Extra	—	27423
—	9/64"	1-15/16"	1/4"	Extra	—	37565
—	5/32"	1-15/16"	1/4"	Extra	—	27424
—	3/16"	1-15/16"	1/4"	Extra	—	27425
—	1/4"	1-15/16"	1/4"	Extra	—	27427

NOTE: Bulk items can be ordered in multiples of one where quantity is not noted. Minimum quantities may apply.



# ALLEN® SECURITY



## INSERT BITS



Pkg. Item #	Point	Length	Shank	Hardness	Pkg. Qty.	Bulk Item #
—	1/8"	1"	1/4"	Extra	—	35693
—	9/64"	1"	1/4"	Extra	—	35694
—	5/32"	1"	1/4"	Extra	—	35695
—	3/16"	1"	1/4"	Extra	—	35696
—	7/32"	1"	1/4"	Extra	—	35697
—	1/4"	1"	1/4"	Extra	—	35698
—	5/16"	1"	1/4"	Extra	—	35699
—	3/8"	1"	1/4"	Extra	—	35701

# POZIDRIV®



## INSERT BITS



Pkg Item #	Point	Length	Shank	Hardness	Pkg Qty.	Bulk Item #
<b>PZD1102</b>	PZ1	1"	1/4"	Extra	2	27045
<b>PZD1102R</b>	PZ1 ribbed	1"	1/4"	Extra	2	—
<b>PZD2102</b>	PZ2	1"	1/4"	Extra	2	27046
—	PZ2	1"	1/4"	Medium	—	45154
<b>PZD2102R</b>	PZ2 ribbed	1"	1/4"	Extra	2	—
<b>PZD3102</b>	PZ3	1"	1/4"	Extra	2	27047
—	PZ3	1"	1/4"	Medium	—	45939
<b>PZD3102R</b>	PZ3 ribbed	1"	1/4"	Extra	2	—

## POWER BITS



Pkg Item #	Point	Length	Shank	Hardness	Pkg Qty.	Bulk Item #
—	PZ1	2"	1/4"	Extra	—	27380
—	PZ2	2"	1/4"	Extra	—	27381
—	PZ3	2"	1/4"	Extra	—	27382
—	PZ1	3-1/2"	1/4"	Extra	—	27386
—	PZ2	3-1/2"	1/4"	Extra	—	27387
—	PZ3	3-1/2"	1/4"	Extra	—	27388
—	PZ1	6"	1/4"	Extra	—	27389
—	PZ3	6"	1/4"	Extra	—	27391



DRILLING AND FASTENING  
SCREWDRIVER BITS

NOTE: Bulk items can be ordered in multiples of one where quantity is not noted. Minimum quantities may apply.



**BOSCH**  
Invented for life

## TORQ-SET®



### INSERT BITS



Pkg. Item #	Point	Length	Shank	Hardness	Pkg. Qty.	Bulk Item #
—	#0	1"	1/4"	Extra	—	35395
—	#1	1"	1/4"	Extra	—	35396
—	#2	1"	1/4"	Extra	—	35397
—	#3	1"	1/4"	Extra	—	35398
—	#4	1"	1/4"	Extra	—	35399
—	#5	1"	1/4"	Extra	—	35394
—	#6	1"	1/4"	Extra	—	35401
—	#8	1"	1/4"	Extra	—	35402
—	#10	1"	1/4"	Extra	—	35403

### POWER BITS



Pkg. Item #	Point	Length	Shank	Hardness	Pkg. Qty.	Bulk Item #
—	#0	1-1/4"	1/4"	Extra	—	35425
—	#1	1-1/4"	1/4"	Extra	—	35426
—	#2	1-1/4"	1/4"	Extra	—	35427
—	#3	1-1/4"	1/4"	Extra	—	35428
—	#4	1-1/4"	1/4"	Extra	—	35429
—	#5	1-1/4"	1/4"	Extra	—	35430
—	#6	1-1/4"	1/4"	Extra	—	35431
—	#8	1-1/4"	1/4"	Extra	—	35432
—	#10	1-1/4"	1/4"	Extra	—	35433

DRILLING AND FASTENING  
SCREWDRIVER BITS

## TRI-WING®



### INSERT BITS



Pkg. Item #	Point	Length	Shank	Hardness	Pkg. Qty.	Bulk Item #
—	#1	1"	1/4"	Extra	—	35410
—	#2	1"	1/4"	Extra	—	35411
—	#3	1"	1/4"	Extra	—	35412
—	#4	1"	1/4"	Extra	—	35413
—	#5	1"	1/4"	Extra	—	35414

## SPANNER



### INSERT BITS



Pkg. Item #	Point	Length	Shank	Hardness	Pkg. Qty.	Bulk Item #
<b>SPA6102</b>	#6 gold bit	1"	1/4"	Extra	2	35422
<b>SPA802</b>	#8 gold bit	1"	1/4"	Extra	2	35423
<b>SPA10102</b>	#10 gold bit	1"	1/4"	Extra	2	35424

NOTE: Bulk items can be ordered in multiples of one where quantity is not noted. Minimum quantities may apply.



## CLUTCH G



### INSERT BITS



Pkg. Item #	Point	Length	Shank	Hardness	Pkg. Qty.	Bulk Item #
–	C2 1/8"	1"	1/4"	Extra	–	27081
<b>CL3102</b>	C3 5/32"	1"	1/4"	Extra	2	27082
<b>CL4102</b>	C4 3/16"	1"	1/4"	Extra	2	27083

### POWER BIT



Pkg. Item #	Point	Length	Shank	Hardness	Pkg. Qty.	Bulk Item #
–	C3 5/32"	1-15/16"	1/4"	Extra	–	27437

## FREARSON®



### INSERT BITS



Pkg. Item #	Point	Length	Shank	Hardness	Pkg. Qty.	Bulk Item #
–	F1	1"	1/4"	Extra	–	27070
<b>FR2102</b>	F2	1"	1/4"	Extra	2	37382

## DOUBLE ENDED

### DOUBLE END SCREW BITS



Pkg. Item #	Point	Length	Shank	Hardness	Pkg. Qty.	Bulk Item #
–	P1-#6	1-1/2"	1/4"	Extra	–	38666
–	P2-#8	1-1/2"	1/4"	Extra	–	38652
–	P3-#10	1-1/2"	1/4"	Extra	–	38653
<b>DEBP28201</b>	P2-S8	1-7/8"	1/4"	Extra	1	–
–	P2-P2	1-3/4"	1/4"	Extra	–	44103
–	R1-R2	2"	1/4"	Extra	–	48784
<b>DEBP282501</b>	P2-S8	2-1/2"	1/4"	Extra	1	38657
<b>DEBP3102501R</b>	P3-S10	2-1/2"	1/4"	Extra	1	–
<b>DEBP1P22501</b>	P1-P2	2-1/2"	1/4"	Extra	1	–
<b>DEBP222501</b>	P2-P2	2-1/2"	1/4"	Extra	1	44071
<b>DEBP2R22501R</b>	P2-R2	2-1/2"	1/4"	Extra	1	38655
<b>DEBR122501</b>	R1-R2	2-1/2"	1/4"	Extra	1	–
<b>DEBR232501</b>	R2-R3	2-1/2"	1/4"	Extra	1	–
<b>DEBT15202501</b>	T15-T20	2-1/2"	1/4"	Extra	1	–
–	T25-T30	1-1/2"	1/4"	Extra	1	42079

NOTE: Bulk items can be ordered in multiples of one where quantity is not noted. Minimum quantities may apply.



**BOSCH**  
Invented for life

# NUTSETTERS

## HEX SHANK NUTSETTERS



Pkg. Item #	Size	Length	Magnetic	Hardness	Pkg. Qty.	Bulk Item #
NS316101	3/16"	1-3/8"	No	Extra	1	—
NS141401MAG	1/4"	1-1/8"	Yes	Extra	1	—
—	1/4"	1-1/8"	Yes	Extra	—	38686
NS141401U	1/4"	1-7/16"	No	Extra	1	—
NS516101MAG	5/16"	1-1/8"	Yes	Extra	1	—
—	5/16"	1-1/8"	Yes	Extra	—	38687
ND5161401	5/16"	1-7/16"	No	Extra	1	—
NS381401MAG	3/8"	1-1/8"	Yes	Extra	1	38688
ND31601	3/8"	1-1/2"	No	Extra	1	—
ND7161501	7/16"	2"	No	Extra	1	—

## QUICK-CHANGE NUTSETTERS



Pkg. Item #	Size	Length	Magnetic	Hardness	Pkg. Qty.	Bulk Item #
—	8mm	1-5/8"	Yes	Extra	—	38328
—	10mm	1-7/8"	Yes	Extra	—	38329
—	1/4"	1-5/8"	Yes	Extra	—	31450
—	1/4"	1-5/8"	No	Extra	—	29090
NS14201	1/4"	2"	Yes	Extra	1	37427
NS1429601	1/4"	2-9/16"	Yes	Extra	1	37582
—	1/4"	2-9/16"	No	Extra	—	37585
—	5/16"	1-5/8"	Yes	Extra	—	31452
—	5/16"	1-5/8"	No	Extra	—	29091
NS51629601	5/16"	2-9/16"	Yes	Extra	1	37583
—	5/16"	4"	Yes	Extra	—	38642
—	3/8"	1-7/8"	Yes	Extra	—	36165
NS381401	3/8"	1-7/8"	No	Extra	1	—
—	3/8"	1-7/8"	No	Extra	—	36166
NS3829601	3/8"	2-9/16"	Yes	Extra	1	37584
NS716201MAG	7/16"	2"	Yes	Extra	1	37893
NS71629601	7/16"	2-9/16"	Yes	Extra	1	38639

## NO-ROUND NUTSETTERS

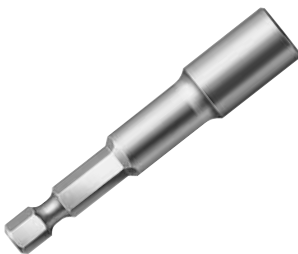

Pkg. Item #	Size	Length	Magnetic	Hardness	Pkg. Qty.	Bulk Item #
NS11401	1/4"	1-5/8"	Yes	Extra	1	61938
—	1/4"	2"	Yes	Extra	—	61942
—	1/4"	2-9/16"	Yes	Extra	—	61943
NS51601	5/16"	1-5/8"	Yes	Extra	1	61939
—	5/16"	2-9/16"	Yes	Extra	—	61944
NS3801	3/8"	1-7/8"	Yes	Extra	1	61940
—	7/16"	2"	Yes	Extra	—	61941
—	7/16"	2-9/16"	Yes	Extra	—	61946

### NO-ROUND NUTSETTER



**SUPERIOR GRIP**  
Contact point at middle of hex avoids stripping

NOTE: Bulk items can be ordered in multiples of one where quantity is not noted. Minimum quantities may apply.

# BIT HOLDERS AND SCREWGUIDES

## BIT HOLDERS



Pkg. Item #	Description	Length	Shank	Hardness	Pkg. Qty.	Bulk Item #
<b>BMAG1</b>	Mag grip holder (set)	-	1/4"	Extra	-	-
<b>CC60491</b>	Compact drive guide	3-1/4"	1/4"	Extra	1	-
<b>CC60493</b>	Standard drive guide	6"	1/4"	Extra	1	-
<b>CC60482</b>	2" magnetic bit tip holder	2"	1/4"	Extra	1	-
<b>CC60483</b>	3" magnetic bit tip holder	3-1/4"	1/4"	Extra	1	-
<b>CC60486</b>	6" magnetic bit tip holder	6"	1/4"	Extra	1	27750
-	2" magnetic bit holder impact	2"	1/4"	Impact Tough™	-	27287
-	Standard with c-ring	2-7/8"	1/4"	Extra	-	27690
-	Standard with c-ring	4"	1/4"	Extra	-	27710
-	Standard with c-ring	5"	1/4"	Extra	-	27730
-	Standard with c-ring	11"	1/4"	Extra	-	27792

## ONE-PIECE CONSTRUCTION BIT HOLDERS



Pkg. Item #	Description	Length	Shank	Hardness	Pkg. Qty.	Bulk Item #
-	One-piece construction non-magnetic bit holder	2-1/8"	1/4"	Extra	-	38215
-	One-piece construction magnetic bit holder	2-1/8"	1/4"	Extra	-	40831
-	One-piece construction magnetic bit holder	3"	1/4"	Extra	-	40833
<b>CC60483</b>	One-piece construction magnetic bit holder (without c-ring retainer)	2-7/8"	1/4"	Extra	1	39972

## HELIX INSERT BITS (SILICON BRONZE) BIT HOLDER



Pkg. Item #	Description	Length	Shank	Hardness	Pkg. Qty.	Bulk Item #
-	Two-piece magnetic bit holder with screw cap (silicon bronze)	3"	1/4"	Extra	-	38310

## SCREW-CAP STYLE BIT HOLDER



Pkg. Item #	Description	Length	Shank	Hardness	Pkg. Qty.	Bulk Item #
-	Screw-cap style bit holder, magnetic	2-3/16"	1/4"	Extra	-	26791



DRILLING AND FASTENING  
SCREWDRIIVER BITS

NOTE: Bulk items can be ordered in multiples of one where quantity is not noted. Minimum quantities may apply.



**BOSCH**  
Invented for life

## BIT HOLDERS AND SCREWGUIDES (CONTINUED)

### MALE SQUARE DRIVE FOR SOCKETS



Pkg. Item #	Description	Length	Shank	Hardness	Pkg. Qty.	Bulk Item #
-	1/4" square drive socket adapter × 1-1/8"	1-1/8"	1/4"	Extra	-	34609
-	1/4" square drive socket adapter × 2"	2"	1/4"	Extra	-	34610
<b>SA2000</b>	3/8" square drive socket adapter × 2"	2"	3/8"	Extra	1	34611

### FEMALE SQUARE DRIVE FOR SOCKETS



Pkg. Item #	Description	Length	Shank	Hardness	Pkg. Qty.	Bulk Item #
-	1/4" square drive bit holder × 1-1/8" for 1/4" hex bits	1-1/8"	1/4"	Extra	-	31894
-	3/8" square drive bit holder × 1-1/8" for 1/4" hex bits	1-1/8"	3/8"	Extra	-	31895
-	3/8" square drive bit holder × 1-3/8" for 5/16" hex bits	1-3/8"	3/8"	Extra	-	31896
-	1/2" square drive bit holder × 1-7/16" for 5/16" hex bits	1-7/16"	1/2"	Extra	-	31897

NOTE: Bulk items can be ordered in multiples of one where quantity is not noted. Minimum quantities may apply.

# SETS



SBID21



CC2460



SBID9



CC2490



T4021

Item #	Hardness	# of Pieces	Includes	Case Type
SBID9	Extra	9	<b>2" Power Bits:</b> (1) P2, (1) R2, (1) SL6-8, (1) SL 8-10; <b>Magnetic Nutsetters:</b> (1) 1/4", (1) 5/16", (1) 3/8"; <b>Hex Shank Drill Bits:</b> (1) 1/16", (1) 1/8"	Pouch
SBID20	Impact Tough™	20	<b>Insert Bits:</b> (2) P2, (1) P3, (1) R2, (1) R3, (1) T20, (1) T25; <b>2" Power Bits:</b> (1) P2, (1) P3, (1) R2, (1) T15, (1) T20, (1) T25; <b>3.5" Power Bits:</b> (1) P2, (1) R2, (1) T25; <b>2" Magnetic Nutsetters:</b> (1) 1/4", (1) 5/16", (1) 3/8", (1) magnetic bit holder	—
SBID21	Impact Tough™	21	<b>Insert Bits:</b> (1) P1, (4) P2, (2) P3, (1) P2R, (1) R1, (4) R2, (1) R3, (1) T15, (2) T20, (2) T25, (1) T30; (1) magnetic bit holder	Magnetic
SBID32	Impact Tough™	32	<b>Insert Bits:</b> (2) P1, (5) P2, (3) P3, (1) P2R, (1) R1, (3) R2, (1) R3, (1) T15, (2) T20, (2) T25, (1) T30; <b>2" Power Bits:</b> (3) P2, (1) P3, (2) R2, (2) T25; <b>3-1/2" Power Bit:</b> (1) P2R2; <b>Impact Tough™ Magnetic Nutsetter:</b> (1) 1/4"	Hard plastic
T4021	Extra	21	(1) finder driver; <b>Insert Bits:</b> (7) P2, (4) R2, (1) SL6-8, (1) SL8-10, (1) SL10-12; <b>2" Power Bits:</b> (3) P2- 2", (3) R2-2"	Pouch
T4030	Extra	30	<b>2" Power Bits:</b> (2) P1, (6) P2, (3) P3, (5) R2, (3) R3, (2) T15, (2) T20, (2) T25, (1) SL6-8, (1) SL8-10, (1) SL10-12; <b>Magnetic Nutsetters:</b> (1) 1/4", (1) 5/16"	Magnetic
T4047	Extra	47	<b>Insert Bits:</b> (1) P1, (12) P2, (1) P3, (1) T15, (1) T20, (1) T25, (1) SL6-8, (1) SL8-10, (1) SL10-12, (1) R1, (10) R2, (1) R3; <b>2" Power Bits:</b> (6) P2, (4) R2; (2) SL8-10; <b>Magnetic Nutsetters:</b> (1) 1/4", (1) 5/16"; (1) finder driver	Hard Plastic
41786	Extra	29	<b>Insert Bits:</b> (1) P0, (1) P1, (1) P2, (1) P3, (1) PZ1, (1) PZ2, (1) R0, (1) R1, (1) R2, (1) R3, (1) T10, (1) T15, (1) T20, (1) T25, (1) T30, (1) T40; (1) SL0-1, (1) SL3-4, (1) SL5-6, (1) SL8-10, (1) SL12-14; <b>Allen® Insert Bits:</b> (1) 5/64", (1) 3/32", (1) 7/64", (1) 1/8", (1) 9/64"; (1) 7" magnetic screwdriver, (1) 1/4" socket adapter, (1) magnetic bit holder	Hard plastic
42826	Extra	40	<b>Insert Bits:</b> (1) P0, (1) P1, (1) P2, (1) P3, (1) PZ1, (1) PZ2, (1) R0, (1) R1, (1) R2, (1) R3, (1) T10, (1) T15, (1) T20, (1) T25, (1) T27, (1) T30, (1) T40, (1) SL0-1, (1) SL3-4, (1) SL5-6, (1) SL8-10, (1) SL12-14; <b>Allen® Insert Bits:</b> (1) 5/64", (1) 3/32", (1) 7/64", (1) 1/8", (1) 9/64", (1) 5/32", (1) 3/16", (1) 7/32", (1) 1/4", (1) 2.5mm, (1) 3mm, (1) 4mm, (1) 5mm, (1) 6mm; (1) 1" clutch, (1) 7" magnetic screwdriver, (1) 1/4" socket adapter, (1) magnetic bit holder	Hard plastic
48240	Extra	29	<b>Insert Bits:</b> (1) T9H, (1) T10H, (1) T15H, (1) T20H, (1) T25H, (1) T27H, (1) T30H, (1) T40H, (1) PZ2, (1) R1, (1) R2; <b>Torq-Set®:</b> (1) #5, (1) #8; <b>Tri-Wing®:</b> (1) #4, (1) #5, (1) #6, (1) #8, (1) #10; <b>Allen® Security:</b> (1) 1/8", (1) 9/64", (1) 5/32", (1) 3/16", (1) 7/32", (1) 1/4", (1) 5/16", (1) 3/8"; (1) 7" magnetic screwdriver, (1) magnetic bit holder, (1) 1/4" socket adapter	Hard plastic
CC2100	Extra	5	(1) Click-Change chuck; <b>Insert Bits:</b> (1) P1, (2) P2, (1) R2	—
CC2110	Extra	8	(1) Click-Change chuck; <b>Hex Shank Drill Bits:</b> (1) 1/16", (1) 3/32", (1) 1/8", (1) 5/32", (1) 3/16", (1) 7/32", (1) 1/4"	—
CC2130	Extra	27	(1) Click-Change chuck; <b>Hex Shank Drill Bits:</b> (1) 1/16", (1) 3/32", (1) 1/8", (1) 5/32", (1) 3/16"; <b>Magnetic Nutsetters:</b> (1) 1/4", (1) 5/16"; <b>Socket Adapters:</b> (1) 1/4", (1) 3/8"; (1) magnetic bit holder; <b>Insert Bits:</b> (2) P1, (6) P2, (1) P3, (1) SL6-8, (1) SL8-10, (1) SL10-12, (1) R1, (3) R2	Hard plastic
CC2400	Extra	5	<b>1/4" Hex Shank Drill Bits:</b> (1) 1/16", (1) 3/32", (1) 1/8", (1) 5/32", (1) 3/16"	—
CC2430	Extra	3	<b>Self-Centering Drill Bits with 1/4" Hex Shank:</b> (1) #6, (1) #8, (1) #10	—
CC2460	Extra	7	<b>1/4" Hex Shank Drill Bits:</b> (1) #6, (1) #8, (1) #10; <b>2" Power Bits:</b> (1) P1, (2) P2, (1) R2 plus (1) 1/8" Allen® wrench	—
CC2470	Extra	12	(1) finder driver, (1) P1, (5) P2, (1) P3, (1) SL6-8, (1) SL10-12, (1) R1, (1) R2	—
CC2490	Extra	3	<b>Magnetic Nutsetters:</b> (1) 1/4", (1) 5/16", (1) 3/8"	—
CC60467	Extra	2	<b>Double-Ended Bits:</b> (1) DEB P1/SL6-8, (1) DEB P2/SL8-10-3-1/2" length	—
CC60464	Extra	3	<b>Double-Ended Bits:</b> (1) DEB P1/SL6-8, (1) DEB P2/SL8-10, (1) DEB P3/SL10-12-2" length	—
CC90396	Extra	6	<b>Insert Bits:</b> (1) T10, (1) T15, (1) T20, (1) T25, (1) T30, (1) T40	—
CC60392	Extra	7	<b>Insert Bits:</b> (1) 9/64", (1) 5/64", (1) 3/32", (1) 1/8", (1) 5/32", (1) 3/16", (1) 7/64"	—



**DRILLING AND FASTENING**  
SCREWDRIVER BITS



**BOSCH**  
Invented for life



# METAL DRILL BITS



The Bosch line of metal drill bits offers a solution for every professional application. Each bit is manufactured to exacting specifications and features split points that deliver fast, easy starts. Plus for reduced bit walking and elimination of a center punch requirement.

DRILLING AND FASTENING  
METAL DRILL BITS

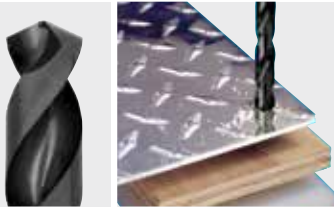

## BLACK OXIDE FOR GENERAL-PURPOSE DRILLING

- ▶ No-skate tip for fast, easy starts that reduce bit walking
- ▶ Available in jobber length, stubby length, extended length (aircraft) and 1/2" reduced shank (Silver and Deming)

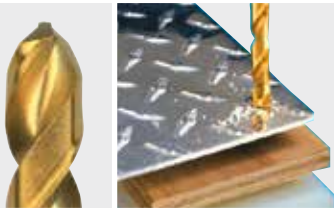

## TITANIUM FOR HEAVY-DUTY REPETITIVE DRILLING

- ▶ Lasts up to three times longer than high-speed steel bits
- ▶ Surface hardened to penetrate tough materials
- ▶ Available in jobber length with 3/8" reduced shank

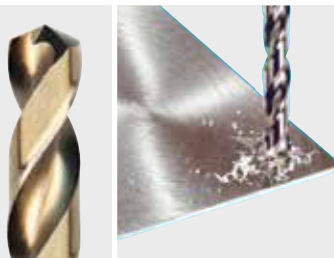





## COBALT FOR HEAVY-DUTY DRILLING IN EXTREMELY HARD OR ABRASIVE MATERIALS

- ▶ Withstands high-temperature applications for extended periods of time (up to 1,100°F)
- ▶ Thick web design adds stability to bit in tough applications
- ▶ Surface hardened to penetrate tough abrasive materials
- ▶ Available in jobber length, full shank



## MATERIAL CHART

	Wood	Plastic	Light Gauge Metal	High Carbon Steel	Aluminum and Alloy Steel	Cast Iron	Stainless Steel
<b>Black Oxide</b> 	●	●	●	●	◐	○	○
<b>Titanium</b> 	●	●	●	●	◐	●	◐
<b>Cobalt</b> 	◐	◐	●	●	●	●	●
<b>Daredevil® MultiPurpose™*</b> 	●	●	●	●	●	◐	○
<b>MultiConstruction™*</b> 	●	●	●	●	●	◐	○

● = Recommended ◐ = Acceptable ○ = Not Recommended

\* Daredevil® MultiPurpose™ and MultiConstruction™ drill bits are available on page 8

# IMPACT TOUGH™ DRILL BITS



**LONG FLUTE**  
For most effective removal  
and universal drilling

**NO-SKATE TIP**  
For fast, easy starts  
that reduce bit walking



**IMPACT-RATED SHANK**  
For use in both drills  
and impact drivers

**BLACK OXIDE AND  
TITANIUM COATINGS**  
For longer life

**NEW**

## IMPACT TOUGH™ DRILL BITS

Item #	Coating	Quantity	Diameter	Overall Length	Shank	Bulk Item	Bulk Qty
BL2131IM	Black Oxide	1	1/16"	1-7/8"	1/4" hex	BL4131IM	12
BL2132IM	Black Oxide	1	5/64"	2"	1/4" hex	BL4132IM	12
BL2133IM	Black Oxide	1	3/32"	2-1/4"	1/4" hex	BL4133IM	12
BL2134IM	Black Oxide	1	7/64"	2-5/8"	1/4" hex	BL4134IM	12
BL2135IM	Black Oxide	1	1/8"	2-3/4"	1/4" hex	BL4135IM	12
BL2136IM	Black Oxide	1	9/64"	2-7/8"	1/4" hex	BL4136IM	12
BL2137IM	Black Oxide	1	5/32"	3-1/8"	1/4" hex	BL4137IM	12
BL2138IM	Black Oxide	1	11/64"	3-1/4"	1/4" hex	BL4138IM	12
BL2139IM	Black Oxide	1	3/16"	3-1/2"	1/4" hex	BL4139IM	12
BL2140IM	Black Oxide	1	13/64"	3-5/8"	1/4" hex	BL4140IM	12
BL2141IM	Black Oxide	1	7/32"	3-3/4"	1/4" hex	BL4141IM	12
BL2143IM	Black Oxide	1	1/4"	4"	1/4" hex	BL4143IM	12
BL2147IM	Black Oxide	1	5/16"	4-1/2"	1/4" hex	BL4147IM	6
BL2151IM	Black Oxide	1	3/8"	5"	1/4" hex	BL4151IM	6
BL2155IM	Black Oxide	1	7/16"	5-1/2"	1/4" hex	BL4155IM	6
BL2159IM	Black Oxide	1	1/2"	6"	1/4" hex	BL4159IM	6
TI2131IM	Titanium	1	1/16"	1-7/8"	1/4" hex	TI4131IM	12
TI2132IM	Titanium	1	5/64"	2"	1/4" hex	TI4132IM	12
TI2133IM	Titanium	1	3/32"	2-1/4"	1/4" hex	TI4133IM	12
TI2134IM	Titanium	1	7/64"	2-5/8"	1/4" hex	TI4134IM	12
TI2135IM	Titanium	1	1/8"	2-3/4"	1/4" hex	TI4135IM	12
TI2136IM	Titanium	1	9/64"	2-7/8"	1/4" hex	TI4136IM	12
TI2137IM	Titanium	1	5/32"	3-1/8"	1/4" hex	TI4137IM	12
TI2138IM	Titanium	1	11/64"	3-1/4"	1/4" hex	TI4138IM	12
TI2139IM	Titanium	1	3/16"	3-1/2"	1/4" hex	TI4139IM	12
TI2140IM	Titanium	1	13/64"	3-5/8"	1/4" hex	TI4140IM	12
TI2141IM	Titanium	1	7/32"	3-3/4"	1/4" hex	TI4141IM	12
TI2143IM	Titanium	1	1/4"	4"	1/4" hex	TI4143IM	12
TI2147IM	Titanium	1	5/16"	4-1/2"	1/4" hex	TI4147IM	6
TI2151IM	Titanium	1	3/8"	5"	1/4" hex	TI4151IM	6
TI2155IM	Titanium	1	7/16"	5-1/2"	1/4" hex	TI4155IM	6
TI2159IM	Titanium	1	1/2"	6"	1/4" hex	TI4159IM	6

NOTE: 1/16"–7/64": 118° point; 1/8" and larger: 135° point; all 1/4" hex shank

## IMPACT TOUGH™ DRILL BIT SETS

Item #	Coating	# of Pieces	Includes	Case Type
BL5IM	Black Oxide	5	3/32", 1/8", 5/32", 3/16", 1/4"	Plastic tube
BL9IM	Black Oxide	9	1/16", 3/32", 1/8", 5/32", 3/16", 7/32", 1/4", 5/16", 3/8"	–
TI5IM	Titanium	5	3/32", 1/8", 5/32", 3/16", 1/4"	Plastic tube
TI9IM	Titanium	9	1/16", 3/32", 1/8", 5/32", 3/16", 7/32", 1/4", 5/16", 3/8"	–



**DRILLING AND FASTENING**  
METAL DRILL BITS



**BOSCH**  
Invented for life

# BLACK OXIDE DRILL BITS

## FRACTIONAL JOBBER LENGTH BLACK OXIDE DRILL BITS



Item #	Qty.	Diameter	Overall Length	Shank	Bulk Item #	Bulk Qty.
BL2131	2	1/16"	1-7/8"	1/16"	BL4131	12
BL2132	2	5/64"	2"	5/64"	BL4132	12
BL2133	2	3/32"	2-1/4"	3/32"	BL4133	12
BL2134	2	7/64"	2-5/8"	7/64"	BL4134	12
BL2135	2	1/8"	2-3/4"	1/8"	BL4135	12
BL2136	1	9/64"	2-7/8"	9/64"	BL4136	12
BL2137	1	5/32"	3-1/8"	5/32"	BL4137	12
BL2138	1	11/64"	3-1/4"	11/64"	BL4138	12
BL2139	1	3/16"	3-1/2"	3/16"	BL4139	12
BL2140	1	13/64"	3-5/8"	13/64"	BL4140	12
BL2141	1	7/32"	3-3/4"	7/32"	BL4141	12
BL2142	1	15/64"	3-7/8"	15/64"	BL4142	12
BL2143	1	1/4"	4"	1/4"	BL4143	12
BL2144	1	17/64"	4-1/8"	17/64"	BL4144	6
BL2145	1	9/32"	4-1/4"	9/32"	BL4145	6
BL2146	1	19/64"	4-3/8"	19/64"	BL4146	6
BL2147	1	5/16"	4-1/2"	5/16"	BL4147	6
BL2148	1	21/64"	4-5/8"	21/64"	BL4148	6
BL2149	1	11/32"	4-3/4"	11/32"	BL4149	6
BL2150	1	23/64"	4-7/8"	23/64"	BL4150	6
BL2151	1	3/8"	5"	3/8"	BL4151	6
BL2152	1	25/64"	5-1/8"	3/8"	BL4152	6
BL2153	1	13/32"	5-1/4"	3/8"	BL4153	6
BL2154	1	27/64"	5-3/8"	3/8"	BL4154	6
BL2155	1	7/16"	5-1/2"	3/8"	BL4155	6
BL2156	1	29/64"	5-5/8"	3/8"	BL4156	6
BL2157	1	15/32"	5-3/4"	3/8"	BL4157	6
BL2158	1	31/64"	5-7/8"	3/8"	BL4158	6
BL2159	1	1/2"	6"	3/8"	BL4159	6

NOTE: 1/64"-7/64": 118° point; 1/8" and larger: 135° point; three flat shank 3/16" and larger

## EXTRA LENGTH (AIRCRAFT) BLACK OXIDE DRILL BITS



Item #	Quantity	Diameter	Overall Length	Shank
BL2631	1	1/16"	6"	1/16"
BL2731	1	1/16"	12"	1/16"
BL2632	1	5/64"	6"	5/64"
BL2633	1	3/32"	6"	3/32"
BL2634	1	7/64"	6"	7/64"
BL2635	1	1/8"	6"	1/8"
BL2735	1	1/8"	12"	1/8"
BL2636	1	9/64"	6"	9/64"
BL2637	1	5/32"	6"	5/32"
BL2638	1	11/64"	6"	11/64"
BL2639	1	3/16"	6"	3/16"
BL2739	1	3/16"	12"	3/16"
BL2640	1	13/64"	6"	13/64"
BL2641	1	7/32"	6"	7/32"
BL2642	1	15/64"	6"	15/64"
BL2643	1	1/4"	6"	1/4"

NOTE: 3/64"-7/64": 118° tip; 1/8" and larger: 135° point; all round shank

## EXTRA LENGTH (AIRCRAFT) BLACK OXIDE DRILL BITS (CONTINUED)

Item #	Quantity	Diameter	Overall Length	Shank
BL2743	1	1/4"	12"	1/4"
BL2647	1	5/16"	6"	5/16"
BL2747	1	5/16"	12"	5/16"
BL2651	1	3/8"	6"	3/8"
BL2751	1	3/8"	12"	3/8"
BL2655	1	7/16"	6"	7/16"
BL2755	1	7/16"	12"	7/16"
BL2759	1	1/2"	12"	1/2"

## FRACTIONAL 1/2" REDUCED SHANK (SILVER & DEMING) BLACK OXIDE DRILL BITS



Item #	Quantity	Diameter	Overall Length	Shank
BL2160	1	33/64"	6"	1/2"
BL2161	1	17/32"	6"	1/2"
BL2162	1	35/64"	6"	1/2"
BL2163	1	9/16"	6"	1/2"
BL2164	1	37/64"	6"	1/2"
BL2165	1	19/32"	6"	1/2"
BL2166	1	39/64"	6"	1/2"
BL2167	1	5/8"	6"	1/2"
BL2168	1	41/64"	6"	1/2"
BL2169	1	21/32"	6"	1/2"
BL2171	1	11/16"	6"	1/2"
BL2172	1	45/64"	6"	1/2"
BL2175	1	3/4"	6"	1/2"
BL2176	1	49/64"	6"	1/2"
BL2179	1	13/16"	6"	1/2"
BL2177	1	25/32"	6"	1/2"
BL2183	1	7/8"	6"	1/2"
BL2185	1	29/32"	6"	1/2"
BL2187	1	15/16"	6"	1/2"
BL2191	1	1"	6"	1/2"
BL2192	1	1-1/64"	6"	1/2"
BL2193	1	1-1/32"	6"	1/2"
BL2195	1	1-1/16"	6"	1/2"
BL2197	1	1-3/32"	6"	1/2"
BL2199	1	1-1/8"	6"	1/2"
BL2203	1	1-3/16"	6"	1/2"
BL2207	1	1-1/4"	6"	1/2"
BL2211	1	1-5/16"	6"	1/2"
BL2215	1	1-3/8"	6"	1/2"
BL2219	1	1-7/16"	6"	1/2"
BL2223	1	1-1/2"	6"	1/2"

NOTE: 135° point; all round shank

## FRACTIONAL STUBBY LENGTH BLACK OXIDE DRILL BITS (BULK)



Item #	Quantity	Diameter	Overall Length	Shank
BL3135	12	1/8"	1-7/8"	1/8"
BL3139	12	3/16"	2-3/16"	3/16"
BL3143	12	1/4"	2-1/2"	1/4"

NOTE: All 135° point round shank

## LETTER SIZE BLACK OXIDE DRILL BITS (BULK)



Item #	Quantity	Diameter	Overall Length	Shank
BL4201	12	A	3-7/8"	0.2340"
BL4202	12	B	4"	0.2380"
BL4203	12	C	4"	0.2420"
BL4204	12	D	4"	0.2460"
BL4205	12	E	4"	0.2500"
BL4206	12	F	4-1/8"	0.2570"
BL4207	6	G	4-1/8"	0.2610"
BL4208	6	H	4-1/8"	0.2660"
BL4209	6	I	4-1/8"	0.2720"
BL4210	6	J	4-1/8"	0.2770"
BL4211	6	K	4-1/4"	0.2810"
BL4212	6	L	4-1/4"	0.2900"
BL4213	6	M	4-3/8"	0.2950"
BL4214	6	N	4-3/8"	0.3020"
BL4215	6	O	4-1/2"	0.3160"
BL4216	6	P	4-5/8"	0.3230"
BL4217	6	Q	4-3/4"	0.3320"
BL4218	6	R	4-3/4"	0.3390"
BL4219	6	S	4-7/8"	0.3480"
BL4220	6	T	4-7/8"	0.3580"
BL4221	6	U	5"	0.3680"
BL4222	6	V	5"	0.3770"
BL4223	6	W	5-1/8"	0.3860"
BL4224	6	X	5-1/8"	0.3970"
BL4225	6	Y	5-1/4"	0.4040"
BL4226	6	Z	5-1/4"	0.4130"

NOTE: All 135° points; all round shank

## FRACTIONAL DOUBLE-END BLACK OXIDE DRILL BITS (BULK)



Item #	Quantity	Diameter	Overall Length	Shank
BL6134	12	7/64"	1-15/16"	7/64"
BL6135	12	1/8"	2-1/8"	1/8"
BL6136	12	9/64"	2-5/32"	9/64"
BL6137	12	5/32"	2-5/32"	5/32"
BL6139	12	3/16"	2-5/16"	3/16"
BL6141	12	7/32"	2-5/16"	7/32"
BL6143	12	1/4"	2-5/16"	1/4"

NOTE: All 135° points

## WIRE GAUGE DOUBLE-END BLACK OXIDE DRILL BITS (BULK)



Item #	Quantity	Diameter	Overall Length	Shank
BL6011	12	11	2-5/16"	0.1910"
BL6020	12	20	2-5/32"	0.1610"
BL6030	12	30	2-1/8"	0.1285"

NOTE: All 135° points

## WIRE GAUGE BLACK OXIDE DRILL BITS (BULK)



Item #	Quantity	Diameter	Overall Length	Shank
BL4001	12	1	3-7/8"	0.2280"
BL4002	12	2	3-7/8"	0.2210"
BL4003	12	3	3-3/4"	0.2130"
BL4004	12	4	3-3/4"	0.2090"
BL4005	12	5	3-3/4"	0.2055"
BL4006	12	6	3-3/4"	0.2040"
BL4007	12	7	3-5/8"	0.2010"
BL4008	12	8	3-5/8"	0.1990"
BL4009	12	9	3-5/8"	0.1960"
BL4010	12	10	3-5/8"	0.1935"
BL4011	12	11	3-1/2"	0.1910"
BL4012	12	12	3-1/2"	0.1890"
BL4013	12	13	3-1/2"	0.1850"
BL4014	12	14	3-3/8"	0.1820"
BL4015	12	15	3-3/8"	0.1800"
BL4016	12	16	3-3/8"	0.1770"
BL4017	12	17	3-3/8"	0.1730"
BL4018	12	18	3-1/4"	0.1695"
BL4019	12	19	3-1/4"	0.1660"
BL4020	12	20	3-1/4"	0.1610"
BL4021	12	21	3-1/4"	0.1590"
BL4022	12	22	3-1/8"	0.1570"
BL4023	12	23	3-1/8"	0.1540"
BL4024	12	24	3-1/8"	0.1520"
BL4025	12	25	3"	0.1495"
BL4026	12	26	3"	0.1470"
BL4027	12	27	3"	0.1440"
BL4028	12	28	2-7/8"	0.1405"
BL4029	12	29	2-7/8"	0.1360"
BL4030	12	30	2-3/4"	0.1285"
BL4031	12	31	2-3/4"	0.1200"
BL4032	12	32	2-3/4"	0.1160"
BL4033	12	33	2-5/8"	0.1130"
BL4034	12	34	2-5/8"	0.1110"
BL4035	12	35	2-5/8"	0.1100"
BL4036	12	36	2-1/2"	0.1065"
BL4037	12	37	2-1/2"	0.1040"
BL4038	12	38	2-1/2"	0.1015"
BL4039	12	39	2-3/8"	0.0995"
BL4040	12	40	2-3/8"	0.0980"
BL4041	12	41	2-3/8"	0.0960"
BL4042	12	42	2-1/4"	0.0935"
BL4043	12	43	2-1/4"	0.0890"
BL4044	12	44	2-1/8"	0.0860"
BL4045	12	45	2-1/8"	0.0820"
BL4046	12	46	2-1/8"	0.0810"
BL4047	12	47	2"	0.0785"
BL4048	12	48	2"	0.0760"
BL4049	12	49	2"	0.0730"
BL4050	12	50	2"	0.0700"
BL4051	12	51	2"	0.0670"
BL4052	12	52	1-7/8"	0.0635"
BL4053	12	53	1-7/8"	0.0595"
BL4054	12	54	1-7/8"	0.0550"
BL4055	12	55	1-7/8"	0.0520"
BL4056	12	56	1-3/4"	0.0465"
BL4057	12	57	1-3/4"	0.0430"
BL4058	12	58	1-5/8"	0.0420"
BL4059	12	59	1-5/8"	0.0410"
BL4060	12	60	1-5/8"	0.0400"

NOTE: 31-60: 118° point; 1-30: 135° point



**DRILLING AND FASTENING  
METAL DRILL BITS**



**BOSCH**  
Invented for life



# BLACK OXIDE DRILL BIT SETS



BL14



BL21A



BL29



BL0026

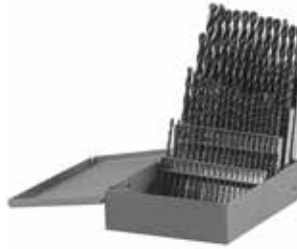

BL0060

Item #	# of Pieces	Includes	Case Type
BL14	14	1/16", 5/64", 3/32", 7/64", (2) 1/8", 9/64", 5/32", 3/16", 7/32", 1/4", 5/16", 3/8", 1/2"	Clear front
BL21A	21	(2) 1/16", (2) 5/64", 3/32", 7/64", (2) 1/8", 9/64", 5/32", 11/64", (2) 3/16", 13/64", 7/32", 15/64", (2) 1/4", 5/16", 3/8", 1/2"	Clear front
BL29	29	1/16", 5/64", 3/32", 7/64", 1/8", 9/64", 5/32", 11/64", 3/16", 13/64", 7/32", 15/64", 1/4", 17/64", 9/32", 19/64", 5/16", 21/64", 11/32", 23/64", 3/8", 25/64", 13/32", 27/64", 7/16", 29/64", 15/32", 31/64", 1/2"	Clear front
BL0026	26	Letter size jobber length A to Z	Metal index
BL0060	60	Wire gauge jobber length sizes #1 to #60	Metal index

**DRILLING AND FASTENING**  
 METAL DRILL BITS

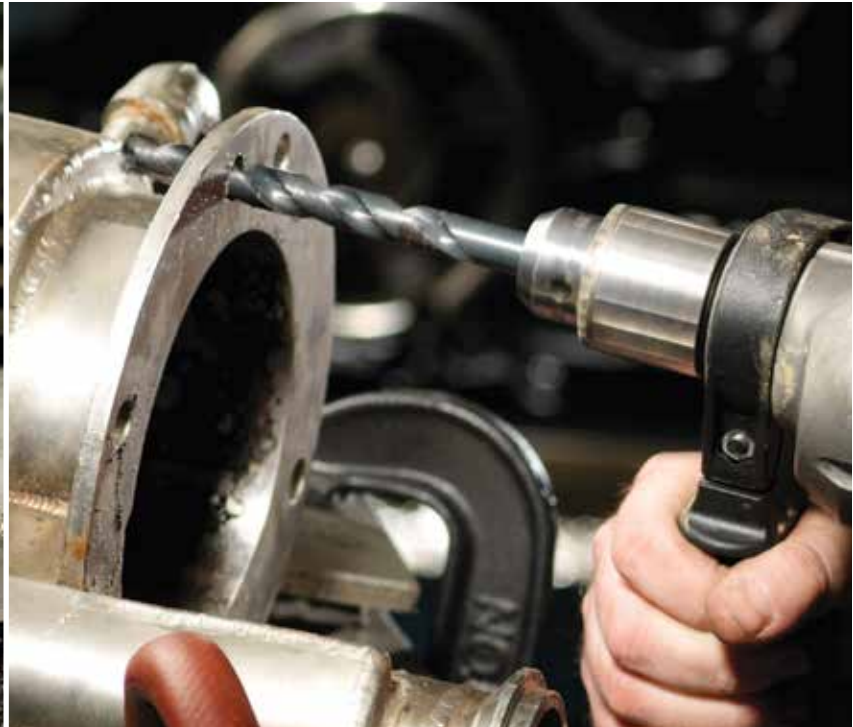



# TITANIUM DRILL BITS

## TITANIUM-COATED DRILL BITS



Item #	Qty.	Diameter	Overall Length	Shank	Bulk Item #	Bulk Qty.
TI2131	2	1/16"	1-7/8"	1/16"	TI4131	12
TI2132	2	5/64"	2"	5/64"	TI4132	12
TI2133	2	3/32"	2-1/4"	3/32"	TI4133	12
TI2134	2	7/64"	2-5/8"	7/64"	TI4134	12
TI2135	2	1/8"	2-3/4"	1/8"	TI4135	12
TI2136	1	9/64"	2-7/8"	9/64"	TI4136	12
TI2137	1	5/32"	3-1/8"	5/32"	TI4137	12
TI2138	1	11/64"	3-1/4"	11/64"	TI4138	12
TI2139	1	3/16"	3-1/2"	3/16"	TI4139	12
TI2140	1	13/64"	3-5/8"	13/64"	TI4140	12
TI2141	1	7/32"	3-3/4"	7/32"	TI4141	12
TI2142	1	15/64"	13-7/8"	15/64"	TI4142	12
TI2143	1	1/4"	4"	1/4"	TI4143	12
TI2144	1	17/64"	4-1/8"	17/64"	TI4144	6
TI2145	1	9/32"	4-1/4"	9/32"	TI4145	6
TI2146	1	19/64"	4-3/8"	19/64"	TI4146	6
TI2147	1	5/16"	4-1/2"	5/16"	TI4147	6
TI2148	1	21/64"	4-5/8"	21/64"	TI4148	6
TI2149	1	11/32"	4-3/4"	11/32"	TI4149	6
TI2150	1	23/64"	4-7/8"	23/64"	TI4150	6
TI2151	1	3/8"	5"	3/8"	TI4151	6
TI2152	1	25/64"	5-1/8"	3/8"	TI4152	6
TI2153	1	13/32"	5-1/4"	3/8"	TI4153	6
TI2154	1	27/64"	5-3/8"	3/8"	TI4154	6
TI2155	1	7/16"	5-1/2"	3/8"	TI4155	6
TI2156	1	29/64"	5-5/8"	3/8"	TI4156	6
TI2157	1	15/32"	5-3/4"	3/8"	TI4157	6
TI2158	1	31/64"	5-7/8"	3/8"	TI4158	6
TI2159	1	1/2"	6"	3/8"	TI4159	6

NOTE: 1/16"–7/64": 118° point; 1/8" and larger: 135° point; three flat shank 3/16" and larger



**DRILLING AND FASTENING**  
METAL DRILL BITS

## TITANIUM-COATED DRILL BIT SETS



TI14



TI21



TI29

Item #	# of Pieces	Includes	Case Type
TI14	14	1/16", 5/64", 3/32", 7/64", (2) 1/8", 9/64", 5/32", 3/16", 7/32", 1/4", 5/16", 3/8", 1/2"	Clear front
TI21A	21	(2) 1/16", (2) 5/64", 3/32", 7/64", (2) 1/8", 9/64", 5/32", 11/64", (2) 3/16", 13/64", 7/32", 15/64", (2) 1/4", 5/16", 3/8", 1/2"	Clear front
TI29	29	1/16", 5/64", 3/32", 7/64", 1/8", 9/64", 5/32", 11/64", 3/16", 13/64", 7/32", 15/64", 1/4", 17/64", 9/32", 19/64", 5/16", 21/64", 11/32", 23/64", 3/8", 25/64", 13/32", 27/64", 7/16", 29/64", 15/32", 31/64", 1/2"	Clear front



**BOSCH**  
Invented for life

# COBALT DRILL BITS

## COBALT DRILL BITS



Item #	Qty.	Diameter	Overall Length	Shank	Bulk Item #	Bulk Qty.
—	—	1/64"	3/4"	1/64"	CO4128	12
—	—	1/32"	1-3/8"	1/32"	CO4129	12
—	—	3/64"	1-3/4"	3/64"	CO4130	12
<b>CO2131</b>	1	1/16"	1-7/8"	1/16"	CO4131	12
<b>CO2132</b>	1	5/64"	2"	5/64"	CO4132	12
<b>CO2133</b>	1	3/32"	2-1/4"	3/32"	CO4133	12
<b>CO2134</b>	1	7/64"	2-5/8"	7/64"	CO4134	12
<b>CO2135</b>	1	1/8"	2-3/4"	1/8"	CO4135	12
<b>CO2136</b>	1	9/64"	2-7/8"	9/64"	CO4136	12
<b>CO2137</b>	1	5/32"	3-1/8"	5/32"	CO4137	12
<b>CO2138</b>	1	11/64"	3-1/4"	11/64"	CO4138	12
<b>CO2139</b>	1	3/16"	3-1/2"	3/16"	CO4139	12
<b>CO2140</b>	1	13/64"	3-5/8"	13/64"	CO4140	12
<b>CO2141</b>	1	7/32"	3-3/4"	7/32"	CO4141	12
<b>CO2142</b>	1	15/64"	3-7/8"	15/64"	CO4142	12
<b>CO2143</b>	1	1/4"	4"	1/4"	CO4143	12

Item #	Qty.	Diameter	Overall Length	Shank	Bulk Item #	Bulk Qty.
<b>CO2144</b>	1	17/64"	4-1/8"	17/64"	CO4144	6
<b>CO2145</b>	1	9/32"	4-1/4"	9/32"	CO4145	6
<b>CO2146</b>	1	19/64"	4-3/8"	19/64"	CO4146	6
<b>CO2147</b>	1	5/16"	4-1/2"	5/16"	CO4147	6
<b>CO2148</b>	1	21/64"	4-5/8"	21/64"	CO4148	6
<b>CO2149</b>	1	11/32"	4-3/4"	11/32"	CO4149	6
<b>CO2150</b>	1	23/64"	4-7/8"	23/64"	CO4150	6
<b>CO2151</b>	1	3/8"	5"	3/8"	CO4151	6
<b>CO2152</b>	1	25/64"	5-1/8"	25/64"	CO4152	6
<b>CO2153</b>	1	13/32"	5-1/4"	13/32"	CO4153	6
<b>CO2154</b>	1	27/64"	5-3/8"	27/64"	CO4154	6
<b>CO2155</b>	1	7/16"	5-1/2"	7/16"	CO4155	6
<b>CO2156</b>	1	29/64"	5-5/8"	29/64"	CO4156	6
<b>CO2157</b>	1	15/32"	5-3/4"	15/32"	CO4157	6
<b>CO2158</b>	1	31/64"	5-7/8"	31/64"	CO4158	6
<b>CO2159</b>	1	1/2"	6"	1/2"	CO4159	6

NOTE: 1/64"–7/64": 118° point; 1/8" and larger: 135° point; three flat shank 3/16" and larger

DRILLING AND FASTENING  
METAL DRILL BITS

## COBALT DRILL BIT SETS



CO14



CO21

Item #	# of Pieces	Includes	Case Type
<b>CO14</b>	14	1/16", 5/64", 3/32", 7/64", (2) 1/8", 9/64", 5/32", 3/16", 7/32", 1/4", 5/16", 3/8", 1/2"	Clear front
<b>CO21</b>	21	(2) 1/16", (2) 5/64", 3/32", 7/64", (2) 1/8", 9/64", 5/32", 11/64", (2) 3/16", 13/64", 7/32", 15/64", (2) 1/4", 5/16", 3/8", 1/2"	Clear front

# COUNTERSINKS

## HIGH-SPEED STEEL COUNTERSINKS



Item #	Diameter	Chamfer Angle	Shank	Number of Flutes
CSH1C	1/2"	82°	1/4"	5
CSH2C	5/8"	82°	1/4"	5
CSH3C	3/4"	82°	1/4"	5

## TITANIUM-COATED COUNTERSINKS



Item #	Diameter	Chamfer Angle	Shank	Number of Flutes
CST1	1/2"	82°	1/4"	5
CST2	5/8"	82°	1/4"	5
CST3	3/4"	82°	1/4"	5

NOTE: Drill bits (or extension + drill bit) in excess of 8" should never exceed 600 RPM

# STEP DRILL BITS

The Bosch line of step drill bits offer the ability to drill multiple holes with a single bit. Cuts are clean and accurate even in the toughest material; ideal for electrical, plumbing and HVAC contractors.

**SUPER-HARD TITANIUM COATING**  
Lasts up to six times longer than high-speed steel

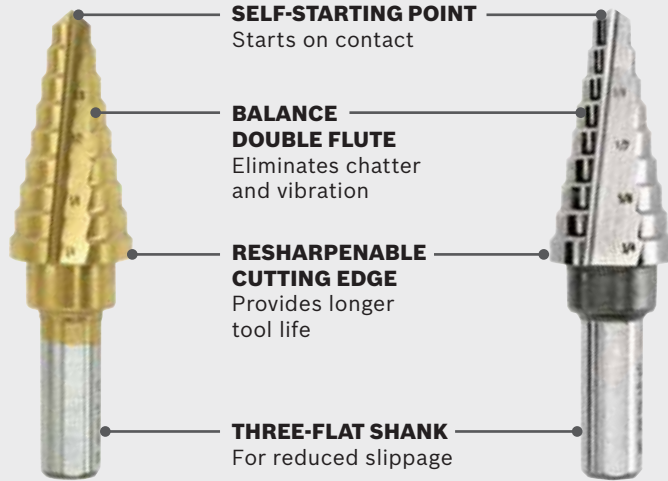

TITANIUM

HIGH-SPEED STEEL

DRILLING AND FASTENING  
METAL DRILL BITS

## IMPACT TOUGH™ STEP DRILL BITS



Item #	Diameter (Increments)	Step Depth	Number of Hole Sizes	Shank Diameter	Application	Point Type
IMSD46401	1/8"-1/2" (1/32")	1/8"	13	1/4" hex with power groove	All common drilling needs	Self-starting
IMSD46403	1/4"-3/4" (1/16")	3/8"	9	1/4" hex with power groove	Ideal for cutting medium size holes	Self-starting
IMSD46405	1/4"-7/8"-1-1/8"	5/32"	3	1/4" hex with power groove	For 1/2" and 3/4" conduit	Self-starting

NOTE: Drill bits (or extension + drill bit) in excess of 8" should never exceed 600 RPM



## HIGH-SPEED STEEL STEP DRILL BITS



Item #	Diameter (Increments)	Step Depth	Number of Hole Sizes	Shank Diameter	Application	Point Type
SDH1	1/8"-1/2" (1/32")	1/8"	13	1/4"	All common drilling needs	Self-starting
SDH6	3/16"-1/2" (1/16")	3/8"	6	1/4"	All common drilling needs	Self-starting
SDH2	3/16"-7/8" (1/16")	1/8"	12	3/8"	All common drilling needs	Self-starting
SDH3	1/4"-3/4" (1/16")	1/8"	9	3/8"	Ideal for cutting medium size holes	Self-starting
SDH4	1/4"-7/8"-1-1/8"	5/32"	3	3/8"	For 1/2" and 3/4" conduit	Self-starting
SDH10	1/4"-1-3/8" (1/8")	1/8"	10	3/8"	For 1" conduit and tubing	Self-starting
SDH8	1/2"	—	1	1/4"	Knockout	Self-starting
SDH7	9/16"-1" (1/16")	1/8"	8	3/8"	Companion bit to SDH1 for diameter range 1/8" to 1" (requires 1/2" pilot hole)	For hole enlarging
SDH9	13/16"-1-3/8" (1/16")	1/8"	10	1/2"	For 1" conduit and tubing (requires 3/4" pilot hole)	For hole enlarging
SDH5	7/8"	—	1	3/8"	Drill perfect size holes for conduit. Ideal for drawbolt and miniature pilot light holes	Self-starting

NOTE: Drill bits (or extension + drill bit) in excess of 8" should never exceed 600 RPM

## TITANIUM-COATED STEP DRILL BITS



Item #	Diameter (Increments)	Step Depth	Number of Hole Sizes	Shank Diameter	Application	Point Type
SDT1	1/8"-1/2" (1/32")	1/8"	13	1/4"	All common drilling needs	Self-starting
SDT6	3/16"-1/2" (1/16")	3/8"	6	1/4"	All common drilling needs	Self-starting
SDT2	3/16"-7/8" (1/16")	1/8"	12	3/8"	All common drilling needs	Self-starting
SDT3	1/4"-3/4" (1/16")	1/8"	9	3/8"	Ideal for cutting medium size holes	Self-starting
SDT4	1/4"-7/8"-1-1/8"	5/32"	3	3/8"	For 1/2" and 3/4" conduit	Self-starting
SDT10	1/4"-1-3/8" (1/8")	1/8"	10	3/8"	For 1" conduit and tubing	Self-starting
SDT8	1/2"	—	1	1/4"	Knockout	Self-starting
SDT7	9/16"-1" (1/16")	1/8"	8	3/8"	Companion bit to SDT1 for diameter range 1/8" to 1" (requires 1/2" pilot hole)	For hole enlarging
SDT9	13/16"-1-3/8" (1/16")	1/8"	10	1/2"	For 1" conduit and tubing (requires 3/4" pilot hole)	For hole enlarging
SDT5	7/8"	—	1	3/8"	Drill perfect size holes for conduit. Ideal for drawbolt and miniature pilot light holes	Self-starting

NOTE: Drill bits (or extension + drill bit) in excess of 8" should never exceed 600 RPM

