

Leadership By Design®



B&K offers customers various lines of reliable and competitive bath and kitchen products. With an extensive selection of goods for bath and kitchen finish as well as rough plumbing accessories, many B&K products include unique, innovative features and industry firsts. Product offering includes faucets, valves, drains and strainers, tools, plumbing repair and specialties/accessories. B&K provides contractors and homeowners alike with affordable, quality solutions.

Table of Contents



Valves

1



Strainers & Drains

11

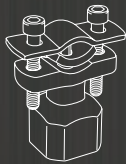

Specialty Fittings

27



Accessories & Repair

53



Tools

61

ITEM NUMBER SUFFIX CODE LEGEND

Suffix	Packaging	Description
HC	Handy Carton	Items are individually barcoded and packaged inside attractive, reach-in corrugated merchandising bins. Each HC pack carton has a full color face label with product image and description and is protected by an easy to remove tear-off over carton. Great for attractive individual product sales.
BP	Builder Pack	Items are multi-packed inside poly bags, barcoded and displayed inside attractive, reach-in merchandising cartons. Each BP pack carton has a full color face label with product image and description and is protected by a tear-off over carton. Great for contractor needs and larger projects.
RP	Retail Pack	Items are individually blister card/clam shell packed and neatly displayed inside attractive, reach-in corrugated merchandising bins. Each RP pack carton has a full color face label with an easy to remove tear-off over carton. Great for attractive individual product sales and clip strip cross merchandising.
DP	Dual Pack	Items are dual packed in blister card/clam shell and neatly displayed inside attractive, reach-in corrugated merchandising bins. Great for attractive individual product sales. Most commonly with two strainers or strainer and flange packed in one clam shell.
NL	Lead-Free	Items are constructed with brass material that has less than .025% leaded content and meet "lead-free" requirements of California, Vermont and Maryland. Items are packaged in a similar manner to our HC (Handy Carton) packaging configuration described above.



Valves

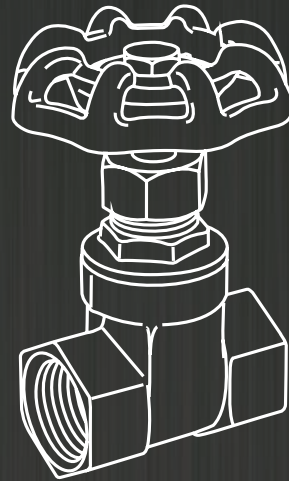

B&K Plumbing Valves are the sensible solution in flow control. Engineered for performance and affordability, B&K plumbing valves offer one of the best values on the market. Offered primarily in traditional corrugated packaging, these quality valves are available in a core selection of styles to meet most everyday plumbing needs.

Ball Valve • 400 PSI • Packing Gland • Standard Port

Brass



823



843

Item No.	Diameter	Connection	Each Wt.	Inner Qty.	Master Carton
Threaded					
907-821	1/4"	FIP x FIP	0.28	15	120
907-822	3/8"	FIP x FIP	0.29	15	120
907-823	1/2"	FIP x FIP	0.38	15	120
907-824	3/4"	FIP x FIP	0.53	10	60
907-825	1"	FIP x FIP	0.79	8	48
907-826	1 1/4"	FIP x FIP	1.07	4	24
907-827	1 1/2"	FIP x FIP	1.53	2	24
907-828	2"	FIP x FIP	2.37	2	12
Solder					
907-843	1/2"	C x C	0.29	15	120
907-844	3/4"	C x C	0.46	10	60
907-845	1"	C x C	0.72	8	48

- Rated up to 400 PSI of water, oil or air
- Packing gland stem design
- Rust resistant handle with vinyl grip sleeve
- Threaded ends made to ANSI B.10.1
- Solder ends made to ANSI B16.18

Ball Valve • 600 PSI • with Drain • Standard Port

Brass



753



553

Item No.	Diameter	Connection	Each Wt.	Inner Qty.	Master Carton
Threaded					
907-753	1/2"	FIP x FIP	0.40	10	100
907-754	3/4"	FIP x FIP	0.67	10	60
907-755	1"	FIP x FIP	0.99	6	36
Solder					
907-553	1/2"	C x C	0.40	10	100
907-554	3/4"	C x C	0.77	10	60

- Rated up to 600 PSI of water, oil or air
- Drain port allows the draining of the non-pressurized side of the valve when closed
- Rated for vacuum use up to 7 PSI
- Threaded ends made to ANSI B.10.1
- Solder ends made to ANSI B16.18

Ball Valve • PEX (Barbed)

Brass



343

Item No.	Diameter	Connection	Each Wt.	Inner Qty.	Master Carton
907-343	1/2"	PEX x PEX	0.25	10	120
907-344	3/4"	PEX x PEX	0.36	10	80

- Rated up to 400 PSI of water or air
- Made to use with potable water and for radiant heating applications
- Rust resistant handle with vinyl grip sleeve
- Quiet water flow with a superior flow rate

Ball Valve • Compression • 600 PSI

Brass



023

Item No.	Diameter	Connection	Each Wt.	Inner Qty.	Master Carton
907-023	1/2"	COMP x COMP	0.44	6	36
907-024	3/4"	COMP x COMP	0.68	6	36

- Rated up to 600 PSI of water, oil or air
- Rust resistant handle with vinyl grip sleeve
- Rated for vacuum use up to 7 PSI

Ball Valve • Schedule 40 • 150 PSI

PVC



133

Item No.	Diameter	Connection	Each Wt.	Inner Qty.	Master Carton
Threaded					
907-133	1/2"	FIP x FIP	0.20	10	100
907-134	3/4"	FIP x FIP	0.29	5	60
907-135	1"	FIP x FIP	0.43	5	40
907-136	1 1/4"	FIP x FIP	0.62	5	30
907-137	1 1/2"	FIP x FIP	0.88	4	24
907-138	2"	FIP x FIP	1.25	2	16



633

Solvent					
907-633	1/2"	S x S	0.19	10	100
907-634	3/4"	S x S	0.28	5	60
907-635	1"	S x S	0.42	5	40
907-636	1 1/4"	S x S	0.61	5	30
907-637	1 1/2"	S x S	0.86	4	24
907-638	2"	S x S	1.11	2	16

- Rated up to 150 PSI at 73°F
- White color
- Fits Schedule 40 pipe

Gate Valve • 200 PSI

Brass



Item No.	Diameter	Connection	Each Wt.	Inner Qty.	Master Carton
Threaded					
900-403	1/2"	FIP x FIP	0.51	10	100
900-404	3/4"	FIP x FIP	0.66	5	60
900-405	1"	FIP x FIP	0.90	5	40
900-406	1 1/4"	FIP x FIP	1.34	5	30
900-407	1 1/2"	FIP x FIP	1.74	4	24
900-408	2"	FIP x FIP	2.75	2	16
Solder					
900-453	1/2"	C x C	0.44	10	100
900-454	3/4"	C x C	0.57	5	60
900-455	1"	C x C	0.90	5	40

- Rated up to 200 PSI of water or air
- Forged construction for added strength
- Made for supply lines that are constantly in use
- PTFE seals
- Threaded ends made to ANSI B.10.1
- 900-453 solder ends made to ANSI B16.18
- 900-454 solder ends made to ANSI B16.19
- 900-455 solder ends made to ANSI B16.20

Stop Valve • 200 PSI • Low Pressure

Brass



Item No.	Diameter	Connection	Each Wt.	Inner Qty.	Master Carton
Threaded					
905-003	1/2"	FIP x FIP	0.46	12	72
905-004	3/4"	FIP x FIP	0.62	12	72
Solder					
905-503	1/2"	C x C	0.46	12	72
905-504	3/4"	C x C	0.57	12	72

- Rated up to 200 PSI of water or air
- Forged construction for added strength
- Used for flow control or as a shut off device
- PTFE seal
- Threaded ends made to ANSI B.10.1
- 905-503 solder ends made to ANSI B16.18
- 905-504 solder ends made to ANSI B16.19



103

Stop & Waste Valve • 200 PSI • Low Pressure

Brass

Item No.	Diameter	Connection	Each Wt.	Inner Qty.	Master Carton
----------	----------	------------	----------	------------	---------------

Threaded

905-103	1/2"	FIP x FIP	0.53	12	72
905-104	3/4"	FIP x FIP	0.70	12	72

Solder

905-603	1/2"	C x C	0.48	12	72
905-604	3/4"	C x C	0.62	12	72

- Threaded ends rated up to 200 PSI of water or air
- Solder ends rated up to 200 PSI of water, oil or air
- Forged construction for added strength
- Allows for the draining of the non-pressurized side of valve when valve is closed
- Threaded ends made to ANSI B.10.1
- 905-603 solder ends made to ANSI B16.18
- 905-604 solder ends made to ANSI B16.19



603

Boiler Drain • Male • Low Pressure

Brass

Item No.	Diameter	Connection	Each Wt.	Inner Qty.	Master Carton
----------	----------	------------	----------	------------	---------------

902-003	1/2"	MIP x 3/4" MHT	0.38	12	72
902-004	3/4"	MIP x 3/4" MHT	0.39	12	72

- For hot or cold water
- Use for hose end connections inside or outside
- Cast iron handle
- Rated up to 125 PSI
- Pipe threads made to ANSI B1.20.1
- Hose threads made to ANSI B1.20.7
- Solder ends made to ANSI B16.18



003

Hose Bibb • Standard • Male • Low Pressure

Brass

Item No.	Diameter	Connection	Each Wt.	Inner Qty.	Master Carton
----------	----------	------------	----------	------------	---------------

903-003	1/2"	MIP x 3/4" MHT	0.29	12	72
903-004	3/4"	MIP x 3/4" MHT	0.33	12	72

- For hot or cold water
- Use for hose end connections inside or outside
- Threaded end made to ANSI B.10.1



003



303



404

Hose Bib • No Kink • Low Pressure

Brass

Item No.	Diameter	Connection	Each Wt.	Inner Qty.	Master Carton
Threaded					
902-303	1/2"	MIP x 3/4" MHT	0.30	12	72
902-304	3/4"	MIP x 3/4" MHT	0.33	12	72
902-403	1/2"	FIP x 3/4" MHT	0.31	12	72
902-404	3/4"	FIP x 3/4" MHT	0.35	12	72

- For hot or cold water
- Use for hose end connections inside or outside
- Pipe threads made to ANSI B1.20.1
- Hose threads made to ANSI B1.20.7



003

Sillcock • Female • Low Pressure

Brass

Item No.	Diameter	Connection	Each Wt.	Inner Qty.	Master Carton
908-003	1/2"	FIP x 3/4" MHT	0.45	12	72
908-004	3/4"	FIP x 3/4" MHT	0.47	12	72

- For hot or cold water
- 3/4" hose connections
- Rated up to 125 PSI
- Pipe threads made to ANSI B1.20.1
- Hose threads made to ANSI B1.20.7



003

Swing Check Valve • 200 PSI

Brass

Item No.	Diameter	Connection	Each Wt.	Inner Qty.	Master Carton
Threaded					
901-003	1/2"	FIP x FIP	0.41	10	100
901-004	3/4"	FIP x FIP	0.62	5	60
901-005	1"	FIP x FIP	0.85	5	40

Solder

901-503	1/2"	C x C	0.37	10	100
901-504	3/4"	C x C	0.57	5	60

- Rated up to 200 PSI of water or air
- Forged construction for added strength
- This design prevents water from flowing backwards
- Threaded ends made to ANSI B.10.1
- 901-503 solder ends made to ANSI B16.18
- 901-504 solder ends made to ANSI B16.19
- Horizontal installation only





503

Toilet Tank Anti-Sweat Valve

Brass

Item No.	Diameter	Each Wt.	Inner Qty.	Master Carton
109-503	1/2"	0.77	0	50
109-503RP	1/2"	0.80	10	40

- Compression 1/2" (5/8" O.D.)
- Hot water adjusting screw allows hot water to be shut off or regulated



804



814



806

Float Valve • 125 PSI

Bronze

Item No.	Diameter	Connection	Each Wt.	Inner Qty.	Master Carton
Rod Size: 1/4" – 20					
109-802	3/8"	Male Inlet - Plain Outlet	0.55	12	72
109-803	1/2"	Male Inlet - Plain Outlet	0.62	12	72
109-804	3/4"	Male Inlet - Plain Outlet	0.85	6	36
109-813	1/2"	Male Inlet - Male Outlet	0.63	12	72
109-814	3/4"	Male Inlet - Male Outlet	0.88	6	36

Rod Size: 5/16" – 18

109-805	1"	Female Inlet - Plain Outlet	1.44	4	24
---------	----	-----------------------------	------	---	----

Rod Size: 3/8" – 16

109-806	1 1/4"	Female Inlet - Plain Outlet	2.25	2	16
109-807	1 1/2"	Female Inlet - Plain Outlet	2.26	2	12
109-808	2"	Female Inlet - Plain Outlet	2.58	2	12

- Flange provides support against tank walls (male)
- Serrated arm allows easy adjustment of water level
- Pivot assembly prevents breakage during freezing
- Replaceable seals
- Locknut and washer included with male inlet valves



872

Tank Float

Copper

Item No.	Diameter	Each Wt.	Inner Qty.	Master Carton
Rod Size: 1/4" – 20				
109-871	5"	0.55	0	12
109-872	6"	0.90	1	12

- High grade copper construction
- Bonded overlapping joints



862

Tank Float

Plastic

Item No.	Diameter	Each Wt.	Inner Qty.	Master Carton
Rod Size: 1/4" – 20				
109-861	5"	0.45	0	12
109-862	6"	0.55	0	12
Rod Size: 5/16" – 18				
109-863	8"	0.90	0	10
Rod Size: 3/8" – 16				
109-864	8"	8.00	0	10

- Polyethylene (PE) construction
- Corrosion resistant
- Impact resistant



852

Tank Float Rods

Brass

Item No.	Diameter	Each Wt.	Inner Qty.	Master Carton
Rod Size: 1/4" – 20				
109-851	10"	0.10	5	250
109-852	12"	0.10	5	250
Rod Size: 5/16" – 18				
109-853	12"	0.20	5	50
Rod Size: 3/8" – 16				
109-855	12"	0.30	5	40

- Solid brass
- Threaded on both ends



841

Float Rod Nuzzle Assembly

Brass

Item No.	Each Wt.	Inner Qty.	Master Carton
Rod Size: 1/4" – 20			
109-841	0.20	10	50
Rod Size: 5/16" – 18			
109-843	0.35	10	50
Rod Size: 3/8" – 16			
109-845	0.45	10	50

- Allows cattle to nuzzle float without damaging it
- Swivel screw connection to float
- Chain connects onto rod



194

Evaporator Cooler Valve

Brass

Item No.	Diameter	Connection	Each Wt.	Inner Qty.	Master Carton
102-194	3/4"	MIP x MHT	0.45	12	72
102-194HC	3/4"	MIP x MHT	0.48	0	12

- 3/4" hose thread inlet and outlet
- Six lobe cast iron handle
- 1/8" female pipe thread side tap for connection to air conditioner
- Hose threads comply with ANSI B1.20.7
- Available in Handy Carton (HC) bin box packaging



901

Evaporator Cooler Float Valve

Brass

Item No.	Diameter	Connection	Each Wt.	Inner Qty.	Master Carton
109-901	1/4"	Compression Inlet	0.40	20	80

- Brass body and rod
- 1/4" compression inlet
- Polyfloat included
- Packaged one set per polybag



203

Drum & Barrel Faucet

Plastic

Item No.	Diameter	Connection	Each Wt.	Inner Qty.	Master Carton
Plain Outlet					
109-203	3/4"	MPT Inlet	0.10	10	100
109-213	2"	MPT Inlet	0.80	0	12

- Excellent chemical resistance
- 3/4" male pipe thread inlet
- Threaded inlets comply with ANSI B1.20.1



213

Drum & Barrel Faucet

Zamac

Item No.	Diameter	Connection	Each Wt.	Inner Qty.	Master Carton
Plain Outlet					
109-204	3/4"	MPT Inlet	0.36	6	72

- Painted brass color
- For use with all petroleum products except trichlorethylene
- Not for use with water or detergents
- 3/4" male pipe thread inlet
- Convenient hole to lock handle in closed position
- Threaded inlets comply with ANSI B1.20.1



204

Drum & Barrel Faucet

Bronze

Item No.	Diameter	Connection	Each Wt.	Inner Qty.	Master Carton
Plain Outlet					
109-214	3/4"	MPT Inlet	1.23	6	36
Hose Thread Outlet					
109-224	3/4"	MPT Inlet	1.27	6	36
Female Threaded Outlet					
109-225	1"	MPT Inlet	1.89	4	24

- Quarter turn operation
- Lockable handle
- Threaded inlets comply with ANSI B1.20.1
- Hose threads comply with ANSI B1.20.7



214

224

225



Strainers & Drains

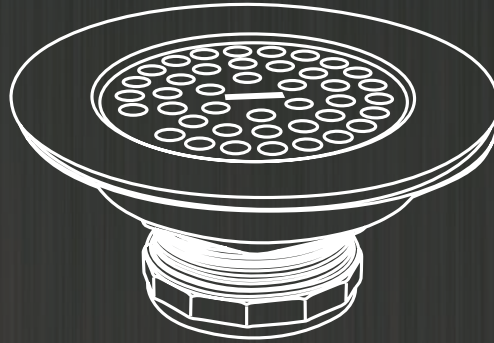

B&K Strainers & Drains are available in multiple styles for use in kitchens, baths, lavatories and more. These products are quality designed and in many cases are suitable for either residential or commercial applications. Select products are available in special display packaging suitable for peg hook and cross merchandising.

Strainers & Drains



201

Sink Strainer

Stainless Steel

Item No.	Flange Size	Each Wt.	Inner Qty.	Master Carton
With Zinc Mounting Nut and Slip Nut				
131-201	4 1/2"	0.56	0	50
131-201DP	4 1/2"	1.12	0	6
131-201RP	4 1/2"	0.56	4	12

- Rolled edge crumb cup
- Fits sinks with 3 1/2" to 4" openings



301

Sink Strainer

Chrome Plated Brass

Item No.	Flange Size	Each Wt.	Inner Qty.	Master Carton
Stamped Brass				
131-301	4 1/2"	0.73	0	24
Cast Brass with Lift Seal Crumb Cup				
131-302	4 1/2"	1.43	0	24

- Rolled edge crumb cup and deep well design
- 131-301
- Zinc slip nut and brass lock nut
- 131-302
- Fits sinks with 3 1/2" to 4" openings
- Brass slip nut and brass lock nut included



302



101

Sink Strainer

Stainless Steel Clad Plastic

Item No.	Flange Size	Each Wt.	Inner Qty.	Master Carton
131-101	4 1/2"	0.33	0	50
131-101BP	4 1/2"	0.31	0	50
131-101RP	4 1/2"	0.52	4	12

- High quality plastic body with stainless steel flange
- Rolled edge crumb cup
- Fits sinks with 3 1/2" to 4" openings



701



204

Sink Strainer • Double Cup

Stainless Steel

Item No.	Flange Size	Each Wt.	Inner Qty.	Master Carton
Deep Cup Body				
131-203	4 1/2"	0.80	0	24
131-701	4 1/2"	0.80	0	24
Standard				
131-204	4 1/2"	0.56	0	40

- Rolled edge crumb cup
- Double cup design for a quick and positive fit
- Fits sinks with 3 1/2" to 4" openings

131-203

- Master weight 22 lbs.

131-204

- Master weight 28 lbs.



702

Sink Strainer • Push & Seal

Plastic Body • Stainless Steel Rim

Item No.	Flange Size	Each Wt.	Inner Qty.	Master Carton
Long Tail				
131-702BP	4 1/2"	0.33	0	50

- Push and seal design



401

Sink Strainer • Spin & Seal

Brass • Stainless Steel

Item No.	Flange Size	Each Wt.	Inner Qty.	Master Carton
Chrome Plated Brass				
131-401	4 1/2"	0.83	0	24
Stainless Steel				
131-601	4 1/2"	0.83	0	24

- Rolled edge crumb cup and deep well design
- Spin and seal design
- Fits sinks with 3 1/2" to 4" openings

Strainers & Drains



501

Sink Strainer • Easy Connection

Stainless Steel

Item No.	Flange Size	Each Wt.	Inner Qty.	Master Carton
131-501	4 1/2"	0.56	0	24

- Rolled edge crumb cup and deep well design
- Easy thumb screw installation
- Fits sinks with 3 1/2" to 4" openings



801

Sink Strainer • Kitchen

White Plastic Body

Item No.	Flange Size	Each Wt.	Inner Qty.	Master Carton
131-801	4 1/2"	0.46	25	100

- Color goes through entire strainer
- Positive sealing color matching crumb cup
- Maximum durability and will not chip
- Fits sinks with 3 1/2" to 4" openings



201

Sink Strainer • Flat Top

Stainless Steel

Item No.	Flange Size	Each Wt.	Inner Qty.	Master Carton
133-201	4 1/2"	0.55	0	50
133-201BP	4 1/2"	0.66	0	50

- Use in shower stalls, kitchen or general purpose sinks
- Fits sinks with 3 1/2" to 4" openings
- Threaded for strength
- Stainless steel finish



202

Sink Strainer • Junior

Stainless Steel • Chrome Plated Brass

Item No.	Flange Size	Each Wt.	Inner Qty.	Master Carton
Stainless Steel				
131-202	2 1/2"	0.30	0	80
131-202BP	2 1/2"	0.30	0	100

Chrome Plated Brass — Deep Style Body

131-212	2 7/8"	0.41	0	100
---------	--------	------	---	-----

- For bar sinks and laundry tubs
- Fits sinks with 1 7/8" to 2 1/4" openings
- Positive seal crumb cup

212





Sink Strainer • Junior

Stainless Steel Clad Plastic

Item No.	Flange Size	Each Wt.	Inner Qty.	Master Carton
131-103BP	2 7/8"	0.15	0	100

Stainless Steel

- Fits sinks with 1 7/8" to 2 1/4" openings



Sink Strainer • Duplex

Stainless Steel

Item No.	Flange Size	Each Wt.	Inner Qty.	Master Carton
133-202	2 3/4"	0.25	0	80

- Fits sinks with 1 7/8" to 2 1/4" openings
- Stainless steel grid



Sink Strainer • Flat Top with Rubber Stopper

Stainless Steel

Item No.	Flange Size	Each Wt.	Inner Qty.	Master Carton
132-201	2 3/4"	0.30	0	80

- White rubber stopper
- Fits sinks with 1 7/8" to 2 1/4" openings



Wash Tray Plug • Long

Chrome Plated Zinc

Item No.	Each Wt.	Inner Qty.	Master Carton
132-203BP	0.32	0	100

- Contains a rubber gasket for sealing
- Conveniently fits sinks with 1 7/8" to 2 1/4" openings

Strainers & Drains



101RP



201



202



203



204



205



207BP



208



209

Replacement Crumb Cup

Stainless Steel

Item No.	Flange Size	Each Wt.	Inner Qty.	Master Carton
Fits 131-101				
139-101RP	—	0.15	12	72
Fits All Metal Post				
139-201	3 1/4"	0.14	10	100
Stick Plastic Post				
139-202	3 1/8"	0.09	10	100
Fits 131-202				
139-203	2 3/4"	0.05	0	100
Spin & Seal				
139-204	3 3/8"	0.23	0	50
Fits All Plastic Post				
139-205	3 3/8"	0.11	20	100
Fits 131-101				
139-207BP	—	0.10	20	200
Fits 131-301 & 201BP				
139-208	—	0.15	10	100
Fits 131-701				
139-209	—	0.17	0	100

- Rolled edge
- Positive seal crumb cup



Pop Up Drain

Brass

Item No.	Finish	Each Wt.	Inner Qty.	Master Carton
127-006	Chrome	1.13	0	24
127-007	Polished Brass	1.25	1	24
127-008	Brushed Nickel	0.86	6	24
127-009	Chrome	1.00	0	24

- Cast brass body
- Heavy duty linkage
- 1 1/4" tailpiece
- Made to ASTM F409 specifications



Pop Up Drain with Overflow

Plastic

Item No.	Finish	Each Wt.	Inner Qty.	Master Carton
127-106	Chrome	0.65	0	50
127-106RP	Chrome	0.65	4	12

- Chrome plated body
- 1 1/4" tailpiece
- Made to ASTM F409 specifications 1/2" to 4" opening



C.O. / P.O. Plug

Brass

Item No.	Each Wt.	Inner Qty.	Master Carton
With Overflow Holes – P.O.			
134-202	0.35	0	50
Less Overflow Holes – C.O.			
134-201	0.30	0	50

- Chrome plated
- White rubber stopper
- Chrome plated chain
- 1 1/4" tailpiece

Strainers & Drains



C.O. / P.O. Plug

Plastic

Item No.	Each Wt.	Inner Qty.	Master Carton
With Overflow Holes – P.O.			
134-102	0.17	0	80
134-102RP	0.37	4	12
Less Overflow Holes – C.O.			
134-101	0.17	0	80
134-101RP	0.37	4	12

- Stainless steel trim ring
- White rubber stopper
- Chrome plated chain
- 1 1/4" tailpiece



C.O. / P.O. Plug

Plastic

Item No.	Finish	Each Wt.	Inner Qty.	Master Carton
Lift Stop				
134-103BP	Bone	0.10	0	80
134-104BP	Chrome	0.13	0	80
134-105BP	White	0.10	0	80

- Plastic
- Rubber stopper and chain
- SS clad



P.O. Plugs • Fixed Grid

Brass

Item No.	Each Wt.	Inner Qty.	Master Carton
Non-Removable Strainer Grid – Straight			
134-301	0.94	0	50
Non-Removable Strainer Grid – Offset			
134-303	1.78	0	25
Lift Lock with Overflow Holes – P.O.			
134-401	0.93	0	50

- Chrome plated
- Non-removable fixed strainer grid is tamper proof
- 1 1/4" tailpiece
- Heavy gauge construction on 1 1/4" tubular stock
- Heavy cast brass drain body



205

Tub Drain • Lift Lock

Brass

Item No.	Flange Size	Each Wt.	Inner Qty.	Master Carton
132-205	2 3/4"	0.59	0	80

- Chrome plated
- Easy operation
- Positive seal
- Fits 1 1/4" fine thread and 1 1/2" coarse thread tub



221

Tub Drain • Lift Lock

ABS

Item No.	Finish	Each Wt.	Inner Qty.	Master Carton
132-221BP	Chrome	0.10	0	100
132-222BP	White	0.10	0	100

- Durable ABS plastic design
- Foam & rubber gasket for sealing
- ABS lock nut



500

Tub Drain • Lift Lock

Zinc

Item No.	Each Wt.	Inner Qty.	Master Carton
132-500BP	0.48	10	100

- Chrome plated zinc design
- Solid brass lift/lock mechanism
- Superior positive seal
- 1 1/2" – 11.5 NPSM threads



206

Tub Drain • Easy Touch

Brass

Item No.	Flange Size	Finish	Each Wt.	Inner Qty.	Master Carton
132-206	2 1/2"	Chrome	0.55	0	80

- One touch open-close operation
- Positive seal
- Fits 1 1/4" fine thread and 1 1/2" coarse thread tub shoes with adapter bushing



207

Tub Drain • Easy Touch

Brass

Item No.	Finish	Each Wt.	Inner Qty.	Master Carton
132-207BP	Chrome Plated	0.40	10	100
132-208BP	Polished Brass	0.46	0	100

- Easy touch cartridge design
- Chrome plated
- Made to ASME A 112.18.2 standards
- IAPMO approved
- Fits 1 1/4" or 1 1/2" thread size
- Easy touch drain

Strainers & Drains



234

Lift & Turn Drain Assembly

Brass

Item No.	Finish	Each Wt.	Inner Qty.	Master Carton
Fine Thread				
132-223		0.46	50	100
Coarse Thread				
132-231		0.46	0	100
132-234	Brushed Nickel	0.47	25	100

- Easy lift and turn design
- O-ring seal
- 132-223 – 1 5/8" O.D. diameter x 16 threads per inch
- 132-231 – 1 7/8" O.D. diameter x 11 1/2 threads per inch



008

003

009

Bath Waste Face Plate

Chrome Plated Brass

Item No.	Type	Each Wt.	Inner Qty.	Master Carton
129-008	Trip Lever	0.24	10	100
129-009	Plain Plate	0.34	10	100



014

015

Bath Waste Face Plate

PVD Brushed Nickel Plated

Item No.	Type	Each Wt.	Inner Qty.	Master Carton
129-014	1 Hole Overflow Plate	0.15	25	100
129-015	2 Hole Overflow Plate	0.18	25	100

- Face plate with 1 or 2 holes



235

Tub Shoe Strainer & Screw

Stainless Steel

Item No.	Finish	Each Wt.	Inner Qty.	Master Carton
132-235	Brushed Stainless Steel	0.18	25	100

- Includes screws



Bath Waste & Overflow Chrome Plated Brass • Polypropylene Body

Item No.	Finish	Each Wt.	Inner Qty.	Master Carton
Trip Lever				
129-003	Chrome	1.30	0	12
Lift Lock				
129-005	Chrome	1.82	0	12
Easy Touch				
129-007	Chrome	1.15	0	12



Bath Waste & Overflow Brass Body

Item No.	Finish	Each Wt.	Inner Qty.	Master Carton
Trip Lever				
129-301	Chrome	3.88	0	12
Lift Lock				
129-302	Chrome	3.88	0	12
Easy Touch				
129-303	Chrome	3.88	0	12
129-313	Polished Brass	3.88	0	12



Shower Drain • Threaded Brass

Item No.	Flange Size	Each Wt.	Inner Qty.	Master Carton
133-302	4 1/2"	1.25	20	40

- Use on steel, fiberglass and plastic shower bases
- Internal compression sealing gasket
- Fits 2" Schedule 40 steel or plastic pipe
- No solvent or lead required

Strainers & Drains



301



101



102



104



106



105



107



404

Shower Drain • Quick Caulking

Brass • Plastic

Item No.	Flange Size	Each Wt.	Inner Qty.	Master Carton
Brass — Stainless Steel Grid				
133-301	4 1/2"	1.51	0	40
PVC — White Plastic Grid				
133-101	4 1/2"	0.39	0	40
PVC — Stainless Steel Grid				
133-102	4 1/2"	0.53	0	40

- Use on steel, fiberglass and plastic shower bases
- Internal compression sealing gasket
- Fits 2" Schedule 40 steel or plastic pipe
- No solvent or lead required

Shower Drain • Solvent Weld

Plastic

Item No.	Flange Size	Each Wt.	Inner Qty.	Master Carton
PVC — White Plastic Grid				
133-104	4 1/2"	0.27	20	40
PVC — Stainless Steel Grid				
133-106	4 1/2"	0.45	0	40
ABS — White Plastic Grid				
133-105	4 1/2"	0.35	0	40
ABS — Stainless Steel Grid				
133-107	4 1/2"	0.40	0	40

- Use on steel, fiberglass and plastic shower bases
- Solvent welds to 2" DWV or Schedule 40 ABS or PVC pipe

Shower Stall Strainer • Threaded

Chrome Plated Brass

Item No.	Size	Each Wt.	Inner Qty.	Master Carton
133-404	2"	0.24	20	80
133-405	1 1/2"	0.22	20	80

- Female threaded outlet
- Stainless steel grid
- 3 1/2" flange diameter

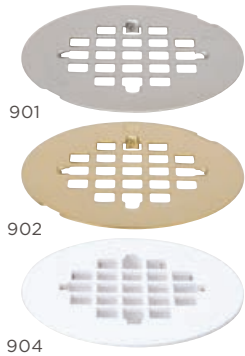

Shower Drain Grid

Stainless Steel • Brass • Plastic

Item No.	Finish	Each Wt.	Inner Qty.	Master Carton
133-901	Stainless Steel	0.15	10	200
133-902	Polished Brass	0.17	10	200
133-904	White Plastic	0.12	10	200

- Snap-in design
- Fits most 4 1/2" shower stall drains
- Polished brass PVD finish



Shower Stall Drain

PVC

Item No.	Size	Each Wt.	Inner Qty.	Master Carton
133-112	2"	0.65	0	20

- Threaded
- Allows secondary drainage if leak occurs around strainer
- Stainless steel grid



Bell Trap Loose Lid

Cast Iron

Item No.	Size	Each Wt.	Inner Qty.	Master Carton
135-102	6" x 6" x 2"	5.20	0	6
135-103	9" x 9" x 3"	12.05	0	1

Replacement Strainer

135-104	For 135-103	3.00	0	25
135-105	For 135-102	1.30	0	25

- Deep body
- Bell attached
- Cast iron body

Strainers & Drains



114



115

Floor Drain • Clamping Type

Plastic

Item No.	Flange Size	Each Wt.	Inner Qty.	Master Carton
PVC — Stainless Steel Grid				
133-114	2" — 3"	1.25	0	20
ABS — Stainless Steel Grid				
133-115	2" — 3"	1.00	0	20

- Use in areas where a large non-corrosive drain is needed
- Replaceable 6" threaded plastic strainer
- Fits 2" or 3" Schedule 40 pipe



201



204



212



203

Floor Drain

Cast Iron

Item No.	Size	Each Wt.	Inner Qty.	Master Carton
Concealed Cleanout				
135-201	2"	15.55	1	0
Exposed Cleanout				
135-204	2"	17.90	0	1
Backwater Device 2" Male				
135-212	2"	0.10	0	25
Drain Cover				
135-203	6 1/2"	1.75	0	20

- 2" plain end
- Available with concealed or exposed cleanout
- Available with or without back-water device



054

Bar Grate • For Soil Pipe

Cast Iron

Item No.	Size	Each Wt.	Inner Qty.	Master Carton
156-054	4" (4 3/8")*	0.75	5	60
156-056	6" (6 7/8")*	1.83	10	20

- Fits in HUB end of soil pipe
- Made of cast iron for durability



108

General Purpose Drain • Fits Schedule 40 Pipe

PVC

Item No.	Size	Each Wt.	Inner Qty.	Master Carton
133-108	2" – 3"	0.40	0	20
133-109	3" – 4"	0.60	0	10

- Fits Schedule 40 pipe



110

General Purpose Drain • Fits Schedule 40 Pipe

ABS

Item No.	Size	Each Wt.	Inner Qty.	Master Carton
133-110	2" – 3"	0.45	0	20
133-111	3" – 4"	0.50	1	10

- Fits Schedule 40 pipe



203

Strainer Flat Top

Chrome Plated Zinc

Item No.	Size	Each Wt.	Inner Qty.	Master Carton
133-203BP	2 1/2"	0.30	0	100

- Chrome plated design
- Removable strainer
- Secondary outlet strainer
- 1 1/2" – 11.5 NPSM outlet
- Fits 2 1/2" opening



601

Strainer Flat Top

ABS • Stainless Steel Grid

Item No.	Size	Each Wt.	Inner Qty.	Master Carton
133-601	3 1/2" – 4"	0.36	0	40

- Threaded for strength
- Use in shower stalls, kitchen or general purpose sinks



Specialty Fittings

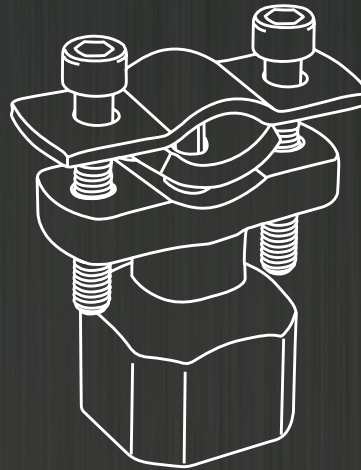

B&K Specialty Fittings include a host of fitting types, connections and materials. From galvanized steel compression fittings to trap connectors and plugs, B&K specialty fittings will give your project the specific connection needed plus the proper fit and long-lasting performance you have come to expect from B&K.

Specialty Fittings



001



002

Cast Iron Closet Floor Flange

Cast Iron

Item No.	Size	Each Wt.	Inner Qty.	Master Carton
Quick Connect				
135-001	4" x 2"	3.90	0	8
Standard				
135-002	4" x 2"	2.85	0	8

- Standard and extra heavy are for caulk connection
- Quick connect has four corrosion resistant bolts for even clamping
- Notched and slotted



000



001



003

Brass Closet Floor Flange

Brass

Item No.	Size	Each Wt.	Inner Qty.	Master Carton
14 oz.				
152-000	4"	0.68	10	60
Deep Seal				
152-001	4"	0.87	4	48
Offset				
152-003	4"	1.17	3	48

- Constructed of brass for durability
- Has a wide variety of installation applications
- 152-000 fits 4"
- 152-001 and 152-003 fit both 3" and 4" Schedule 40



012

Plastic Flange Riser

Plastic

Item No.	Size	Each Wt.	Inner Qty.	Master Carton
152-012	6 3/4"	0.25	0	20

- 1/4" thick
- Stackable
- Polycarbonate material
- Best if used with silicone sealant when installing

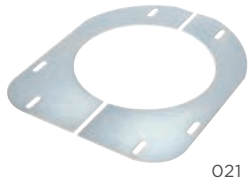

021

Closet Flange Support

Stamped Steel

Item No.	Size	Each Wt.	Inner Qty.	Master Carton
For Plastic Flanges				
135-021	4"	0.80	10	20
For Cast Iron Flanges				
135-022	4"	0.70	0	20

- Provides support for remodel or damaged flooring
- Includes screws
- Plastic is for 3", 4" or 3" x 4" PVC or ABS flanges
- Cast iron is for 3" or 4" standard cast iron flanges



007

Test Plug

Galvanized Steel

Item No.	Size	Each Wt.	Inner Qty.	Master Carton
154-007	1 1/2"	0.25	6	36
154-008	2"	0.30	6	36
154-010	3"	0.70	6	36
154-011	4"	0.95	6	36
154-012	5"	0.53	0	40
154-013	6"	0.72	0	36

- Rubber gaskets
- Large wing nuts for easy operation



003

Lead Cleanout Plugs

Iron

Item No.	Size	Each Wt.	Inner Qty.	Master Carton
156-003	3"	1.50	12	24
156-004	3 1/2"	1.79	12	24
156-005	4"	1.97	12	24

- Size 3" – 4"
- Malleable iron core
- Square head for wrench

Specialty Fittings

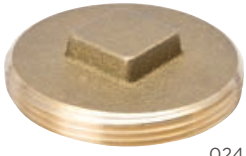

024

Raised Square Head Plugs

Brass

Item No.	Size	Each Wt.	Inner Qty.	Master Carton
156-020	1 1/4"	0.11	25	200
156-021	1 1/2"	0.13	25	300
156-022	2"	0.21	25	200
156-023	2 1/2"	0.24	15	120
156-024	3"	0.41	15	150
156-025	3 1/2"	0.55	10	90
156-026	4"	0.53	10	80

- Cored plug
- Threads comply with ANSI/ASME B1.20.1 — ANSI/ASME B1.20.7
- Heavy duty solid brass construction
- Square head for wrench



121

Countersunk Plugs

Brass

Item No.	Size	Each Wt.	Inner Qty.	Master Carton
156-119	1"	0.19	40	160
156-121	1 1/2"	0.15	100	400
156-122	2"	0.23	100	200
156-123	2 1/2"	0.31	50	200
156-124	3"	0.36	20	160
156-125	3 1/2"	0.54	20	120
156-126	4"	0.66	15	90
156-127	5"	1.03	10	60
156-129	6"	1.44	10	40

- Cored plug
- Brass body adds strength
- Recessed square head for wrench



877



977

Trap Adapters

Brass

Item No.	Size	Each Wt.	Inner Qty.	Master Carton
Slip X Male				
158-866	1 1/4" x 1 1/4"	0.33	12	72
158-876	1 1/4" x 1 1/2"	0.35	12	72
158-877	1 1/2" x 1 1/2"	0.39	12	72
Slip X Female				
158-966	1 1/4" x 1 1/4"	0.33	12	72
158-976	1 1/4" x 1 1/2"	0.38	12	72
158-977	1 1/2" x 1 1/2"	0.39	12	72

- Chrome plating die cast nut
- Brass slip ring
- Brass body and ring with zinc nut

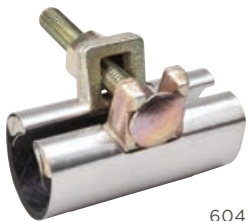

604

Repair Clamp

Stainless Steel

Item No.	Size	Each Wt.	Inner Qty.	Master Carton
3" Clamp – Single Bolt				
160-602	3/8"	0.45	6	24
160-603	1/2"	0.50	6	24
160-604	3/4"	0.50	6	24
160-605	1"	0.50	6	24
160-606	1 1/4"	0.50	6	24
160-607	1 1/2"	0.50	6	24
160-608	2"	0.85	4	16
160-609	2 1/2"	0.90	4	16
160-610	3"	0.90	4	16
160-611	4"	1.00	2	8

- Provides positive seal on leaking pipes
- Type 430 stainless steel
- Max operating temperature of 167°F
- Rated up to 150 PSI

Specialty Fittings

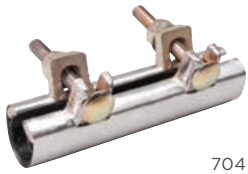

704

Repair Clamp

Stainless Steel

Item No.	Size	Each Wt.	Inner Qty.	Master Carton
6" Clamp — Two Bolt				
160-703	1/2"	0.95	3	12
160-704	3/4"	1.00	3	12
160-705	1"	1.00	3	12
160-706	1 1/4"	1.06	3	12
160-707	1 1/2"	1.05	3	12
160-708	2"	1.70	2	8
160-709	2 1/2"	1.80	2	8
160-710	3"	1.85	2	8
160-711	4"	2.40	0	4

- Provides positive seal on leaking pipes
- Type 430 stainless steel
- Max operating temperature of 167°F
- Rated up to 150 PSI



804

Repair Clamp • Rubber Gasket

Galvanized Steel

Item No.	Size	Each Wt.	Inner Qty.	Master Carton
160-803	1/2"	0.44	10	100
160-804	3/4"	0.46	10	100
160-805	1"	0.82	5	50
160-806	1 1/4"	0.94	5	50
160-807	1 1/2"	1.00	5	50
160-808	2"	1.15	5	50

- Size: 1/2" to 2" for Schedule 40
- Heavy-gauge galvanized steel body with rubber gasket
- Hinge style



004

Compression Coupling • For Iron Pipe Sizes

Galvanized Steel

Item No.	Size	Each Wt.	Inner Qty.	Master Carton
Long Pattern				
160-003	1/2"	0.81	10	60
160-003HC	1/2"	0.81	0	25
160-004	3/4"	1.00	10	40
160-004HC	3/4"	1.00	0	24
160-005	1"	1.38	5	40
160-005HC	1"	1.38	0	10
160-006	1 1/4"	2.30	4	24
160-006HC	1 1/4"	2.35	0	3
160-007	1 1/2"	2.15	4	24
160-007HC	1 1/2"	2.45	0	3
160-008	2"	4.70	2	12
160-008HC	2"	2.70	0	4

- Long pattern
- Hydroformed steel body
- Rubber compression gasket
- Metal friction ring
- Rated up to 125 PSI at 210°F
- Iron pipe size for piping or repairs on galvanized pipe
- Pipe must be restrained after installation



304

Compression Coupling

Brass

Item No.	Size	Each Wt.	Inner Qty.	Master Carton
Dual Size IPS & CTS				
160-303	3/8" & 1/2"	0.52	12	144
160-303HC	3/8" & 1/2"	0.52	0	12
160-303NL	3/8" & 1/2"	0.52	0	12
160-304	1/2" & 3/4"	0.64	12	108
160-304HC	1/2" & 3/4"	0.64	0	12
160-304NL	1/2" & 3/4"	0.64	0	12
160-305	3/4" & 1"	1.04	6	60
160-305HC	3/4" & 1"	1.04	0	10
160-305NL	3/4" & 1"	1.04	0	10
160-306	1" & 1 1/4"	1.15	4	48
160-306NL	1" & 1 1/4"	1.15	4	48
160-307	1 1/4" & 1 1/2"	1.47	4	60
160-307NL	1 1/4" & 1 1/2"	1.47	4	60
CTS				
160-308	2"	1.65	4	40
160-308NL	2"	1.65	4	40
IPS				
160-407	1 1/2"	1.72	4	40
160-407NL	1 1/2"	1.72	4	40

- Brass body and brass nut
- Rubber gaskets
- Dual sized to fit IPS and CTS



004

Compression Tee

Galvanized Steel

Item No.	Size	Each Wt.	Inner Qty.	Master Carton
Tee-Malleable Body				
162-003	1/2"	0.80	4	48
162-004	3/4"	1.15	4	48

- Long pattern
- Rubber gasket
- Rated up to 125 PSI at 210°F
- Iron pipe size for piping or repairs on galvanized pipe
- Pipe must be restrained after installation



304

Compression Tee

Brass

Item No.	Size	Each Wt.	Inner Qty.	Master Carton
Dual Size IPS & CxC x FIP Branch				
162-303	3/8" & 1/2" x 1/2"	0.60	6	48
162-303NL	3/8" & 1/2" x 1/2"	0.60	6	48
162-304	1/2" & 3/4" x 3/4"	0.60	6	48
162-304HC	1/2" & 3/4" x 3/4"	0.60	0	12
162-304NL	1/2" & 3/4" x 3/4"	0.60	6	48
162-305	3/4" & 1" x 1"	0.97	4	24
162-305HC	3/4" & 1" x 1"	0.97	0	12
162-305NL	3/4" & 1" x 1"	0.97	4	24
162-306	3/4" & 1" x 1/2"	0.84	4	24
162-306NL	3/4" & 1" x 1/2"	0.84	4	24
162-307	3/4" & 1" x 3/4"	0.83	4	24
162-307NL	3/4" & 1" x 3/4"	0.83	4	24
162-334	1/2" & 3/4" x 1/2"	0.56	6	48
162-334NL	1/2" & 3/4" x 1/2"	0.56	6	48

- Brass body and brass nut
- Rated up to 125 PSI at 210°F
- Rubber gaskets

Specialty Fittings



104

Compression Coupling • For Iron Pipe Sizes

PVC

Item No.	Size	Each Wt.	Inner Qty.	Master Carton
160-103	1/2"	0.26	10	200
160-103HC	1/2"	0.26	0	20
160-104	3/4"	0.35	10	120
160-104HC	3/4"	0.35	0	16
160-105	1"	0.44	10	120
160-105HC	1"	0.44	0	12
160-106	1 1/4"	0.61	10	80
160-106HC	1 1/4"	0.61	0	4
160-107	1 1/2"	0.82	10	60
160-107HC	1 1/2"	0.80	0	4
160-108	2"	1.18	5	50
160-108HC	2"	1.13	0	2
160-109	2 1/2"	1.99	3	24
160-110	3"	2.65	3	12
160-111	4"	4.12	3	6

- Rated up to 150 PSI at 73°F
- NSF approved
- EPDM O-ring
- Fits both Schedule 40 and 80 pipe



204

Compression Coupling • For Tubing Sizes

CPVC

Item No.	Size	Each Wt.	Inner Qty.	Master Carton
160-203	1/2"	0.16	10	200
160-203HC	1/2"	0.16	0	38
160-204	3/4"	0.28	10	200
160-204HC	3/4"	0.28	0	20
160-205	1"	0.35	10	120

- CPVC body and nuts & rubber gaskets
- Rated up to 100 PSI at 180°F
- NSF approved



504

Ez Span™ Repair Coupling

PVC

Item No.	Size	Each Wt.	Inner Qty.	Master Carton
Expands from 6 3/4" to 8 1/2"				
160-503	1/2"	0.29	0	28
160-503HC	1/2"	0.29	0	12
Expands from 7 1/2" to 9 3/4"				
160-504	3/4"	0.40	0	24
160-504HC	3/4"	0.40	0	12
Expands from 8 3/4" to 11 1/4"				
160-505	1"	0.66	0	15
160-505HC	1"	0.66	0	8
Expands from 9" to 11 3/4"				
160-506	1 1/4"	0.94	0	10
160-506HC	1 1/4"	0.94	0	4
Expands from 10" to 13"				
160-507	1 1/2"	1.13	0	16
160-507HC	1 1/2"	1.13	0	4
Expands from 11 1/4" to 14 1/4"				
160-508	2"	1.63	0	12
160-508HC	2"	1.63	0	2
Expands from 13" to 17 1/4"				
160-509	2 1/2"	2.80	0	3
Expands from 14 3/4" to 18 3/4"				
160-510	3"	3.65	0	3
Expands from 15" to 18 3/4"				
160-511	4"	5.10	0	3

- Heavy PVC construction
- Double O-ring seal
- For cold water only
- Designed for solvent welding in new or existing pipe line
- Pipe must be restrained after installation
- NSF approved
- Made to ASTM D1784 and D2466 standards
- Recommended for repair only

Specialty Fittings



Compression Male Adapter • For Iron Pipe Sizes

PVC

Item No.	Size	Each Wt.	Inner Qty.	Master Carton
161-103	1/2"	0.14	12	120
161-103HC	1/2"	0.14	0	20
161-104	3/4"	0.17	6	120
161-104HC	3/4"	0.17	0	18
161-105	1"	0.24	6	120
161-105HC	1"	0.24	0	18
161-106	1 1/4"	0.24	6	72
161-107	1 1/2"	0.42	6	60
161-108	2"	0.62	4	24

- PVC body and nuts & rubber gaskets
- Rated up to 150 PSI at 73°F
- Pipe must be restrained after installation
- NSF approved



Compression Tee • For Iron Pipe Sizes

PVC

Item No.	Size	Each Wt.	Inner Qty.	Master Carton
Female Threaded Branch				
162-103	1/2"	0.28	24	96
162-103HC	1/2"	0.28	0	18
162-104	3/4"	0.37	12	72
162-104HC	3/4"	0.37	0	14
162-105	1"	0.48	12	60
162-105HC	1"	0.48	0	10
162-106	1 1/4"	0.65	6	36
162-107	1 1/2"	0.86	6	30
162-108	2"	1.31	4	12
162-134	3/4" x 1/2"	0.38	12	72
162-134HC	3/4" x 1/2"	0.38	0	16

Solvent Branch

162-603	1/2"	0.27	24	96
162-604	3/4"	0.36	12	72
162-605	1"	0.47	12	60
162-606	1 1/4"	0.64	6	36
162-607	1 1/2"	0.84	6	30
162-608	2"	1.29	4	12

- PVC body and nuts
- Iron pipe size for piping or repairs on galvanized pipe or plastic pipe
- Pipe must be restrained after installation
- Threaded ends made to ANSI B1.20.1
- Solvent ends made to ASTM D2466 standards
- NSF approved



604



104

Union • Schedule 80 • Gray

PVC

Item No.	Size	Each Wt.	Inner Qty.	Master Carton
Threaded				
164-103	1/2"	0.16	12	96
164-103HC	1/2"	0.16	0	36
164-104	3/4"	0.29	12	72
164-104HC	3/4"	0.29	0	25
164-105	1"	0.38	12	60
164-105HC	1"	0.38	0	12
164-106	1 1/4"	0.48	6	36
164-106HC	1 1/4"	0.48	0	9
164-107	1 1/2"	0.66	6	36
164-107HC	1 1/2"	0.66	0	5
164-108	2"	0.90	6	24
164-108HC	2"	0.90	0	4

- Rated up to 150 PSI at 73°F
- NSF approved
- EPDM O-ring
- Fits both Schedule 40 and 80 pipe
- Solvent ends made to ANSI B1.20.1

Specialty Fittings



604

Union • Schedule 80 • Gray

PVC

Item No.	Size	Each Wt.	Inner Qty.	Master Carton
Solvent				
164-603	1/2"	0.14	12	96
164-603HC	1/2"	0.14	0	36
164-604	3/4"	0.29	12	72
164-604HC	3/4"	0.29	0	25
164-605	1"	0.34	12	60
164-605HC	1"	0.34	0	12
164-606	1 1/4"	0.44	6	36
164-606HC	1 1/4"	0.44	0	9
164-607	1 1/2"	0.56	6	36
164-607HC	1 1/2"	0.56	0	5
164-608	2"	0.83	6	24
164-608HC	2"	0.83	0	4

- Rated up to 150 PSI at 73°F
- NSF approved
- EPDM O-ring
- Fits both Schedule 40 and 80 pipe
- Made to ANSI/NSF 61-8 approved low lead standards
- Solvent ends made to ASTM D2466 standards



134

Union • Schedule 80 • White

PVC

Item No.	Size	Each Wt.	Inner Qty.	Master Carton
Threaded				
164-133	1/2"	0.14	12	96
164-133HC	1/2"	0.14	0	36
164-134	3/4"	0.28	12	72
164-134HC	3/4"	0.28	0	25
164-135	1"	0.38	12	60
164-135HC	1"	0.38	0	12
164-136	1 1/4"	0.21	6	36
164-136HC	1 1/4"	0.21	0	9
164-137	1 1/2"	0.29	6	36
164-137HC	1 1/2"	0.29	0	5
164-138	2"	0.41	6	24
164-138HC	2"	0.41	0	4

- Rated up to 150 PSI at 73°F
- NSF approved
- EPDM O-ring
- Fits both Schedule 40 and 80 pipe
- Solvent ends made to ANSI B1.20.1



634

Union • Schedule 80 • White

PVC

Item No.	Size	Each Wt.	Inner Qty.	Master Carton
Solvent				
164-633	1/2"	0.14	12	96
164-633HC	1/2"	0.14	0	36
164-634	3/4"	0.29	12	72
164-634HC	3/4"	0.29	0	25
164-635	1"	0.34	12	60
164-635HC	1"	0.34	0	12
164-636	1-1/4"	0.44	6	36
164-636HC	1-1/4"	0.44	0	9
164-637	1-1/2"	0.56	6	36
164-637HC	1-1/2"	0.56	0	5
164-638	2"	0.84	6	24
164-638HC	2"	0.84	0	4
164-639	2-1/2"	2.44	0	12
164-640	3"	4.42	0	4
164-641	4"	5.52	0	4

- Rated up to 150 PSI at 73°F
- NSF approved
- EPDM O-ring
- Fits both Schedule 40 and 80 pipe
- Made to ANSI/NSF 61-8 approved low lead standards
- Solvent ends made to ASTM D2466 standards



204

Union • Copper Tube Size (CTS)

CPVC

Item No.	Size	Each Wt.	Inner Qty.	Master Carton
Solvent				
164-203	1/2" (5/8" O.D.)	0.08	12	144
164-204	3/4" (7/8" O.D.)	0.13	12	144

- CPVC body and nuts
- Rubber O-rings
- Tubing sizes use in piping or repairs on copper or plastic pipe
- Pipe must be restrained after installation
- NSF approved

Specialty Fittings



314HC

CPVC Transition Adapter

Forged Brass

Item No.	Size	Each Wt.	Inner Qty.	Master Carton
Male				
164-303HC	1/2" MIP	0.16	0	25
164-303NL	1/2" MIP	0.16	0	25
164-304HC	3/4" MIP	0.19	0	25
164-304NL	3/4" MIP	0.19	0	25
164-305HC	1" MIP	0.34	0	25
164-305NL	1" MIP	0.34	0	25
Female				
164-313HC	1/2" FIP	0.19	0	25
164-313NL	1/2" FIP	0.19	0	25
164-314HC	3/4" FIP	0.19	0	25
164-314NL	3/4" FIP	0.19	0	25
164-315HC	1" FIP	0.38	0	25
164-315NL	1" FIP	0.38	0	25

164-303HC, 164-304HC, 164-305HC

- Threaded ends made to ANSI B1.20.1
- NSF approved

164-303NL, 164-304NL, 164-305NL

- Designed as an adapter for metal pipe thread to CPVC pipe
- Has a threaded male end
- Hex is larger than plastic so no breaks occur when using a wrench

164-313HC

- Solder ends made to ANSI B16.8
- Made to ANSI/NSF Annex G approved

164-313NL

- Made with no lead brass and CPVC
- Solder ends comply with ANSI B16.8
- Made to ANSI/NSF Annex G
- Made to CSA, FM and UL standards

164-314HC

- Solder ends made to ANSI B16.9
- Made to ANSI/NSF Annex G approved

164-314NL

- Made with no lead brass and CPVC
- Solder ends comply with ANSI B16.9
- Made to ANSI/NSF Annex G
- Made to CSA, FM and UL standards

164-315HC

- Solder ends made to ANSI B16.10
- Made to ANSI/NSF Annex G approved

164-315NL

- Made with no lead brass and CPVC
- Solder ends comply with ANSI B16.10
- Made to ANSI/NSF Annex G
- Made to CSA, FM and UL standards



030

Elbow • Drop Ear • CPVC Transition

Forged Brass

Item No.	Size	Each Wt.	Inner Qty.	Master Carton
440-030HC	1/2" FIP x 1/2" SOLV	0.15	0	25
440-030NL	1/2" FIP x 1/2" SOLV	0.15	0	25

- Solder ends made to ANSI B16.8
- NSF approved
- Forged brass construction
- Drop ear design
- CPVC transition
- C x FIP



403

Poly Street Elbow

Polyethylene

Item No.	Size	Each Wt.	Inner Qty.	Master Carton
169-403	1/2"	0.04	10	500

- Self lubricating polyethylene construction
- Permits back and forth as well as side to side movement of riser when two elbows are used together



405

Poly Cut Off Riser & Extension

Polyethylene

Item No.	Size	Each Wt.	Inner Qty.	Master Carton
Riser				
169-401	1/2" x 1/2" x 6"	0.05	50	500
169-404	1/2" x 3/4" x 6"	0.05	50	300
169-405	3/4" x 3/4" x 6"	0.05	25	300
169-406	3/4" x 1/2" x 6"	0.05	25	300
Extension				
169-402	1/2" x 1/2" x 3"	0.02	50	500

- PE material in risers made to NSF61
- PE material in extension made to NSF62
- Pipe threads made to ANSI B1.20.1
- Heavy-duty lubricating polyethylene construction
- Molded increments for easy cutting



402

Specialty Fittings



030

Nipple • Schedule 80

PVC

Item No.	Size	Each Wt.	Inner Qty.	Master Carton
403-001	1/2" x Close	0.01	10	500
403-015	1/2" x 1 1/2"	0.02	10	500
403-020	1/2" x 2"	0.05	10	500
403-025	1/2" x 2 1/2"	0.05	10	500
403-030	1/2" x 3"	0.05	10	250
403-035	1/2" x 3 1/2"	0.06	10	250
403-040	1/2" x 4"	0.05	10	250
403-045	1/2" x 4 1/5"	0.07	10	250
403-050	1/2" x 5"	0.10	10	250
403-055	1/2" x 5 1/2"	0.08	10	250
403-060	1/2" x 6"	0.10	10	250
403-070	1/2" x 7"	0.12	10	250
403-080	1/2" x 8"	0.10	10	250
403-090	1/2" x 9"	0.26	10	120
403-100	1/2" x 10"	0.15	10	120
403-120	1/2" x 12"	0.15	10	120
403-160	1/2" x 16"	0.20	0	50
403-180	1/2" x 18"	0.25	0	50
403-240	1/2" x 24"	0.35	0	50
403-300	1/2" x 30"	0.48	0	50
403-360	1/2" x 36"	0.55	0	50
403-480	1/2" x 48"	0.75	0	50
404-001	3/4" x Close	0.03	10	250
404-020	3/4" x 2"	0.05	10	250
404-025	3/4" x 2 1/2"	0.05	10	250
404-030	3/4" x 3"	0.15	10	250
404-040	3/4" x 4"	0.10	10	250
404-050	3/4" x 5"	0.10	10	120
404-060	3/4" x 6"	0.15	10	120
404-080	3/4" x 8"	0.15	10	120
404-100	3/4" x 10"	0.20	10	120
404-120	3/4" x 12"	0.25	10	120
404-180	3/4" x 18"	0.40	0	25
404-240	3/4" x 24"	0.55	0	25
404-300	3/4" x 30"	0.63	0	25
404-360	3/4" x 36"	0.85	0	25
404-480	3/4" x 48"	1.10	0	25

- Can be used in both Schedule 40 and Schedule 80 piping systems
- Pipe threads made to ANSI B1.20.1

Nipple • Schedule 80

PVC

Item No.	Size	Each Wt.	Inner Qty.	Master Carton
405-001	1" x Close	0.05	10	250
505-020	1" x 2"	0.05	10	250
505-030	1" x 3"	0.10	10	250
505-040	1" x 4"	0.10	10	250
405-050	1" x 5"	0.15	10	120
405-060	1" x 6"	0.20	10	120
405-080	1" x 8"	0.25	10	120
405-100	1" x 10"	0.30	10	120
405-120	1" x 12"	0.35	10	120
406-001	1 1/4" x Close	0.05	10	250
506-020	1 1/4" x 2"	0.10	10	250
506-025	1 1/4" x 2 1/2"	0.09	10	250
506-030	1 1/4" x 3"	0.10	10	250
506-040	1 1/4" x 4"	0.15	10	250
506-050	1 1/4" x 5"	0.17	10	120
506-060	1 1/4" x 6"	0.25	10	120
506-080	1 1/4" x 8"	0.35	10	120
506-100	1 1/4" x 10"	0.40	10	40
506-120	1 1/4" x 12"	0.50	10	40
407-001	1 1/2" x Close	0.10	10	250
507-020	1 1/2" x 2"	0.10	10	250
507-025	1 1/2" x 2 1/2"	0.12	10	250
507-030	1 1/2" x 3"	0.15	10	250
507-040	1 1/2" x 4"	0.20	10	120
507-050	1 1/2" x 5"	0.14	10	120
407-060	1 1/2" x 6"	0.30	10	120
407-080	1 1/2" x 8"	0.45	10	120
407-100	1 1/2" x 10"	0.55	10	120
407-120	1 1/2" x 12"	0.85	10	40
408-001	2" x Close	0.15	10	250
408-030	2" x 3"	0.20	10	120
408-040	2" x 4"	0.25	10	120
408-050	2" x 5"	0.10	10	50
408-060	2" x 6"	0.40	10	100
408-080	2" x 8"	0.60	10	80
408-100	2" x 10"	0.75	10	60
408-120	2" x 12"	0.90	10	40

- Can be used in both Schedule 40 and Schedule 80 piping systems
- Pipe threads made to ANSI B1.20.1

Specialty Fittings



060

Coupler Nipple • Male x Female

PVC

Item No.	Size	Each Wt.	Inner Qty.	Master Carton
413-040	1/2" x 4"	0.10	10	250
413-060	1/2" x 6"	0.10	10	250
413-080	1/2" x 8"	0.10	10	120
413-100	1/2" x 10"	0.20	10	120
413-120	1/2" x 12"	0.20	10	120

- Pipe threads made to ANSI B1.20.1



030

Nipple • Schedule 40

Polyethylene

Item No.	Size	Each Wt.	Inner Qty.	Master Carton
423-001	1/2" x Close	0.05	10	500
423-020	1/2" x 2"	0.05	10	500
423-030	1/2" x 3"	0.05	10	250
423-040	1/2" x 4"	0.05	10	250
423-050	1/2" x 5"	0.05	10	250
423-060	1/2" x 6"	0.05	10	250
423-080	1/2" x 8"	0.05	10	250
423-100	1/2" x 10"	0.05	10	120
423-120	1/2" x 12"	0.10	10	120

- Pipe threads made to ANSI B1.20.1



431

Nipple • Schedule 40

Polyethylene

Item No.	Size	Each Wt.	Inner Qty.	Master Carton
423-431	3/4 x 1/2 x Close	0.05	10	250

- Can be used in both Schedule 40 and Schedule 80 piping systems
- Pipe threads made to ANSI B1.20.1



57521

Coupling • Insert

Steel

Item No.	Size	Each Wt.	Inner Qty.	Master Carton
57521	1/2" I.D.	0.10	25	300
57523	3/4" I.D.	0.18	25	300
57525	1" I.D.	0.38	20	160
57527	1 1/4" I.D.	0.54	20	120
57529	1 1/2" I.D.	0.60	10	60
57531	2" I.D.	0.80	10	40

- Galvanized steel
- Joins plastic to plastic
- Steel coupling insert



57541

Adapter • Insert

Steel

Item No.	Size	Each Wt.	Inner Qty.	Master Carton
57541	1/2" I.D.	0.14	25	300
57543	3/4" I.D.	0.22	25	200
57545	1" I.D.	0.38	20	160
57547	1 1/4" I.D.	0.55	20	120
57549	1 1/2" I.D.	0.71	10	60
57551	2" I.D.	0.95	10	40
57559	3/4" I.D.	0.24	25	200

- Galvanized steel
- Plastic to male (except 57559)
- 57559 has a female insert
- Insert fittings

Specialty Fittings

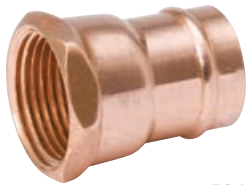

504

Rapid-Fire™ Pre-Solder Copper Fitting

Copper

Item No.	Connection	Size	Each Wt.	Inner Qty.	Master Carton
Adapter • Female					
611-503HC	C x F	1/2"	0.07	50	0
611-504HC	C x F	3/4"	0.12	30	0
611-505HC	C x F	1"	0.20	20	0

- Female thread
- 100% lead-free solder
- Made to ASME/ANSI-standard B16.22
- Solder ends comply with ANSI B16.18
- ASTM standard specification B32
- Manufactured in compliance with IGC 100-98
- IAPMO approved and tested



604

Rapid-Fire™ Pre-Solder Copper Fitting

Copper

Item No.	Connection	Size	Each Wt.	Inner Qty.	Master Carton
Adapter • Male					
611-603HC	C x M	1/2"	0.07	50	0
611-604HC	C x M	3/4"	0.12	25	0
611-605HC	C x M	1"	0.17	15	0

- Male thread
- 100% lead-free solder
- Made to ASME/ANSI-standard B16.22
- Solder ends comply with ANSI B16.18
- ASTM standard specification B32
- Manufactured in compliance with IGC 100-98
- IAPMO approved and tested



204

Rapid-Fire™ Pre-Solder Copper Fitting

Copper

Item No.	Connection	Size	Each Wt.	Inner Qty.	Master Carton
Coupling • Rolled Stop					
611-203HC	C x C	1/2"	0.03	75	0
611-204HC	C x C	3/4"	0.07	50	0
611-205HC	C x C	1"	0.12	25	0

- Coupling with stop equal sweat
- 100% lead-free solder
- Made to ASME/ANSI-standard B16.22
- Solder ends comply with ANSI B16.18
- ASTM standard specification B32
- Manufactured in compliance with IGC 100-98
- IAPMO approved and tested



223

Rapid-Fire™ Pre-Solder Copper Fitting

Copper

Item No.	Connection	Size	Each Wt.	Inner Qty.	Master Carton
Coupling • Without Stop					
611-223HC	C x C	1/2"	0.03	75	0
611-224HC	C x C	3/4"	0.07	50	0

- Coupling with stop equal sweat
- 100% lead-free solder
- Made to ASME/ANSI-standard B16.22
- Solder ends comply with ANSI B16.18
- ASTM standard specification B32
- Manufactured in compliance with IGC 100-98
- IAPMO approved and tested



343

Rapid-Fire™ Pre-Solder Copper Fitting

Copper

Item No.	Connection	Size	Each Wt.	Inner Qty.	Master Carton
Coupling • Reducing					
611-343HC	C x C	3/4" x 1/2"	0.07	50	0
611-354HC	C x C	1" x 3/4"	0.11	25	0

- Coupling with stop equal sweat
- 100% lead-free solder
- Made to ASME/ANSI-standard B16.22
- Solder ends comply with ANSI B16.18
- ASTM standard specification B32
- Manufactured in compliance with IGC 100-98
- IAPMO approved and tested



004

Rapid-Fire™ Pre-Solder Copper Fitting

Copper

Item No.	Connection	Size	Each Wt.	Inner Qty.	Master Carton
90° Elbow					
610-003HC	C x C	1/2"	0.04	75	0
610-004HC	C x C	3/4"	0.09	40	0
610-005HC	C x C	1"	0.16	20	0

- Pre-soldered copper fitting 90 degree elbow
- 100% lead-free solder
- Complies with ANSI/NSF 61 Section 4

Specialty Fittings



004

Rapid-Fire™ Pre-Solder Copper Fitting

Copper

Item No.	Connection	Size	Each Wt.	Inner Qty.	Master Carton
90° Elbow • Street					
620-003HC	FTG x C	1/2"	0.04	75	0
620-004HC	FTG x C	3/4"	0.10	30	0
620-005HC	FTG x C	1"	0.15	15	0

- 90 degree elbow equal sweat
- 100% lead-free solder
- Made to ASME/ANSI-standard B16.22
- Solder ends comply with ANSI B16.18
- ASTM standard specification B32
- Manufactured in compliance with IGC 100-98
- IAPMO approved and tested



204

Rapid-Fire™ Pre-Solder Copper Fitting

Copper

Item No.	Connection	Size	Each Wt.	Inner Qty.	Master Carton
45° Elbow					
610-203HC	C x C	1/2"	0.04	75	0
610-204HC	C x C	3/4"	0.08	30	0

- 45 degree elbow-equal sweat
- 100% lead-free solder
- Made to ASME/ANSI-standard B16.22
- Solder ends comply with ANSI B16.18
- ASTM standard specification B32
- Manufactured in compliance with IGC 100-98
- IAPMO approved and tested



504

Rapid-Fire™ Pre-Solder Copper Fitting

Copper

Item No.	Connection	Size	Each Wt.	Inner Qty.	Master Carton
45° Elbow • Street					
610-503HC	FTG x C	1/2"	0.04	75	0
610-504HC	FTG x C	3/4"	0.08	30	0

- 45 degree street elbow
- 100% lead-free solder
- Made to ASME/ANSI-standard NSF 61
- Pre-solder copper fitting



604

Rapid-Fire™ Pre-Solder Copper Fitting

Copper

Item No.	Connection	Size	Each Wt.	Inner Qty.	Master Carton
Tee					
610-603HC	C x C x C	1/2"	0.07	50	0
610-604HC	C x C x C	3/4"	0.17	25	0
610-605HC	C x C x C	1"	0.27	10	0

- Tee-reducing sweat
- 100% lead-free solder
- Made to ASME/ANSI-standard B16.22
- Solder ends comply with ANSI B16.18
- ASTM standard specification B32
- Manufactured in compliance with IGC 100-98
- IAPMO approved and tested



443

Rapid-Fire™ Pre-Solder Copper Fitting

Copper

Item No.	Connection	Size	Each Wt.	Inner Qty.	Master Carton
Tee • Reducing					
610-433HC	C x C x C	3/4" x 1/2" x 1/2"	0.11	20	0
610-434HC	C x C x C	3/4" x 1/2" x 3/4"	0.17	15	0
610-443HC	C x C x C	3/4" x 3/4" x 1/2"	0.14	20	0
610-553HC	C x C x C	1" x 1" x 1/2"	0.17	15	0
610-554HC	C x C x C	1" x 1" x 3/4"	0.24	10	0

- Tee-reducing sweat
- 100% lead-free solder
- Made to ASME/ANSI-standard B16.22
- Solder ends comply with ANSI B16.18
- ASTM standard specification B32
- Manufactured in compliance with IGC 100-98
- IAPMO approved and tested



554

Rapid-Fire™ Pre-Solder Copper Fitting

Copper

Item No.	Connection	Size	Each Wt.	Inner Qty.	Master Carton
Tube Cap					
611-403HC	C	1/2"	0.02	75	0
611-404HC	C	3/4"	0.03	50	0
611-405HC	C	1"	0.07	40	0

- Strong copper cap
- 100% lead-free solder
- Made to ASME/ANSI-standard B16.22
- Solder ends comply with ANSI B16.18
- ASTM standard specification B32
- Manufactured in compliance with IGC 100-98
- IAPMO approved and tested



404



Accessories & Repair



B&K Accessories & Repair items include popular products such as downspouts, saddle tees, ice maker kits and other unique components.

Each item is made for exacting fit, long life and project convenience. Year after year, B&K Accessories & Repair items are preferred for their ease of use, innovation and value.



Bath Faucet Coupling Elbow

Chrome Plated Brass

Item No.	Size	Each Wt.	Inner Qty.	Master Carton
123-096	3/4" x 1/2"	0.22	12	144

- Converts 3/4" bath cock thread to 1/2" male straight pipe thread
- Fits all B&K and most other manufacturers' bath cocks



Thin Wall Shower Stall Elbow

Brass

Item No.	Size	Each Wt.	Inner Qty.	Master Carton
993-113	2 1/2" x 1 3/4" x 2 1/4"	0.40	6	72

- Brass body and nuts
- For stable mounting of shower arm to thin metal and plastic shower stalls
- 1/2" male straight pipe thread inlet with internal copper socket for solder connection



Mounting Block • For Laundry Tray Faucet

ABS

Item No.	Size	Each Wt.	Inner Qty.	Master Carton
125-901	5 1/4" x 1 1/4"	0.25	0	50

- Used to mount rough brass laundry tray faucets on ledge type sinks
- Made with durable ABS



Saddle Tee

Cast Iron

Item No.	Size	Each Wt.	Inner Qty.	Master Carton
135-301	4" x 2"	2.15	0	10

- Connects quickly to cast iron soil pipe
- Tapped 2" female iron pipe



Saddle Tee

Brass

Item No.	Size	Each Wt.	Inner Qty.	Master Carton
993-024	3/4" FIP	0.60	20	80

- Use with water heater safety expansion tank



012

Shower Head Brass Ball

Item No.	Each Wt.	Inner Qty.	Master Carton
141-012	0.20	0	50

- Chrome plated design
- Adjustable spray nozzle
- Max. 2.5GPM at 80 PSI



500

Arm & Flange Kit for Shower Head

Item No.	Each Wt.	Inner Qty.	Master Carton
141-500BP	0.19	50	100

- Chrome plated design
- Max. 2.5GPM at 80 PSI
- Made to ASME A 112.18.1 standards



513

Shower Arm • Escutcheon

Chrome Plated Brass

Item No.	Size	Each Wt.	Inner Qty.	Master Carton
141-513	6" w/Escutcheon	0.25	10	100

- Chrome plated brass finish
- Escutcheon with set screw



090

Bath Spout & Diverter

Chrome Plated Brass

Item No.	Connection Type	Each Wt.	Inner Qty.	Master Carton
----------	-----------------	----------	------------	---------------

Brass Diverter - Chrome

142-090	Type A	1.37	0	24
---------	--------	------	---	----

Die Cast Diverter - Chrome

142-093	Type A	0.57	0	48
---------	--------	------	---	----

142-095	Type B	0.66	0	48
---------	--------	------	---	----

142-096	Type C	0.75	0	48
---------	--------	------	---	----

Die Cast Tube Spout - Chrome

142-092	Type B	0.39	0	48
---------	--------	------	---	----

142-103	Type C	0.53	0	48
---------	--------	------	---	----

Die Cast Diverter - Personal Shower Connection - Chrome

142-094	Type A	0.51	0	48
---------	--------	------	---	----

- Type A: Connects to piping at the rear of the spout and has a combination 3/4" x 1/2" face bushing for use with both 1/2" or 3/4" threaded pipe.
- Type B: Connects to piping at the front of spout and has a 1/2" IPS connection.
- Type C: Slides over copper tubing, seals with an "O" ring and is held in place by a set screw.



092



103



094

Accessories & Repair



Closet Spud

Rubber • Brass

Item No.	Size	Each Wt.	Inner Qty.	Master Carton
150-201	1" x 3/4"	0.29	25	200
150-202	1 1/4" x 3/4"	0.38	25	150
150-203	1 1/4" x 1 1/4"	0.38	25	150
150-204	1 1/2" x 3/4"	0.41	25	125
150-205	1 1/2" x 1 1/4"	0.41	25	125
150-206	1 1/2" x 1 1/2"	0.49	25	125
150-207	2" x 1 1/4"	0.67	25	100
150-208	2" x 1 1/2"	0.64	25	100
150-209	2" x 2"	0.68	25	100

- Brass locknut
- Rubber washer

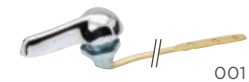

Tank Levers

Brass



Item No.	Finish	Each Wt.	Inner Qty.	Master Carton
153-001	Chrome	0.23	0	100
153-011	Polished Brass	0.24	0	100
153-013	Plastic Chrome	0.05	0	250

- Metal units have die cast levers and brass rods
- Metal units are individually boxed
- Plastic units have plastic levers
- Plastic units are polybagged
- Polished brass is a PVD finish

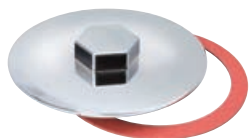

Drum Trap Cover • Die Cast

Chrome Plated

Item No.	Size	Each Wt.	Inner Qty.	Master Carton
156-013	3"	0.40	0	110

- Rubber gasket
- Chrome plated



Access Panel/Wall Adapters

Plastic

Item No.	Size	Each Wt.	Inner Qty.	Master Carton
156-708	8" x 8"	0.55	0	10
156-712	12" x 12"	1.40	0	10

- Frameless easy installation design
- Durable plastic body



002

Floor & Ceiling Plate

Chrome Plated Steel

Item No.	Size	Each Wt.	Inner Qty.	Master Carton
Iron Pipe Size				
158-002	3/8"	0.04	12	288
158-003	1/2"	0.04	12	288
158-004	3/4"	0.04	12	288
158-005	1"	0.06	12	288
158-006	1 1/4"	0.05	12	288
158-007	1 1/2"	0.05	12	288
158-008	2"	0.05	12	144
Copper Tube Size				
158-503	1/2"	0.04	12	288
158-504	3/4"	0.04	12	288
158-505	1"	0.04	12	288
158-506	1 1/4"	0.10	12	288
158-507	1 1/2"	0.06	12	288

- Split flange for easy installation
- Chrome plated finish



102

Escutcheons

Chrome Plated Steel

Item No.	Size	Each Wt.	Inner Qty.	Master Carton
Iron Pipe Size				
158-102	3/8"	0.01	25	500
158-103	1/2"	0.01	25	500
158-104	3/4"	0.01	25	500
158-105	1"	0.05	10	100
158-107	1 1/2"	0.05	10	100
158-108	2"	0.05	10	100
Copper Tube Size				
158-602	3/8"	0.01	25	500
158-603	1/2"	0.01	25	500
158-604	3/4"	0.01	25	500

- Low pattern
- Chrome plated finish
- 158-602 split flange for easy installation



207

Flange

Chrome Plated Steel

Item No.	Size	Each Wt.	Inner Qty.	Master Carton
Iron Pipe Size				
158-207	1 1/2"	0.08	5	50
Tubular O.D. Size				
158-706	1 1/4"	0.10	5	200
158-707	1 1/2"	0.10	5	50

- Chrome plated finish
- Box pattern



001

Ice Maker • Humidifier Kit

Plastic

Item No.	Each Wt.	Inner Qty.	Master Carton
993-001	0.60	0	25

- Self piercing saddle valve
- 25' of tubing
- Allows complete connection from water line to appliance



003

Jiffy Rod Shower Flange

Chrome Plated • Plastic

Item No.	Each Wt.	Inner Qty.	Master Carton
993-003	0.10	50	200

- Rubber pads where flange contacts wall
- Easily adjustable



004



014

Saddle Tees

Brass • Steel

Item No.	Each Wt.	Inner Qty.	Master Carton
Self Piercing			
993-004	0.22	0	50
Standard			
993-014	0.22	50	250

- Fits 3/8" through 1 1/4" tubing
- Outlet fits 1/4" copper or poly tubing



114

Thin Wall Shower Adapter

Plastic

Item No.	Size	Each Wt.	Inner Qty.	Master Carton
993-114	6 5/8"	0.17	0	50

- For single lever control
- Allows mounting of Delta style shower valve on metal or plastic thin shower walls



004

Overflow Pipe

Galvanized Steel

Item No.	Size	Each Wt.	Inner Qty.	Master Carton
994-004	48"	0.27	0	125
994-005	60"	0.34	0	125
994-006	72"	0.41	0	125

- For use with T&P valves not exceeding 105,000 BTU per hour
- 3/4" galvanized nipple connection



011

Disposal Connector

Rubber

Item No.	Size	Each Wt.	Inner Qty.	Master Carton
992-011	3 1/2"	0.16	50	200

- With 2 worm drive clamps
- PVC construction



000

Air Gap

Plastic Body

Item No.	Finish	Each Wt.	Inner Qty.	Master Carton
995-000	Chrome	0.19	0	24
995-000BP	Chrome	0.15	0	50

- Chrome plated
- Prevents backflow of dishwasher water into water supply system



001

Trap Vent

Plastic

Item No.	Size	Each Wt.	Inner Qty.	Master Carton
995-001	1 1/2"	0.09	0	90

- Replaces any secondary plumbing vent protecting the traps of kitchen sinks, bathroom basins, tubs, showers or washing machines
- NSF listed



Tools

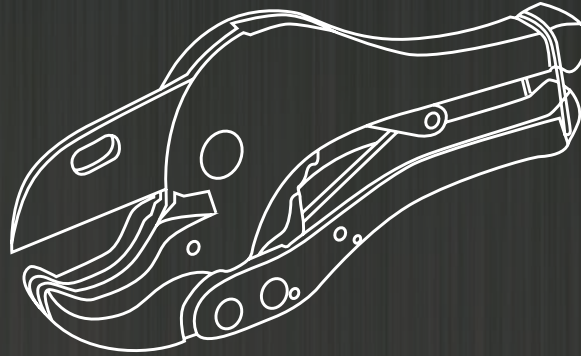

B&K tools are the practical answer for the completion and maintenance of various plumbing needs. Whether it is street keys needed for opening and closing curb stops or pipe cutters used for providing clean cuts to plastic piping, each item in the B&K line of tools is designed to be a durable and trusted piece of equipment.

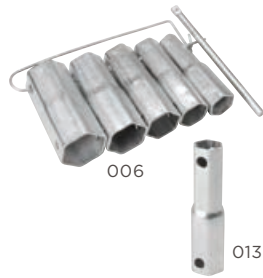

Socket Set

Plated Steel

Item No.	Size	Each Wt.	Inner Qty.	Master Carton
151-006	Set	2.30	1	24
151-013	21/32" & 27/32"	0.25	12	96

- Heavy duty
- Bright plated steel construction
- Each socket fits two sizes



4-Way Stem Key

Chrome Plated

Item No.	Size	Each Wt.	Inner Qty.	Master Carton
151-015	1/4", 9/32", 5/16", 11/32"	0.40	10	100

- Fits square stems
- Vinyl display/storage pouch



Water Heater Element Socket

Plated Steel

Item No.	Size	Each Wt.	Inner Qty.	Master Carton
----------	------	----------	------------	---------------

Kit with Handle

151-021	1 1/2"	0.90	6	48
---------	--------	------	---	----

Economy Socket Only - No Display Pouch

151-027	1 1/2"	0.30	12	48
---------	--------	------	----	----

- 151-021
 - Bright plated steel socket
 - Vinyl display/storage pouch with handle
- 151-027
 - Plated steel



Nipple Extractor

Steel

Item No.	Size	Each Wt.	Inner Qty.	Master Carton
151-039	1/2"	0.30	6	72

- Vinyl covered steel handle
- For use with PVC and poly nipples
- Vinyl display/storage pouch



044

Pipe Cutter • PVC

Heavy Duty

Item No.	Size	Each Wt.	Inner Qty.	Master Carton
151-044	1" – 1 1/2"	1.04	6	24

- Single action releasing mechanism
- Most suitable for polyethylene and polybutene pipes
- Quick and easy cutting with one hand with ratchet mechanism



051



053



054



055



056

Pipe Cutter • PVC

Aluminum

Item No.	Size	Each Wt.	Inner Qty.	Master Carton
151-051	1/2" – 1"	0.76	1	36
151-053	1/2" – 1"	1.38	1	20
151-054	1" – 1 1/2"	1.65	1	20
151-055	1 1/2 – 2 1/2"	2.51	1	20
151-056	1 1/2" – 2 1/2"	1.30	1	36

151-051

- Five-step ratchet mechanism for smooth, easy operation
- Heavy duty all metal construction
- Replaceable tool steel blade

151-053 & 151-054

- Ratchet action for quick cuts
- Razor cut accuracy
- Easily replaceable hardened steel blade
- Dozens of uses

151-055 & 151-056

- Rubber grip handle with aluminum body
- One hand operation
- Replaceable blade



045



052



057



058



059



068

Pipe Cutter Replacement Blades

Hardened Steel

Item No.	Fits Pipe Cutter	Each Wt.	Inner Qty.	Master Carton
151-045	151-044	0.24	10	150
151-052	151-051	0.15	1	200
151-057	151-053	0.05	1	200
151-058	151-054	0.08	1	100
151-059	151-055	0.40	1	50
151-068	151-056	0.30	1	50

- Easily resharpened
- Made of hardened steel for durability

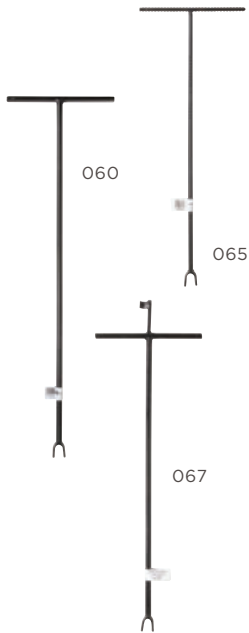

Street Keys

Bronze

Item No.	Size	Each Wt.	Inner Qty.	Master Carton
Re-Bar				
151-060	36", 5/8" OD	4.20	1	5
151-061	60", 5/8" OD	6.25	1	5
151-062	60", 3/4" OD	9.00	1	5
151-065	28"	4.20	1	5
151-066	36"	4.20	1	5

Combination

151-067	30"	4.20	1	5
---------	-----	------	---	---

- Heavy welded cold rolled steel
- Black painted finish
- 151-067 is combination street key & water meter box key



Water Meter Keys

Bronze

Item No.	Type	Each Wt.	Inner Qty.	Master Carton
151-063	Box Key	0.52	6	72
151-064	Combo Key	1.07	4	32

- Combination key - water meter key and box key
- Used to open meter boxes and turn water off at meter



Drain Plunger

Rubber • Wood

Item No.	Size	Each Wt.	Inner Qty.	Master Carton
151-710	4"	0.30	24	192
151-730	6"	0.80	12	48

- Heavy duty red rubber
- Reinforced ribbed construction
- Ideal for sinks, basins, and laundry tubs
- Dispenser box
- 151-710 has a 9" handle, 151-730 has a 21" handle



Toilet Plunger

Rubber • Wood

Item No.	Size	Each Wt.	Inner Qty.	Master Carton
151-770	21"	1.00	12	48

- Heavy duty black rubber
- Folding cuff
- Reinforced ribbed construction
- Ideal for toilets as well as sinks, basins, and laundry tubs
- Dispenser box
- 21" handle

Terms of Sale

THE FOLLOWING CONSTITUTE THE TERMS AND CONDITIONS OF SALE FOR ALL PRODUCTS MANUFACTURED, DISTRIBUTED AND/OR SOLD BY MUELLER INDUSTRIES, INC. OR ITS SUBSIDIARIES OR AFFILIATES (SELLER). ACCEPTANCE OF SELLER'S OFFER TO SELL OR BUYER'S ORDER IS EXPRESSLY MADE CONDITIONAL ON BUYER'S ACCEPTANCE OF THE PROVISIONS STATED HEREIN. BUYER'S ACCEPTANCE OF EACH SHIPMENT OF GOODS SHALL BE DEEMED TO BE AN ACCEPTANCE OF THE PROVISIONS HEREOF NOTWITHSTANDING ANY ACT OF SELLER, INCLUDING SHIPMENT, ACCEPTANCE OF PAYMENTS, AND NOTWITHSTANDING ANY TERM OR CONDITION CONTAINED IN ANY FORM OF BUYER, AND ANY PROPOSAL FOR ADDITIONAL OR DIFFERENT TERMS OR ANY ATTEMPT BY BUYER TO VARY ANY OF THE PROVISIONS HEREIN IS HEREBY DEEMED A MATERIAL ALTERATION AND REJECTED. THE PROVISIONS HEREIN MAY NOT BE ADDED TO, MODIFIED, SUPERSEDED, OR ALTERED EXCEPT BY WRITTEN AGREEMENT OR MODIFICATION SIGNED BY AN OFFICER OF SELLER, NOTWITHSTANDING ANY TERMS WHICH MAY NOW OR IN THE FUTURE APPEAR ON BUYER'S FORMS OR COMMUNICATIONS, ALL OF WHICH ARE REJECTED WITHOUT FURTHER ACTION OF SELLER. NO PERSON (EXCEPT AN OFFICER OF SELLER) IS AUTHORIZED TO BIND SELLER TO ANY ORDER FOR ANY GOODS EXCEPT ACCORDING TO THE PROVISIONS HEREIN.

1. PRICES. All prices for SELLER's products are subject to change or withdrawal without notice. Unless otherwise stated by SELLER, prices, terms of payment and pricing policies will be those of the SELLER in effect at the time of shipment. SELLER reserves the right to make price changes within the periods of contracts, including installment contracts or blanket orders. The cost of packing and crating other than in accordance with the standards of SELLER may constitute an additional charge and may at SELLER's discretion be added to the sales price(s). SELLER also reserves the right to divide Buyer's order into separate shipments and to invoice and otherwise treat each shipment as a separate contract subject to these Terms and Conditions. All sales and shipments are subject at all times to credit approval by SELLER.

2. TRANSPORTATION AND RISK OF LOSS. Unless otherwise agreed in advance in writing by SELLER, and except for products sold for delivery in Canada, delivery of products hereunder shall be F.O.B. shipping point, with transportation expenses paid by Buyer unless standard SELLER freight prepayment qualifications are met and the risk of loss or damage to products in transit shall fall upon Buyer (whose responsibility it shall be to file claims with carrier at delivery to Buyer at Buyer's premises) upon delivery (a) to Buyer's designated representative, or (b) to a common carrier or other designated shipper (not including SELLER), whichever of the foregoing occurs earlier. SELLER in its discretion shall select the appropriate transportation method and routing. All orders, unless otherwise agreed in writing, are for shipment at SELLER's earliest convenience. Stated delivery dates are approximate and will be calculated from the date that SELLER has received all information necessary to permit SELLER to proceed with work immediately and without interruption. If any or all products are not delivered when ready due to the request of Buyer, SELLER reserves the right to invoice Buyer at any time thereafter and to place such products in storage with all risk of loss or damage borne by Buyer and with all expenses and costs attributable thereto for the account of Buyer, which shall be payable by Buyer upon submission of SELLER's invoices to Buyer.

For products sold for delivery in Canada by Streamline Copper & Brass Ltd. (an affiliate) on or after April 1, 2010, Streamline Copper & Brass Ltd. shall constitute the SELLER for purposes of these terms and conditions. For such sales, unless otherwise agreed in advance in writing by SELLER, SELLER shall deliver the products to Buyer at Buyer's designated receiving point. Title to the products shall pass from SELLER to Buyer when the products are delivered (but not yet unloaded) to Buyer's designated receiving point. Risk of loss or damage to the products while in transit, with the exception of loss or damage incurred during the unloading of the products by Buyer at Buyer's designated receiving point, shall be borne by SELLER until the products are delivered to the Buyer's designated receiving point.

3. DELAYS. SELLER shall not be liable for any delays in delivery due or resulting in whole or in part from or made impossible or impractical by any cause beyond the control of SELLER including but not limited to fire, explosion, epidemics, accident, material and significant breakdown, strike or labor disputes, adverse weather conditions, loss or damage in shipment, shortage or lack of materials, fuel or power, sale or transfer of manufacturing facilities, embargo, acts of God, acts (including delay or failure to act) of any governmental authority (de jure or de facto) or any other contingency or delay or failure or cause beyond SELLER's control. If, due to any such occurrence, SELLER is unable to supply total demands for any goods specified, SELLER may, but shall not be obligated to, allocate production, inventory and deliveries (in any manner fair and reasonable to the extent that goods are not special or unique) and will notify Buyer reasonably that there will be delay or nondelivery.

4. TAXES. All prices are exclusive of any applicable foreign or U.S.A. federal, state or local sales, use, excise or other taxes, which SELLER may be required to pay or collect, under any existing or future law, upon or with respect to the sale, delivery, storage, processing, use or consumption of any of the products covered hereby, which shall be for the account of Buyer, who shall promptly pay the amount thereof to SELLER upon demand.

5. PAYMENT TERMS AND SECURITY INTEREST. Unless otherwise agreed in advance in writing by SELLER, payment terms are 2% 30 days, net 45 days. All payments not made within such time may be subject to a carrying charge of one percent per month on the unpaid balance or the highest rate permitted by applicable law, whichever is the lesser. Until the entire amount due hereunder is paid, SELLER reserves a security interest in all products sold, with all rights, privileges and remedies of a selling secured party in the jurisdiction to which the goods may be shipped or within which they may be kept at any time. In pursuance thereof, Buyer agrees to timely execute any documents which SELLER may request from time to time in order to give notice of, perfect or otherwise give effect to the existence of said security interest.

6. FINANCIAL RESPONSIBILITY. If Seller has any reasonable doubt at any time as to Buyer's financial condition and ability to perform, Seller, at its option, may (a) decline to make further shipments other than on a cash in advance basis or upon Buyer providing other security satisfactory to Seller, or (b) terminate this agreement.

7. RECEIVING AND INSPECTION. Any claim by Buyer based upon or relating to any claimed defect in the products ascertainable upon visual inspection thereof, including without limitation any claim relating to size, type, quantity or shipping damage and the like, must be presented to SELLER or its representative within fifteen (15) days following the date of receipt of the product by Buyer. Buyer's receipt of any product delivered hereunder shall be an unqualified acceptance, and a waiver by Buyer of any and all such claims with respect to such product unless Buyer gives SELLER notice of claim within fifteen (15) days after such receipt. Unless otherwise agreed in advance in writing by SELLER, variations in the products as to composition, dimensions, quantity and the like shall be permissible and not cause for Buyer's rejection or revocation if within prevailing industry (United States of America) standards. Buyer assumes all risk and liability for results.

8. TOOLING. Buyer will indemnify, defend and hold SELLER harmless from and against any liability, damage, loss or expense arising from the use or handling of any tooling supplied or designed by Buyer from which products are to be cast or manufactured by SELLER.

9. PATENT INDEMNITY. SELLER agrees to protect, indemnify and hold harmless the Buyer, its successors, assigns, customers and users of its products against any liability, loss, damage or expense whatsoever resulting from any infringement of any United States Letters Patent by any thing, number, material, design, composition, or processing of SELLER's origin or practice supplied by SELLER. With respect to any thing, number, material or design, composition, or processing, specified by Buyer and not of SELLER's origin or practice, BUYER agrees to save SELLER harmless from any liability, loss damage or expense whatsoever resulting from any infringement of any United States Letters Patent arising out of SELLER's making, using or selling the same for or to BUYER in fulfillment of its orders or contracts. SELLER and BUYER severally agree to notify the other in writing promptly of any charge of infringement made and of any suit brought in respect to such device or composition and to assume or tender to the other the full control of the defense or settlement of such suit in accordance herewith.

10. WARRANTY. Seller warrants only to Buyer that products furnished of Seller's own manufacture will conform to prevailing (United States of America) industry standards as to quality, inspections, composition, quantity and type, and will be free from defects in workmanship and materials for a period of one year from the date of receipt by Buyer of the products. This warranty will not apply to damage resulting from normal wear, improper installation, misuse or neglect. Weight figures shown in Seller's catalogue and price sheets, and documents of sale are approximate only. Product is sold on a per unit basis not on a weight basis. Seller does not warrant any aspect of product representation, installation, modifications or manufacturing carried out by parties other than Seller and Buyer hereby indemnifies Seller for any loss, cost or expense to which Seller may be exposed as a result of any such activities by Buyer or Buyer's customers. Seller's sole obligation for failure to comply with this warranty will be, at its election, to repair or replace the defective product where Buyer notifies Seller and such product is made available to Seller for inspection F.O.B. Seller's facility or point of manufacture within the one year warranty period. Except to the extent that (1) descriptions of size, quality and type, which may appear on Seller invoices and other documents, and (2) statements of conformity of products with specification of certain industry, government, or professional organizations standards, which may appear as product information disclosures in Seller's literature and documents, may from time to time be construed to be express warranties, THIS WARRANTY IS IN LIEU OF AND EXCLUDES ALL OTHER WARRANTIES, EXPRESS OR IMPLIED, INCLUDING MERCHANTABILITY AND FITNESS FOR A PARTICULAR PURPOSE.

11. LIMITATION OF LIABILITY. Under no circumstances will Seller's liability in the aggregate to Buyer under any legal theory, including without limitation, breach of contract or warranty, or commission of any tort, including negligence and strict liability, or claims for indemnification, exceed the invoice price for the affected product. Buyer must commence any action at law or in equity against Seller within one year after the product is delivered to Buyer. Buyer will not have any recourse against Seller for any loss which reasonably could be prevented by cover or otherwise. Exceptions to Seller's warranty and limitation of liability provisions or waivers of the same granted by Seller will not constitute a precedent, default or waiver of Seller's rights to enforce such provisions in whole or in part in the future. SELLER WILL NOT BE LIABLE TO ANY PERSON FOR ANY INDIRECT, SPECIAL, INCIDENTAL, CONSEQUENTIAL OR OTHER DAMAGES OF ANY KIND WHATSOEVER, WHETHER ANY CLAIM OR POTENTIAL CLAIM IS BASED UPON THEORIES OF CONTRACT, NEGLIGENCE, OR TORT AND INCLUDING WITHOUT LIMITATION, SELLER WILL HAVE NO LIABILITY FOR SHIPPING CHARGES, LABOR, INSTALLATION, COSTS OR ANY OTHER LOSSES OR EXPENSES RELATED TO OR ASSOCIATED WITH THE INSPECTION, REPAIR OR REPLACEMENT OF THE WARRANTED PRODUCTS.

12. DEFAULT. Buyer will be in default if (a) Buyer fails to pay Seller any amount when due under this agreement, (b) Buyer otherwise fails for a period of five days after receiving written notice from Seller to fulfill or perform any provisions of this agreement, (c) Buyer becomes insolvent or bankrupt, or a petition is filed voluntarily or involuntarily and not dismissed within 30 days of filing, or (d) Buyer makes a general assignment for the benefit of its creditors, or a receiver is appointed, or a substantial part of Buyer's assets are attached or seized under legal process and not released within 30 days thereafter. Upon Buyer's default, Seller may, at its option, without prejudice to any of its other rights and remedies, and without demand for payments past due, (a) make shipments subject to receipt of cash in advance, (b) terminate this agreement and declare immediately due and payable the obligations of Buyer for goods previously shipped, notwithstanding any other provision in these terms and conditions, (c) demand reclamation, or (d) suspend any further deliveries until the default is corrected, without releasing Buyer from its obligations under this agreement. In any event, Buyer will remain liable for all loss and damage sustained by Seller because of Buyer's default.

13. OTHER. (a) SELLER accepts no responsibility to BUYER or to any person claiming by or through BUYER, for compliance with any statute, governmental rule or regulation made applicable to this contract by reason of BUYER's intended use of the products unless SELLER has received from BUYER prior timely written notification of such statute, rule or regulation and has accepted the same by a separate writing signed by an officer of SELLER. (b) SELLER's forbearance or failure to enforce any of these conditions as set forth herein or to exercise any right accruing from any default of BUYER shall not affect, impair or waive SELLER's right if such default continues or if any subsequent default of BUYER occurs. (c) The provisions herein constitute the entire agreement between BUYER and SELLER and no terms or conditions other than those stated herein and no agreement or understanding oral or written in any way purporting to modify these conditions shall be binding on SELLER unless hereafter made in writing and signed by an officer of SELLER. All orders are subject to acceptance at SELLER's offices. This agreement shall be construed in accordance with the laws of Tennessee and any disputes arising under these terms and conditions, and the orders to which they pertain, shall be brought exclusively in Shelby County, Tennessee. (d) The provisions of this agreement shall be considered severable. In the event that any of the provisions, or portions or applications thereof, of this agreement are held to be unenforceable or invalid by any court of competent jurisdiction, all remaining portions shall remain in full force and effect in accordance with the spirit of this agreement. (e) The rights and obligations of BUYER and SELLER hereunder shall not be assigned to any third party without the prior written consent of the other party. (f) ACCEPTANCE OF THE PRODUCTS SOLD HEREUNDER SHALL CONSTITUTE ASSENT TO THESE CONDITIONS AND SELLER HEREBY OBJECTS TO AND REJECTS ANY AND ALL ADDITIONAL OR DIFFERENT TERMS PROPOSED BY BUYER, WHETHER CONTAINED IN BUYER'S PURCHASING OR SHIPPING RELEASE FORMS OR ELSEWHERE. ALL PROPOSALS, NEGOTIATIONS, AND REPRESENTATIONS, IF ANY, MADE PRIOR AND WITH REFERENCE HERETO ARE MERGED HEREIN, AND ANY PROPOSED ADDITIONS, MODIFICATIONS, DELETIONS OR CHANGES NOT IN SEPARATE WRITINGS SIGNED BY AN OFFICER OF SELLER ARE REJECTED WITHOUT FURTHER ACTION BY SELLER.

Valves

Ball Valve • 400 PSI	3
Ball Valve • 600 PSI	3
Ball Valve • Compression	4
Ball Valve • PEX (Barbed)	4
Ball Valve • Schedule 40	4
Boiler Drain	6
Drum & Barrel Faucet	10
Evaporator Cooler Float Valve	10
Evaporator Cooler Valve	10
Float Rod Nuzzle Assembly	9
Float Valve	8
Gate Valve	5
Hose Bibb • No Kink	7
Hose Bibb • Standard	6
Sillcock	7
Stop & Waste Valve	6
Stop Valve	5
Swing Check Valve	7
Tank Float	8-9
Tank Float Rods	9
Toilet Tank Anti-Sweat Valve	8

Strainers & Drains

Bar Grate • For Soil Pipe	25
Bath Waste & Overflow	22
Bath Waste Face Plate	21
Bell Trap Loose Lid	24
C.O./P.O. Plug	18-19
Floor Drain	25
Floor Drain • Clamping Type	25
General Purpose Drain	26
Lift & Turn Drain Assembly	21
P.O. Plugs • Fixed Grid	19
Pop Up Drain	18
Pop Up Drain with Overflow	18
Replacement Crumb Cup	17
Shower Drain • Quick Caulking	23
Shower Drain • Solvent Weld	23
Shower Drain • Threaded	22
Shower Drain Grid	24
Shower Stall Drain	24
Shower Stall Strainer • Threaded	23
Sink Strainer	13
Sink Strainer • Double Cup	14
Sink Strainer • Duplex	16
Sink Strainer • Easy Connection	15
Sink Strainer • Flat Top	15
Sink Strainer • Flat Top with Rubber Stopper	16
Sink Strainer • Junior	15-16
Sink Strainer • Kitchen	15
Sink Strainer • Push & Seal	14
Sink Strainer • Spin & Seal	14
Strainer Flat Top	26
Tub Drain • Easy Touch	20
Tub Drain • Lift Lock	20
Tub Shoe Strainer & Screw	21
Wash Tray Plug	16

Specialty Fittings

Adapter • Insert	48
Closet Flange Support	30
Closet Floor Flange	29
Compression Coupling	35

Compression Coupling • For Iron Pipe Sizes	34, 37
Compression Coupling • For Tubing Sizes	37
Compression Male Adapter • For Iron Pipe Sizes	39
Compression Tee	36
Compression Tee • For Iron Pipe Sizes	39
Countersunk Plugs	31
Coupler Nipple	47
Coupling • Insert	48
CPVC Transition Adapter	43
Elbow • Drop Ear	44
Ez Span™ Repair Coupling	38
Flange Riser	29
Lead Cleanout Plugs	30
Nipple • Schedule 40	47
Nipple • Schedule 80	45-46
Poly Cut Off Riser & Extension	44
Poly Street Elbow	44
Raised Square Head Plugs	31
Rapid-Fire™ Pre-Solder Copper Fitting	49-52
Repair Clamp	32-33
Repair Clamp • Rubber Gasket	33
Test Plug	30
Trap Adapters	32
Union • Copper Tube Size (CTS)	42
Union • Schedule 80 • Gray	40-41
Union • Schedule 80 • White	41-42

Accessories & Repair

Access Panel/Wall Adapters	57
Air Gap	60
Arm & Flange Kit for Shower Head	56
Bath Faucet Coupling Elbow	55
Bath Spout & Diverter	56
Closet Spud	57
Disposal Connector	60
Drum Trap Cover	57
Escutcheons	58
Flange	59
Floor & Ceiling Plate	58
Ice Maker • Humidifier Kit	59
Jiffy Rod Shower Flange	59
Mounting Block • For Laundry Tray Faucet	55
Overflow Pipe	60
Saddle Tees	55, 59
Shower Arm • Escutcheon	56
Shower Head Brass Ball	56
Tank Levers	57
Thin Wall Shower Adapter	60
Thin Wall Shower Stall Elbow	55
Trap Vent	60

Tools

4-Way Stem Key	63
Drain Plunger	66
Nipple Extractor	63
Pipe Cutter Replacement Blades	64
Pipe Cutters	64
Socket Set	63
Street Keys	65
Toilet Plunger	66
Water Heater Element Socket	63
Water Meter Keys	65



Mueller Streamline Co. | 8285 Tournament Drive, Suite 150 | Memphis, TN 38125
www.muellerindustries.com | 800.782.2385