

OATEY[®]SCS[®]

Supply Chain Services



Product Catalog

Category	Description	Page
1 Plastic Pipe Cements and Primers	Oatey®, Hercules® and United Elchem solvent cements, primers, cleaners and related products	5
2 Thread Sealants	Hercules and Oatey thread sealants, PTFE tape and leak detectors	31
3 Copper Installation	Oatey solder, Oatey and Hercules flux, brushes, abrasives and related products	38
4 Putty, Caulks and Water Barriers	Oatey and Hercules putty, epoxy, sealing compounds and caulk	48
5 Oils, Lubricants and Hand Cleaners	Oatey and Hercules cutting oil, lubricants, hand towels and lotion cleaners and related products	54
6 Drain and Waste System Cleaners	Hercules and Cloroben® drain system cleaning products	59
7 Heating Chemicals and Anti-Freeze	Hercules heating maintenance products and Cryo-tek™ anti-freeze	63
8 Bowl Setting Wax Gaskets and Bolts	Oatey wax rings and Hercules Johni-Rings® and Johni-Bolts®	69
9 Drains and Closet Flanges	Closet flanges, shower drains, backwater valves and related products	73
10 Shower Pan Liners	Shower pan liners and related products	87
11 Supply Boxes	Washing machine, icemaker outlet boxes with related supply lines	92
12 Flashings	Metal and plastic flashings and related products	110
13 Air Admittance Valves (AAV)	Sure Vent™ and related products	117
14 Pipe Support	Pipe clamps, hanging straps and related products	122
15 Brass, Plastic and Commercial Tubular/Grab Bars	Dearborn Brass®, plastic and commercial tubular products and related products	131
16 Bath Waste and Overflow	Dearborn Brass bath waste and related products	156
17 Basket and Sink Strainers	Dearborn Brass basket strainers and related products	166
18 Pneumatic Test Balls	Cherne® Test-Ball® plugs, clean seal plugs and related products	181
19 Mechanical Test Plugs	Cherne mechanical plugs	187
20 Test Ball and Plug Accessories	Cherne deflection gauges, pressure testing equipment and accessories, smoke testing, joint testers, point repair carriers, clog-buster, hoses, gauges, poly-lift lines	192
21 Pans and Stands	Metal and plastic water heater pans; Water heater stands	197
22 Commercial Drainage	Commercial and general purpose drains, cleanouts and related products	201
23 Rough-In Products	Tub protectors, tub boxes, access panels, pipe guards, test caps and related products	230
Numerical Listing		235



The Power of One

OateySCS® is the number one source for purchasing the leading brands in the plumbing and home improvement industries. You can purchase any of our brands easily and efficiently – on one invoice, in one shipment, with one phone call. Only Oatey SCS brings you the plumbing industry's best brands in one source. That's why we're the choice for plumbing professionals.

For more information on OateySCS or our product offerings, please visit www.oatey.com or contact our customer service group at **800-321-9532**.

TRUSTED

- Comprehensive technical support
- Reputable leadership in the plumbing industry
- Experienced customer service professionals

STRONG

- Regional distribution: Dallas, Newark, Cleveland
- Multiple manufacturing locations: Colorado, Minnesota, New Jersey, Nebraska, Ohio, Mexico and China
- ISO 9001 Certified
- Twenty-two categories with a broad range of products

EFFICIENT

- VMI - Vendor Managed Inventory
- EDI - Paperless ordering, invoices and ship notices
- Automatic acknowledgements and confirmations of shipments
- Economical minimum orders for prepaid freight
- Multibranded Promotional Opportunities

SAFE

- Compliant to hazmat policies
- Sustainable practices
- C-TPAT participant



Our History

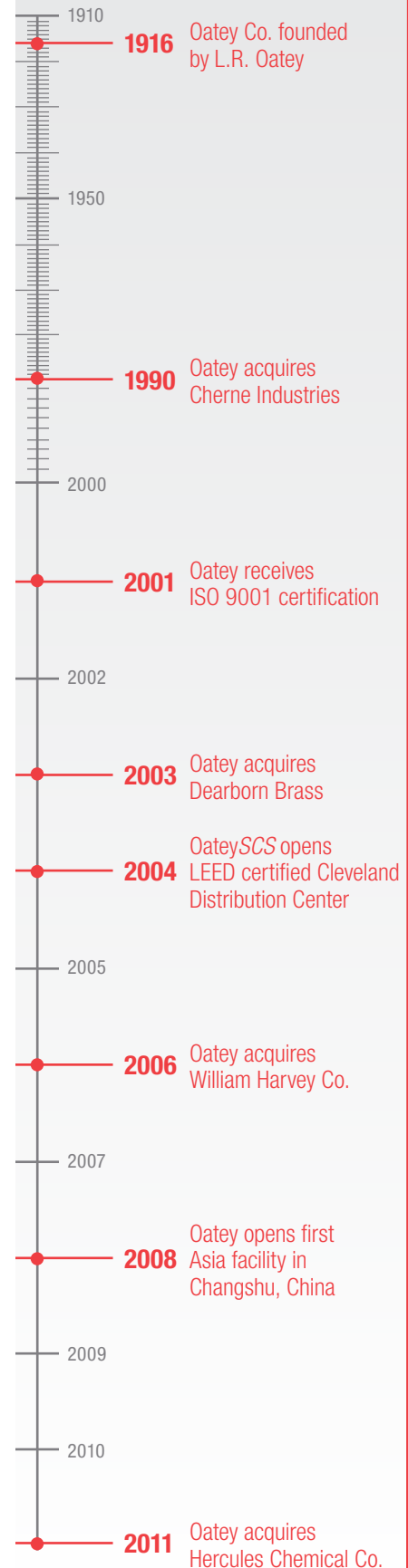

OATEYSCS® BRAND

Cherne® is the recognized world leader in pipe plug and testing equipment manufacturing. In 1998, Cherne demonstrated its commitment to quality and continuous improvement by achieving ISO 9001 registration. Cherne is the only domestic pipe plug manufacturer to achieve this certification. Serving the plumbing and underground industries for almost 50 years, Cherne is dedicated to providing customers with unparalleled product quality in addition to the highest level of customer service. From plumbing to underground—we have your products in stock.



For more information on Cherne or our product offerings, please visit www.cherneind.com.

Dearborn Brass® is the leading manufacturer of Brass and Plastic Tubular products for the plumbing industry.

Included in our product offering are Commercial Tubular, Bath Waste and Overflow, Basket Strainers and Plumbing Specialties. Dearborn Brass has been successful for more than 100 years because of the commitment of our associates to provide superior quality products at competitive prices. The Dearborn Brass name has grown to become the preferred choice of plumbing professionals, widely recognized by its distinctive checkerboard packaging. Find the checkerboard and you've found assured quality and peace of mind.



For more information on Dearborn Brass or our product offerings, please visit www.dearbornbrass.com.

Hercules® brand plumbing chemicals have been found in plumber's tool collections for nearly 100 years. The company makes more than 100 different products including chemicals, putty, drain cleaners, hand towels and Megaloc® thread sealant and PTFE tapes.



For more information on Hercules or our product offerings, please visit www.herchem.com.

Oatey® is the leading manufacturer of solvent cements, roof flashings, washing machine outlet boxes, air admittance valves, plumbing chemicals, wax bowl rings, and hundreds of other plumbing specialty products. Found in many residential and commercial applications, Oatey products have earned the trust of both plumbing professionals and consumers since 1916. Oatey Co. operates a comprehensive global manufacturing and distribution network, backed by experienced and responsive technical service professionals.



For more information on Oatey or our product offerings, please visit www.oatey.com.

Oatey SCS®

Based in Cleveland, Ohio, Oatey SCS distributes an unmatched array of more than 6,000 plumbing products. Our stable of brands has built significant equity over the years and is leveraged to penetrate various market segments. Included are **Cherne®** underground and testing equipment, **Dearborn Brass®** tubular and bath waste products, **Hercules®** plumbing chemicals, and **Oatey®** plumbing supplies.



For more information on Oatey SCS or our product offerings, please visit www.oateyscs.com.



United Elchem Industries



Category 1

Plastic Pipe Cements and Primers

Oatey sells only Lo-VOC solvent cements, which means they are compliant with the South Coast Air Quality Management District (SCAQMD) Rule 1168 and the Ozone Transport Commission (OTC) standards. Plus they meet ASTM, NSF and UPC standards for a wide variety of applications, including potable water, DWV, industrial, pool/spa, turf/irrigation, sewer and many more. With Oatey you get more than just the strongest solvent welded joint – you get the confidence of the top selling brands, backed by years of extensive research and leadership in the plumbing industry. That's why Oatey has been the choice of plumbing professionals for nearly 100 years.

Blue Lava Hot PVC Cement (see page 9)

The HOTTEST PVC cement in the industry

Maximize your productivity in all weather climates. Blue Lava Hot PVC Cement can handle any job, from irrigation and agriculture to pool and spa and is perfect for damp or humid conditions.

- **Fast** – sets up 25-50% faster than other "hot" cements on the market.
- **Hot** – quickly melts pipe surface to weld the joint. Priming step not necessary where local codes permit.
- **Thick** – Blue Lava is two to five times thicker than other "hot" cements, which means it clings to the pipe surface better, and doesn't end up on the floor.



Systems can be hydrostatically tested up to 75 PSI after 15 minutes, and up to 180 PSI after 30 minutes (at temperatures above 60°F and up to 2" pipe diameter).

Oatey Blue Lava Hot PVC Cement – nothing is hotter!



Orange Lava Hot CPVC Cement (See page 9)

The HOTTEST CPVC cement in the industry

Orange Lava Hot CPVC Cut-In Cement is perfect for any repair job that requires minimal downtime for existing plumbing systems. With the lowest set-up and cure times in the industry, Orange Lava also has the highest concentration of THF.

- **Fast** – Fast – bond strength of up to 250 PSI in just 10 minutes in lab conditions –so fast it eliminates the need for bracing.
- **Hot** – quickly melts pipe surface to weld the joint. Priming step not necessary where local codes permit.
- **Thick** – Orange Lava is two to five times thicker than other "hot" cements, which means you get more cement on the pipe, and less on the floor.



Oatey Orange Lava Hot CPVC Cut-In Cement – our hottest cement yet!



PVC CEMENTS

PVC Heavy Duty Clear Cement

- Heavy-bodied clear cement for use on all schedules and classes PVC pipe and fitting up to 12" diameter with interference fit, up to 18" for non-pressure.
- Lo-V.O.C. Solvent Cement meets California South Coast Air Quality Management District (SCAQMD) 1168/316A or BAAQMD Method 40 and various environmental requirements.
- Thick formula fills gaps in large diameter pipe and loose fitting joints.
- Recommended for potable water, pressure pipe, conduit and DWV.
- Recommended application temperature 40°F to 110°F / 4°C to 43°C.
- Meets ASTM D2564.



#31008 shown



Product No.	Size	Description	Ctn. Qty.
30850	4 oz.	PVC Heavy Duty Clear	24
30863	8 oz.	PVC Heavy Duty Clear	24
308633	8 oz	PVC Heavy Duty Clear - Display Pack	36
30876	16 oz.	PVC Heavy Duty Clear	24
308763	16 oz	PCV Heavy Duty Clear - Display Pack	10
31008	32 oz.	PVC Heavy Duty Clear	12
310083	32 oz.	PVC Heavy Duty Clear - Display Pack	6
31011	Gallon	PVC Heavy Duty Clear - Wide Mouth Can	6

PVC Heavy Duty Gray Cement

- Heavy-bodied grey cement for use on all schedules and classes PVC pipe and fitting up to 12" diameter with interference fit, up to 18" for non-pressure.
- Lo-V.O.C. Solvent Cement meets California South Coast Air Quality Management District (SCAQMD) 1168/316A or BAAQMD Method 40 and various environmental requirements.
- Thick formula fills gaps in large diameter pipe and loose fitting joints.
- Recommended for potable water, pressure pipe, conduit and DWV.
- Recommended application temperature 40°F to 110°F / 4°C to 43°C.
- Meets ASTM D2564.



#31105 shown



Product No.	Size	Description	Ctn. Qty.
31093	4 oz.	PVC Heavy Duty Gray	24
31094	8 oz.	PVC Heavy Duty Gray	24
31095	16 oz.	PVC Heavy Duty Gray	24
31105	32 oz.	PVC Heavy Duty Gray	12
31118	Gallon	PVC Heavy Duty Gray - Wide Mouth Can	6

PVC Heavy Duty Gray Fast Set Cement

- Very Heavy-bodied medium setting gray cement for use on all schedules and classes PVC pipe and fittings up to 18" diameter with interference fit.
- Lo-V.O.C. Solvent Cement meets California South Coast Air Quality Management District (SCAQMD) 1168/316A or BAAQMD Method 40 and various environmental requirements.
- Formulated for quick installation of irrigation pipe and fittings.
- Builds up for large diameter installations.
- Fills gaps in large diameter pipe and loose fitting joints.
- Recommended for potable water, pressure pipe, conduit and DWV.
- Recommended application temperature 40°F to 110°F / 4°C to 43°C.
- Meets ASTM D2564.



#31122 shown



Product No.	Size	Description	Ctn. Qty.
31121	16 oz.	PVC Heavy Duty Gray Fast Set	24
311213	16 oz.	PVC Heavy Duty Gray Fast Set - Display Pack	10
31122	32 oz.	PVC Heavy Duty Gray Fast Set	12
31123	Gallon	PVC Heavy Duty Gray Fast Set - Wide Mouth Can	6





#31020 shown



PVC Medium Clear Cement

- Medium-bodied clear cement for use on all schedules and classes of PVC pipe and fittings up to 6" diameter with interference fit.
- Lo-V.O.C. Solvent Cement meets California South Coast Air Quality Management District (SCAQMD) 1168/316A or BAAQMD Method 40 and various environmental requirements.
- Recommended for potable water, pressure pipe, conduit and DWV.
- Recommended application temperature 40°F to 110°F / 4°C to 43°C.
- Meets ASTM D2564.

Product No.	Size	Description	Ctn. Qty.
31017	4 oz.	PVC Medium Clear	24
310173	4 oz.	PVC Medium Clear - Display Pack	72
31018	8 oz.	PVC Medium Clear	24
310183	8 oz.	PVC Medium Clear - Display Pack	36
31019	16 oz.	PVC Medium Clear	24
310193	16 oz.	PCV Medium Clear - Display Pack	10
31020	32 oz.	PVC Medium Clear	12
310203	32 oz.	PVC Medium Clear - Display Pack	6
31021	Gallon	PVC Medium Clear	6



#30886 shown



PVC Medium Gray Cement

- Medium-bodied gray cement for use on all schedules and classes of PVC pipe and fittings up to 6" diameter with interference fit.
- Lo-V.O.C. Solvent Cement meets California South Coast Air Quality Management District (SCAQMD) 1168/316A or BAAQMD Method 40 and various environmental requirements.
- Recommended for potable water, pressure pipe, conduit and DWV.
- Recommended application temperature 40°F to 110°F / 4°C to 43°C.
- Meets ASTM D2564.

Product No.	Size	Description	Ctn. Qty.
30883	4 oz.	PVC Medium Gray	24
308833	4 oz.	PVC Medium Gray – Display Pack	48
30884	8 oz.	PVC Medium Gray	24
30885	16 oz.	PVC Medium Gray	24
30886	32 oz.	PVC Medium Gray	12
30887	Gallon	PVC Medium Gray	6



#31015 shown



PVC Regular Clear Cement

- Regular-bodied clear cement for use on all schedules and classes of PVC pipe and fittings up to 4" for Sch. 40 and up to 2" for Sch. 80.
- Lo-V.O.C. Solvent Cement meets California South Coast Air Quality Management District (SCAQMD) 1168/316A or BAAQMD Method 40 and various environmental requirements.
- Recommended for potable water, pressure pipe, conduit and DWV.
- Recommended application temperature 40°F to 110°F / 4°C to 43°C.
- Meets ASTM D2564.

Product No.	Size	Description	Ctn. Qty.
31012	4 oz.	PVC Regular Clear	24
310123	4 oz.	PVC Regular Clear – Display Pack	48
31013	8 oz.	PVC Regular Clear	24
310133	8 oz.	PVC Regular Clear – Display Pack	36
31014	16 oz.	PVC Regular Clear	24
310143	16 oz.	PVC Regular Clear – Display Pack	10
31015	32 oz.	PVC Regular Clear	12
310153	32 oz.	PVC Regular Clear – Display Pack	6
31016	Gallon	PVC Regular Clear	6





#31928 shown



PVC Regular Clear Advanced Cement

- Regular-bodied clear cement for use on PVC pipe and fittings up to 4" for DWV Sch. 40 and up to 2" for Sch. 80.
- Lo-V.O.C. Solvent Cement meets California South Coast Air Quality Management District (SCAQMD) 1168/316A or BAAQMD Method 40 and various environmental requirements.
- Sets up quickly.
- Recommended for potable water, pressure pipe, conduit and DWV.
- Recommended application temperature 40°F to 110°F / 4°C to 43°C.
- Meets ASTM D2564.

Product No.	Size	Description	Ctn. Qty.
31925	4 oz.	PVC Regular Clear Advanced	24
31926	8 oz.	PVC Regular Clear Advanced	24
31927	16 oz.	PVC Regular Clear Advanced	24
31928	32 oz.	PVC Regular Clear Advanced	12
31929	Gallon	PVC Regular Clear Advanced - Wide Mouth Can	6

SPECIALTY SOLVENT CEMENTS



#32163 shown



PVC Blue Lava Hot Cement

- Medium-bodied blue cement for use on all schedules and classes of PVC pipe and fittings up to 6" diameter with interference fit.
- Lo-V.O.C. Solvent Cement meets California South Coast Air Quality Management District (SCAQMD) 1168/316A or BAAQMD Method 40 and various environmental requirements.
- Very fast-setting "Hot" cement formulated for wet conditions and/or quick pressurization and fast installation.
- Recommended for potable water, sewer and DWV applications.
- Recommended application temperature 40°F to 110°F / 4°C to 43°C.
- No primer needed on non-pressure DWV, where local codes permit.
- Meets ASTM D2564.

Product No.	Size	Description	Ctn. Qty.
32160	4 oz.	PVC Blue Lava Hot Cement	24
32161	8 oz.	PVC Blue Lava Hot Cement	24
32162	16 oz.	PVC Blue Lava Hot Cement	24
32163	32 oz.	PVC Blue Lava Hot Cement	12
32164	Gallon	PVC Blue Lava Hot Cement	6



#32168 shown



Orange Lava Hot CPVC Cut-In Cement

- Lo-V.O.C. Solvent Cement meets California South Coast Air Quality Management District (SCAQMD) 1168/316A or BAAQMD Method 40 and various environmental requirements.
- Very fast setting "Hot" cement, 25-50% faster than other CPVC cements.
- No primer needed on non-pressure DWV, where local codes permit.
- Meets ASTM D2564.

Product No.	Size	Description	Ctn. Qty.
32167	16 oz.	Orange Lava CPVC Cut-In Cement	24
32168	32 oz.	Orange Lava CPVC Cut-In Cement	12



#31133 shown



PW-DWV-SEWER

PVC All Weather Clear Cement

- Medium-bodied clear cement for use on all schedules and classes of PVC pipe and fittings up to 6" diameter with interference fit.
- Lo-V.O.C. Solvent Cement meets California South Coast Air Quality Management District (SCAQMD) 1168/316A or BAAQMD Method 40 and various environmental requirements.
- Recommended application temperature -15°F to 110°F / -26°C to 43°C.
- Recommended for use on potable water, drain, waste, and vent systems.
- No primer needed on non-pressure DWV, where local codes permit.
- Meets ASTM D2564.

Product No.	Size	Description	Ctn. Qty.
31132	16 oz.	PVC All Weather Clear	24
311323	16 oz.	PVC All Weather Clear – Display Pack	10
31133	32 oz.	PVC All Weather Clear	12
31135	Gallon	PVC All Weather Clear – Wide Mouth Can	6



#31938 shown



PW-DWV-SEWER

PVC Hot Weather Plus™ Cement

- Medium-bodied clear cement for use on all schedules and classes of PVC pipe and fittings up to 6" diameter with interference fit.
- Ideal for installation in high temperature environments where additional working time is required.
- Lo-V.O.C. Solvent Cement meets California South Coast Air Quality Management District (SCAQMD) 1168/316A or BAAQMD Method 40 and various environmental requirements.
- Recommended application temperature -15°F to 110°F / -26°C to 43°C.
- Recommended for use on potable water, drain, waste, and vent systems.
- No primer needed on non-pressure DWV, where local codes permit.
- Meets ASTM D2564.

Product No.	Size	Description	Ctn. Qty.
31936	8 oz.	PVC Hot Weather Plus Medium Clear	24
31937	16 oz.	PVC Hot Weather Plus Medium Clear	24
31938	32 oz.	PVC Hot Weather Plus Medium Clear	12



#30879 shown



PW-DWV-SEWER

PVC Flexible Clear Cement

- Medium-bodied clear cement for use on flexible PVC pipe and rigid fittings up to 6" diameter with interference fit.
- Lo-V.O.C. Solvent Cement meets California South Coast Air Quality Management District (SCAQMD) 1168/316A or BAAQMD Method 40 and various environmental requirements.
- Formulated to withstand pressures and vibrations commonly associated with spa and swimming pool installations.
- Meets manufacturer's rated line pressure for flexible PVC pipe.
- Recommended application temperature 40°F to 110°F / 4°C to 43°C.
- Meets ASTM D2564.

Product No.	Size	Description	Ctn. Qty.
30875	4 oz.	PVC Flexible Clear	12
30879	32 oz.	PVC Flexible Clear	12





#30926 shown



ABS To PVC Transition Green Cement

- Medium-bodied green cement for use in joining ABS to PVC in non-pressure transition joints up to 6" diameter.
- Lo-V.O.C. Solvent Cement meets California South Coast Air Quality Management District (SCAQMD) 1168/316A or BAAQMD Method 40 and various environmental requirements.
- Recommended application temperature 40°F to 110°F / 4°C to 43°C.
- Meets ASTM D3138.

Product No.	Size	Description	Ctn. Qty.
30900	4 oz.	ABS To PVC Transition Green	24
3090033	4 oz.	ABS To PVC Transition Green – Display Pack	24
30925	16 oz.	ABS To PVC Transition Green	6
30926	32 oz.	ABS To PVC Transition Green	12
309003	4 oz.	ABS To PVC Transition Green – Display Pack	12



#30847 shown

All Purpose Cement

- Medium-bodied milky-clear cement for use on all schedules and classes of ABS, PVC and CPVC* pipe and fittings up to 6" diameter with interference fit.
- Lo-V.O.C. Solvent Cement meets California South Coast Air Quality Management District (SCAQMD) 1168/316A or BAAQMD Method 40 and various environmental requirements.
- Recommended for potable water, conduit and DWV.
- Recommended application temperature 40°F to 110°F / 4°C to 43°C.
- Meets performance requirements of ASTM D2564, D2235, F493.
- Always check local codes for acceptability of this product.

*Consult Oatey Technical Service before using.

Product No.	Size	Description	Ctn. Qty.
30818	4 oz.	All Purpose	24
308183	4 oz.	All Purpose – Display Pack	48
30821	8 oz.	All Purpose	24
308213	8 oz.	All Purpose – Display Pack	36
30834	16 oz.	All Purpose	24
308343	16 oz.	All Purpose – Display Pack	10
30847	32 oz.	All Purpose	12
30848	Gallon	All Purpose	6



ABS CEMENTS



#30902 shown



ABS Medium Black Cement

- Medium-bodied black cement for use on all schedules and classes of ABS pipe and fittings up to 6" diameter with interference fit.
- Lo-V.O.C. Solvent Cement meets California South Coast Air Quality Management District (SCAQMD) 1168/316A or BAAQMD Method 40 and various environmental requirements.
- For all non-pressure applications.
- Recommended application temperature 40°F to 110°F / 4°C to 43°C.
- Meets ASTM D2235.

Product No.	Size	Description	Ctn. Qty.
30999	4 oz.	ABS Medium Black	24
309993	4 oz.	ABS Medium Black – Display Pack	48
30889	8 oz.	ABS Medium Black	24
308893	8 oz.	ABS Medium Black – Display Pack	36
30892	16 oz.	ABS Medium Black	24
308923	16 oz.	ABS Medium Black – Display Pack	10
30902	32 oz.	ABS Medium Black	12
309023	32 oz.	ABS Medium Black – Display Pack	6
30915	Gallon	ABS Medium Black	6

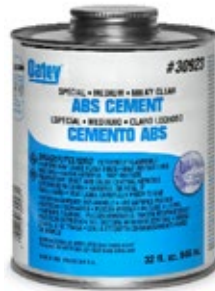

#30923 shown



ABS Special Milky Clear Cement

- Medium-bodied clear cement for use on all schedules and classes of ABS pipe and fittings up to 6" diameter with interference fit.
- Lo-V.O.C. Solvent Cement meets California South Coast Air Quality Management District (SCAQMD) 1168/316A or BAAQMD Method 40 and various environmental requirements.
- Fast curing for all non-pressure applications.
- Formulated to eliminate the clean-up problems associated with black ABS cements.
- Recommended application temperature 40°F to 110°F / 4°C to 43°C.
- Meets ASTM D2235.

Product No.	Size	Description	Ctn. Qty.
30922	16 oz.	ABS Special Milky Clear	24
30923	32 oz.	ABS Special Milky Clear	12
30924	Gallon	ABS Special Milky Clear	6



#30919 shown



ABS Extra Special Black Cement

- Medium-bodied black cement for use on all schedules and classes of ABS pipe and fittings up to 6" diameter with interference fit.
- Lo-V.O.C. Solvent Cement meets California South Coast Air Quality Management District (SCAQMD) 1168/316A or BAAQMD Method 40 and various environmental requirements.
- Formulated especially for the hot, arid climates in the Western states.
- For all non-pressure applications.
- Recommended application temperature 40°F to 110°F / 4°C to 43°C.
- Meets ASTM D2235.

Product No.	Size	Description	Ctn. Qty.
30916	4 oz.	ABS Extra Special Black	24
30917	8 oz.	ABS Extra Special Black	24
309173	8 oz.	ABS Extra Special Black – Display Pack	36
30918	16 oz.	ABS Extra Special Black	24
30919	32 oz.	ABS Extra Special Black	12
30920	Gallon	ABS Extra Special Black	6



CPVC CEMENTS



#31913 shown



All Weather CPVC FlowGuard Gold®* 1-Step Yellow Cement

- For copper tube size (CTS) CPVC hot and cold potable water pipe and fittings up to 2" diameter interference fit.
- Lo-V.O.C. Solvent Cement meets California South Coast Air Quality Management District (SCAQMD) 1168/316A or BAAQMD Method 40 and various environmental requirements.
- For cold water systems and hot water systems up to 200°F / 93°C.
- May be used without primer where local codes permit.
- Recommended application temperature 0°F to 115°F / -17°C to 46°C.
- Meets ASTM F493.

*FlowGuard Gold is a registered trademark of The Lubrizol Corporation.

Product No.	Size	Description	Ctn. Qty.
31910	4 oz.	CPVC Flowguard Gold® 1-Step Yellow	24
3191033	4 oz.	CPVC Flowguard Gold® 1-Step Yellow – Display Pack	24
31911	8 oz.	CPVC Flowguard Gold® 1-Step Yellow	24
319113	8 oz.	CPVC Flowguard Gold® 1-Step Yellow – Display Pack	40
31912	16 oz.	CPVC Flowguard Gold® 1-Step Yellow	24
319123	16 oz.	CPVC Flowguard Gold® 1-Step Yellow – Display Pack	10
31913	32 oz.	CPVC Flowguard Gold® 1-Step Yellow	12
31914	Gallon	CPVC Flowguard Gold® 1-Step Yellow	6



#31919 shown



All Weather 1-Step FlowGuard Gold®* With Ultraviolet Indicator

- For copper tube size (CTS) CPVC hot and cold potable water pipe and fittings up to 2" diameter interference fit.
- Lo-V.O.C. Solvent Cement meets California South Coast Air Quality Management District (SCAQMD) 1168/316A or BAAQMD Method 40 and various environmental requirements.
- For cold water systems and hot water systems up to 200°F / 93°C.
- CPVC FlowGuard Gold® with UltraViolet Indicator is specially formulated to allow for quick and easy inspection of dry fit joints using any ultraviolet light source.
- When solvent cement is applied properly, the yellow formula will glow BLUE under ultraviolet light.
- May be used without primer where local codes permit.
- Recommended application temperature 0°F to 115°F / -17°C to 46°C.
- Meets ASTM F493.

*FlowGuard Gold is a registered trademark of The Lubrizol Corporation.

Product No.	Size	Description	Ctn. Qty.
31917	8 oz.	1-Step CPVC Flowguard Gold® with UV Indicator	24
31918	16 oz.	1-Step CPVC Flowguard Gold® with UV Indicator	24
31919	32 oz.	1-Step CPVC Flowguard Gold® with UV Indicator	24



#31131 shown



CPVC Medium Orange Cement

- Medium-bodied orange cement for use on all schedules and classes of CPVC pipe and fittings up to 6" diameter with interference fit.
- Lo-V.O.C. Solvent Cement meets California South Coast Air Quality Management District (SCAQMD) 1168/316A or BAAQMD Method 40 and various environmental requirements.
- For Residential and Commercial hot and cold water systems up to 200°F / 93°C.
- Recommended application temperature 40°F to 110°F / 4°C to 43°C.
- Approved for Corzan® CPVC Piping Systems.
- Meets ASTM F493 and ASTM D2846.

*Corzan is a registered trademark of The Lubrizol Corporation.

Product No.	Size	Description	Ctn. Qty.
31128	4 oz.	CPVC Medium Orange	24
311283	4 oz.	CPVC Medium Orange – Display Pack	48
31129	8 oz.	CPVC Medium Orange	24
311293	8 oz.	CPVC Medium Orange – Display Pack	36
31130	16 oz.	CPVC Medium Orange	24
31131	32 oz.	CPVC Medium Orange	12
31127	Gallon	CPVC Medium Orange	6





#31083 shown



CPVC Heavy Duty Orange Solvent Cement

- Heavy-bodied orange cement for use on all schedules and classes of CPVC pipe and fittings up to 12" diameter with interference fit.
- Lo-V.O.C. Solvent Cement meets California South Coast Air Quality Management District (SCAQMD) 1168/316A or BAAQMD Method 40 and various environmental requirements.
- For Commercial hot and cold water systems up to 200°F / 93°C.
- Recommended application temperature 40°F to 110°F / 4°C to 43°C.
- Approved for Corzan® CPVC Piping Systems.
- Meets ASTM F493 and ASTM D2846.

**Corzan is a registered trademark of The Lubrizol Corporation.*

Product No.	Size	Description	Ctn. Qty.
31082	16 oz.	CPVC Heavy Duty Orange	24
31083	32 oz.	CPVC Heavy Duty Orange	12
31084	Gallon	CPVC Heavy Duty Orange – Wide Mouth Can	6



#31037 shown



CPVC Heavy Duty Gray Cement

- Heavy-bodied gray cement for use on all schedules and classes of CPVC pipe and fittings up to 12" diameter with interference fit.
- Lo-V.O.C. Solvent Cement meets California South Coast Air Quality Management District (SCAQMD) 1168/316A or BAAQMD Method 40 and various environmental requirements.
- For Commercial hot and cold water systems up to 200°F / 93°C.
- Recommended application temperature 40°F to 110°F / 4°C to 43°C.
- Approved for Corzan® CPVC Piping Systems.
- Meets ASTM F493 and ASTM D2846.

**Corzan is a registered trademark of The Lubrizol Corporation.*

Product No.	Size	Description	Ctn. Qty.
31036	16 oz.	CPVC Heavy Duty Gray	24
31037	32 oz.	CPVC Heavy Duty Gray	12

PRIMERS & CLEANERS



#30771 shown



Industrial Grade Purple Primer – NSF Listed

- Very Aggressive Purple-tinted primer for use on PVC and CPVC pipe and fittings.
- Lo-V.O.C. Solvent Cement meets California South Coast Air Quality Management District (SCAQMD) 1168/316A or BAAQMD Method 40 and various environmental requirements.
- Recommended for Commercial and Large diameter thermoplastic piping systems, specifically CPVC Sch. 40 / 80.
- Ideal for use in cold weather applications.
- Removes surface dirt, grease and grime as well as softens the pipe surface to allow a fast, secure solvent weld.
- For use in areas where plumbing code calls for verification that a primer has been used.
- NSF and IAPMO Listed.
- Meets ASTM F656.

Product No.	Size	Description	Ctn. Qty.
30770	16 oz.	Purple Primer – Industrial Grade	24
30771	32 oz.	Purple Primer – Industrial Grade	12
30772	Gallon	Purple Primer – Industrial Grade	6



#30774 shown



PW-DWV-SEWER

Industrial Grade Clear Primer – NSF Listed

- Very Aggressive Clear primer for use on PVC and CPVC pipe and fittings.
- Lo-V.O.C. Solvent Cement meets California South Coast Air Quality Management District (SCAQMD) 1168/316A or BAAQMD Method 40 and various environmental requirements.
- Recommended for Commercial and Large diameter thermoplastic piping systems, specifically CPVC Sch. 40 / 80.
- Ideal for use in cold weather applications.
- Removes surface dirt, grease and grime as well as softens the pipe surface to allow a fast, secure solvent weld.
- NSF Listed.
- Meets ASTM F656.

Product No.	Size	Description	Ctn. Qty.
30773	16 oz.	Clear Primer – Industrial Grade	24
30774	32 oz.	Clear Primer – Industrial Grade	12
30775	Gallon	Clear Primer – Industrial Grade	6



#30758 shown



PW-DWV-SEWER

Purple Primer – NSF Listed

- Purple-tinted aggressive primer for use on PVC and CPVC pipe and fittings.
- Lo-V.O.C. Solvent Cement meets California South Coast Air Quality Management District (SCAQMD) 1168/316A or BAAQMD Method 40 and various environmental requirements.
- Removes surface dirt, grease and grime as well as softens the pipe surface to allow a fast, secure solvent weld.
- For use in areas where plumbing code calls for verification that a primer has been used.
- NSF and IAPMO Listed.
- Meets ASTM F656.

Product No.	Size	Description	Ctn. Qty.
30755	4 oz.	Purple Primer	24
307553	4 oz.	Purple Primer – Display Pack	48
30756	8 oz.	Purple Primer	24
307563	8 oz.	Purple Primer – Display Pack	36
30757	16 oz.	Purple Primer	24
307573	16 oz.	Purple Primer – Display Pack	10
30758	32 oz.	Purple Primer	12
307583	32 oz.	Purple Primer – Display Pack	6
30759	Gallon	Purple Primer – Wide Mouth Can	6



#30753 shown



PW-DWV-SEWER

Clear Primer – NSF Listed

- Clear aggressive primer for use on PVC and CPVC pipe and fittings.
- Lo-V.O.C. Solvent Cement meets California South Coast Air Quality Management District (SCAQMD) 1168/316A or BAAQMD Method 40 and various environmental requirements.
- Removes surface dirt, grease and grime as well as softens the pipe surface to allow a fast, secure solvent weld.
- NSF Listed.
- Meets ASTM F656.

Product No.	Size	Description	Ctn. Qty.
30750	4 oz.	Clear Primer	24
30751	8 oz.	Clear Primer	24
30752	16 oz.	Clear Primer	24
30753	32 oz.	Clear Primer	12
30754	Gallon	Clear Primer	6



#30806 shown

Purple Primer/Cleaner

- Purple-tinted aggressive primer for use on PVC and CPVC pipe and fittings.
- Lo-V.O.C. Solvent Cement meets California South Coast Air Quality Management District (SCAQMD) 1168/316A or BAAQMD Method 40 and various environmental requirements.
- Less aggressive than clear and purple primers.
- Removes surface dirt, grease and grime for preparation before solvent cementing.
- Always check local codes for acceptability of this product.

Product No.	Size	Description	Ctn. Qty.
30780	4 oz.	Purple Primer/Cleaner	24
30783	8 oz.	Purple Primer/Cleaner	24
30796	16 oz.	Purple Primer/Cleaner	24
30806	32 oz.	Purple Primer/Cleaner	12
30768	Gallon	Purple Primer/Cleaner	6



#30805 shown

Clear Cleaner

- Clear Cleaner for ABS, PVC and CPVC pipe and fittings.
- Lo-V.O.C. Solvent Cement meets California South Coast Air Quality Management District (SCAQMD) 1168/316A or BAAQMD Method 40 and various environmental requirements.
- All schedules and all diameters.
- Flows freely and evaporates quickly.
- Fast acting cleaner removes surface dirt, grease and grime.

Product No.	Size	Description	Ctn. Qty.
30779	4 oz.	Cleaner	24
307793	4 oz.	Cleaner – Display Pack	48
30782	8 oz.	Cleaner	24
307823	8 oz.	Cleaner – Display Pack	36
30795	16 oz.	Cleaner	24
307953	16 oz.	Cleaner – Display Pack	10
30805	32 oz.	Cleaner	12
308053	32 oz.	Cleaner – Display Pack	6
30766	Gallon	Cleaner – Wide Mouth Can	6



#302443 shown

Handy Packs

- Convenient "Handy Pack" for storage – just add pipe and fittings.
- Contains one can of PVC Cement and one can of NSF Purple Primer.

Product No.	Size	Description	Ctn. Qty.
30246	4 oz.	PVC Regular & NSF Purple Primer	12
302483	8 oz.	PVC Regular & NSF Purple Primer – Display Pack	20
30246D	4 oz.	PVC Medium & NSF Purple Primer – Display Pack	24
302443	8 oz.	PVC Medium & NSF Purple Primer	20



#302483 shown



PVC CEMENTS



#60015 (Blue Label) shown



PVC - Clear, Medium Body, Medium Set Cement

- For PVC Types I & II, potable water, DWV and SW pipe and fittings up to 6" diameter.
- For Schedules 40 and 80.

Product No.	Size	Description	Ctn. Qty.
60003	4 oz.	PVC - Clear - Dauber In Cap	12
60013	8 oz.	PVC - Clear - Dauber In Cap	12
60015	16 oz.	PVC - Clear - Jumbo Dauber In Cap	12
60020	32 oz.	PVC - Clear - Jumbo Dauber In Cap	12
60025	Gallon	PVC - Clear	6



#60055 (Pink Label) shown



PVC - Clear, Regular Body, Medium Set Cement

- For PVC Types I & II, potable water and SW pipe and fittings up to 4" diameter.
- For Schedules 40.

Product No.	Size	Description	Ctn. Qty.
60043	4 oz.	PVC - Clear - Dauber In Cap	12
60053	8 oz.	PVC - Clear - Dauber In Cap	12
60055	16 oz.	PVC - Clear - Jumbo Dauber In Cap	12
60060	32 oz.	PVC - Clear - Jumbo Dauber In Cap	12



#60115 (Yellow Label) shown



PVC - Clear, Medium Body, Fast Set Cement

- For PVC Types I & II, potable water and SW pipe and fittings up to 8" diameter.
- For Schedules 40 and 80.

Product No.	Size	Description	Ctn. Qty.
60103	4 oz.	PVC - Clear - Dauber In Cap	24
60113	8 oz.	PVC - Clear - Jumbo Dauber In Cap	12
60115	16 oz.	PVC - Clear - Jumbo Dauber In Cap	12
60120	32 oz.	PVC - Clear - Jumbo Dauber In Cap	12



#60145 (Orange Label) shown



Below Zero PVC - Clear, Regular Body, Fast Set Cement

- For PVC Types I & II, potable water and SW pipe and fittings up to 6" diameter.
- For Schedules 40.

Product No.	Size	Description	Ctn. Qty.
60142	8 oz.	Below Zero PVC - Clear - Dauber In Cap	24
60145	16 oz.	Below Zero PVC - Clear - Jumbo Dauber In Cap	12
60148	32 oz.	Below Zero PVC - Clear - Jumbo Dauber In Cap	12





#60160 (Tan Label) shown



PVC - Clear, Heavy Body, Slow Set Cement

- For PVC Types I & II, potable water, DWV and SW pipe and fittings up to 15" diameter.
- For Schedules 40 and 80.

Product No.	Size	Description	Ctn. Qty.
60155	8 oz.	PVC - Clear - Dauber In Cap	24
60160	16 oz.	PVC - Clear - Jumbo Dauber In Cap	12
60165	32 oz.	PVC - Clear - Jumbo Dauber In Cap	12



#60215 (Gray Label) shown



PVC - Gray, Heavy Body, Slow Set Cement

- For PVC Types I & II, potable water, DWV and SW pipe and fittings up to 6" diameter.
- For Schedule 40.

Product No.	Size	Description	Ctn. Qty.
60210	8 oz.	PVC - Gray - Dauber In Cap	24
60215	16 oz.	PVC - Gray - Jumbo Dauber In Cap	12
60220	32 oz.	PVC - Gray - Jumbo Dauber In Cap	12
60225	Gallon	PVC - Gray	6



#60255 (Aqua Label) shown



Wet Set PVC - Aqua Blue, Medium Body, Fast Set Cement

- For PVC Types I & II, potable water, DWV and SW pipe and fittings up to 8" diameter.
- Ideal for lawn sprinkler and swimming pool installations.
- Applicable where conditions are very wet and/or when quick pressurization is imperative.
- For Schedules 40 and 80.

Product No.	Size	Description	Ctn. Qty.
60253	8 oz.	Wet Set PVC - Aqua Blue - Dauber In Cap	12
60255	16 oz.	Wet Set PVC - Aqua Blue - Jumbo Dauber In Cap	12
60260	32 oz.	Wet Set PVC - Aqua Blue - Jumbo Dauber In Cap	12

CPVC CEMENTS



#60315 (Orange Label) shown



CPVC - Orange, Medium Body, Fast Set Cement

- CPVC potable water pipe and fittings up to 8" diameter.
- For all Schedules.

Product No.	Size	Description	Ctn. Qty.
60303	4 oz.	CPVC Cement - Orange - Dauber In Cap	12
60313	8 oz.	CPVC Cement - Orange - Dauber In Cap	12
60315	16 oz.	CPVC Cement - Orange - Jumbo Dauber In Cap	12
60320	32 oz.	CPVC Cement - Orange - Jumbo Dauber In Cap	12





#60415 (Purple Label) shown

Primer For PVC And CPVC - Purple

- To soften and prepare surface of PVC and CPVC pipe and fittings.
- Use caution: Purple primers contain a dye which is difficult or impossible to remove.
- For all Schedules.



Product No.	Size	Description	Ctn. Qty.
60403	4 oz.	Primer - Purple - Dauber In Cap	12
60413	8 oz.	Primer - Purple - Dauber In Cap	12
60415	16 oz.	Primer - Purple - Jumbo Dauber In Cap	12
60420	32 oz.	Primer - Purple - Jumbo Dauber In Cap	12
60425	Gallon	Primer - Purple	6



#60845 (Purple Label) shown

PVC PRIMER-Purple

- To soften and prepare surface of PVC pipe and fittings
- For all Schedules
- Use caution: Purple primers contain a dye which is difficult or impossible to remove



Product No.	Size	Description	Ctn. Qty.
60473	4 oz.	PVC Primer-Purple- Dauber In Cap	12
60483	8 oz.	PVC Primer-Purple- Dauber In Cap	12
60485	16 oz.	Cleaner - Clear - Jumbo Dauber In Cap	12
60490	32 oz.	PVC Primer-Purple- Jumbo Dauber In Cap	12
60495	Gallon	PVC Primer- Purple	6



#60460 (Red Label) shown

PVC Primer - Clear

- To soften and prepare surface of PVC pipe and fittings.
- For all Schedules.



Product No.	Size	Description	Ctn. Qty.
60453	4 oz.	PVC Primer - Clear - Dauber In Cap	12
60458	8 oz.	PVC Primer - Clear - Dauber In Cap	12
60460	16 oz.	PVC Primer - Clear - Jumbo Dauber In Cap	12
60465	32 oz.	PVC Primer - Clear - Jumbo Dauber In Cap	12
60470	Gallon	PVC Primer - Clear	6



#60445 (Green Label) shown

Unpurple Primer For PVC And CPVC Cement

- To soften and prepare surface of PVC pipe and fittings.
- Special purple dye appears clear - purple color revealed only under UV light.
- For all Schedules.



Product No.	Size	Description	Ctn. Qty.
60445	16 oz.	Unpurple Primer For PVC And CPVC - Jumbo Dauber In Cap	12
60447	32 oz.	Unpurple Primer For PVC And CPVC - Jumbo Dauber In Cap	12



UV Flashlights

Product No.	Size	Description	Ctn. Qty.
50350	NA	High Intensity UV Flashlight	1
50360	NA	Pocket Keychain UV Flashlight	5





#60664 (Yellow Label) shown

Plastic Pipe And Fittings Cleaner - Clear

- For removing foreign matter and dirt from ABS, PVC, and CPVC, pipe and fitting
- For all Schedules.

Product No.	Size	Description	Ctn. Qty.
60652	4 oz.	Cleaner - Clear - Dauber In Cap	12
60659	8 oz.	Cleaner - Clear - Dauber In Cap	12
60664	16 oz.	Cleaner - Clear - Jumbo Dauber In Cap	12
60667	32 oz.	Cleaner - Clear - Jumbo Dauber In Cap	12

ABS CEMENTS



#60515 (Green Label) shown



ABS - Black, Medium Body, Fast Set Cement

- For DWV and SW pipe and fittings up to 8" diameter.
- For all Schedules.

Product No.	Size	Description	Ctn. Qty.
60503	4 oz.	ABS - Black - Dauber In Cap	12
60513	8 oz.	ABS - Black - Dauber In Cap	12
60515	16 oz.	ABS - Black - Jumbo Dauber In Cap	12
60520	32 oz.	ABS - Black - Jumbo Dauber In Cap	12



#60560 (Brown Label) shown



ABS/PVC Transition - Green, Medium Body, Fast Set Cement

- For joining ABS to PVC pipe and fittings up to 6" diameter.
- For all Schedules.

Product No.	Size	Description	Ctn. Qty.
60555	8 oz.	ABS/PVC Transition - Green - Dauber In Cap	24
60560	16 oz.	ABS/PVC Transition - Green - Jumbo Dauber In Cap	12



#60720 (Olive Label) shown



Multi-Purpose - Milky, Medium Body, Fast Set Cement

- For potable water, DWV and SW pipe and fittings.
- For joining PVC, CPVC and ABS pipe and fittings up to 6" diameter.
- For Schedules 40 and 80.

Product No.	Size	Description	Ctn. Qty.
60703	4 oz.	Multi-Purpose - Milky - Dauber In Cap	12
60713	8 oz.	Multi-Purpose - Milky - Dauber In Cap	12
60715	16 oz.	Multi-Purpose - Milky - Jumbo Dauber In Cap	12
60720	32 oz.	Multi-Purpose - Milky - Jumbo Dauber In Cap	12
60725	Gallon	Multi-Purpose - Milky	6



PVC CEMENTS

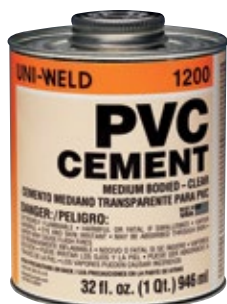

#1236S shown



1200 Series PVC Medium Clear Cement

- Medium-bodied clear cement for use on all schedules and classes of PVC pipe and fittings up to 6" diameter with interference fit.
- Lo-V.O.C. Solvent Cement meets California South Coast Air Quality Management District (SCAQMD) 1168/316A or BAAQMD Method 40 and various environmental requirements.
- Recommended for potable water, pressure pipe and DWV.
- Recommended application temperature 40°F to 110°F / 4°C to 43°C.
- Meets ASTM D2564.

Product No.	Size	Description	Ctn. Qty.
1266S	4 oz.	PVC Medium Clear	24
1256S	8 oz.	PVC Medium Clear	24
1246S	16 oz.	PVC Medium Clear	24
1236S	32 oz.	PVC Medium Clear	12
1224	Gallon	PVC Medium Clear	6



#1536S shown



1500 Series PVC Heavy Duty Clear Cement

- Heavy duty clear cement for use on all schedules and classes of PVC pipe and fittings up to 12" diameter with interference fit, up to 18" for non-pressure.
- Lo-V.O.C. Solvent Cement meets California South Coast Air Quality Management District (SCAQMD) 1168/316A or BAAQMD Method 40 and various environmental requirements.
- Recommended application temperature 40°F to 110°F / 4°C to 43°C.
- Thick formula fills gaps in large diameter pipe and loose fitting joints.
- Recommended for potable water, pressure pipe, conduit and DWV.
- Meets ASTM D2564.

Product No.	Size	Description	Ctn. Qty.
1566S	4 oz.	PVC Heavy Duty Clear	24
1556S	8 oz.	PVC Heavy Duty Clear	24
1546S	16 oz.	PVC Heavy Duty Clear	24
1536S	32 oz.	PVC Heavy Duty Clear	12
1524	Gallon	PVC Heavy Duty Clear	6



#1636S shown



1600 Series PVC Medium Gray Cement

- Medium-bodied clear cement for use on all schedules and classes of PVC pipe and fittings up to 6" diameter with interference fit.
- Lo-V.O.C. Solvent Cement meets California South Coast Air Quality Management District (SCAQMD) 1168/316A or BAAQMD Method 40 and various environmental requirements.
- Recommended application temperature 40°F to 110°F / 4°C to 43°C.
- Recommended for potable water, pressure pipe and DWV.
- Meets ASTM D2564.

Product No.	Size	Description	Ctn. Qty.
1666S	4 oz.	PVC Medium Gray	24
1656S	8 oz.	PVC Medium Gray	24
1646S	16 oz.	PVC Medium Gray	24
1636S	32 oz.	PVC Medium Gray	12
1624	Gallon	PVC Medium Gray	6



#1736S shown



1700 Series PVC Heavy Duty Gray Cement

- Heavy duty gray cement for use on all schedules and classes of PVC pipe and fittings up to 12" diameter with interference fit, up to 18" for non-pressure.
- Lo-V.O.C. Solvent Cement meets California South Coast Air Quality Management District (SCAQMD) 1168/316A or BAAQMD Method 40 and various environmental requirements.
- Recommended application temperature 40°F to 110°F / 4°C to 43°C.
- Thick formula fills gaps in large diameter pipe and pipe and fittings, loose fitting joints.
- Recommended for water, pressure pipe and DWV.
- Meets ASTM D2564.

Product No.	Size	Description	Ctn. Qty.
1756S	8 oz.	PVC Heavy Duty Gray	24
1746S	16 oz.	PVC Heavy Duty Gray	24
1736S	32 oz.	PVC Heavy Duty Gray	12
1724	Gallon	PVC Heavy Duty Gray – Wide Mouth Can	6



#1836S shown



1800 Series Super 30® Extra Heavy Body Gray PVC Cement

- Extra heavy bodied medium-setting gray cement for use on PVC pipe and fittings up to 30" diameter.
- Lo-V.O.C. Solvent Cement meets California South Coast Air Quality Management District (SCAQMD) 1168/316A or BAAQMD Method 40 and various environmental requirements.
- Builds up for large diameter installation to fill gaps.
- Recommended application temperature 40°F to 110°F / 4°C to 43°C.
- Formulated for quick installation.
- Recommended for potable water, pressure pipe and DWV.
- Meets ASTM D2564.

Product No.	Size	Description	Ctn. Qty.
1836S	32 oz.	Extra Heavy Duty Gray	12
1824	Gallon	Extra Heavy Duty Gray – Wide Mouth Can	6



#2236S shown



2200 Series PVC Regular Clear Cement

- Regular-bodied clear cement for use on all schedules and classes of PVC pipe and fittings up to 4" for Sch. 40 and up to 2" for Sch. 80.
- Lo-V.O.C. Solvent Cement meets California South Coast Air Quality Management District (SCAQMD) 1168/316A or BAAQMD Method 40 and various environmental requirements.
- Recommended for potable water, pressure pipe and DWV.
- Recommended application temperature 40°F to 110°F / 4°C to 43°C.
- Sets up quickly.
- Meets ASTM D2564.

Product No.	Size	Description	Ctn. Qty.
2266S	4 oz.	PVC Regular Clear	24
2256S	8 oz.	PVC Regular Clear	24
2246S	16 oz.	PVC Regular Clear	24
2236S	32 oz.	PVC Regular Clear	12
2224	Gallon	PVC Regular Clear	6



#2646S shown



2600 Series Polar-Weld™ PVC All Weather Cement

- Medium-bodied clear cement for use on all schedules and classes of PVC pipe and fittings up to 6" diameter with interference fit.
- Lo-V.O.C. Solvent Cement meets California South Coast Air Quality Management District (SCAQMD) 1168/316A or BAAQMD Method 40 and various environmental requirements.
- Recommended for potable water, pressure pipe and DWV.
- Formulated for fast initial set-up at temperatures down to -5°F to 110°F / -20°C to 43°C.
- No primer needed on non-pressure DWV, where local codes permit.
- Meets ASTM D2564.

Product No.	Size	Description	Ctn. Qty.
2666S	4 oz.	Polar-Weld PVC All Weather	24
2656S	8 oz.	Polar-Weld PVC All Weather	24
2646S	16 oz.	Polar-Weld PVC All Weather	24
2636S	32 oz.	Polar-Weld PVC All Weather	12
2624	Gallon	Polar-Weld PVC All Weather	6



#2836S shown



2800 Series PVC Regular Clear Fast Set Cement

- Regular-bodied clear cement for use on all schedules and classes of PVC pipe and fittings up to 4" for Sch. 40 and up to 2" for Sch. 80.
- Lo-V.O.C. Solvent Cement meets California South Coast Air Quality Management District (SCAQMD) 1168/316A or BAAQMD Method 40 and various environmental requirements.
- Recommended for potable water, pressure pipe and DWV.
- Recommended application temperature 40°F to 110°F / 4°C to 43°C.
- Sets up quickly.
- Meets ASTM D2564.

Product No.	Size	Description	Ctn. Qty.
2866S	4 oz.	PVC Regular Clear Fast Set	24
2856S	8 oz.	PVC Regular Clear Fast Set	24
2846S	16 oz.	PVC Regular Clear Fast Set	24
2836S	32 oz.	PVC Regular Clear Fast Set	12
2824	Gallon	PVC Regular Clear Fast Set	6

CPVC, ABS & MULTI-PURPOSE CEMENTS



#3246S shown



3200 Series CPVC Medium Orange Cement

- Medium-bodied orange cement for use on CPVC pipe and fittings up to 6" diameter.
- Lo-V.O.C. Solvent Cement meets California South Coast Air Quality Management District (SCAQMD) 1168/316A or BAAQMD Method 40 and various environmental requirements.
- Recommended application temperature 40°F to 110°F / 4°C to 43°C.
- Recommended for hot and cold potable water pressure pipe.
- Meets ASTM F493.

Product No.	Size	Description	Ctn. Qty.
3266S	4 oz.	CPVC Medium Orange	24
3256S	8 oz.	CPVC Medium Orange	24
3246S	16 oz.	CPVC Medium Orange	24
3236S	32 oz.	CPVC Medium Orange	12



#6236S shown

6200 Series Multi Purpose Clear Cement

- Regular-bodied clear cement for use on all schedules and classes of PVC, CPVC and ABS pipe and fittings up to 2" diameter with interference fit.
- Lo-V.O.C. Solvent Cement meets California South Coast Air Quality Management District (SCAQMD) 1168/316A or BAAQMD Method 40 and various environmental requirements.
- Recommended for potable water, pressure pipe and DWV.
- Recommended application temperature 40°F to 110°F / 4°C to 43°C.
- Meets performance requirements of ASTM D2564, D2235 and F493.

Consult Oatey Technical Service before using.

Product No.	Size	Description	Ctn. Qty.
6266S	4 oz.	Multi Purpose Regular Clear	24
6256S	8 oz.	Multi Purpose Regular Clear	24
6246S	16 oz.	Multi Purpose Regular Clear	24
6236S	32 oz.	Multi Purpose Regular Clear	12

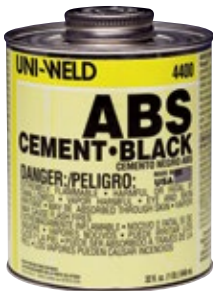

#4436S shown



4400 Series ABS Medium Black Cement

- Medium-bodied black cement for use on all schedules and classes of ABS pipe and fittings up to 6" diameter with interference fit.
- Lo-V.O.C. Solvent Cement meets California South Coast Air Quality Management District (SCAQMD) 1168/316A or BAAQMD Method 40 and various environmental requirements.
- For all non-pressure applications.
- Recommended application temperature 40°F to 110°F / 4°C to 43°C.
- Meets ASTM D2235.

Product No.	Size	Description	Ctn. Qty.
4466S	4 oz.	ABS Medium Black	24
4456S	8 oz.	ABS Medium Black	24
4446S	16 oz.	ABS Medium Black	24
4436S	32 oz.	ABS Medium Black	12
4424	Gallon	ABS Medium Black	6

PRIMERS & CLEANERS



#7336S shown

7300 Series All Purpose Clear Cleaner

- Clear cleaner for ABS, PVC and CPVC pipe and fittings.
- Lo-V.O.C. Solvent Cement meets California South Coast Air Quality Management District (SCAQMD) 1168/316A or BAAQMD Method 40 and various environmental requirements.
- Flows freely and evaporates quickly.
- Fast acting cleaner removes surface dirt, grease and grime.
- All schedules and all diameters.

Product No.	Size	Description	Ctn. Qty.
7366S	4 oz.	Clear Cleaner	24
7356S	8 oz.	Clear Cleaner	24
7346S	16 oz.	Clear Cleaner	24
7336S	32 oz.	Clear Cleaner	12
7324	Gallon	Clear Cleaner	6



#8036S shown



8000 Series Prime-Tite™ Blue Primer – NSF Listed

- Blue-tinted aggressive primer for use on PVC and CPVC pipe and fittings.
- Lo-V.O.C. Solvent Cement meets California South Coast Air Quality Management District (SCAQMD) 1168/316A or BAAQMD Method 40 and various environmental requirements.
- Formulated to work with all "TITE" products.
- Meets ASTM F656.

Product No.	Size	Description	Ctn. Qty.
8056S	8 oz.	Prime-Tite Blue Primer	24
8046S	16 oz.	Prime-Tite Blue Primer	24
8036S	32 oz.	Prime-Tite Blue Primer	12



#8736S shown



8700 Series Purple Primer – NSF Listed

- Purple-tinted aggressive primer for use on PVC and CPVC pipe and fittings.
- Lo-V.O.C. Solvent Cement meets California South Coast Air Quality Management District (SCAQMD) 1168/316A or BAAQMD Method 40 and various environmental requirements.
- For use in areas where plumbing code calls for verification that a primer has been used.
- Removes surface dirt, grease and grime as well as softens the pipe surface to allow a fast, secure solvent weld.

Product No.	Size	Description	Ctn. Qty.
8766S	4 oz.	Purple Primer	24
8756S	8 oz.	Purple Primer	24
8746S	16 oz.	Purple Primer	24
8736S	32 oz.	Purple Primer	12
8724	Gallon	Purple Primer	6



#8836S shown

8800 Series Purple Primer/Cleaner

- Purple-tinted aggressive primer for use on PVC and CPVC pipe and fittings.
- Lo-V.O.C. Solvent Cement meets California South Coast Air Quality Management District (SCAQMD) 1168/316A or BAAQMD Method 40 and various environmental requirements.
- Less aggressive than clear primer and purple primer.
- Removes surface dirt, grease and grime as well as softens the pipe surface to allow a fast, secure solvent weld.

Product No.	Size	Description	Ctn. Qty.
8866S	4 oz.	Purple Primer/Cleaner	24
8856S	8 oz.	Purple Primer/Cleaner	24
8846S	16 oz.	Purple Primer/Cleaner	24
8836S	32 oz.	Purple Primer/Cleaner	12
8824	Gallon	Purple Primer/Cleaner	6



#9936S shown



9300 Series Clear Primer – NSF Listed

- A clear aggressive primer for use on PVC and CPVC.
- Lo-V.O.C. Solvent Cement meets California South Coast Air Quality Management District (SCAQMD) 1168/316A or BAAQMD Method 40 and various environmental requirements.
- Removes surface dirt, grease and grime as well as softens the pipe surface to allow a fast, secure solvent weld.
- All schedules and all diameters.
- Meets ASTM F656.

Product No.	Size	Description	Ctn. Qty.
9366S	4 oz.	Clear Primer – NSF Listed	24
9356S	8 oz.	Clear Primer – NSF Listed	24
9346S	16 oz.	Clear Primer – NSF Listed	24
9336S	32 oz.	Clear Primer – NSF Listed	12
9324	Gallon	Clear Primer – NSF Listed	6

"TITE SERIES" CEMENTS



#2036S shown



2000 Series Plumb-Tite™ PVC Medium "Hot" Blue Cement

- Medium-bodied blue colored cement for use on all schedules and classes of flexible and rigid PVC pipe and fittings up to 6" with interference fit.
- Lo-V.O.C. Solvent Cement meets California South Coast Air Quality Management District (SCAQMD) 1168/316A or BAAQMD Method 40 and various environmental requirements.
- No primer needed on non-pressure DWV, where local codes permit.
- Very fast setting cement formulated for wet conditions and/or quick pressurization and fast installation.
- Recommended application temperature 40°F to 110°F / 4°C to 43°C.
- Recommended for potable water, pressure pipe and DWV.
- Meets ASTM D2564.

Product No.	Size	Description	Ctn. Qty.
2066S	4 oz.	Plumb-Tite PVC Medium "Hot" Blue	24
2056S	8 oz.	Plumb-Tite PVC Medium "Hot" Blue	24
2046S	16 oz.	Plumb-Tite PVC Medium "Hot" Blue	24
2036S	32 oz.	Plumb-Tite PVC Medium "Hot" Blue	12
2024	Gallon	Plumb-Tite PVC Medium " Hot" Blue	6



#2346S shown



2300 Series Pool-Tite™ Medium Blue "Hot" PVC Cement

- Medium-bodied blue colored cement for use on all schedules and classes of flexible and rigid PVC pipe and fittings up to 6" with interference fit.
- Lo-V.O.C. Solvent Cement meets California South Coast Air Quality Management District (SCAQMD) 1168/316A or BAAQMD Method 40 and various environmental requirements.
- No primer needed on non-pressure DWV, where local codes permit.
- Very fast setting cement formulated for wet conditions and/or quick pressurization and fast installation.
- Recommended application temperature 40°F to 110°F / 4°C to 43°C.
- Recommended for potable water, pressure pipe and DWV.
- Meets ASTM D2564.

Product No.	Size	Description	Ctn. Qty.
2366S	4 oz.	Pool-Tite PVC Medium "Hot" Blue	24
2356S	8 oz.	Pool-Tite PVC Medium "Hot" Blue	24
2346S	16 oz.	Pool-Tite PVC Medium "Hot" Blue	24
2336S	32 oz.	Pool-Tite PVC Medium "Hot" Blue	12
2324	Gallon	Pool-Tite PVC Medium "Hot" Blue	6



#2946S shown



2900 Series Pool-Clear™ Medium Clear PVC Cement

- Medium-bodied blue colored cement for use on all schedules and classes of flexible and rigid PVC pipe and fittings up to 6" with interference fit.
- Lo-V.O.C. Solvent Cement meets California South Coast Air Quality Management District (SCAQMD) 1168/316A or BAAQMD Method 40 and various environmental requirements.
- Specially formulated for use with flexible and rigid piping systems.
- Recommended application temperature 40°F to 110°F / 4°C to 43°C.
- Recommended for potable water, pressure pipe and DWV.
- Meets ASTM D2564.

Product No.	Size	Description	Ctn. Qty.
2946S	16 oz.	Pool-Clear PVC Medium Clear	24
2936S	32 oz.	Pool-Clear PVC Medium Clear	12



#2436S0 shown



2400 Series Turf-Tite™ PVC Medium "Hot" Blue Cement

- Medium-bodied blue colored cement for use on all schedules and classes of flexible and rigid PVC pipe and fittings up to 6" with interference fit.
- Lo-V.O.C. Solvent Cement meets California South Coast Air Quality Management District (SCAQMD) 1168/316A or BAAQMD Method 40 and various environmental requirements.
- No primer needed on non-pressure DWV, where local codes permit.
- Very fast setting cement formulated for wet conditions and/or quick pressurization and fast installation.
- Recommended application temperature 40°F to 110°F / 4°C to 43°C.
- Recommended for potable water, pressure pipe and DWV.
- Meets ASTM D2564.

Product No.	Size	Description	Ctn. Qty.
2466S	4 oz.	Turf-Tite PVC Medium "Hot" Blue	24
2456S	8 oz.	Turf-Tite PVC Medium "Hot" Blue	24
2446S	16 oz.	Turf-Tite PVC Medium "Hot" Blue	24
2436S	32 oz.	Turf-Tite PVC Medium "Hot" Blue	12
2424	Gallon	Turf-Tite PVC Medium "Hot" Blue	6



#2736S shown

2700 Series Multi-Tite™ Medium Blue "Hot" PVC Solvent Cement

- Medium-bodied blue colored cement for use on ABS, PVC and CPVC pipe and fittings up to 6" with interference fit.
- Lo-V.O.C. Solvent Cement meets California South Coast Air Quality Management District (SCAQMD) 1168/316A or BAAQMD Method 40 and various environmental requirements.
- No primer needed on non-pressure DWV, where local codes permit.
- Very fast setting cement formulated for wet conditions and/or quick pressurization and fast installation.
- Recommended application temperature 40°F to 110°F / 4°C to 43°C.
- Recommended for potable water, pressure pipe and DWV.
- Meets ASTM D2564.

Product No.	Size	Description	Ctn. Qty.
2766S	4 oz.	Multi-Tite PVC Medium "Hot" Blue	24
2756S	8 oz.	Multi-Tite PVC Medium "Hot" Blue	24
2746S	16 oz.	Multi-Tite PVC Medium "Hot" Blue	24
2736S	32 oz.	Multi-Tite PVC Medium "Hot" Blue	12



#24436S shown



#24336S shown



#3036S shown



Spa-Tite™ Heavy Duty "Hot" Blue PVC Cement

- Heavy-bodied blue colored cement for use on all schedules and classes of flexible and rigid PVC pipe and fittings up to 12" with interference fit.
- Lo-V.O.C. Solvent Cement meets California South Coast Air Quality Management District (SCAQMD) 1168/316A or BAAQMD Method 40 and various environmental requirements.
- Specially formulated for use with flexible and rigid piping systems.
- Very fast setting cement formulated for wet conditions and/or quick pressurization and fast installation.
- Recommended application temperature 40°F to 110°F / 4°C to 43°C.
- Recommended for potable water, pressure pipe and DWV.
- Meets ASTM D2564.

Product No.	Size	Description	Ctn. Qty.
24436S	32 oz.	Spa-Tite PVC Heavy Duty Blue	12

Spa-Tite™ Heavy Duty "Hot" Clear PVC Cement

- Heavy-bodied clear cement for use on all schedules and classes of flexible and rigid PVC pipe and fittings up to 12" with interference fit.
- Lo-V.O.C. Solvent Cement meets California South Coast Air Quality Management District (SCAQMD) 1168/316A or BAAQMD Method 40 and various environmental requirements.
- Specially formulated for use with flexible and rigid piping systems.
- Very fast setting cement formulated for wet conditions schedules and classes of flexible and rigid PVC pipe and/or quick pressurization and fast installation.
- Recommended application temperature 40°F to 110°F / 4°C to 43°C.
- Recommended for ALL grades and types of PVC pipe and fittings potable water, pressure pipe and DWV.
- Meets ASTM D2564.

Product No.	Size	Description	Ctn. Qty.
24336S	32 oz.	Spa-Tite PVC Heavy Duty Clear	12

3000 Series Well-Tite™ PVC Medium "Hot" Blue Cement

- Medium-bodied blue colored cement for use on all schedules and classes of flexible and rigid PVC pipe and fittings up to 6" with interference fit.
- Lo-V.O.C. Solvent Cement meets California South Coast Air Quality Management District (SCAQMD) 1168/316A or BAAQMD Method 40 and various environmental requirements.
- No primer needed on non-pressure DWV, where local codes permit.
- Very fast setting cement formulated for wet conditions and/or quick pressurization and fast installation.
- Recommended application temperature 40°F to 110°F / 4°C to 43°C.
- Recommended for potable water, pressure pipe and DWV.
- Meets ASTM D2564.

Product No.	Size	Description	Ctn. Qty.
3046S	16 oz.	Well-Tite PVC Medium "Hot" Blue	24
3036S	32 oz.	Well-Tite PVC Medium "Hot" Blue	12
3024	Gallon	Well-Tite PVC Medium "Hot" Blue	6

ACCESSORIES



Plastic Pipe Cement Brushes

Product No.	Size	Description	Ctn. Qty.
50200	1"	Plastic Pipe Cement Brush - Natural Bristle	36

Solvent Cement And Primer Accessories

- Standard replacement daubers specifically sized for 4 oz., 8 oz., 16 oz. and 32 oz. cement/primer cans.
- Brush applicator for 16 & 32 oz. cans.
- Standard replacement cans.



Product No.	Size	Description	Ctn. Qty.
31299	4 oz.	Dauber 3/4"	48
31309	8 oz.	Dauber 3/4"	48
31310	16 oz.	Dauber 1-1/2"	48
31312	32 oz.	Dauber 1-1/2"	48
31313	16/32 oz.	Dauber For CPVC Cement 3/4"	48
31257	16/32 oz.	Brush Top Dauber 1-1/2" Length	50
31275	12"	Gallon Can Roller Applicator – Fits Wide And Standard Mouth Size	12
31276	12"	Gallon Can Swab Applicator – Fits Wide And Standard Mouth Size	12
31304	4 oz.	Cement Can	24
31305	8 oz.	Cement Can	24
31306	16 oz.	Cement Can	24
31307	32 oz.	Cement Can	12
30901	1 Gallon	Wide Mouth Can	6

Adjustable Daubers

- For applying solvent cement and primers.
- Dauber is unbreakable.
- Designed to adjust to various can dimensions and evaporation of solvents and prevents spillage to ensure a good solvent weld.
- Specially constructed easy open, easy close sealing controls allows application of the proper amount of cement.
- Fits can sizes 1/2 pint through quart.
- 1/2" and 1" size daubers.



Product No.	Size	Description	Ctn. Qty.
31300	1/2"	Adjustable Plastic Dauber w/ 1/2" Ball	100
31301	1"	Adjustable Plastic Dauber w/ 1" Ball	100
31302	1"	Adjustable Plastic Dauber w/ 1" Ball	50

Cement Carrier

- Designed to make it easier to keep cement and cleaner ready for use on the job.
- Caddy holds two 32 oz. cans.
- Patented Design.



Product No.	Size	Description	Ctn. Qty.
31250	32 oz. can	Cement Carrier	12

HOW TO SOLVENT WELD



Pipe Types

CPVC: Chlorinated Polyvinyl Chloride – Typically used for pressure piping applications, including hot and cold potable water distribution. Can also be used for corrosive fluid handling in industrial or chemical applications.

ABS: Acrylonitrile Butadiene Styrene – Typically used for non-pressure piping applications.

PVC: Polyvinyl Chloride – Typically used for pressure or non-pressure piping applications.

Solvent Cements for any Application

If you need to solvent weld one pipe joint or one thousand, Oatey® is the solvent cement more professionals choose than any other brand. From hot to cold, wet to dry, Oatey has the solvent cement to meet your exact requirement for any plastic pipe installation.

Solvent Cement Cure Times

The cure time of solvent cements is dependent on several factors. The pipe size, socket fit, ambient temperature, relative humidity, solvent cements and the system operating pressure should all be considered when determining cure times.

Oatey Solvent Cements are developed with the plumbing contractor in mind. New products like **Orange Lava Hot CPVC Cement** have the lowest set up and cure times in the industry, a perfect fit for any job requiring minimal downtime.

Oatey continues to work hard to provide you peace of mind and confidence when using Oatey brand solvent cements and products.

Cure chart see page xxx

How To Solvent Weld

PRIOR TO USE: Read all product labels carefully.

Stir or shake cement before using. If jelly-like, do not use. Keep container closed when not in use. Avoid eye and skin contact. Wear safety glasses with side shields and wear rubber gloves.

1. Square pipe ends, chamfer and remove all dirt.
2. Check dry fit of pipe and fitting. Pipe should easily go 1/3 of the way into the fitting. If pipe bottoms, it should be snug.
3. Use a suitable applicator at least 1/2 the size of the pipe diameter. For larger size pipe systems use a natural bristle brush or roller.
4. Clean pipe and fitting with a listed primer. (Do not use primer on ABS pipe and fittings. Use Clear Cleaner only!)
5. Apply liberal coat of cement to pipe to the depth of the socket, leave no uncoated surface.
6. Apply a thin coat of cement to inside of fitting, avoid puddling of cement. Puddling can cause weakening and premature failure of pipe or fitting. Apply a second coat of cement to the pipe.
7. Assemble parts QUICKLY. Cement must be fluid. If cement surface has dried, recoat both parts.
8. Push pipe FULLY into fitting using a 1/4 turning motion until pipe bottoms.
9. Hold pipe and fitting together for 30 seconds to prevent pipe push-out – longer at low temperatures. Wipe off excess.
10. Allow 15 minutes for good handling strength and 2 hours cure time at temperatures above 60°F before pressure testing up to 180 psi. Longer cure times may be required at temperatures below 60°F or with pipe above 3". DO NOT TEST WITH AIR.

For specialty cements and chemical applications, please see specific product label instructions.

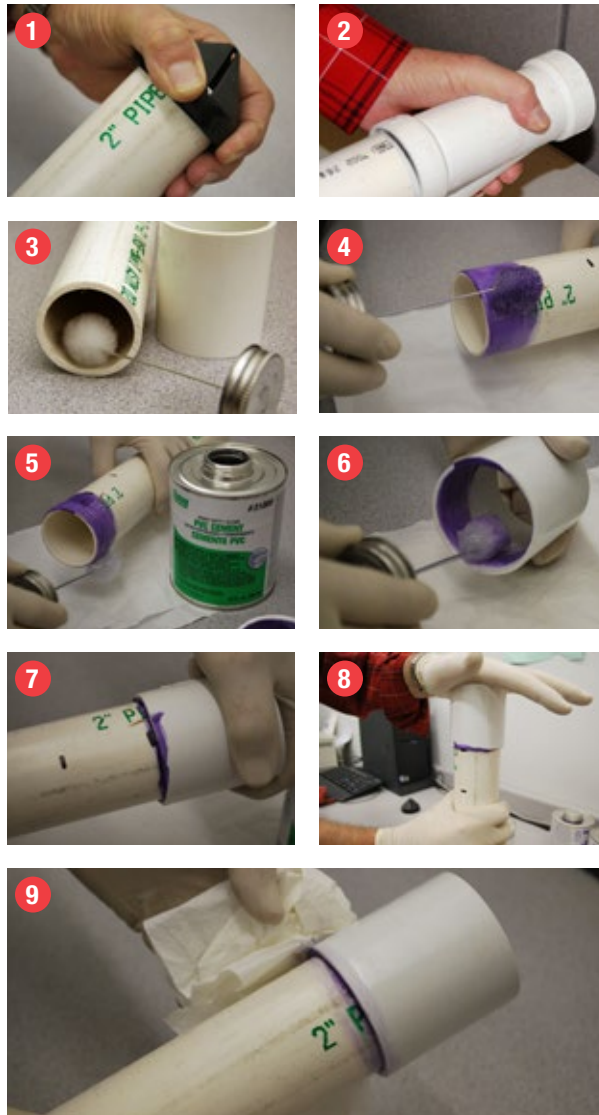



Category 2

Thread Sealants and Leak Detectors

When it comes to Thread Sealants, nobody does it better than Oatey® and Hercules®. Together we have formulated and manufactured thread sealants for more than 70 years. We continuously respond to professional plumbers' changing needs with new technology, new ideas, and new products. From low-pressure to high-pressure piping demands, from plastics to metals, as well as the market's need for PTFE – we lead the industry with Thread Sealants and Pipe Joint Compounds that provide solutions.

CATEGORY 2 THREAD SEALANTS AND LEAK DETECTORS

Hercules® MEGALOC® Thread Sealant (see page 37)

Now with DuPont™ Kevlar®

Call it the plumbing industry's only "bulletproof" thread sealant. **MEGALOC® Thread Sealant** now features **DuPont™ Kevlar®** in its formula. That's one part of what makes MEGALOC the highest performing thread sealant on the market. Another is the fact that it wipes clean from hands and tools with just a dry rag. And it washes out of clothing too.

For use on both plastic and metal pipe and fittings, MEGALOC is grit-free and does not contain PTFE. It sets soft; no cure time required; never hardens, cracks or becomes brittle. No odor. It's non-separating, non-flammable, and non-hazardous, with leak-proof hydraulic resistance to 12,000 PSI. It withstands gas pressure to 2600 PSI and performs over a temperature range of -50° to 400°F (on steel pipe).

Use MEGALOC on all metals, including galvanized steel, black iron, aluminum, copper, brass, stainless steel, and on PVC, ABS, and CPVC plastics. Not recommended for lines carrying concentrated acids, alkalis, ketones and oxygen.

Certified to ANSI/NSF Standard 61. Safe for drinking water lines. UPC listed. Meets CSA requirements 4-90 for gas. Low VOC. Meets Fed. Spec. TT-S-1732. Blue.



Only From Hercules®!





#31228 shown



Gray Pipe Joint Compound

- Non-hardening gray paste seals and lubricates threaded joints.
- For use on water, steam or air lines.
- Non-separating and non-toxic material.
- Not for use on plastic threads.

Product No.	Size	Description	Ctn. Qty.
31226	1 fl. oz.	Gray Pipe Joint Compound	12
31226D	1 fl. oz.	Gray Pipe Joint Compound – Display	54
31227	4 fl. oz.	Gray Pipe Joint Compound	12
31228	8 fl. oz.	Gray Pipe Joint Compound	12
31228D	8 fl. oz.	Gray Pipe Joint Compound – Display	30
31235	16 fl. oz.	Gray Pipe Joint Compound	24
31236	32 fl. oz.	Gray Pipe Joint Compound	12



#31229 shown



Great White® Pipe Joint Compound with PTFE

- Lubricates and seals all threaded joints.
- White, non-hardening, non-separating, non-toxic paste.
- Withstands up to 3,000 PSI on gases from -50 to +400°F, and 10,000 PSI on liquids from -50 to +500°F.
- For use with water, steam, caustics or dilute acid lines.
- Can be used with plastic and metal threads.

Product No.	Size	Description	Ctn. Qty.
31229	1 fl. oz.	Great White® Pipe Joint Compound w/PTFE	12
31229D	1 fl. oz.	Great White® Pipe Joint Compound w/ PTFE – Display	54
312291	1 fl. oz.	Great White® Pipe Joint Compound w/ PTFE – Gravity Feed	120
31230	4 fl. oz.	Great White® Pipe Joint Compound w/ PTFE	12
31230D	4 fl. oz.	Great White® Pipe Joint Compound w/ PTFE – Display	48
31231	8 fl. oz.	Great White® Pipe Joint Compound w/ PTFE	12
31231D	8 fl. oz.	Great White® Pipe Joint Compound w/ PTFE – Display	30
31232	16 fl. oz.	Great White® Pipe Joint Compound w/ PTFE	24
31233	32 fl. oz.	Great White® Pipe Joint Compound w/ PTFE	12



#31261 shown



Great Blue® Pipe Joint Compound

- Flexible blue, non-hardening, non-separating, non-toxic paste, no odor, easy clean-up.
- Use on PVC, CPVC, ABS, polyethylene, polypropylene, iron, steel, copper or brass threads up to and including 2".
- Withstands up to 3,000 PSI on gases from -50° to +400° F and 10,000 PSI on liquids from -50° to +500° F ABS, cyclocac, polypropylene, iron, steel or copper.
- Lubricates and seals thread on water, natural gas, steam, air lines, caustics and dilute acids.

Product No.	Size	Description	Ctn. Qty.
31265	1 fl. oz.	Great Blue® Pipe Joint Compound	12
31261	4 fl. oz.	Great Blue® Pipe Joint Compound	12
31262	8 fl. oz.	Great Blue® Pipe Joint Compound	12
31263	16 fl. oz.	Great Blue® Pipe Joint Compound	24
312636	16 fl. oz.	Great Blue® Pipe Joint Compound – Display	6





#31202 shown

White General Purpose Thread Seal Tape With PTFE

- Provides a clean, positive seal on threaded connections.
- A high density product that resists tearing and stretching for easy, efficient application.
- Available carded or packaged bulk on spools.
- Complies with Military Spec. No. A-A-58092 & UL 31 RO.
- 3 mils thick, 0.7 grams/cubic centimeter density.

Product No.	Size	Description	Ctn. Qty.
31199	1/2" x 260"	PTFE White Thread Seal Tape	144
31202	1/2" x 520"	PTFE White Thread Seal Tape	144
31212	3/4" x 260"	PTFE White Thread Seal Tape	144



#31403 shown

Yellow Gas Line Thread Seal Tape With PTFE

- Manufactured especially for natural gas, propane, butane, water, oil and chemical lines.
- Heavier than white tape with density of 1.35-1.50 grams/cubic centimeters, 4 mils thick.
- Complies with MIL-T-22230A (ASG), UL 31 RO, AGA 3226 and CAN/ULC-S642.
- Packaged on spools in convenient dispenser box.

Product No.	Size	Description	Ctn. Qty.
31403	1/2" x 260"	PTFE Yellow Thread Seal Tape – Dispenser Pack	100
31403D	1/2" x 260"	PTFE Yellow Thread Seal Tape – Display	20



#31402 shown

Pink Water Line Thread Seal Tape With PTFE

- Provides fast positive seal for water lines, sewage lines and sprinkler systems.
- Effective on metal or plastic threads.
- Complies with Mil. Spec. A-A 58092.
- Pink tape is 3 mils thick with density of 1.35-1.50 grams/cubic centimeter.
- Packaged on spools in a display carton.

Product No.	Size	Description	Ctn. Qty.
31402D	1/2" x 260"	PTFE Pink Thread Seal Tape – Display	50



#30209 shown

All Purpose Leak Detector

- Detects leaks quickly on all types of tubing, valves, cylinders, pressure tanks or other systems under air, gas or oxygen pressure.
- Functions in -55 F to 160 F temperature range.
- Slow evaporation rate extends inspection time.

Product No.	Size	Description	Ctn. Qty.
30209	8 oz.	All Purpose Leak Detector With Dauber	12
30211	16 oz.	All Purpose Leak Detector With Trigger Spray	12
30212	Gallon	All Purpose Leak Detector	4



#15120 shown

Megatape

- High density.
- Recommended by professionals.
- Extra-large spool.

Product No.	Size	Description	Ctn. Qty.
15100	½"x1000"	Blue PTFE Tape	63
15110	¾"x 1000"	Blue PTFE Tape	45
15120	1"x1000"	Blue PTFE Tape	36



#15176 shown

TFE Pipe Joint Tape

- Economy-grade, low density tape.
- Weather resistant; Will not "freeze", seize or harden.

Product No.	Size	Description	Ctn. Qty.
15162	1/2" x 260"	TFE Pipe Joint Tape	144
15164	1/2" x 520"	TFE Pipe Joint Tape	144
15169	1/2" x 1296"	TFE Pipe Joint Tape	36
15176	3/4" x 520"	TFE Pipe Joint Tape	36
15183	1" x 520"	TFE Pipe Joint Tape	36



Tape Dope®

- Industrial heavy grade multi-purpose PTFE tape.
- High density, high quality
- Self lubricant, easy-to-use.

Product No.	Size	Description	Ctn. Qty.
15124	1/2" x 500"	Tape Dope®	24
15127	1/2" x 750"	Tape Dope®	24
15136	3/4" x 500"	Tape Dope®	12



#15325 shown



Pipe Joint Compound

- Oil-based thread sealant.
- Not for use on plastic pipe or fittings.
- Non-setting formula; Will not harden, crack or become brittle.
- Not for use on plastic pipe or fittings.
- Rust color.

Product No.	Size	Description	Ctn. Qty.
15308	2 oz.	Pipe Joint Compound - Display, Plastic Tube (12 Trays)	144
15308B	2 oz.	Pipe Joint Compound - Plastic Tube -Bulk Pk	144
15311	1/4 pt.	Pipe Joint Compound	24
15325	1/2 pt.	Pipe Joint Compound - Screw Cap With Brush	24
15327	1 pt.	Pipe Joint Compound - Screw Cap With Brush	12
15340	Gallon	Pipe Joint Compound	4





#15420 shown



Pro Dope®

- Oil-based thread sealant.
- Not for use on plastic pipe or fittings.
- Gray color.
- Non-setting formula; Will not harden, crack or become brittle.
- Accepted for use on FlowGuard Gold® Pipe and Fittings.

Product No.	Size	Description	Ctn. Qty.
15420	1/2 pt.	Pro Dope® - Screw Cap With Brush	24
15427	1 pt.	Pro Dope® - Screw Cap With Brush	12
15433	6 lb.	Pro Dope® - Plastic Pail With Handle	6
15435	Gallon	Pro Dope®	4
15445	5 gal.	Pro Dope®	1



#15515 shown



Grrip™ - Industrial Black

- All purpose, tough, pliable, non-petroleum based seal.
- Will not harden, crack, crumble or shrink.
- Sets up quickly and dries to form a very tough, yet flexible seal.

Product No.	Size	Description	Ctn. Qty.
15510	1/4 pt.	Grrip™ - Industrial Black - Screw Cap With Brush	24
15515	1/2 pt.	Grrip™ - Industrial Black - Screw Cap With Brush	24
15520	1 pt.	Grrip™ - Industrial Black - Screw Cap With Brush	12
15525	1 qt.	Grrip™ - Industrial Black	12



#15555 shown



Grrip™ Lite - Tan Thread Sealant

- Lead-free, all-purpose pipe joint and gasket sealing compound
- For use on metals and plastics including PVC.
- Sets up quickly and dries to form a very tough, yet flexible seal.
- Ideal for sealing jobs in plumbing, heating, piping, air conditioning, refrigeration, automotive and industrial applications.
- Apply at temperatures as low as +20°F.
- Performs over a temperature range of -90°F to +450°F.
- Provides leak-proof hydraulic resistance to 12,000 psi and withstands gas pressure to 2,600 psi.

Product No.	Size	Description	Ctn. Qty.
15550	1/4 pt.	Grrip™ Lite - Neutral Beige - Screw cap with brush	24
15555	1/2 pt.	Grrip™ Lite - Neutral Beige - Screw cap with brush	24
15560	1 pt.	Grrip™ Lite - Neutral Beige - Screw cap with brush	12
15565	1 qt.	Grrip™ Lite - Neutral Beige	12
15570	1 gal	Grrip™ Lite - Neutral Beige	4



#15625 shown



Real Tuff™

- Multi-purpose, heavy duty white PTFE paste thread sealant.
- Provides leak proof hydraulic resistance to 2,000 psi.

Product No.	Size	Description	Ctn. Qty.
15605	2 oz.	Real Tuff™ - Display, Plastic Tube (4 Trays)	48
15615	1/4 pt.	Real Tuff™ - Screw Cap With Brush	24
15620	1/2 pt.	Real Tuff™ - Screw Cap With Brush	24
15625	1 pt.	Real Tuff™ - Screw Cap With Brush	12
15632	1 qt.	Real Tuff™ - Screw Cap With Brush	12
15635	Gallon	Real Tuff™	4
15640	5 gal.	Real Tuff™	1





#15711 shown

Block™

- All purpose, high performance pipe joint and gasket sealing compound.
- Leak-proof.
- Grit-free; non-separating, distinctive non-runny consistency.

Product No.	Size	Description	Ctn. Qty.
15703	1/4 pt.	Block™ - Screw Cap With Brush	24
15707	1/2 pt.	Block™ - Screw Cap With Brush	24
15711	1 pt.	Block™ - Screw Cap With Brush	12
15716	1 qt.	Block™ - Screw Cap With Brush	12



#15806 shown



Megaloc®

- Now made with DuPont™ Kevlar®.
- Wipes easily from hands and tools with dry rag.
- No odor - No waiting - Non Flammable.
- High performing thread sealant.
- Grit-free.

Product No.	Size	Description	Ctn. Qty.
15802	1.1 fl oz.	Megaloc® - Display, Plastic Tube	24
15804	1/4 pt.	Megaloc® - Screw Cap With Brush	24
15806	1/2 pt.	Megaloc® - Screw Cap With Brush	24
15808	1 pt.	Megaloc® - Screw Cap With Brush	12
15811	1 qt.	Megaloc® - Screw Cap With Brush	12
15814	Gallon	Megaloc®	4
15816	5 gal.	Megaloc®	1
15818	55 gal.	Megaloc®	1



#45804 shown

Megabubble® Leak Detector

- Detects even the smallest gas leaks.
- Produces large, blue, long-lasting bubbles.
- Clings, even to vertical surfaces.
- Non-toxic, non-corrosive formula

Product No.	Size	Description	Ctn. Qty.
45801	8 oz.	Megabubble® Leak Detector - With Dauber	24
45804	16 oz.	Megabubble® Leak Detector - With Sprayer - Display Pack	12
45802	32 oz.	Megabubble® Leak Detector - With Sprayer	12
45803	Gallon	Megabubble® Leak Detector - Refill Container	4



Pipe Dope Brush

Product No.	Size	Description	Ctn. Qty.
50310	8"	Pipe Dope Brush - Wood Handle	144





Category 3

Copper Installation

The best soldered joints come from the best cleaning and fluxing tools, as well as a careful and professional technique. Our solder, flux and cleaning tools are designed for the professional who takes pride in knowing just how to do the job right and chooses the highest quality products.

LEAD FREE WIRE SOLDER



#23001 shown



Silver Lead Free Plumbing Wire Solder

- Copper, bismuth, tin and silver alloy.
- 420°F – 460°F melting range.
- Meets ASTM Standard B-32 and the requirements of the Safe Water Drinking Act.
- Formulated for plumbing/potable water line applications

Product No.	Size	Description	Gauge	Ctn. Qty.
BULK				
22027	200 g.	Silver Lead Free Wire Solder	.084"	10
23000	1/2 lb.	Silver Lead Free Wire Solder	.117"	10
23001	1 lb.	Silver Lead Free Wire Solder	.117"	25
23002	5 lb.	Silver Lead Free Wire Solder	.117"	10



#29024 shown



Safe-Flo® Lead Free Plumbing Wire Solder

- Copper, bismuth, tin and silver alloy.
- 420°F – 460°F melting range.
- Meets ASTM Standard B-32 and the requirements of the Safe Water Drinking Act.
- Formulated for plumbing/potable water line applications

Product No.	Size	Description	Gauge	Ctn. Qty.
BULK				
29030	1 oz.	Safe-Flo Silver Wire Solder	.084"	20
29024	1/2 lb.	Safe-Flo Silver Wire Solder	.117"	10
29024D	1/2 lb.	Safe-Flo Silver Wire Solder	.117"	24
29025	1 lb.	Safe-Flo Silver Wire Solder	.117"	10
29025D	1 lb.	Safe-Flo Silver Wire Solder	.117"	20
CARDED				
53061	1 oz.	Safe-Flo Silver Wire Solder	.084"	12
53180	1 oz.	Safe-Flo Silver Wire Solder*	.084"	12
53062	1/4 lb.	Safe-Flo Silver Wire Solder	.117"	12
53188	1/4 lb.	Safe-Flo Silver Wire Solder*	.117"	12
53064	1/2 lb.	Safe-Flo Silver Wire Solder	.117"	12
53195	1/2 lb.	Safe-Flo Silver Wire Solder*	.117"	12
50683	8 oz.	Safe-Flo Silver Plumbing Kit	.117"	12
50684	8 oz.	Safe-Flo Silver Plumbing Kit*	.117"	12
50691	8 oz.	Safe-Flo/H-205 Flux Solder Kit	.117"	12
50692	1 oz.	Safe-Flo/H-2095 Flux Solder Kit	.117"	12
53013	1 oz.	Hobby Solder Kit	.063"	12
53186	1 oz.	Hobby Solder Kit*	.063"	12

*Packaged without inner display carton.



#22017 shown

95/5 Lead Free Plumbing Wire Solder

- Lead Free Alloy of 95% Tin and 5% Antimony.
- 450°F – 464°F melting range.
- Meets the requirements of the Safe Water Drinking Act.
- Most commonly used where frequent and extreme temperature changes and vibrations occur.

Product No.	Size	Description	Gauge	Ctn. Qty.
BULK				
22004	1/2 lb.	95/5 Wire Solder	.117"	10
22018	1 lb.	95/5 Wire Solder	.117"	10
22025	200g.	95/5 Wire Solder	.117"	10
22017	1 lb.	95/5 Wire Solder	.117"	25

CARDED

53026	1 oz.	95/5 Wire Solder	.081"	12
53181	1 oz.	95/5 Wire Solder*	.081"	12
53027	1/4 lb.	95/5 Wire Solder	.081"	12
53189	1/4 lb.	95/5 Wire Solder*	.063"	12

*Packaged without inner display carton.



#53172 shown

95/5 Lead Free Acid Core Wire Solder

- Lead Free Alloy of 95% Tin and 5% Antimony.
- 450°F – 464°F melting range.
- General purpose solder for sheet metal, radiator work. Acid flux is contained within the core.

Product No.	Size	Description	Gauge	Ctn. Qty.
BULK				
53170	1/2 lb.	95/5 Acid Core Wire Solder	.081"	10
53172	1 lb.	95/5 Acid Core Wire Solder	.120"	10

CARDED

53174	1.5 oz.	95/5 Acid Core Wire Solder	.081"	12
53176	1/4 lb.	95/5 Acid Core Wire Solder	.081"	12



#53173 shown

95/5 Lead Free Rosin Core Wire Solder

- Lead Free Alloy of 95% Tin and 5% Antimony.
- 450°F – 464°F melting range.
- Designed for electrical/electronic work. Rosin flux is contained within the core.

Product No.	Size	Description	Gauge	Ctn. Qty.
BULK				
53171	1/2 lb.	95/5 Rosin Core Wire Solder	.063"	10
53173	1 lb.	95/5 Rosin Core Wire Solder	.120"	10

CARDED

53175	1 oz.	95/5 Rosin Core Wire Solder	.063"	12
53177	1/4 lb.	95/5 Rosin Core Wire Solder	.063"	12
53190	1/4 lb.	95/5 Rosin Core Wire Solder*	.063"	12
29031	1 oz.	95/5 Rosin Core Wire Solder	.063"	20

*Packaged without inner display carton.



#53019 shown

Instant Solder

- Lead Free.
- Easy to use – solder and flux all in one.
- Can be used on drinking water lines.

Product No.	Size	Description	Ctn. Qty.
53019	1-1/2 oz.	Instant Solder	12
53202	1-1/2 oz.	Instant Solder*	12

*Packaged without inner display carton.

LEADED WIRE SOLDER



#53010 shown

Wire Solder

- 50/50 Alloy of 50% Tin and 50% Lead.
- 40/60 Alloy of 40% Tin and 60% Lead.
- 361°F – 421°F melting range for 50/50 Alloy.
- 361°F – 460°F melting range for 40/60 Alloy.
- Commonly used for tin plating, seaming joints, copper DWV systems and sheet metal repair.
- Contains lead. Not for use on drinking water lines.

Product No.	Size	Description	Gauge	Ctn. Qty.
BULK				
50192	1/2 lb.	50/50 Wire Solder	.125"	10
20015	1 lb.	50/50 Wire Solder	.125"	10
20019	1 lb.	50/50 Wire Solder	.125"	50
CARDED				
53010	1 oz.	50/50 Wire Solder	.075"	12
53182	1 oz.	50/50 Wire Solder*	.075"	12
53014	1/4 lb.	50/50 Wire Solder	.125"	12
53191	1/4 lb.	50/50 Wire Solder*	.125"	12
50490	1/2 lb.	50/50 Wire Solder	.125"	12
21018	1 lb.	40/60 Wire Solder	.125"	50

*Packaged without inner display carton.



#53011 shown

Acid Core Wire Solder

- 40/60 Alloy of 40% Tin and 60% Lead.
- 50/50 Alloy of 50% Tin and 50% Lead.
- 361°F – 421°F melting range for 50/50 Alloy.
- 361°F – 460°F melting range for 40/60 Alloy.
- General purpose solder for repairing galvanized gutters, filling metal seams and other general repairs.
- Contains lead. Not for use on drinking water lines.

Product No.	Size	Description	Gauge	Ctn. Qty.
BULK				
29032	1 oz.	40/60 Acid Core Wire Solder	.081"	20
20116	1 lb.	50/50 Acid Core Wire Solder	.125"	10
50193	1/2 lb.	40/60 Acid Core Wire Solder	.081"	10
21115	1 lb.	40/60 Acid Core Wire Solder	.125"	10
CARDED				
53011	1.5 oz.	40/60 Acid Core Wire Solder	.081"	12
53183	1 oz.	40/60 Acid Core Wire Solder*	.081"	12
53015	1/4 lb.	40/60 Acid Core Wire Solder	.081"	12
53192	1/4 lb.	40/60 Acid Core Wire Solder*	.081"	12
50429	1/2 lb.	40/60 Acid Core Wire Solder	.081"	12
53196	1/2 lb.	40/60 Acid Core Wire Solder*	.081"	12

*Packaged without inner display carton.



#50194 shown

Rosin Core Wire Solder

- 40/60 Alloy of 40% Tin and 60% Lead.
- 40/60 Alloy of 40% Tin and 60% Lead.
- 361°F – 460°F melting range for 40/60 Alloy.
- 361°F – 375°F melting range for 60/40 Alloy.
- Can be used for electrical applications including wiring and other fine electronic work.
- Contains lead. Not for use on drinking water lines.

Product No.	Size	Description	Gauge	Ctn. Qty.
BULK				
29033	1 oz.	40/60 Rosin Core	.063"	20
50194	1/2 lb.	60/40 Rosin Core	.063"	10
21212	1 lb.	40/60 Rosin Core	.125"	10
CARDED				
53023	1 oz.	60/40 Rosin Core	.063"	12
53012	1 oz.	40/60 Rosin Core	.063"	12
53184	1 oz.	40/60 Rosin Core	.063"	12
53185	.8 oz.	60/40 Rosin Core	.063"	12
53016	1/4 lb.	40/60 Rosin Core	.063"	12
53193	1/4 lb.	40/60 Rosin Core	.063"	12
50678	1/2 lb.	60/40 Rosin Core	.063"	12

*Packaged without inner display carton.



#21305 shown

Bar Solder

- 50/50 Alloy of 50% Tin and 50% Lead
- 361°F – 421°F melting range.
- Contains lead. Not for use on drinking water lines.
- For use with copper drain piping, tin plating, seaming joints and sheet metal.

Product No.	Size	Description	Ctn. Qty.
21305	1-1/4 lb.	50% Tin / 50% Lead Bar	10
20307	1-1/4 lb.	50% Tin / 50% Lead Bar	40

FLUX



#30011 shown



No. 5 Paste Flux

- Cleans and fluxes at the same time.
- Effective on all metals except aluminum, magnesium and stainless steel.
- 100% lead free.
- Blended to clean surface oxidation.

Product No.	Size	Description	Ctn. Qty.
30011	1.7 oz.	No. 5 Flux	12
53017	1.7 oz.	No. 5 Flux w/ Brush – Carded	12
53200	1.7 oz.	No. 5 Flux w/ Brush – Carded*	12
30013	4 oz.	No. 5 Flux	24
30038	8 oz.	No. 5 Flux	24
30014	8 oz.	No. 5 Flux	24
30041	16 oz.	No. 5 Flux	12
30041D	16 oz.	No. 5 Flux – Display	12

*Packaged without inner display carton.



#30372 shown



No. 95 Tinning Flux

- Formulated with the same high quality as No. 5. Oatey silver solder powder is added to pre-tin the copper pipe.
- Does not turn copper green.
- 100% lead free.
- Excellent for large diameter copper.

Product No.	Size	Description	Ctn. Qty.
30373	1.7 oz.	No. 95 Tinning Flux – Lead Free – Carded	12
30374	1.7 oz.	No. 95 Tinning Flux – Lead Free	12
30374D	1.7 oz.	No. 95 Tinning Flux – Lead Free – Display	48
53201	1.7 oz.	No. 95 Tinning Flux – Lead Free – Carded*	12
30372	8 oz.	No. 95 Tinning Flux – Lead Free	24
30372D	8 oz.	No. 95 Tinning Flux – Lead Free – Display	24
30375	16 oz.	No. 95 Tinning Flux – Lead Free	12

*Packaged without inner display carton.



#30133 shown



U.S. Patent No. 6,752,309

H-20^{®5} Paste Flux

- Water flushable.
- As thick as No. 5 flux.
- Meets ASTM B-813.

Product No.	Size	Description	Ctn. Qty.
30130	1.7 oz.	H-20 ⁵ Water Soluble Paste Flux	12
53067	1.7 oz.	H-20 ⁵ Water Soluble Paste Flux – Carded	12
30131	4 oz.	H-20 ⁵ Water Soluble Paste Flux	24
30132	8 oz.	H-20 ⁵ Water Soluble Paste Flux	24
30133	16 oz.	H-20 ⁵ Water Soluble Paste Flux	12



#30143 shown



U.S. Patent No. 6,752,309

H-20^{®95} Water Soluble Tinning Flux

- Water soluble tinning flux base.
- As thick as No. 5 flux.
- Solder powder added to pre-tin the pipe.

Product No.	Size	Description	Ctn. Qty.
30140	1.7 oz.	H-20 ⁹⁵ Water Soluble Tinning Flux	12
53068	1.7 oz.	H-20 ⁹⁵ Water Soluble Tinning Flux – Carded	12
30142	8 oz.	H-20 ⁹⁵ Water Soluble Tinning Flux	24
30143	16 oz.	H-20 ⁹⁵ Water Soluble Tinning Flux	12



Hot Weather Flux

- Specially formulated to remain a paste up to 135°F.

Product No.	Size	Description	Ctn. Qty.
30062	16 oz.	No. 5 Paste Flux – Hot Weather	12



No. 11 Liquid Flux

- Formulated with strong cleaning agent.
- Ensures fast and effective soldering operation.
- Can be used for HVAC applications.

Product No.	Size	Description	Ctn. Qty.
30106	4 oz.	No. 11 Liquid Flux	12



Climate Smooth™ Soldering Paste

- Smooth, premium quality, petroleum-based flux.
- Formulated for use in extreme climate temperatures all year long.
- Self-cleaning; lead-free formula.
- Will not lose its consistency in high or low temperatures.
- Meets Commercial Item Description A-A-51145 (supersedes Fed. Spec O-F-506).

Product No.	Size	Description	Ctn. Qty.
10606	1.8 oz.	6-1 Dz. Display Packs	72
10608	2 oz.	Display Pack, Screw Cap With Brush	48
10616	1/2 lb.	Climate Smooth™ Soldering Paste	24
10619	9 oz.	Screw Cap With Brush	24
10621	1 lb.	Climate Smooth™ Soldering Paste	24



Jel-Flux™

- Non-petroleum gel-type soldering flux.
- For use on most common metals except aluminum and stainless steels.
- Lead-free, self-cleaning, and flows easily.

Product No.	Size	Description	Ctn. Qty.
10810	4 oz.	Dauber In Cap	24
10815	8 oz.	Dauber In Cap	24

CLEANING TOOLS



Acid Brushes

- Perfect brush for applying liquid or paste fluxes.
- Approximately 5" long, 1/2" wide.

Product No.	Size	Description	Ctn. Qty.
30710	1/2"	Acid Brush – Carded	12
30711	1/2"	Acid Brush – Bulk (per gross)	1
30712	1/2"	Acid Brush – with Barcode	144



Flame Protector

- 9" x 12" woven ceramic (non asbestos) heat shield.
- Protects work areas from torches up to 2500°F.

Product No.	Size	Description	Ctn. Qty.
31400	9" x 12"	Bagged Flame Protector	5





#31411 shown

Plumber's Abrasive Sandcloth

- For cleaning copper pipe and fittings and other soft metals.
- Use for deburring and roughing copper tubing, as well as plastic pipe.
- Packaged on rolls in handy dispenser box or carded to keep abrasive clean when storing.
- Sandcloth backing is covered 100% with a tough aluminum oxide abrasive that provides fast cleaning and long life.

Product No.	Size	Description	Ctn. Qty.
31315	1.5" x 2 yds.	120 Grit Abrasive Sandcloth	20
31411	1.5" x 2 yds.	120 Grit Abrasive Sandcloth – Carded	10
31317	1.5" x 10 yds.	120 Grit Abrasive Sandcloth	24
31318	1.5" x 25 yds.	120 Grit Abrasive Sandcloth	12



#31321 shown

180 Open Mesh Cloth

- For working with copper, brass or aluminum.
- Made of an open nylon fabric with a phenolic resin adhesive which provides a rugged, waterproof aluminum oxide cloth of superior quality.

Product No.	Size	Description	Ctn. Qty.
31320	1.5" x 5 yds.	180 Open Mesh Cloth	24
31321	1.5" x 10 yds.	180 Open Mesh Cloth	24



Power Brushes

- Ideal for cleaning copper fittings.
- Includes 2 high carbon spring steel brushes 1/2" and 3/4".
- Brush shaft is designed for 1/4" and 1/2" power drill chuck.

Product No.	Size	Description	Ctn. Qty.
31408	1/4" & 1/2"	Power Brushes – Carded	10



#31404 shown

Heavy Duty Fitting Brush

- Easy to use, contoured, heavy duty handle is perfect for cleaning copper and brass fittings fast and effectively.
- High carbon twisted steel shaft and brush gives long life and durability.

Product No.	Size	Description	Ctn. Qty.
31327	1/2"	ID Fitting Brush w/ Heavy Duty Handle	12
31404	1/2"	ID Fitting Brush w/ Heavy Duty Handle Carded	10
31328	3/4"	ID Fitting Brush w/ Heavy Duty Handle Carded	12
31405	3/4"	ID Fitting Brush w/ Heavy Duty Handle Carded	10
31329	1"	ID Fitting Brush w/ Heavy Duty Handle	12
31406	1"	ID Fitting Brush w/ Heavy Duty Handle Carded	10
31330	1-1/4"	ID Fitting Brush w/ Heavy Duty Handle	12
31331	1-1/2"	ID Fitting Brush w/ Heavy Duty Handle	6
31332	2"	ID Fitting Brush w/ Heavy Duty Handle	6



#31336 shown

Economy Fitting Brush

- Specially designed twisted wire handle fitting brush for cleaning copper and brass fittings.
- High carbon steel brush ensures a long lasting, and sharp cutting surface.

Product No.	Size	Description	Ctn. Qty.
31336	1/2"	ID fitting brush w/ wire handle	12
31337	3/4"	ID fitting brush w/ wire handle	12
31338	1"	ID fitting brush w/ wire handle	12
31339	1-1/4"	ID fitting brush w/ wire handle	12
31340	1-1/2"	ID fitting brush w/ wire handle	6
31341	2"	ID fitting brush w/ wire handle	6



4-In-1 Brush

- Includes long lasting high carbon steel brushes for cleaning the I.D. and hand tempered steel for cleaning the O.D. of 1/2" and 3/4" copper tube and fittings.

Product No.	Size	Description	Ctn. Qty.
31407	1/2" & 3/4"	4-in-1 brush – Carded	10
31348	1/2" & 3/4"	4-in-1 brush	12



#31412 shown

O.D. Tube Cleaning Brush

- Cleans the outside of copper and plastic tubing fast.
- The easy-to-grip brush ensures a clean surface and prepares the pipe for soldering or solvent welding.

Product No.	Size	Description	Ctn. Qty.
31345	1/2"	O.D. tube brush	12
31412	1/2"	O.D. tube brush – Carded	10
31346	3/4"	O.D. tube brush	12
31413	3/4"	O.D. tube brush – Carded	10
31347	1"	O.D. tube brush	12
31414	1"	O.D. tube brush – Carded	10



Nylon Grit Pads

- Contains two 2" x 6" coarse grade nylon pads.
- For cleaning pipe and fittings and general use.

Product No.	Size	Description	Ctn. Qty.
31409		Nylon grit pads – Carded	10



Specialty Brushes

- Stainless steel bristled brush for cleaning threads on hard metal pipes.
- For cleaning pipe and fittings and general use.

Product No.	Size	Description	Ctn. Qty.
31410		Specialty brushes – Carded	10

HOW TO USE SOLDER & LEAD PRODUCTS

Application:

1. Assemble all material you will need.
2. Select Oatey® soldering products. Read all instructions carefully.
3. Select and cut the copper pipe squarely using a tubing cutter or hacksaw.
4. Clean all the copper surfaces to be joined using Oatey fitting and tubing brushes or sandcloth.
5. Apply Oatey tinning or paste flux to the inside of the copper fitting and outside of the copper pipe.
6. Assemble the joint.
7. Heat the joint evenly and apply Oatey solder wire to the joint only after flux begins to bubble. This indicates proper temperature has been reached.
8. Remove heat and solder wire once a bead has formed around the fitting. Allow the solder to cool before wiping away excess with a damp cloth.

Soldering is the most common method for connecting joints in copper water lines. Flux is used to remove foreign material from copper surfaces and to etch the copper surface. Without flux, solder will not flow into the joint. Thus, filling the void between the pipe and fitting provides a water-tight seal. Oatey Safe-Flo® Silver works much like 50/50 solder. Oatey #95 Tinning Flux contains powdered lead-free solder that melts when the joint is heated, coating the joint with a thin layer of solder that ensures the solid wire will flow into the joint. When used together, they are as easy to use as a 50/50 solder.

1. After you have selected Oatey #95 Tinning Flux and Safe-Flo Silver Solder, assemble your materials and put on protective eye wear. You'll need to cut your pipe. A tubing cutter will ensure a square cut. If the joint is not cut squarely or if the tube is mis-shaped, the joint may not solder properly.
2. All surfaces to be soldered must be free of all foreign material and the oxide that forms on copper tubing. We recommend that you use Oatey fitting and tubing brushes or sandcloth. The Oatey 4-in-1 brush is a convenient tool for cleaning 1/2" and 3/4" copper tube and fittings. If all surfaces are bright and shiny, the flux will properly etch the copper surface. When applying flux, remember to coat both the fitting and copper tube before you assemble your joint. Use caution when working with Oatey flux as well as with any flux. Do not allow contact with eyes or skin. Wear impervious clothing while handling. Wash thoroughly when finished.
3. Although heating the joint is not a complicated process, you must be sure to address a few issues before you begin.
 - If the joint to be heated is close to a floor joist, wall stud or any combustible material, place an Oatey Flame Protector between the joint and material of concern. This will provide protection from heat and flames up to 2,000° F.
 - If you are soldering an existing water line, try to drain the line as much as possible. Water in the line will prevent the joint from reaching the required temperature. If you cannot drain all the water sufficiently, place a wadded up piece of bread into the line to prevent the water from flowing. The bread will hold the water back, allow the joint to be heated, and then easily wash away through the line when the water is turned on.
 - Solder flows to the hottest part of the joint, so heat the joint evenly so that the Safe-Flo Silver Solder will flow through the entire joint. Apply heat to one side of the joint and solder wire to the other. Never heat the solder wire itself.
4. Solder is drawn into the joint by capillary action and a bead of solder will form around the joint when it's filled. When the bead appears, you know the joint is completed.
5. Be careful when wiping away the excess solder and flux residue that is left on the joint. Although the pipe may appear to be cool, always use a damp cloth to remove the excess solder and flux residue. Never touch the pipe without allowing it to cool.

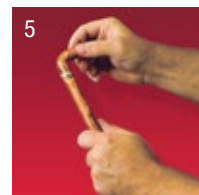
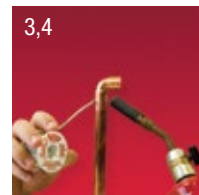
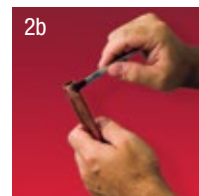
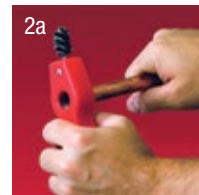



Category 4

Putty, Caulks and Water Barriers

Whether installing a faucet or strainer, resetting tile, sealing roof flashing, or repairing a pipe, professional plumbers can't afford a leak. They demand a watertight seal and they know that Oatey® and Hercules® products are formulated to do the job right every time. Stain-Free and Sta Put putty, pro poxy 20, plumbers caulk and roof and flashing sealants are trusted and synonymous with high quality and top performance.

NEW PRODUCTS

Hercules Sta Put™ Ultra®*(see page 50)*

Safe for ANY Surface

Be sure to pick the right putty for the job. Great for sinks, bowls, faucets, strainers and shower bases. It stays flexible longer and will not crack or shrink. Plus it cleans up quickly and easily.

Hercules Sta Put™ Ultra® uses a new oil-free, non staining formula that is safe for any natural porous surface including:

- Granite
- Marble
- Quartz
- Sandstone
- Corian®
- Plastic
- Any other natural, porous surface

Count on Oatey to provide the highest quality plumber's putty in the business!



NEW!
From Oatey®

CATEGORY 4 PUTTY, CAULKS AND WATER BARRIERS

Oatey®



#31166 shown

Plumber's Putty

- Fixture setting compound for setting frames, faucets, strainer baskets, etc.
- Stays flexible, will not crack or shrink.
- Easily workable, soft, pliable material.
- Not for use on marble, granite, plastic or any other dimensional stone.
- Meets Military Spec TTP-1536A.

Product No.	Size	Description	Ctn. Qty.
31166	14 oz.	Putty – Plastic container	24
31166D	14 oz.	Putty – Plastic container – Display	30
311660	14 oz.	Putty – Plastic container – Mini Pallet	270
31170	3 lb.	Putty – Plastic container	6
31174	5 lb.	Putty – Plastic container	6
31174D	5 lb.	Putty – Plastic container – Display	6



Pipe Seal

- Caulking lead substitute for sealing cast iron soil pipe joints.
- Air dry putty compound packs easily and resists shrinkage.
- Forms a hard leakproof seal.
- For use whenever it is impractical to pour molten lead.

Product No.	Size	Description	Ctn. Qty.
30614	16 oz.	Pipe Seal	12



#30240 shown

Tub-N-Tile Caulk

- White, flexible, latex sealant.
- Fills and seals cracks and joints.
- For caulking around showers, tubs, lavatories and sinks.
- Cleans up with soap and water.
- Can be used to reset loose tiles.
- Can be painted when dry with either oil base or latex paint.

Product No.	Size	Description	Ctn. Qty.
30240	6 oz.	Tub-N-Tile Caulk – Tube	24
30241	10 oz.	Tub-N-Tile Caulk – Cartridge	24



Tub-N-Tile Ultra Clear Sealant

- Applies white and dries clear.
- Flexible butyl acrylate formula adheres to porous surfaces such as wood and masonry.
- Cleans up with soap and water.
- Flexible material won't crack or peel and adheres tightly.
- Paintable with no offensive odors.

Product No.	Size	Description	Ctn. Qty.
30235	6 oz.	Tub-N-Tile Clear Sealant - Tube	12





Fix-It™ Stick Epoxy Putty

- Convenient multi-purpose sealing, patching and mending compound.
- Steel filled material, mixes in your hand and hardens in minutes.
- May be drilled, tapped, filed, sanded, sealed and painted when hardened.
- Non-toxic material contains no solvents and will not shrink.

Product No.	Size	Description	Ctn. Qty.
31270	4 oz.	Fix-It Stick Epoxy Putty	12



#30236 shown

Silicone Sealant

- Clear and white sealants for high performance sealing.
- Bonds to porcelain, ceramic, marble, fiberglass and most metals.
- Remains permanently elastic.
- When fully cured, recognized by USDA for use in meat and poultry plants.
- Withstands temperature from -60°F to 400°F.
- Meets Fed. Spec. TT-S-00230C Class A & TT-S-001543A Class A, Mil. Spec. 46106A, ASTM C920, FDA Regulation No. 21 CFR 177.2600.

Product No.	Size	Description	Ctn. Qty.
30236	10.3 oz.	Silicone Sealant, Clear - Cartridge	12
30237	10.3 oz.	Silicone Sealant, White - Cartridge	12



#25101 shown

Sta Put®

- Superior grade of plumbers' putty.
- Flexible, stretchable compound; molds easily.
- Will not harden, crumble, crack or shrink.

Product No.	Size	Description	Ctn. Qty.
25101	14 oz.	Sta Put®	24
25103	3 lb.	Sta Put®	12
25105	5 lb.	Sta Put®	6
25110	7 lb.	Sta Put® - Plastic Pail With Handle	6
25120	20 lb.	Sta Put® - Plastic Pail With Handle	2



Sta Put Ultra®

- Non-staining polymer sealant .
- Permanently soft, malleable, and flexible.
- Unique, professional grade.

Product No.	Size	Description	Ctn. Qty.
25171	14 oz.	Sta Put® Ultra	12



Plastic Seal™

- Multi-purpose caulk & repair product.
- Waterproof.
- Ideal lead substitute in lead/oakum joints.

Product No.	Size	Description	Ctn. Qty.
25215	10.3 oz.	Plastic Seal™ - Cartridge	12



#25410 shown

Roof & Flashing Sealant

- Long-lasting sealant.
- No separation; no stirring time; no objectionable odor.
- Forms durable, flexible, weatherproof coating.
- Can be applied on cold or wet surfaces.

Product No.	Size	Description	Ctn. Qty.
25403	10.3 oz.	Roof & Flashing Sealant - Cartridge	12
25405	1 qt.	Roof & Flashing Sealant	12
25410	Gallon	Roof & Flashing Sealant	6
25415	5 gal.	Roof & Flashing Sealant	1



ProPoxy® 20

- Cures in 20 minutes.
- Kneads quickly and easily.
- Seals, mends, bonds and repairs almost anything.

Product No.	Size	Description	Ctn. Qty.
25515	4 oz.	ProPoxy® 20 - Display Pack (2 - 1 Dz.)	24



Plastic Poxy™

- For most plastics.
- Fully hardens in 40 minutes.
- Kneads quickly and easily.

Product No.	Size	Description	Ctn. Qty.
25531	4 oz.	Plastic Poxy™ - Display Pack (2 - 1 Dz.)	24



ProPoxy® Triple Play Putty

- Three epoxies in one, handy package.
- Hercules ProPoxy 20, Copper Poxy and Plastic Poxy included.
- Cures in minutes.

Product No.	Size	Description	Ctn. Qty.
25527	4 oz.	ProPoxy Triple Play Putty Display Pack	24



#25615 shown

Plumbers Caulk™

- Siliconized acrylic-latex plumbers caulk.
- Flows easily, does not harden in tube or cartridge; will not crumble, resists shrinkage.
- Flexible, durable, extremely mildew-resistant, waterproof.

Product No.	Size	Description	Ctn. Qty.
25605	6 fl oz.	Plumbers Caulk™ - White - Tube Display	24
25615	11 fl oz.	Plumbers Caulk™ - White - Cartridge	12
25620	5.5 fl oz.	Plumbers Caulk™ - Clear - Tube Display	24
25625	10.3 fl oz.	Plumbers Caulk™ - Clear - Cartridge	12
25631	5.5 fl oz.	Plumbers Caulk™ - Almond/Bone - Tube Display	24
25636	10.3 fl oz.	Plumbers Caulk™ - Almond/Bone - Cartridge	12
25641	6 fl. oz.	Plumbers Caulk™ - Biscuit/Linen - Tube Display	24
25646	10 fl. oz.	Plumbers Caulk™ - Biscuit/Linen - Cartridge	12
25641R	6 fl. oz.	Plumbers Caulk™ - Linen - Tube Display	24





Plumbers Caulk - Silicone™

- High-quality 100% pure professional grade sealant.
- Excellent adhesion to most porous and non-porous materials.
- Tack-free in 30 minutes; completely cured in 24 hours.

Product No.	Size	Description	Ctn. Qty.
25676	11 oz.	Plumbers Caulk - Silicone™ - White - Cartridge	12
25686	11 oz.	Plumbers Caulk - Silicone™ - Clear - Cartridge	12



#25696 shown

Plumbers Firestop Sealant™

- Latex-based intumescent sealant.
- Meets many applications and codes.
- Provides up to a 3-hour fire rating.

Product No.	Size	Description	Ctn. Qty.
25696	10 oz.	Plumbers Firestop Sealant™ - Cartridge	12
25698	5 gal.	Plumbers Firestop Sealant™ - Pail	1



High Temp Red

- For high temperature applications.
- Flexible, durable, waterproof seal.
- Performs at temperatures ranging from -80° F to +600° F.

Product No.	Size	Description	Ctn. Qty.
25666	10.1 fl. oz.	High Temp Red – Cartridge	12



Black Magic™ Asphalt Paint

- Weather and corrosion resistant asphalt-base coating

Product No.	Size	Description	Ctn. Qty.
45210	Gallon	Black Magic™ Asphalt Paint	6





Category 5

Oils, Lubricants and Hand Cleaners

Our Oatey® and Hercules® cutting oils outperform the competition in four key areas: cutting efficiency (tap and drill test); in-use temperature and power requirements; fewest nicks and wearability on tools; and cutting the cleanest threads.

FEATURED PRODUCTS

Hercules® for Hands™ (see page 57)

Say Goodbye to Dirty "Plumber's Hands"

These pre-moistened hand cleaning towels are specifically formulated for plumbers. Anti-bacterial and ready-to-use, the towels remove industrial paints, lubricants, adhesives, tar, printer's ink, sealants, grease, oil, grime, caulks, flux and other stubborn soils. They also soften and remove plastic pipe cement. Use them for any dirty job!

Hercules for Hands towels are a safe alternative to products with harsh skin-drying solvents or abrasive particles. They contain skin-conditioning aloe vera, lanolin and vitamin E. The 12" x 10" towels are rugged, and won't shred or leave residue on hands and can also be used to clean many other surfaces (see label precautions). Each container features a unique, patented storage lid that keeps all remaining towels moist.



CATEGORY 5 OILS, LUBRICANTS AND HAND CLEANERS



5



#30200 shown

Clear Thread Cutting Oil

- Protection helps make sharp clean threads while extending the life of your dies.
- Formulated for hand thread cutting machines.
- Anti-mist and non-staining formula is not affected by weather.

Product No.	Size	Description	Ctn. Qty.
30200	16 oz.	Clear Cutting Oil (Hand Threading)	12
30201	32 oz.	Clear Cutting Oil (Hand Threading)	12
30202	Gallon	Clear Cutting Oil (Hand Threading)	6



#30205 shown

Dark Thread Cutting Oil

- Formulated for high speed cutting machines.
- A special mixture of sulfonated and chlorinated oils provides high film strength.
- Keeps machines running cooler and extends the life of your dies.
- Anti-mist and non-staining formula is not affected by weather.

Product No.	Size	Description	Ctn. Qty.
30203	16 oz.	Dark Cutting Oil (Speed Threading)	12
30204	32 oz.	Dark Cutting Oil (Speed Threading)	12
30205	Gallon	Dark Cutting Oil (Speed Threading)	6



#30601 shown

Pipe/Gasket Lube

- Non-toxic, soft, paste like material for lubricating bell joint pipe gaskets.
- Will not deteriorate natural or synthetic rubber.
- Will not support bacteria.
- Dissolves in hot water.

Product No.	Size	Description	Ctn. Qty.
30599	16 oz.	Pipe Lubricant	24
30600	32 oz.	Pipe Lubricant	12
30601	Gallon	Pipe Lubricant	4
30602	3.5 Gallon	Pipe Lubricant	1





Cream Hand Cleaner - Waterless

- Cleans hands thoroughly with or without water.
- Removes grease, paint, putty, carbon, ink, adhesives and more.
- Lubricates while it cleans.

Product No.	Size	Description	Ctn. Qty.
45304	14 oz.	Cream Hand Cleaner - Waterless	12



#45314 shown

Hercules For Hands™ - Lemon Lotion Hand Cleaner

- Professional strength cleaner formulated with pumice.
- Citrus scent.

Product No.	Size	Description	Ctn. Qty.
45314	15 oz.	Hercules For Hands™ - Lemon Lotion Hand Cleaner - Flip Top Cap	12
45316	Gallon	Hercules For Hands™ - Lemon Lotion Hand Cleaner - Pump Dispenser	4



#45325 shown

Hercules For Hands™ - Pumice Lotion Hand Cleaner

- Professional strength cleaner formulated with pumice.
- Protects and moisturizes hands with aloe vera, vitamin E and lanolin.

Product No.	Size	Description	Ctn. Qty.
45325	15 fl. oz.	Hercules For Hands™ - Pumice Lotion Hand Cleaner - Flip Top Cap	12
45328	Gallon	Hercules For Hands™ - Pumice Lotion Hand Cleaner - Pump Dispenser	4



#45333 shown

Hercules For Hands™ - Pre-Moistened Towels

- Formulated for plumbers - even removes plastic pipe cement.
- Anti-bacterial, ready-to-use.

Product No.	Size	Description	Ctn. Qty.
45333	12" x 10"	Hercules For Hands™ - Pre-Moistened Towels - Dispenser Tub Of 70 Towels	6
45333T	12" x 10"	Hercules For Hands™ - Pre-Moistened Towels - Pop Display Of 30 Tubs	30
45337	12" x 10"	Hercules For Hands™ - Pre-Moistened Towels - Thin Tub -25 Per Tub	6





#40210 shown

Cutting Oil

- Contains activated sulfur-lard and extreme pressure - antiwear additives.
- Contains no nitrosamine-forming compounds or chlorine additives
- Excellent lubrication for cutting sharp threads.
- NSF registered/USDA authorized.

Product No.	Size	Description	Ctn. Qty.
40110	1 pt.	Cutting Oil - Clear	24
40115	1 qt.	Cutting Oil - Clear	12
40120	Gallon	Cutting Oil - Clear	6
40125	5 gal.	Cutting Oil - Clear	1
40140	55 gal.	Cutting Oil - Clear	1
40210	1 pt.	Cutting Oil - Dark	24
40215	1 qt.	Cutting Oil - Dark	12
40220	Gallon	Cutting Oil - Dark	6
40225	5 gal.	Cutting Oil - Dark	1
40240	55 gal.	Cutting Oil - Dark	1



Jet-Stream Penetrating Oil

- For speedy release of "frozen", rusted or corroded parts.
- Safe for metals; will not harm painted surfaces.

Product No.	Size	Description	Ctn. Qty.
40300	12 oz.	Jet-Stream Penetrating Oil - Aerosol Can	12



Lube Oil With Extenda-Spout

- Non-gumming, non-toxic, non-detergent, and will not foam during use.
- Contains rust and corrosion preventatives.
- Custom-formulated, multi-purpose lubricating oil.

Product No.	Size	Description	Ctn. Qty.
40404	4 oz.	Lube Oil With Extenda-Spout	24



#40506 shown



Certified to NSF/ANSI 61

Duck Butter®

- Water soluble pipe lubricant.
- Adheres to wet and dry surfaces.

Product No.	Size	Description	Ctn. Qty.
40501	2 lb.	Duck Butter®	12
40506	8 lb.	Duck Butter®	4



300 Degree Plumbers Grease

- Petroleum oil-based valve and faucet stem grease.
- Waterproof; prevents corrosion.
- Non-melting, non-hazardous.

Product No.	Size	Description	Ctn. Qty.
40601	2 oz.	300 Degree Plumbers Grease	24



Plumber's Silicone Grease

- Will not melt like ordinary grease can.
- Contains no petroleum products
- Can be used on plastic and rubber components
- Non-hazardous and odor free

Product No.	Size	Description	Ctn. Qty.
40610	2 oz.	Plumbers Silicone Grease	24





CATEGORY 6 DRAIN AND WASTE SYSTEM CLEANERS

Category 6

Drain and Waste System Cleaners

When plumbing professionals need to use drain and waste system cleaners, they turn to Hercules for the best quality and highest performing products available. Two trusted brands, Hercules® and Cloroben™, offer a variety of solutions for a variety of drain cleaning challenges. These include emergency drain openers, drain system maintenance including unique clog-specific formulations, septic system care and repair, root controls, and unique grease management products.



#33441 shown

Clog Buster®

- Environmentally safe and easy-to-use way to unclog drains.
- Adapter available to use with garden hose.

Product No.	Size	Description	Ctn. Qty.
33440	1 2"	Clog Buster®	6
33441	1-1/2" – 3"	Clog Buster®	6
33442	4 – 6"	Clog Buster®	4
33444		Faucet Adapter	12
33445		Hose & Faucet Adapter Kit	4



#20110 shown

Wham®

- Environmentally safe, biodegradable waste system cleaner.
- Floral scent.
- Dissolves and controls build up - Deodorizes.

Product No.	Size	Description	Ctn. Qty.
20110	1 qt.	Wham®	12
20115	Gallon	Wham®	6
20120	5 gal.	Wham®	1
20130	55 gal.	Wham®	1



#20211 shown

Clobber® (For Professional Use Only - Not For Retail Sale)

- Fastest method for clearing emergency waste line stoppages.
- Rapidly disintegrates paper, rags, food and all organic matter.
- Not for retail use or sale.

Product No.	Size	Description	Ctn. Qty.
20205	1 qt.	Clobber®	12
20211	1/2 gal.	Clobber® - With Saf-T-Por Spout	6



#20310 shown

Sizzle® (For Professional Use Only - Not For Retail Sale)

- Triple action formula.
- Effective removal of urinary salts, lime, rust, scale, etc.

Product No.	Size	Description	Ctn. Qty.
20305	1 qt.	Sizzle®	12
20310	Gallon	Sizzle® -With Saf-T-Por Spout	4





#20410 shown

Glug®

- Non-acid crystals clear sluggish drains, prevents clogs.
- Harmless to most metal and plastic pipe, valves and fittings.

Product No.	Size	Description	Ctn. Qty.
20412	16 oz.	Glug® - Crystals	24
20410	20 oz.	Glug® - Crystals	24
20413	2 lb.	Glug® - Crystals	12
20415	5 lb.	Glug® - Crystals	6
20450	1 qt.	Glug® - Bath - Liquid	10
20455	1/2 gal.	Glug® - Bath - Liquid	6
20470	1 qt.	Glug® - Kitchen - Liquid	10
20475	1/2 gal.	Glug® - Kitchen - Liquid	6



Root Force Foaming Root Destroyer

- In water soluble bags - just drop and flush sealed package.
- Prevents and clears root-blocked sewer lines.
- Saleable in all states except California, where approval is pending.
- No measuring, mixing or mess.
- Does not contain copper.

Product No.	Size	Description	Ctn. Qty.
20550	1 lb. (2-8oz. bags)	Root Force Foaming Root Destroyer	6



#20602 shown

R-D™ - Root Destroyer

- Non-acid, non-caustic herbicide.
- Harmless to skin and clothing; safe to use in lines leading to septic tanks, cesspools and drywells.
- Dissolves slowly.
- Not for use in CT or some jurisdictions in CA.

Product No.	Size	Description	Ctn. Qty.
20602	2 lb.	R-D™ - Root Destroyer	6
20610	50 lb.	R-D™ - Root Destroyer	1



#45400 shown

Iron Ike® Rust Remover

- Dissolves and removes rust stains on contact.
- Contains no dangerous phosphoric acid, phosphates or chlorine.

Product No.	Size	Description	Ctn. Qty.
45400	20 oz.	Iron Ike® Rust Remover	12
45403	5 lb.	Iron Ike® Rust Remover	6



#137301 shown

Cloroben PT-BIO1™

- Concentrated liquid blend of fast acting grease dissolver.
- Contains no acids, caustics, solvents or other harsh chemicals.

Product No.	Size	Description	Ctn. Qty.
137301	1 qt.	Cloroben PT-BIO1™	12
137303	Gallon	Cloroben PT-BIO1™	4
137304	5 gal.	Cloroben PT-BIO1™ - Pail	1
137307	15 gal.	Cloroben PT-BIO1™ - Drum	1
137308	30 gal.	Cloroben PT-BIO1™ - Drum	1
137309	55 gal.	Cloroben PT-BIO1™ - Drum	1





Cloroben Clorodoser

- Automatic dispensing system
- Maintains and manages waste and grease disposal

Product No.	Size	Description	Ctn. Qty.
301005		Automatic Dispenser	1
301050		AC Power Adaptor	1



#137503 shown

Cloroben PT-4™

- Unique non-acid, non-caustic formulation.
- Safely liquefies and disperse grease, soap scum, food residue, sludge and other build-ups.

Product No.	Size	Description	Ctn. Qty.
137501	1 qt.	Cloroben PT-4™	12
137503	Gallon	Cloroben PT-4™	4
137504	5 gal.	Cloroben PT-4™ - Pail	1
137507	15 gal.	Cloroben PT-4™ - Drum	1
137509	55 gal.	Cloroben PT-4™ - Drum	1



Septic Tank and Cesspool Cleaner

- Dissolves grease and organic matter in cesspools, septic tanks and grease traps.
- Ideal for emergency use to eliminate back-up and overflow.
- Non-acid formula. NSF registered. USDA authorized. CT D.E.P. sec. 22a-462-3 R.C.S.A.

Product No.	Size	Description	Ctn. Qty.
20705	5 lb.	Hercules Septic Tank and Cesspool Cleaner	6
20715	25 lb.	Hercules Septic Tank and Cesspool Cleaner	1



Cloroben Septic-Flow™

- Concentrated liquid bacterial additives.
- Keeps septic systems in peak condition

Product No.	Size	Description	Ctn. Qty.
139302	1/2 gal.	Cloroben Septic-Flow™	6



Cloroben Bacta-Life®

- A concentrated powdered product.
- Replaces beneficial bacteria.

Product No.	Size	Description	Ctn. Qty.
222031	1 lb.	Cloroben Bacta-Life®	12



Cloroben Aid-Ox®

- Oxygen-based foaming porosity restorer and cleaner.
- Frequently used on seasonal rentals.
- Non-aid, non-caustic formulation.

Product No.	Size	Description	Ctn. Qty.
252034	9 lb.	Cloroben Aid-Ox®	4



Cloroben Open Wide®

- Crystal drain opener.
- Effervescent, low heat formula.

Product No.	Size	Description	Ctn. Qty.
271131	1 lb.	Cloroben Open Wide®	12





Category 7

Heating Chemicals and Anti-Freeze

A well-maintained hydronic heating system provides reliable performance even during the harshest winters. Heating maintenance professionals know that top quality materials are critical to achieve superior performance. That's why contractors depend on Hercules maintenance and stop-leak products. They are formulated for high performance and developed with both the user and the environment in mind. Hercules "clean and friendly" furnace cement is the latest example of this commitment. Its patented formula is the first and only to meet OSHA's requirement of less than .1% crystalline silica.

Hercules® Cryo-Tek Solar System™ (see page 67)

Anti-Freeze for Solar Panel Systems

Hercules® introduces **CRYO-TEK Solar System™ Anti-Freeze**, specially formulated for closed loop anti-freeze heat exchanger systems. It contains virgin propylene glycol and high purity triple protection additives, which stabilize pH to prevent acid corrosion, chelate hard water minerals and inhibit scale formation and sediment. CRYO-TEK Solar System can also be used in radiant tube heating systems and geothermal loops. Solar System Anti-Freeze is compatible with PEX and elastomeric radiant tubing, commonly used materials for seals and bushings, and provides corrosion protection for aluminum, steel, stainless steel, rubber and most plastic components. Solar System Anti-Freeze is a 94-98% efficient heat transfer solution in most application dilutions. Available in 5 gallon buckets or 55 gallon drums. See Specification Sheet for details on www.herchem.com.



NEW!
From Hercules®





#30115 shown

Boiler Liquid

- Seals and repairs cracks and leaks in steam and hot water systems
- No odors - no priming - no foaming

Product No.	Size	Description	Ctn. Qty.
30115	1 qt.	Stop Leak	12
30120	Gallon	Stop Leak	6
30125	5 gal.	Stop Leak	1



#30213 shown

Base Hit™ II

- Seals and prevents leaks in ferrous, non-ferrous and radiant tube
- Works fast and does not clog hydronic systems.

Product No.	Size	Description	Ctn. Qty.
30213	12 oz.	Stop Leak	12
30213R	12 oz.	Stop Leak - 6 Pack	6
30206	Gallon	Stop Leak	6
30214	5 gal.	Stop Leak	1



#30310 shown

Boiler Solder

- Powdered stop-leak works quickly
- No odors; petroleum-free
- Resists high pressure and temperature
- Will not clog

Product No.	Size	Description	Ctn. Qty.
30310	1 lb.	Stop Leak	12
30320	200 lb.	Stop Leak	1



Scout™

- Non-toxic, odorless steam boiler cleaner
- Contains fast acting Trisodium Phosphate (TSP)

Product No.	Size	Description	Ctn. Qty.
35100	113 gram	Boiler Cleaner	12



Airspray

- Formulated to eliminate fuel oil and septic odors
- Contains no CFCs or other chlorinated ingredients

Product No.	Size	Description	Ctn. Qty.
35151	16 oz.	Airspray	12



#35152 shown

Blot-O™ Plus

- Fuel absorber for cleaning spills
- Absorbs eight times its volume of fuel oil
- Sweet fragrance eliminates odor

Product No.	Size	Description	Ctn. Qty.
35155	19 oz.	Shaker Top Can	12
35152	15 lb.	Reusable Plastic Pail	1



Electrical Contact Cleaner

- Combination of solvents and propellants
- Removes oil, dirt and moisture from small electrical equipment controls, ignition systems, motors, relays and thermostats
- No rinse required

Product No.	Size	Description	Ctn. Qty.
35180	11 oz.	Aerosol Can	12



Citrus Foaming Degreaser

- General purpose cleaner/degreaser
- Simple water rinse
- Aggressive foaming action
- Non-corrosive and contains no petroleum distillates, caustics or acids

Product No.	Size	Description	Ctn. Qty.
35185	17 oz.	Aerosol Can	12



#35253 shown

Cryo-Tek™ Original

- For use in ornamental fountains, snow melting, etc
- Blue liquid
- Specific dilutions for various temperature protection levels

Product No.	Size	Description	Ctn. Qty.
35253	Gallon	Cryo-Tek™ Original	6
35260	5 gal.	Cryo-Tek™ Original	1
35267	55 gal.	Cryo-Tek™ Original	1



#35282 shown

Cryo-Tek™ AG

- Concentrated "arctic grade" anti-freeze solution
- Blue liquid
- 100% pure virgin propylene glycol/triple protection inhibitor package

Product No.	Size	Description	Ctn. Qty.
35282	Gallon	Cryo-Tek™ AG	6
35285	5 gal.	Cryo-Tek™ AG	1
35288	30 gal.	Cryo-Tek™ AG	1
35289	55 gal.	Cryo-Tek™ AG	1



#35281 shown

Cryo-Tek™ - 100

- Contains virgin (not recycled) propylene glycol with triple protection corrosion inhibitor
- Pre-mixed ready to use formulation
- Pink Liquid

Product No.	Size	Description	Ctn. Qty.
35281	Gallon	Cryo-Tek™-100	6
35284	5 gal.	Cryo-Tek™-100	1
35286	30 gal.	Cryo-Tek™-100	1
35287	55 gal.	Cryo-Tek™-100	1





#35283 shown

Cryo-Tek™ - 100/AI for Aluminum

- Special formula for aluminum heat exchange boilers
- Orange Liquid

Product No.	Size	Description	Ctn. Qty.
35283	5 gal.	Orange Container	1
35291	55 gal.	Drum	1



#35276 shown

Cryo-Tek™ Inhibitor

Product No.	Size	Description	Ctn. Qty.
35274	8 oz.	Cryo-Tek A1 Inhibitor	12
35276	8 oz.	Cryo-Tek Inhibitor	24
35277	1 qt.	Cryo-Tek A1 Inhibitor	12
35278	1 qt.	Cryo-Tek Inhibitor	12



#35280 shown

Cryo-Tek™ Solar System™

- For use in closed loop anti-freeze heat exchanger systems.
- Can also be used in radiant tube heating systems and geothermal loops.
- Compatible with PEX and elastomeric radiant tubing.

Product No.	Size	Description	Ctn. Qty.
35280	5 gal.	Cryo-Tek Solar System	1
35292	55 gal.	Cryo-Tek Solar System	1



Cryo-Tek™ Test Kit

Product No.	Size	Description	Ctn. Qty.
35271		Test Kit, 6 - 10 Packs	6



pH Test Meter

Product No.	Size	Description	Ctn. Qty.
35272		pH Test Meter	1



Refractometer

Product No.	Size	Description	Ctn. Qty.
35290		Refractometer	1



#35206 shown

Boiler And Heating System Cleaner

- Liquid cleaner and corrosion preventative treatment
- Helps maximize boiler efficiency

Product No.	Size	Description	Ctn. Qty.
35206	1 qt.	Boiler and Heating System Cleaner	12
35211	Gallon	Boiler and Heating System Cleaner	6
35216	5 gal.	Boiler and Heating System Cleaner	1
35220	1 qt.	Boiler and Heating System Cleaner	12
35255	55 gal.	Boiler and Heating System Cleaner	1





#35302 shown

Power Flow™

- Fuel oil additive
- Packaged for one shot application for typical 275 gal. fuel tank
- Prevents waxing and gelling of oil
- Minimizes breakdowns by cleaning clogged lines, strainers, nozzles, pumps and burners

Product No.	Size	Description	Ctn. Qty.
35302	1 pt.	Power Flow™	1
35302R	1 pt.	Power Flow™ - 6 pack	6



#35310 shown

Sludge Treat

- Helps eliminate burner breakdown from sludge and water in fuel oil and tanks
- Increases fuel tank life
- Prevents tank corrosion, sludge formation and winter freeze-ups

Product No.	Size	Description	Ctn. Qty.
35310	1 qt.	Sludge Treat	12
35315	Gallon	Sludge Treat	6
35320	5 gal.	Sludge Treat	1



Flip-Stick® Soot Destroyer

- Patented formula
- Non-explosive; safe and easy to use - just throw entire stick into firebox
- Removes fuel-consuming deposits of soot and carbon from chimneys, flues and heat exchangers

Product No.	Size	Description	Ctn. Qty.
35427	85 g.	Display	72



#35515 shown

High Heat Furnace Cement

- Unique environmentally clean and friendly formula
- Will not shrink, crack or crumble
- Meets OSHA requirements
- Contains no asbestos or crystalline silica

Product No.	Size	Description	Ctn. Qty.
35503	1/2 pt.	Regular Body	24
35504	1 pt.	Regular Body	12
35509	11 oz.	Regular Body - Cartridge	12
35515	1/2 gal.	Regular Body	6
35521	1/2 gal.	Heavy Body	6
35526	Gallon	Heavy Body	4
35610	Gallon	Regular Body	4





Category 8

Bowl Setting Wax Gaskets and Bolts

For generations of professional plumbers, Oatey® and Hercules® have set the standard for the highest quality and best performing toilet-setting products. Oatey wax rings and Hercules Johni-rings® are cast at the factory, unmolded and immediately packaged in an exclusive fully-enclosed and sealed "stick-free" package for clean handling and easy installation, even on hot, humid days.



Heavy Duty Wax Bowl Ring

- 100% pure petroleum wax gasket for setting any floor type closet bowl.
- Fits 3" or 4" waste lines and meets Military Spec. TT-P-1536A.
- Provides a permanent seal impervious to vermin, odors, gases and acids.

Product No.	Size	Description	Ctn. Qty.
31190		Heavy Duty Wax Bowl Ring	48



#31193 shown

Heavy Duty Wax Bowl Ring W/ Sleeve

- 100% pure petroleum wax gasket for setting any floor type closet bowl.
- Fits 3" or 4" waste lines and meets Military Spec. TT-P-1536A.
- Provides a permanent seal impervious to vermin, odors, gases and acids.
- Polycarbonate sleeve extends discharge opening for a more positive seal assuring proper bowl alignment.

Product No.	Size	Description	Ctn. Qty.
31194		Wax Bowl Ring With Polycarbonate Sleeve	24
31193		Flanged Gasket W/ 1/4" X 2-1/4" Brass Bolts And Nuts	24



Reinforced Wax Bowl Ring W/ Sleeve

- 100% pure petroleum wax gasket for setting any floor type closet bowl.
- Provides a permanent seal impervious to vermin, odors, gases and acids.
- Fits 3" to 4" waste lines and meets Military Spec. TT-P-1536A.
- Polycarbonate sleeve extends discharge opening for a more positive seal assuring proper bowl alignment.
- Sponge provides resiliency. Expands and contracts with the bowl or building to prevent wax from settling.

Product No.	Size	Description	Ctn. Qty.
31195		Fiber Reinforced Wax Bowl Ring with Polycarbonate Sleeve	24



Maxwax® Wax Bowl Ring

- 40% thicker than regular wax ring with a polycarbonate sleeve to assure a tight seal.
- 100% pure petroleum wax gasket for setting any floor type closet bowl.
- Fits 3" to 4" waste lines and meets Military Spec. TT-P-1536A.
- Polycarbonate sleeve extends discharge opening for a more positive seal assuring proper bowl alignment.
- Provides a permanent seal impervious to vermin, odors, gases and acids.

Product No.	Size	Description	Ctn. Qty.
31188		MaxWax Bowl Ring with Sleeve	12



Urinal Wax Ring

- Urinal wax ring has a urethane sponge to provide resiliency.

Product No.	Size	Description	Ctn. Qty.
31187		Urinal Wax Ring	24



Liquilock™

- Solidifies water for easy toilet removal.
- Prevents water spills.
- Gel forms in 4 minutes.
- Non-toxic, Lo-V.O.C.

Product No.	Size	Description	Ctn. Qty.
31417	0.6 oz.	Liquilock - Gel For Toilet Removal	50
31416	0.6 oz.	Liquilock - Gel For Toilet Removal	24
31417D	0.6 oz.	Liquilock - Gel For Toilet Removal - Display Pack	50

#31417 shown





#90104 shown

Johni-Bolts® And Johni-Bolt XL

- Solid brass closet bolts.
- Snap-off slot and captive washer.

Product No.	Size	Description	Ctn. Qty.
90104	1/4" diameter	Johni-Bolts®	100
90124	5/16" diameter	Johni-Bolts®	100
90154	1/4" diameter	Johni-Bolts® Extra-Long	100
90174	5/16" diameter	Johni-Bolts® Extra-Long	100



#90904 shown

Johni Quick Bolts

- Unique new bolting system for mounting toilets.
- Fast and easy; just push down and twist to tighten in one quick motion.
- Eliminates "fall-through" and wobble.

Product No.	Size	Description	Ctn. Qty.
90904	1/4" diameter	Johni Quick Bolts	100
90905	5/16" diameter	Johni Quick Bolts	100
90906	1/4" diameter	Johni Quick Bolts - Extra-Long	50
90907	5/16" diameter	Johni Quick Bolts - Extra-Long	50



#90220 shown

Johni-Rings*

- Soft and flexible high-grade petroleum wax rings.
- Comes in exclusive all-weather, non-stick packaging.
- Anti-bacterial and anti-mold.

* Ring sizes refer to waste lines

Product No.	Size	Description	Ctn. Qty.
90210	3" or 4"	Johni-Rings - Standard Size	48
90211	3" or 4"	Johni-Rings - Standard Size - Contractor Pack	24
90220	3" or 4"	Johni-Rings - Standard Size With Plastic Horn	24
90221	3" or 4"	Johni-Rings - Standard Size/Plastic Horn - Contractor Pack	24
90230	4"	Johni-Rings - Standard Size With Plastic Horn	24
90241	3" or 4"	Johni-Rings - Jumbo Size With Plastic Horn	24
90243	3" or 4"	Johni-Rings - Jumbo Size	24



#90203 shown

Johni-Ring With Bolts - Combo Pack

- Soft and flexible high-grade petroleum wax rings.
- Comes in exclusive all-weather, non-stick packaging.
- Anti-bacterial and anti-mold.
- Includes two 1/4" diameter solid brass bolts.

Product No.	Size	Description	Ctn. Qty.
90203	3" or 4"	Johni-Rings - Jumbo W/Plastic Horn & XI Bolts, Combo Pack	24
90214	3" or 4"	Johni-Rings - Regular Flat Ring, Combo Pack	48
90224	4"	Johni-Rings - With Plastic Horn, Combo Pack	24
90234	3" or 4"	Johni-Rings - With Plastic Horn, Combo Pack	24



#90270 shown

Johni-Ring Specialties

- Soft and flexible high-grade petroleum wax rings.
- Comes in exclusive all-weather, non-stick packaging.
- Anti-bacterial and anti-mold.

Product No.	Size	Description	Ctn. Qty.
90260	2"	Johni-Rings - For Urinal	24
90270	4"	Johni-Rings - For Back Outlet Toilets	24



#96403 shown

Johni-Ring With Johni-Quick Bolts® - Combo Pack

- Soft and flexible high-grade petroleum wax rings.
- Comes in exclusive all-weather, non-stick packaging.
- Anti-bacterial and anti-mold.
- Includes two 1/4" Johni-Quick Bolts.

Product No.	Size	Description	Ctn. Qty.
96401	3" or 4"	Johni-Rings - Regular Flat Ring, Combo Pack	48
96402	3" or 4"	Johni-Rings - With Plastic Horn, Combo Pack	24
96403	4"	Johni-Rings - With Plastic Horn, Combo Pack	24



Oatey®



Category 9

Drains and Closet Flanges

Oatey drains and closet flanges come in the widest variety of sizes, materials and configurations. PVC, cast iron, ABS, no matter what your shower drain or closet flange need, Oatey has the part you need to do the job right.

CLOSET FLANGES



#43503 shown

Level-Fit Closet Flange With Plastic Ring

- 3" or 4" all plastic flange solvent welds inside of 4" or over 3" Schedule 40 DWV pipe.
- 3" inside fit flange fits inside 3" Schedule 40 DWV pipe.
- Four mounting slots.
- Four countersunk holes for secure attachment to the floor.

Product No.	Size	Description	Ctn. Qty.
43502	3" or 4"	ABS closet flange w/plastic ring w/o test cap	12
43503	3" or 4"	PVC closet flange w/plastic ring w/o test cap	7

Inside Fit Closet Flange With Plastic Ring

43506	3"	ABS closet flange w/plastic ring w/ test cap	12
43507	3"	PVC closet flange w/plastic ring w/ test cap	12
43508	3"	ABS closet flange w/plastic ring w/o test cap	12
43509	3"	PVC closet flange w/plastic ring w/o test cap	12



#43495 shown



Level Fit Closet Flange With Stainless Steel Ring

- Corrosion resistant stainless steel ring.
- 3" x 4" flange fits inside of 4" or over 3" Sch. 40 DWV pipe.
- 4" flange fits over 4" Sch. 40 DWV pipe.
- Meets ASTM D2661 and D2665.
- Adjustable ring for alignment of bolts and screws, sits flush on floor.

Product No.	Size	Description	Ctn. Qty.
43494	3" x 4"	ABS closet flange w/SS ring w/o test cap	12
43495	3" x 4"	PVC closet flange w/SS ring w/o test cap	12

Over 4" Fit Flange

43498	4"	ABS closet flange w/SS ring w/o test cap	12
43499	4"	PVC closet flange w/SS ring w/o test cap	12



#43512 shown



Level-Fit Closet Flange With Metal Ring

- The metal ring provides added strength and cracking resistance to the flange and can be rotated to allow precise alignment of bolts and screws.
- 3" or 4" flange solvent welds inside of 4" or over 3" Schedule 40 DWV pipe.
- 4" flange solvent welds over 4" Sch. 40 DWV pipe.

Product No.	Size	Description	Ctn. Qty.
43512	3" or 4"	ABS closet flange w/ metal ring w/o test cap	12
43513	3" or 4"	PVC closet flange w/metal ring w/o test cap	12

Over 4" Fit Flange

43520	4"	ABS closet flange w/ metal ring w/o test cap	12
43521	4"	PVC closet flange w/ metal ring w/o test cap	12



#43612 shown



Easy Tap® Closet Flange

- Fits over 3" or inside of 4" Schedule 40 DWV pipe
- Available with plastic ring, durable metal ring and corrosion-resistant stainless steel ring
- Test cap holds up to 30 ft. of head pressure
- Test cap will not break or fall into DWV line

Product No.	Size	Description	Ctn. Qty.
43556	3" or 4"	Easy Tap Closet Flange, ABS w/plastic ring	12
43552	3" or 4"	Easy Tap Closet Flange, ABS w/SS ring	12
43558	3" or 4"	Easy Tap Closet Flange, ABS w/metal ring	12
43557	3" or 4"	Easy Tap Closet Flange, PVC w/plastic ring	12
43553	3" or 4"	Easy Tap Closet Flange, PVC w/SS ring	12
43559	3" or 4"	Easy Tap Closet Flange, PVC w/metal ring	12
43610	3" or 4"	Easy Tap Closet Flange, ABS w/plastic ring	24
43611	3" or 4"	Easy Tap Closet Flange, ABS w/SS ring	24
43612	3" or 4"	Easy Tap Closet Flange, PVC w/plastic ring	24
43613	3" or 4"	Easy Tap Closet Flange, PVC w/SS ring	24



#43621 shown

Over 4" Level-Fit Closet Flange

- Fits over 4" Schedule 40 DWV pipe
- Available with and without test cap
- With plastic ring

Product No.	Size	Description	Ctn. Qty.
43621	4"	Over 4" Closet Flange, PVC, w/o test cap	12
43549	4"	Over 4" Closet Flange, PVC, w/ test cap	12
43548	4"	Over 4" Closet Flange, ABS, w/o test cap	12
43550	4"	Over 4" Closet Flange, ABS, w/ test cap	12



#43528 shown



Level-Fit Closet Flange With Plastic 2 Slot/2 Slide Ring

- 3" or 4" all plastic flange solvent welds inside of 4" or over 3" Schedule 40 DWV pipe.
- Two mounting slots.

Product No.	Size	Description	Ctn. Qty.
43528	3" or 4"	ABS closet flange w/plastic 2 slot/2 slide ring w/ test cap	12
43529	3" or 4"	PVC closet flange w/plastic 2 slot/2 slide ring w/ test cap	12
43530	3" or 4"	ABS closet flange w/plastic 2 slot/2 slide ring w/o test cap	12
43531	3" or 4"	PVC closet flange w/plastic 2 slot/2 slide ring w/o test cap	12



#43523 shown



Level Fit Long Pattern Closet Flange

- Solvent welds inside of 4" or over 3" Schedule 40 DWV pipe.
- Longer length to allow for pipes cut short.

Product No.	Size	Description	Ctn. Qty.
43522	3" or 4"	ABS long pattern closet flange w/plastic ring w/test cap	6
43523	3" or 4"	PVC long pattern closet flange w/plastic ring w/test cap	6
43524	3" or 4"	ABS long pattern closet flange w/plastic ring w/o test cap	6
43525	3" or 4"	PVC long pattern closet flange w/plastic ring w/o test cap	6
43532	3" or 4"	ABS long pattern closet flange w/metal ring w/test cap	6
43533	3" or 4"	PVC long pattern closet flange w/metal ring w/test cap	6
43534	3" or 4"	ABS long pattern closet flange w/metal ring w/test cap	6
43535	3" or 4"	PVC long pattern closet flange w/metal ring w/o test cap	6



#43511 shown



Level Fit Closet Flange With Plastic Ring, Long Mounting Slots

- All plastic flange solvent welds inside of 4" or over 3" Schedule 40 DWV pipe.
- Four countersunk holes for secure attachment to the floor.
- Radial slots extend 130 degrees to allow exact alignment of the water closet.

Product No.	Size	Description	Ctn. Qty.
43510	3" or 4"	ABS closet flange w/plastic ring, long mounting slots – w/o test cap	12
43511	3" or 4"	PVC closet flange w/plastic ring, long mounting slots – w/o test cap	12
43526	3" or 4"	ABS closet flange w/plastic ring, long mounting slots – w/ test cap	12
43527	3" or 4"	PVC closet flange w/plastic ring, long mounting slots – w/ test cap	12



#43501 shown



Level Fit Offset Closet Flange With Metal Ring

- The metal ring provides added strength and cracking resistance to the flange and can be rotated to allow precise alignment of bolts and screws.
- Solvent welds inside of 4" or over 3" Schedule 40 DWV pipe.
- 2" offset allows a margin of error for drain pipe/flange alignment.

Product No.	Size	Description	Ctn. Qty.
43500	3" or 4"	ABS offset closet flange with metal ring w/o test cap	12
43501	3" or 4"	PVC offset closet flange with metal ring w/o test cap	12
43804	3" or 4"	PVC offset closet flange with metal ring w/o test cap	16



#43815 shown

Level Fit 45° Closet Flange With Plastic Ring

- 45° bend, 360° rotation allows wide range of plumbing connections in tight spaces.
- Design allows flange to set flush.
- Fits over 3" or inside 4" pipe.

Product No.	Size	Description	Ctn. Qty.
43815	3" or 4"	ABS 45° closet flange w/plastic ring w/o test cap	6
43816	3" or 4"	PVC 45° closet flange w/plastic ring w/o test cap	6



#43585 shown

Spigot Fit Closet Flange

- For use in hub-end of fitting.
- Fits on inside of fitting.
- Eight countersunk holes and two closet bolt slots for secure attachment to the floor.

Product No.	Size	Description	Ctn. Qty.
43584	3"	Spigot Fit Closet Flange, ABS, w/ plastic ring	12
43585	3"	Spigot Fit Closet Flange, PVC, w/ plastic ring	12
43586	4"	Spigot Fit Closet Flange, ABS, w/ plastic ring	12
43587	4"	Spigot Fit Closet Flange, PVC, w/ plastic ring	12



#42253 shown

Cast Iron Closet Flange

- Cast iron closet flange, no caulking.
- Complete with body, brass ring, bolts and gasket.
- To be used on plastic or heavy weight, no hub or service weight soil pipe.

Product No.	Size	Description	Ctn. Qty.
42253	3"	Cast iron flange w/o test cap	6
42255	4"	Cast iron flange w/o test cap	6
42256	4"	Cast iron flange w/ test cap	6



Cast Iron Deepset Closet Flange

- Cast iron closet flange, no caulking.
- 4" Deep set.
- Complete with body, brass ring, bolts and gasket.
- To be used on plastic or heavy weight, no hub or service weight soil pipe.

Product No.	Size	Description	Ctn. Qty.
42257	4" x 4"	Cast iron closet flange w/o test cap	8



#43651 shown

Twist-N-Set® Replacement Closet Flange

- Replaces broken cast iron closet flanges.
- Installs easily without tools.
- Smooth unrestricted flow design.
- Gasket expands to fit inside service weight, heavy weight and no hub pipe.

Product No.	Size	Description	Ctn. Qty.
43654	3"	PVC Twist-N-Set closet flange	2
43655	3"	ABS Twist-N-Set closet flange	2
43651	4"	PVC Twist-N-Set closet flange	2
43650	4"	ABS Twist-N-Set closet flange	2
43653	4"	Cast Iron Twist-N-Set closet flange	2



#43539 shown

Replacement Closet Flange

- Slides inside of 4" cast iron or Sch. 40 DWV plastic pipe.
- 3" stainless steel bolts are tightened from the finished floor.
- No caulking required
- Compression joint allows up to 3" of adjustment to the riser.

Product No.	Size	Description	Ctn. Qty.
43538	4"	ABS closet flange replacement	2
43539	4"	PVC closet flange replacement	2



#43519 shown

Closet Flange Spacer

- Builds up an existing closet flange when new flooring is installed.
- Can be stacked to desired height

Product No.	Size	Description	Ctn. Qty.
43519	1/4"	Closet flange spacer	12
43646	1/2"	Closet flange spacer	12



#43540 shown

Horizontal Adjustable Urinal Flange Kit

- Horizontal mounting slots accommodate urinals with 3-1/2" to 7" mount centers.
- Kit includes all bolts, nuts, washers and gaskets
- The flange fits over 2" Sch. 40 DWV pipe (Prod No. 43540 and 43541).

Product No.	Size	Description	Ctn. Qty.
43540	2"	ABS horizontal adjustable urinal flange kit	10
43541	2"	PVC horizontal adjustable urinal flange kit	10
43542	2"	ABS horizontal spigot urinal flange kit	10
43543	2"	PVC horizontal spigot urinal flange kit	10



Wax Free Gasket

- For repairs and new installations
- 3" diameter hole
- No wax needed

Product No.	Size	Description	Ctn. Qty.
42759		Wax Free Gasket	12



Stainless Steel Closet Flange Replacement Ring

- For use on 3" or 4" closet flanges
- Six countersunk holes and two closet bolt slots for secure attachment to the floor

Product No.	Size	Description	Ctn. Qty.
42778	3" or 4"	Stainless Steel Closet Flange	12



Brass Closet Flange Replacement Ring

- For use 4" closet flanges
- Three countersunk holes and three closet bolt slots for secure attachment to the floor

Product No.	Size	Description	Ctn. Qty.
43551	3" or 4"	Brass Closet Flange Replacement Ring	12



Moss Bay Replacement Flange

- For rusted or corroded metal closet flange rings
- For use on PVC or ABS closet flanges
- Includes closet bolts

Product No.	Size	Description	Ctn. Qty.
42777		Moss Bay Replacement Flange	12



Closet Flange Spacer Kit

- For use when overlaying, replacing or tiling bathroom floors
- Kit includes gaskets, 1/2" spacer, closet bolts and shims

Product No.	Size	Description	Ctn. Qty.
43645		Closet Flange Spacer Kit	12



Galvanized Wood Support Kit

- For repairing wobbly toilets or loose closet flanges without replacing the floor
- Includes two heavy gauge pre-slotted flange plates, six floor attaching screws and 4 large flathead flange assembly screws
- Use for holes cut too large, rotting floors or screws that pulled loose
- Easy-to-use floor and flange support

Product No.	Size	Description	Ctn. Qty.
43555		Galvanized Wood Support Kit	12

SHOWER DRAINS FOR PREFORMED BASES



#42150 shown

No-Calk Shower Base Drain

- For repairing wobbly toilets or loose closet flanges without replacing the floor
- Includes two heavy gauge pre-slotted flange plates, six floor attaching screws and 4 large flathead flange assembly screws
- Use for holes cut too large, rotting floors or screws that pulled loose
- Easy-to-use floor and flange support

Product No.	Size	Description	Ctn. Qty.
-------------	------	-------------	-----------

140 Series Brass No-Calk Shower Drain

42150	2"	140 NC Brass NO-CALK shower drain w/ stainless steel strainer	12
-------	----	---	----

101 PNC Series Plastic No-Calk Shower Drain

42084	2"	101 PNC ABS NO-CALK shower drain w/ stainless steel strainer	12
42099	2"	101 PNC PVC NO-CALK shower drain w/ stainless steel strainer	12
42077	2"	101 PNC ABS NO-CALK shower drain w/ plastic strainer	12
42075	2"	101 PNC PVC NO-CALK shower drain w/ plastic strainer	12
42080	2"	101 PNC PVC NO-CALK shower drain w/ Ultrashine® polished brass strainer	12

No-Calk Shower Drain Accessories

42163		Rubber caulking gasket to fit 1-1/2" Sch. 40 DWV drain pipe in the NO-CALK shower drains	12
42156		Rubber caulking gasket to fit 2" Sch. 40 DWV drain pipe in the NO-CALK shower drains	12
42157		Rubber caulking gasket to fit 2" No-hub cast iron pipe in the NO-CALK shower drains	12
42158		Rubber caulking gasket to fit 2" copper DWV drain pipe in the NO-CALK shower drains	12
42159		Rubber caulking gasket to fit 1-1/2" copper DWV drain pipe in the NO-CALK shower drains	12
42239		NO-CALK shower drain wrench – carded	4



#42156 shown

SOLVENT WELD SHOWER DRAINS



#42078 shown

101 PS Series Solvent Weld Shower Drain

- Solvent weld over 2" Sch. 40 DWV pipe.
- Universal 4-1/4" Snap-Tite Strainer.
- Drain body is sealed to shower base with rubber gasket and fiber slip washer.

Product No.	Size	Description	Ctn. Qty.
-------------	------	-------------	-----------





42093	2"	101 PS ABS Solvent Weld Shower Drain w/ stainless steel strainer	6
42097	2"	101 PS PVC Solvent Weld Shower Drain w/ stainless steel strainer	6
42086	2"	101 PS ABS Solvent Weld Shower Drain w/ plastic strainer	5
42089	2"	101 PS PVC Solvent Weld Shower Drain w/ plastic strainer	8
42078	2"	101 PS PVC Solvent Weld Shower Drain w/ Ultrashine® polished brass strainer	6



#42045 shown

102 Series Solvent Weld Shower Drain With Receptor Base

- Solvent weld over 2" Sch. 40 DWV pipe.
- Universal 4-1/4" Snap-Tite Strainer.
- Drain body is sealed to shower base with rubber gasket and fiber slip washer.

Product No.	Size	Description	Ctn. Qty.
42044	2"	2-part ABS Solvent Weld Shower Drain w/ stainless steel strainer	7 
42045	2"	2-part PVC Solvent Weld Shower Drain w/ stainless steel strainer	9 
42047	2"	2-part PVC Solvent Weld Shower Drain w/ Ultrashine® polished brass strainer	9 
42048	2"	2-part ABS Solvent Weld Shower Drain w/ plastic strainer	7 
42049	2"	2-part PVC Solvent Weld Shower Drain w/ plastic strainer	9 



103 Series Offset Solvent Weld Shower Drain With Receptor Base

- Solvent weld over 2" Sch. 40 DWV pipe
- Universal 4-1/4" Snap-Tite Strainer.
- Drain body provides 1-1/2" offset to work around joists and imperfect slab penetrations.
- Drain body is sealed to shower base with rubber gasket and fiber slip washer.

Product No.	Size	Description	Ctn. Qty.
42787	2"	Offset PVC Shower Drain w/ Stainless Steel Strainer	8
42788	2"	Offset ABS Shower Drain w/ Stainless Steel Strainer	8

CAULKING AND THREADING SHOWER DRAINS



101 Series Brass NPT And Caulking Drain

- Drain body is sealed to shower base with rubber gasket and fiber slip washer.
- Three DWV connection methods for metallic pipe.
- Universal 4-1/4" Snap-Tite Strainer.

Product No.	Size	Description	Ctn. Qty.
42070	1-1/2"	101 NPT IPS Brass Drain w/ stainless	6





SHOWER DRAINS FOR BUILT-UP SHOWERS



#42210 shown

130 Series Shower Drain For Tile Shower Bases



- Designed for use on built-up shower bases of tile or marble, where a shower pan liner is used
- Low profile design for use in tight spaces
- Solvent welds over 2" or inside 3" Schedule 40 DWV pipe
- Reversible clamping collar is secured with stainless steel bolts into brass inserts to prevent stripping
- Square Snap-In Strainers available in Stainless Steel and Brushed Nickel finishes

Product No.	Size	Description	Ctn. Qty.
42210	2" or 3"	ABS drain w/ round stainless steel Screw-Tite strainer	14 
42213	2" or 3"	PVC drain w/ round stainless steel Screw-Tite strainer	17 
42399	2" or 3"	ABS drain w/ round Ultrashine® PVD Screw-Tite polished brass strainer	14 
42404	2" or 3"	PVC drain w/ round Ultrashine® PVD Screw-Tite polished brass strainer	17 







Chrome plated, brass strainer barrel provides finished metal appearance

42218	2" or 3"	ABS drain w/ round stainless steel Screw-Tite strainer w/chrome plated brass barrel	19
42219	2" or 3"	PVC drain w/ round stainless steel Screw-Tite strainer w/chrome plated brass barrel	23
42393	2" or 3"	ABS drain w/ square stainless steel Screw-Tite strainer w/chrome plated brass barrel	26
42394	2" or 3"	PVC drain w/ square stainless steel Screw-Tite strainer w/chrome plated brass barrel	26

Snap-on Grate

42202	2" or 3"	PVC drain w/ round stainless steel Snap-Tite strainer	17 
42203	2" or 3"	ABS drain w/ round stainless steel Snap-Tite strainer	17 
42245	2" or 3"	PVC drain w/ round stainless steel Snap-Tite Strainer, BARREL and STRAINER ONLY	12 
42246	2" or 3"	PVC drain w/ round stainless steel Snap-Tite Strainer, BASE DRAIN, COLLAR and FASTENERS ONLY	12
42247	2" or 3"	PVC drain w/ square stainless steel Snap-Tite Strainer, BARREL and STRAINER ONLY	12

130 Series Shower Drain For Tile Shower Bases (cont.)





Product No.	Size	Description	Ctn. Qty.
42237	2" or 3"	PVC drain w/ square stainless steel Snap-Tite strainer	24 
42238	2" or 3"	ABS drain w/ square stainless steel Snap-Tite strainer	24 
42251	2" or 3"	PVC drain w/square brushed nickel Snap-Tite strainer	24 
42250	2" or 3"	ABS drain w/square brushed nickel Snap-Tite strainer	24 
42396	2" or 3"	ABS drain w/square rubbed bronze Snap-Tite strainer	24 
42398	2" or 3"	PVC drain w/square rubbed bronze Snap-Tite strainer	24 



#42235 shown

131 Series Two Part Adjustable Slab Drain

- Ideal for installations on a slab where a pan liner membrane is not required.
- Available with high quality stainless steel strainer, Brass or Nickel finish cast grates for heavy traffic applications.
- Drain base engineered as hub for 2" Sch. 40 pipe or solvent welds inside 3" Sch. 40 pipe.
- Available with both round and square strainer top.

Product No.	Size	Description	Ctn. Qty.
42235	2" or 3"	PVC drain w/round stainless steel Screw-Tite strainer	22 
42236	2" or 3"	ABS drain w/round stainless steel Screw-Tite strainer	22 
42380	2" or 3"	PVC drain w/round brass cast grate w/round ring	10
42381	2" or 3"	ABS drain w/round brass cast grate w/round ring	10
42382	2" or 3"	PVC drain w/round brass cast grate w/square ring	10
42383	2" or 3"	ABS drain w/round brass cast grate w/square ring	10
42384	2" or 3"	PVC round nickel cast grate w/round ring	10
42385	2" or 3"	ABS round nickel cast grate w/round ring	10
42386	2" or 3"	PVC round nickel cast grate w/square ring	10
42387	2" or 3"	ABS round nickel cast grate w/square ring	10
42388	2" or 3"	PVC drain w/square stainless steel Snap-Tite strainer	40 
42389	2" or 3"	ABS drain w/square stainless steel Snap-Tite strainer	40 



#42201 shown

151 Series Cast Iron And Plastic Two Part Shower Drain

- Designed for use with tile and marble showers.
- Cast Iron or plastic variations with threaded, No-Calk or solvent weld connections.
- 3-1/4" Crown Ring Set.

Product No.	Size	Description	Ctn. Qty.
42197	2"	151 cast iron w/ 2" NPT connection	27
42192	1-1/2"	151 cast iron w/ 1-1/2" NPT connection	27
42201	2"	151 cast iron w/ 2" Sch. 40 No-calk connection	29
42206	2"	151 cast iron w/ 2" No Hub connection	30
42211	2"	151 ABS drain w/ 2" solvent weld connection	6 
42215	2"	151 cast iron drain top & ABS bottom w/ 2" solvent weld connection	6

151 Series Accessories

42011	3-1/4"	Crown Ring Set – stainless steel – carded	3
42012	6"x 6"	Square Tile Ring – stainless steel – carded	5
42010	3-1/4"	Crown Ring Set- Ultrashine® PVD polished brass – Carded	3
42042	4-1/4" x 4-1/4"	Square Tile Ring – stainless steel – carded	1
42041	4-1/4" x 4-1/4"	Square Tile Ring – Ultrashine® PVD polished brass – carded	1

REPLACEMENT STRAINERS



White Plastic Replacement Strainer

- 6-3/4" strainer
- With screws included

Product No.	Size	Description	Ctn. Qty.
42021	6-3/4"	Replacement Strainer, White Plastic	12



#42138 shown

4-1/4" Round Snap-Tite Strainer

- For 101BR, 101PNC, 101NPT, 101PS, 102, 103, 130 and 131 Series Shower Drains with round strainers.
- UltraShine® PVD lifetime finish where noted.
- For series 101BR, 101PNC, 101NPT, 101PS, 102, 103, 130 & 131, 140 NC Series Shower Drains.

Product No.	Size	Description	Ctn. Qty.
42136	4-1/4"	White Plastic	2
42138	4-1/4"	Stainless Steel	4
42137	4-1/4"	UltraShine® PVD Polished Brass	3
42003	4-1/4"	Carded White Plastic – carded	2
42005	4-1/4"	Stainless Steel – carded	2
42004	4-1/4"	UltraShine® PVD Polished Brass – carded	3
42014	4-1/4"	UltraShine® PVD Satin Nickel – carded	3
42015	4-1/4"	UltraShine® PVD Satin Chrome – carded	3
42016	4-1/4"	Biscuit – carded	3
42017	4-1/4"	Rubbed Bronze – carded	3
42018	4-1/4"	Brushed Nickel – carded	3
42019	4-1/4"	White Metal – carded	3
42020	4-1/4"	Antique Bronze – carded	3



#46266 shown

4-1/4" Square Snap-Tite Strainer

- For 130 Series Shower Drains with square strainers.

Product No.	Size	Description	Ctn. Qty.
46266	4-1/4"	Stainless Steel – carded	3
46267	4-1/4"	Rubbed Bronze – carded	3
46268	4-1/4"	Brushed Nickel – carded	3



#42358 shown

4" Screw-Tite Strainer

- For screw-on tile shower drains and 2" x 3" slab shower drains.
- Polished brass strainers have PVD lifetime finish.
- For 130 and 131 Series Shower Drains and 43566, 43567, 43578, 43579, 43580, 43581.

Product No.	Size	Description	Ctn. Qty.
42358	4"	Stainless Steel	2
42359	4"	UltraShine® PVD Polished Brass	2
43861	4"	Stainless Steel – carded	3
43862	4"	UltraShine® PVD Polished Brass – carded	3

3-1/4" Strainer

- For brass drains.
- Polished brass strainers have Ultrashine® PVD lifetime finish.

Product No.	Size	Description	Ctn. Qty.
42116	3-1/4"	Stainless Steel	12
44016	3-1/4"	Antique Brass	12
42001	3-1/4"	Carded Stainless Steel	12

Stainless Steel Snap-In Strainer

- Fits inside Schedule 40 DWV pipe.

Product No.	Size	Description	Ctn. Qty.
42730	2"	Snap-In Stainless Steel Strainer	12
42731	3"	Snap-In Stainless Steel Strainer	12
42732	4"	Snap-In Stainless Steel Strainer	12



#42731 shown

GENERAL PURPOSE DRAINS



#43581 shown



Short General Purpose Drain

- 1-3/16" high for tight spaces.

Product No.	Size	Description	Ctn. Qty.
43580	2" or 3"	ABS short general purpose drain w/ 4" stainless steel Screw-Tite strainer	18
43581	2" or 3"	PVC short general purpose drain w/ 4" stainless steel Screw-Tite strainer	5



#43579 shown



General Purpose Drain

Product No.	Size	Description	Ctn. Qty.
43578	2" or 3"	ABS general purpose drain w/ 4" stainless steel Screw-Tite strainer	12
43579	2" or 3"	PVC general purpose drain w/ 4" stainless steel Screw-Tite strainer	12
43582	3" or 4"	ABS general purpose drain w/ 5" stainless steel Screw-Tite strainer	12
43583	3" or 4"	PVC general purpose drain w/ 5" stainless steel Screw-Tite strainer	12
43600	3" or 4"	ABS general purpose drain w/ 5" nickel alloy grate	12
43601	3" or 4"	PVC general purpose drain w/ 5" nickel alloy grate	12
43598	3" or 4"	ABS general purpose drain w/ 5" brass grate and metal ring	12
43599	3" or 4"	PVC general purpose drain w/ 5" brass grate and metal ring	12



#43569 shown

All Plastic Snap-In Drain

- Also suitable for use as a vent stack or air inlet strainer.

Product No.	Size	Description	Ctn. Qty.
43560	2"	ABS Snap-In Drain	1
43561	2"	PVC Snap-In Drain	6
43564	3"	ABS Snap-In Drain	2
43565	3"	PVC Snap-In Drain	2
43568	4"	ABS Snap-In Drain	6
43569	4"	PVC Snap-In Drain	12



#43563 shown

Plastic Snap-In Drain With Removable Stainless Steel Strainer

- Strainer can be removed to allow access to the pipe.

Product No.	Size	Description	Ctn. Qty.
43562	3"	ABS Snap-In Drain w/ 3-1/2" Stainless Steel Strainer	3
43563	3"	PVC Snap-In Drain w/ 3-1/2" Stainless Steel Strainer	3
43566	4"	ABS Snap-In Drain w/ 4" Stainless Steel Strainer	8
43567	4"	PVC Snap-In Drain w/ 4" Stainless Steel Strainer	9



#43571 shown

All Plastic Snap-In Outlet Cover

- For covering an open pipe.
- Protects piping from dirt and debris.

Product No.	Size	Description	Ctn. Qty.
43570	2"	ABS Snap-In Drain Outlet Cover	6
43571	2"	PVC Snap-In Drain Outlet Cover	6
43572	3"	ABS Snap-In Drain Outlet Cover	2
43573	3"	PVC Snap-In Drain Outlet Cover	2

REPLACEMENT STRAINERS



#43637 shown

Bell Trap Drain

- Fits over 1-1/2" Sch. 40 DWV pipe or into 2" coupling.
- Fits over 3" or inside of 4" Sch. 40 DWV pipe.

Product No.	Size	Description	Ctn. Qty.
43636	1-1/2"	ABS 6" x 6" bell trap drain	5
43637	1-1/2"	PVC 6" x 6" bell trap drain	5
43632	3" or 4"	ABS 9" x 9" bell trap drain	7
43633	3" or 4"	PVC 9" x 9" bell trap drain	7



#43641 shown

Utility Drain

- Fits over 1-1/2" Sch. 40 DWV pipe or into 2" coupling.

Product No.	Size	Description	Ctn. Qty.
43640	1-1/2"	ABS 6" x 6" utility drain	14
43641	1-1/2"	PVC 6" x 6" utility drain	15



Four-Way Area Drain

- Fits over 2" or 3" Schedule 40 DWV pipe
- General purpose drain for use in garages and utility rooms
- Sump for large capacity

Product No.	Size	Description	Ctn. Qty.
43596	2" or 3"	Four-Way Area Drain, PVC	10



#42724 shown

Integral Trap Drain

- One piece trap drain/cleanout design molded from PVC or ABS plastic.
- 3-3/4" deep sump bowl.
- Solvent weld over 2" Sch. 40 DWV pipe.
- Built in 2" FIP threadway for backwater device.
- ASTM 2665 and ASTM D2661.
- Internal 1-1/2" – 14 NPT – cleanout.

Product No.	Size	Description	Ctn. Qty.
42724	2"	PVC Floor drain with p-trap and cleanout	6
42723	2"	ABS Floor drain with p-trap and cleanout	6
42725	2"	Backwater valve device	1

CLEANOUT ASSEMBLIES



#43711 shown

All Plastic 2" x 3" Snap-In Cleanout Assemblies

Product No.	Size	Description	Ctn. Qty.
43710	2" or 3"	ABS Snap-In Cleanout Assembly	12
43711	2" or 3"	PVC Snap-In Cleanout Assembly	12



Inside 2" Snap-In Cleanout Assemblies

Product No.	Size	Description	Ctn. Qty.
43819		Inside 2", PVC	12
43820		Inside 2", ABS	12
43821		Replacement Plug for Inside 2" Cleanout, PVC	6
43822		Replacement Plug for Inside 2" Cleanout, ABS	6



#42786 shown

All Plastic 3" x 4" Snap-In Cleanout Assemblies

Product No.	Size	Description	Ctn. Qty.
42785	3" or 4"	ABS Snap-In Cleanout Assembly	12
42786	3" or 4"	PVC Snap-In Cleanout Assembly	12



#43733 shown

All Plastic Snap-In Cleanout Assemblies

• Fits inside of Sch. 40 DWV pipe fitting.

Product No.	Size	Description	Ctn. Qty.
43730	3"	ABS Snap-In Cleanout Assembly	12
43731	3"	PVC Snap-In Cleanout Assembly	12
43732	4"	ABS Snap-In Cleanout Assembly	12
43733	4"	PVC Snap-In Cleanout Assembly	12
43764	2-1/3"	ABS Replacement Plug for the 3" and the 2" or 3" cleanout assemblies	6
43765	2-1/3"	PVC Replacement Plug for the 3" and the 2" or 3" cleanout assemblies	6
43766	3-1/2"	ABS Replacement Plug for the 4" regular and the 3" Hub cleanout assemblies	6
43767	3-1/2"	PVC Replacement Plug for the 4" regular and the 3" Hub cleanout assemblies	6



#42365 shown

180 B Brass Cleanout Frame and Cover

• Brass covers for 2", 3", 4" and 6" pipes.

Product No.	Size	Description	Ctn. Qty.
42365	2"	180 B Cleanout	12
42366	3"	180 B Cleanout	12
42367	4"	180 B Cleanout	12
42368	6"	180 B Cleanout	12



#42370 shown

185 Brass Cleanout Plug With Raised Head

• Brass cleanout plugs with raised square head for use with slip joint pliers.

Product No.	Size	Description	Ctn. Qty.
42369	1-1/2"	185 Brass cleanout plug	12
42370	2"	185 Brass cleanout plug	12
42371	2-1/2"	185 Brass cleanout plug	12
42372	3"	185 Brass cleanout plug	12
42373	3-1/2"	185 Brass cleanout plug	12
42374	4"	185 Brass cleanout plug	12



#42745 shown

Brass Cleanout Plug With Recessed Head

• All sizes are countersunk and tapped.

Product No.	Size	Description	Ctn. Qty.
42740	1-1/2"	Brass cleanout plug	12
42741	2"	Brass cleanout plug	12
42742	2-1/2"	Brass cleanout plug	12
42743	3"	Brass cleanout plug	12
42744	3-1/2"	Brass cleanout plug	12
42745	4"	Brass cleanout plug	12



Cover Plate

- Cover plates conceal the clean-out plug access hole.

Product No.	Size	Description	Ctn. Qty.
34405	4"	Flat Chrome Cover Plate	25
34406	5"	Flat Chrome Cover Plate	25
34410	4"	Flat White Cover Plate	25
34411	5"	Flat White Cover Plate	25
34415	4"	Bell Chrome Cover Plate	25
34416	5"	Bell Chrome Cover Plate	25
34420	4"	Bell White Cover Plate	25
34421	5"	Bell White Cover Plate	25

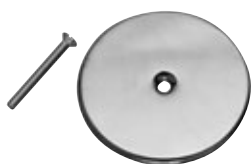

#42781 shown

Stainless Steel Cover Plate

- Stainless steel cover plates conceal the clean-out plug access hole.
- Protective film cover.
- 1/4" – 20 screw included.

Product No.	Size	Description	Ctn. Qty.
42780	3"	Stainless steel cover plate	12
42781	4"	Stainless steel cover plate	12
42782	5"	Stainless steel cover plate	12
42783	6"	Stainless steel cover plate	12
42784	8"	Stainless steel cover plate	12

BACKWATER VALVES



#43900 shown

Backwater Valves

- Protects low areas or basements from backflow or waste from street sewers.
- Elastomeric seal in quick action flapper ensures a water tight seal.
- Threaded access cap incorporates a neoprene seal for positive sealing and can be tightened or removed by hand.
- Valve hub fits DWV pipe and can be adapted for sewer and drain pipe.

Product No.	Size	Description	Ctn. Qty.
43900	3"	PVC backwater valve	4
43901	3"	ABS backwater valve	4
43904	4"	PVC backwater valve	2
43905	4"	ABS backwater valve	2
43908	6"	PVC backwater valve	1
43909	6"	ABS backwater valve	1

Backwater Accessories

Product No.	Size	Description	Ctn. Qty.
43915	3"	PVC threaded cap	1
43916	3"	ABS threaded cap	1
43918	4"	PVC threaded cap	1
43919	4"	ABS threaded cap	1
43921	6"	PVC threaded cap	1
43922	6"	ABS threaded cap	1
43924	3"	PVC flapper w/ "O" ring	1
43925	3"	ABS flapper w/ "O" ring	1
43927	4"	PVC flapper w/ "O" ring	1
43928	4"	ABS flapper w/ "O" ring	1
43929	6"	PVC flapper w/ "O" ring	1
43930	6"	ABS flapper w/ "O" ring	1

SADDLE TEE KITS

Saddle Tee Kits

- For tapping into a 3" or 4" Sch. 40 DWV line.
- Saddle is solvent welded to the existing line and secured with metal V-bolts, washers and nuts provided in the kit.
- The tee accepts the incoming line inside the socket or joins with a Sch. 40 DWV fitting.



#43791 shown

Product No.	Size	Description	Ctn. Qty.
43788	3" x 2"	Abs Saddle Tee Kit	6
43789	3" x 2"	Pvc Saddle Tee Kit	6
43790	4" x 2"	Abs Saddle Tee Kit	6
43791	4" x 2"	Pvc Saddle Tee Kit	6
43792	4" x 3"	Abs Saddle Tee Kit	6
43793	4" x 3"	Pvc Saddle Tee Kit	6
43794	4" x 4"	Abs Saddle Tee Kit	6
43795	4" x 4"	Pvc Saddle Tee Kit	6
43796		Gasket For Tapping Into Cast Iron Soil Pipe	12

ACCESSORIES

Traps

- One-piece design.
- Made from 3/4" PVC Schedule 40 DWV pipe.



#42757 shown

Product No.	Size	Description	Ctn. Qty.
42757	3/4"	PVC Condensate "P"-trap	24
42758	3/4"	Pvc Condensate Running Trap	24

Mushroom Vent Cap

- Fits either 3" or 4" vent stacks.
- Shipped fully assembled.
- Includes 3 hex-head bolts.
- Made of high-impact PVC.



Product No.	Size	Description	Ctn. Qty.
43805	3" or 4"	Mushroom Vent Cap	12

RAINWATER COLLECTION

Mystic™ Rainwater Collection System

- Directs rainwater from downspouts into collection barrels for re-use in lawn/garden watering.
- Fits standard 2" x 3" residential downspouts.
- 2-piece design is made of UV-resistant material and can be painted.
- Comes with 4' high-flow hose.



Product No.	Size	Description	Ctn. Qty.
14209	2" x 3"	Mystic Rainwater Collection System – Display Box	4

Oatey®



Category 10

Shower Pan Liners

Oatey® Shower Pan Liners and accessories are designed as an economical, flexible pan liner for use in tile shower and other concealed water-proofing applications. Shower Pan Liners are available in 30 mil or 40 mil thickness, and widths of 4', 5' or 6'. Liner is marked every 6" to allow for easy measuring of material.



#41625 shown



PVC Shower Pan Liner

- Economical, time-tested flexible pan liner.
- Available in 30 & 40 mil thicknesses.
- Liner marked in 6" increments for ease of measuring
- Dam corners available.
- Meets ASTM Standard D4551.
- Superior cold weather characteristics.

Product No.	Size	Description	Ctn. Qty.
41596	4' x 50 ft.	40 mil Gray – Roll	1
41625	4' x 50 ft.	40 mil Gray – Linear Foot	50
41593	4' x 50 ft.	40 mil Gray – Linear Foot, UPC barcode	50
41597	5' x 40 ft.	40 mil Gray – Roll	1
41626	5' x 40 ft.	40 mil Gray – Linear Foot	40
41594	5' x 40 ft.	40 mil Gray – Linear Foot, UPC barcode	40
41601	6' x 50 ft.	40 mil Gray – Roll	1
41619	6' x 50 ft.	40 mil Gray – Linear Foot	50
41604	5' x 100 ft.	40 mil Gray – Roll	1
41606	5' x 100 ft.	40 mil Blue – Roll	1
41627	5' x 100 ft.	40 mil Gray – Linear Foot	100
41611	6' x 100 ft.	40 mil Gray – Roll	1
41628	6' x 100 ft.	40 mil Gray – Linear Foot	100
41620	5' x 6 ft.	40 mil Gray – Liner Kit	4
41630	5' x 6 ft.	40 mil Gray – Liner Kit w/o dam corners	4
41598	4' x 50 ft.	30 mil Blue – Roll	1
41616	4' x 50 ft.	30 mil Blue – Linear Foot	50
41599	5' x 40 ft.	30 mil Blue – Roll	1
41617	5' x 40 ft.	30 mil Blue – Linear Foot	40
41600	6' x 50 ft.	30 mil Blue – Roll	1
41618	6' x 50 ft.	30 mil Blue – Linear Foot	50
41612	6' x 100 ft.	30 mil Blue – Roll	1
41629	6' x 100 ft.	30 mil Blue – Linear Foot	100



LO-VOC X-15™ PVC Solvent

- X-15 PVC solvent is specially formulated for extended working times.
- Meets California and other environmental district rules.
- X-15 PVC solvent provides exceptional sheet to sheet bonding.

Product No.	Size	Description	Ctn. Qty.
30812	16 oz.	LO-VOC X-15 PVC Solvent w/ dauber	6



#41588 shown

CPE Shower Pan Liner

- Original flexible pan liner.
- Available in 40 mil thickness.
- Liner marked in 6" increments for ease of measuring.
- Meets ASTM Standard D4068.

Product No.	Size	Description	Ctn. Qty.
41588	4' x 50'	40 mil Black – Roll	1
41614	4' x 50'	40 mil Black – Linear Foot	50
41590	5' x 40'	40 mil Black – Roll	1
41615	5' x 40'	40 mil Black – Linear Foot	40
41613	6' x 33'	40 mil Black-Linear Foot	33
41584	6' x 33'	40 mil Black – Roll	1



Oateyweld™

- CPE solvent is specially formulated for extended working times.
- CPE solvent provides exceptional sheet to sheet bonding.

Product No.	Size	Description	Ctn. Qty.
30810	16 oz.	CPE Solvent w/ dauber	12



Dam Corner

- Dam corners have universal design for right or left corners.
- Dam corners for use at junction of curb and door jamb.

Product No.	Size	Description	Ctn. Qty.
41602		Dam Corner – 40 mil PVC	48

SHOWER PAN LINER – APPLICATION INSTRUCTIONS

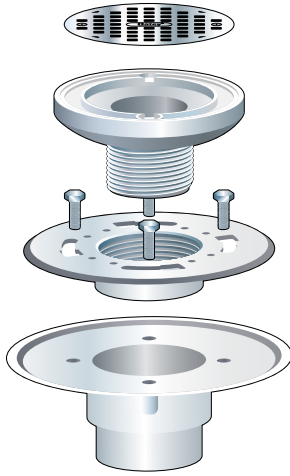

Oatey® provides several products needed for tile shower installations. Choose from the list below before you start your project:

PVC or CPE Pan Liner – referred to as pan liner or membrane in our instructions.

Tile Shower Drain – PVC for PVC drain pipe or ABS for ABS drain pipe. Each is available with stainless steel, polished brass or white plastic strainer.

X-15 or CPE (Oateyweld) bonding adhesive – For use on dam corners or seaming use X-15 for PVC and Oateyweld for CPE.

PVC or ABS solvent cement – PVC solvent cement and primer for PVC drainage systems or ABS solvent cement for ABS drainage systems. Use the appropriate cement (and primer for PVC) to solvent weld tile shower drain to the drain pipe.

Dam Corners – For outside corners and over the curb preformed dam corners are available, which can be used for PVC or CPE pan liner applications.

NOTE: Oatey pan liner instructions assume the shower framing has been constructed and the flooring is plywood. Generally the same principles apply to concrete flooring where the sloped mortar bed is applied beneath the pan liner. Also the instructions apply to either PVC pan liner or CPE pan liner which are installed the same with the exception of the bonding adhesive used for seaming and dam corner applications. If you have questions regarding pan liner installation that are not covered in these instructions, contact Oatey customer service at 800-321-9532 and you will be referred to someone who can assist you.

Shower Pan Installation

1. For typical wood subfloor cut a 4.5" diameter hole in the center of the shower floor where the tile shower drain would normally be positioned. Disassemble the tile shower drain. Lay the tile shower drain base in the opening so the flange of the drain base rests on top of the subfloor. Solvent weld the drain base to the drain pipe using the appropriate solvent cement. See Figure A.
2. Cover the drain base opening with duct tape to keep debris from entering the drain. Begin by applying Portland Sand/Cement mixture mortar bed over the subfloor at 1/4" per foot slope from the wall framing to the top of, but not over, the drain base. After this step the sloped mortar bed should be flush with the top surface of the drain base.

Figure A

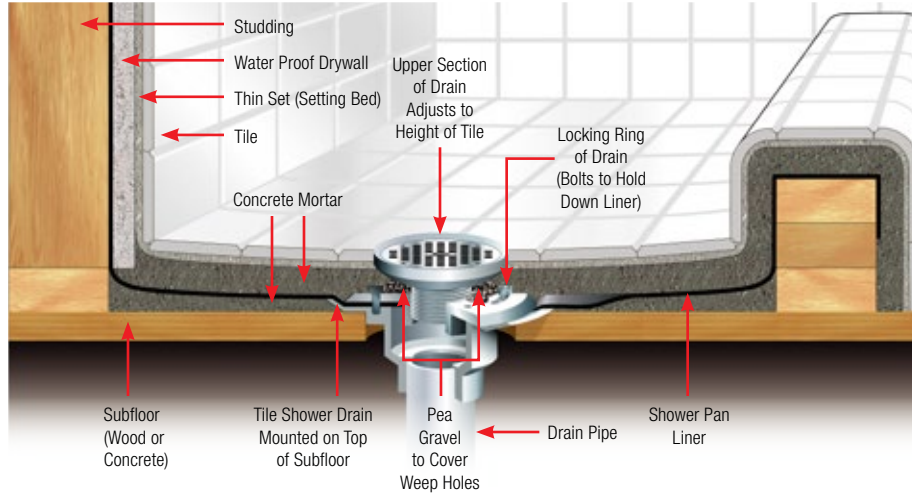

3. After the sloped mortar bed has cured, the pan liner dimensions need to be determined. Pan liner dimensions should be sufficient to completely cover the floor, turn up all sidewalls at least 2" above the finished curb height, and adequately cover the curb. Lay the pan liner on a clean floor surface, measure, and cut to the appropriate dimensions. **NOTE: Seaming may be required in larger showers. See Figure B. Follow instructions on bonding adhesive.**

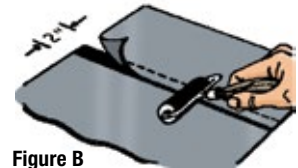
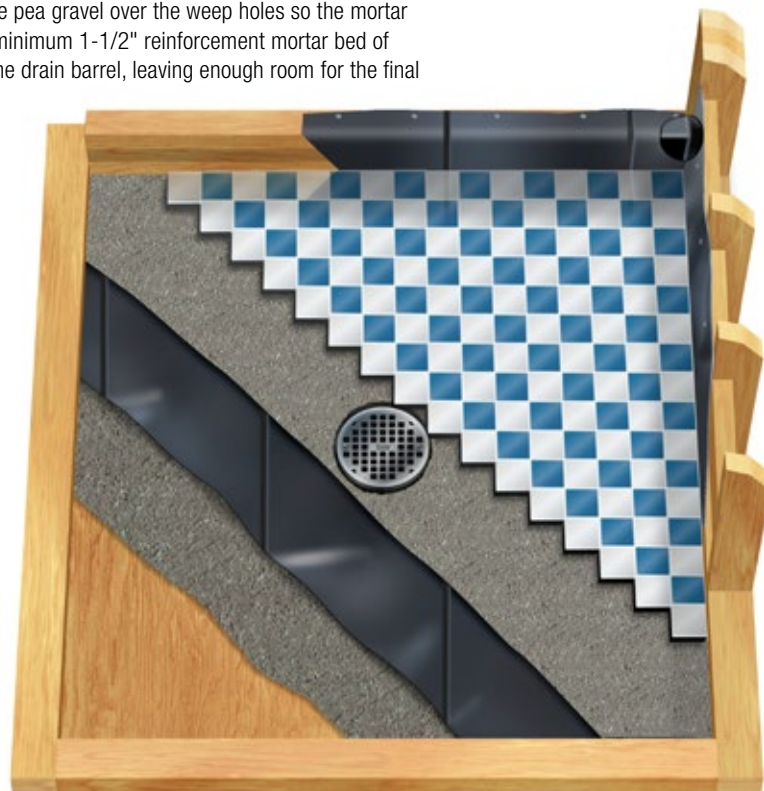
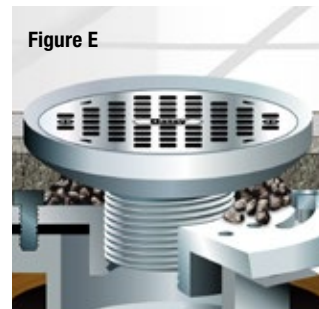
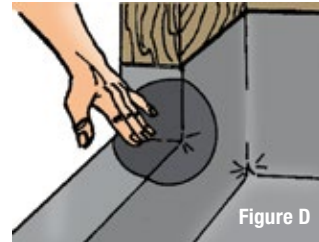
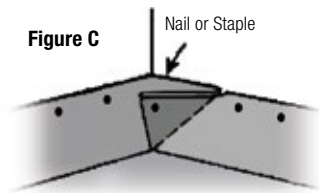

Figure B

4. Before installing the pan liner remove the tape from the drain base and apply a 1/4"-3/8" bead of 100% silicone caulk around the upper surface of the drain base approximately 1" in from the outside edge. This will provide a seal between the underside of the pan liner and the drain base surface. Screw the clamping ring bolts into the drain base to 2-3 thread depth. Before the caulk dries lay the premeasured pan liner on the floor and over the drain body. At the top of each bolt slit an "X" so the pan liner slides over the bolts and down to the drain base surface. Press pan liner firmly into place to ensure a seal between the drain base and the bottom surface of the pan liner.

SHOWER PAN LINER – APPLICATION INSTRUCTIONS

5. Work the pan material from the drain body to the sidewall framing and curb threshold so it lays flat on the floor surface. If desired an adhesive can be used to bond pan liner to the floor and curb. Prior to use of adhesive, confirm compatibility of adhesive to the pan liner. Fold corners and nail or staple pan liner to the sidewall framing or wall studs 1/2" below the upper edge of the material to hold it in place. Nail or staple the remainder of the pan liner to the sidewall framing or wall studs 1/2" below the upper edge of the material. See Figure C.
6. For outside corners or curbs where it's necessary to cut the pan liner use a dam corner to cover the cut area. To bond dam corners in the cut area use X-15 for PVC liner installations or Oateyweld for CPE liner installations. See Figure D.
7. Locate where the drain hole is on the drain base and cut out the pan liner material to the dimension of the drain hole on the drain base. Place clamping ring over the bolts and slide the ring counter clockwise so it's locked in place. Tighten the bolts so they're snug. Make sure the weep holes are clear of any residual pan liner material or silicone. **NOTE: The clamping ring can increase the height of the finished shower floor by approximately 3/4". You will see the extension if you turn the ring upside down. Simply tighten it to the drain base the way you normally would, only inverted.**
8. Water test the installation by closing off the drain pipe opening with a pneumatic or mechanical test plug. Fill the shower floor with water just below the top of the curb and let it sit for four (4) hours. Observe for leaks and repair if necessary. Retest the installation. Repeat until the installation is leak free. Completely drain the water before proceeding to Step 9.
9. A reinforcement bed of mortar needs to be applied over the membrane (see step 11) but before doing so nail water impervious drywall to the wall studs to approximately 1" above the pan liner surface. **NOTE: The use of mortar vs. drywall for the curb should be considered because you can avoid the use of nails as you construct this part of your installation.**
10. The clamping ring has an inner thread pattern that will accept the drain barrel and strainer assembly. Once you determine the finished height of the shower thread the drain barrel into the inside clamping ring thread so the finished floor will be flush with the top of the drain barrel. As mentioned in step 7 you can increase the shower drain height by inverting the clamping ring.
11. Before the final mortar application place some pea gravel over the weep holes so the mortar doesn't completely cover them. Now lay the minimum 1-1/2" reinforcement mortar bed of concrete over the pan liner from the wall to the drain barrel, leaving enough room for the final thinset and tile application. See Figure E.



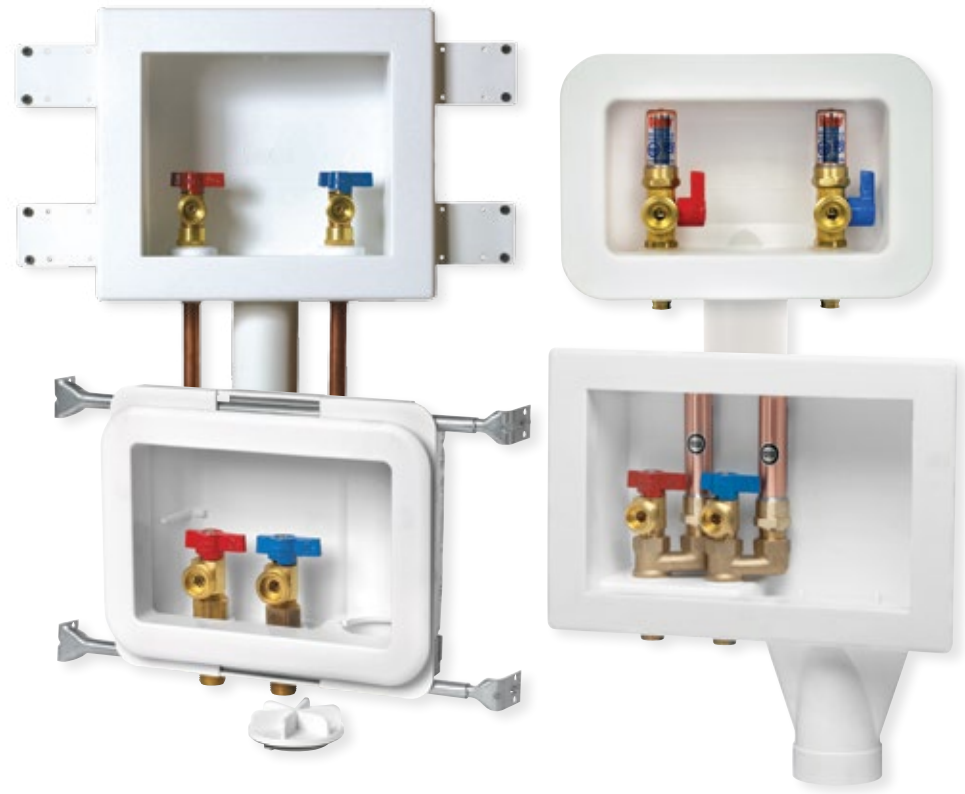

Category 11

Supply Boxes

Oatey® supply boxes can be used in commercial or residential applications that require supply valves and waste drain recessed into the wall. Available water hammer arrestor option provides water pressure shock arrestors required for installation on supply lines to quick closing valves. Available in fire-rated, round and other configurations.

NEW PRODUCTS

Oatey® Centro Center Drain Washing Machine Outlet Box (see pages 96)

Offers Flexibility and Easy Installation

Our new **Centro Center Drain Washing Machine Outlet Boxes** offer the best of both worlds – easy installation and compact box design. Made of high impact polystyrene and supplied with two mounting brackets, count on Centro boxes for maximum durability and performance in residential applications.

The durable design gives you maximum flexibility, with a wide variety of tailpiece configurations in a sleek compact design.

Why Centro?

- **Compact size** – Takes up less space and fits almost anywhere.
- **Durability** – Box and support brackets made from high-impact polystyrene.
- **Easy installation** – Knockout drain caps are removed effortlessly.
- **Flexibility** – Three knockouts on box top allow for condensate drain while two-piece valves come uninstalled, giving you the choice of mounting locations.
- **Variety** – Boxes available in various tailpiece configurations, giving you the specific product your customers need, including Water Hammer Arrestor SKUs.



NEW!
From Oatey®

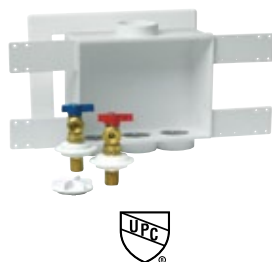

Quadtro® Washing Machine Outlet Boxes

- 2" drain opening fits PVC or ABS Sch. 40 DWV pipe.
- Easy to remove knockout, Patent Pending Hammer Valves.
- Snap-on Faceplate Frame accommodates up to 1" drywall.
- Box made of high impact polystyrene.
- Top or Bottom Valve Mount.
- 4 support brackets included for mounting.
- Dimensions: Box: 8-3/4"W x 7-1/2"H x 3-5/8"D
Faceplate: 11-3/4"W x 10-1/8"H.

Product No.	Description	Ctn. Qty.
No Hammer		
38530	Quadtro, 1/4 Turn, Copper – Standard Pack	12
38560	Quadtro, 1/4 Turn, Copper – Contractor Pack	12
38529	Quadtro, 1/4 Turn, Copper – Display Box	4
38531	Quadtro, 1/4 Turn, CPVC – Standard Pack	12
38561	Quadtro, 1/4 Turn, CPVC – Contractor Pack	12
38532	Quadtro, 1/4 Turn, F1807 – Standard Pack	12
38562	Quadtro, 1/4 Turn, F1807 – Contractor Pack	12
38528	Quadtro, 1/4 Turn, F1807 – Display Box	4
38533	Quadtro, 1/4 Turn, F1960 – Standard Pack	12
38563	Quadtro, 1/4 Turn, F1960 – Contractor Pack	12
38555	Quadtro, 1/4 Turn, F2080 – Standard Pack	12
38535	Quadtro, Single Lever, Copper – Standard Pack	12
38536	Quadtro, Single Lever, CPVC – Standard Pack	12
38537	Quadtro, Single Lever, F1807 – Standard Pack	12
38538	Quadtro, Single Lever, F1960 – Standard Pack	12
38552	Quadtro, Brass Boiler Drain, Copper – Standard Pack	12
38553	Quadtro, Brass Boiler Drain, Copper, Screw Driver Stop – Standard Pack	12
38554	Quadtro, North American Brass Boiler Drain, Copper, NAFTA – Standard Pack	12
Hammer		
38540	Quadtro, 1/4 Turn, Copper, Hammer – Standard Pack	12
38541	Quadtro, 1/4 Turn, CPVC, Hammer – Standard Pack	12
38542	Quadtro, 1/4 Turn, F1807, Hammer – Standard Pack	12
38543	Quadtro, 1/4 Turn, F1960, Hammer – Standard Pack	12
38551	Quadtro, 1/4 Turn, Compression – Standard Pack	12
38545	Quadtro, Single Lever, Copper, Hammer – Standard Pack	12
38546	Quadtro, Single Lever, CPVC, Hammer – Standard Pack	12
38547	Quadtro, Single Lever, F1807, Hammer – Standard Pack	12
38548	Quadtro, Single Lever, F1960, Hammer – Standard Pack	12
Accessories		
38550	Quadtro, Plain Box, No Valves – Standard Pack	12
38460	Quadtro, DWV test Cap with Gauge and Gauge	1
38576	Quadtro, Test Cap	12
38577	Quadtro, Hub/O-Ring	24
38941	Quadtro, Plastic Faceplate	12
38768	Brackets, 4" Long Plastic	12
38648	Brackets, 12" Long Plastic	12



#38934 shown



Center Drain Washing Machine Outlet Boxes

- High impact polystyrene.
- 4 support brackets.
- Easy drain knockout.
- Top mount knockouts.
- Dimensions: Box: 8-3/4" W x 7-1/2" H x 3-5/8" D
Faceplate: 11-3/4" W x 10-1/8" H

Product No.	Description	Ctn. Qty.
No Hammer		
38934	Center Drain, 1/4 Turn, Copper – Standard Pack	12
38825	Center Drain, 1/4 Turn, Copper w/Solder Kit – Display Pack	4
38937	Center Drain, 1/4 Turn, CPVC – Standard Pack	12
38945	Center Drain, 1/4 Turn, F1807 – Standard Pack	12
38943	Center Drain, 1/4 Turn, F1960 – Standard Pack	12
Hammer		
38747	Center Drain, 1/4 Turn, Copper, Hammer – Standard Pack	12
38970	Center Drain, 1/4 Turn, Copper, Hammer – Display Box	4
38748	Center Drain, 1/4 Turn, CPVC, Hammer – Standard Pack	12
38725	Center Drain, 1/4 Turn, F1807, Hammer – Standard Pack	12
38726	Center Drain, 1/4 Turn, F1960, Hammer – Standard Pack	12
Accessories		
38751	Center Drain, Plain Box, No Valves – Standard Pack	12
38753	Center Drain, Plain Box, No Valves – Display Box	12
38824	Center Drain, Plain Box, No Valves – Bagged	12
38799	Center Drain, Plain Box, No Valves, With Grommets – Standard Pack	12
38820	Center Drain, Plain Box, No Valves, With Grommets – Display Pack	12
38928	Center Drain, Plain Box, 1.5" -2" Drain Port – Standard Pack	12
38941	Center Drain, Plastic Faceplate	12
38768	Brackets 4" Long Plastic	12
38648	Brackets 12" Long Plastic	12



#38389 shown



Centro Washing Machine Outlet Boxes

- Takes up less space and will fit almost anywhere.
- Made of high impact polystyrene.
- Knockout drain cap.
- 3 knockouts on box top.
- Two piece valves come uninstalled.
- Two support brackets.
- Available in a wide-variety of tailpiece configurations and packaging options.
- Dimensions: Box: 8" W x 4-3/4" x 3" D
Faceplate: 10" W x 6-3/4" H

Product No.	Description	Ctn. Qty.
No Hammer		
38390	Centro, 1/4 Turn, Copper – Standard Pack	12
38392	Centro, 1/4 Turn, CPVC – Standard Pack	12
38391	Centro, 1/4 Turn, F1807 – Standard Pack	12
38396	Centro, 1/4 Turn, F1960 – Standard Pack	12
Hammer		
38393	Centro, 1/4 Turn, Copper, Hammer – Standard Pack	12
38394	Centro, 1/4 Turn, CPVC, Hammer – Standard Pack	12
38389	Centro, 1/4 Turn, F1807, Hammer – Standard Pack	12
38388	Centro, 1/4 Turn, F1960, Hammer – Standard Pack	12
Accessories		
38395	Centro, Plain Box, No Valves – Standard Pack	12
38380	Centro, Plain Box, No Valves – Standard Pack	12
38381	Centro, Plastic Faceplate	12
38382	Brackets 4" Long Plastic	12
38383	Brackets 12" Long Plastic	12



#38962 shown



Offset Drain Washing Machine Outlet Boxes

- High impact polystyrene.
- 4 support brackets.
- Easy drain knockout.
- Top mount knockouts.
- Dimensions: Box: 8-3/4" W x 7-1/2" H x 3-5/8" D
Faceplate: 11-3/4" W x 10-1/8" H

Product No.	Description	Ctn. Qty.
No Hammer		
38962	Offset Drain, 1/4 Turn, Copper – Standard Pack	12
38399	Offset Drain, 1/4 Turn, Copper – Display Box	4
38894	Offset Drain, Single Lever, Copper – Standard Pack	12
38822	Offset Drain, Single Lever, Copper – Display Box	4
Hammer		
38957	Offset Drain, 1/4 Turn, Copper, Hammer – Standard Pack	12
Accessories		
38791	Offset Drain, Plain Box, No Valves – Standard Pack	12
38941	Offset Drain, Plastic Faceplate	12
38768	Brackets 4" Long Plastic	12
38648	Brackets 12" Long Plastic	12



#38642 shown



The Eliminator® Washing Machine Outlet Boxes

- Allows single connection to drain washing machine hose, AC condensate, water softener, discharge and/or humidifier lines.
- Engineered clamping system to support discharge lines.
- 4 support brackets.
- Install in up to 24" stud bay.
- Top mount knock outs.
- High impact polystyrene.
- Dimensions: Box: 10-1/2" W x 6-1/4" H x 3-3/4" D
Faceplate: 12-3/4" W X 8-3/4" H

Product No.	Description	Ctn. Qty.
No Hammer		
38661	Eliminator, Single Lever, CPVC- Standard Pack	12
38630	Eliminator, 1/4 Turn, Copper - Standard Pack	12
38631	Eliminator, 1/4 Turn, Copper, Top Mount - Standard Pack	12
38637	Eliminator, 1/4 Turn, CPVC - Standard Pack	12
38633	Eliminator, 1/4 Turn, F1807 - Standard Pack	12
38644	Eliminator, 1/4 Turn, F1960 - Contractor Pack	12
38645	Eliminator, 1/4 Turn, F1960, Top Mount - Standard Pack	12
38634	Eliminator, Single Lever, Copper - Standard Pack	12
38635	Eliminator, Single Lever, F1807 - Standard Pack	12
38651	Eliminator, Single Lever, F1960 - Standard Pack	12
Hammer		
38642	Eliminator, 1/4 Turn, Copper, Hammer - Standard Pack	12
38655	Eliminator, 1/4 Turn, Copper, Hammer, Top Mount - Contractor Pack	12
38652	Eliminator, 1/4 Turn, CPVC, Hammer - Standard Pack	12
38656	Eliminator, 1/4 Turn, CPVC, Hammer, Top Mount - Standard Pack	12
38657	Eliminator, 1/4 Turn, F1807, Hammer, Top Mount - Contractor Pack	12
38669	Eliminator, 1/4 Turn, F1960, Hammer - Standard Pack	12
38658	Eliminator, 1/4 Turn, F1960, Hammer, Top Mount - Contractor Pack	12
38666	Eliminator, Single Lever, F1807, Hammer - Standard Pack	12
38667	Eliminator, Single Lever, F1960, Hammer - Standard Pack	12
Accessories		
38640	Eliminator, Plain Box, No Valves - Contractor Pack	12
38649	Eliminator, Plastic Faceplate	12
38646	Eliminator, Plastic Steel Clamp	6
38768	Brackets 4" Long Plastic	12
38648	Brackets 12" Long Plastic	12



#38660 shown



Double Outlet Washing Machine Outlet Boxes

Product No.	Description	Ctn. Qty.
No Hammer		
38673	Double Outlet, 1/4 Turn, Copper - Standard Pack	12
38398	Double Outlet, 1/4 Turn, Copper - Display Pack	4
38670	Double Outlet, 1/4 Turn, CPVC - Standard Pack	12
38674	Double Outlet, 1/4 Turn, F1807 - Standard Pack	12
38660	Double Outlet, Single Lever, Copper - Standard Pack	12
Accessories		
38650	Double Outlet, Plain Box, No Valves	12
38940	Double Outlet - Plastic Faceplate	12
38787	Double Outlet - Bracket Set	12



#38981 shown



Metal Washing Machine Outlet Boxes

- Allows left or right hand drain.
- 2 metal support brackets.
- 2" drain opening – rubber coupling, solvent weld or threaded.
- Box made of 20 gauge steel.
- Dimensions: Box: 9" W x 6-1/8" H x 3-1/16" D
Faceplate: 10-7/8" W x 7-3/4" H

Product No.	Description	Ctn. Qty.
No Hammer		
38981	Metal, 1/4 Turn, Copper, 2" PVC Tailpiece - Standard Pack	1
38983	Metal, 1/4 Turn, Copper, 2" ABS Tailpiece - Standard Pack	1
38993	Metal, 1/4 Turn, Copper, 2" NPT Tailpiece - Standard Pack	1
38985	Metal, 1/4 Turn, Copper, 2" Rubber Tailpiece - Standard Pack	1
38979	Metal, 1/4 Turn, CPVC, 2" Rubber Tailpiece - Standard Pack	1
38982	Metal, Single Lever, Copper, 2" PVC Tailpiece - Standard Pack	1
38984	Metal, Single Lever, Copper, 2" ABS Tailpiece - Standard Pack	1
38986	Metal, Single Lever, Copper, 2" Rubber Tailpiece - Standard Pack	1
Hammer		
38995	Metal, 1/4 Turn, Copper, Hammer, 2" Rubber Tailpiece - Standard Pack	1
38996	Metal, 1/4 Turn, CPVC, Hammer, 2" Rubber Tailpiece - Standard Pack	1
Accessories		
38980	Metal, Plain Box, No Valves, or Tailpiece - Standard Pack	1
38975	Metal, Faceplate	1
38989	Metal, 1-1/2" Rubber Tailpiece	1
38988	Metal, 2" ABS Tailpiece	1
38987	Metal, 2" PVC Tailpiece	1
38990	Metal, 2" Rubber Tailpiece	1
38976	Metal, Brackets	1

CATEGORY **11** SUPPLY BOXES



11



Fire-Rated Washing Machine Outlet Boxes

- Warnock Hersey certified, for 1-hour and 2-hour fire-rated walls.
- 2" drain opening fits PVC or ABS Sch. 40 DWV pipe.
- Box made of Bulk Molding Compound (BMC) with UL-classified intumescent pads and UL-classified insulating material.
- Adjustable metal mounting brackets, easy to remove test cap.
- Flexible valve/drain arrangement capabilities.
- Dimensions: Box: 8-1/3" W x 5-1/2" H x 3-3/4" D
Faceplate: 10-1/5" W x 7-2/5" H

Product No.	Description	Ctn. Qty.
No Hammer		
38470	Fire Rated, 1/4 Turn, Copper - Standard Pack	6
38470SP	Fire Rated, 1/4 Turn, Copper - Single Pack	1
38471	Fire Rated, 1/4 Turn, CPVC - Standard Pack	6
38471SP	Fire Rated, 1/4 Turn, CPVC - Single Pack	1
38472	Fire Rated, 1/4 Turn, F1807 - Standard Pack	6
38472SP	Fire Rated, 1/4 Turn, F1807 - Single Pack	1
38473	Fire Rated, 1/4 Turn, F1960 - Standard Pack	6
38473SP	Fire Rated, 1/4 Turn, F1960 - Single Pack	1
38474	Fire Rated, Single Lever, Copper - Standard Pack	6
38474SP	Fire Rated, Single Lever, Copper - Single Pack	1
38475	Fire Rated, Single Lever, CPVC - Standard Pack	6
38475SP	Fire Rated, Single Lever, CPVC - Single Pack	1
38476	Fire Rated, Single Lever, F1807 - Standard Pack	6
38476SP	Fire Rated, Single Lever, F1807 - Single Pack	1
38477	Fire Rated, Single Lever, F1960 - Standard Pack	6
38477SP	Fire Rated, Single Lever, F1960 - Single Pack	1
Hammer		
38478	Fire Rated, 1/4 Turn, Copper, Hammer - Standard Pack	6
38478SP	Fire Rated, 1/4 Turn, Copper, Hammer - Single Pack	1
38479	Fire Rated, 1/4 Turn, CPVC, Hammer - Standard Pack	6
38479SP	Fire Rated, 1/4 Turn, CPVC, Hammer - Single Pack	1
38480	Fire Rated, 1/4 Turn, F1807, Hammer - Standard Pack	6
38480SP	Fire Rated, 1/4 Turn, F1807, Hammer - Single Pack	1
38481	Fire Rated, 1/4 Turn, F1960, Hammer - Standard Pack	6
38481SP	Fire Rated, 1/4 Turn, F1960, Hammer - Single Pack	1
38482	Fire Rated, Single Lever, Copper, Hammer - Standard Pack	6
38482SP	Fire Rated, Single Lever, Copper, Hammer - Single Pack	1
38483	Fire Rated, Single Lever, CPVC, Hammer - Standard Pack	6
38483SP	Fire Rated, Single Lever, CPVC, Hammer - Single Pack	1
38484	Fire Rated, Single Lever, F1807, Hammer - Standard Pack	6
38484SP	Fire Rated, Single Lever, F1807, Hammer - Single Pack	1
38485	Fire Rated, Single Lever, F1960, Hammer - Standard Pack	6
38485SP	Fire Rated, Single Lever, F1960, Hammer - Single Pack	1
Accessories		
38494	Fire Rated, Plain Box, No Valves, Faceplate, or Bracket	6
38496	Fire Rated, Faceplate	6
38498	Fire Rated, Bracket-2 Piece	12
38576	Fire Rated, Test Cap	12

NOTE:

Federal regulations require the discontinuation of products containing more than 0.25% lead as of January 1, 2014. Oatey is implementing this change a year early so customers do not buy products they can't use. Therefore, certain products will be discontinued as of December 31, 2012.



#38688 shown



Metal Ice Maker Outlet Boxes

- Made of 20 gauge steel.
- Nailplate support brackets.
- Dimensions: Box: 5-1/2" W x 5" H x 2-1/2" D
Faceplate Interior: 5" W x 5" H
Faceplate Exterior: 6-3/4" W x 6-3/4" H

Product No.	Description	Ctn. Qty.
No Hammer - Discontinued after 12/31/12.		
38689	Metal, 1/4 Turn, Copper - Standard Pack	1
No Hammer Low Lead		
39141	Metal, 1/4 Turn, Copper, Low Lead - Standard Pack	1
Hammer - Discontinued after 12/31/12.		
38688	Metal, 1/4 Turn, Copper, Hammer - Standard Pack	1
Hammer Low Lead		
39140	Metal, 1/4 Turn, Copper, Hammer, Low Lead - Standard Pack	1
Accessories		
38687	Metal, Plain Box, No Valves - Standard Pack	1
38686	Metal Faceplate	1



#38681 shown



Square Ice Maker Outlet Boxes

- 2 support brackets.
- Provides quick, safe water supply and shut off for refrigerator ice maker and water dispenser.
- High impact polystyrene.
- Valves comply with requirements of NSF 61, Section 9.
- Available in several box and valve configurations.
- Dimensions: Box: 6" W x 6" H x 3-3/8" D
Faceplate: 8-1/4" W x 8-1/4" H

Product No.	Description	Ctn. Qty.
No Hammer - Discontinued after 12/31/12.		
38681	Square, 1/4 Turn, Copper - Standard Pack	6
38683	Square, 1/4 Turn, Copper - Contractor Pack	12
38823	Square, 1/4 Turn, Copper - Display Pack	6
38574	Square, 1/4 Turn, Copper - Standard Pack, 6' SS Hose	6
38680	Square, 1/4 Turn, CPVC - Standard Pack	6
38685	Square, 1/4 Turn, CPVC - Contractor Pack	12
38623	Square, 1/4 Turn, CPVC - Standard Pack, 6' SS Hose	6
38684	Square, 1/4 Turn, F1807 - Standard Pack	6
38691	Square, 1/4 Turn, F1807 - Contractor Pack	12
38950	Square, 1/4 Turn, F1807 - Display Bag	6
38575	Square, 1/4 Turn, F1807 - Standard Pack, 6' SS Hose	6
38693	Square, 1/4 Turn, F1960 - Standard Pack	6
385961	Square, 1/4 Turn, F1960 - Standard Pack, 6' SS Hose	6
38624	Square, 1/4 Turn, F1960 - Contractor Pack, 6' SS Hose	12
38807	Square, Boiler Drain, Copper, NAFTA - Standard Pack	6
38951	Square, Boiler Drain, CPVC - Standard Pack	6



Square Ice Maker Outlet Boxes (cont.)

Product No.	Description	Ctn. Qty.
No Hammer Low Lead		
39156	Square, 1/4 Turn, Copper, Low Lead - Standard Pack	6
39157	Square, 1/4 Turn, Copper, Low Lead - Contractor Pack	12
39145	Square, 1/4 Turn, Copper, Low Lead - Standard Pack, 6' SS Hose	6
39155	Square, 1/4 Turn, CPVC, Low Lead - Standard Pack	6
39159	Square, 1/4 Turn, CPVC, Low Lead - Contractor Pack	12
39153	Square, 1/4 Turn, CPVC, Low Lead - Standard Pack, 6' SS Hose	6
39158	Square, 1/4 Turn, F1807, Low Lead - Standard Pack	6
39160	Square, 1/4 Turn, F1807, Low Lead - Contractor Pack	12
39146	Square, 1/4 Turn, F1807, Low Lead - Standard Pack, 6' SS Hose	6
39161	Square, 1/4 Turn, F1960 Low Lead - Standard Pack	6
39154	Square, 1/4 Turn, F1960 Low Lead - Standard Pack, 6' SS Hose	6
39162	Square, Boiler Drain Copper, Low Lead, NAFTA - Standard Pack	6
Hammer - Discontinued after 12/31/12		
38608	Square, 1/4 Turn, Copper, Hammer - Standard Pack	6
38607	Square, 1/4 Turn, Copper, Hammer - Display Pack	6
38570	Square, 1/4 Turn, Copper, Hammer - Standard Pack, 6' SS Hose	6
38602	Square, 1/4 Turn, CPVC, Hammer - Standard Pack	6
38571	Square, 1/4 Turn, CPVC, Hammer - Standard Pack, 6' SS Hose	6
38604	Square, 1/4 Turn, F1807, Hammer - Standard Pack	6
38572	Square, 1/4 Turn, F1807, Hammer - Standard Pack, 6' SS Hose	6
38605	Square, 1/4 Turn, F1960, Hammer - Standard Pack	6
Hammer Low Lead		
39152	Square, 1/4 Turn, Copper, Hammer, Low Lead - Standard Pack	6
39151	Square, 1/4 Turn, Copper, Hammer, Low Lead - Display Pack	6
39142	Square, 1/4 Turn, Copper, Hammer, Low Lead - Standard Pack, 6' SS Hose	6
39148	Square, 1/4 Turn, CPVC, Hammer, Low Lead - Standard Pack	6
39143	Square, 1/4 Turn, CPVC, Hammer, Low Lead - Standard Pack, 6' SS Hose	6
39149	Square, 1/4 Turn, F1807, Hammer, Low Lead - Standard Pack	6
39144	Square, 1/4 Turn, F1807, Hammer, Low Lead - Standard Pack, 6' SS Hose	6
39150	Square, 1/4 Turn, F1960, Hammer, Low Lead - Standard Pack	6
Accessories		
38810	Square, Plain Box, No Valves - Standard Pack	6
38806	Square, Plain Box, No Valves, With Grommet - Standard Pack	6
38942	Square, Plastic Faceplate	24
38768	Brackets 4" Long Plastic	12
38648	Brackets 12" Long Plastic	12



#39180 shown



Round Ice Maker Outlet Boxes

- With preloaded nails and 2 support brackets for mounting options.
- Provides quick, safe water supply and shut-off for refrigerator ice maker and water dispenser.
- Valves comply with requirements of NSF 61, Section 9.
- Dimensions: Box: 5" diameter, 2-7/8" D
Faceplate: 7-3/8" diameter

Product No.	Description	Ctn. Qty.
No Hammer - Discontinued after 12/31/12		
39180	Round, 1/4 Turn, Copper - Standard Pack	6
39188	Round, 1/4 Turn, Copper - Contractor Pack	12
39197	Round, 1/4 Turn, Copper - Standard Pack, 6' SS Hose	6
39205	Round, 1/4 Turn, Copper - Contractor Pack, 6' SS Hose	12
39181	Round, 1/4 Turn, CPVC - Standard Pack	6
39189	Round, 1/4 Turn, CPVC - Contractor Pack	12
39198	Round, 1/4 Turn, CPVC - Standard Pack, 6' SS Hose	6
39182	Round, 1/4 Turn, F1807 - Standard Pack	6
39190	Round, 1/4 Turn, F1807 - Contractor Pack	12
39199	Round, 1/4 Turn, F1807 - Standard Pack, 6' SS Hose	6
39183	Round, 1/4 Turn, F1960 - Standard Pack	6
39191	Round, 1/4 Turn, F1960 - Contractor Pack	12
39200	Round, 1/4 Turn, F1960 - Standard Pack, 6' SS Hose	6
39206	Round, 1/4 Turn, F1960 - Contractor Pack, 6' SS Hose	12
No Hammer Low Lead		
39207	Round, 1/4 Turn, Copper, Low Lead - Standard Pack	6
39208	Round, 1/4 Turn, CPVC, Low Lead - Standard Pack	6
39209	Round, 1/4 Turn, F1807, Low Lead - Standard Pack	6
39210	Round, 1/4 Turn, F1960, Low Lead - Standard Pack	6
Hammer - Discontinued after 12/31/12		
39184	Round, 1/4 Turn, Copper, Hammer - Standard Pack	6
39192	Round, 1/4 Turn, Copper, Hammer - Contractor Pack	12
39201	Round, 1/4 Turn, Copper, Hammer - Standard Pack, 6' SS Hose	6
39185	Round, 1/4 Turn, CPVC, Hammer - Standard Pack	6
39193	Round, 1/4 Turn, CPVC, Hammer - Contractor Pack	12
39202	Round, 1/4 Turn, CPVC, Hammer - Standard Pack, 6' SS Hose	6
39186	Round, 1/4 Turn, F1807, Hammer - Standard Pack	6
39194	Round, 1/4 Turn, F1807, Hammer - Contractor Pack	6
39203	Round, 1/4 Turn, F1807, Hammer - Standard Pack, 6' SS Hose	6
39187	Round, 1/4 Turn, F1960, Hammer - Standard Pack	6
39196	Round, 1/4 Turn, F1960, Hammer - Contractor Pack	12
39204	Round, 1/4 Turn, F1960, Hammer - Standard Pack, 6' SS Hose	6
Hammer Low Lead		
39211	Round, 1/4 Turn, Copper, Hammer, Low Lead - Standard Pack	6
39212	Round, 1/4 Turn, CPVC, Hammer, Low Lead - Standard Pack	6
39213	Round, 1/4 Turn, F1807, Hammer, Low Lead - Standard Pack	6
39214	Round, 1/4 Turn, F1960 Hammer, Low Lead - Standard Pack	6
Accessories		
39216	Round, Plain Box, No Valves - Standard Pack	6
39215	Round, Plastic Faceplate	6
38768	Brackets 4" Long Plastic	12
38648	Brackets 12" Long Plastic	12





I2K® Ice Maker Outlet Boxes

- Nails preloaded.
- Right or left hand installation.
- Provides quick, safe water supply and shut-off for refrigerator ice maker and water dispenser.
- Valves comply with requirements of NSF 61, Section 9.
- No support bracket needed.
- Dimensions: Box: 3-1/4" W x 4" H x 2-1/2" D
Faceplate: 5" W x 6" H

Product No.	Description	Ctn. Qty.
No Hammer - Discontinued after 12/31/12		
38611	I2K, 1/4 Turn, Copper - Standard Pack	6
38612	I2K, 1/4 Turn, Copper - Contractor Pack	12
38587	I2K, 1/4 Turn, Copper - Display Pack	4
38610	I2K, 1/4 Turn, CPVC - Standard Pack	6
38614	I2K, 1/4 Turn, CPVC - Contractor Pack	12
38613	I2K, 1/4 Turn, F1807 - Standard Pack	6
38615	I2K, 1/4 Turn, F1807 - Contractor Pack	12
38597	I2K, 1/4 Turn, F1807 3/8" - Standard Pack	6
38606	I2K, 1/4 Turn, F1960 - Contractor Pack	12
38617	I2K, Boiler Drain, Copper, NAFTA - Standard Pack	6
No Hammer Low Lead		
39134	I2K, 1/4 Turn, Copper, Low Lead - Standard Pack	6
39135	I2K, 1/4 Turn, Copper, Low Lead - Contractor Pack	12
39130	I2K, 1/4 Turn, Copper, Low Lead - Display Pack	4
39133	I2K, 1/4 Turn, CPVC, Low Lead - Standard Pack	6
39137	I2K, 1/4 Turn, CPVC, Low Lead - Contractor Pack	12
39136	I2K, 1/4 Turn, F1807, Low Lead - Standard Pack	6
39138	I2K, 1/4 Turn, F1807, Low Lead - Contractor Pack	12
39132	I2K, 1/4 Turn, F1960, Low Lead - Contractor Pack	12
39139	I2K, Boiler Drain, Copper, Low Lead, NAFTA - Standard Pack	6
Hammer - Discontinued after 12/31/12		
38580	I2K, 1/4 Turn, Copper, Hammer - Standard Pack	12
38582	I2K, 1/4 Turn, CPVC, Hammer - Standard Pack	12
38583	I2K, 1/4 Turn, F1807, Hammer - Standard Pack	12
38584	I2K, 1/4 Turn, F1960, Hammer - Standard Pack	12
38573	I2K, 1/4 Turn, F2080, Hammer - Standard Pack	12
Hammer Low Lead		
39125	I2K, 1/4 Turn, Copper, Hammer, Low Lead - Standard Pack	12
39126	I2K, 1/4 Turn, CPVC, Hammer, Low Lead - Standard Pack	12
39127	I2K, 1/4 Turn, F1807, Hammer, Low Lead - Standard Pack	12
39128	I2K, 1/4 Turn, F1960, Hammer, Low Lead - Standard Pack	12
Accessories		
38619	I2K, Plain Box, No Valves - Standard Pack	6
38621	I2K, Plastic Faceplate 1/2" Deep	12
38622	I2K, Plastic Faceplate 1" Deep	12



#38486 shown



Fire-Rated Ice Maker Outlet Boxes

- Warnock Hersey certified, for 1-hour and 2-hour fire-rated walls.
- Box made of Bulk Molding Compound (BMC) with UL-classified insulating material.
- Adjustable metal mounting brackets.
- Dimensions: Box: 5-9/10" W x 5-4/5" H x 3-3/4" D
Faceplate: 8-1/8" W X 8-1/16" H

Product No.	Description	Ctn. Qty.
No Hammer - Discontinued after 12/31/12		
38486	Fire Rated, 1/4 Turn, Copper - Standard Pack	6
38486SP	Fire Rated, 1/4 Turn, Copper - Single Pack	1
38487	Fire Rated, 1/4 Turn, CPVC - Standard Pack	6
38487SP	Fire Rated, 1/4 Turn, CPVC - Single Pack	1
38488	Fire Rated, 1/4 Turn, F1807 - Standard Pack	6
38488SP	Fire Rated, 1/4 Turn, F1807 - Single Pack	1
38489	Fire Rated, 1/4 Turn, F1960 - Standard Pack	6
38489SP	Fire Rated, 1/4 Turn, F1960 - Single Pack	1
No Hammer Low Lead		
39117	Fire Rated, 1/4 Turn, Copper, Low Lead - Standard Pack	6
39117SP	Fire Rated, 1/4 Turn, Copper, Low Lead - Single Pack	1
39118	Fire Rated, 1/4 Turn, CPVC, Low Lead - Standard Pack	6
39118SP	Fire Rated, 1/4 Turn, CPVC, Low Lead - Single Pack	1
39119	Fire Rated, 1/4 Turn, F1807, Low Lead - Standard Pack	6
39119SP	Fire Rated, 1/4 Turn, F1807, Low Lead - Single Pack	1
39120	Fire Rated, 1/4 Turn, F1960, Low Lead - Standard Pack	6
39120SP	Fire Rated, 1/4 Turn, F1960, Low Lead - Single Pack	1
Hammer - Discontinued after 12/31/12		
38490	Fire Rated, 1/4 Turn, Copper, Hammer - Standard Pack	6
38490SP	Fire Rated, 1/4 Turn, Copper, Hammer - Single Pack	1
38491	Fire Rated, 1/4 Turn, CPVC, Hammer - Standard Pack	6
38491SP	Fire Rated, 1/4 Turn, CPVC, Hammer - Single Pack	1
38492	Fire Rated, 1/4 Turn, F1807, Hammer - Standard Pack	6
38492SP	Fire Rated, 1/4 Turn, F1807, Hammer - Single Pack	1
38493	Fire Rated, 1/4 Turn, F1960, Hammer - Standard Pack	6
38493SP	Fire Rated, 1/4 Turn, F1960, Hammer - Single Pack	1
Hammer Low Lead		
39121	Fire Rated, 1/4 Turn, Copper, Hammer, Low Lead - Standard Pack	6
39121SP	Fire Rated, 1/4 Turn, Copper, Hammer, Low Lead - Single Pack	1
39122	Fire Rated, 1/4 Turn, CPVC, Hammer, Low Lead - Standard Pack	6
39122SP	Fire Rated, 1/4 Turn, CPVC, Hammer, Low Lead - Single Pack	1
39123	Fire Rated, 1/4 Turn, F1807, Hammer, Low Lead - Standard Pack	6
39123SP	Fire Rated, 1/4 Turn, F1807, Hammer, Low Lead - Single Pack	1
39124	Fire Rated, 1/4 Turn, F1960, Hammer, Low Lead - Standard Pack	6
39124SP	Fire Rated, 1/4 Turn, F1960, Hammer, Low Lead - Single Pack	6
Accessories		
38495	Fire Rated, Plain Box, No Valves - Standard Pack	6
38497	Fire Rated, Faceplate	6
38498	Fire Rated, Bracket-2 Piece	12





#34310 shown

Pex Water Supply Tubes

- Meets performance requirements of ASME A122.18.6 ASTM F876 and ASTM F877.
- Fast and easy to install.
- One-piece ready to use.

Product No.	Description	Ctn. Qty.
34351	PEX Dishwasher Supply 3/8" x 3/8" x 5'	6
34300	PEX Riser Supply 3/8" Comp x 1/2" IPS Threads x 12"	12
34301	PEX Riser Supply 3/8" Comp x 1/2" IPS Threads x 20"	12
34302	PEX Riser Supply 3/8" Comp x 1/2" IPS Threads x 36"	12
34305	PEX Riser Supply 3/8" Comp x 7/8" Ballcock x 12"	12
34306	PEX Riser Supply 3/8" Comp x 7/8" Ballcock x 20"	12
34310	PEX Sink Supply 12"	48
34311	PEX Sink Supply 15"	48
34312	PEX Sink Supply 20"	48
34313	PEX Sink Supply 30"	48
34322	PEX Sink Supply 30" With Flag	48
34314	PEX Sink Supply 36"	48
34315	PEX Toilet Riser 12"	48
34316	PEX Toilet Riser 15"	48
34317	PEX Toilet Riser 20"	48
34015	PEX Water Supply Kit with 1/4" Valve	6
34018	PEX Celcon Compression Sleeve	48



Washing Machine Outlet Box Valves

Product No.	Description	Ctn. Qty.
No Hammer		
38871	WMOB Valve, 1/4 Turn, Copper, 3/4" Blue	1
38870	WMOB Valve, 1/4 Turn, Copper, 3/4" Red	1
38969	WMOB Valve, 1/4 Turn, CPVC, 3/4" Blue	1
38965	WMOB Valve, 1/4 Turn, CPVC, 3/4" Red	1
38978	WMOB Valve, 1/4 Turn, F1807, 3/4" Blue	1
38977	WMOB Valve, 1/4 Turn, F1807, 3/4" Red	1
38880	WMOB Valve, 1/4 Turn, F1960, 3/4" Blue	1
38881	WMOB Valve, 1/4 Turn, F1960, 3/4" Red	1
38433	WMOB Valve, 1/4 Turn, Compression, Blue	1
38432	WMOB Valve, 1/4 Turn, Compression, Red	1
38431	WMOB Valve, 1/4 Turn, F1807 3/8", Blue	1
38430	WMOB Valve, 1/4 Turn, F1807 3/8", Red	1
38826	WMOB Valve, Single Lever, Copper	1
38434	WMOB Valve, Single Lever, CPVC	1
38435	WMOB Valve, Single Lever, F1807	1
38436	WMOB Valve, Single Lever, F1960	1
38440	WMOB Valve, Boiler Drain, Copper	1
Hammer		
38401	WMOB Valve, 1/4 Turn, Copper, Hammer, Blue	1
38400	WMOB Valve, 1/4 Turn, Copper, Hammer, Red	1
38403	WMOB Valve, 1/4 Turn, CPVC, Hammer, Blue	1
38402	WMOB Valve, 1/4 Turn, CPVC, Hammer, Red	1
38405	WMOB Valve, 1/4 Turn, F1960, Hammer, Blue	1
38404	WMOB Valve, 1/4 Turn, F1960, Hammer, Red	1
38409	WMOB Valve, 1/4 Turn, F1807, Hammer, Blue	1
38408	WMOB Valve, 1/4 Turn, F1807, Hammer, Red	1
38429	WMOB Valve, 1/4 Turn, F1807 3/8", Hammer, Blue	1
38428	WMOB Valve, 1/4 Turn, F1807 3/8", Hammer, Red	1
38412	WMOB Valve, Single Lever, Copper, Hammer	1
38413	WMOB Valve, Single Lever, CPVC, Hammer	1
38414	WMOB Valve, Single Lever, F1807, Hammer	1
38415	WMOB Valve, Single Lever, F1960, Hammer	1



Ice Maker Outlet Box Valves

Product No.	Description	Ctn. Qty.
No Hammer - Discontinued after 12/31/12		
38974	IMOB Valve, 1/4 Turn, Copper	1
38887	IMOB Valve, 1/4 Turn, CPVC	1
38886	IMOB Valve, 1/4 Turn, F1807	1
38884	IMOB Valve, 1/4 Turn, F1960	1
38789	IMOB Valve, 1/4 Turn, F2080	1
38441	IMOB Valve, Boiler Drain, Copper	1
No Hammer Low Lead		
39176	IMOB Valve, 1/4 Turn, Copper, Low Lead	1
39175	IMOB Valve, 1/4 Turn, CPVC, Low Lead	1
39173	IMOB Valve, 1/4 Turn, F1960 Low Lead	1
39174	IMOB Valve, 1/4 Turn, F1807, Low Lead	1
39171	IMOB Valve, Boiler Drain, Copper, Low Lead	1
Hammer - Discontinued after 12/31/12		
38417	IMOB Valve, 1/4 Turn, Copper, Hammer	1
38418	IMOB Valve, 1/4 Turn, CPVC, Hammer	1
38419	IMOB Valve, 1/4 Turn, F1807, Hammer	1
38420	IMOB Valve, 1/4 Turn, F1960, Hammer	1
38422	IMOB, Valve 1/4 Turn, F2080, Hammer	1
Hammer Low Lead		
39166	IMOB Valve, 1/4 Turn, Copper, Hammer, Low Lead	1
39167	IMOB Valve, 1/4 Turn, CPVC, Hammer, Low Lead	1
39168	IMOB Valve, 1/4 Turn, F1807, Hammer, Low Lead	1
39169	IMOB Valve, 1/4 Turn, F1960, Hammer, Low Lead	1
Accessories		
38779	Adapter 1/2" Female NPT X 1/2" Copper	1
38829	Locknut 1/2" Plastic	1
38769	Grommets 1/2"	12



Category 12

Flashings

Oatey® invented the flashing industry nearly 100 years ago. Today Oatey flashings are used in commercial and residential applications where a water-tight seal around plumbing vent pipe or outside wall penetrations is required. Flashings are available in a variety of thermoplastic, aluminum, galvanized and copper materials. All Oatey flashings are rated for a minimum of 180°F continuous heat.

NEW PRODUCTS

Oatey® SideFlash™ Seals Pipe Penetrations Through Outside Walls (see page 112)

Effective Side Flashing Installs Quickly

The **Oatey SideFlash** is designed to seal around piping penetrations through outside walls. The product features a hard plastic panel with an elastomeric collar that seals around the pipe. It is designed to be installed under the house wrap or building paper to become part of the building envelope.

- **Tear-out collar** enables just two products to fit pipes from ½" to 6".
- **Faster, less expensive and longer lasting** than caulking/foam.
- **Prevents moisture** from intruding to limit mold growth.
- **Seals against air penetration** to reduce energy costs.
- **Won't fade, crack or rust.**
- **Prevents bugs and vermin** from entering the home.
- **Rated to 180° F.**



NEW!
From Oatey®

Oatey® Aurora™ Solar Flashing (see page 112)

For Solar Mounting Systems

Oatey No-Calk® Solar Flashings are designed to flash around solar mounting systems. The products consist of a metal base with an elastomeric collar that incorporates a unique tear out feature enabling it to snugly fit most common mounting systems. The flashing bases are available in aluminum, soft aluminum or galvanized metal to accommodate all different roofing materials.

- **Two items flash ½" to 3" penetrations.**
- **Seals and prevents moisture from collecting** without messy caulk or silicone.
- **Easy and fast to install.**
- **Collar designed** to fit with minimal stress.
- **Seals against insects and vermin.**
- **Flashings won't fade, crack or rust.**
- **Low profile, clean appearance.**





Sideflash™ Vertical Flashings

- Used in commercial and residential applications where a water-tight seal of piping penetrations through outside walls is required.
- Designed with a tear out collar to accommodate pipe size use from 1/2" to 2-1/2" or 3" to 6".
- 180°F continuous heat and approved for type B installations.

Product No.	Size	Description	Ctn. Qty.
12805	1/2" – 2-1/2"	Sideflash Vertical Flashing	12
12806	3" – 6"	Sideflash Vertical Flashing	12



Aurora™ No-Calk® Solar Flashings

- Can be used in commercial and residential applications where a water-tight seal for roof penetrations around the piping for solar mounting system is required.
- Low profile flashing collar design provides a clean finished appearance.
- Available in galvanized bases.
- 180°F continuous heat and approved for type B installations.

Product No.	Size	Description	Ctn. Qty.
12801	1-1/2", 9-1/2" X 12-1/2"	Aurora™ Solar Flashing	12
12802	1/2" - 1-1/2", 9-1/2" X 12-1/2"	Aurora™ Solar Flashing	12



#11853 shown



Galvanized No-Calk® Roof Flashings

- Galvanized Base.
- Self-sealing collar slides over pipe and requires no caulking.
- Metal base for pitch from 0-40° or up to 10/12 roof.
- Do not use petroleum based products or paint on flashing collar. Not for hot-mopped or built-up roofs.
- Rated 180°F continuous heat and approved for Type B installations.

Product No.	Size	Description	Ctn. Qty.
SOLAR FLASHING			
11830	.5" – 1"	Galvanized 9" x 12.5" base	12
11859	.5" – 1"	Galvanized Black 11" x 14.5" base	12
11831	.5" – 1"	Galvanized 18" x 18" base	12
STANDARD BASE FLASHING			
11840	1.25" – 1.5"	Galvanized 9" x 12.5" base	12
11841	1.25" – 1.5"	Galvanized 9" x 12.5" base	6
11853	2"	Galvanized 9" x 12.5" base	12
11854	2"	Galvanized 9" x 12.5" base	6
11866	3"	Galvanized 11" x 14.5" base	12
11867	3"	Galvanized 11" x 14.5" base	6
11879	4"	Galvanized 12" x 15" base	12
11880	4"	Galvanized 12" x 15" base	6
STANDARD BASE FLASHING – 28 GAUGE			
11960	1.25" – 1.5"	Galvanized – 28 gauge 14" x 14" base	12
11961	2"	Galvanized – 28 gauge 14" x 14" base	12
18" X 18" BASE FLASHING			
11921	1.25" – 1.5"	Galvanized 18" x 18" base	12
11923	1.25" – 1.5"	Galvanized 18" x 18" base	6
11934	2"	Galvanized 18" x 18" base	12
11936	2"	Galvanized 18" x 18" base	6
11947	3"	Galvanized 18" x 18" base	12
11950	4"	Galvanized 18" x 18" base	12





#12936 shown



Aluminum No-Calk® Roof Flashings

- Rustproof stamped aluminum base allows for easy shaping of flashing.
- Rated 180°F continuous heat and approved for Type B installations.
- Metal base for pitch from 0-40° or up to 10/12 roof.
- Self-sealing collar slides over pipe and requires no caulking.
- Do not use petroleum based products or paint on flashing collar. Not for hot-mopped or built-up roofs.

Product No.	Size	Description	Ctn. Qty.
STANDARD BASE FLASHING			
11832	.5" – 1"	Aluminum 9" x 12.5" base	12
12920	1.25" – 1.5"	Aluminum 9" x 12.5" base	12
12923	1.25" – 1.5"	Aluminum 9" x 12.5" base	6
12933	2"	Aluminum 9" x 12.5" base	12
12936	2"	Aluminum 9" x 12.5" base	6
12946	3"	Aluminum 11" x 14.5" base	12
12949	3"	Aluminum 11" x 14.5" base	6
12958	4"	Aluminum 12" x 15" base	6
12959	4"	Aluminum 12" x 15" base	12
18" X 18" BASE FLASHING			
11833	.5" – 1"	Aluminum 18" x 18" base	12
12836	1.25" – 1.5"	Soft Aluminum 18" x 18" base	12
12849	2"	Soft Aluminum 18" x 18" base	12
12852	3"	Soft Aluminum 18" x 18" base	12
12865	4"	Soft Aluminum 18" x 18" base	12



#11898 shown



U.S. Patent No. 5,390,451

Thermoplastic No-Calk® Roof Flashings

- Non-fading, non-cracking, rigid black thermoplastic base.
- Self-sealing collar slides over pipe and requires no caulking.
- Do not use petroleum based products or paint on flashing collar or plastic base. Not for hot-mopped or built-up roofs.
- Plastic base for pitch from 0-45° or up to 12/12 roof.
- Rated 180°F continuous heat and approved for Type B installations.

Product No.	Size	Description	Ctn. Qty.
STANDARD BASE FLASHING			
11908	1.25" – 1.5"	Thermoplastic 9.25" x 13" base	12
11898	1.25" – 1.5"	Thermoplastic 9.25" x 13" base	6
11909	2"	Thermoplastic 9.25" x 13" base	12
11899	2"	Thermoplastic 9.25" x 13" base	6
11910	3"	Thermoplastic 11" x 15" base	12
11890	3"	Thermoplastic 11" x 15" base	6
11911	4"	Thermoplastic 12" x 16" base	12
11891	4"	Thermoplastic 12" x 16" base	6
11884	1.25" – 1.5"	Thermoplastic 12" x 18" base	12
SW/TEXAS BASE FLASHING			
11917	1.25" – 1.5"	Thermoplastic SW 11" x 15" base	12
11918	2"	Thermoplastic SW 11" x 15" base	12
18" X 18" BASE FLASHING			
11887	1.25" – 1.5"	Thermoplastic 18" x 18" base	12
11888	2"	Thermoplastic 18" x 18" base	12
11889	3"	Thermoplastic 18" x 18" base	12

CATEGORY 12 FLASHINGS





#14012 shown



Flex-Flash™ No-Calk® Roof Flashings

- 100% flexible, foldable plastic base.
- Self-sealing collar slides over pipe and requires no caulking.
- Do not use petroleum based products or paint on flashing collar or plastic base. Not for hot-mopped or built-up roofs.
- Plastic base for pitch from 0-45° or up to 12/12 roof.
- Rated 180°F continuous heat and approved for Type B installations.

Product No.	Size	Description	Ctn. Qty.
14009	1.25" – 1.5"	Flex-Flash™ 9" x 11" base	12
14012	2"	Flex-Flash™ 9" x 11" base	12
14025	2.5"	Flex-Flash™ 10" x 13.25" base	12
14038	3"	Flex-Flash™ 10" x 13.25" base	12
14041	4"	Flex-Flash™ 11.5" x 14" base	12



#14052 shown



Master Flash® Roof Flashings

- Engineered for profiled roofing systems at any pitch.
- Rated 212°F continuous heat and approved for Type B installations.
- Easily customized to accommodate a broad range of pipe diameters.

MASTER FLASH® is a Registered Trademark of the Aztec Washer Company, Inc.

Product No.	Size	Description	Ctn. Qty.
14050	.25" – 2"	Master Flash® 4.5" x 4.5" base	6
14051	1.25" – 3"	Master Flash® 6" x 6" base	6
14052	.25" – 4"	Master Flash® 8" x 8" base	6
14053	3" – 6"	Master Flash® 10" x 10" base	6
14054	4" – 7"	Master Flash® 11" x 11" base	2
14055	5" – 9"	Master Flash® 12" x 12" base	2
14056	6" – 11"	Master Flash® 14" x 14" base	2
14057	7" – 13"	Master Flash® 17" x 17" base	2
14059	10" – 18"	Master Flash® 25" x 25" base	2



#12945 shown



U.S. Patent No. 5,588,267

All-Flash® Galvanized/Copper/Aluminum/Thermoplastic No-Calk® Roof Flashings

- Patented All-Flash® design allows use on multiple pipe sizes with choice of Aluminum, Copper, Galvanized or Thermoplastic Base.
- Rated 180°F continuous heat and approved for Type B installations.
- Metal base for pitch from 0-40° and plastic base for pitch from 0-45°.
- Self-sealing collar slides over pipe and requires no caulking.
- Do not use petroleum based products or paint on flashing collar or plastic base. Not for hot-mopped or built-up roofs.

Product No.	Size	Description	Ctn. Qty.
GALVANIZED BASE FLASHING			
11871	1.5" – 3"	Galvanized All-Flash® 11" x 14.5" base	12
11815	1.5" – 3"	Galvanized All-Flash® 11" x 14.5" base	6
11877	3" – 4"	Galvanized All-Flash® 12" x 15" base	12
11816	3" – 4"	Galvanized All-Flash® 12" x 15" base	6
11957	1.5" – 3"	Galvanized All-Flash® 18" x 18" base	12
11958	3" – 4"	Galvanized All-Flash® 18" x 18" base	12
COPPER BASE FLASHING			
12403	1.5" – 3"	Copper No-Calk® 11" x 14.5" base	12
12404	3" – 4"	Copper No-Calk® 11" x 14.5" base	12
ALUMINUM BASE FLASHING			
12945	1.5" – 3"	Aluminum All-Flash® 11" x 14.5" base	12
12956	3" – 4"	Aluminum All-Flash® 12" x 15.5" base	12
12974	1.5" – 3"	Aluminum All-Flash® 18" x 18" base	12
12975	3" – 4"	Aluminum All-Flash® 18" x 18" base	12
THERMOPLASTIC BASE FLASHING			
11919	1.5" – 3"	Thermoplastic All-Flash® 11.25" x 15" base	12
11920	3" – 4"	Thermoplastic All-Flash® 12" x 16" base	12

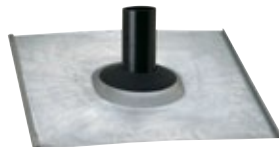

#11963 shown



Bent-Edge Galvanized All-Flash® No-Calk® Roof Flashings

- Galvanized base has 3/4" bent edge to eliminate horizontal water flow.
- Rated 180°F continuous heat and approved for Type B installations.
- Metal base for pitch from 0-40° or up to 10/12 roof.
- Self-sealing collar slides over pipe and requires no caulking.
- Do not use petroleum based products or paint on flashing collar or plastic base. Not for hot-mopped or built-up roofs.

Product No.	Size	Description	Ctn. Qty.
11962	1.5" – 3"	Bent-Edge All-Flash® Galvanized 17" x 17" base	12
11963	3" – 4"	Bent-Edge All-Flash® Galvanized 17" x 17" base	12

Electrical Service Mast (ESM) Roof Flashings

- Galvanized base.
- Do not use petroleum based products or paint on flashing collar or plastic base. Not for hot-mopped or built-up roofs.
- Self-sealing collar slides over pipe and requires no caulking.
- Collar unattached from flashing base for Electrical Service Mast applications

Product No.	Size	Description	Ctn. Qty.
11536	1.25"	Galvanized ESM	25
11549	1.5"	Galvanized ESM	25
11552	2"	Galvanized ESM	25
11565	2.5"	Galvanized ESM	25



#11930 shown



High-Rise® Thermoplastic All-Flash® No-Calk® Roof Flashings

- Ideal for steep pitch roofs with non-fading, non-cracking, rigid black thermoplastic base.
- Self-sealing collar slides over pipe and requires no caulking.
- Do not use petroleum based products or paint on flashing collar or plastic base. Not for hot-mopped or built-up roofs.
- Plastic base for pitch from 10-60° or up to 20/12 roof.
- Rated 180°F continuous heat and approved for Type B installations.

Product No.	Size	Description	Ctn. Qty.
11930	1.5" – 3"	All-Flash® High-Rise® 11" x 19" base	6
11931	3" – 4"	All-Flash® High-Rise® 13" x 20" base	6



#12944 shown



Color-Flash® Aluminum/Galvanized All-Flash® No-Calk® Roof Flashings

- Color base designed to match roof color.
- Self-sealing collar slides over pipe and requires no caulking.
- Do not use petroleum based products or paint on flashing collar or plastic base. Not for hot-mopped or built-up roofs.
- Metal base for pitch from 0-40° and plastic base for pitch from 0-45°.
- Rated 180°F continuous heat and approved for Type B installations.

Product No.	Size	Description	Ctn. Qty.
12944	1.5" – 3"	Aluminum Brown 11" x 14.5" base	12
12943	1.5" – 3"	Aluminum Black 11" x 14.5" base	12
12942	1.5" – 3"	Aluminum Gray 11" x 14.5" base	12
12955	3" – 4"	Aluminum Brown 12" x 15" base	12
12954	3" – 4"	Aluminum Black 12" x 15" base	12
12953	3" – 4"	Aluminum Gray 12" x 15" base	12
11872	1.5" – 3"	Galvanized Brown 11" x 14.5" base	12
11873	1.5" – 3"	Galvanized Black 11" x 14.5" base	12
11874	1.5" – 3"	Galvanized Gray 11" x 14.5" base	12
11875	3" – 4"	Galvanized Brown 12" x 15" base	12
11876	3" – 4"	Galvanized Black 12" x 15" base	12
11878	3" – 4"	Galvanized Gray 12" x 15" base	12

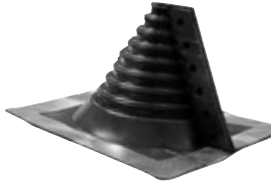

#14049 shown



Retro Master Flash® Roof Flashings

- Split collar design easily installs on pipe with limited over the top access.
- Easily customized to accommodate a broad range of pipe diameters.
- Engineered for profiled roofing systems at any pitch.
- Rated 212°F continuous heat and approved for Type B installations.

Product No.	Size	Description	Ctn. Qty.
14751	.5" – 4"	Retro Master Flash® 8" x 8" base	10
14752	4" – 9.25"	Retro Master Flash® 8" x 8" base	5
14753	9.25" – 16.25"	Retro Master Flash® 8" x 8" base	5
14049	.25" – 4"	Retro Master Flash® 8" x 8" base	1



#14206 shown

Rain Collar For No-Calk® Roof Flashings

- Use as a protective water shield (slides over existing flashing).
- Do not use petroleum based products on rubber collars.
- Non-fading collar material.

Product No.	Size	Description	Ctn. Qty.
14122	1.25" – 1.5"	Collar	36
14205	1.25" – 1.5"	Collar – Carded	6
14135	2"	Collar	24
14206	2"	Collar – Carded	6
14193	3"	Collar	24
14207	3"	Collar – Carded	6
14203	4"	Collar	12
14208	4"	Collar – Carded	6
14136	1.5" – 3"	All Flash Collar	24
14137	3" – 4"	All Flash Collar	24

Oatey®



Category 13

Air Admittance Valves (AAV)

Sensitivity to pressure changes, combined with its ability to consistently open and close, is what distinguishes the Oatey® Sure-Vent® AAV from all others. Superior engineering along with stringent quality standards ensure a lifetime of unmatched performance. Available in 6, 20, 160, and 500 DFU.

CATEGORY **13** AIR ADMITTANCE VALVES (AAV)

NEW Sure-Vent® AAV Wall Box (see pages 120)

When combined with 6 or 20 DFU air admittance valves, the **Oatey Sure-Vent AAV** wall boxes are a convenient solution for recessed installations. The high-impact polystyrene construction accommodates 1-1/2" to 2" adapters through the box opening while the textured grille faceplate conceals the AAV, providing a professional looking finish.

- **AAV mounts inside the wall box to the DWV system** via a 2" diameter molded-in drain port.
- **Box accommodates 6 or 20 DFU AAVs** with 1-1/2" or 2" adapters.
- **New smaller size** – 4-1/2" x 5-3/4" box for tight areas.
- **Adjustable faceplate** mounting with any wall finish provides a clean look.
- **Box and faceplate made from high-impact polystyrene.**
- **Available with PVC or ABS adapters.**
- **UPC listed.**



NEW!
From Oatey®



#39225 shown



Sure-Vent® Air Admittance Valve – 6 DFU Capacity

- Complies to ASSE Standard 1050 and 1051.
- For use as a secondary vent.
- One size approved to handle up to 2" vent pipe.
- Opens/closes as needed by building's plumbing system.

Product No.	Size	Description	Ctn. Qty.
39225	1.5"	6 DFU Sure-Vent AAV 1-1/2" Tubular adapter (white)	6
39226	1.5"	6 DFU Sure-Vent AAV 1-1/2" Tubular adapter (black)	6
39239	1.5"	6 DFU AAV Installation Kit 1-1/2" P-trap, 6" extension tube, PVC threaded adapter & deep box flange	6
39020	1.5"	6 DFU Sure-Vent AAV No adapter	50
39250	1.5" - 2"	6 DFU Sure-Vent AAV PVC Schedule 40, 90° adapter	6
39251	1.5" - 2"	6 DFU Sure-Vent AAV ABS Schedule 40, 90° adapter	6
39252	1.5" - 2"	6 DFU Sure-Vent AAV PVC Schedule 40, 90° adapter	50
39253	1.5" - 2"	6 DFU Sure-Vent AAV ABS Schedule 40, 90° adapter	50
39254	1.5" - 2"	6 DFU Sure-Vent AAV PVC Schedule 40 adapter	6
39256	1.5" - 2"	6 DFU Sure-Vent AAV ABS Schedule 40 adapter	6
39255	1.5" - 2"	6 DFU Sure-Vent PVC Schedule 40 Adapter	50



#39238 shown



Sure-Vent® Air Admittance Valve – 20 DFU Capacity

- Complies to ASSE Standard 1050 and 1051.
- For use as a secondary vent.
- One size approved to handle up to 3" vent pipe.
- Opens/closes as needed by building's plumbing system.

Product No.	Size	Description	Ctn. Qty.
39016	1.5" – 2"	20 DFU Sure-Vent AAV with 1 ½" x 2" PVC Schedule 40 Adapter	6
39018	1.5" – 2"	20 DFU Sure-Vent AAV with 1 ½" x 2" ABS Schedule 40 Adapter	6
39017	1.5" – 2"	20 DFU Sure-Vent AAV with 1 ½" x 2" PVC Schedule 40 Adapter	50
39019	1.5" – 2"	20 DFU Sure-Vent AAV with 1 ½" x 2" ABS Schedule 40 Adapter	50
39238	1.5" – 2"	20 DFU Sure-Vent AAV with mechanical adapter	12



Sure-Vent® Air Admittance Valve – 160 DFU Capacity

- Complies to ASSE Standard 1050 and 1051.
- For use as a secondary vent.
- One size approved to handle up to 4" vent pipe.
- Opens/closes as needed by building's plumbing system.

Product No.	Size	Description	Ctn. Qty.
39220	2" – 3"	160 DFU Sure-Vent AAV 2" x 3" Sch. 40 PVC adapter	6
39221	2" – 3"	160 DFU Sure-Vent AAV 2" x 3" Sch. 40 ABS adapter	6



Sure-Vent® Air Admittance Valve – 500 DFU Capacity

- Complies to ASSE Standard 1050 and 1051.
- For use as a secondary vent.
- One size approved to handle up to 4" vent pipe.
- Opens/closes as needed by building's plumbing system.

Product No.	Size	Description	Ctn. Qty.
39223	3" – 4"	500 DFU Sure-Vent AAV 3" x 4" Sch. 40 PVC adapter	6
39224	3" – 4"	500 DFU Sure-Vent AAV 3" x 4" Sch. 40 ABS adapter	6



Sure-Vent® Metal Wall Box

- Allows access to Sure-Vent air admittance valve.
- Fits Oatey Sure-Vents – 6, 20, 160 DFU (Sold Separately.)

Product No.	Size	Description	Ctn. Qty.
39010		Sure-Vent Wall Box with Metal Grille Faceplate	12
39011		Metal Grille Faceplate For Wall Box	10



#39260 shown



Sure-Vent® Wall Box

- New, smaller size: 4-1/2" x 5-3/4".
- High-impact polystyrene construction.
- Accommodates 6 or 20 DFU AAVs with 1-1/2" or 2" adapters.
- UPC listed.

Product No.	Size	Description	Ctn. Qty.
39260		Box Kit	6
39261		Louvered Faceplate	6
39262		Box Kit with PVC Adapter and 20 DFU AAV	6
39263		Box Kit with ABS Adapter and 20 DFU AAV	6



Sure-Vent® Access Panel

- Allows access to Sure-Vent air admittance valve.
- Meets code requirements for recessing an air admittance valve in a wall.

Product No.	Size	Description	Ctn. Qty.
34247		Louvered Design Access Panel	12



In-Line Vent

- Mechanical vent installs on the drain line and vents the line without allowing sewer gas to enter the home.
- For venting sinks, tubs, showers, etc.
- Available in either chrome or black.

Product No.	Size	Description	Ctn. Qty.
39000		Chrome In-Line Vent	6
39012		ABS In-Line Vent	6



DRAIN, WASTE AND VENT

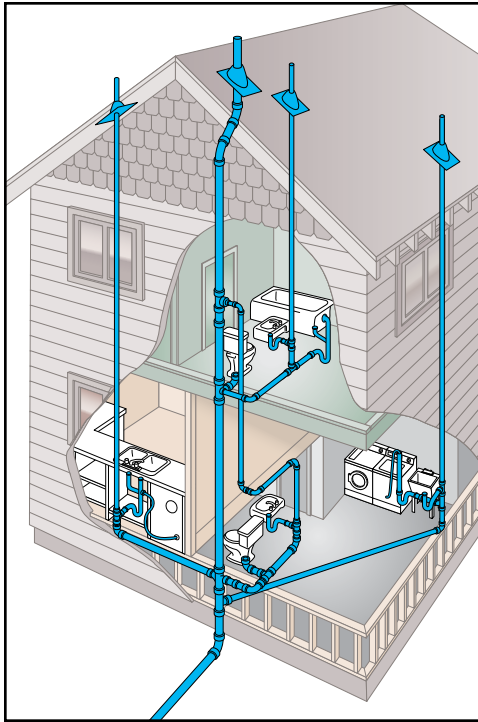

Traditional Vented House

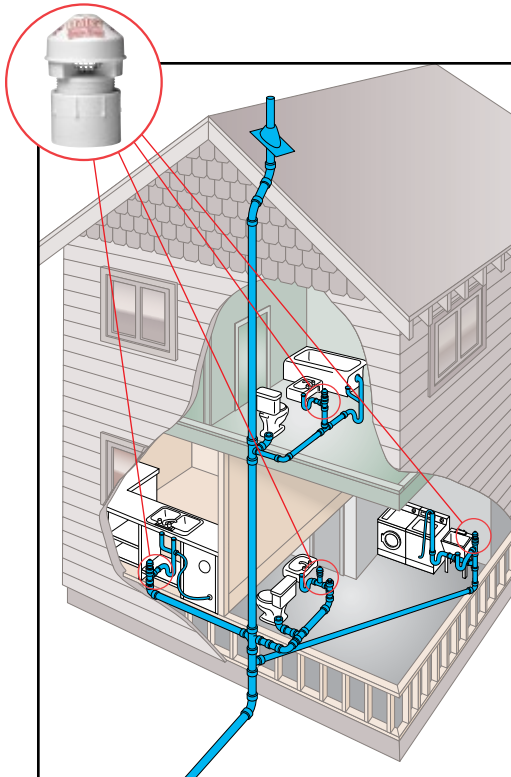

AAV Vented House

Plumbing Drain, Waste and Vent systems, known as DWV, consist of the DRAIN pipes that provide a network for the removal of WASTE and the VENT pipes that prevent traps from siphoning and maintain an equalized pressure. The DWV system uses gravity and air displacement throughout the piping network to function and breathe. In a simplified example, water in an inverted bottle without an air hole will glug and gasp when emptied. Adding an opening to the bottom of the bottle will turn the process into an efficient, steady flow because the bottle "breathes."

Every Drain Needs a Trap. Every Trap Needs a Vent.

To prevent sewer gases from being released into the structure, plumbing code requires a trap to be installed at every fixture. A trap is a U-shaped bend of pipe filled with water that acts as a barrier between the structure and the sewer system. Trap seals can only be compromised under two conditions – high sewer pressures and water siphons, in both cases vents prevent this from happening.

Under high sewer pressures without a vent, trap seals will allow sewer gases to escape and enter the structure. This happens when the sewer pressure is greater than the pressure from the column of water in the trap. A vent will keep the sewer and atmospheric pressures equalized to maintain the trap seal.

Water moving through pipes can create a negative pressure or a siphon. The siphon will pull the water from a trap, leaving a clear path for sewer gases to enter the structure. A vent will prohibit siphoning, maintaining the trap seal.

Why Use a Sure-Vent® Air Admittance Valve?

Air Admittance Valves (AAVs) open and close in conjunction with normal DWV system operation, effectively eliminating the need for secondary vent pipes. An AAV provides an alternative to secondary venting when utilized within the scope of model plumbing codes, referenced standards and Oatey® installation instructions.

AAVs provide the ideal venting solution for island sinks, remote bathroom groups and remodeling jobs by eliminating the need to tie into a stack vent.

AAVs are often more economical than running vent pipe in new construction because they reduce the added need for supplies and labor.

The Oatey Sure-Vent offers UNMATCHED PERFORMANCE by opening and closing under the smallest pressures, multiple sizes for OPTIMIZED DFUs and SUPERIOR SEALING technology, providing a lifetime of reliability.



Category 14

Pipe Support

Oatey® offers a complete range of pipe support products for all of your application needs. Whether it's securing supply lines, DWV pipe or supporting your work with brackets and bars, you can count on Oatey for quality, performance and innovation.

NEW PRODUCTS

Ultimate Efficiency – NEW DuoFit™ Clamp Fits both ½" and ¾" Pipe (see page 125)

The **Oatey® Duo-Fit** clamp is designed to hold ½" or ¾" pipe with one clamp. They can be used with copper, CPVC or PEX pipe and provide the versatility you need when mounting pipe vertically or horizontal. Move the pre-loaded nail and you can keep pipe off the stud and allow for expansion and contraction of the pipe system. They install easily and hold the pipe securely at any angle, unlike competing clamps.

- **Efficient – Use one clamp for two different size pipes.**
- **Nails are pre-loaded for fast installation.**
- **Mounts easily in tight areas using various nail angles.**
- **Can be used on copper, CPVC or PEX pipe systems.**
- **Temperature range 0°F to 230°F.**
- **Constructed using black polypropylene.**
- **Can be used with hydronic systems.**
- **IAPMO certified.**



NEW!
From Oatey®

NEW Stand-Off™ Clamp Keeps Pipe Off Studs for Reduced Noise (see page 125)

The **Oatey® Stand-Off™** pipe clamp is designed to hold ½", ¾" and 1" pipe completely off the stud or mounting surface, producing less noise while maximizing pipe protection. The clamps can be used with copper, CPVC or PEX pipe and provide the versatility you need when mounting pipe vertically or horizontally.

Pre-loaded nail provides fast and easy installation.

- **Holds pipe off the stud to minimize noise and protect the pipe.**
- **Nails are pre-loaded for fast installation.**
- **Mounts easily in tight areas using various nail angles.**
- **Can be used on copper, CPVC or PEX pipe systems.**
- **Made from high impact polypropylene.**
- **Temperature range -60°F to 160°F.**



Improved J-Hook Design Holds Pipe in Place More Securely (see page 128)

Oatey® J-Hooks are designed to hold and support 1-1/2" - 4" drain, waste or vent (DWV) pipes. The locking finger allows DWV pipes to be held in inverted applications, while the pre-loaded nails make it easier to install. A new diagonal nail path makes it much easier to hammer in tighter areas. Additional holes allow securing cable ties and other fasteners.

- Nails are pre-loaded for fast installation.
- Exclusive locking finger for mounting DWV pipe in any angle.
- Can be used in tight areas.
- Can be used above or below the joist for running DWV pipes.
- Constructed using black and white ABS
- Temperature range -40°F to 180°F.

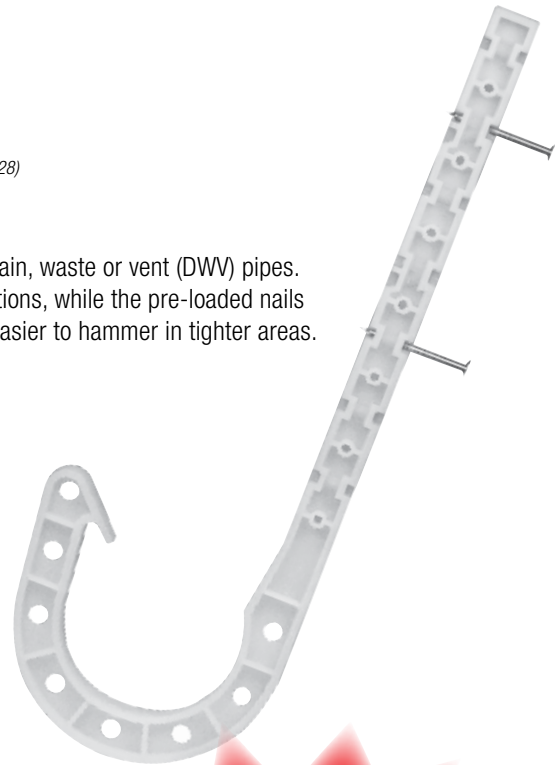

NEW!
From Oatey®

Bucket o' Savings – DuoFit™ and Stand-Off™ Clamps in 2 Gallon Buckets (see page 125)

No need to break the bank when buying a bucket of clamps from Oatey®. You can now get your favorite Duo-Fit and Stand-Off clamps in a handy 2.1 gallon Oatey bucket. The bucket holds 300-500 clamps depending on the size and type. And each bucket features a unique reclosable lid. No need to cut a hole in the lid like other buckets force you to do, tearing your hand up in the process of grabbing a handful of clamps. Better yet, when the bucket is empty, it makes a great storage container, or is useful when working on plumbing under sinks and tight areas where bigger buckets just can't fit.

- Smaller size bucket saves you money, more versatile.
- Reclosable lid is easy on the hands.
- Holds 400 DuoFit clamps.
- Holds 500 1/2" Stand-Off clamps.
- Holds 300 3/4" Stand-Off clamps.



Oatey®



#34285 shown



DuoFit™ Pipe Clamps

- One clamp fits both 1/2" and 3/4" size pipe.
- Use on copper, CPVC and PEX.
- Move pre-loaded nail to keep pipe off of stud.
- Temperature range: 0°F - 160°F.
- Constructed of black polypropylene.

Product No.	Size	Description	Ctn. Qty.
34285	1/2" - 3/4"	DuoFit Pipe Support System with Nail (100 in polybag)	500 Pcs
34295	1/2" - 3/4"	DuoFit Pipe Support System with Nail (12 in polybag)	6 Bags
34297	1/2" - 3/4"	DuoFit Pipe Support System with Nail (400 in 2.Gallon Bucket)	1



#34286 shown



Stand-Off™ Half Clamps

- Clamps keep pipe completely off of the stud.
- Pre-loaded nail provides fast and easy installation.
- Made of high-impact polypropylene.
- Temperature range: -60°F - 160°F.

Product No.	Size	Description	Ctn. Qty.
34286	1/2"	Stand-Off Pipe Clamp with Nail (100 in polybag)	500 Pcs
34287	3/4"	Stand-Off Pipe Clamp with Nail (100 in polybag)	500 Pcs
34288	1"	Stand-Off Pipe Clamp with Nail (50 in polybag)	250 Pcs
34298	1/2"	Stand-Off Pipe Clamp with Nail (500 in 2.Gallon Bucket)	1
34299	3/4"	Stand-Off Pipe Clamp with Nail (300 in 2.Gallon Bucket)	1



#33900 shown



Pipe Clamps With Nail

- Pre-loaded nail feature provides fast and easy installation.
- Ribbed design insulates against water line noise.
- No corrosion – made of high impact polypropylene.
- Rust resistant nails.
- Can be used on hydronic systems.

Product No.	Size	Description	Ctn. Qty.
HALF CLAMP			
33900	1/2"	Half Clamp w/ barbed nail (100 in polybag)	500 PCS.
34900	1/2"	Half Clamp w/ barbed nail (100 in polybag)	5 BAGS
33910	1/2"	Half Clamp w/ barbed nail (12 in polybag)	6 BAGS
33901	3/4"	Half Clamp w/ barbed nail (100 in polybag)	500 PCS.
33911	3/4"	Half Clamp w/ barbed nail (12 in polybag)	6 BAGS
34901	3/4"	Half Clamp w/ barbed nail (100 in polybag)	5 BAGS
33902	1"	Half Clamp w/ barbed nail (50 in polybag)	250 PCS.
33909	1"	Half Clamp w/ barbed nail (6 in polybag)	6 BAGS



#33912 shown



FULL CLAMP			
33905	1/2"	Full Clamp w/ barbed nail (100 in polybag)	500 PCS.
33912	1/2"	Full Clamp w/ barbed nail (12 in polybag)	6 BAGS
33906	3/4"	Full Clamp w/ barbed nail (50 in polybag)	250 PCS.
33913	3/4"	Full Clamp w/ barbed nail (12 in polybag)	6 BAGS
33907	1"	Full Clamp w/ barbed nail (25 in polybag)	250 PCS.



#33914 shown



Suspension Pipe Clamps

- Eliminates contact between the pipe and framing surface thereby reducing transmission of water line noise.
- No corrosion – made of durable polypropylene.
- Ribbed design allows faster cooling and pipe expansion and contraction.
- Can be used on hydronic systems.

Product No.	Size	Description	Ctn. Qty.
HALF CLAMP			
33935	1/2"	Suspension Pipe Clamp (100 in polybag)	500 PCS.
33914	1/2"	Suspension Pipe Clamp (6 in polybag)	6 BAGS
33936	3/4"	Suspension Pipe Clamp (100 in polybag)	500 PCS.
33915	3/4"	Suspension Pipe Clamp (6 in polybag)	6 BAGS
33937	1"	Suspension Pipe Clamp (50 in polybag)	250 PCS.
33876	1"	Suspension Pipe Clamp (6 in polybag)	6 BAGS
33956	1-1/4"	Suspension Pipe Clamp (25 in polybag)	250 PCS.
33957	1-1/2"	Suspension Pipe Clamp (25 in polybag)	250 PCS.
33958	2"	Suspension Pipe Clamp (25 in polybag)	250 PCS.



#33953 shown



Insulating Pipe Clamps

- Designed to eliminate notching and wrapping of pipe when running water lines through framing.
- Reduces water line noise and vibration.
- No corrosion – made of low density polyethylene.

Product No.	Size	Description	Ctn. Qty.
33950	1/2"	Insulating Pipe Clamp (50 in polybag)	250 PCS.
33953	1/2"	Insulating Pipe Clamp (6 in polybag)	6 BAGS
33951	3/4"	Insulating Pipe Clamp (50 in polybag)	250 PCS.
33954	3/4"	Insulating Pipe Clamp (6 in polybag)	6 BAGS
33952	1"	Insulating Pipe Clamp (25 in polybag)	250 PCS.
33875	1"	Insulating Pipe Clamp (6 in polybag)	6 BAGS



#33916 shown



Standard Pipe Clamps

- Clamp design allows pipe to be flush mounted to walls and joists.
- Minimizes the transmission of water line noise.
- No corrosion – made of high impact polypropylene.
- Ribbed design allows pipe to cool faster and expand/contract freely.
- Can be used on hydronic systems.

Product No.	Size	Description	Ctn. Qty.
33916	1/2"	Standard Pipe Clamp (6 in polybag)	6 BAGS
33940	1/2"	Standard Pipe Clamp (100 in polybag)	500 PCS.
33917	3/4"	Standard Pipe Clamp (6 in polybag)	6 BAGS
33941	3/4"	Standard Pipe Clamp (100 in polybag)	500 PCS.
33877	1"	Standard Pipe Clamp (6 in polybag)	6 BAGS
33942	1"	Standard Pipe Clamp (50 in polybag)	250 PCS.
33943	1-1/4"	Standard Pipe Clamp (25 in polybag)	250 PCS.
33944	1-1/2"	Standard Pipe Clamp (25 in polybag)	250 PCS.
33946	2"	Standard Pipe Clamp (25 in polybag)	250 PCS.



#33680 shown



Versa-Link™ Modular CTS Clamp

- Modular design for quick connections.
- Use on PEX, CPVC or copper pipe.
- Available in one-pipe clamp or two-pipe clamp configurations.
- Positions pipe in the center of the stud.
- Pre-loaded with nails or drill point screws.

Product No.	Size	Description	Ctn. Qty.
33680	1/2"	Two-Pipe Clamps with Nails (20 in polybag)	10 BAGS
33681	1/2"	Two-Pipe Clamps with Screws (20 in polybag)	10 BAGS
33682	1/2"	One-Pipe Clamps	10 BAGS

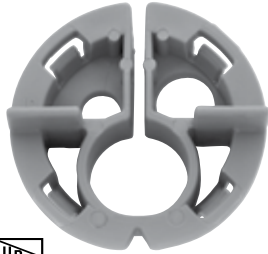

#33857 shown

Metal Stud Insulating Pipe Clamps

- Reduces water line noise and vibration when running water lines through metal studs.
- Uses 1-11/32" hole diameter.
- 1/2" size has 1/4" and 3/8" holes.
- Can be used on hydronic systems.
- No corrosion – made of durable polypropylene.

Product No.	Size	Description	Ctn. Qty.
33856	1/2"	Metal Stud Insulating Pipe Clamp (50 in polybag)	250 PCS.
33857	3/4"	Metal Stud Insulating Pipe Clamp (50 in polybag)	250 PCS.
33858	1"	Metal Stud Insulating Pipe Clamp (25 in polybag)	250 PCS.



Holdrite® Pipe Support Bracket

- Supports any water supply lines penetrating the wall.
- Holes on 2" centers for 1/2" pipe and 4" centers for 3/4" and 1" copper pipe.
- Nail in place and solder pipe to copper plated bracket for secure installation.

Holdrite® is a registered trademark of Securus, Inc.

Product No.	Size	Description	Ctn. Qty.
33980		Pipe Support Bracket	25 PCS



#33965 shown

Flat Tube Nailers

- Copper plated tube nailers provide quick nail support.
- Use with copper, PVC, CPVC, galvanized, PEX and other piping systems.

Product No.	Size	Description	Ctn. Qty.
33966	1/2" – 3/4"	Copper Coated Steel Nailer (100 in polybag)	1000 PCS.
33965	1/2" – 3/4"	Copper Coated Tube Nailer (12 in polybag)	36 BAGS



#33995 shown

Copper Tube Straps

- Use with copper, PVC, CPVC, galvanized, polybutylene and other piping systems.
- Allows pipe to be flush mounted to walls, joists and rafters.

Product No.	Size	Description	Ctn. Qty.
33993	1/2"	Copper Tube Strap (50 in polybag)	500 PCS.
33995	1/2"	Copper Tube Strap (12 in polybag)	6 BAGS
33994	3/4"	Copper Tube Strap (50 in polybag)	500 PCS.
33996	3/4"	Copper Tube Strap (12 in polybag)	6 BAGS
33908	1"	Copper Tube Strap (12 in polybag)	6 BAGS



Copper and Steel Pipe Hooks

- Use with copper, PVC, CPVC, galvanized, PEX and other piping systems.
- Support pipe from rafters or joists.
- Self-nailing.

Product No.	Size	Description	Ctn. Qty.
33971	1/2" x 6"	Copper Pipe Hook – 50 per Box	500 PCS.
33970	1/2" x 6"	Copper Pipe Hook – 12 per Bag	10 BAGS
33973	3/4" x 6"	Copper Pipe Hook – 50 per Box	500 PCS.
33972	3/4" x 6"	Copper Pipe Hook – 12 per Bag	10 BAGS
33975	1" x 6"	Copper Pipe Hook – 50 per Box	500 PCS.
33969	1" x 6"	Copper Pipe Hook – 6 per Bag	12 BAGS
33974	1" x 6"	Copper Pipe Hook – 12 per Bag	10 BAGS
33977	1/2" x 6"	Copper Pipe Hook – 6 per Bag	12 BAGS
33955	1/2" x 6"	Steel Pipe Hook – 6 per Bag	12 BAGS.
33998	1/2" x 6"	Steel Pipe Hook – 50 per Box	500 PCS.
33964	1/2" x 6"	Steel Pipe Hook – 12 per Bag	12 BAGS
33999	3/4" x 6"	Steel Pipe Hook – 50 per Box	500 PCS.
33979	3/4" x 6"	Steel Pipe Hook – 6 per Bag	12 BAGS
33997	1" x 6"	Steel Pipe Hook – 50 per Box	500 PCS.



DWV J-Hook

- Pre-loaded nails in stem.
- Diagonal nail path for use in tight applications.
- Locking finger for tight hold at any angle, including inverted.
- Additional holes allow securing with cable ties or other fasteners.
- Made of black and white ABS. Temperature range: -40°F - 180°F.

Product No.	Size	Description	Ctn. Qty.
33740	1-1/2" x 7-1/2"	DWV J-Hook - White (25 In Polybag)	300 PCS.
33760	1-1/2" x 7-1/2"	DWV J-Hook - White (4 In Polybag)	6 BAGS
33741	2" x 7-1/2"	DWV J-Hook - White (25 In Polybag)	300 PCS.
33761	2" X 7- 1/2"	DWV J-Hook - White (4 In Polybag)	6 BAGS
33742	3" x 7-1/2"	DWV J-Hook - White (25 In Polybag)	300 PCS.
33762	3" X 7-1/2"	DWV J-Hook - White (4 In Polybag)	6 BAGS
33743	4" x 7-1/2"	DWV J-Hook - White (25 In Polybag)	300 PCS.
33763	4" x 7-1/2"	DWV J-Hook - White (4 In Polybag)	6 BAGS
33755	1-1/2" x 7"	DWV J-Hook - Black (25 In Polybag)	300 PCS.
33756	2" x 7"	DWV J-Hook - Black (25 In Polybag)	300 PCS.
33757	3" x 7"	DWV J-Hook - Black (25 In Polybag)	300 PCS.
33758	4" x 7"	DWV J-Hook - Black (25 In Polybag)	300 PCS.



CTS J-Hook

- Support copper and CPVC water supply lines from joists and rafters.
- J-Hook nails flush against a wall or stud.
- Made of high impact ABS for increased load capacity.

Product No.	Size	Description	Ctn. Qty.
33745	1/2" x 4"	CTS Baby J-Hook (25 in polybag)	300 PCS.
33764	1/2" x 4"	CTS Baby J-Hook (6 in polybag)	6 BAGS
33746	3/4" x 4"	CTS Baby J-Hook (25 in polybag)	300 PCS.
33765	3/4" x 4"	CTS Baby J-Hook (6 in polybag)	6 BAGS
33747	1" x 4"	CTS Baby J-Hook (25 in polybag)	200 PCS.
33766	1" x 4"	CTS Baby J-Hook (6 in polybag)	6 BAGS
33750	1/2" x 7-1/2"	CTS Long Baby J-Hook (25 in polybag)	200 PCS.
33751	3/4" x 7-1/2"	CTS Long Baby J-Hook (25 in polybag)	200 PCS.

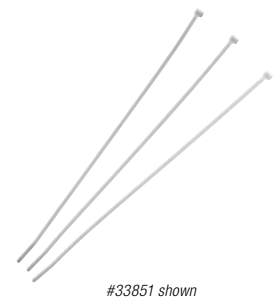

Cable, Conduit & Duct Ties

- Enables cables, tubing, etc. to be secured together.
- Special locking device provides a positive, non-slip grip.
- Made of nylon.

Product No.	Size	Description	Ctn. Qty.
33850	7-1/2"	Ties for 1-3/4" diameter (25 in polybag)	12 BAGS
33851	11"	Ties for 3" diameter (25 in polybag)	12 BAGS
33852	14"	Ties for 4" diameter (25 in polybag)	12 BAGS
33853	24"	Ties for 7" diameter (6 in polybag)	12 BAGS
33854	34"	Ties for 10" diameter (6 in polybag)	12 BAGS
33855	48"	Ties for 15" diameter (6 in polybag)	12 BAGS



Stud Guards and FHA Plates

- Provide protection for pipes and wiring installations.
- Stud guards have special self-nailing feature.
- Made of 16 or 18 gauge steel.

Product No.	Size	Description	Ctn. Qty.
33897	5" x 8"	16 Gauge BOCA Plate Meets BOCA Code P-309.2	25 PCS.
33899	5" x 8"	16 Gauge Self-Nailing BOCA Plate Meets BOCA Code P-309.2	25 PCS.
33893	1-1/2" x 3"	16 Gauge Self-Nailing Stud Guard – 2-1/2" between points	100 PCS.
33894	1-1/2" x 5"	16 Gauge Self-Nailing Stud Guard – 4-1/2" between points	100 PCS.
33984	1-1/2" x 5"	16 Gauge Self-Nailing Stud Guard – 4-1/2" between points	100 PCS.
33895	1-1/2" x 6"	16 Gauge Self-Nailing Stud Guard – 5-1/2" between points	100 PCS.
33930	1-1/2" x 3"	18 Gauge Self-Nailing Stud Guard – 2-1/2" between points	100 PCS.
33933	1-1/2" x 3"	18 Gauge Self-Nailing Stud Guard – Barcoded	25 PCS.
33931	1-1/2" x 5"	18 Gauge Self-Nailing Stud Guard – 4-1/2" between points	100 PCS.
33934	1-1/2" x 5"	18 Gauge Self-Nailing Stud Guard – Barcoded	25 PCS.
33919	1-1/2" x 6"	18 Gauge Self-Nailing Stud Guard – 5-1/2" between points	100 PCS.
33932	1-1/2" x 9"	18 Gauge FHA Plate -Barcoded	25 PCS.



#33918 shown

Metal Hanger Strap

- Quick and inexpensive way to hang pipe from joists or rafters.
- Available in 24 and 28 gauge steel.

Product No.	Size	Description	Ctn. Qty.
33918	3/4" x 10'	24 Ga. Copper-Plated Steel Hanger Strap – Bagged	12 PCS.
33730	3/4" x 10'	24 Ga. Galvanized Steel Hanger Strap – Bagged	12 PCS.
33889	3/4" x 100'	28 Ga. Galvanized Steel Hanger Strap – Boxed	10 PCS.
33923	3/4" x 10'	28 Ga. Galvanized Steel Hanger Strap – Bagged	12 PCS.
33929	3/4" x 25'	28 Ga. Galvanized Steel Hanger Strap – Bagged	12 PCS.
33922	3/4" x 50'	28 Ga. Galvanized Steel Hanger Strap – Bulk	10 PCS.



#33925 shown

Plastic Hanger Strap

- Nail holes are 1/8" in diameter and spaced 3/4" apart.
- Non-corrosive, non-conductive, polyethylene.
- Quick and inexpensive way to hang pipe from joists or rafters.

Product No.	Size	Description	Ctn. Qty.
33928	3/4" x 10'	Plastic Hanger Strap – Bagged	12 PCS.
33925	3/4" x 25'	Plastic Hanger Strap – Bagged	20 PCS.
33926	3/4" x 50'	Plastic Hanger Strap – Bagged	20 PCS.
33927	3/4" x 100'	Plastic Hanger Strap – Bagged	20 PCS.
339270	3/4" x 100'	Plastic Hanger Strap – Bagged	10 PCS.

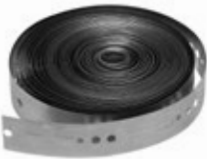

#33992 shown

Tab Tape®

- Self fastening Hanger Strap.
- No nuts or bolts required.

Tab Tape® is a registered trademark of Hang It All Products.

Product No.	Size	Description	Ctn. Qty.
33989	3/4" x 10'	Galvanized Tab Tape – 28 Ga. – Bagged	12 PCS.
33992	1-1/2" x 50'	Galvanized Tab Tape – 26 Ga. – Boxed	5 PCS.



#33982 shown

Hyco Bar

- Multi-purpose Galvanized Strap.

Product No.	Size	Description	Ctn. Qty.
33982	5/8" x 18"	Hyco-Bar – 14 Ga.	100
33983	5/8" x 26"	Hyco-Bar – 14 Ga.	100



#33692 shown

Copper Plated Bell Hangers

- Designed with 13/16" standoff from mounting surface.
- Mounting screw has pierce point for use on metal studs.
- Recessed mounting screw does not contact the piping.
- Includes two clamp screws and one 2-1/2" screws.

Product No.	Size	Description	Ctn. Qty.
33691	1/2"	Copper Plated Bell Hanger	25
33692	3/4"	Copper Plated Bell Hanger	25
33693	1"	Copper Plated Bell Hanger	25



#33699 shown

Copper Plated Milford Hangers

- Hang copper tube size piping.
- Top set plate swivels and locks into place.

Product No.	Size	Description	Ctn. Qty.
33694	1/2" x 6"	Copper Plated Milford Hanger	25
33695	3/4" x 6"	Copper Plated Milford Hanger	25
33696	1" x 6"	Copper Plated Milford Hanger	25
33697	1/2" x 12"	Copper Plated Milford Hanger	25
33698	3/4" x 12"	Copper Plated Milford Hanger	25
33699	1" x 12"	Copper Plated Milford Hanger	25



Category 15

Brass, Plastic and Commercial Tubular/Grab Bars

If you need brass, plastic or commercial tubular products, Dearborn has what you are looking for. There are literally hundreds of parts to choose from: P-traps, S-traps, J-bends, waste arms, extension tubes, grab bars and much more.

NEW PRODUCTS

Build a Better P-Trap – with Made in the USA, Premium TRUE BLUE® Washers (see page 153)

Dearborn Brass® offers a complete line of lightweight and dependable plastic tubular products for all installations in 1-1/4" and 1-1/2" sizes. Dearborn tubular meets the industry standards and provides consistent quality and reliability. All of our P-traps include TRUE BLUE premium washers. These washers incorporate a specially formulated blue Thermoplastic Elastomer (TPE) to prevent drying out and cracking. The material has superior flex fatigue resistance and extends the life of the product. Better yet, the TPE is flexible, easier to install and provides a secure seal with simple hand tightening.

- **Ultra flexible elastomer washer combined** with the tapered design provides ultimate leak protection.
- **Superior flex fatigue resistance** extends the life of the product.
- **TPE advanced properties** allows washer to retain its shape when compared to traditional rubber.
- **Doesn't dry out or crack**, providing long, leak-free protection.
- **TRUE BLUE washers are made in the United States.**
- **IAPMO listed.**



NEW!
From Dearborn Brass®

Complete Garbage Disposal Kit for Double Sink (see page 151)

Insist on the **Dearborn Brass® Garbage Disposal Kit** for years of trouble-free use from your garbage disposal. The kit comes complete with a P-trap, waste line to the wall, connection to the disposal, connection to the non-disposal sink, an optional adapter for the dishwasher discharge hose and all the nuts and washers you need to do the job. Ultra flexible elastomer washer combined with the tapered design provides ultimate leak protection.

- **Complete kit means you don't have to piece together components**, potentially leading to poor seals and possible leaks.
- **Polypropylene tubular is easy to cut to length**, making it easy to fit any sink type or configuration.
- **Non-metallic components are corrosion resistant**, lightweight and impervious to most household cleaners and chemicals.





1-1/4" P-Traps Without Cleanout

Product No.	Size	Description	Ctn.	Qty.
2700-1	1-1/4"	P-Trap - Budget Ga.	25	
2700A-1	1-1/4"	P-Trap - Budget Ga. w/ 9.50" Wall Tube	25	
2700DF-1	1-1/4"	P-Trap - Budget Ga. w/ Deep Flange	25	
700-1	1-1/4"	P-Trap - 20 Ga.	25	
700A-1	1-1/4"	P-Trap - 20 Ga. w/ 10" Wall Tube	25	NSF
700BN-1	1-1/4"	P-Trap - 20 Ga. w/ Brass Nuts	25	NSF
700DF-1	1-1/4"	P-Trap - 20 Ga. w/ Deep Flange	25	NSF
700DFBN-1	1-1/4"	P-Trap - 20 Ga. w/ Deep Flange & Brass Nuts	25	NSF
701-1	1-1/4"	P-Trap - 17 Ga.	25	NSF
701BN-1	1-1/4"	P-Trap - 17 Ga. w/ Brass Nuts	25	NSF
701DF-1	1-1/4"	P-Trap - 17 Ga. w/ Deep Flange	25	NSF
701DFBN-1	1-1/4"	P-Trap - 17 Ga. w/ Deep Flange & Brass Nuts	25	NSF
701A-1	1-1/4"	P-Trap - 17 Ga. w/ 10" Wall Tube	25	NSF
701ADF-1	1-1/4"	P-Trap - 17 Ga. w/ Deep Flange 10" Wall Tube	25	NSF
701G-1	1-1/4"	P-Trap - 17 Ga. w/ Ground Joint	25	NSF
21604	1-1/4"	P-Trap - 17 Ga. w/ Box Flange, Polished Brass	2	NSF
21603	1-1/4"	P-Trap - 17 Ga. w/ Deep Flange, Polished Brass	2	NSF



#21303 shown



#2702-1 shown

1-1/2" P-Traps Without Cleanout

Product No.	Size	Description	Ctn.	Qty.
2702-1	1-1/2"	P-Trap - Budget Ga.	25	
2702DF-1	1-1/2"	P-Trap - Budget Ga. w/ Deep Flange	25	
702-1	1-1/2"	P-Trap - 20 Ga.	25	NSF
702BN-1	1-1/2"	P-Trap - 20 Ga. w/ Brass Nuts	25	NSF
702DF-1	1-1/2"	P-Trap - 20 Ga. w/ Deep Flange	25	NSF
702DFBN-1	1-1/2"	P-Trap - 20 Ga. w/ Deep Flange & Brass Nuts	25	NSF
702A-1	1-1/2"	P-Trap - 20 Ga. w/ 11.25" Wall Tube	25	NSF
704-1	1-1/2"	P-Trap - 17 Ga.	25	NSF
H704-3	1-1/2"	P-Trap - 17 Ga., Unfinished, Cutcase Box	6	NSF
704BN-1	1-1/2"	P-Trap - 17 Ga. w/ Brass Nuts	25	NSF
704DF-1	1-1/2"	P-Trap - 17 Ga. w/ Deep Flange	25	NSF
704DFBN-1	1-1/2"	P-Trap - 17 Ga. w/ Deep Flange & Brass Nuts	25	NSF
704A-1	1-1/2"	P-Trap - 17 Ga. w/ 11.25" Wall Tube	25	NSF
704G-1	1-1/2"	P-Trap - 17 Ga. w/ Ground Joint	25	NSF
704GBN-1	1-1/2"	P-Trap - 17 Ga. w/ Ground Joint & Brass Nuts	25	NSF
704GBN-3	1-1/2"	P-Trap - 17 Ga. w/ Ground Joint & Brass Nuts, Unfinished	25	NSF
704GDFBN-1	1-1/2"	P-Trap - 17 Ga. w/ Ground Joint, Deep Flange & Brass Nuts	25	NSF



#705GBN-1 shown

1-1/4" X 1-1/2" P-Traps With Choked Throat Without Cleanout

Product No.	Size	Description	Ctn.	Qty.
703-1	1-1/4" x 1-1/2"	P-Trap - 20 Ga. w/ Choked Throat	25	
705-1	1-1/4" x 1-1/2"	P-Trap - 17 Ga. w/ Choked Throat	25	
705BN-1	1-1/4" x 1-1/2"	P-Trap - 17 Ga. w/ Choked Throat & Brass Nuts	25	
705GBN-1	1-1/4" x 1-1/2"	P-Trap - 17 Ga. w/ Choked Throat, Ground Joint & Brass Nuts	25	NSF





#707-1 shown

P-Traps With Cleanout

Product No.	Size	Description	Ctn. Qty.
706-1	1-1/4"	P-Trap w/ Cleanout - 20 Ga.	10
707-1	1-1/4"	P-Trap w/ Cleanout - 17 Ga.	10
707DF-1	1-1/4"	P-Trap w/ Cleanout - 17 Ga. w/ Deep Flange	10
707A-1	1-1/4"	P-Trap w/ Cleanout - 17 Ga. w/ 10" Wall Tube	10
707BN-1	1-1/4"	P-Trap w/ Cleanout - 17 Ga. w/ Brass Nuts	10
708-1	1-1/2"	P-Trap w/ Cleanout - 20 Ga.	10
710-1	1-1/2"	P-Trap w/ Cleanout - 17 Ga.	10
710BN-1	1-1/2"	P-Trap w/ Cleanout - 17 Ga. w/ Brass Nuts	10
710DF-1	1-1/2"	P-Trap w/ Cleanout - 17 Ga. w/ Deep Flange	10
710ADF-1	1-1/2"	P-Trap w/ Cleanout - 17 Ga. w/ Deep Flange & 11.25" Wall Tube	10
710GBN-1	1-1/2"	P-Trap w/ Cleanout - 17 Ga. w/ Ground Joint & Brass Nuts	10
710GDFBN-1	1-1/2"	P-Trap w/ Cleanout - 17 Ga. w/ Ground Joint, Deep Flange & Brass Nuts	10
710GDFBN-3	1-1/2"	P-Trap w/ Cleanout - 17 Ga. w/ Ground Joint, Deep Flange & Brass Nuts, Unfinished	10



Repair Traps

Product No.	Size	Description	Ctn. Qty.
700R-1	1-1/4"	Repair Trap - 20 Ga.	10
702R-1	1-1/2"	Repair Trap - 20 Ga.	10



Low Inlet Tube P-Traps

Product No.	Size	Description	Ctn. Qty.
711A-1	1-1/4"	P-Trap, Low Inlet - 17 Ga.	10
714A-1	1-1/2"	P-Trap, Low Inlet - 17 Ga.	10



N.Y. Code Trap

Product No.	Size	Description	Ctn. Qty.
H752-3	1-1/4" x 1-1/2"	N.Y. Trap - 17 Ga., Unfinished, Cutcase Box	6
H753-3	1-1/2" x 2"	N.Y. Trap - 17 Ga., Unfinished, Cutcase Box	6



L.A. Code Trap

Product No.	Size	Description	Ctn. Qty.
H751-3	1-1/2" x 2"	L.A. Trap - 17 Ga., Unfinished, Cutcase Box	6
750-1	1-1/2"	Repair Trap - 17 Ga. w/ Reducing Poly Washer	10
750-3	1-1/2"	Repair Trap - 17 Ga. w/ Reducing Poly Washer, Unfinished	10



Washington Code Traps

Product No.	Size	Description	Ctn. Qty.
743GDFBN-1	1-1/2" x 1-1/4"	Wash Code P-Trap w/Deep Flange & Brass Nuts	10
747GDFBN-1	1-1/2" x 1-1/4"	Wash Code P-Trap w/Cleanout, Deep Flange & Brass Nuts	10
727DFBN-6-1	1-1/2" x 1-1/4"	Sink Trap w/ Cleanout & 6" (SWT) Extension, Deep Flange & Brass	10



Sink Traps with Extension Cover Tube

Product No.	Size	Description	Ctn. Qty.
730GPBN-6-1	1-1/2" x 1-1/4"	Sink Trap w/ Schedule 40 PVC Adapter, Ground Joint, Cover Tube & Escutcheon & Brass Nuts	5
730GABN-6-1	1-1/2" x 1-1/4"	Sink Trap w/ Schedule 40 ABS Adapter, Ground Joint, Cover Tube & Escutcheon & Brass Nuts	5
730GPPB-3	1-1/2" x 1-1/4"	Sink Trap w/ Schedule 40 PVC Adapter, Ground Joint, Cover Tube & Escutcheon, Polished Brass & Brass Nuts	5



Sink Traps With Extension Cover Tube & Cleanout

Product No.	Size	Description	Ctn. Qty.
732GPBN-6-1	1-1/2" x 1-1/4"	Sink Trap w/ Cleanout, Schedule 40 PVC Adapter, Ground Joint, Cover Tube & Escutcheon & Brass Nuts	5



Anti-Siphon Traps

Product No.	Size	Description	Ctn. Qty.
971GBN-1	1-1/2"	Anti-Siphon P-Trap - 17 Ga., Chrome Plated, Brass Nuts	1
979GBN-1	1-1/4"	Anti-Siphon P-Trap - 17 Ga., Chrome Plated, Brass Nuts	1
983GBN-1	1-1/2"	Anti-Siphon P-Trap - 17 Ga., Chrome Plated, Brass Nuts	1



Sink Traps Without Cleanout

Product No.	Size	Description	Ctn. Qty.
736W-1	1-1/4"	Sink Trap w/ Washer Joint NPT - 20 Ga.	10
738W-1	1-1/2"	Sink Trap w/ Washer Joint NPT - 20 Ga.	10
740W-1	1-1/2"	Sink Trap w/ Washer Joint NPT - 17 Ga.	10
738-1	1-1/2"	Sink Trap w/ Ground Joint NPT - 20 Ga. w/ Reducing Poly Washer	10
738CS-1	1-1/2"	Sink Trap w/ Ground Joint w/ Copper Sweat Elbow - 20 Ga.	10
740-1	1-1/2"	Sink Trap w/ Ground Joint NPT - 17 Ga. w/ Reducing Poly Washer	10



J-Bends Without Cleanout

Product No.	Size	Description	Ctn. Qty.
2650-1	1-1/4"	J-Bend - Budget Ga.	10
650-1	1-1/4"	J-Bend - 20 Ga.	10
652-1	1-1/4"	J-Bend - 17 Ga.	10
2651-1	1-1/2"	J-Bend - Budget Ga.	10
651-1	1-1/2"	J-Bend - 20 Ga.	10
653-1	1-1/2"	J-Bend - 17 Ga.	10



Sink J-Bends Without Cleanout

Product No.	Size	Description	Ctn. Qty.
656W-1	1-1/4"	Sink J-Bend w/ Washer Joint - 20 Ga.	10
2654W-1	1-1/2"	Sink J-Bend w/ Washer Joint - Budget Ga.	10
654W-1	1-1/2"	Sink J-Bend w/ Washer Joint - 20 Ga.	10
655W-1	1-1/2"	Sink J-Bend w/ Washer Joint - 17 Ga.	10
654-1	1-1/2"	Sink J-Bend w/ Ground Joint - 20 Ga.	10
655-1	1-1/2"	Sink J-Bend w/ Ground Joint - 17 Ga.	10
655BN-1	1-1/2"	Sink J-Bend w/ Ground Joint - 17 Ga. w/ Brass Nuts	10
655BN-3	1-1/2"	Sink J-Bend w/ Ground Joint - 17 Ga. w/ Brass Nuts, Unfinished	10



Wall Tubes

Product No.	Size	Description	Ctn. Qty.
H2401-1	1-1/4"	Wall Tube 6.5" - Budget Ga., Ind. UPC	10
2401A-1	1-1/4"	Wall Tube 9.5" - Budget Ga.	25
401-17-1	1-1/4"	Wall Tube 7.5" - 17 Ga.	10
401A-17-1	1-1/4"	Wall Tube 10" - 17 Ga.	10
401B-17-1	1-1/4"	Wall Tube 15" - 17 Ga.	10
401C-17-1	1-1/4"	Wall Tube 21" - 17 Ga.	25
401D-17-1	1-1/4"	Wall Tube 33" - 17 Ga.	25
401E-17-1	1-1/4"	Wall Tube 45" - 17 Ga.	20
401F-17-1	1-1/4"	Wall Tube 57" - 17 Ga.	20
H2402-1	1-1/2"	Wall Tube 7.5" - Budget Ga., Ind. UPC	10
2402A-1	1-1/2"	Wall Tube 11.25" - Budget Ga.	10
402-17-1	1-1/2"	Wall Tube 8.25" - 17 Ga.	10
402A-17-1	1-1/2"	Wall Tube 11.25" - 17 Ga.	10
402B-17-1	1-1/2"	Wall Tube 15" - 17 Ga.	10
H402B-17-3	1-1/2"	Wall Tube 15" - 17 Ga., Unfinished, Cutcase Box	6
402C-17-1	1-1/2"	Wall Tube 21" - 17 Ga.	25
402D-17-1	1-1/2"	Wall Tube 33" - 17 Ga.	25
402E-17-1	1-1/2"	Wall Tube 45" - 17 Ga.	20
402F-17-1	1-1/2"	Wall Tube 57" - 17 Ga.	20



S-Traps Without Cleanout

Product No.	Size	Description	Ctn. Qty.
2718-1	1-1/4"	S-Trap - Budget Ga.	5
718-1	1-1/4"	S-Trap - 20 Ga.	5
718DF-1	1-1/4"	S-Trap - 20 Ga. w/ Deep Flange	5
719-1	1-1/4"	S-Trap - 17 Ga.	5
719DFBN-1	1-1/4"	S-Trap - 17 Ga. w/ Deep Flange & Brass Nuts	5
2720-1	1-1/2"	S-Trap - Budget Ga.	5
720-1	1-1/2"	S-Trap - 20 Ga.	5
720DF-1	1-1/2"	S-Trap - 20 Ga. w/ Deep Flange	5
722-1	1-1/2"	S-Trap - 17 Ga.	5
722DFBN-1	1-1/2"	S-Trap - 17 Ga. w/ Deep Flange & Brass Nuts	5



S-Traps With Cleanout

Product No.	Size	Description	Ctn. Qty.
725BN-1	1-1/4"	S-Trap - 17 Ga. w/ Cleanout & Brass Nuts	5
726BN-1	1-1/2"	S-Trap - 17 Ga. w/ Cleanout & Brass Nuts	5



Washing Machine Trap

Product No.	Size	Description	Ctn. Qty.
89-17-1	1-1/2" x 25-1/2"	Washing Machine Trap NPT-17 Ga.	1

**End Outlet Waste**

Product No.	Size	Description	Ctn. Qty.
2108A-1	1-1/2" x 16"	Center To Center, Slip Joint - Budget Ga.	10
108A-1	1-1/2" x 16"	Center To Center, Slip Joint - 20 Ga.	10 (NSC)
108B-1	1-1/2" x 21"	Center To Center, Slip Joint - 20 Ga.	10 (NSC)
111A-1	1-1/2" x 16"	Center To Center, Slip Joint - 17 Ga.	10 (NSC)
111ABN-1	1-1/2" x 16"	Center To Center, Slip Joint - 17 Ga. w/ Brass Nuts	10 (NSC)
2178A-1	1-1/2" x 16"	Center To Center, Slip Joint w/ Baffle Tee - Budget Ga.	10
78A-1	1-1/2" x 16"	Center To Center, Slip Joint w/ Baffle Tee - 20 Ga.	10 (NSC)
78A-17-1	1-1/2" x 16"	Center To Center, Slip Joint w/ Baffle Tee - 17 Ga.	10 (NSC)
78A-17BN-1	1-1/2" x 16"	Center To Center, Slip Joint w/ Baffle Tee - 17 Ga. w/ Brass Nuts	10 (NSC)



#2121A-1 shown

End Outlet Waste w/ Hi-Line

Product No.	Size	Description	Ctn. Qty.
2121A-1	1-1/2" x 16"	Center To Center, Hi-Line - Budget Ga.	10
121A-1	1-1/2" x 16"	Center To Center, Hi-Line - 20 Ga.	10 (NSC)
121B-1	1-1/2" x 21"	Center To Center, Hi-Line - 20 Ga.	10 (NSC)
131A-1	1-1/2" x 16"	Center To Center, Hi-Line - 17 Ga.	10 (NSC)
131ABN-3	1-1/2" x 16"	Center To Center, Hi-Line - 17 Ga. w/ Brass Nuts, Unfinished	10 (NSC)
2181A-1	1-1/2" x 16"	Center To Center, Hi-Line w/ Baffle Tee - Budget Ga.	10
81A-1	1-1/2" x 16"	Center To Center, Hi-Line w/ Baffle Tee - 20 Ga.	10 (NSC)

**3 Part End Outlet Waste**

Product No.	Size	Description	Ctn. Qty.
109-20-1	1-1/2" x 24"	Center To Center, Slip Joint - 20 Ga.	1

**L.A. Code End Outlet Waste**

Product No.	Size	Description	Ctn. Qty.
50-3	1-1/2" x 16"	Center To Center, LA Code - 20 Ga., Unfinished	10

**Center Outlet Waste**

Product No.	Size	Description	Ctn. Qty.
2114A-1	1-1/2" x 16"	Center To Center, Slip Joint - Budget Ga.	5
114A-1	1-1/2" x 16"	Center To Center, Slip Joint - 20 Ga.	5 (NSC)
114B-1	1-1/2" x 21"	Center To Center, Slip Joint - 20 Ga.	5 (NSC)
117A-1	1-1/2" x 16"	Center To Center, Slip Joint - 17 Ga.	5 (NSC)
79A-1	1-1/2" x 16"	Center To Center, Slip Joint w/ Baffle Tee - 20 Ga	5 (NSC)
2123A-1	1-1/2" x 16"	Center To Center, Hi-Line - Budget Ga.	5
123A-1	1-1/2" x 16"	Center To Center, Hi-Line - 20 Ga.	5 (NSC)
123B-1	1-1/2" x 21"	Center To Center, Hi-Line - 20 Ga.	5 (NSC)
133A-1	1-1/2" x 16"	Center To Center, Hi-Line - 17 Ga.	5 (NSC)
83A-1	1-1/2" x 16"	Center To Center, Hi-Line w/ Baffle Tee - 20 Ga.	5 (NSC)



#138-1 shown



#2137-1 shown

Outlet Tees with Tailpiece

Product No.	Size	Description	Ctn. Qty.
153-1	1-1/2"	End Outlet Tee - 20 Ga. For Slip Joint End Outlet Waste	10 (NSE)
2185-1	1-1/2"	Baffle Tee - 20 Ga. For Slip Joint End Outlet Waste	10 (NSE)
2185-17-1	1-1/2"	Baffle Tee - 17 Ga. For Slip Joint End Outlet Waste	10 (NSE)

2186-1	1-1/2"	Baffle Tee - 20 Ga. For Center Outlet Waste	10 (NSE)
--------	--------	---	----------

163B-1	1-1/2"	Hi-Line Nipple Only	10
--------	--------	---------------------	----

Waste Arms with Hi-line

Product No.	Size	Description	Ctn. Qty.
2138-1	7"	Waste Arm w/ Hi-Line For 16" Center Outlet - Budget Ga.	10
2138C-1	15"	Waste Arm w/ Hi-Line For 16" End Outlet - Budget Ga.	10
138-1	7"	Waste Arm w/ Hi-Line For 16" Center Outlet - 20 Ga.	10 (NSE)
138C-1	15"	Waste Arm w/ Hi-Line For 16" End Outlet - 20 Ga.	10 (NSE)
138D-1	20"	Waste Arm w/ Hi-Line For 21" End Outlet - 20 Ga.	10 (NSE)
138B-17-1	11"	Waste Arm w/ Hi-Line For 24" Center Outlet - 17 Ga.	10 (NSE)
138C-17-1	15"	Waste Arm w/ Hi-Line For 16" End Outlet - 17 Ga.	10 (NSE)
138E-17-1	23"	Waste Arm w/ Hi-Line For 24" End Outlet - 17 Ga.	10 (NSE)

Waste Arms with Slip Joint (For all 1-1/2")

Product No.	Size	Description	Ctn. Qty.
2137-1	7"	Waste Arm w/ Slip Joint For 16" Center Outlet - Budget Ga.	10
2137B-1	11"	Waste Arm w/ Slip Joint For 24" Center Outlet - Budget Ga.	10
2137C-1	15"	Waste Arm w/ Slip Joint For 16" Center Outlet - Budget Ga.	10
137-1	7"	Waste Arm w/ Slip Joint For 16" Center Outlet - 20 Ga.	10 (NSE)
H137-17-3	7"	Waste Arm w/ Slip Joint For 16" Center Outlet- 17 Ga., Unfinished, Cutcase Box	6 (NSE)
H137B-17-3	11"	Waste Arm w/ Slip Joint For 24" Center Outlet- 17 Ga., Unfinished, Cutcase Box	6 (NSE)
137C-1	15"	Waste Arm w/ Slip Joint For 16" End Outlet - 20 Ga.	10 (NSE)
137CBN-3	15"	Waste Arm w/ Slip Joint For 16" End Outlet - 20 Ga. w/ Brass Nuts, Unfinished	10 (NSE)
137D-1	20"	Waste Arm w/ Slip Joint For 21" End Outlet - 20 Ga.	10 (NSE)
137E-1	23"	Waste Arm w/ Slip Joint For 24" End Outlet - 20 Ga.	10 (NSE)
137EBN-3	23"	Waste Arm w/ Slip Joint For 24" End Outlet - 20 Ga. w/ Brass Nuts, Unfinished	10 (NSE)
137-17BN-1	7"	Waste Arm w/ Slip Joint For 16" Center Outlet - 17 Ga. w/ Brass Nuts	10 (NSE)
137C-17-1	15"	Waste Arm w/ Slip Joint For 16" End Outlet - 17 Ga.	10 (NSE)
137C-17BN-1	15"	Waste Arm w/ Slip Joint For 16" End Outlet - 17 Ga. w/ Brass Nuts	10 (NSE)
137C-17BN-3	15"	Waste Arm w/ Slip Joint For 16" End Outlet - 17 Ga. w/ Brass Nuts, Unfinished	10 (NSE)
137E-17-1	23"	Waste Arm w/ Slip Joint For 24" End Outlet - 17 Ga.	10 (NSE)
137E-17BN-3	23"	Waste Arm w/ Slip Joint For 24" End Outlet - 17 Ga. w/ Brass Nuts, Unfinished	10 (NSE)



#790-1 shown

Extension Tubes with Slip Joint

Product No.	Size	Description	Ctn. Qty.
790-1	1-1/4" x 6"	Extension Tube w/ Slip Joint - Budget Ga.	10
790A-1	1-1/4" x 8"	Extension Tube w/ Slip Joint - Budget Ga.	10
791A-1	1-1/4" x 12"	Extension Tube w/ Slip Joint - Budget Ga.	10
790-20-1	1-1/4" x 6"	Extension Tube w/ Slip Joint - 20 Ga.	10 (NSE)
790A-20-1	1-1/4" x 8"	Extension Tube w/ Slip Joint - 20 Ga.	10 (NSE)
791A-20-1	1-1/4" x 12"	Extension Tube w/ Slip Joint - 20 Ga.	10 (NSE)
791A-20BN-1	1-1/4" x 12"	Extension Tube w/ Slip Joint- 20 Ga. w/ Brass Nuts	10 (NSE)
790-17-1	1-1/4" x 6"	Extension Tube w/ Slip Joint - 17 Ga.	10 (NSE)
790-17BN-1	1-1/4" x 6"	Extension Tube w/ Slip Joint - 17 Ga. w/ Brass Nut	10 (NSE)
790A-17-1	1-1/4" x 8"	Extension Tube w/ Slip Joint - 17 Ga.	10 (NSE)
790A-17BN-1	1-1/4" x 8"	Extension Tube w/ Slip Joint - 17 Ga. w/ Brass Nut	10 (NSE)
791A-17-1	1-1/4" x 12"	Extension Tube w/ Slip Joint - 17 Ga.	10 (NSE)
791A-17BN-1	1-1/4" x 12"	Extension Tube w/ Slip Joint - 17 Ga. w/ Brass Nut	10 (NSE)
791B-17BN-1	1-1/4" x 24"	Extension Tube w/ Slip Joint - 17 Ga. w/ Brass Nut	10 (NSE)
792-1	1-1/2" x 6"	Extension Tube w/ Slip Joint - Budget Ga.	10
792A-1	1-1/2" x 8"	Extension Tube w/ Slip Joint - Budget Ga.	10
793A-1	1-1/2" x 12"	Extension Tube w/ Slip Joint - Budget Ga.	10
792-20-1	1-1/2" x 6"	Extension Tube w/ Slip Joint - 20 Ga.	10 (NSE)
792A-20-1	1-1/2" x 8"	Extension Tube w/ Slip Joint - 20 Ga.	10 (NSE)
792A-20BN-1	1-1/2" x 8"	Extension Tube w/ Slip Joint - 20 Ga. w/ Brass Nut	10 (NSE)
793A-20-1	1-1/2" x 12"	Extension Tube w/ Slip Joint - 20 Ga.	10 (NSE)
793A-20BN-1	1-1/2" x 12"	Extension Tube w/ Slip Joint - 20 Ga. w/ Brass Nut	10 (NSE)
793A-20BN-3	1-1/2" x 12"	Extension Tube w/ Slip Joint - 20 Ga. w/ Brass Nut, Unfinished	10 (NSE)
792-17-1	1-1/2" x 6"	Extension Tube w/ Slip Joint - 17 Ga.	10 (NSE)
792A-17-1	1-1/2" x 8"	Extension Tube w/ Slip Joint - 17 Ga.	10 (NSE)
792A-17BN-1	1-1/2" x 8"	Extension Tube w/ Slip Joint - 17 Ga. w/ Brass Nut	10 (NSE)
793A-17-1	1-1/2" x 12"	Extension Tube w/ Slip Joint - 17 Ga.	10 (NSE)
793A-17BN-1	1-1/2" x 12"	Extension Tube w/ Slip Joint - 17 Ga. w/ Brass Nut	10 (NSE)
793A-17BN-3	1-1/2" x 12"	Extension Tube w/ Slip Joint - 17 Ga. w/ Brass Nut, Unfinished	10 (NSE)
794-17BN-1	1-1/2" x 24"	Extension Tube w/ Slip Joint - 17 Ga. w/ Brass Nut	10 (NSE)



#786-1 shown

Extension Tubes with Solder Joint

Product No.	Size	Description	Ctn. Qty.
786-1	1-1/4" x 6"	Extension Tube w/ Solder Joint - Budget Ga.	10
786A-1	1-1/4" x 8"	Extension Tube w/ Solder Joint - Budget Ga.	10
787A-1	1-1/4" x 12"	Extension Tube w/ Solder Joint - Budget Ga.	10
787A-17-1	1-1/4" x 12"	Extension Tube w/ Solder Joint - 17 Ga.	10 (NSE)
788A-1	1-1/2" x 8"	Extension Tube w/ Solder Joint - Budget Ga.	10
789A-1	1-1/2" x 12"	Extension Tube w/ Solder Joint - Budget Ga.	10
789A-17-1	1-1/2" x 12"	Extension Tube w/ Solder Joint - 17 Ga.	10 (NSE)
789A-17-3	1-1/2" x 12"	Extension Tube w/ Solder Joint - 17 Ga., Unfinished	10 (NSE)



#819-1 shown



#798-1 shown

Extension Tubes with Threaded Joint

Product No.	Size	Description	Ctn. Qty.
819-1	1-1/4" x 6"	Extension Tube, Threaded Both Ends - 20 Ga.	10
820A-1	1-1/4" x 8"	Extension Tube, Threaded Both Ends - 20 Ga.	10
822-1	1-1/4" x 12"	Extension Tube, Threaded Both Ends - 20 Ga.	10
822-3	1-1/4" x 12"	Extension Tube, Threaded Both Ends - 20 Ga., Unfinished	10
820C-1	1-1/4" x 8"	Extension Tube, Threaded Both Ends - 17 Ga.	10
822A-1	1-1/4" x 12"	Extension Tube, Threaded Both Ends - 17 Ga.	10
822A-3	1-1/4" x 12"	Extension Tube, Threaded Both Ends - 17 Ga., Unfinished	10
824-1	1-3/8" x 12"	Extension Tube, Threaded Both Ends - 17 Ga.	10
828-1	1-1/2" x 6"	Extension Tube, Threaded Both Ends - 20 Ga.	10
825A-1	1-1/2" x 8"	Extension Tube, Threaded Both Ends - 20 Ga.	10
827-1	1-1/2" x 12"	Extension Tube, Threaded Both Ends - 20 Ga.	10
827-3	1-1/2" x 12"	Extension Tube, Threaded Both Ends - 20 Ga., Unfinished	10
827A-1	1-1/2" x 12"	Extension Tube, Threaded Both Ends - 17 Ga.	10
827A-3	1-1/2" x 12"	Extension Tube, Threaded Both Ends - 17 Ga., Unfinished	10
803A-1	1-1/2" x 1-1/4" x 8"	Extension Tube, Threaded One End - 17 Ga.	10

Flanged Strainer Tailpieces

Product No.	Size	Description	Ctn. Qty.
795-1	1-1/2" x 1-1/4" x 6"	Flanged Strainer Tailpiece - 20 Ga.	10 
796-1	1-1/2" x 1-1/4" x 8"	Flanged Strainer Tailpiece - 20 Ga.	10 
798-1	1-1/2" x 1-1/4" x 12"	Flanged Strainer Tailpiece - 20 Ga.	10 
799-1	1-1/2" x 4"	Flanged Strainer Tailpiece - Budget Ga.	10
799-3	1-1/2" x 4"	Flanged Strainer Tailpiece - Budget Ga., Unfinished	10
800-1	1-1/2" x 6"	Flanged Strainer Tailpiece - Budget Ga.	10
801-1	1-1/2" x 8"	Flanged Strainer Tailpiece - Budget Ga.	10
803-1	1-1/2" x 12"	Flanged Strainer Tailpiece - Budget Ga.	10
803BD-1	1-1/2" x 12"	Double Flanged Strainer Tailpiece - Budget Ga.	10
803ED-1	1-1/2" x 16"	Double Flanged Strainer Tailpiece - Budget Ga.	10
800-20-1	1-1/2" x 6"	Flanged Strainer Tailpiece - 20 Ga.	10 
801-20-1	1-1/2" x 8"	Flanged Strainer Tailpiece - 20 Ga.	10 
801-20-3	1-1/2" x 8"	Flanged Strainer Tailpiece - 20 Ga., Unfinished	10 
803-20-1	1-1/2" x 12"	Flanged Strainer Tailpiece - 20 Ga.	10 
803-20-3	1-1/2" x 12"	Flanged Strainer Tailpiece - 20 Ga., Unfinished	10 
803ED-20-1	1-1/2" x 16"	Double Flanged Strainer Tailpiece - 20 Ga.	10 
803ED-20-3	1-1/2" x 16"	Double Flanged Strainer Tailpiece - 20 Ga., Unfinished	10 
799-17-1	1-1/2" x 4"	Flanged Strainer Tailpiece -17 Ga.	10 
799-17-3	1-1/2" x 4"	Flanged Strainer Tailpiece, 17 Ga., Unfinished	10 
800-17-1	1-1/2" x 6"	Flanged Strainer Tailpiece -17 Ga.	10 
800-17-3	1-1/2" x 6"	Flanged Strainer Tailpiece -17 Ga., Unfinished	10 
801-17-1	1-1/2" x 8"	Flanged Strainer Tailpiece -17 Ga.	10 
801-17-3	1-1/2" x 8"	Flanged Strainer Tailpiece -17 Ga., Unfinished	10 
803-17-1	1-1/2" x 12"	Flanged Strainer Tailpiece -17 Ga.	10 
803-17-3	1-1/2" x 12"	Flanged Strainer Tailpiece -17 Ga., Unfinished	10 
803ED-17-1	1-1/2" x 16"	Double Flanged Strainer Tailpiece -17 Ga.	10 
803ED-17-3	1-1/2" x 16"	Double Flanged Strainer Tailpiece -17 Ga., Unfinished	10 





#812B-1 shown



#814B-1 shown



#814TB-1 shown

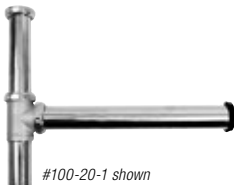

#100-20-1 shown



#1046-1 shown

Branch Tailpieces

Product No.	Size	Description	Ctn. Qty.
812A-1	1-1/2" x 6"	Branch Tailpiece, 1/2" Nominal Sweat Branch, Budget Ga.	10
812B-1	1-1/2" x 8"	Branch Tailpiece, 1/2" Nominal Sweat Branch, Budget Ga.	10
812B-3	1-1/2" x 8"	Branch Tailpiece, 1/2" Nominal Sweat Branch, Budget Ga., Unfinished	10
812B-17BN-3	1-1/2" x 8"	Branch Tailpiece DC, 1/2" Nominal Sweat Branch, 17 Ga. w/ Brass Nut, Unfinished	10 (NSE)
813B-1	1-1/2" x 8"	Branch Tailpiece, 3/4" Hose or 1/2" Nominal Sweat, Budget Ga.	10
814A-1	1-1/2" x 6"	Branch Tailpiece, Hose & Clamp - Budget Ga.	10
814B-1	1-1/2" x 8"	Branch Tailpiece, Hose & Clamp - Budget Ga.	10
814BBN-1	1-1/2" x 8"	Branch Tailpiece, Hose & Clamp w/ Brass Nuts - 20 Ga.	10 (NSE)
814B-17-1	1-1/2" x 8"	Branch Tailpiece, Hose & Clamp - 17 Ga.	10 (NSE)
814TA-1	1-1/2" x 6"	Branch Tailpiece, Hose & Clamp, Threaded Top - 20 Ga.	10 (NSE)
814TB-1	1-1/2" x 8"	Branch Tailpiece, Hose & Clamp, Threaded Top - 20 Ga.	10 (NSE)
817TB-1	1-1/4" x 8"	Branch Tailpiece, Hose & Clamp, Threaded Top - 20 Ga., 7/8" Branch	10 (NSE)
814ET-1	1-1/2" x 8"	Branch Tailpiece, Hose & Clamp, Slip Joint Top - 20 Ga., 7/8" Branch (Nut Down)	10 (NSE)
814ETBN-1	1-1/2" x 8"	Branch Tailpiece, Hose & Clamp, Slip Joint Top, 20 Ga. w/ Brass Nut, 7/8" Branch (Nut Down)	10 (NSE)
814ETBN-3	1-1/2" x 8"	Branch Tailpiece, Hose & Clamp, Slip Joint Top - 20 Ga. w/ Brass Nut, 7/8" Branch (Nut Down), Unfinished	10 (NSE)
814ET-17-1	1-1/2" x 8"	Branch Tailpiece, Hose & Clamp, Slip Joint Top - 17 Ga., 7/8" Branch (Nut Down)	10 (NSE)
817ET-1	1-1/4" x 8"	Branch Tailpiece, Hose & Clamp, Slip Joint Top - 20 Ga., (Nut Down)	10 (NSE)
817ETBN-1	1-1/4" x 8"	Branch Tailpiece, Hose & Clamp, Slip Joint Top - 20 Ga. w/ Brass Nut (Nut Down)	10 (NSE)
817ETBN-3	1-1/4" x 8"	Branch Tailpiece, Hose & Clamp, Slip Joint Top - 20 Ga. w/ Brass Nut, Unfinished (Nut Down)	10 (NSE)

Trap Primer Tailpieces

Product No.	Size	Description	Ctn. Qty.
831-1	1-1/4"	Trap Primer Tailpiece - 17 Ga.	10
832-1	1-1/2"	Trap Primer Tailpiece w/Captured Nut - 17 Ga.	10

Disposer Kits

Product No.	Size	Description	Ctn. Qty.
100-22-1	1-1/2" x 13"	Center to End Disposer Kit - Budget Ga.	10
100-20-1	1-1/2" x 13"	Center to End Disposer Kit - 20 Ga.	10 (NSE)
100-17-1	1-1/2" x 13"	Center to End Disposer Kit - 17 Ga.	10 (NSE)

Double Slip Joint Trap Offset

Product No.	Size	Description	Ctn. Qty.
1046-1	1-1/4"	Double Slip Joint Trap Offset - 20 Ga.	5
1046-17BN-1	1-1/4"	Double Slip Joint Trap Offset - 17 Ga. w/ Brass Nuts	5
1046A-1	1-1/2"	Double Slip Joint Trap Offset - 20 Ga.	5
1046ABN-1	1-1/2"	Double Slip Joint Trap Offset - 20 Ga. w/ Brass Nuts	5
1046A-17BN-1	1-1/2"	Double Slip Joint Trap Offset - 17 Ga. w/ Brass Nuts	5
H1046A-17-3	1-1/2"	Double Slip Joint Trap Offset - 17 Ga. Unfinished, Cutcase Box	6



#793BD-20BN-1 shown

Double Slip Joint Extension Tubes

Product No.	Size	Description	Ctn. Qty.
791B-1	1-1/4" x 12"	Double Slip Joint Extension Tube - Budget Ga.	5
791BD-1	1-1/4" x 16"	Double Slip Joint Extension Tube - Budget Ga.	5
791BD-20BN-1	1-1/4" x 16"	Double Slip Joint Extension Tube - 20 Ga. w/ Brass Nuts	5 (NSE)
793B-1	1-1/2" x 12"	Double Slip Joint Extension Tube - Budget Ga.	5
793BD-1	1-1/2" x 16"	Double Slip Joint Extension Tube - Budget Ga.	5
793BD-20BN-1	1-1/2" x 16"	Double Slip Joint Extension Tube - 20 Ga. w/ Brass Nuts	5 (NSE)
793BD-20BN-3	1-1/2" x 16"	Double Slip Joint Extension Tube - 20 Ga. w/ Brass Nuts, Unfinished	5 (NSE)



Double Slip Joint Connections

Product No.	Size	Description	Ctn. Qty.
793C-1	1-1/4" x 2"	Double Slip Joint Connection - 20 Ga.	10
793D-1	1-1/2" x 2"	Double Slip Joint Connection - 20 Ga.	10



Slip Joint Connections

Product No.	Size	Description	Ctn. Qty.
8482	1-1/4"	90 Degree Slip Joint Elbow, Chrome - 20 Ga.	5
8483	1-1/2"	90 Degree Slip Joint Elbow, Chrome - 20 Ga.	5



8477	1-1/4"	45 Degree Slip Joint Elbow, Chrome - 20 Ga.	5
8478	1-1/2"	45 Degree Slip Joint Elbow, Chrome - 20 Ga.	5



8480	1-1/4"	Tee Slip Joint, Chrome - 20 Ga.	5
8481	1-1/2"	Tee Slip Joint, Chrome - 20 Ga.	5



#758-1 shown

Pop-Up Assemblies

Product No.	Size	Description	Ctn. Qty.
758-1	1-1/4"	Pop-Up Assembly, 2 Piece, Chrome	10
758U-3	1-1/4"	Pop-Up Assembly, 2 Piece, UltraShine® Polished Brass	10
759-1	1-1/4"	Pop-Up Assembly, 1 Piece, Chrome - 20 Ga.	10
759PB-3	1-1/4"	Pop-Up Assembly, 1 Piece, Polished Brass - 20 Ga.	12



#2764A-1 shown

Patent Overflow & Center Outlet Plugs

Product No.	Size	Description	Ctn. Qty.
2763-1	1-1/4" x 5"	Patent Overflow Plug Ind. Boxed 1 Pc. - 20 Ga.	10
2764A-1	1-1/4" x 8"	Patent Overflow Plug Ind. Boxed 1 Pc. - 20 Ga.	10
2765-1	1-1/4" x 12"	Patent Overflow Plug Ind. Boxed 1 Pc. - 20 Ga.	10
763-1	1-1/4" x 5"	Patent Overflow Plug Ind. Boxed 2 Pc. - 20 Ga.	10
763K-1	1-1/4" x 5"	Center Outlet Plug Ind. Boxed 2 Pc. Less Overflow - 20 Ga.	10
764-1	1-1/4" x 6"	Patent Overflow Plug Ind. Boxed 2 Pc. - 20 Ga.	10
764A-1	1-1/4" x 8"	Patent Overflow Plug Ind. Boxed 2 Pc. - 20 Ga.	10
765-1	1-1/4" x 12"	Patent Overflow Plug Ind. Boxed 2 Pc. - 20 Ga.	10



#1033D-1 shown

Closet Flush Elbows

Product No.	Size	Description	Ctn. Qty.
1032D-1	2" x 4" x 6"	Closet Flush Elbow - 20 Ga.	5
1032AD-1	2" x 5" x 7"	Closet Flush Elbow - 20 Ga.	5
1032ADBN-1	2" x 5" x 7"	Closet Flush Elbow - 20 Ga. w/ Brass Nuts	5
1033D-1	2" x 6" x 8"	Closet Flush Elbow - 20 Ga.	5
1033DBN-1	2" x 6" x 8"	Closet Flush Elbow - 20 Ga. w/ Brass Nuts	5

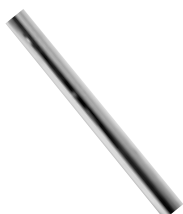

Brass Tubing

Product No.	Size	Description	Ctn. Qty.
1138-1	1-1/4" x 6'	Brass Tubing - 17 Ga., Boxed	1
1142-1	1-1/2" x 6'	Brass Tubing - 17 Ga., Boxed	1
1139-1	1-3/8" x 6'	Brass Tube - Budget (Cover 1" I.P.), Boxed	1



Bell Flange Cover Tube

Product No.	Size	Description	Ctn. Qty.
780-1	6"	Bell Flange Escutcheon, covers 1-1/2" Schedule 40 Pipe	10



Semi-Cast P-Traps w/ Cleanout

Product No.	Size	Description	Ctn. Qty.
507-1	1-1/4" x 12"	Semi-Cast P-Trap w/ Cleanout 17 Ga. w/ Deep Flange & Brass Nuts	12
5507-1	1-1/4" x 12"	Semi-Cast P-Trap w/ Cleanout 17 Ga. w/ Deep Flange & Brass Nuts, White Box	12
5507A-1	1-1/4" x 15"	Semi-Cast P-Trap w/ Cleanout 17 Ga. w/ Deep Flange & Brass Nuts	12
510-1	1-1/2" x 12"	Semi-Cast P-Trap w/ Cleanout 17 Ga. w/ Deep Flange & Brass Nuts	12
5510-1	1-1/2" x 12"	Semi-Cast P-Trap w/ Cleanout 17 Ga. w/ Deep Flange & Brass Nuts, White Box	12
5510A-1	1-1/2" x 15"	Semi-Cast P-Trap w/ Cleanout 17 Ga. w/ Deep Flange & Brass Nuts	12
505-1	1-1/4" x 10"	Semi-Cast P-Trap w/ Cleanout 17 Ga. w/ Shallow Flange & Zinc Nuts	12
509-1	1-1/2" x 11"	Semi-Cast P-Trap w/ Cleanout 17 Ga. w/ Shallow Flange & Zinc Nuts	12



Cast Grid Patent Outlet Plugs

Product No.	Size	Description	Ctn. Qty.
760-1		Semi-Cast Grid Patent Overflow Plug w/ 1-1/4" x 6" - 17 Ga. Tailpiece	25
761-1		Semi-Cast Grid Patent Overflow Plug w/ 1-1/2" x 6" - 17 Ga. Tailpiece	25
760W-1		Semi-Cast Grid Wheelchair Patent Overflow Plug w/ 1-1/4" - 17 Ga. Tailpiece	10



Cover Traps

Product No.	Size	Description	Ctn. Qty.
515FLX-3	3/8" - 1/2"	Supply Line/Stop Cover Trap	1



515FST-3	1-1/4" - 1-1/2"	Offset Cover Trap	1
----------	-----------------	-------------------	---



515KIT-3		Cover Trap Kit, (1) P-Trap & (2) Supply Line Covers	1
----------	--	---	---

515TRP-3	1-1/4" - 1-1/2"	P-Trap Cover	1
----------	-----------------	--------------	---

515KOF-3		Cover Trap Kit, (1) P-Trap, (2) Supply Line Covers & (1) Offset Cover	1
----------	--	---	---



Cast Brass Flanges w/Set Screw

Product No.	Size	Description	Ctn. Qty.
1119-1	3/8"	NPT Cast Brass Flange w/ Set Screw	12
1119A-1	1/2"	NPT Cast Brass Flange w/ Set Screw	12
1119D-1	5/8"	O.D. Cast Brass Flange w/ Set Screw	12
1120E-1	1-1/2"	NPT Cast Brass Flange w/ Set Screw	12
1121A-1	1-1/4"	O.D. Cast Brass Deep Flange w/ Set Screw	12
1121B-1	1-1/2"	O.D. Cast Brass Deep Flange w/ Set Screw	12



Cast Brass Fittings

Product No.	Size	Description	Ctn. Qty.
1674-2	1-1/4"	90 Degree Cast Brass Slip Joint Elbow	6
1675-2	1-1/2"	90 Degree Cast Brass Slip Joint Elbow	6



1679-2	1-1/2"	Cast Brass Slip Joint Tee	6
--------	--------	---------------------------	---



1664SL-2	1-1/4"	45 Degree Cast Brass Solder Elbow	6
----------	--------	-----------------------------------	---

1665SL-2	1-1/2"	45 Degree Cast Brass Solder Elbow	6
----------	--------	-----------------------------------	---

1667SL-2	1-1/2"	90 Degree Cast Brass Solder Elbow	6
----------	--------	-----------------------------------	---



Grab Bars with Exposed Flanges, Satin Finish

Product No.	Size	Description	Ctn. Qty.
DB7416	1-1/4" x 16"	Stainless Steel Grab Bar w/ Exposed Flange, Satin Finish	4
DB7424	1-1/4" x 24"	Stainless Steel Grab Bar w/ Exposed Flange, Satin Finish	4
DB7436	1-1/4" x 36"	Stainless Steel Grab Bar w/ Exposed Flange, Satin Finish	4
DB7442	1-1/4" x 42"	Stainless Steel Grab Bar w/ Exposed Flange, Satin Finish	4
DB7512	1-1/2" x 12"	Stainless Steel Grab Bar w/ Exposed Flange, Satin Finish	4
DB7518	1-1/2" x 18"	Stainless Steel Grab Bar w/ Exposed Flange, Satin Finish	4
DB7524	1-1/2" x 24"	Stainless Steel Grab Bar w/ Exposed Flange, Satin Finish	4
DB7530	1-1/2" x 30"	Stainless Steel Grab Bar w/ Exposed Flange, Satin Finish	4
DB7532	1-1/2" x 32"	Stainless Steel Grab Bar w/ Exposed Flange, Satin Finish	4
DB7536	1-1/2" x 36"	Stainless Steel Grab Bar w/ Exposed Flange, Satin Finish	4
DB7542	1-1/2" x 42"	Stainless Steel Grab Bar w/ Exposed Flange, Satin Finish	4
DB7548	1-1/2" x 48"	Stainless Steel Grab Bar w/ Exposed Flange, Satin Finish	4



Grab Bars with Concealed Flanges, Satin Finish

Product No.	Size	Description	Ctn. Qty.
DB8712	1-1/4" x 12"	Stainless Steel Grab Bar w/ Concealed Flange, Satin Finish	4
DB8716	1-1/4" x 16"	Stainless Steel Grab Bar w/ Concealed Flange, Satin Finish	4
DB8718	1-1/4" x 18"	Stainless Steel Grab Bar w/ Concealed Flange, Satin Finish	4
DB8724	1-1/4" x 24"	Stainless Steel Grab Bar w/ Concealed Flange, Satin Finish	4
DB8730	1-1/4" x 30"	Stainless Steel Grab Bar w/ Concealed Flange, Satin Finish	4
DB8732	1-1/4" x 32"	Stainless Steel Grab Bar w/ Concealed Flange, Satin Finish	4
DB8736	1-1/4" x 36"	Stainless Steel Grab Bar w/ Concealed Flange, Satin Finish	4
DB8742	1-1/4" x 42"	Stainless Steel Grab Bar w/ Concealed Flange, Satin Finish	4
DB8748	1-1/4" x 48"	Stainless Steel Grab Bar w/ Concealed Flange, Satin Finish	4
DB8912	1-1/2" x 12"	Stainless Steel Grab Bar w/ Concealed Flange, Satin Finish	4
DB8916	1-1/2" x 16"	Stainless Steel Grab Bar w/ Concealed Flange, Satin Finish	4
DB8918	1-1/2" x 18"	Stainless Steel Grab Bar w/ Concealed Flange, Satin Finish	4
DB8924	1-1/2" x 24"	Stainless Steel Grab Bar w/ Concealed Flange, Satin Finish	4
DB8930	1-1/2" x 30"	Stainless Steel Grab Bar w/ Concealed Flange, Satin Finish	4
DB8932	1-1/2" x 32"	Stainless Steel Grab Bar w/ Concealed Flange, Satin Finish	4
DB8936	1-1/2" x 36"	Stainless Steel Grab Bar w/ Concealed Flange, Satin Finish	4
DB8942	1-1/2" x 42"	Stainless Steel Grab Bar w/ Concealed Flange, Satin Finish	4
DB8948	1-1/2" x 48"	Stainless Steel Grab Bar w/ Concealed Flange, Satin Finish	4



Grab Bars with Concealed Flanges, Peened Finish

Product No.	Size	Description	Ctn. Qty.
DB8712P	1-1/4" x 12"	Stainless Steel Grab Bar w/ Concealed Flange, Peened Finish	4
DB8716P	1-1/4" x 16"	Stainless Steel Grab Bar w/ Concealed Flange, Peened Finish	4
DB8724P	1-1/4" x 24"	Stainless Steel Grab Bar w/ Concealed Flange, Peened Finish	4
DB8736P	1-1/4" x 36"	Stainless Steel Grab Bar w/ Concealed Flange, Peened Finish	4
DB8742P	1-1/4" x 42"	Stainless Steel Grab Bar w/ Concealed Flange, Peened Finish	4
DB8912P	1-1/2" x 12"	Stainless Steel Grab Bar w/ Concealed Flange, Peened Finish	4
DB8918P	1-1/2" x 18"	Stainless Steel Grab Bar w/ Concealed Flange, Peened Finish	4
DB8924P	1-1/2" x 24"	Stainless Steel Grab Bar w/ Concealed Flange, Peened Finish	4
DB8932P	1-1/2" x 32"	Stainless Steel Grab Bar w/ Concealed Flange, Peened Finish	4
DB8936P	1-1/2" x 36"	Stainless Steel Grab Bar w/ Concealed Flange, Peened Finish	4
DB8942P	1-1/2" x 42"	Stainless Steel Grab Bar w/ Concealed Flange, Peened Finish	4
DB8948P	1-1/2" x 48"	Stainless Steel Grab Bar w/ Concealed Flange, Peened Finish	4



1-1/4" P-Traps

Product No.	Size	Description	Ctn. Qty.
P9701	1-1/4"	P-Trap	25
P9701BG	1-1/4"	P-Trap, Bagged	25
P9701DFB	1-1/4"	P-Trap w/ Deep Flange, Bagged	25
P9701B	1-1/4"	P-Trap less Flange, Bagged	25
P9700	1-1/4"	Choked Throat Outlet P-Trap w/ 1-1/2" Inlet	25
P9700BG	1-1/4"	Choked Throat Outlet P-Trap w/ 1-1/2" Inlet, Bagged	25
P9701PBDFB	1-1/4"	P-Trap w/ Deep Flange, Polished Brass Finish, Bagged	25
A9701BG	1-1/4"	P-Trap, Bagged	25



#P9702 shown

1-1/2" P-Traps W/ Solvent Weld Adapter

Product No.	Size	Description	Ctn. Qty.
P9702	1-1/2"	P-Trap w/ PVC Quarter Bend & Solvent Weld Adapter	25
P9702B	1-1/2"	P-Trap w/ PVC Quarter Bend & Solvent Weld Adapter, Bagged	50
P9702DF	1-1/2"	P-Trap w/ PVC Quarter Bend, Solvent Weld Adapter & Deep Flange	25
P9702DFB	1-1/2"	P-Trap w/ PVC Quarter Bend, Solvent Weld Adapter & Deep Flange, Bagged	50
P9702T	1-1/2"	P-Trap w/ PVC Quarter Bend & Threaded PVC Adapter	25

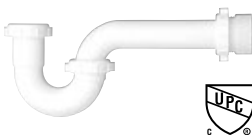

1-1/2" P-Trap W/ Reversible J-Bend

Product No.	Size	Description	Ctn. Qty.
P9703BG	1-1/2"	P-Trap w/ Threaded PVC Adapter & Reversible J-Bend, Bagged	25
P9703W	1-1/2"	P-Trap with Threaded PVC Adapter and Reversible J-Bend in a Carton w/ True Blue Washer	25
P9703WBG	1-1/2"	P-Trap with Threaded PVC Adapter, and Reversible J-Bend, Bagged w/ True Blue Washer	50
A9703WBG	1-1/2"	P-Trap with Threaded ABS Adapter, and Reversible J-Bend, Bagged w/ True Blue Washer	50



1-1/2" P-Traps W/ Threaded Adapter

Product No.	Size	Description	Ctn. Qty.
P9704	1-1/2"	P-Trap w/ Threaded PVC Adapter	25
P9704A	1-1/2"	P-Trap (White) w/ Threaded ABS Adapter	25
P9704AB	1-1/2"	P-Trap (White) w/ Threaded ABS Adapter, Bagged	50
P9704BG	1-1/2"	P-Trap w/ Threaded PVC Adapter, Bagged	50
P9704DF	1-1/2"	P-Trap w/ Threaded PVC Adapter & Deep Flange	25
P9704DFB	1-1/2"	P-Trap w/ Threaded PVC Adapter & Deep Flange, Bagged	50
A9704	1-1/2"	P-Trap w/ Threaded ABS Adapter	25
A9704B	1-1/2"	P-Trap w/ Threaded ABS Adapter, Bagged	50
A9704DF	1-1/2"	P-Trap w/ Threaded ABS Adapter & Deep Flange	25



Plastic J-Bends

Product No.	Size	Description	Ctn. Qty.
HP9650BG	1-1/4"	J-Bend, Printed Bag, Display Box	12
HDP9651B	1-1/2"	J-Bend, Printed Bag, Display Box	12

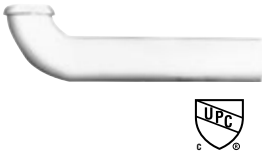

Plastic Wall Tube

Product No.	Size	Description	Ctn. Qty.
HP9005	1-1/4"	Wall Tube, Display Box, Ind. UPC	20
HP9006	1-1/2"	Wall Tube, Display Box, Ind. UPC	12



Repair Traps

Product No.	Size	Description	Ctn. Qty.
P9702R	1-1/2"	Repair Trap w/ 1-1/2" or 1-1/4" Washer	25
HD2661C	1-1/2"	Repair Trap w/ Compression Elbow & 1-1/2" or 1-1/4" Washer, Printed Bag, Display Box	12









#P9718 shown

S-Traps

Product No.	Size	Description	Ctn. Qty.
P9718	1-1/4"	S-Trap w/ PVC Solvent Weld Adapter	25
P9720	1-1/2"	S-Trap w/ PVC Solvent Weld Adapter	25
P9722	1-1/2"	S-Trap w/ PVC Threaded Adapter	25
P9722BG	1-1/2"	S-Trap w/ PVC Threaded Adapter, Bagged	10
P9722W	1-1/2"	S-Trap w/ PVC Threaded Adapter w/ True Blue Washer	25
A9722	1-1/2"	S-Trap w/ ABS Threaded Adapter	25

Repair J-Bend

Product No.	Size	Description	Ctn. Qty.
HP9654	1-1/2"	Repair J-Bend w/ 1-1/2" or 1-1/4" Washer, Printed Bag, Display Box	12

		End Outlet Waste			
		Product No.	Size	Description	Ctn. Qty.
  #P9108A shown		P9108A	1-1/2" x 16"	Center to Center, Slip Joint w/ Baffle Tee	25
		P9108AB	1-1/2" x 16"	Center to Center, Slip Joint w/ Baffle Tee, Bagged	25
		P9108B	1-1/2" x 21"	Center to Center, Slip Joint w/ Baffle Tee	25
		P9108AT	1-1/2" x 11"-17"	Slip Joint w/ Telescopic Waste Arm	25
		P9108ATB	1-1/2" x 11"-17"	Slip Joint w/ Telescopic Waste Arm, Bagged	25
		P9108AWB	1-1/2" X 16"	Center to Center, Slip Joint with Baffle Tee, Bagged w/ True Blue Washer	25
  #P9108AT shown		P9121	1-1/2" x 16"	Center to Center, Hi-Line w/ Baffle Tee	25
		P9121A	1-1/2" x 16"	Center to Center, Hi-Line/ Slip Joint Combination w/ Baffle Tee	25
		P9121ABG	1-1/2" x 16"	Center to Center, Hi-Line/ Slip Joint Combination w/ Baffle Tee, Bagged	25
		P9121B	1-1/2" x 21"	Center to Center, Hi-Line/ Slip Joint Combination w/ Baffle Tee	25
		P9121AT	1-1/2" x 11"-17"	Hi-Line/Slip Joint Combination w/ Telescopic Waste Arm	25
		P9121ATBG	1-1/2" x 11"-17"	Hi-Line/Slip Joint Combination w/ Telescopic Waste Arm, Bagged	25
  #P9121A shown		P9121ATWBG	1-1/2" X 11"-17"	Hi-Line/Slip Joint Combination w/ Telescopic Waste Arm, Bagged w/ True Blue Washer	25
		P9121AT-8	1-1/2" x 11"-17"	Hi-Line/Slip Joint Combination w/ Telescopic Waste Arm & 1/2" Branch	25
		P9121AT-12	1-1/2" x 11"-17"	Hi-Line/Slip Joint Combination w/ Telescopic Waste Arm & 3/4" Branch	25
		P9121T	1-1/2" x 21"	End Outlet Waste Hi-Line w/Telescopic Tee	25
		A9108A	1-1/2" x 16"	Center to Center, Slip Joint w/ Baffle Tee	25
		A9108AB	1-1/2" x 16"	Center to Center, Slip Joint w/ Baffle Tee, Bagged	25
		A9108AWB	1-1/2" X 16"	Center to Center, Slip Joint with Baffle Tee, Bagged w/ True Blue Washer	25
		A9108AT	1-1/2" x 11"-17"	Slip Joint w/ Telescopic Waste Arm	25
		A9108ATB	1-1/2" x 11"-17"	Slip Joint w/ Telescopic Waste Arm, Bagged	25
		A9108B	1-1/2" x 21"	Center to Center, Slip Joint w/ Baffle Tee	25
	A9121	1-1/2" x 16"	Center to Center, Hi-Line w/ Baffle Tee	25	
	A9121A	1-1/2" x 16"	Center to Center, Hi-Line/ Slip Joint Combination w/ Baffle Tee	25	
	A9121AWB	1-1/2" x 16"	Center to Center, Hi-Line/ Slip Joint Combination w/ Baffle Tee w/ True Blue Washer	25	
	A9121AT	1-1/2" x 11"-17"	Hi-Line/Slip Joint Combination w/ Telescopic Waste Arm	25	



#P9123A shown



Center Outlet Waste w/ Baffle Tee

Product No.	Size	Description	Ctn. Qty.
P9114A	1-1/2" x 16"	Center to Center, Slip Joint w/ Baffle Tee	25
P9114AB	1-1/2" x 16"	Center to Center, Slip Joint w/ Baffle Tee	25
P9123	1-1/2" x 16"	Center to Center, Hi-Line w/ Baffle Tee	25
P9123A	1-1/2" x 16"	Center to Center, Hi-Line/Slip Joint Combination w/ Baffle Tee	25
P9123ABG	1-1/2" x 16"	Center to Center, Hi-Line/Slip Joint Combination w/ Baffle Tee, Bagged	25
P9123AW	1-1/2" X 16"	Center to Center, Hi-Line/Slip Joint Combination with Baffle Tee, Bagged w/ True Blue Washer	25
P9123B	1-1/2" x 21"	Center to Center, Hi-Line/Slip Joint Combination w/ Baffle Tee	25
A9114A	1-1/2" x 16"	Center to Center, Slip Joint w/ Baffle Tee	25
A9123A	1-1/2" x 16"	Center to Center, Hi-Line/Slip Joint Combination w/ Baffle Tee	25
A9123AW	1-1/2" X 16"	Center to Center, Hi-Line/Slip Joint Combination with Baffle Tee, Bagged w/ True Blue Washer	25



#P9185 shown

#P9186 shown



Baffle Tees

Product No.	Size	Description	Ctn. Qty.
P9185	1-1/2"	Baffle Tee, For Slip Joint End Outlet Waste	25
P9185W	1-1/2"	Baffle Tee, For Slip Joint End Outlet Waste w/ True Blue Washer	25
P9186	1-1/2"	Baffle Tee, For Slip Joint Center Outlet Waste	25
P9187	1-1/2"	Baffle Tee, For Hi-Line End Outlet Waste	25
A9185	1-1/2"	Baffle Tee, For Slip Joint End Outlet Waste	25
A9185W	1-1/2"	Baffle Tee, For Slip Joint End Outlet Waste w/ True Blue Washer	25

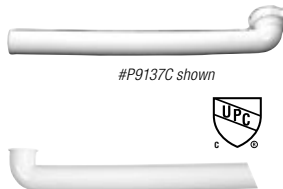

#P9137C shown



#P9138C shown

Waste Arms

Product No.	Size	Description	Ctn. Qty.
P9137	1-1/2" x 7"	Waste Arm w/ Slip Joint	25
P9137C	1-1/2" x 15"	Waste Arm w/ Slip Joint	25
P9137D	1-1/2" x 20"	Waste Arm w/ Slip Joint	25
P9138C	1-1/2" x 15"	Waste Arm w/ Hi-Line	25
A9137C	1-1/2" x 15"	Waste Arm w/ Slip Joint	25
A9138C	1-1/2" x 15"	Waste Arm w/ Hi-Line	25



#P9787A shown

Extension Tubes with Solvent Weld Joint

Product No.	Size	Description	Ctn. Qty.
P9786A	1-1/2" x 8"	Solvent Weld Extension Tube, PVC	25
P9787A	1-1/2" x 12"	Solvent Weld Extension Tube, PVC	25
P9787E	1-1/2" x 16"	Double Connect Solvent Weld Extension Tube, PVC	25
A9786A	1-1/2" x 8"	Solvent Weld Extension Tube, ABS	25
A9787A	1-1/2" x 12"	Solvent Weld Extension Tube, ABS	25
A9787E	1-1/2" x 16"	Double Connect Solvent Weld Extension Tube, ABS	25
HP9786	1-1/2" x 6"	Solvent Weld Extension Tube, PVC, Display Box, Ind. UPC	12



#P9790 shown



Extension Tubes with Slip Joint

Product No.	Size	Description	Ctn. Qty.
P9790	1-1/4" x 6"	Slip Joint Extension Tube	25
P9791A	1-1/4" x 12"	Slip Joint Extension Tube	25
P9791E	1-1/4" x 16"	Double Connect Slip Joint Extension Tube	25
P9792	1-1/2" x 6"	Slip Joint Extension Tube	25
P9792A	1-1/2" x 8"	Slip Joint Extension Tube	25
P9792AW	1-1/2" X 8"	Slip Joint Extension Tube w/ True Blue Washer	25
P9793A	1-1/2" x 12"	Slip Joint Extension Tube	25
P9793AC	1-1/2" x 12"	Slip Joint Extension Tube, PVC	25
P9793E	1-1/2" x 16"	Double Connect Slip Joint Extension Tube	25
P9793EC	1-1/2" x 16"	Double Connect Slip Joint Extension Tube, PVC	25
P9793EW	1-1/2" X 16"	Double Connect Slip Joint Extension Tube w/ True Blue Washer	25
A9791E	1-1/4" x 16"	Double Connect Slip Joint Extension Tube	25
A9792	1-1/2" x 6"	Slip Joint Extension Tube	25
A9792A	1-1/2" x 8"	Slip Joint Extension Tube	25
A9792AW	1-1/2" X 8"	Slip Joint Extension Tube w/ True Blue Washer	25
A9793A	1-1/2" x 12"	Slip Joint Extension Tube	25
A9793E	1-1/2" x 16"	Double Connect Slip Joint Extension Tube	25
A9793EW	1-1/2" X 16"	Double Connect Slip Joint Extension Tube w/ True Blue Washer	25



#P9799 shown



Flanged Strainer Tailpieces

Product No.	Size	Description	Ctn. Qty.
P9799	1-1/2" x 4"	Flanged Strainer Tailpiece	25
P9800	1-1/2" x 6"	Flanged Strainer Tailpiece	25
P9801	1-1/2" x 8"	Flanged Strainer Tailpiece	25
P9803	1-1/2" x 12"	Flanged Strainer Tailpiece	25
P9803C	1-1/2" x 12"	Flanged Strainer Tailpiece, PVC	25
P9803E	1-1/2" x 16"	Double Flanged Strainer Tailpiece	25
P9803EC	1-1/2" x 16"	Double Flanged, Strainer Tailpiece, PVC	25
A9799	1-1/2" x 4"	Flanged Strainer Tailpiece	25
A9800	1-1/2" x 6"	Flanged Strainer Tailpiece	25
A9801	1-1/2" x 8"	Flanged Strainer Tailpiece	25
A9803	1-1/2" x 12"	Flanged Strainer Tailpiece	25
A9803E	1-1/2" x 16"	Double Flanged Strainer Tailpiece	25



Branch Tailpieces

Product No.	Size	Description	Ctn. Qty.
PP9816	1-1/2" x 8"	Branch Tailpiece, Slip Joint Top w/ 1/2" Branch	25
PP9816BD	1-1/2" x 8"	Branch Tailpiece, Hi-Line/ Slip Joint Combination w/ 1/2" Branch	25
PP9816W	1-1/2" x 8"	Branch Tailpiece, Slip Joint Top w/ 1/2" Branch w/ True Blue Washer	25
PP9817	1-1/2" x 8"	Branch Tailpiece, Slip Joint Top w/ 3/4" Branch	25
PP9817BD	1-1/2" x 8"	Branch Tailpiece, Hi-Line/ Slip Joint Combination Top w/ 3/4" Branch	25
PP9817W	1-1/2" x 8"	Branch Tailpiece, Slip Joint Top w/ 3/4" Branch w/ True Blue Washer	25
PP9818	1-1/2" x 8"	Branch Tailpiece, Hi-Line w/ 1/2" Branch	25
PP9819	1-1/2" x 8"	Branch Tailpiece, Hi-Line w/ 3/4" Branch	25
AP9816	1-1/2" x 8"	Branch Tailpiece, Slip Joint Top w/ 1/2" Branch	25
AP9816W	1-1/2" x 8"	Branch Tailpiece, Slip Joint Top w/ 1/2" Branch w/ True Blue Washer	25
AP9817	1-1/2" x 8"	Branch Tailpiece, Slip Joint Top w/ 3/4" Branch	25
AP9817W	1-1/2" x 8"	Branch Tailpiece, Slip Joint Top w/ 3/4" Branch w/ True Blue Washer	25
AP9818	1-1/2" x 8"	Branch Tailpiece, Hi-Line w/ 1/2" Branch	25
AP9819	1-1/2" x 8"	Branch Tailpiece, Hi-Line w/ 3/4" Branch	25

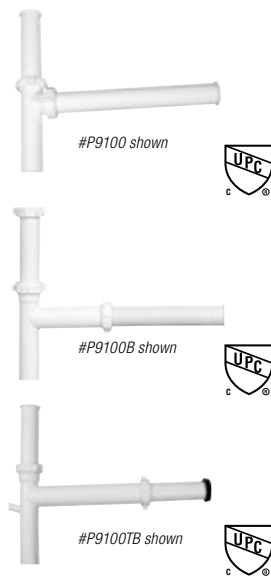

Disposer Kits

Product No.	Size	Description	Ctn. Qty.
P9100	1-1/2"	Disposer Kit For In-Sink-Erator®	25
P9100B	1-1/2"	Disposer Kit For In-Sink-Erator®, Bagged	25
P9100T	1-1/2"	Telescopic Disposer Kit For In-Sink-Erator® or GE®	25
P9100TB	1-1/2"	Telescopic Disposer Kit For In-Sink-Erator®, Bagged	25
P9100GE	1-1/2" x 15"	Disposer Kit For GE®	25
P9100GEB	1-1/2" x 15"	Disposer Kit For GE®, Bagged	25
P9100WB	1-1/2"	Disposer Kit For In-Sink Erator, Bagged w/ True Blue Washer	25
P9103	1-1/2" x 13"	Master Disposer Kit	25
A9100	1-1/2"	Disposer Kit For In-Sink-Erator®	25
A9100B	1-1/2"	Disposer Kit For In-Sink-Erator®, Bagged	25
A9100T	1-1/2"	Telescopic Disposer Kit For In-Sink-Erator® or GE®	25
A9100TB	1-1/2"	Telescopic Disposer Kit For In-Sink-Erator®, Bagged	25
A9100GEB	1-1/2" x 15"	Disposer Kit For GE®, Bagged	25
A9100WB	1-1/2"	Disposer Kit For In-Sink Erator, Bagged w/ True Blue Washer	25



Double Slip Joint Trap Offset

Product No.	Size	Description	Ctn. Qty.
P9046A	1-1/2"	Double Slip Joint Trap Offset	25
A9046A	1-1/2"	Double Slip Joint Trap Offset	25



90 Degree Slip Joint Connectors

Product No.	Size	Description	Ctn. Qty.
P9675	1-1/2"	90 Degree Slip Joint Elbow	25



Elbows & Connectors

Product No.	Size	Description	Ctn. Qty.
P9665	1-1/2"	45 Degree Slip Joint Elbow	25



P9679	1-1/2"	Tee Slip Joint Connector	25
-------	--------	--------------------------	----



P9793D	1-1/2" x 2"	Double Slip Connector	25
--------	-------------	-----------------------	----



P9000	1-1/2"	PVC Solvent Weld Adapter	25
-------	--------	--------------------------	----



P9000A	1-1/2"	PVC Threaded Adapter w/ Nut & Washer Printed Bag, Display Box	25
--------	--------	---	----



6' Tubing

Product No.	Size	Description	Ctn. Qty.
P9141A	1-1/2"	O.D. x 6 Ft. Tubing, PVC	10



Deep Flanges

Product No.	Size	Description	Ctn. Qty.
P9009	1-1/4"	I.D. Deep Flange	25
P9010	1-1/2"	I.D. Deep Flange	25



Bulk Slip Joint Nuts

Product No.	Size	Description	Ctn. Qty.
P9001A	1-1/4"	Slip Joint Nut	100
P9001	1-1/2"	Slip Joint Nut	100
A9001	1-1/2"	Slip Joint Nut	100



Bulk Slip Joint Washers

Product No.	Size	Description	Ctn. Qty.
9002A	1-1/4" x 1-1/4"	Polyethylene Washer	100
9002	1-1/2" x 1-1/2"	Polyethylene Washer	100
9003	1-1/2" x 1-1/4"	Polyethylene Reducing Washer	100
7206	1-1/4" x 1-1/2"	Reducing True Blue Washer	100
7207	1-1/2"	Slip Joint True Blue Washer	100



Bagged Nuts and Washers

Product No.	Size	Description	Ctn. Qty.
HD2798C		Nut and Washer Slip Joint 1-1/4" Plastic, Ind. Printed Bag, Display Box	20
HD2698C		Nut and Washer Slip Joint 1-1/2" Plastic, Ind. Printed Bag, Display Box	20
HD2699C		Polyethylene Beveled Washers Assorted, Ind. Printed Bag, Display Box	20
HD7196C		Polyethylene Beveled Washers 1-1/4", Ind. Printed Bag, Display Box	20
HD7197C		Polyethylene Beveled Washers 1-1/2", Ind. Printed Bag, Display Box	20
HD7198C		Polyethylene Beveled Washers 1-1/2" x 1-1/4", Ind. Printed Bag, Display Box	20
HD7195C		Polyethylene Flanged Washers, 1-1/2", Ind. Printed Bag, Display Box	20



Air Gaps

Product No.	Size	Description	Ctn. Qty.
DB-CD-3		Air Gap, Copper w/ Chrome Plated Metal Cap	48
DB-CD-4P		Air Gap, Plastic w/ Chrome Plated Metal Cap	48
8000E		Air Gap, Plastic, Boxed	24



Form-N-Fit Plastic Tubular Products

Product No.	Size	Description	Ctn. Qty.
HD3522605		Connects To Kitchen Or Bath Drain Systems. J-Bend Neck Extends From 3-1/2" To Over 6", Printed Bag, Display Box	12
HD3522845		Connects To All Drain Systems. Extends From 3-1/2" To Over 7" To Make Offsets Up To 2-1/2", Will Bend Over 90 Degree, Printed Bag, Display Box	10
HD3526945		Connects To 1-1/4" Metal Or Plastic Tailpiece. Extends From 4-1/2" To Over 7-3/4", Printed Bag, Display Box	10
HD3526955		Connects To Hi-Line And Slip Joint Applications. Adapts To 1-1/2" And 1-1/4" Drain Systems. Tailpiece Extends From 5-1/2" To Over 11" And Offsets Up To 4-1/2", Printed Bag, Display Box	10
HD3522355		Connects To 1-1/2" Or 1-1/4" Metal Or Plastic Tailpiece. Extends From 5-1/2" To Over 11", Printed Bag, Display Box	10

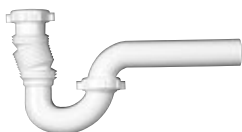



Pop-Up Assemblies Brass/Plastic

Product No.	Size	Description	Ctn. Qty.
HD3522215		Form-N-Fit Pop-Up Unit 1-1/4" Plastic, DB Cutcase, Bagged	8

Dishwasher And Disposal Connectors



Product No.	Size	Description	Ctn. Qty.
HD7983C		Dishwasher Disposal Connector, Printed Bag, Display Box	20



HD2673C		Elbow For In-Sink-Erator® Plastic, Display Box	10
---------	--	--	----



HD2672C		Disposal Gasket For In-Sink-Erator® , Printed Bag	24
---------	--	---	----



HD2688B	1-1/2" & 1-1/4"	Reducer Adapter, Printed Bag	12
---------	-----------------	------------------------------	----



HD2670C		Elbow for Waste King® Disposer, Plastic	12
---------	--	---	----



Category 16

Bath Waste and Overflow

Dearborn Brass® bath waste and overflow products offer excellent performance for air or water testing. Full kits include 4" and 12" Sch. 40 pipe with Sch. 40 tee and all components required for rough-in, testing and finish installation. Half kits include everything except pipes and tee. IAPMO approved.



Brass Chicago Code Thru Wall

Product No.	Description	Ctn. Qty.
235-3	Full Kit, Brass Tubular - 17 Ga. Uni-Lift Stopper w/ Chrome Finish Trim 2 Hole Faceplate, Chicago Code Thru Wall	1



Brass Touch-Toe Bath Waste

Product No.	Description	Ctn. Qty.
228-3	Full Kit, Brass Tubular - 17 Ga. Touch Toe Stopper w/ Chrome Finish Trim	1



#202-1 shown

Brass Chain & Stopper Bath Waste

Product No.	Description	Ctn. Qty.
202-1	Full Kit, Brass Tubular - 17 Ga. Chain & Stopper w/ Chrome Finish Trim w/ Chromed Pipes, Elbows & Tee	1
202-3	Full Kit, Brass Tubular - 17 Ga. Chain & Stopper w/ Chrome Finish Trim	1
208-3	Full Kit, Brass Tubular - 17 Ga. Chain & Stopper w/ Chrome Finish Trim 1-1/2" Outlet	1



With Condensate Top Elbow Option

Brass Trip-Lever Bath Waste

Product No.	Description	Ctn. Qty.
226-3	Full Kit, Brass Tubular - 17 Ga. Trip Lever Stopper w/ Chrome Finish Trim	1



#230-3 shown

Brass Whirlpool Bath Waste

Product No.	Description	Ctn. Qty.
203-3	Full Kit, Brass Tubular - 17 Ga. Uni-Lift Stopper w/ Chrome Finish Trim For Whirlpool Tubs	1
230-3	Full Kit, Brass Tubular - 17 Ga. Trip Lever Stopper w/ Chrome Finish Trim For Whirlpool Tubs	1



With Condensate Top Elbow Option

#227-3 shown

Brass Uni-Lift Bath Waste

Product No.	Description	Ctn. Qty.
227-3	Full Kit, Brass Tubular - 17 Ga. Uni-Lift Stopper w/ Chrome Finish Trim	1
227C-3	Full Kit, Brass Tubular - 17 Ga. Uni-Lift Stopper w/ Chrome Finish Trim Condensate Elbow	1



Brass Uni-Lift For Direct Drain

Product No.	Description	Ctn. Qty.
227D-3	Full Kit, Brass Tubular - 17 Ga. Uni-Lift Stopper w/ Chrome Finish Drain Direct Drain	1



Brass Uni-Lift Bath Waste For Side Drain

Product No.	Description	Ctn. Qty.
227S-3	Full Kit, Brass Tubular - 17 Ga. Uni-Lift Stopper w/ Chrome Finish Drain Side Drain	1



#P8220 shown

Plastic Tubular Cable Bath Waste

Product No.	Description	Ctn. Qty.
P8220	Full Kit, Plastic Tubular – White Cable Stopper w/ Chrome Finish Trim	1
P220	Rough-In Kit, Plastic Tubular – White Cable Stopper - No Trim	1



#K20 shown

Plastic Tubular And Schedule 40 Cable Bath Waste Conversion Kits

Product No.	Description	Ctn. Qty.
K20	Conversion Kit, Cable Stopper w/ Chrome Finish Trim	2
K20BC	Conversion Kit, Cable Stopper w/ Biscuit Finish Trim	2
K20BN	Conversion Kit, Cable Stopper w/ Brushed Nickel Finish Trim	2
K20PB	Conversion Kit, Cable Stopper w/ UltraShine® Polished Brass Finish Trim	2
K20RB	Conversion Kit, Cable Stopper w/ Rubbed Bronze Finish Trim	2
K20SN	Conversion Kit, Cable Stopper w/ UltraShine® Satin Nickel Finish Trim	2
K20WH	Conversion Kit, Cable Stopper w/ White Finish Trim	2



#P9226 shown

Plastic Tubular Trip-Lever Bath Waste

Product No.	Description	Ctn. Qty.
P9226	Full Kit, Plastic Tubular - White Trip-Lever Stopper w/ Chrome Finish	10
A9226	Full Kit, Plastic Tubular - Black Trip-Lever Stopper w/ Chrome Finish	10



#P8227 shown

Plastic Tubular Uni-Lift Bath Waste

Product No.	Description	Ctn. Qty.
P8227	Full Kit, Plastic Tubular - White Uni-Lift Stopper w/ Chrome Finish Trim	10
P8227BN	Full Kit, Plastic Tubular - White Uni-Lift Stopper w/ Brushed Nickel Finish Trim	10
P8227RB	Full Kit, Plastic Tubular - White Uni-Lift Stopper w/ Rubbed Bronze Finish Trim	10
P8227BG	Full Kit, Plastic Tubular - White Uni-Lift Stopper w/ Chrome Finish Trim Zinc Drain Unit, 2 Hole Faceplate	10
A8227	Full Kit, Plastic Tubular - Black Uni-Lift Stopper w/ Chrome Finish Trim	10
A8227BG	Full Kit, Plastic Tubular - Black Uni-Lift Stopper w/ Chrome Finish Trim Zinc Drain Unit, 2 Hole Faceplate	10



#P8227C shown

Plastic Tubular Uni-Lift Bath Waste With Condensate Top Elbow

Product No.	Description	Ctn. Qty.
P8227C	Full Kit, Plastic Tubular - White Uni-Lift Stopper w/ Chrome Finish Trim Condensate Elbow	10
A8227C	Full Kit, Plastic Tubular - Black Uni-Lift Stopper w/ Chrome Finish Trim Condensate Elbow	10



#P8227D shown

Plastic Tubular Uni-Lift For Direct Drain

Product No.	Description	Ctn. Qty.
P8227D	Full Kit, Plastic Tubular - White Uni-Lift Stopper w/ Chrome Finish Trim Direct Drain	10
A8227D	Full Kit, Plastic Tubular - Black Uni-Lift Stopper w/ Chrome Finish Trim Direct Drain	10



#P8228 shown

Plastic Tubular Touch-Toe Bath Waste

Product No.	Description	Ctn. Qty.
P9228	Full Kit, Plastic Tubular - White Touch-Toe Stopper w/ Chrome Finish Trim	10
A9228	Full Kit, Plastic Tubular - Black Touch-Toe Stopper w/ Chrome Finish Trim	10



#P7224 shown

Schedule 40 Touch-Toe Full Kit Bath Waste

Product No.	Description	Ctn. Qty.
P7224	Full Kit, Schedule 40 - PVC Touch-Toe Stopper w/ Chrome Finish Trim	10
P7644	DBLue Full Kit, Schedule 40 - PVC Touch-Toe Stopper w/ Chrome Finish Trim and Test Plug	10
A7224	Full Kit, Schedule 40 - ABS Touch-Toe Stopper w/ Chrome Finish Trim	10
A7644	DBLue Full Kit, Schedule 40 - ABS Touch-Toe Stopper w/ Chrome Finish Trim and Test Plug	10



#P7225 shown

Schedule 40 Uni-Lift Full Kit Bath Waste

Product No.	Description	Ctn. Qty.
P7225	Full Kit, Schedule 40 - PVC Uni-Lift Stopper w/ Chrome Finish Trim	10
P7544	DBLue Full Kit, Schedule 40 - PVC Uni-Lift Stopper w/ Chrome Finish Trim and Test Plug	10
A7225	Full Kit, Schedule 40 - ABS Uni-Lift Stopper w/ Chrome Finish Trim	10
A7544	DBLue Full Kit, Schedule 40 - ABS Uni-Lift Stopper w/ Chrome Finish Trim and Test Plug	10



Schedule 40 Tap-Tap Bath Waste

Product No.	Description	Ctn. Qty.
P7444	Full Kit, Schedule 40 - PVC Tap-Tap Stopper w/ Chrome Finish Trim	10
P7444B	Half Kit, Schedule 40 - PVC Tap-Tap Stopper w/ Chrome Finish Trim	20



#P7224B shown

Schedule 40 Bath Waste Touch Toe Half Kits

Product No.	Description	Ctn. Qty.
P7224B	Half Kit, Schedule 40 - PVC Touch-Toe Stopper w/ Chrome Finish Trim	20
P7725	DBLue Half Kit, Schedule 40 - PVC Touch-Toe Stopper w/ Chrome Finish Trim and Test Plug	20
P7725BN	DBLue Half Kit, Schedule 40 - PVC Touch-Toe Stopper w/ Brushed Nickel Finish Trim and Test Plug	20
A7224B	Half Kit, Schedule 40 - ABS Touch-Toe Stopper w/ Chrome Finish Trim	20
A7725	DBLue Half Kit, Schedule 40 - ABS Touch-Toe Stopper w/ Chrome Finish Trim and Test Plug	20
A7725BN	DBLue Half Kit, Schedule 40 - ABS Touch-Toe Stopper w/ Brushed Nickel Finish Trim and Test Plug	20



Schedule 40 Bath Waste Uni-Lift Half Kits

Product No.	Description	Ctn. Qty.
P7225B	Half Kit, Schedule 40 - PVC Uni-Lift Stopper w/ Chrome Finish Trim	20
P7225BAB	Half Kit, Schedule 40 - PVC Uni-Lift Stopper w/ Antique Bronze Finish Trim	20
P7225BBC	Half Kit, Schedule 40 - PVC Uni-Lift Stopper w/ Biscuit Finish Trim	20
P7225BBN	Half Kit, Schedule 40 - PVC Uni-Lift Stopper w/ Brushed Nickel Finish Trim	20
P7225BRB	Half Kit, Schedule 40 - PVC Uni-Lift Stopper w/ Rubbed Bronze Finish Trim	20
P7225BSC	Half Kit, Schedule 40 - PVC Uni-Lift Stopper w/ UltraShine® Satin Chrome Finish Trim	20
P7225BSN	Half Kit, Schedule 40 - PVC Uni-Lift Stopper w/ UltraShine® Satin Nickel Finish Trim	20
P7225BWH	Half Kit, Schedule 40 - PVC Uni-Lift Stopper w/ White Finish Trim	20
P7225BZ	Half Kit, Schedule 40 - PVC Uni-Lift Stopper w/ Chrome Finish Trim w/ Zinc Drain Unit	20
P7325	DBLue Half Kit, Schedule 40 - PVC Uni-Lift Stopper w/ Chrome Finish Trim and Test Plug	20
P7325RB	DBLue Half Kit, Schedule 40 - PVC Uni-Lift Stopper w/ Oil Rubbed Bronze Finish Trim and Test Plug	20
P7325BN	DBLue Half Kit, Schedule 40 - PVC Uni-Lift Stopper w/ Brushed Nickel Finish Trim and Test Plug	20
P7325BZ	DBLue Half Kit, Schedule 40 - PVC Uni-Lift Stopper w/ Chrome Finish Trim w/ Zinc Spud and Test Plug	20
P9225BBG	Half Kit, Schedule 40 - PVC Uni-Lift Stopper w/ Chrome Finish Trim w/ Zinc Drain Unit No Test Kit, 2 Hole Faceplate	25
A7225B	Half Kit, Schedule 40 - ABS Uni-Lift Stopper w/ Chrome Finish Trim	20
A7225BZ	Half Kit, Schedule 40 - ABS Uni-Lift Stopper w/ Chrome Finish Trim w/ Zinc Drain Unit	20
A7325	DBLue Half Kit, Schedule 40 - ABS Uni-Lift Stopper w/ Chrome Finish Trim and Test Plug	20
A7325RB	DBLue Half Kit, Schedule 40 - ABS Uni-Lift Stopper w/ Oil Rubbed Bronze Finish Trim and Test Plug	20
A7325BN	DBLue Half Kit, Schedule 40 - ABS Uni-Lift Stopper w/ Brushed Nickel Finish Trim and Test Plug	20
A7325BZ	DBLue Half Kit, Schedule 40 - ABS Uni-Lift Stopper w/ Chrome Finish Trim w/Zinc Spud and Test Plug	20
A9225BBG	Half Kit, Schedule 40 - ABS Uni-Lift Stopper w/ Chrome Finish Trim w/ Zinc Drain Unit No Test Kit, 2 Hole Faceplate	25

CATEGORY 16 BATH WASTE AND OVERFLOW



Schedule 40 Bath Waste Half Kits With Condensate Top Elbow

Product No.	Description	Ctn. Qty.
P7225BC	Half Kit, Schedule 40 - PVC Uni-Lift Stopper w/ Chrome Finish Trim Condensate Elbow	20
P7325BCZ	Half Kit, Schedule 40 - PVC Condensate Elbow, Uni-Lift Stopper w/ Chrome Finish Trim and Zinc Spud	35



Schedule 40 Cable Bath Waste Rough-In Kit

Product No.	Description	Ctn. Qty.
P7220BF	Rough-In Kit, Schedule 40 - PVC Cable Stopper w/ Chrome Finish Trim	20



Schedule 40 Bath Waste Quarter Kits

Product No.	Description	Ctn. Qty.
P3225D	Quarter Kit, Schedule 40 - PVC Uni-Lift Stopper w/ Chrome Finish Trim Direct Drain	20
A3225Z	Quarter Kit, Schedule 40 - ABS Uni-Lift Stopper w/ Chrome Finish Trim Zinc Drain Unit, 90 Degree Elbow	20



Schedule 40 Bath Waste Rough-In Kits

Product No.	Description	Ctn. Qty.
P7223CRK	Rough-In Kit, Schedule 40 - PVC w/Condensate Elbow	30
P7223RK	Rough-In Kit, Schedule 40 - PVC	30
P7323RKZ	Rough-In Kit, Schedule 40 - PVC w/ Zinc Spud	30
A7223RK	Rough-In Kit, Schedule 40 - ABS	30
A7323RKZ	Rough-In Kit, Schedule 40 - ABS w/ Zinc Spud	30



Schedule 40 Bath Waste DBLue Rough-In Kits

Product No.	Description	Ctn. Qty.
P7323	DBLue Rough-In Kit, Schedule 40 - PVC	30
A7323	DBLue Rough-In Kit, Schedule 40 - ABS	30

Bath Waste Trim Kits



Chrome Finish Trim Kits do not include spud



Decorator Finish Trim Kits include color-coordinated spud



Chrome Finish Trim Kits do not include spud

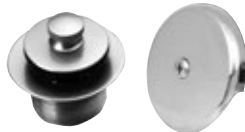

Decorator Finish Trim Kits include color-coordinated spud



K22BN shown*

Product No.	Description	Ctn. Qty.
K24TB	Trim Kit, for Schedule 40 - Rough-In Kit Touch-Toe Stopper w/ Chrome Finish Trim	10
K74TBN	Trim Kit, for Schedule 40 - Rough-In Kit Touch-Toe Stopper w/ Brushed Nickel Finish Trim	10
K74TSN	Trim Kit, for Schedule 40 - Rough-In Kit Touch-Toe Stopper w/ UltraShine® Satin Nickel Finish Trim	10
K74TWH	Trim Kit, for Schedule 40 - Rough-In Kit Touch-Toe Stopper w/ White Finish Trim	10
K25TB	Trim Kit, for Schedule 40 - Rough-In Kit Uni-Lift Stopper w/ Chrome Finish Trim	10
K75AB	Trim Kit, for Schedule 40 - Rough-In Kit Uni-Lift Stopper w/ Antique Bronze Finish Trim	10
K75TPB	Trim Kit, for Schedule 40 - Rough-In Kit Uni-Lift Stopper w/ UltraShine® Polished Brass Finish Trim	10
K75TRB	Trim Kit, for Schedule 40 - Rough-In Kit Uni-Lift Stopper w/ Rubbed Bronze Finish Trim	10
K75TSC	Trim Kit, for Schedule 40 - Rough-In Kit Uni-Lift Stopper w/ UltraShine® Satin Chrome Finish Trim	10
K75TSN	Trim Kit, for Schedule 40 - Rough-In Kit Uni-Lift Stopper w/ UltraShine® Satin Nickel Finish Trim	10
K25TBZ	Trim Kit, for Schedule 40 - Rough-In Kit Uni-Lift Stopper Zinc Drain Unit w/ Chrome Finish Trim	10
K22WH	Trim Kit, for Schedule 40 - Rough-In Kit Uni-Lift Stopper w/ White Finish Trim	10

Bath Waste DBLue Trim Kits

Product No.	Description	Ctn. Qty.
K22TB	DBLue Trim Kit, for Schedule 40 - Rough-In Kit Uni-Lift Stopper w/ Chrome Finish Trim	10
K22RB	DBLue Trim Kit, for Schedule 40 - Rough-In Kit Uni-Lift Stopper w/ Oil Rubbed Bronze Finish Trim	10
K22BN	DBLue Trim Kit, for Schedule 40 - Rough-In Kit Uni-Lift Stopper w/ Brushed Nickel Finish Trim	10
K23TB	DBLue Trim Kit, for Schedule 40 - Rough-In Kit Touch-Toe Stopper w/ Chrome Finish Trim	10
K23RB	DBLue Trim Kit, for Schedule 40 - Rough-In Kit Touch-Toe Stopper w/ Oil Rubbed Bronze Finish Trim	10
K23BN	DBLue Trim Kit, for Schedule 40 - Rough-In Kit Touch-Toe Stopper w/ Brushed Nickel Finish Trim	10

CATEGORY 16 BATH WASTE AND OVERFLOW



Bath Waste Conversion Kits

Product No.	Description	Ctn. Qty.
K26	Conversion Kit, Trip Lever Stopper w/ Chrome Finish Trim	2
K26BN	Conversion Kit, Trip Lever Stopper w/ Brushed Nickel Finish Trim	2
K26PB	Conversion Kit, Trip Lever Stopper w/ UltraShine® Polished Brass Finish Trim	2
K26RB	Conversion Kit, Trip Lever Stopper w/ Rubbed Bronze Finish Trim	2
K26SC	Conversion Kit, Trip Lever Stopper w/ UltraShine® Satin Chrome Finish Trim	2
K26SN	Conversion Kit, Trip Lever Stopper w/ UltraShine® Satin Nickel Finish Trim	2
K27	Conversion Kit, Uni-Lift Stopper w/ Chrome Finish Trim	2
K27AB	Conversion Kit, Uni-Lift Stopper w/ Antique Bronze Finish Trim	2
K27BN	Conversion Kit, Uni-Lift Stopper w/ Brushed Nickel Finish Trim	2
K27PB	Conversion Kit, Uni-Lift Stopper w/ UltraShine® Polished Brass Finish Trim	2
K27RB	Conversion Kit, Uni-Lift Stopper w/ Rubbed Bronze Finish Trim	2
K27SC	Conversion Kit, Uni-Lift Stopper w/ UltraShine® Satin Chrome Finish Trim	2
K27SN	Conversion Kit, Uni-Lift Stopper w/ UltraShine® Satin Nickel Finish Trim	2
K27WH	Conversion Kit, Uni-Lift Stopper w/ White Finish Trim	2
K28	Conversion Kit, w Two-Hole Cover Plate, Uni-Lift Stopper w/ Chrome Finish Trim	2
K28BN	Conversion Kit, w Two-Hole Cover Plate, Uni-Lift Stopper w/ Brushed Nickel Finish Trim	2
K28RB	Conversion Kit, w Two-Hole Cover Plate, Uni-Lift Stopper w/ Rubbed Bronze Finish Trim	2
K28SN	Conversion Kit, w Two-Hole Cover Plate, Uni-Lift Stopper w/ UltraShine® Satin Nickel Finish Trim	2



Bath Waste Model Kits

Product No.	Description	Ctn. Qty.
46206	Test Plug Kit	10
46207	Conversion Bar Kit	10

Bath Waste Repair Parts

Product No.	Description	Ctn. Qty.
4502-1	Faceplate, Two Hole, Chrome Plated w/ Screws	1
4503-1	Faceplate, Trip Lever, Chrome Plated w/ Screws	1
4504-1	Faceplate, One Hole, Chrome Plated w/ Screw (46250)	1
4537-1	Strainer Cover, Chrome w/ Screw, Stainless Steel	1
4534-3	Bottom Strainer (1-1/4")	
4534C-3	Cast Bottom Strainer (1-1/2")	1
4547-1	Uni-Lift Plug and Seat (1-1/4" NPT), Chrome	1
4597-1	Drain Assembly, Uni-Lift 1-1/2" Chrome, 3/8"x 16 Stem	1
4597X-1	Plug Only, Uni-Lift 1-1/2", Chrome 3/8"-16 Stem	1
4497-1	Unit (1-1/2" NPT), Chrome	1
4497X-1	Tap-Tap Replacement Cartridge, Brass, Chrome 3/8"-16 Stem	1
4509-3	Washer for Top Ell, Blue Foam (Oatey #46208)	1

Pop-Up Bath Waste Drain Seat & Plug

Product No.	Description	Ctn. Qty.
4538-3	Drain Plug w/ Fulcrum Linkage, Nut & Plug Seat, Chrome	1

CATEGORY **16** BATH WASTE AND OVERFLOW



Category 17

Basket and Sink Strainers

Dearborn Brass offers the widest variety of basket and sink strainers in the industry. Many of our most popular items are made in the USA.

Sink Strainers



Product No.	Description	Ctn. Qty.
L7	"Lucky 7" Sink Basket Strainer, Chrome Plated Brass Body w/ Stainless Steel Basket, Metal Post, Heavy Locknut, Rubber Stopper, Extra Thick Washer, Machine Cut Threads.	24
L7BN	Same as L7 w/ Brass Nuts	24
L7T	Same as L7 w/ 4" Chrome Plated Tailpiece	24
4201-L7-3	Replacement Basket for L7	1



L74	"Lucky 7" Sink Basket Strainer, w/ Stainless Steel 4-Prong Basket, Chrome Plated Brass Body, Metal Post, Rubber Stopper, Heavy Locknut, Extra Thick Washer, Machine Cut Threads.	24
L74T	Same as L74 w/ 4" Tailpiece.	24
4204-L7-3	Replacement Basket for L74 (4-Prongs)	1



DB1000	Locking Cup Sink Basket Strainer, Stainless Steel Body and Basket, Galvanized Steel Locking Cup, Plastic Post and Rubber Stopper.	24
--------	---	----



DB1000EZBN	EZ-Mount Sink Basket Strainer with Stainless Steel Body and Basket with EZ-Mount Connection and Brass Nut, Plastic Post and Rubber Stopper.	24
4204-00-3	Replacement Basket for DB1000	1



DB1120	Deep Locking Cup Sink Basket Strainer, Stainless Steel Body and Basket, Rubber Stopper w/ Snap-In Basket. Length - 3-3/4".	24
DB1120BN	Same as DB1120 w/ Brass Nuts.	24
4204-20-3	Replacement Basket for DB1120	1



DB711	"Spin-N-Lock" Sink Basket Strainer, Chrome Plated Brass Body w/ Stainless Steel Screw-In Basket, Brass Turning Nut	24
DB711BN	Same as DB711 w/ Brass Nuts	24



DB711EZ	"Spin-N-Lock" Sink Basket Strainer, Chrome Plated Brass Body w/ Stainless Steel Screw-In Basket and EZ-Mount Connection	24
4204-11-3	Replacement Basket for DB711	1



Economy

Product No.	Description	Ctn. Qty.
12	Medium Cup Basket Strainer, Stainless Steel Body and Basket, Medium Locking Cup, Neoprene Stopper, Bright Flange, Length 3-1/8" Fits Deep Cast Iron Sinks.	24



Locking Cup Strainers

Product No.	Description	Ctn. Qty.
14	Shallow Cup Basket Strainer, Stainless Steel Body and Basket Shallow Locking Cup. Neoprene Stopper w/ Snap-In Basket w/ Bright. Flange. Length- 2-3/4". Fits Deep Cast Iron Sinks	24
14T	Same as 14 w/ 4" Chrome Plated Tailpiece	24
4204-14-3	Replacement Basket for 14 (new style with metal snap-in spring)	1



15	"Snap-N-Tite" Sink Basket Strainer, Stainless Steel Body and Basket. Locking Cup. Neoprene Stopper. Fits cast iron sinks. Length 3-3/4"	24
15T	Same as 15 w/ 4" Chrome Plated Tailpiece (Fits all cast iron)	24
15BN	Same as 15 w/ Brass Nuts. Neoprene Stopper with Brass Nuts. (Fits all cast iron)	24
4201-15-3	Replacement Basket for 15	1



18	Sink Basket Strainer, Stainless Steel Body and Basket. Deep Locking Cup. Neoprene Stopper. Length-3-3/4"	24
18T	Same as 18 w/ 4" Chrome Plated Tailpiece	24
18BN	Same as 18 w/ Brass Nuts	24
4204-18-3	Replacement Basket for 18 (new style with metal snap-in spring)	1



Easy Mount Strainer

Product No.	Description	Ctn. Qty.
3BN	Thumbscrew Sink Basket Strainer, Stainless Steel Body and Basket, Triangular Threaded Flange w/ Three Thumbscrews for Easy Installation and Brass Nuts, Neoprene Stopper	24
4204-3-3	Replacement Basket for 3BN	1

Threaded Body Strainers



Product No.	Description	Ctn. Qty.
6	"Super 6" Sink Basket Strainer, Stainless Steel Body and Basket, Rubber Stopper w/ Metal Post, Extra Wide Locknut, Extra Thick Washer	24
6T	Same as Above w/ 4" Chrome Plated Tailpiece	24
4204-6-3	Replacement Basket for 6 (new style snap-in metal spring)	



9	Economy Sink Basket Strainer, ABS Body w/ Stainless Steel Rim and Basket. Rubber Stopper w/ Plastic Post, ABS Locknut	24
---	---	----



10	Standard Sink Basket Strainer, Stainless Steel Body and Basket. Rubber Stopper w/ Metal Post	24
10T	Same as 10 w/ 4" Chrome Plated Tailpiece	24
4201-3-3	Replacement Basket for 10	1



11	Standard Sink Basket Strainer, Stainless Steel Body and Basket. Rubber Stopper w/ Chromed Plastic Post	24
11T	Same as Above w/ 4" Chrome Plated Tailpiece	24
4201-4-3	Replacement Basket for 11	1



16	Sink Basket Strainer, Brass Body w/ Stainless Steel Basket. Heavy Locknut. Rubber Stopper. Length-3-3/4"	24
16BN	Same as 16 w/ Brass Nuts	24
16T	Same as 16 w/ 4" Chrome Plated Tailpiece	24
4201-3-3	Replacement Basket for 16	1



17	"Spin-N-Lock" Sink Basket Strainer, Stainless Steel Body w/ Stainless Steel Screw-In Basket	24
17BN	Same as 17 w/ Brass Nuts	24
17T	Same as 17 w/ 4" Chrome Plated Tailpiece	24
4201-17-3	Replacement Basket for 17	1



816	Cast Brass Body Sink Basket Strainer, Stainless Steel Basket w/ Brass Slide Post, Cast Brass Stopper and Brass Locknut. Heavy Duty Commercial Grade.	24
816T	Same as Above w/ 4" Chrome Plated 17 Ga. Tailpiece	24

Bar Sink Strainers



Product No.	Description	Ctn. Qty.
3784	Junior Duo Bar Sink Strainer, Stainless Steel Body and Basket. Length 1-1/8"	12
3784BN	Same as 3784 w/ Brass Nuts	12
3784T	Same as 3784 w/ 4" Chrome Plated Tailpiece	12
4201-5-3	Replacement Basket for 3784	1



774	Duplex Sink Strainer, Brass Body w/ Flat Stainless Steel Strainer for 2-1/2" Opening	12
774BN	Same as 774 w/ Brass Nuts	12
774T	Same as 774 w/ 4" Chrome Plated Tailpiece	12



774A	Tray Plug Sink Basket Strainer, Brass Body w/ Rubber Stopper for 2-1/2" Opening	12
------	---	----



3785A	Standard Bar Sink Strainer, Brass Body and Crumb Cup. Length - 2-1/8"	12
3785ABN	Same as 3785A w/ Brass Nuts	12
3785AT	Same as 3785A w/ 4" Chrome Plated Tailpiece	12
4201-8-1	Replacement Basket for 3785A	1



815B	Flat Top Sink Basket Strainer, Brass Body and Stainless Steel Strainer. Length - 1-7/8"	12
815BT	Same as 815B w/ 4" Chrome Plated Tailpiece	12

Repair Parts For Basket Strainers



Product No.	Description	Ctn. Qty.
4202-2-3	Rubber Washer For 6, 9, 10, 11, 14, 16, 17, 18, 815B and 816	1

Decorator Plastic Strainer Assemblies



Product No.	Description	Ctn. Qty.
9BC	Plastic Strainer Assembly, Biscuit Color, Clamshell	6
9BC-BX	Plastic Strainer Assembly, Biscuit Color, Boxed	12
9WH	Plastic Strainer Assembly, White Color, Clamshell	6
9WH-BX	Plastic Strainer Assembly, White Color, Boxed	12
9BNE	Plastic Strainer Assembly, Bone Color, Clamshell	6
9BNE-BX	Plastic Strainer Assembly, Bone Color, Boxed	12
9EWH	Plastic Strainer Assembly, Euro-White Color, Clamshell	6
9EWH-BX	Plastic Strainer Assembly, Euro-White Color, Boxed	12
9BL	Plastic Strainer Assembly, Black Color, Clamshell	6
9BL-BX	Plastic Strainer Assembly, Black Color, Boxed	12



Decorator Brass Disposer Flanges

Product No.	Description	Ctn. Qty.
D7U	Disposer Flange and Stopper, UltraShine® Polished Brass Finish, Boxed	6
D7CHR	Disposer Flange and Stopper, Brass Polished Chrome Finish, Boxed	6

Decorator Plastic Disposer Flanges



Product No.	Description	Ctn. Qty.
D9BC	Disposer Flange Assembly, Biscuit Color, Clamshell	6
D9BC-BX	Disposer Flange Assembly, Biscuit Color, Boxed	12
D9WH	Disposer Flange Assembly, White Color, Clamshell	6
D9WH-BX	Disposer Flange Assembly, White Color, Boxed	12
D9BNE	Disposer Flange Assembly, Bowl, Bone Color, Clamshell	6
D9BNE-BX	Disposer Flange Assembly, Bowl, Bone Color, Boxed	12
D9EWH	Disposer Flange Assembly, Euro-White Color, Clamshell	6
D9EWH-BX	Disposer Flange Assembly, Euro-White Color, Boxed	12
D9BL	Disposer Flange Assembly, Black Color, Clamshell	6
D9BL-BX	Disposer Flange Assembly, Black Color, Boxed	12



Polished Brass Bar Strainer

Product No.	Description	Ctn. Qty.
23030	Bar Sink Strainer w/ Crumb Cup. Length 2-1/8", Polished Brass	1

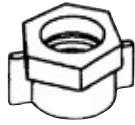

#930100 shown

Fill Valve Components

Product No.	Description	Ctn. Qty.
930100	Wing Coupling Nut - 5/8" Center Hole, plastic (1911-2)	100
930103	9" Vinyl Refill Tube (190617)	100
930133	Tank Lever Nut, Brass	100



Water Saving Flappers

Product No.	Description	Ctn. Qty.
930042TR	Timed Rate Flapper Kit (Bagged) Vinyl flapper w/ 9" chain, hook and baffles	24



Tank Ball Floats

Product No.	Description	Ctn. Qty.
930118	Plastic Tank Float (Bulk). High Buoyancy, Black Polypropylene (P83)	100



Spud Washers

Product No.	Description	Ctn. Qty.
4025	2" x 2" Closet Spud	6
4026	2" x 1-1/2" Closet Spud	6
4028	1-1/2" x 1-1/2" Closet Spud	6
4028A	1-1/2" x 1-1/4" Closet Spud	6
4029	1-1/4" x 1-1/4" Closet Spud	6
4030	1" x 3/4" Urinal Spud	6
4031	1-1/4" x 3/4" Urinal Spud	6
4032	1-1/2" x 3/4" Urinal Spud	6
7101	1-1/2" Flanged Spud Washer	25
7102	2" Flanged Spud Washer	25
7105	1" x 3/4" Flanged Spud Washer	25

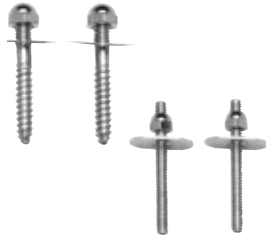

Closet Bolts/Screws

Product No.	Description	Ctn. Qty.
8545C	Tank to Bowl Bolt Kit w/ Galvanized Spud Washer	50
8546	Tank to Bowl Bolt Kit w/ Brass Spud Washer	50
8512C	Toilet Screw Set, 5/16" x 2-1/2" Brass Closet Screws 2 Brass Screws w/ Nuts and Washers	50
8525C	Toilet Bolts, 1/4" x 2-1/2" Plated, Oregon Pattern	50



Flush Levers

Product No.	Description	Ctn. Qty.
702007	Chrome, Plastic Spud And Nut, Round Brass Arm - 8"	100
702034	Chrome, Zinc spud and Nut, Round Brass Arm - 8"	24
4225B	Economy Flush Lever, Chrome Plated Plastic w/ Plastic Spud	25
4223	Alloy Rod Flush Lever, Chrome Plated w/Die Cast Spud	25



Toilet Accessories

Product No.	Description	Ctn. Qty.
4211	Toilet Tank Cover	1
7520	Three Way Rubber Flapper	25
7555	6-3/4" Form Fit Closet Bowl Sponge Rubber Gasket	10
7556	5-3/4" O.D. x 3-1/2" Closet Bowl Sponge Rubber Gasket	10
7557	3-1/4" O.D x 2-1/8" Tank to Bowl Sponge Rubber Gasket for Close Couple Connection	24

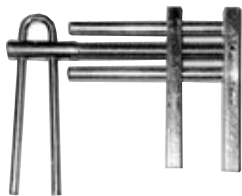

Wrenches, Tools & Plungers

Product No.	Description	Ctn. Qty.
3003	Strainer Locknut Wrench w/Hinged Jaw	6
3010	Large Jaw Basin Wrench w/ 15" Handle	1
3030	1" - 4" Spud Wrench for Removal or Installation of Closet Spuds, Sink Strainers, P.O Plugs, Waste & Overflow	10
3032	Tub Waste Wrench - Fits 1-1/2" and 1-1/4" Sizes	1
3040G	2" Heavy Duty Pliers with Vinyl Grips	1
3068	Socket Wrench Set with 5 Socket Wrenches	1
3713	Swedge Tool for 3/8", 1/2" & 3/4" I.D. Nominal sizes to 5/8" & 7/8" O.D. Tubing	1
5126	1/8" NPT Bright Plated Loose Key Coin Air Vent	25
5130	1/4" NPT Bright Finish Vent Key	20
5236	1/4" NPT Straight Type Steel Siphon	12
7981FW	Four Way Key	12
7505	Samson Force Cup Plunger w/ 18" Handle	5

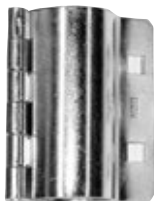

Pipe Repair Clamps

Product No.	Description	Ctn. Qty.
8201	1/2" NPT Cadmium Plated Steel Pipe Repair Clamp w/Neoprene Gasket	6
8202	3/4" NPT Cadmium Plated Steel Pipe Repair Clamp w/Neoprene Gasket	6
8203	1" NPT Cadmium Plated Steel Pipe Repair Clamp w/Neoprene Gasket	10
8204	1-1/4" NPT Cadmium Plated Steel Pipe Repair Clamp w/Neoprene Gasket	6
8205B	1-1/2" NPT Cadmium Plated Steel Pipe Repair Clamp w/Neoprene Gasket	1
6200C	1/8" x 24" Graphite Twist Packing w/individual strand - Bagged	48



Ground Joint Part Waste Connectors

Product No.	Description	Ctn. Qty.
1004	1-1/4" x 1-1/4" Male (Female Copper Sweat)	6
1005	1-1/2" x 1-1/2" Male (Female Copper Sweat)	6
R1006	1-1/4" x 1-1/2" Male (Female Copper Sweat)	6
B1005	1-1/2" Brass Ring	10
B1004	1-1/4" Brass Ring	10
1012	1-1/4" x 1-1/4" Female, Ground Joint Waste Connector	6
1013	1-1/2" x 1-1/2" Female, Ground Joint Waste Connector	6
1014	1-1/4" x 1-1/2" Female, Ground Joint Waste Connector	6



Bulk Slip Nuts – Brass

Product No.	Description	Ctn. Qty.
8006	1-1/2" x 1-1/2" Slip Nut w/ Washer, Chrome Plated	50
8006R	1-1/2" x 1-1/2" Brass Nut, Unfinished	50
8007	1-1/4" x 1-1/4" Slip Nut w/ Washer, Chrome Plated	50
8008	1-1/2" x 1-1/4" Slip Nut w/ Washer, Chrome Plated	50
8009	1-1/2" x 1-3/8" Slip Nut w/ Washer, Chrome Plated	50
8011	2" x 2" Slip Nut w/ Washer, Chrome Plated	25



Bulk Slip Nuts – Die Cast

Product No.	Description	Ctn. Qty.
8030	1-1/4" x 1-1/4" Die Cast Nut, Chrome Plated	50
8030LW	1-1/4" x 1-1/4" Die Cast Nut, Chrome Plated, Less Washer	100
8031	1-1/2" x 1-1/4" Die Cast Nut, Chrome Plated	50
8031LW	1-1/2" x 1-1/4" Die Cast Nut, Chrome Plated, Less Washer	100
8032	1-1/2" x 1-3/8" Die Cast Nut, Chrome Plated	50
8033	1-1/2" x 1-1/2" Die Cast Nut, Chrome Plated	50
8033LW	1-1/2" x 1-1/2" Die Cast Nut, Chrome Plated, Less Washer	100
8034	2" x 2" Die Cast Nut, Chrome Plated	25

**Nuts & Washers Individual Bag**

Product No.	Description	Ctn. Qty.
HD8030C	Zinc Nut & Washer Slip Joint 1-1/4", Ind. Printed Bag, Display Box	20
HD8033C	Zinc Nut & Washer Slip Joint 1-1/2", Ind. Printed Bag, Display Box	20
HD8031C	Zinc Nut & Washer Slip Joint 1-1/4" x 1-1/2", Ind. Printed Bag, Display Box	20

Bulk Washers

Product No.	Description	Ctn. Qty.
7195	1-1/2" flanged washer, 1-5/16" I.D. x 1-23/32" O.D.	100
7196	1-1/4" beveled S.J. washer, 1-1/4" I.D. x 1-29/64" O.D. x 7/64" thick.	100
7198	1-1/2" x 1-1/4" beveled washer, bulk	100
9002	Plastic Washers	100
7202	1-1/4" Regular, rubber, 1-1/4" I.D. x 1-7/16" O.D., 5/32" thick	100
7203	1-1/2" Regular, rubber, 1-1/2" I.D. x 1-3/4" O.D., 3/16" thick	100
7204	2" Regular, rubber, 1-15/16" I.D. x 2-1/8" O.D., 3/16" thick	100
7210	1-1/2" x 1-1/4", rubber, 1-1/4" I.D. x 1-3/4" O.D., 5/32" thick	100

**Individual Bagged Washers**

Product No.	Description	Ctn. Qty.
HD7202C	Rubber Slip Joint Washer 1-1/4", 3/Card, Ind. Printed Bag, Display Box	20
HD7203C	Rubber Slip Joint Washer 1-1/2", 3/Card, Ind. Printed Bag, Display Box	20
HD7210	Rubber Slip Joint Reducing Washers 1-1/2" x 1-1/4", Ind. Printed Bag, Display Box	25





Flanges

Product No.	Description	Ctn. Qty.
Low Pattern Chrome Plated		
1097	3/8" O.D. for 1/4" Nom	50
1098	1/2" O.D. for 3/8" Nom	50
1099	5/8" O.D. for 1/2" Nom	50
1099A	7/8" O.D. For 3/4" Nom Copper	50
H1099A	Flat Escutcheon 7/8" Copper, Bagged	20
1099AB	7/8" O.D. For 3/4" Nom	250
1099B	5/8" O.D. For 1/2" Nom	250
1100	3/8" NPT	50
HD1831C	Flange 3/8" IPS, Bagged	20
1100B	3/8" NPT	250
1101	1/2" NPT	50
1101R	Rubber Escutcheon	50
HD75C	Flange 1/2" IPS, Bagged	20
1101A	3/4" NPT	50
HD76C	5/8" O.D. for 1/2" Nom Copper, Bagged	20
1101AA	1" NPT	50
1101B	1/2" NPT	250
1102	1-1/4" O.D.	50
HD72C	1/4" O.D. Tube, Bagged	20
1104	1-1/2" O.D.	50
HD73C	1/2" O.D. Tube, Bagged	20
1104A	2" O.D.	50
1105	1-1/4" NPT	50
1106	1-1/2" NPT	50
1106A	2" NPT	50
1106B	1-1/2" NPT	250
High Pattern Chrome Plated		
1107A	3/8" O.D. For 1/4" Nom	50
1107B	1/2" O.D. For 3/8" Nom	50
1107C	5/8" O.D. For 1/2" Nom	50
1107D	11/16" O.D. For Sweat Extension	50
1109	3/8" I.P.S.	50
1110	1/2" NPT	50
1114	1-1/4" O.D.	50
1114A	1-1/4" NPT	50
1115	1-1/2" O.D.	50
1115A	1-1/2" NPT	50
Box Pattern Chrome Plated		
1116	1-1/4" O.D.	12
H1116	1-1/4" O.D. Tube In Bag, Display Box	20
1116A	1-1/4" NPT	12
1117	1-1/2" O.D.	12
H1117	1-1/2" O.D. Tube In Bag, Display Box	20
1117A	1-1/2" NPT	12
1118	2" Deep Flange	12
1119	1/2" Chrome Plated Sleeve	4



Floor And Ceiling Plates

Product No.	Description	Ctn. Qty.
Copper Tube Sizes – H=Heavy Grade		
5340	1/2" Tube	12
HD5340C	1/2" Tube, Bagged	20
5340H	5/8" O.D. .5 Nom	12
5341	3/4" Tube	12
HD5341C	3/4" Tube, Bagged	20
5341H	7/8" O.D. 3/4" Nom	12
5342	1-1/8" O.D.	12
5342H	1-1/8" O.D. 3/4"	12
5343	1-3/8" O.D.	12
5343H	1-3/8" O.D. 1-1/4"	12
5344	1 1/2" Nom	12
5344H	1-5/8" O.D. 1.5	12
5345H	2-1/8" O.D. 2 Nom	12
5346H	2-5/8" O.D. 2.5	12
5347H	3-1/8" O.D. 3 Nom	12
Iron Pipe Sizes – H=Heavy Grade		
5350	3/8" IPS	12
5350H	3/8" IPS	12
5351	1/2" IPS	12
HD5351C	1/2" IPS, Bagged	20
5351H	1/2" IPS	12
5352	3/4" IPS	12
HD5352C	3/4" IPS, Bagged	20
5352H	3/4" IPS	12
5353	1" IPS	12
HD5353C	1" IPS, Bagged	24
5353H	1" IPS	20
5354	1-1/4" IPS	12
HD5354C	1-1/4" IPS, Bagged	20
5354H	1-1/4" IPS	12
5355	1-1/2" IPS	12
HD5355C	1-1/2" IPS, Bagged	20
5355H	1-1/2" IPS	12
5356	2" IPS	12
HD5356C	2" IPS, Bagged	20
5356H	2" IPS	12
5357H	2-1/2" IPS	12
5358H	3" IPS	12
5359H	3-1/2" IPS	12
5360H	4" IPS	12



Plastic Split Flange

Product No.	Description	Ctn. Qty.
Copper Tube Sizes		
5340P	1/2" Nom	12
5341P	3/4" Nom	12
5342P	1" Nom	12
Iron Pipe Sizes		
5351P	1/2" IPS	12
5352P	3/4" IPS	12
5353P	1" IPS	12
5354P	1-1/4" IPS	12
5355P	1-1/2" IPS	12
5356P	2" IPS	12



Shower Drains

Product No.	Description	Ctn. Qty.
1268	Shower Drain, Brass Body w/ 3-1/2" Grid, 2", Type M to Caulk	10



Strainers

Product No.	Description	Ctn. Qty.
1256	Strainer w/ 3 Prongs, 1-7/8"	25
1257	Strainer w/ 3 Prongs, 1-5/8"	25



Accessories

Product No.	Description	Ctn. Qty.
6200C	1/8" x 24" Graphite Twist Packing for Faucets, Valves & Pumps	48
7633C	6' High Pressure Washing Machine Hose	6

SPECIALTY SINK REPAIR



Drum Trap Covers

Product No.	Description	Ctn. Qty.
1023	3-1/4" - 4" Adj. Drum Trap Cover (Style A) w/ 5-1/4" Stainless Steel Cover & Rubber Gasket	10
1024	3-1/4" - 4" Adj. Drum Trap Cover (Style B) w/ 5-1/4" Stainless Steel Cover & Rubber Gasket	10



Sink Hole Covers

Product No.	Description	Ctn. Qty.
1226	2" Sink Hole Cover w/ 2-Piece Stainless Steel Head	12
1227	1-3/4" Sink Hole Cover w/ 2-Piece Stainless Steel Head	24
1228	1-3/4" Sink Hole Cover w/ 1-Piece Stainless Steel Head	24
1228E	1-3/4" Sink Hole Cover w/ 1-Piece Chrome Plated Steel Head	24



#202C shown

Accessories

Product No.	Description	Ctn. Qty.
7983	Dishwasher Disposal Hose Connector	50
8636	1/2" NPT x 1/4" NPT Basin Cock Coupling Nut	25
202C	Replacement Spray Head	12
2403E	27" Stainless Steel Fit-All Hexagon Lug Lavatory Legs w/ Escutcheons for China Fixtures (one pair)	1
7536C	1" - 1-3/8" Fit-All White Sink Stopper w/Metal Ring	24

SPECIALTY BATHTUB REPAIR



Add-On Showers

Product No.	Description	Ctn. Qty.
59	26" x 45" Chrome Plated Brass Ad-On Shower Frame w/ Wall & Ceiling Supports. 3/4" Diameter	1
R100	26" x 45" Chrome Plated Brass Ad-On Shower Frame w/ Wall & Ceiling Supports for Fixture w/Bath Faucet in Tub Includes No. 355 Tub Spout, No. 126WS Shower Head w/ 3/4" NPT, 3-3/8" Centers. 3/4" Diameter	1
104	Add-On Shower w/ No. 353 Tub Spout, 3/4" NPT w/ 3/4" x 1/2" Face Bushing	1
107	1/2" x 21" Bent Riser Add-On Basement Shower w/Soap Dish	1



Shower Heads & Tub Spouts

Product No.	Description	Ctn. Qty.
122WS	Chrome Plated Brass Water Saving Shower Head	1
126CWS	Chrome Plated Plastic Water Saving Shower Head w/ Plastic Ball Joint	6
350	Chrome Plated Brass Self-Closing Shower Valve w/ Pull Chain	1
351C	Chrome Plated Die Cast Diverter Spout w/ Personal Shower Fitting w/ 3/4" x 1/2" Face Bushing	12
355	Tub Faucet for No. R100, Add-On Shower Frames	1
359A	Chrome Plated Brass Diverter Spout, 3/4" NPT Wall Connection w/ 3/4" x 1/2" Brass Face Bushing	12

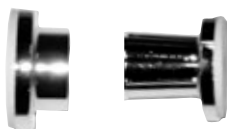

#80 shown

Shower Rods

Product No.	Description	Ctn. Qty.
43LF	5' Aluminum Shower Rod, Less Flanges	50
45C	5' Aluminum Shower Rod, w/ Flanges	6
80	Shower Rod Flange w/ Screws (bagged 1 pair)	24
83	Adjustable Plastic Shower Rod Holder	50
1056	1-3/8" Plated Steel Shower Curtain Pins	100



#7537C shown

Accessories

Product No.	Description	Ctn. Qty.
89CF	6" Shower Arm w/ Die Cast Flange	20
89F	6" Shower Arm w/ Flange	10
2565	1/2" x 21-1/2" Offset Bath Supply w/ Nuts, Washers & Floor Flange (pair)	1
2566	9/16" x 2-1/2" Offset Bath Supply w/ Nuts Washers & Floor Flange (pair)	1
7537C	1-1/2" -2" White Tub Stopper w/ Metal Ring	24



Category 18

Pneumatic Pipe Plugs

Cherne® pneumatic Test Ball® and Muni-Ball® pipe plugs have been the contractor's choice for more than 55 years. Used in residential DWV systems, sanitary/storm sewers, Cherne® pneumatic pipe plugs do it all! Larger sizes are available with our patented Rupture Disc Technology, which prevents over-inflation. This eliminates plug damage due to over-inflation and enhances user safety.

NEW and Improved I-Series® Plugs (see page 183)

The **Cherne® I-Series®** plugs include several enhancements to make the product easier and safer to operate. Its smaller deflated diameter makes it easier to insert into tight manhole openings, while improved hardware adds strength over competing products.

Design Changes on Plugs 24-48" an Larger

- **New 3/4" eyebolts** for added strength.
- **Shorter overall length** makes it more maneuverable.
- **Additional bypass sizes available – now offering 6" and 8" bypasses on larger sizes** for better flow rates.
- **All plugs feature our patented, field-repairable, Rupture Disc technology**, which eliminates the risk and danger of over-inflation due to faulty gauges or user error.





I-Series® Plugs

- Smaller deflated diameter.
- Improved hardware for more strength.
- Shorter length.
- Additional bypass sizes available.
- 20-40" and larger sizes feature patented, field-repairable rupture disc technology to eliminate over-inflation risk

Product No.	Size	Description	Ctn. Qty.	Back Pressure P.S.I.	Feet of Head
395088	4-8"	Test Ball® plug	1	13	30
395128	6-12"	Test Ball® plug	1	13	30
395168	8-16"	Test Ball® plug	1	13	30
395248	12-24"	Test Ball® plug	1	13	30
310408	20-40"	Test Ball® plug	1	8.7	20
310488	24-48"	Test Ball® plug	1	10	23
310600	24-60"	Test Ball® plug	1	6	14
310728	48-72"	Test Ball® plug	1	6	14
310968	54-96"	Test Ball® plug	1	6	14
355088	4-8"	Muni-Ball® plug w/ 3/4" Bypass	1	13	30
355128	6-12"	Muni-Ball® plug w/ 1" Bypass	1	13	30
355168	8-16"	Muni-Ball® plug w/2" Bypass	1	13	30
355248	12-24"	Muni-Ball® plug w/2" Bypass	1	13	30
312408	20-40"	Muni-Ball® plug w/2" Bypass	1	8.7	20
314408	20-40"	Muni-Ball® plug w/4" Bypass	1	8.7	20
316408	20-40"	Muni-Ball® plug w/6" Bypass	1	8.7	20
314488	24-48"	Muni-Ball® plug w/4" Bypass	1	10	23
316488	24-48"	Muni-Ball® plug w/6" Bypass	1	10	23
314728	48-72"	Muni-Ball® plug w/4" Bypass	1	6	14
316728	48-72"	Muni-Ball® plug w/6" Bypass	1	6	14
318728	48-72"	Muni-Ball® plug w/8" Bypass	1	6	14
314968	54-96"	Muni-Ball® plug w/4" Bypass	1	6	14
316968	54-96"	Muni-Ball® plug w/6" Bypass	1	6	14
318968	54-96"	Muni-Ball® plug w/8" Bypass	1	6	14

Air Loc® plug versions also available. Consult factory.



Single-Size Test-Ball® Plugs

- Made of natural rubber for excellent expansion and memory.
- Seals both round and out-of-round pipe.
- Zinc-plated steel chain and ring handle acts as an anchor to prevent plug from sliding down a line.
- Fits easily through test tees, sanitary tees, floor drains, and other "tight" situations.
- Broader expansion range than mechanical plugs.

Product No.	Size	Description	Ctn. Qty.	Back Pressure P.S.I.	Feet of Head
270008	3/4"-1-1/4"	Test-Ball® Plug	6	17 PSI	40 FT
270016	1-1/4"-1-1/2"	Test-Ball® Plug	6	13 PSI	30 FT
270024	2"	Test-Ball® Plug	6	13 PSI	30 FT
270108	2-1/2"	Test-Ball® Plug	6	13 PSI	30 FT
270032	3"	Test-Ball® Plug	6	13 PSI	30 FT
270040	4"	Test-Ball® Plug	6	13 PSI	30 FT
270059	5"	Test-Ball® Plug	1	13 PSI	30 FT
270067	6"	Test-Ball® Plug	1	13 PSI	30 FT





Bulk Test-Ball® Plugs – Individual Display Bags*

- Same great Test-Ball® plug in bulk packaging.
- Preprinted bag designed for use with peg hook displays.

* Bulk Test-Ball® Plugs MUST be ordered in quantities of 24 plugs.

Product No.	Size	Description	Ctn. Qty.	Back Pressure P.S.I.	Feet of Head
240018	1-1/4"-1-1/2"	Test-Ball® Plug	24	13 PSI	30 FT
240028	2"	Test-Ball® Plug	24	13 PSI	30 FT
240038	3"	Test-Ball® Plug	24	13 PSI	30 FT
240048	4"	Test-Ball® Plug	24	13 PSI	30 FT



Single-Size Test-Ball® Plugs (Underground)

- Designed to block sewer flow or for use as a back plug for sewer air testing.
- Natural rubber material for excellent expansion and memory.
- Seals both round and out-of-round pipe.
- Removable inflation valve can be replaced if damaged or replaced with quick disconnect fitting.
- Features an eye-bolt for use with a poly-lift line.

Product No.	Size	Description	Ctn. Qty.	Back Pressure P.S.I.	Feet of Head
041386	8"	Test-Ball® Plug	1	17 PSI	40 FT
041394	10"	Test-Ball® Plug	1	17 PSI	40 FT
041408	12"	Test-Ball® Plug	1	17 PSI	40 FT



Multi-Size Test-Ball® Plugs (Plumbing)

- One size fits multiple pipe diameters, doing the job of 2+ single-size plugs.
- Use to block flow (water DWV test) or as a back plug for sewer air testing.
- Seals both round and out-of-round pipe.
- Zinc-plated steel chain and ring handle acts as an anchor to prevent plug from sliding down a line.

Product No.	Size	Description	Ctn. Qty.	Back Pressure P.S.I.	Feet of Head
276128	1-1/4"-2"	Test-Ball® Plug	6	17 PSI	40 FT
276238	2"- 3"	Test-Ball® Plug	6	17 PSI	40 FT
276348	3"- 4"	Test-Ball® Plug	6	17 PSI	40 FT
276468	4"- 6"	Test-Ball® Plug	6	17 PSI	40 FT



Multi-Size Test-Ball® Plugs (Underground)

- One plug fits multiple pipe diameters.
- Made of natural rubber for excellent expansion and memory.
- Seals both round and out-of-round pipe.
- Removable inflation valve can be replaced if damaged or replaced with quick disconnect fitting.
- Use to block flow or as a back plug for sewer air testing.

Product No.	Size	Description	Ctn. Qty.	Back Pressure P.S.I.	Feet of Head
275048	4"- 6"	Test-Ball® Plug	1	17 PSI	40 FT
275058	6"- 8"	Test-Ball® Plug	1	17 PSI	40 FT
395128	6"- 12"	Test-Ball® Plug	1	13 PSI	30 FT
275088	8"- 12"	Test-Ball® Plug	1	11 PSI	25 FT
275128	12"- 18"	Test-Ball® Plug	1	11 PSI	25 FT
395248	12"- 24"	Test-Ball® Plug	1	13 PSI	30 FT





Clean-Seal® Plugs

- Threads into test tee, eliminating water backslash.
- Removable snifter valve inflation fitting is replaceable.
- Made from long-lasting natural rubber.
- Seals both cast-iron and plastic pipe

Product No.	Size	Description	Ctn. Qty.	Back Pressure P.S.I.	Feet of Head
271508	1-1/2"	Clean-Seal® Plug	6	13 PSI	30 FT
271705	2"	Clean-Seal® Plug	6	13 PSI	30 FT
271713	3"	Clean-Seal® Plug	6	13 PSI	30 FT
271721	4"	Clean-Seal® Plug	6	13 PSI	30 FT
271758	6"	Clean-Seal® Plug	1	13 PSI	30 FT



Long Test-Ball® Plugs

- Designed for waste stack testing from floor drain to sewer pipe.
- Long enough to seal wye vertical riser and sewer run.
- Includes 3' extension hose.
- Ring and chain assembly prevents plug from sliding down a line.

Product No.	Size	Description	Ctn. Qty.	Back Pressure P.S.I.	Feet of Head
271020	2"	Long Test-Ball® Plug	1	13 PSI	30 FT
271039	3"	Long Test-Ball® Plug	1	13 PSI	30 FT
271047	4"	Long Test-Ball® Plug	1	13 PSI	30 FT
271055	5"	Long Test-Ball® Plug	1	13 PSI	30 FT
271063	6"	Long Test-Ball® Plug	1	13 PSI	30 FT
271098	4"- 6"	Long Test-Ball® Plug	1	13 PSI	30 FT



MS2® Long Test-Ball® Plugs

- Designed for waste stack testing from floor drain to sewer pipe.
- Long enough to seal wye vertical riser and sewer run.
- Multi-stage deflation eliminates backslash.
- Works in multiple pipe diameters.
- Pressure relief valve to safeguard against over-inflation.
- Nylon strap and safety handle prevents plug from sliding down a line.

Product No.	Size	Description	Ctn. Qty.	Back Pressure P.S.I.	Feet of Head
274518	2"- 3"	MS2® Plug	1	13 PSI	30 FT
274526	3"- 4"	MS2® Plug	1	13 PSI	30 FT
274534	4"- 6"	MS2® Plug	1	13 PSI	30 FT





Single-Size Muni-Ball® Plugs (Underground)

- Works in all types of pipe.
- Easily converts to an air test plug with use of a conversion kit.
- Durable natural rubber construction seals the roughest of surfaces.
- 8", 10", 12" and 15" plugs include two port plug for easy use in sewer air tests.
- Threaded aluminum bypass.



Product No.	Size	Description	Ctn. Qty.	Back Pressure P.S.I.	Feet of Head
262008	1-1/2"	Muni-Ball® Plug 1/8" Bypass	1	22 PSI	50 FT
262010	2"	Muni-Ball® Plug 1/8" Bypass	1	22 PSI	50 FT
262021	3"	Muni-Ball® Plug 3/4" Bypass	1	22 PSI	50 FT
262048	4"	Muni-Ball® Plug 3/4" Bypass	1	22 PSI	50 FT
262064	6"	Muni-Ball® Plug 1-1/2" Bypass	1	13 PSI	30 FT
262080	8"	Muni-Ball® Plug 3" Bypass	1	13 PSI	30 FT
262110	10"	Muni-Ball® Plug 3" Bypass	1	13 PSI	30 FT
262129	12"	Muni-Ball® Plug 3" Bypass	1	13 PSI	30 FT
262137	15"-16"	Muni-Ball® Plug 3" Bypass	1	13 PSI	30 FT
262188	18"	Muni-Ball® Plug 4" Bypass	1	13 PSI	30 FT
262218	21"	Muni-Ball® Plug 4" Bypass	1	13 PSI	30 FT
262242	24"	Muni-Ball® Plug 4" Bypass	1	13 PSI	30 FT



Multi-Size Muni-Ball® Plugs (Underground)

- Work in all types of pipe.
- Durable natural rubber construction seals the roughest of surfaces.
- Threaded aluminum bypass.
- Easily converts to an air test plug with the use of a conversion kit.
- One plug fits multiple pipe diameters.



Product No.	Size	Description	Ctn. Qty.	Back Pressure P.S.I.	Feet of Head
262008	1-1/2"	Muni-Ball® Plug 1/8" Bypass	1	22 PSI	50 FT
265048	4"- 6"	Muni-Ball® Plug 3/4" Bypass	1	17 PSI	40 FT
265068	6"- 8"	Muni-Ball® Plug 1-1/2" Bypass	1	17 PSI	40 FT
265078	8"- 10"	Muni-Ball® Plug 2" Bypass	1	17 PSI	40 FT
265098	8"- 12"	Muni-Ball® Plug 2" Bypass	1	17 PSI	40 FT
265128	12"- 18"	Muni-Ball® Plug 4" Bypass	1	13 PSI	30 FT





Category 19

Mechanical Pipe Plugs

Cherne® mechanical test plugs can be used in a wide variety of applications including DWV and stack testing. With a variety of end-of-pipe and in-pipe options available, it's easy to find the right mechanical test plug for the job.



Gripper® Mechanical Plugs

- Ideal for plumbing system tests.
- Easy to install with extra-large wing nut.
- Inside of pipe seals inside pipe as far as needed.
- Made with glass-reinforced ABS plastic.
- End-of-pipe seals only at the end of a pipe, preventing plug from falling into stack.

Product No.	Size	Description	Ctn. Qty.	Back Pressure P.S.I.	Feet of Head
270210	1-1/2"	End of Pipe Gripper® Plug	10	17 PSI	40FT
270229	2"	End of Pipe Gripper® Plug	10	17 PSI	40FT
270237	3"	End of Pipe Gripper® Plug	10	17 PSI	40FT
270245	4"	End of Pipe Gripper® Plug	10	17 PSI	40FT
270261	6"	End of Pipe Gripper® Plug	5	17 PSI	40FT
270270	8"	End of Pipe Gripper® Plug	1	17 PSI	40FT
270296	4"	Inside of Pipe Gripper® Plug	10	17 PSI	40FT
270253	6"	Inside of Pipe Gripper® Plug	5	17 PSI	40FT
270288	8"	Inside of Pipe Gripper® Plug	1	17 PSI	40FT



Hub-Fit Gripper® Plugs

- Ideal for use in hub fittings and in bell-end pipe.
- Pressure rated for conducting DWV tests.
- Yellow color enhances visibility in pipe.
- Made with glass-reinforced ABS plastic and natural rubber O-ring.

Product No.	Size	Description	Ctn. Qty.	Back Pressure P.S.I.	Feet of Head
270528	2"	Hub-Fit Gripper® Plug	10	13 PSI	30FT
270538	3"	Hub-Fit Gripper® Plug	10	13 PSI	30FT
270548	4"	Hub-Fit Gripper® Plug	10	13 PSI	30FT



Clean-Out Gripper® Plugs

- Patented threaded O-ring ensures airtight seal.
- Stainless steel hardware prevents corrosion.
- Black color blends well with cast-iron pipe.
- NPT-sized, including hard-to-find 3-1/2".
- Guaranteed to seal all damaged threads.
- Made with glass-reinforced ABS plastic and natural rubber O-ring.

Product No.	Size	Description	Ctn. Qty.	Back Pressure P.S.I.	Feet of Head
270168	2"	Plug Seals 2-1/2" Threaded Opening	10	17 PSI	40FT
270178	3"	Plug Seals 3-1/2" Threaded Opening	10	17 PSI	40FT
270138	3-1/2"	Plug Seals 4" Threaded Opening	10	17 PSI	40FT
270188	4"	Plug Seals 4-1/2" Threaded Opening	10	17 PSI	40FT





T-Handle Aluminum Gripper® Plugs (Underground)

- Can be used in long-term applications.
- Chemical-resistant neoprene O-ring.
- Made of heavy-duty aluminum.
- Bypass can be used to conduct sewer air pressure test.

Product No.	Size	Description	Ctn. Qty.	Back Pressure P.S.I.	Feet of Head
272949	6"	Gripper® Plug 1/4" Bypass	1	17 PSI	40FT
272957	8"	Gripper® Plug 3/4" Bypass	1	17 PSI	40FT
272965	10"	Gripper® Plug 3/4" Bypass	1	17 PSI	40FT
272973	12"	Gripper® Plug 3/4" Bypass	1	13 PSI	30FT
272981	15"	Gripper® Plug 3/4" Bypass*	1	13 PSI	30FT
272998	18"	Gripper® Plug 3/4" Bypass*	1	8.7 PSI	20FT

*Concrete and clay pipe sizes only.



T-Handle Aluminum Gripper® Plugs (Underground)

- Can be used in long-term applications.
- Chemical-resistant neoprene O-ring.
- Made of heavy-duty aluminum.

Product No.	Size	Description	Ctn. Qty.	Back Pressure P.S.I.	Feet of Head
272892	6"	Gripper® Plug (Non By-Pass)	1	17 PSI	40FT
272906	8"	Gripper® Plug (Non By-Pass)	1	17 PSI	40FT
272914	10"	Gripper® Plug (Non By-Pass)	1	17 PSI	40FT
272922	12"	Gripper® Plug (Non By-Pass)	1	13 PSI	30FT
272930	15"	Gripper® Plug (Non By-Pass)*	1	13 PSI	30FT
272888	18"	Gripper® Plug (Non By-Pass)*	1	8.7 PSI	20FT

*Concrete and clay pipe sizes only.



Econ-O-Grip® Plugs

- Cost-effective method for plugging open-ended pipe.
- Natural rubber O-ring.
- Effective pipe dust cover.
- Not recommended for pressure tests.

Product No.	Size	Description	Ctn. Qty.	Back Pressure P.S.I.	Feet of Head
271519	1-1/2"	Econ-O-Grip® Plug	10	2 PSI	5FT
271527	2"	Econ-O-Grip® Plug	10	2 PSI	5FT
271535	3"	Econ-O-Grip® Plug	10	2 PSI	5FT
271543	4"	Econ-O-Grip® Plug	10	2 PSI	5FT
271551	5"	Econ-O-Grip® Plug	5	1 PSI	2FT
271578	6"	Econ-O-Grip® Plug	5	1 PSI	2FT





Petro Econ-O-Grip® Plugs (Chemical Resistant)

- Chemical-resistant Nitrile rubber and stainless steel hardware.
- Not recommended for pressure tests.

Product No.	Size	Description	Ctn. Qty.	Back Pressure P.S.I.	Feet of Head
273318	1-1/2"	Stainless Steel Econ-O-Grip® Plug	2	2 PSI	5FT
273328	2"	Stainless Steel Econ-O-Grip® Plug	2	2 PSI	5FT
273338	3"	Stainless Steel Econ-O-Grip® Plug	2	2 PSI	5FT
273348	4"	Stainless Steel Econ-O-Grip® Plug	2	2 PSI	5FT
273358	5"	Stainless Steel Econ-O-Grip® Plug	1	1 PSI	2FT
273368	6"	Stainless Steel Econ-O-Grip® Plug	1	1 PSI	2FT



Sure-Grip® Plugs

- Polypropylene construction with natural rubber O-ring.
- Can be used as a permanent or temporary plug.
- Fits all type of pipe at nominal sizes.

Product No.	Size	Description	Ctn. Qty.	Back Pressure P.S.I.	Feet of Head
271158	1-1/2"	Sure-Grip® Plug	10	22 PSI	50FT
271208	2"	Sure-Grip® Plug	10	22 PSI	50FT
271308	3"	Sure-Grip® Plug	10	13 PSI	30FT
271408	4"	Sure-Grip® Plug	10	13 PSI	30FT



Kwik 'N Sure® Plugs

- Works in all types of pipe.
- Wing nut on 3/8" – 1-1/4" sizes.
- Hex nut on 1.5" through 5" sizes.
- Works well for plugging water line stub-outs.
- Natural rubber O-ring.

Product No.	Size	Description	Ctn. Qty.	Back Pressure P.S.I.	Feet of Head
269832	0.39"	Kwik 'n Sure® Plug	10	185 PSI	428FT
269840	1/2"	Kwik 'n Sure® Plug	10	180 PSI	415FT
269867	3/4"	Kwik 'n Sure® Plug	10	180 PSI	415FT
269875	1"	Kwik 'n Sure® Plug	10	40 PSI	92FT
269883	1-1/4"	Kwik 'n Sure® Plug	10	112 PSI	258FT
269891	1-1/2"	Kwik 'n Sure® Plug	10	88 PSI	203FT
269905	2"	Kwik 'n Sure® Plug	5	112 PSI	258FT
269913	2-1/2"	Kwik 'n Sure® Plug	5	72 PSI	166FT
269921	3"	Kwik 'n Sure® Plug	5	28 PSI	65FT
269948	4"	Kwik 'n Sure® Plug	5	24 PSI	55FT
269956	5"	Kwik 'n Sure® Plug	5	8 PSI	18FT





Monitor Well™ Locking Plugs

- Designed to seal monitor wells.
- Sized to seal Schedule 40 piping.
- 2" and 4" sizes can also seal schedule 5 plastic and stainless steel pipe.
- Yellow chromate-coated locking latch accepts Cherne's solid brass padlock or No. 2 Master® padlock.
- Meets all EPA requirements for locking plugs.
- Made with chemical-/petroleum-resistant Estaloc® plastic top/bottom plates and Nitrile sealing O-ring.
- Comes with stainless steel carriage bolt.

Product No.	Size	Description	Ctn. Qty.	Back Pressure P.S.I.	Feet of Head
271648	1"-1-1/4"	Monitor Well™ Locking Plug	12	6.5 PSI	15FT
271675	2"	Monitor Well™ Locking Plug	50	6.5 PSI	15FT
271669	3"	Monitor Well™ Locking Plug	75	6.5 PSI	15FT
271683	4"	Monitor Well™ Locking Plug	25	6.5 PSI	15FT
271691	6"	Monitor Well™ Locking Plug	8	6.5 PSI	15FT
271735	8"	Monitor Well™ Locking Plug	1	6.5 PSI	15FT
112941		Padlock with Key	1		



Tub Waste & Overflow Plugs

- Used to isolate bath wastes for air/water testing.
- Natural rubber gasket creates air-tight seal.
- For use on center hole drains overflow.
- Yellow ABS plastic ensures easy job site recognition.
- 3/8" Drain thread.
- 1/4" Overflow thread.

Product No.	Size	Description	Ctn. Qty.	Back Pressure P.S.I.	Feet of Head
012678		Tub Plug Set (Overflow & Drain)	12	5	13





Category 20

Test Equipment, Drain, Flushers, and Accessories

Everything from replacement chains and extension hoses to poly lift lines and gauges. Innovation and quality has made Cherne the contractor's choice for more than 55 years. Here's to the next 55!



Econ-O-Pump™ Test Pump

- Low cost version for the infrequent user.
- 0-140 PSI gauge.
- Traditional thumb lock.
- All metal construction.

Product No.	Size	Description	Ctn. Qty.
273888		Econ-O-Pump™ Test Pump	1



Air-Max® Test Pumps

- Gauge raised from base for protection.
- Durable steel barrel.
- Textured steel base prevents feet from slipping.
- Durable, no-kink hose.

Product No.	Size	Description	Ctn. Qty.
273958		Air-Max® Test Pump	1
034588		Replacement Hose Assembly w/ Thumb Lock	1



Air-Max® Pro HV Test Pumps

- Large barrel for maximum volume means fewer strokes to inflate plug.
- 0-60 PSI gauge for most accurate plug pressure readings.
- All-metal thumb lock for durability.
- Hose strain relief to transfer tension from hose to the barrel.
- Forged steel barrel for extra toughness.
- Large, three-point base for maximum stability.
- Rubber cover to protect gauge from damage.
- Solid wood handle for greater comfort and durability.
- Durable, no-kink hose.

Product No.	Size	Description	Ctn. Qty.
273968		Air-Max® Pro HV Test Pump	1
055728		Replacement Hose Assembly w/ Thumb Lock	1





Smoke Fluid Testing Products

Product No.	Description	Ctn. Qty.
303018	Smoke Fluid Smoke Blower Kit: Honda Engine	1
303008	Smoke Fluid Smoke Blower Kit: Briggs & Stratton Engine	1
065808	Smoke Fluid: One Gallon	4
065818	Smoke Fluid: Five Gallons	1
065828	Smoke Fluid: Fifty-Five Gallon Drum	1



Smoke Generator (Bomb) Testing Products

Product No.	Description	Ctn. Qty.
303550	Smoke Bomb Smoke Blower Kit: Briggs & Stratton Engine	1
072608	Smoke Bomb: 30 Seconds	12
072618	Smoke Bomb: 60-Seconds	12
072628	Smoke Bomb: 3 Minutes	12
072638	Smoke Bomb: 3 Minutes Double Wick	12



Smoke Testing Accessories

Product No.	Description	Ctn. Qty.
14722	Smoke Blower Replacement Fan (Left Pitch)	1
58368	Smoke Bomb Holding Cage	1
36308	Smoke Fluid Conversion Kit From Smoke Bomb Briggs & Stratton Engine	1
38558	Smoke Fluid Conversion Kit From Smoke Bomb Honda Engine Pre 2006	1
61028	Smoke Fluid Conversion Kit From Smoke Bomb Honda Engine 2006 And Newer	1



Clog-Buster® Drain Flusher

- Unclogs drain pipes in seconds.
- Simply remove aerator from faucet spigot and attach faucet adapter to garden hose.
- Attaches to standard garden hose fitting.
- Natural rubber body provides excellent seal.

Product No.	Size	Description	Ctn. Qty.
303127	1"-2"	Clog-Buster® Drain Flusher	1
303135	1-1/2"-3"	Clog-Buster® Drain Flusher	1
303143	4"- 6"	Clog-Buster® Drain Flusher	1
006193		Clog-Buster® Faucet Adapter	1



Manometer

- Used for final test of DWV pipe and to test gas lines.
- Reads in 1/10" increments
- Measures water columns from 0" to 16".

Product No.	Size	Description	Ctn. Qty.
010205		Manometer	1





Replacement Chains

- Replacement assemblies for Test-Ball plugs.
- Rings prevent test plugs from sliding down a line.
- Includes a safety tag.

Product No.	Description	Ctn. Qty.
059708	2" Ring With 12" Chain	1
059718	3" Ring With 12" Chain	1
059728	4" Ring With 12" Chain	1
059748	6" Ring With 12" Chain	1
059758	2" Ring With 24" Chain	1
059768	3" Ring With 24" Chain	1
059778	4" Ring With 24" Chain	1
059788	5" Ring With 24" Chain	1
059798	6" Ring With 24" Chain	1



Gauges

- Features 2" unbreakable plastic face.
- All connections constructed of high-quality brass.
- Inflator valve is replaceable.

Product No.	Description	Ctn. Qty.
000698	0-15 psi Gauge 2" Face 0.1 psi Increments	1
000628	0-30 psi Gauge 2" Face 0.5 psi Increments	1
000638	0-60 psi Gauge 2" Face 1 psi Increments	1
000648	0-100 psi Gauge 2" Face 2 psi Increments	1



Gauges With 3/4" FNPT Test Body

- Features 2" unbreakable plastic face.
- All connections constructed of high-quality brass.
- Inflator valve is replaceable.

Product No.	Description	Ctn. Qty.
024568	0-15 psi Gauge 2" Face 0.1 psi Increments	1
019698	0-30 psi Gauge 2" Face 0.5 psi Increments	1
019708	0-60 psi Gauge 2" Face 1 psi Increments	1
019718	0-100 psi Gauge 2" Face 2 psi Increments	1
000658	Hex Test Body 1/8" Tap	1
068 527	Replacement Snifter Valve 1/8"	1



Extension Hose With Gauge, 3/16" ID

- Recommended for use with plugs up to 15" in diameter.
- Ideal for plumbing applications
- Standard tire fitting connections.
- 3/16" ID hose.

Product No.	Description	Ctn. Qty.
274218	5' Hose With Gauge 3/16" ID	1
274228	10' Hose With Gauge 3/16" ID	1
274238	20' Hose With Gauge 3/16" ID	1





Hose - 3/16" ID

- Recommended for use with plugs up to 15" in diameter.
- Ideal for plumbing applications.
- Standard tire fitting connections.
- 3/16" ID hose.

Product No.	Description	Ctn. Qty.
274011	2' Hose, 3/16" ID	6
274038	3' Hose, 3/16" ID	6
274008	2' Hose, 3/16" ID Bagged Bulk Pak	24
274018	3' Hose, 3/16" ID Bagged Bulk Pak	24
274054	5' Hose, 3/16" ID	1
274100	10' Hose, 3/16" ID	1
274208	20' Hose, 3/16" ID	1
055816	Deflator With Clamp (Female End)	1
055808	Inflator With Clamp (Male End)	1



Poly Lift Line - 3/16" ID

- Standard tire fitting connections.
- Poly rope designed for raising and lowering plug.
- Ideal for plugs 8" and up.
- 3/16" ID hose.
- Snap hook connects to plug eyebolt.

Product No.	Description	Ctn. Qty.
261084	20' Hose With Poly Lift Line, 3/16" ID	1
261106	30' Hose With Poly Lift Line, 3/16" ID	1
261114	40' Hose With Poly Lift Line, 3/16" ID	1



Poly Lift Line With Gauge - 3/8" ID

- Dump valve for quick deflation.
- Utilizes quick disconnects.
- Poly rope designed for raising and lowering plug.
- Ideal for plugs 8" and larger in diameter.
- Retard gauge protects against "peg out".
- 3/8" ID hose for quicker inflation and deflation.
- Snap hook connects to plug eyebolt.

Product No.	Description	Ctn. Qty.
261398	20' Hose With Poly Lift Line And Gauge, Dump Valve, 3/8" ID	1
261408	30' Hose With Poly Lift Line And Gauge, Dump Valve, 3/8" ID	1
261418	40' Hose With Poly Lift Line And Gauge, Dump Valve, 3/8" ID	1
048468	0-60 psi, 2.5" Dial, Plug Pressure Gauge With Retarded Increments To 160 Psi With Cover	1
053458	0-60 psi, 2.5" Dial, Plug Pressure Gauge With Retarded Increments To 160 Psi	1





Category 21

Pans and Stands

Oatey® Aluminum and Plastic Water Heater Pans can be installed under gas or electric water heaters to protect from water damage. Available with 1" PVC, 1-½" PVC or 1" CPVC drain fittings to allow for connection to indirect drain. Oatey Gas Water Heater Stands allow placement of water heater tanks 18" above the ground as required by the National Fuel Gas Code. Gas Water Heater Stands are constructed of heavy duty 18 gauge spangled galvanized sheet metal.



#34170 shown

Aluminum Water Heater Pan

- Manufactured from prime aluminum and are expertly worked to exact specifications under strict quality control.
- Recommended for gas or electric water heaters.
- Meets requirements of Southern Building Code.
- Exposed edges have been rolled to protect the installer from injury.

Product No.	Size	Description	Ctn. Qty.
Water Heater Pans – 1" CPVC Adapter			
34170	18"	Aluminum Pan – Bulk	6
34171	20"	Aluminum Pan – Bulk	6
34172	22"	Aluminum Pan – Bulk	6
34173	24"	Aluminum Pan – Bulk	6
34174	26"	Aluminum Pan – Bulk	6
34176	28"	Aluminum Pan – Bulk	6
34175	30"	Aluminum Pan – Bulk	6
Water Heater Pans – 1" PVC Adapter (1" inside adapter/ 1-1/2" over adapter)			
34079	18"	Aluminum Pan – Bulk	6
34151	20"	Aluminum Pan – Bulk	6
34152	22"	Aluminum Pan – Bulk	6
34153	24"	Aluminum Pan – Bulk	6
34154	26"	Aluminum Pan – Bulk	6
34156	28"	Aluminum Pan – Bulk	6
34085	30"	Aluminum Pan – Bulk	6
Water Heater Pans With 1" To 1-1/2" PVC Adapter (1" inside adapter / 1-1/2" inside adapter)			
34081	20"	Aluminum Pan – Bulk	6
34082	22"	Aluminum Pan – Bulk	6
34083	24"	Aluminum Pan – Bulk	6
34084	26"	Aluminum Pan – Bulk	6
34103	28"	Aluminum Pan – Bulk	6
Water Heater Pans			
34090	18"	Aluminum Pan Without Hole / Adapter	6
34091	20"	Aluminum Pan Without Hole / Adapter	6
34092	22"	Aluminum Pan Without Hole / Adapter	6
34093	24"	Aluminum Pan Without Hole / Adapter – Bulk	6
34157	24"	Aluminum Pan With Hole / Without Adapter – Bulk	6
34094	26"	Aluminum Pan Without Hole / Adapter	6
34095	30"	Aluminum Pan Without Hole / Adapter	6



#34143 shown

Plastic Water Heater Pan

- Manufactured from semi-flexible, tough and durable .0625" plastic polymer.
- Meets requirements of Southern Building Code.
- Recommended for electric water heaters.

Product No.	Size	Description	Ctn. Qty.
Water Heater Pans With 1" CPVC Adapter			
34160	18"	Plastic Pan	12
34161	20"	Plastic Pan	12
34158	20"	Plastic Pan	12
34162	22"	Plastic Pan	12
34159	22"	Plastic Pan	12
34163	24"	Plastic Pan	12
34164	26"	Plastic Pan	12
34168	28"	Plastic Pan	12
34165	30"	Plastic Pan	12
Water Heater Pans With 1"-1-1/2" PVC Adapter (1" inside adapter / 1-1/2" over adapter)			
34060	18"	Plastic Pan	12
34061	20"	Plastic Pan	12
34062	22"	Plastic Pan	12
34063	24"	Plastic Pan	12
34058	24"	Plastic Pan	6
34064	26"	Plastic Pan	12
34072	28"	Plastic Pan	12
34065	30"	Plastic Pan	12
Water Heater Pans with 1"-1-1/2" Adapter (1" inside adapter / 1-1/2" inside adapter)			
34140	18"	Plastic Pan	12
34141	20"	Plastic Pan	12
34142	22"	Plastic Pan	12
34143	24"	Plastic Pan	12
34144	26"	Plastic Pan	12
34146	28"	Plastic Pan	12
34145	30"	Plastic Pan	12
Water Heater Pans Without Hole and/or Adapter			
34066	22"	Plastic Pan Without Hole / Adapter	12
34119	24"	Plastic Pan With Hole / Adapter	6



Water Heater Pan Adapters

- Available in PVC or CPVC
- 1" & 1-1/2"

Product No.	Size	Description	Ctn. Qty.
34088	1" & 1-1/2"	PVC Adapter (1" inside adapter / 1-1/2" over adapter)	12
34086	1" & 1-1/2"	PVC Adapter (1" inside adapter / 1-1/2" inside adapter)	12
34089	1"	CPVC Adapter	12



#34067 shown

Washing Machine Pan

- Provides protection from washing machine overflow.
- Pans have formed hole to punch out for the furnished, 1" PVC plastic fitting.
- Made from high impact plastic.

Product No.	Size	Description	Ctn. Qty.
34067	28" x 30"	Plastic Pan	12
34051	28" x 30"	Plastic Pan – Bagged	4
34052	28" x 30"	Plastic Pan – Without Fitting	6



Gas Water Heater Stand

- Allows the placement of water heater tanks 18" above the ground as required by the National Fuel Gas Code.
- Constructed of 18 gauge spangled galvanized sheet metal, holds up to 50 gallon water heaters.

Product No.	Size	Description	Ctn. Qty.
34057	21" Square x 18" High	Galvanized Water Heater Stand	4



Category 22

Commercial Drainage

Oatey® commercial drains are designed to stand up to heavy traffic areas. Preformed anchor positions are included in each base design and drain barrels include internal thread that accepts clean-out plugs. Four grate finishes are available: Stainless Steel, Nickel, Chrome and Brass.

ADJUSTABLE COMMERCIAL DRAIN BASES



PVC Barrel With 5" Round Grate

Product No.	Size	Description	Ctn. Qty.
72012	2"	PVC Adj. Commercial Drain w/ 5" SS Grate	1
82012	2"	ABS Adj. Commercial Drain w/ 5" SS Grate	1
72022	2"	PVC Adj. Commercial Drain w/ 5" BR Grate	1
82022	2"	ABS Adj. Commercial Drain w/ 5" BR Grate	1
72052	2"	PVC Adj. Commercial Drain w/ 5" NI Grate	1
82052	2"	ABS Adj. Commercial Drain w/ 5" NI Grate	1
72082	2"	PVC Adj. Commercial Drain w/ 5" CHR Grate	1
82082	2"	ABS Adj. Commercial Drain w/ 5" CHR Grate	1
72013	3" or 4"	PVC Adj. Commercial Drain w/ 5" SS Grate	1
82013	3" or 4"	ABS Adj. Commercial Drain w/ 5" SS Grate	1
72023	3" or 4"	PVC Adj. Commercial Drain w/ 5" BR Grate	1
82023	3" or 4"	ABS Adj. Commercial Drain w/ 5" BR Grate	1
72053	3" or 4"	PVC Adj. Commercial Drain w/ 5" NI Grate	1
82053	3" or 4"	ABS Adj. Commercial Drain w/ 5" NI Grate	1
72083	3" or 4"	PVC Adj. Commercial Drain w/ 5" CHR Grate	1
82083	3" or 4"	ABS Adj. Commercial Drain w/ 5" CHR Grate	1
72014	4"	PVC Adj. Commercial Drain w/ 5" SS Grate	1
82014	4"	ABS Adj. Commercial Drain w/ 5" SS Grate	1
72024	4"	PVC Adj. Commercial Drain w/ 5" BR Grate	1
82024	4"	ABS Adj. Commercial Drain w/ 5" BR Grate	1
72054	4"	PVC Adj. Commercial Drain w/ 5" NI Grate	1
82054	4"	ABS Adj. Commercial Drain w/ 5" NI Grate	1
72084	4"	PVC Adj. Commercial Drain w/ 5" CHR Grate	1
82084	4"	ABS Adj. Commercial Drain w/ 5" CHR Grate	1
72016	6"	PVC Adj. Commercial Drain w/ 5" SS Grate	1
82016	6"	ABS Adj. Commercial Drain w/ 5" SS Grate	1
72026	6"	PVC Adj. Commercial Drain w/ 5" BR Grate	1
82026	6"	ABS Adj. Commercial Drain w/ 5" BR Grate	1
72056	6"	PVC Adj. Commercial Drain w/ 5" NI Grate	1
82056	6"	ABS Adj. Commercial Drain w/ 5" NI Grate	1
72086	6"	PVC Adj. Commercial Drain w/ 5" CHR Grate	1
82086	6"	ABS Adj. Commercial Drain w/ 5" CHR Grate	1





PVC Barrel With 5" Round Grate With Round Ring

Product No.	Size	Description	Ctn. Qty.
72032	2"	PVC Adj. Commercial Drain w/ 5" BR Grate & Round Ring	1
82032	2"	ABS Adj. Commercial Drain w/ 5" BR Grate & Round Ring	1
72062	2"	PVC Adj. Commercial Drain w/ 5" NI Grate & Round Ring	1
82062	2"	ABS Adj. Commercial Drain w/ 5" NI Grate & Round Ring	1
72092	2"	PVC Adj. Commercial Drain w/ 5" CHR Grate & Round Ring	1
82092	2"	ABS Adj. Commercial Drain w/ 5" CHR Grate & Round Ring	1
72033	3" or 4"	PVC Adj. Commercial Drain w/ 5" BR Grate & Round Ring	1
82033	3" or 4"	ABS Adj. Commercial Drain w/ 5" BR Grate & Round Ring	1
72063	3" or 4"	PVC Adj. Commercial Drain w/ 5" NI Grate & Round Ring	1
82063	3" or 4"	ABS Adj. Commercial Drain w/ 5" NI Grate & Round Ring	1
72093	3" or 4"	PVC Adj. Commercial Drain w/ 5" CHR Grate & Round Ring	1
82093	3" or 4"	ABS Adj. Commercial Drain w/ 5" CHR Grate & Round Ring	1
72034	4"	PVC Adj. Commercial Drain w/ 5" BR Grate & Round Ring	1
82034	4"	ABS Adj. Commercial Drain w/ 5" BR Grate & Round Ring	1
72064	4"	PVC Adj. Commercial Drain w/ 5" NI Grate & Round Ring	1
82064	4"	ABS Adj. Commercial Drain w/ 5" NI Grate & Round Ring	1
72094	4"	PVC Adj. Commercial Drain w/ 5" CHR Grate & Round Ring	1
82094	4"	ABS Adj. Commercial Drain w/ 5" CHR Grate & Round Ring	1
72036	6"	PVC Adj. Commercial Drain w/ 5" BR Grate & Round Ring	1
82036	6"	ABS Adj. Commercial Drain w/ 5" BR Grate & Round Ring	1
72066	6"	PVC Adj. Commercial Drain w/ 5" NI Grate & Round Ring	1
82066	6"	ABS Adj. Commercial Drain w/ 5" NI Grate & Round Ring	1
72096	6"	PVC Adj. Commercial Drain w/ 5" CHR Grate & Round Ring	1
82096	6"	ABS Adj. Commercial Drain w/ 5" CHR Grate & Round Ring	1

CATEGORY 22 COMMERCIAL DRAINAGE



SS - Stainless Steel BR - Brass NI - Nickel CHR - Chrome



PVC Barrel With 5" Round Grate With Square Ring

Product No.	Size	Description	Ctn. Qty.
72042	2"	PVC Adj. Commercial Drain w/ 5" BR Grate & Square Ring	1
82042	2"	ABS Adj. Commercial Drain w/ 5" BR Grate & Square Ring	1
72072	2"	PVC Adj. Commercial Drain w/ 5" NI Grate & Square Ring	1
82072	2"	ABS Adj. Commercial Drain w/ 5" NI Grate & Square Ring	1
72102	2"	PVC Adj. Commercial Drain w/ 5" CHR Grate & Square Ring	1
82102	2"	ABS Adj. Commercial Drain w/ 5" CHR Grate & Square Ring	1
72043	3" or 4"	PVC Adj. Commercial Drain w/ 5" BR Grate & Square Ring	1
82043	3" or 4"	ABS Adj. Commercial Drain w/ 5" BR Grate & Square Ring	1
72073	3" or 4"	PVC Adj. Commercial Drain w/ 5" NI Grate & Square Ring	1
82073	3" or 4"	ABS Adj. Commercial Drain w/ 5" NI Grate & Square Ring	1
72103	3" or 4"	PVC Adj. Commercial Drain w/ 5" CHR Grate & Square Ring	1
82103	3" or 4"	ABS Adj. Commercial Drain w/ 5" CHR Grate & Square Ring	1
72044	4"	PVC Adj. Commercial Drain w/ 5" BR Grate & Square Ring	1
82044	4"	ABS Adj. Commercial Drain w/ 5" BR Grate & Square Ring	1
72074	4"	PVC Adj. Commercial Drain w/ 5" NI Grate & Square Ring	1
82074	4"	ABS Adj. Commercial Drain w/ 5" NI Grate & Square Ring	1
72104	4"	PVC Adj. Commercial Drain w/ 5" CHR Grate & Square Ring	1
82104	4"	ABS Adj. Commercial Drain w/ 5" CHR Grate & Square Ring	1
72046	6"	PVC Adj. Commercial Drain w/5" BR Grate & Square Ring	1
82046	6"	ABS Adj. Commercial Drain w/ 5" BR Grate & Square Ring	1
72076	6"	PVC Adj. Commercial Drain w/ 5" NI Grate & Square Ring	1
82076	6"	ABS Adj. Commercial Drain w/ 5" NI Grate & Square Ring	1
72106	6"	PVC Adj. Commercial Drain w/ 5" CHR Grate & Square Ring	1
82106	6"	ABS Adj. Commercial Drain w/ 5" CHR Grate & Square Ring	1





PVC Barrel With 6" Round Grate

Product No.	Size	Description	Ctn. Qty.
72112	2"	PVC Adj. Commercial Drain w/ 6" SS Grate	1
82112	2"	ABS Adj. Commercial Drain w/ 6" SS Grate	1
72122	2"	PVC Adj. Commercial Drain w/ 6" BR Grate	1
82122	2"	ABS Adj. Commercial Drain w/ 6" BR Grate	1
72152	2"	PVC Adj. Commercial Drain w/ 6" NI Grate	1
82152	2"	ABS Adj. Commercial Drain w/ 6" NI Grate	1
72182	2"	PVC Adj. Commercial Drain w/ 6" CHR Grate	1
82182	2"	ABS Adj. Commercial Drain w/ 6" CHR Grate	1
72113	3" or 4"	PVC Adj. Commercial Drain w/ 6" SS Grate	1
82113	3" or 4"	ABS Adj. Commercial Drain w/ 6" SS Grate	1
72123	3" or 4"	PVC Adj. Commercial Drain w/ 6" BR Grate	1
82123	3" or 4"	ABS Adj. Commercial Drain w/ 6" BR Grate	1
72153	3" or 4"	PVC Adj. Commercial Drain w/ 6" NI Grate	1
82153	3" or 4"	ABS Adj. Commercial Drain w/ 6" NI Grate	1
72183	3" or 4"	PVC Adj. Commercial Drain w/ 6" CHR Grate	1
82183	3" or 4"	ABS Adj. Commercial Drain w/ 6" CHR Grate	1
72114	4"	PVC Adj. Commercial Drain w/ 6" SS Grate	1
82114	4"	ABS Adj. Commercial Drain w/ 6" SS Grate	1
72124	4"	PVC Adj. Commercial Drain w/ 6" BR Grate	1
82124	4"	ABS Adj. Commercial Drain w/ 6" BR Grate	1
72154	4"	PVC Adj. Commercial Drain w/ 6" NI Grate	1
82154	4"	ABS Adj. Commercial Drain w/ 6" NI Grate	1
72184	4"	PVC Adj. Commercial Drain w/ 6" CHR Grate	1
82184	4"	ABS Adj. Commercial Drain w/ 6" CHR Grate	1
72116	6"	PVC Adj. Commercial Drain w/ 6" SS Grate	1
82116	6"	ABS Adj. Commercial Drain w/ 6" SS Grate	1
72126	6"	PVC Adj. Commercial Drain w/ 6" BR Grate	1
82126	6"	ABS Adj. Commercial Drain w/ 6" BR Grate	1
72156	6"	PVC Adj. Commercial Drain w/ 6" NI Grate	1
82156	6"	ABS Adj. Commercial Drain w/ 6" NI Grate	1
72186	6"	PVC Adj. Commercial Drain w/ 6" CHR Grate	1
82186	6"	ABS Adj. Commercial Drain w/ 6" CHR Grate	1



PVC Barrel With 6" Round Grate With Round Ring

Product No.	Size	Description	Ctn. Qty.
72132	2"	PVC Adj. Commercial Drain w/ 6" BR Grate & Round Ring	1
82132	2"	ABS Adj. Commercial Drain w/ 6" BR Grate & Round Ring	1
72162	2"	PVC Adj. Commercial Drain w/ 6" NI Grate & Round Ring	1
82162	2"	ABS Adj. Commercial Drain w/ 6" NI Grate & Round Ring	1
72192	2"	PVC Adj. Commercial Drain w/ 6" CHR Grate & Round Ring	1
82192	2"	ABS Adj. Commercial Drain w/ 6" CHR Grate & Round Ring	1
72133	3" or 4"	PVC Adj. Commercial Drain w/ 6" BR Grate & Round Ring	1
82133	3" or 4"	ABS Adj. Commercial Drain w/ 6" BR Grate & Round Ring	1
72163	3" or 4"	PVC Adj. Commercial Drain w/ 6" NI Grate & Round Ring	1
82163	3" or 4"	ABS Adj. Commercial Drain w/ 6" NI Grate & Round Ring	1
72193	3" or 4"	PVC Adj. Commercial Drain w/ 6" CHR Grate & Round Ring	1
82193	3" or 4"	ABS Adj. Commercial Drain w/ 6" CHR Grate & Round Ring	1
72134	4"	PVC Adj. Commercial Drain w/ 6" BR Grate & Round Ring	1
82134	4"	ABS Adj. Commercial Drain w /6" BR Grate & Round Ring	1
72164	4"	PVC Adj. Commercial Drain w/ 6" NI Grate & Round Ring	1
82164	4"	ABS Adj. Commercial Drain w /6" NI Grate & Round Ring	1
72194	4"	PVC Adj. Commercial Drain w /6" CHR Grate & Round Ring	1
82194	4"	ABS Adj. Commercial Drain w /6" CHR Grate & Round Ring	1
72136	6"	PVC Adj. Commercial Drain w/ 6" BR Grate & Round Ring	1
82136	6"	ABS Adj. Commercial Drain w /6" BR Grate & Round Ring	1
72166	6"	PVC Adj. Commercial Drain w /6" NI Grate & Round Ring	1
82166	6"	ABS Adj. Commercial Drain w/ 6" NI Grate & Round Ring	1
72196	6"	PVC Adj. Commercial Drain w/ 6" CHR Grate & Round Ring	1
82196	6"	ABS Adj. Commercial Drain w/ 6" CHR Grate & Round Ring	1



PVC Barrel With 6" Round Grate With Square Ring



Product No.	Size	Description	Ctn. Qty.
72142	2"	PVC Adj. Commercial Drain w/ 6" BR Grate & Square Ring	1
82142	2"	ABS Adj. Commercial Drain w/ 6" BR Grate & Square Ring	1
72172	2"	PVC Adj. Commercial Drain w/ 6" NI Grate & Square Ring	1
82172	2"	ABS Adj. Commercial Drain w/ 6" NI Grate & Square Ring	1
72202	2"	PVC Adj. Commercial Drain w/ 6" CHR Grate & Square Ring	1
82202	2"	ABS Adj. Commercial Drain w/ 6" CHR Grate & Square Ring	1
72143	3" or 4"	PVC Adj. Commercial Drain w/ 6" BR Grate & Square Ring	1
82143	3" or 4"	ABS Adj. Commercial Drain w/ 6" BR Grate & Square Ring	1
72173	3" or 4"	PVC Adj. Commercial Drain w/ 6" NI Grate & Square Ring	1
82173	3" or 4"	ABS Adj. Commercial Drain w/ 6" NI Grate & Square Ring	1
72203	3" or 4"	PVC Adj. Commercial Drain w/ 6" CHR Grate & Square Ring	1
82203	3" or 4"	ABS Adj. Commercial Drain w/ 6" CHR Grate & Square Ring	1
72144	4"	PVC Adj. Commercial Drain w/ 6" BR Grate & Square Ring	1
82144	4"	ABS Adj. Commercial Drain w/ 6" BR Grate & Square Ring	1
72174	4"	PVC Adj. Commercial Drain w/ 6" NI Grate & Square Ring	1
82174	4"	ABS Adj. Commercial Drain w/ 6" NI Grate & Square Ring	1
72204	4"	PVC Adj. Commercial Drain w/ 6" CHR Grate & Square Ring	1
82204	4"	ABS Adj. Commercial Drain w/ 6" CHR Grate & Square Ring	1
72146	6"	PVC Adj. Commercial Drain w/ 6" BR Grate & Square Ring	1
82146	6"	ABS Adj. Commercial Drain w/ 6" BR Grate & Square Ring	1
72176	6"	PVC Adj. Commercial Drain w/ 6" NI Grate & Square Ring	1
82176	6"	ABS Adj. Commercial Drain w/ 6" NI Grate & Square Ring	1
72206	6"	PVC Adj. Commercial Drain w/ 6" CHR Grate & Square Ring	1
82206	6"	ABS Adj. Commercial Drain w/ 6" CHR Grate & Square Ring	1

Cast Barrel With Round Grate In Round Top



Product No.	Size	Description	Ctn. Qty.
72312	2"	PVC Adj. Commercial Drain w/ 5" Cast NI Grate & Round Top	1
82312	2"	ABS Adj. Commercial Drain w/ 5" Cast NI Grate & Round Top	1
72332	2"	PVC Adj. Commercial Drain w/ 6" Cast NI Grate & Round Top	1
82332	2"	ABS Adj. Commercial Drain w/ 6" Cast NI Grate & Round Top	1
72352	2"	PVC Adj. Commercial Drain w/ 8" Cast NI Grate & Round Top	1
82352	2"	ABS Adj. Commercial Drain w/ 8" Cast NI Grate & Round Top	1
72372	2"	PVC Adj. Commercial Drain w/ 10" Cast NI Grate & Round Top	1
82372	2"	ABS Adj. Commercial Drain w/ 10" Cast NI Grate & Round Top	1
72322	2"	PVC Adj. Commercial Drain w/ 5" Cast CHR Grate & Round Top	1
82322	2"	ABS Adj. Commercial Drain w/ 5" Cast CHR Grate & Round Top	1
72342	2"	PVC Adj. Commercial Drain w/ 6" Cast CHR Grate & Round Top	1
82342	2"	ABS Adj. Commercial Drain w/ 6" Cast CHR Grate & Round Top	1
72362	2"	PVC Adj. Commercial Drain w/ 8" Cast CHR Grate & Round Top	1
82362	2"	ABS Adj. Commercial Drain w/ 8" Cast CHR Grate & Round Top	1
72382	2"	PVC Adj. Commercial Drain w/ 10" Cast CHR Grate & Round Top	1
82382	2"	ABS Adj. Commercial Drain w/ 10" Cast CHR Grate & Round Top	1
72313	3" or 4"	PVC Adj. Commercial Drain w/ 5" Cast NI Grate & Round Top	1
82313	3" or 4"	ABS Adj. Commercial Drain w/ 5" Cast NI Grate & Round Top	1

SS - Stainless Steel BR - Brass NI - Nickel CHR - Chrome

CATEGORY 22 COMMERCIAL DRAINAGE



22



Cast Barrel With Round Grate In Round Top (cont.)

Product No.	Size	Description	Ctn. Qty.
72333	3" or 4 "	PVC Adj. Commercial Drain w/ 6" Cast NI Grate & Round Top	1
82333	3" or 4 "	ABS Adj. Commercial Drain w/ 6" Cast NI Grate & Round Top	1
72353	3" or 4 "	PVC Adj. Commercial Drain w/ 8" Cast NI Grate & Round Top	1
82353	3" or 4 "	ABS Adj. Commercial Drain w/ 8" Cast NI Grate & Round Top	1
72373	3" or 4 "	PVC Adj. Commercial Drain w/ 10" Cast NI Grate & Round Top	1
82373	3" or 4 "	ABS Adj. Commercial Drain w/ 10" Cast NI Grate & Round Top	1
72323	3" or 4 "	PVC Adj. Commercial Drain w/ 5" Cast CHR Grate & Round Top	1
82323	3" or 4 "	ABS Adj. Commercial Drain w/ 5" Cast CHR Grate & Round Top	1
72343	3" or 4 "	PVC Adj. Commercial Drain w/ 6" Cast CHR Grate & Round Top	1
82343	3" or 4 "	ABS Adj. Commercial Drain w/ 6" Cast CHR Grate & Round Top	1
72363	3" or 4 "	PVC Adj. Commercial Drain w/ 8" Cast CHR Grate & Round Top	1
82363	3" or 4 "	ABS Adj. Commercial Drain w/ 8" Cast CHR Grate & Round Top	1
72383	3" or 4 "	PVC Adj. Commercial Drain w/ 10" Cast CHR Grate & Round Top	1
82383	3" or 4 "	ABS Adj. Commercial Drain w/ 10" Cast CHR Grate & Round Top	1
72314	4"	PVC Adj. Commercial Drain w/ 5" Cast NI Grate & Round Top	1
82314	4"	ABS Adj. Commercial Drain w/ 5" Cast NI Grate & Round Top	1
72334	4"	PVC Adj. Commercial Drain w/ 6" Cast NI Grate & Round Top	1
82334	4"	ABS Adj. Commercial Drain w/ 6" Cast NI Grate & Round Top	1
72354	4"	PVC Adj. Commercial Drain w/ 8" Cast NI Grate & Round Top	1
82354	4"	ABS Adj. Commercial Drain w/ 8" Cast NI Grate & Round Top	1
72374	4"	PVC Adj. Commercial Drain w/ 10" Cast NI Grate & Round Top	1
82374	4"	ABS Adj. Commercial Drain w/ 10" Cast NI Grate & Round Top	1
72324	4"	PVC Adj. Commercial Drain w/ 5" Cast CHR Grate & Round Top	1
82324	4"	ABS Adj. Commercial Drain w/ 5" Cast CHR Grate & Round Top	1
72344	4"	PVC Adj. Commercial Drain w/ 6" Cast CHR Grate & Round Top	1
82344	4"	ABS Adj. Commercial Drain w/ 6" Cast CHR Grate & Round Top	1
72364	4"	PVC Adj. Commercial Drain w/ 8" Cast CHR Grate & Round Top	1
82364	4"	ABS Adj. Commercial Drain w/ 8" Cast CHR Grate & Round Top	1
72384	4"	PVC Adj. Commercial Drain w/ 10" Cast CHR Grate & Round Top	1
82384	4"	ABS Adj. Commercial Drain w/ 10" Cast CHR Grate & Round Top	1
72316	6"	PVC Adj. Commercial Drain w/ 5" Cast NI Grate & Round Top	1
82316	6"	ABS Adj. Commercial Drain w/ 5" Cast NI Grate & Round Top	1
72336	6"	PVC Adj. Commercial Drain w/ 6" Cast NI Grate & Round Top	1
82336	6"	ABS Adj. Commercial Drain w/ 6" Cast NI Grate & Round Top	1
72356	6"	PVC Adj. Commercial Drain w/ 8" Cast NI Grate & Round Top	1
82356	6"	ABS Adj. Commercial Drain w/ 8" Cast NI Grate & Round Top	1
72376	6"	PVC Adj. Commercial Drain w/ 10" Cast NI Grate & Round Top	1
82376	6"	ABS Adj. Commercial Drain w/ 10" Cast NI Grate & Round Top	1
72326	6"	PVC Adj. Commercial Drain w/ 5" Cast CHR Grate & Round Top	1
82326	6"	ABS Adj. Commercial Drain w/ 5" Cast CHR Grate & Round Top	1
72346	6"	PVC Adj. Commercial Drain w/ 6" Cast CHR Grate & Round Top	1
82346	6"	ABS Adj. Commercial Drain w/ 6" Cast CHR Grate & Round Top	1
72366	6"	PVC Adj. Commercial Drain w/ 8" Cast CHR Grate & Round Top	1
82366	6"	ABS Adj. Commercial Drain w/ 8" Cast CHR Grate & Round Top	1
72386	6"	PVC Adj. Commercial Drain w/ 10" Cast CHR Grate & Round Top	1
82386	6"	ABS Adj. Commercial Drain w/ 10" Cast CHR Grate & Round Top	1

SS - Stainless Steel BR - Brass NI - Nickel CHR - Chrome



Cast Barrel With Round Grate In Square Top



Product No.	Size	Description	Ctn. Qty.
72272	2"	PVC Adj. Commercial Drain w/ 5" Cast NI Grate & Square Top	1
82272	2"	ABS Adj. Commercial Drain w/ 5" Cast NI Grate & Square Top	1
72292	2"	PVC Adj. Commercial Drain w/ 6" Cast NI Grate & Square Top	1
82292	2"	ABS Adj. Commercial Drain w/ 6" Cast NI Grate & Square Top	1
72282	2"	PVC Adj. Commercial Drain w/ 5" Cast CHR Grate & Square Top	1
82282	2"	ABS Adj. Commercial Drain w/ 5" Cast CHR Grate & Square Top	1
72302	2"	PVC Adj. Commercial Drain w/ 6" Cast CHR Grate & Square Top	1
82302	2"	ABS Adj. Commercial Drain w/ 6" Cast CHR Grate & Square Top	1
72273	3" or 4 "	PVC Adj. Commercial Drain w/ 5" Cast NI Grate & Square Top	1
82273	3" or 4 "	ABS Adj. Commercial Drain w/ 5" Cast NI Grate & Square Top	1
72293	3" or 4 "	PVC Adj. Commercial Drain w/ 6" Cast NI Grate & Square Top	1
82293	3" or 4 "	ABS Adj. Commercial Drain w/ 6" Cast NI Grate & Square Top	1
72283	3" or 4 "	PVC Adj. Commercial Drain w/ 5" Cast CHR Grate & Square Top	1
82283	3" or 4 "	ABS Adj. Commercial Drain w/ 5" Cast CHR Grate & Square Top	1
72303	3" or 4 "	PVC Adj. Commercial Drain w/ 6" Cast CHR Grate & Square Top	1
82303	3" or 4 "	ABS Adj. Commercial Drain w/ 6" Cast CHR Grate & Square Top	1
72274	4"	PVC Adj. Commercial Drain w/ 5" Cast NI Grate & Square Top	1
82274	4"	ABS Adj. Commercial Drain w/ 5" Cast NI Grate & Square Top	1
72294	4"	PVC Adj. Commercial Drain w/ 6" Cast NI Grate & Square Top	1
82294	4"	ABS Adj. Commercial Drain w/ 6" Cast NI Grate & Square Top	1
72284	4"	PVC Adj. Commercial Drain w/ 5" Cast CHR Grate & Square Top	1
82284	4"	ABS Adj. Commercial Drain w/ 5" Cast CHR Grate & Square Top	1
72304	4"	PVC Adj. Commercial Drain w/ 6" Cast CHR Grate & Square Top	1
82304	4"	ABS Adj. Commercial Drain w/ 6" Cast CHR Grate & Square Top	1
72276	6"	PVC Adj. Commercial Drain w/ 5" Cast NI Grate & Square Top	1
82276	6"	ABS Adj. Commercial Drain w/ 5" Cast NI Grate & Square Top	1
72296	6"	PVC Adj. Commercial Drain w/ 6" Cast NI Grate & Square Top	1
82296	6"	ABS Adj. Commercial Drain w/ 6" Cast NI Grate & Square Top	1
72286	6"	PVC Adj. Commercial Drain w/ 5" Cast CHR Grate & Square Top	1
82286	6"	ABS Adj. Commercial Drain w/ 5" Cast CHR Grate & Square Top	1
72306	6"	PVC Adj. Commercial Drain w/ 6" Cast CHR Grate & Square Top	1
82306	6"	ABS Adj. Commercial Drain w/ 6" Cast CHR Grate & Square Top	1

Cast Barrel With Square Grate In Square Top



Product No.	Size	Description	Ctn. Qty.
72212	2"	PVC Adj. Commercial Drain w/ 4" Cast NI Square Grate & Square Top	1
82212	2"	ABS Adj. Commercial Drain w/ 4" Cast NI Square Grate & Square Top	1
72232	2"	PVC Adj. Commercial Drain w/ 5" Cast NI Square Grate & Square Top	1
82232	2"	ABS Adj. Commercial Drain w/ 5" Cast NI Square Grate & Square Top	1
72252	2"	PVC Adj. Commercial Drain w/ 6" Cast NI Square Grate & Square Top	1
82252	2"	ABS Adj. Commercial Drain w/ 6" Cast NI Square Grate & Square Top	1
72222	2"	PVC Adj. Commercial Drain w/ 4" Cast CHR Square Grate & Square Top	1
82222	2"	ABS Adj. Commercial Drain w/ 4" Cast CHR Square Grate & Square Top	1

SS - Stainless Steel BR - Brass NI - Nickel CHR - Chrome

CATEGORY 22 COMMERCIAL DRAINAGE



22



Cast Barrel With Square Grate In Square Top (cont.)

Product No.	Size	Description	Ctn. Qty.
72242	2"	PVC Adj. Commercial Drain w/ 5" Cast CHR Square Grate & Square Top	1
82242	2"	ABS Adj. Commercial Drain w/ 5" Cast CHR Square Grate & Square Top	1
72262	2"	PVC Adj. Commercial Drain w/ 6" Cast CHR Square Grate & Square Top	1
82262	2"	ABS Adj. Commercial Drain w/ 6" Cast CHR Square Grate & Square Top	1
72213	3" or 4 "	PVC Adj. Commercial Drain w/ 4" Cast NI Square Grate & Square Top	1
82213	3" or 4 "	ABS Adj. Commercial Drain w/ 4" Cast NI Square Grate & Square Top	1
72233	3" or 4 "	PVC Adj. Commercial Drain w/ 5" Cast NI Square Grate & Square Top	1
82233	3" or 4 "	ABS Adj. Commercial Drain w/ 5" Cast NI Square Grate & Square Top	1
72253	3" or 4 "	PVC Adj. Commercial Drain w/ 6" Cast NI Square Grate & Square Top	1
82253	3" or 4 "	ABS Adj. Commercial Drain w/ 6" Cast NI Square Grate & Square Top	1
72223	3" or 4 "	PVC Adj. Commercial Drain w/ 4" Cast CHR Square Grate & Square Top	1
82223	3" or 4 "	ABS Adj. Commercial Drain w/ 4" Cast CHR Square Grate & Square Top	1
72243	3" or 4 "	PVC Adj. Commercial Drain w/ 5" Cast CHR Square Grate & Square Top	1
82243	3" or 4 "	ABS Adj. Commercial Drain w/ 5" Cast CHR Square Grate & Square Top	1
72263	3" or 4 "	PVC Adj. Commercial Drain w/ 6" Cast CHR Square Grate & Square Top	1
82263	3" or 4 "	ABS Adj. Commercial Drain w/ 6" Cast CHR Square Grate & Square Top	1
72214	4"	PVC Adj. Commercial Drain w/ 4" Cast NI Square Grate & Square Top	1
82214	4"	ABS Adj. Commercial Drain w/ 4" Cast NI Square Grate & Square Top	1
72234	4"	PVC Adj. Commercial Drain w/ 5" Cast NI Square Grate & Square Top	1
82234	4"	ABS Adj. Commercial Drain w/ 5" Cast NI Square Grate & Square Top	1
72254	4"	PVC Adj. Commercial Drain w/ 6" Cast NI Square Grate & Square Top	1
82254	4"	ABS Adj. Commercial Drain w/ 6" Cast NI Square Grate & Square Top	1
72224	4"	PVC Adj. Commercial Drain w/ 4" Cast CHR Square Grate & Square Top	1
82224	4"	ABS Adj. Commercial Drain w/ 4" Cast CHR Square Grate & Square Top	1
72244	4"	PVC Adj. Commercial Drain w/ 5" Cast CHR Square Grate & Square Top	1
82244	4"	ABS Adj. Commercial Drain w/ 5" Cast CHR Square Grate & Square Top	1
72264	4"	PVC Adj. Commercial Drain w/ 6" Cast CHR Square Grate & Square Top	1
82264	4"	ABS Adj. Commercial Drain w/ 6" Cast CHR Square Grate & Square Top	1
72216	6"	PVC Adj. Commercial Drain w/ 4" Cast NI Square Grate & Square Top	1
82216	6"	ABS Adj. Commercial Drain w/ 4" Cast NI Square Grate & Square Top	1
72236	6"	PVC Adj. Commercial Drain w/ 5" Cast NI Square Grate & Square Top	1
82236	6"	ABS Adj. Commercial Drain w/ 5" Cast NI Square Grate & Square Top	1
72256	6"	PVC Adj. Commercial Drain w/ 6" Cast NI Square Grate & Square Top	1
82256	6"	ABS Adj. Commercial Drain w/ 6" Cast NI Square Grate & Square Top	1
72226	6"	PVC Adj. Commercial Drain w/ 4" Cast CHR Square Grate & Square Top	1
82226	6"	ABS Adj. Commercial Drain w/ 4" Cast CHR Square Grate & Square Top	1
72246	6"	PVC Adj. Commercial Drain w/ 5" Cast CHR Square Grate & Square Top	1
82246	6"	ABS Adj. Commercial Drain w/ 5" Cast CHR Square Grate & Square Top	1
72266	6"	PVC Adj. Commercial Drain w/ 6" Cast CHR Square Grate & Square Top	1
82266	6"	ABS Adj. Commercial Drain w/ 6" Cast CHR Square Grate & Square Top	1



SS - Stainless Steel BR - Brass NI - Nickel CHR - Chrome

ADJUSTABLE GENERAL PURPOSE DRAIN BASES



PVC Barrel With 5" Round Grate

Product No.	Size	Description	Ctn. Qty.
72017	3" or 4"	PVC General Purpose Drain w/ 5" SS Grate	1
82017	3" or 4"	ABS General Purpose Drain w/ 5" SS Grate	1
72027	3" or 4"	PVC General Purpose Drain w/ 5" BR Grate	1
82027	3" or 4"	ABS General Purpose Drain w/ 5" BR Grate	1
72057	3" or 4"	PVC General Purpose Drain w/ 5" NI Grate	1
82057	3" or 4"	ABS General Purpose Drain w/ 5" NI Grate	1
72087	3" or 4"	PVC General Purpose Drain w/ 5" CHR Grate	1
82087	3" or 4"	ABS General Purpose Drain w/ 5" CHR Grate	1
72018	4"	PVC Pipe Base General Purpose Drain w/ 5" SS Grate	1
82018	4"	ABS Pipe Base General Purpose Drain w/ 5" SS Grate	1
72028	4"	PVC Pipe Base General Purpose Drain w/ 5" BR Grate	1
82028	4"	ABS Pipe Base General Purpose Drain w/ 5" BR Grate	1
72058	4"	PVC Pipe Base General Purpose Drain w/ 5" NI Grate	1
82058	4"	ABS Pipe Base General Purpose Drain w/ 5" NI Grate	1
72088	4"	PVC Pipe Base General Purpose Drain w/ 5" CHR Grate	1
82088	4"	ABS Pipe Base General Purpose Drain w/ 5" CHR Grate	1
72019	4"	PVC Hub Base General Purpose Drain w/ 5" SS Grate	1
82019	4"	ABS Hub Base General Purpose Drain w/ 5" SS Grate	1
72029	4"	PVC Hub Base General Purpose Drain w/ 5" BR Grate	1
82029	4"	ABS Hub Base General Purpose Drain w/ 5" BR Grate	1
72059	4"	PVC Hub Base General Purpose Drain w/ 5" NI Grate	1
82059	4"	ABS Hub Base General Purpose Drain w/ 5" NI Grate	1
72089	4"	PVC Hub Base General Purpose Drain w/ 5" CHR Grate	1
82089	4"	ABS Hub Base General Purpose Drain w/ 5" CHR Grate	1

CATEGORY 22 COMMERCIAL DRAINAGE



SS - Stainless Steel BR - Brass NI - Nickel CHR - Chrome



PVC Barrel With 5" Round Grate With Round Ring

Product No.	Size	Description	Ctn. Qty.
72037	3" or 4"	PVC General Purpose Drain w/ 5" BR Grate & Round Ring	1
82037	3" or 4"	ABS General Purpose Drain w/ 5" BR Grate & Round Ring	1
72067	3" or 4"	PVC General Purpose Drain w/ 5" NI Grate & Round Ring	1
82067	3" or 4"	ABS General Purpose Drain w/ 5" NI Grate & Round Ring	1
72097	3" or 4"	PVC General Purpose Drain w/ 5" CHR Grate & Round Ring	1
82097	3" or 4"	ABS General Purpose Drain w/ 5" CHR Grate & Round Ring	1
72038	4"	PVC Pipe Base General Purpose Drain w/ 5" BR Grate & Round Ring	1
82038	4"	ABS Pipe Base General Purpose Drain w/ 5" BR Grate & Round Ring	1
72068	4"	PVC Pipe Base General Purpose Drain w/ 5" NI Grate & Round Ring	1
82068	4"	ABS Pipe Base General Purpose Drain w/ 5" NI Grate & Round Ring	1
72098	4"	PVC Pipe Base General Purpose Drain w/ 5" CHR Grate & Round Ring	1
82098	4"	ABS Pipe Base General Purpose Drain w/ 5" CHR Grate & Round Ring	1
72039	4"	PVC Hub Base General Purpose Drain w/ 5" BR Grate & Round Ring	1
82039	4"	ABS Hub Base General Purpose Drain w/ 5" BR Grate & Round Ring	1
72069	4"	PVC Hub Base General Purpose Drain w/ 5" NI Grate & Round Ring	1
82069	4"	ABS Hub Base General Purpose Drain w/ 5" NI Grate & Round Ring	1
72099	4"	PVC Hub Base General Purpose Drain w/ 5" CHR Grate & Round Ring	1
82099	4"	ABS Hub Base General Purpose Drain w/ 5" CHR Grate & Round Ring	1



PVC Barrel With 5" Round Grate With Square Ring

Product No.	Size	Description	Ctn. Qty.
72047	3" or 4"	PVC General Purpose Drain w/ 5" BR Grate & Square Ring	1
82047	3" or 4"	ABS General Purpose Drain w/ 5" BR Grate & Square Ring	1
72077	3" or 4"	PVC General Purpose Drain w/ 5" NI Grate & Square Ring	1
82077	3" or 4"	ABS General Purpose Drain w/ 5" NI Grate & Square Ring	1
72107	3" or 4"	PVC General Purpose Drain w/ 5" CHR Grate & Square Ring	1
82107	3" or 4"	ABS General Purpose Drain w/ 5" CHR Grate & Square Ring	1
72048	4"	PVC Pipe Base General Purpose Drain w/ 5" BR Grate & Square Ring	1
82048	4"	ABS Pipe Base General Purpose Drain w/ 5" BR Grate & Square Ring	1
72078	4"	PVC Pipe Base General Purpose Drain w/ 5" NI Grate & Square Ring	1
82078	4"	ABS Pipe Base General Purpose Drain w/ 5" NI Grate & Square Ring	1
72108	4"	PVC Pipe Base General Purpose Drain w/ 5" CHR Grate & Square Ring	1
82108	4"	ABS Pipe Base General Purpose Drain w/ 5" CHR Grate & Square Ring	1
72049	4"	PVC Hub Base General Purpose Drain w/ 5" BR Grate & Square Ring	1
82049	4"	ABS Hub Base General Purpose Drain w/ 5" BR Grate & Square Ring	1
72079	4"	PVC Hub Base General Purpose Drain w/ 5" NI Grate & Square Ring	1
82079	4"	ABS Hub Base General Purpose Drain w/ 5" NI Grate & Square Ring	1
72109	4"	PVC Hub Base General Purpose Drain w/ 5" CHR Grate & Square Ring	1
82109	4"	ABS Hub Base General Purpose Drain w/ 5" CHR Grate & Square Ring	1



SS - Stainless Steel BR - Brass NI - Nickel CHR - Chrome



PVC Barrel With 6" Round Grate

Product No.	Size	Description	Ctn. Qty.
72117	3" or 4"	PVC General Purpose Drain w/ 6" SS Grate	1
82117	3" or 4"	ABS General Purpose Drain w/ 6" SS Grate	1
72127	3" or 4"	PVC General Purpose Drain w/ 6" BR Grate	1
82127	3" or 4"	ABS General Purpose Drain w/ 6" BR Grate	1
72157	3" or 4"	PVC General Purpose Drain w/ 6" NI Grate	1
82157	3" or 4"	ABS General Purpose Drain w/ 6" NI Grate	1
72187	3" or 4"	PVC General Purpose Drain w/ 6" CHR Grate	1
82187	3" or 4"	ABS General Purpose Drain w/ 6" CHR Grate	1
72118	4"	PVC Pipe Base General Purpose Drain w/ 6" SS Grate	1
82118	4"	ABS Pipe Base General Purpose Drain w/ 6" SS Grate	1
72128	4"	PVC Pipe Base General Purpose Drain w/ 6" BR Grate	1
82128	4"	ABS Pipe Base General Purpose Drain w/ 6" BR Grate	1
72158	4"	PVC Pipe Base General Purpose Drain w/ 6" NI Grate	1
82158	4"	ABS Pipe Base General Purpose Drain w/ 6" NI Grate	1
72188	4"	PVC Pipe Base General Purpose Drain w/ 6" CHR Grate	1
82188	4"	ABS Pipe Base General Purpose Drain w/ 6" CHR Grate	1
72119	4"	PVC Hub Base General Purpose Drain w/ 6" SS Grate	1
82119	4"	ABS Hub Base General Purpose Drain w/ 6" SS Grate	1
72129	4"	PVC Hub Base General Purpose Drain w/ 6" BR Grate	1
82129	4"	ABS Hub Base General Purpose Drain w/ 6" BR Grate	1
72159	4"	PVC Hub Base General Purpose Drain w/ 6" NI Grate	1
82159	4"	ABS Hub Base General Purpose Drain w/ 6" NI Grate	1
72189	4"	PVC Hub Base General Purpose Drain w/ 6" CHR Grate	1
82189	4"	ABS Hub Base General Purpose Drain w/ 6" CHR Grate	1



PVC Barrel With 6" Round Grate With Round Ring

Product No.	Size	Description	Ctn. Qty.
72137	3" or 4"	PVC General Purpose Drain w/ 6" BR Grate & Round Ring	1
82137	3" or 4"	ABS General Purpose Drain w/ 6" BR Grate & Round Ring	1
72167	3" or 4"	PVC General Purpose Drain w/ 6" NI Grate & Round Ring	1
82167	3" or 4"	ABS General Purpose Drain w/ 6" NI Grate & Round Ring	1
72197	3" or 4"	PVC General Purpose Drain w/ 6" CHR Grate & Round Ring	1
82197	3" or 4"	ABS General Purpose Drain w/ 6" CHR Grate & Round Ring	1
72138	4"	PVC Pipe Base General Purpose Drain w/ 6" BR Grate & Round Ring	1
82138	4"	ABS Pipe Base General Purpose Drain w/ 6" BR Grate & Round Ring	1
72168	4"	PVC Pipe Base General Purpose Drain w/ 6" NI Grate & Round Ring	1
82168	4"	ABS Pipe Base General Purpose Drain w/ 6" NI Grate & Round Ring	1
72198	4"	PVC Pipe Base General Purpose Drain w/ 6" CHR Grate & Round Ring	1
82198	4"	ABS Pipe Base General Purpose Drain w/ 6" CHR Grate & Round Ring	1
72139	4"	PVC Hub Base General Purpose Drain w/ 6" BR Grate & Round Ring	1
82139	4"	ABS Hub Base General Purpose Drain w/ 6" BR Grate & Round Ring	1
72169	4"	PVC Hub Base General Purpose Drain w/ 6" NI Grate & Round Ring	1
82169	4"	ABS Hub Base General Purpose Drain w/ 6" NI Grate & Round Ring	1
72199	4"	PVC Hub Base General Purpose Drain w/ 6" CHR Grate & Round Ring	1
82199	4"	ABS Hub Base General Purpose Drain w/ 6" CHR Grate & Round Ring	1



PVC Barrel With 6" Round Grate With Square Ring

Product No.	Size	Description	Ctn. Qty.
72147	3" or 4"	PVC General Purpose Drain w/ 6" BR Grate & Square Ring	1
82147	3" or 4"	ABS General Purpose Drain w/ 6" BR Grate & Square Ring	1
72177	3" or 4"	PVC General Purpose Drain w/ 6" NI Grate & Square Ring	1
82177	3" or 4"	ABS General Purpose Drain w/ 6" NI Grate & Square Ring	1
72207	3" or 4"	PVC General Purpose Drain w/ 6" CHR Grate & Square Ring	1
82207	3" or 4"	ABS General Purpose Drain w/ 6" CHR Grate & Square Ring	1
72148	4"	PVC Pipe Base General Purpose Drain w/ 6" BR Grate & Square Ring	1
82148	4"	ABS Pipe Base General Purpose Drain w/ 6" BR Grate & Square Ring	1
72178	4"	PVC Pipe Base General Purpose Drain w/ 6" NI Grate & Square Ring	1
82178	4"	ABS Pipe Base General Purpose Drain w/ 6" NI Grate & Square Ring	1
72208	4"	PVC Pipe Base General Purpose Drain w/ 6" CHR Grate & Square Ring	1
82208	4"	ABS Pipe Base General Purpose Drain w/ 6" CHR Grate & Square Ring	1
72149	4"	PVC Hub Base General Purpose Drain w/ 6" BR Grate & Square Ring	1
82149	4"	ABS Hub Base General Purpose Drain w/ 6" BR Grate & Square Ring	1
72179	4"	PVC Hub Base General Purpose Drain w/ 6" NI Grate & Square Ring	1
82179	4"	ABS Hub Base General Purpose Drain w/ 6" NI Grate & Square Ring	1
72209	4"	PVC Hub Base General Purpose Drain w/ 6" CHR Grate & Square Ring	1
82209	4"	ABS Hub Base General Purpose Drain w/ 6" CHR Grate & Square Ring	1



SS - Stainless Steel BR - Brass NI - Nickel CHR - Chrome

Cast Barrel With Square Grate In Square Top



Product No.	Size	Description	Ctn. Qty.
72217	3" or 4"	PVC General Purpose Pipe Fit Drain w/ 4" Cast NI Grate & Square Top	1
82217	3" or 4"	ABS General Purpose Pipe Fit Drain w/ 4" Cast NI Grate & Square Top	1
72237	3" or 4"	PVC General Purpose Pipe Fit Drain w/ 5" Cast NI Grate & Square Top	1
82237	3" or 4"	ABS General Purpose Pipe Fit Drain w/ 5" Cast NI Grate & Square Top	1
72257	3" or 4"	PVC General Purpose Pipe Fit Drain w/ 6" Cast NI Grate & Square Top	1
82257	3" or 4"	ABS General Purpose Pipe Fit Drain w/ 6" Cast NI Grate & Square Top	1
72227	3" or 4"	PVC General Purpose Pipe Fit Drain w/ 4" Cast CHR Grate & Square Top	1
82227	3" or 4"	ABS General Purpose Pipe Fit Drain w/ 4" Cast CHR Grate & Square Top	1
72247	3" or 4"	PVC General Purpose Pipe Fit Drain w/ 5" Cast CHR Grate & Square Top	1
82247	3" or 4"	ABS General Purpose Pipe Fit Drain w/ 5" Cast CHR Grate & Square Top	1
72267	3" or 4"	PVC General Purpose Pipe Fit Drain w/ 6" Cast CHR Grate & Square Top	1
82267	3" or 4"	ABS General Purpose Pipe Fit Drain w/ 6" Cast CHR Grate & Square Top	1
72218	4"	PVC General Purpose Pipe Fit Drain w/ 4" Cast NI Grate & Square Top	1
82218	4"	ABS General Purpose Pipe Fit Drain w/ 4" Cast NI Grate & Square Top	1
72238	4"	PVC General Purpose Pipe Fit Drain w/ 5" Cast NI Grate & Square Top	1
82238	4"	ABS General Purpose Pipe Fit Drain w/ 5" Cast NI Grate & Square Top	1
72258	4"	PVC General Purpose Pipe Fit Drain w/ 6" Cast NI Grate & Square Top	1
82258	4"	ABS General Purpose Pipe Fit Drain w/ 6" Cast NI Grate & Square Top	1
72228	4"	PVC General Purpose Pipe Fit Drain w/ 4" Cast CHR Grate & Square Top	1
82228	4"	ABS General Purpose Pipe Fit Drain w/ 4" Cast CHR Grate & Square Top	1
72248	4"	PVC General Purpose Pipe Fit Drain w/ 5" Cast CHR Grate & Square Top	1
82248	4"	ABS General Purpose Pipe Fit Drain w/ 5" Cast CHR Grate & Square Top	1
72268	4"	PVC General Purpose Pipe Fit Drain w/ 6" Cast CHR Grate & Square Top	1
82268	4"	ABS General Purpose Pipe Fit Drain w/ 6" Cast CHR Grate & Square Top	1
72219	4"	PVC General Purpose Hub Fit Drain w/ 4" Cast NI Grate & Square Top	1
82219	4"	ABS General Purpose Hub Fit Drain w/ 4" Cast NI Grate & Square Top	1
72239	4"	PVC General Purpose Hub Fit Drain w/ 5" Cast NI Grate & Square Top	1
82239	4"	ABS General Purpose Hub Fit Drain w/ 5" Cast NI Grate & Square Top	1
72259	4"	PVC General Purpose Hub Fit Drain w/ 6" Cast NI Grate & Square Top	1
82259	4"	ABS General Purpose Hub Fit Drain w/ 6" Cast NI Grate & Square Top	1
72229	4"	PVC General Purpose Hub Fit Drain w/ 4" Cast CHR Grate & Square Top	1
82229	4"	ABS General Purpose Hub Fit Drain w/ 4" Cast CHR Grate & Square Top	1
72249	4"	PVC General Purpose Hub Fit Drain w/ 5" Cast CHR Grate & Square Top	1
82249	4"	ABS General Purpose Hub Fit Drain w/ 5" Cast CHR Grate & Square Top	1
72269	4"	PVC General Purpose Hub Fit Drain w/ 6" Cast CHR Grate & Square Top	1
82269	4"	ABS General Purpose Hub Fit Drain w/ 6" Cast CHR Grate & Square Top	1

CATEGORY 22 COMMERCIAL DRAINAGE



SS - Stainless Steel BR - Brass NI - Nickel CHR - Chrome



Cast Barrel With Round Grate In Square Top

Product No.	Size	Description	Ctn. Qty.
72277	3" or 4"	PVC General Purpose Pipe Fit Drain w/ 5" Cast NI Grate & Square Top	1
82277	3" or 4"	ABS General Purpose Pipe Fit Drain w/ 5" Cast NI Grate & Square Top	1
72297	3" or 4"	PVC General Purpose Pipe Fit Drain w/ 6" Cast NI Grate & Square Top	1
82297	3" or 4"	ABS General Purpose Pipe Fit Drain w/ 6" Cast NI Grate & Square Top	1
72287	3" or 4"	PVC General Purpose Pipe Fit Drain w/ 5" Cast CHR Grate & Square Top	1
82287	3" or 4"	ABS General Purpose Pipe Fit Drain w/ 5" Cast CHR Grate & Square Top	1
72307	3" or 4"	PVC General Purpose Pipe Fit Drain w/ 6" Cast CHR Grate & Square Top	1
82307	3" or 4"	ABS General Purpose Pipe Fit Drain w/ 6" Cast CHR Grate & Square Top	1
72278	4"	PVC General Purpose Pipe Fit Drain w/ 5" Cast NI Grate & Square Top	1
82278	4"	ABS General Purpose Pipe Fit Drain w/ 5" Cast NI Grate & Square Top	1
72298	4"	PVC General Purpose Pipe Fit Drain w/ 6" Cast NI Grate & Square Top	1
82298	4"	ABS General Purpose Pipe Fit Drain w/ 6" Cast NI Grate & Square Top	1
72288	4"	PVC General Purpose Pipe Fit Drain w/ 5" Cast CHR Grate & Square Top	1
82288	4"	ABS General Purpose Pipe Fit Drain w/ 5" Cast CHR Grate & Square Top	1
72308	4"	PVC General Purpose Pipe Fit Drain w/ 6" Cast CHR Grate & Square Top	1
82308	4"	ABS General Purpose Pipe Fit Drain w/ 6" Cast CHR Grate & Square Top	1
72279	4"	PVC General Purpose Hub Fit Drain w/ 5" Cast NI Grate & Square Top	1
82279	4"	ABS General Purpose Hub Fit Drain w/ 5" Cast NI Grate & Square Top	1
72299	4"	PVC General Purpose Hub Fit Drain w/ 6" Cast NI Grate & Square Top	1
82299	4"	ABS General Purpose Hub Fit Drain w/ 6" Cast NI Grate & Square Top	1
72289	4"	PVC General Purpose Hub Fit Drain w/ 5" Cast CHR Grate & Square Top	1
82289	4"	ABS General Purpose Hub Fit Drain w/ 5" Cast CHR Grate & Square Top	1
72309	4"	PVC General Purpose Hub Fit Drain w/ 6" Cast CHR Grate & Square Top	1
82309	4"	ABS General Purpose Hub Fit Drain w/ 6" Cast CHR Grate & Square Top	1



Cast Barrel With Round Grate In Round Top

Product No.	Size	Description	Ctn. Qty.
72317	3" or 4"	PVC General Purpose Pipe Fit Drain w/ 5" Cast NI Grate & Round Top	1
82317	3" or 4"	ABS General Purpose Pipe Fit Drain w/ 5" Cast NI Grate & Round Top	1
72337	3" or 4"	PVC General Purpose Pipe Fit Drain w/ 6" Cast NI Grate & Round Top	1
82337	3" or 4"	ABS General Purpose Pipe Fit Drain w/ 6" Cast NI Grate & Round Top	1
72357	3" or 4"	PVC General Purpose Pipe Fit Drain w/ 8" Cast NI Grate & Round Top	1
82357	3" or 4"	ABS General Purpose Pipe Fit Drain w/ 8" Cast NI Grate & Round Top	1
72377	3" or 4"	PVC General Purpose Pipe Fit Drain w/ 10" Cast NI Grate & Round Top	1
82377	3" or 4"	ABS General Purpose Pipe Fit Drain w/ 10" Cast NI Grate & Round Top	1
72327	3" or 4"	PVC General Purpose Pipe Fit Drain w/ 5" Cast CHR Grate & Round Top	1
82327	3" or 4"	ABS General Purpose Pipe Fit Drain w/ 5" Cast CHR Grate & Round Top	1
72347	3" or 4"	PVC General Purpose Pipe Fit Drain w/ 6" Cast CHR Grate & Round Top	1
82347	3" or 4"	ABS General Purpose Pipe Fit Drain w/ 6" Cast CHR Grate & Round Top	1
72367	3" or 4"	PVC General Purpose Pipe Fit Drain w/ 8" Cast CHR Grate & Round Top	1
82367	3" or 4"	ABS General Purpose Pipe Fit Drain w/ 8" Cast CHR Grate & Round Top	1
72387	3" or 4"	PVC General Purpose Pipe Fit Drain w/ 10" Cast CHR Grate & Round Top	1
82387	3" or 4"	ABS General Purpose Pipe Fit Drain w/ 10" Cast CHR Grate & Round Top	1



SS - Stainless Steel BR - Brass NI - Nickel CHR - Chrome

Cast Barrel With Round Grate In Round Top (cont.)



Product No.	Size	Description	Ctn. Qty.
72318	4"	PVC General Purpose Pipe Fit Drain w/ 5" Cast NI Grate & Round Top	1
82318	4"	ABS General Purpose Pipe Fit Drain w/ 5" Cast NI Grate & Round Top	1
72338	4"	PVC General Purpose Pipe Fit Drain w/ 6" Cast NI Grate & Round Top	1
82338	4"	ABS General Purpose Pipe Fit Drain w/ 6 " Cast NI Grate & Round Top	1
72358	4"	PVC General Purpose Pipe Fit Drain w/ 8" Cast NI Grate & Round Top	1
82358	4"	ABS General Purpose Pipe Fit Drain w/ 8" Cast NI Grate & Round Top	1
72378	4"	PVC General Purpose Pipe Fit Drain w/ 10" Cast NI Grate & Round Top	1
82378	4"	ABS General Purpose Pipe Fit Drain w/ 10" Cast NI Grate & Round Top	1
72328	4"	PVC General Purpose Pipe Fit Drain w/ 5" Cast CHR Grate & Round Top	1
82328	4"	ABS General Purpose Pipe Fit Drain w/ 5" Cast CHR Grate & Round Top	1
72348	4"	PVC General Purpose Pipe Fit Drain w/ 6" Cast CHR Grate & Round Top	1
82348	4"	ABS General Purpose Pipe Fit Drain w/ 6" Cast CHR Grate & Round Top	1
72368	4"	PVC General Purpose Pipe Fit Drain w/ 8" Cast CHR Grate & Round Top	1
82368	4"	ABS General Purpose Pipe Fit Drain w/ 8" Cast CHR Grate & Round Top	1
72388	4"	PVC General Purpose Pipe Fit Drain w/ 10" Cast CHR Grate & Round Top	1
82388	4"	ABS General Purpose Pipe Fit Drain w/ 10" Cast CHR Grate & Round Top	1
72319	4"	PVC General Purpose Hub Fit Drain w/ 5" Cast NI Grate & Round Top	1
82319	4"	ABS General Purpose Hub Fit Drain w/ 5" Cast NI Grate & Round Top	1
72339	4"	PVC General Purpose Hub Fit Drain w/ 6" Cast NI Grate & Round Top	1
82339	4"	ABS General Purpose Hub Fit Drain w/ 6" Cast NI Grate & Round Top	1
72359	4"	PVC General Purpose Hub Fit Drain w/ 8" Cast NI Grate & Round Top	1
82359	4"	ABS General Purpose Hub Fit Drain w/ 8" Cast NI Grate & Round Top	1
72379	4"	PVC General Purpose Hub Fit Drain w/ 10" Cast NI Grate & Round Top	1
82379	4"	ABS General Purpose Hub Fit Drain w/ 10" Cast NI Grate & Round Top	1
72329	4"	PVC General Purpose Hub Fit Drain w/ 5" Cast CHR Grate & Round Top	1
82329	4"	ABS General Purpose Hub Fit Drain w/ 5" Cast CHR Grate & Round Top	1
72349	4"	PVC General Purpose Hub Fit Drain w/ 6" Cast CHR Grate & Round Top	1
82349	4"	ABS General Purpose Hub Fit Drain w/ 6" Cast CHR Grate & Round Top	1
72369	4"	PVC General Purpose Hub Fit Drain w/ 8" Cast CHR Grate & Round Top	1
82369	4"	ABS General Purpose Hub Fit Drain w/ 8" Cast CHR Grate & Round Top	1
72389	4"	PVC General Purpose Hub Fit Drain w/ 10" Cast CHR Grate & Round Top	1
82389	4"	ABS General Purpose Hub Fit Drain w/ 10" Cast CHR Grate & Round Top	1

CATEGORY 22 COMMERCIAL DRAINAGE



SS - Stainless Steel BR - Brass NI - Nickel CHR - Chrome

ADJUSTABLE COMMERCIAL CLEANOUT BASES



PVC Barrel With 6" Round Grate

Product No.	Size	Description	Ctn. Qty.
74122	2"	PVC Adj. Commercial Cleanout w/ 6" BR Cover	1
84122	2"	ABS Adj. Commercial Cleanout w/ 6" BR Cover	1
74152	2"	PVC Adj. Commercial Cleanout w/ 6" NI Cover	1
84152	2"	ABS Adj. Commercial Cleanout w/ 6" NI Cover	1
74182	2"	PVC Adj. Commercial Cleanout w/ 6" CHR Cover	1
84182	2"	ABS Adj. Commercial Cleanout w/ 6" CHR Cover	1
74123	3" or 4 "	PVC Adj. Commercial Cleanout w/ 6" BR Cover	1
84123	3" or 4 "	ABS Adj. Commercial Cleanout w/ 6" BR Cover	1
74153	3" or 4 "	PVC Adj. Commercial Cleanout w/ 6" NI Cover	1
84153	3" or 4 "	ABS Adj. Commercial Cleanout w/ 6" NI Cover	1
74183	3" or 4 "	PVC Adj. Commercial Cleanout w/ 6" CHR Cover	1
84183	3" or 4 "	ABS Adj. Commercial Cleanout w/ 6" CHR Cover	1
74124	4"	PVC Adj. Commercial Cleanout w/ 6" BR Cover	1
84124	4"	ABS Adj. Commercial Cleanout w/ 6" BR Cover	1
74154	4"	PVC Adj. Commercial Cleanout w/ 6" NI Cover	1
84154	4"	ABS Adj. Commercial Cleanout w/ 6" NI Cover	1
74184	4"	PVC Adj. Commercial Cleanout w/ 6" CHR Cover	1
84184	4"	ABS Adj. Commercial Cleanout w/ 6" CHR Cover	1
74126	6"	PVC Adj. Commercial Cleanout w/ 6" BR Cover	1
84126	6"	ABS Adj. Commercial Cleanout w/ 6" BR Cover	1
74156	6"	PVC Adj. Commercial Cleanout w/ 6" NI Cover	1
84156	6"	ABS Adj. Commercial Cleanout w/ 6" NI Cover	1
74186	6"	PVC Adj. Commercial Cleanout w/ 6" CHR Cover	1
84186	6"	ABS Adj. Commercial Cleanout w/ 6" CHR Cover	1



PVC Barrel With 6" Round Grate With Round Ring

Product No.	Size	Description	Ctn. Qty.
74132	2"	PVC Adj. Commercial Cleanout w/ 6" BR Cover & Round Ring	1
84132	2"	ABS Adj. Commercial Cleanout w/ 6" BR Cover & Round Ring	1
74162	2"	PVC Adj. Commercial Cleanout w/ 6" NI Cover & Round Ring	1
84162	2"	ABS Adj. Commercial Cleanout w/ 6" NI Cover & Round Ring	1
74192	2"	PVC Adj. Commercial Cleanout w/ 6" CHR Cover & Round Ring	1
84192	2"	ABS Adj. Commercial Cleanout w/ 6" CHR Cover & Round Ring	1
74133	3" or 4 "	PVC Adj. Commercial Cleanout w/ 6" BR Cover & Round Ring	1
84133	3" or 4 "	ABS Adj. Commercial Cleanout w/ 6" BR Cover & Round Ring	1
74163	3" or 4 "	PVC Adj. Commercial Cleanout w/ 6" NI Cover & Round Ring	1
84163	3" or 4 "	ABS Adj. Commercial Cleanout w/ 6" NI Cover & Round Ring	1
74193	3" or 4 "	PVC Adj. Commercial Cleanout w/ 6" CHR Cover & Round Ring	1
84193	3" or 4 "	ABS Adj. Commercial Cleanout w/ 6" CHR Cover & Round Ring	1



PVC Barrel With 6" Round Grate With Round Ring (cont.)



Product No.	Size	Description	Ctn. Qty.
74134	4"	PVC Adj. Commercial Cleanout w/ 6" BR Cover & Round Ring	1
84134	4"	ABS Adj. Commercial Cleanout w/ 6" BR Cover & Round Ring	1
74164	4"	PVC Adj. Commercial Cleanout w/ 6" NI Cover & Round Ring	1
84164	4"	ABS Adj. Commercial Cleanout w/ 6" NI Cover & Round Ring	1
74194	4"	PVC Adj. Commercial Cleanout w/ 6" CHR Cover & Round Ring	1
84194	4"	ABS Adj. Commercial Cleanout w/ 6" CHR Cover & Round Ring	1
74136	6"	PVC Adj. Commercial Cleanout w/ 6" BR Cover & Round Ring	1
84136	6"	ABS Adj. Commercial Cleanout w/ 6" BR Cover & Round Ring	1
74166	6"	PVC Adj. Commercial Cleanout w/ 6" NI Cover & Round Ring	1
84166	6"	ABS Adj. Commercial Cleanout w/ 6" NI Cover & Round Ring	1
74196	6"	PVC Adj. Commercial Cleanout w/ 6" CHR Cover & Round Ring	1
84196	6"	ABS Adj. Commercial Cleanout w/ 6" CHR Cover & Round Ring	1

PVC Barrel With 6" Round Cover With Square Ring



Product No.	Size	Description	Ctn. Qty.
74142	2"	PVC Adj. Commercial Cleanout w/ 6" BR Cover & Square Ring	1
84142	2"	ABS Adj. Commercial Cleanout w/ 6" BR Cover & Square Ring	1
74172	2"	PVC Adj. Commercial Cleanout w/ 6" NI Cover & Square Ring	1
84172	2"	ABS Adj. Commercial Cleanout w/ 6" NI Cover & Square Ring	1
74202	2"	PVC Adj. Commercial Cleanout w/ 6" CHR Cover & Square Ring	1
84202	2"	ABS Adj. Commercial Cleanout w/ 6" CHR Cover & Square Ring	1
74143	3" or 4 "	PVC Adj. Commercial Cleanout w/ 6" BR Cover & Square Ring	1
84143	3" or 4 "	ABS Adj. Commercial Cleanout w/ 6" BR Cover & Square Ring	1
74173	3" or 4 "	PVC Adj. Commercial Cleanout w/ 6" NI Cover & Square Ring	1
84173	3" or 4 "	ABS Adj. Commercial Cleanout w/ 6" NI Cover & Square Ring	1
74203	3" or 4 "	PVC Adj. Commercial Cleanout w/ 6" CHR Cover & Square Ring	1
84203	3" or 4 "	ABS Adj. Commercial Cleanout w/ 6" CHR Cover & Square Ring	1
74144	4"	PVC Adj. Commercial Cleanout w/ 6" BR Cover & Square Ring	1
84144	4"	ABS Adj. Commercial Cleanout w/ 6" BR Cover & Square Ring	1
74174	4"	PVC Adj. Commercial Cleanout w/ 6" NI Cover & Square Ring	1
84174	4"	ABS Adj. Commercial Cleanout w/ 6" NI Cover & Square Ring	1
74204	4"	PVC Adj. Commercial Cleanout w/ 6" CHR Cover & Square Ring	1
84204	4"	ABS Adj. Commercial Cleanout w/ 6" CHR Cover & Square Ring	1
74146	6"	PVC Adj. Commercial Cleanout w/ 6" BR Cover & Square Ring	1
84146	6"	ABS Adj. Commercial Cleanout w/ 6" BR Cover & Square Ring	1
74176	6"	PVC Adj. Commercial Cleanout w/ 6" NI Cover & Square Ring	1
84176	6"	ABS Adj. Commercial Cleanout w/ 6" NI Cover & Square Ring	1
74206	6"	PVC Adj. Commercial Cleanout w/ 6" CHR Cover & Square Ring	1
84206	6"	ABS Adj. Commercial Cleanout w/ 6" CHR Cover & Square Ring	1

CATEGORY 22 COMMERCIAL DRAINAGE



SS - Stainless Steel BR - Brass NI - Nickel CHR - Chrome



Cast Barrel With 6" Round Cover With Round Top

Product No.	Size	Description	Ctn. Qty.
74212	2"	PVC Adj. Commercial Cleanout w/ 6" Cast BR Cover & Round Top	1
84212	2"	ABS Adj. Commercial Cleanout w/ 6" Cast BR Cover & Round Top	1
74222	2"	PVC Adj. Commercial Cleanout w/ 6" Cast NI Cover & Round Top	1
84222	2"	ABS Adj. Commercial Cleanout w/ 6" Cast NI Cover & Round Top	1
74232	2"	PVC Adj. Commercial Cleanout w/ 6" Cast CHR Cover & Round Top	1
84232	2"	ABS Adj. Commercial Cleanout w/ 6" Cast CHR Cover & Round Top	1
74213	3" or 4 "	PVC Adj. Commercial Cleanout w/ 6" Cast BR Cover & Round Top	1
84213	3" or 4 "	ABS Adj. Commercial Cleanout w/ 6" Cast BR Cover & Round Top	1
74223	3" or 4 "	PVC Adj. Commercial Cleanout w/ 6" Cast NI Cover & Round Top	1
84223	3" or 4 "	ABS Adj. Commercial Cleanout w/ 6" Cast NI Cover & Round Top	1
74233	3" or 4 "	PVC Adj. Commercial Cleanout w/ 6" Cast CHR Cover & Round Top	1
84233	3" or 4 "	ABS Adj. Commercial Cleanout w/ 6" Cast CHR Cover & Round Top	1
74214	4"	PVC Adj. Commercial Cleanout w/ 6" Cast BR Cover & Round Top	1
84214	4"	ABS Adj. Commercial Cleanout w/ 6" Cast BR Cover & Round Top	1
74224	4"	PVC Adj. Commercial Cleanout w/ 6" Cast NI Cover & Round Top	1
84224	4"	ABS Adj. Commercial Cleanout w/ 6" Cast NI Cover & Round Top	1
74234	4"	PVC Adj. Commercial Cleanout w/ 6" Cast CHR Cover & Round Top	1
84234	4"	ABS Adj. Commercial Cleanout w/ 6" Cast CHR Cover & Round Top	1
74216	6"	PVC Adj. Commercial Cleanout w/ 6" Cast BR Cover & Round Top	1
84216	6"	ABS Adj. Commercial Cleanout w/ 6" Cast BR Cover & Round Top	1
74226	6"	PVC Adj. Commercial Cleanout w/ 6" Cast NI Cover & Round Top	1
84226	6"	ABS Adj. Commercial Cleanout w/ 6" Cast NI Cover & Round Top	1
74236	6"	PVC Adj. Commercial Cleanout w/ 6" Cast CHR Cover & Round Top	1
84236	6"	ABS Adj. Commercial Cleanout w/ 6" Cast CHR Cover & Round Top	1



ADJUSTABLE GENERAL PURPOSE CLEANOUT BASES



PVC Barrel With 6" Round Cover

Product No.	Size	Description	Ctn. Qty.
74127	3" or 4"	PVC General Purpose Cleanout w/ 6" BR Cover	1
84127	3" or 4"	ABS General Purpose Cleanout w/ 6" BR Cover	1
74157	3" or 4"	PVC General Purpose Cleanout w/ 6" NI Cover	1
84157	3" or 4"	ABS General Purpose Cleanout w/ 6" NI Cover	1
74187	3" or 4"	PVC General Purpose Cleanout w/ 6" CHR Cover	1
84187	3" or 4"	ABS General Purpose Cleanout w/ 6" CHR Cover	1
74128	4"	PVC Pipe Base General Purpose Cleanout w/ 6" BR Cover	1
84128	4"	ABS Pipe Base General Purpose Cleanout w/ 6" BR Cover	1
74158	4"	PVC Pipe Base General Purpose Cleanout w/ 6" NI Cover	1
84158	4"	ABS Pipe Base General Purpose Cleanout w/ 6" NI Cover	1
74188	4"	PVC Pipe Base General Purpose Cleanout w/ 6" CHR Cover	1
84188	4"	ABS Pipe Base General Purpose Cleanout w/ 6" CHR Cover	1
74129	4"	PVC Hub Base General Purpose Cleanout w/ 6" BR Cover	1
84129	4"	ABS Hub Base General Purpose Cleanout w/ 6" BR Cover	1
74159	4"	PVC Hub Base General Purpose Cleanout w/ 6" NI Cover	1
84159	4"	ABS Hub Base General Purpose Cleanout w/ 6" NI Cover	1
74189	4"	PVC Hub Base General Purpose Cleanout w/ 6" CHR Cover	1
84189	4"	ABS Hub Base General Purpose Cleanout w/ 6" CHR Cover	1



PVC Barrel With 6" Round Cover With Round Ring

Product No.	Size	Description	Ctn. Qty.
74137	3" or 4"	PVC General Purpose Cleanout w/ 6" BR Cover & Round Ring	1
84137	3" or 4"	ABS General Purpose Cleanout w/ 6" BR Cover & Round Ring	1
74167	3" or 4"	PVC General Purpose Cleanout w/ 6" NI Cover & Round Ring	1
84167	3" or 4"	ABS General Purpose Cleanout w/ 6" NI Cover & Round Ring	1
74197	3" or 4"	PVC General Purpose Cleanout w/ 6" CHR Cover & Round Ring	1
84197	3" or 4"	ABS General Purpose Cleanout w/ 6" CHR Cover & Round Ring	1
74138	4"	PVC Pipe Base General Purpose Cleanout w/ 6" BR Cover & Round Ring	1
84138	4"	ABS Pipe Base General Purpose Cleanout w/ 6" BR Cover & Round Ring	1
74168	4"	PVC Pipe Base General Purpose Cleanout w/ 6" NI Cover & Round Ring	1
84168	4"	ABS Pipe Base General Purpose Cleanout w/ 6" NI Cover & Round Ring	1
74198	4"	PVC Pipe Base General Purpose Cleanout w/ 6" CHR Cover & Round Ring	1
84198	4"	ABS Pipe Base General Purpose Cleanout w/ 6" CHR Cover & Round Ring	1
74139	4"	PVC Hub Base General Purpose Cleanout w/ 6" BR Cover & Round Ring	1
84139	4"	ABS Hub Base General Purpose Cleanout w/ 6" BR Cover & Round Ring	1
74169	4"	PVC Hub Base General Purpose Cleanout w/ 6" NI Cover & Round Ring	1
84169	4"	ABS Hub Base General Purpose Cleanout w/ 6" NI Cover & Round Ring	1
74199	4"	PVC Hub Base General Purpose Cleanout w/ 6" CHR Cover & Round Ring	1
84199	4"	ABS Hub Base General Purpose Cleanout w/ 6" CHR Cover & Round Ring	1

CATEGORY 22 COMMERCIAL DRAINAGE



SS - Stainless Steel BR - Brass NI - Nickel CHR - Chrome



PVC Barrel With 6" Round Cover With Square Ring

Product No.	Size	Description	Ctn. Qty.
74147	3" or 4"	PVC General Purpose Cleanout w/ 6" BR Cover & Square Ring	1
84147	3" or 4"	ABS General Purpose Cleanout w/ 6" BR Cover & Square Ring	1
74177	3" or 4"	PVC General Purpose Cleanout w/ 6" NI Cover & Square Ring	1
84177	3" or 4"	ABS General Purpose Cleanout w/ 6" NI Cover & Square Ring	1
74207	3" or 4"	PVC General Purpose Cleanout w/ 6" CHR Cover & Square Ring	1
84207	3" or 4"	ABS General Purpose Cleanout w/ 6" CHR Cover & Square Ring	1
74148	4"	PVC Pipe Base General Purpose Cleanout w/ 6" BR Cover & Square Ring	1
84148	4"	ABS Pipe Base General Purpose Cleanout w/ 6" BR Cover & Square Ring	1
74178	4"	PVC Pipe Base General Purpose Cleanout w/ 6" NI Cover & Square Ring	1
84178	4"	ABS Pipe Base General Purpose Cleanout w/ 6" NI Cover & Square Ring	1
74208	4"	PVC Pipe Base General Purpose Cleanout w/ 6" CHR Cover & Square Ring	1
84208	4"	ABS Pipe Base General Purpose Cleanout w/ 6" CHR Cover & Square Ring	1
74149	4"	PVC Hub Base General Purpose Cleanout w/ 6" BR Cover & Square Ring	1
84149	4"	ABS Hub Base General Purpose Cleanout w/ 6" BR Cover & Square Ring	1
74179	4"	PVC Hub Base General Purpose Cleanout w/ 6" NI Cover & Square Ring	1
84179	4"	ABS Hub Base General Purpose Cleanout w/ 6" NI Cover & Square Ring	1
74209	4"	PVC Hub Base General Purpose Cleanout w/ 6" CHR Cover & Square Ring	1
84209	4"	ABS Hub Base General Purpose Cleanout w/ 6" CHR Cover & Square Ring	1



Cast Barrel With 6" Round Cover With Round Top

Product No.	Size	Description	Ctn. Qty.
74217	3" or 4"	PVC General Purpose Cleanout w/ 6" Cast BR Cover & Round Top	1
84217	3" or 4"	ABS General Purpose Cleanout w/ 6" Cast BR Cover & Round Top	1
74227	3" or 4"	PVC General Purpose Cleanout w/ 6" Cast NI Cover & Round Top	1
84227	3" or 4"	ABS General Purpose Cleanout w/ 6" Cast NI Cover & Round Top	1
74237	3" or 4"	PVC General Purpose Cleanout w/ 6" Cast CHR Cover & Round Top	1
84237	3" or 4"	ABS General Purpose Cleanout w/ 6" Cast CHR Cover & Round Top	1
74218	4"	PVC Pipe Base General Purpose Cleanout w/ 6" Cast BR Cover & Round Top	1
84218	4"	ABS Pipe Base General Purpose Cleanout w/ 6" Cast BR Cover & Round Top	1
74228	4"	PVC Pipe Base General Purpose Cleanout w/ 6" Cast NI Cover & Round Top	1
84228	4"	ABS Pipe Base General Purpose Cleanout w/ 6" Cast NI Cover & Round Top	1
74238	4"	PVC Pipe Base General Purpose Cleanout w/ 6" Cast CHR Cover & Round Top	1
84238	4"	ABS Pipe Base General Purpose Cleanout w/ 6" Cast CHR Cover & Round Top	1
74219	4"	PVC Hub Base General Purpose Cleanout w/ 6" Cast BR Cover & Round Top	1
84219	4"	ABS Hub Base General Purpose Cleanout w/ 6" Cast BR Cover & Round Top	1
74229	4"	PVC Hub Base General Purpose Cleanout w/ 6" Cast NI Cover & Round Top	1
84229	4"	ABS Hub Base General Purpose Cleanout w/ 6" Cast NI Cover & Round Top	1
74239	4"	PVC Hub Base General Purpose Cleanout w/ 6" Cast CHR Cover & Round Top	1
84239	4"	ABS Hub Base General Purpose Cleanout w/ 6" Cast CHR Cover & Round Top	1



SEDIMENT DRAINS

Plastic Sediment Drains



Product No.	Size	Description	Ctn. Qty.
76012	2"	PVC Sediment Drain, Plastic Grate w/ Bucket	1
86012	2"	ABS Sediment Drain, Plastic Grate w/ Bucket	1
76013	3"	PVC Sediment Drain, Plastic Grate w/ Bucket	1
86013	3"	ABS Sediment Drain, Plastic Grate w/ Bucket	1
76014	4"	PVC Sediment Drain, Plastic Grate w/ Bucket	1
86014	4"	ABS Sediment Drain, Plastic Grate w/ Bucket	1
76016	6"	PVC Sediment Drain, Plastic Grate w/ Bucket	1
86016	6"	ABS Sediment Drain, Plastic Grate w/ Bucket	1
76022	2"	PVC Sediment Drain, Plastic Grate w/o Bucket	1
86022	2"	ABS Sediment Drain, Plastic Grate w/o Bucket	1
76023	3" or 4 "	PVC Sediment Drain, Plastic Grate w/o Bucket	1
86023	3" or 4 "	ABS Sediment Drain, Plastic Grate w/o Bucket	1
76024	4"	PVC Sediment Drain, Plastic Grate w/o Bucket	1
86024	4"	ABS Sediment Drain, Plastic Grate w/o Bucket	1
76026	6"	PVC Sediment Drain, Plastic Grate w/o Bucket	1
86026	6"	ABS Sediment Drain, Plastic Grate w/o Bucket	1

Cast Iron Sediment Drains



Product No.	Size	Description	Ctn. Qty.
76032	2"	PVC Sediment Drain, Cast Iron Grate w/ Bucket	1
86032	2"	ABS Sediment Drain, Cast Iron Grate w/ Bucket	1
76033	3" or 4 "	PVC Sediment Drain, Cast Iron Grate w/ Bucket	1
86033	3" or 4 "	ABS Sediment Drain, Cast Iron Grate w/ Bucket	1
76034	4"	PVC Sediment Drain, Cast Iron Grate w/ Bucket	1
86034	4"	ABS Sediment Drain, Cast Iron Grate w/ Bucket	1
76036	6"	PVC Sediment Drain, Cast Iron Grate w/ Bucket	1
86036	6"	ABS Sediment Drain, Cast Iron Grate w/ Bucket	1
76042	2"	PVC Sediment Drain, Cast Iron Grate w/o Bucket	1
86042	2"	ABS Sediment Drain, Cast Iron Grate w/o Bucket	1
76043	3" or 4 "	PVC Sediment Drain, Cast Iron Grate w/o Bucket	1
86043	3" or 4 "	ABS Sediment Drain, Cast Iron Grate w/o Bucket	1
76044	4"	PVC Sediment Drain, Cast Iron Grate w/o Bucket	1
86044	4"	ABS Sediment Drain, Cast Iron Grate w/o Bucket	1
76046	6"	PVC Sediment Drain, Cast Iron Grate w/o Bucket	1
86046	6"	ABS Sediment Drain, Cast Iron Grate w/o Bucket	1

CATEGORY 22 COMMERCIAL DRAINAGE



ROOF DRAINS



Roof Drain With Dome And Gravel Guard

Product No.	Size	Description	Ctn. Qty.
78012	2"	PVC Roof Drain w/ Plastic Dome	1
88012	2"	ABS Roof Drain w/ Plastic Dome	1
78022	2"	PVC Roof Drain w/ Cast Iron Dome	1
88022	2"	ABS Roof Drain w/ Cast Iron Dome	1
78013	3" or 4 "	PVC Roof Drain w/ Plastic Dome	1
88013	3" or 4 "	ABS Roof Drain w/ Plastic Dome	1
78023	3" or 4 "	PVC Roof Drain w/ Cast Iron Dome	1
88023	3" or 4 "	ABS Roof Drain w/ Cast Iron Dome	1
78014	4"	PVC Roof Drain w/ Plastic Dome	1
88014	4"	ABS Roof Drain w/ Plastic Dome	1
78024	4"	PVC Roof Drain w/ Cast Iron Dome	1
88024	4"	ABS Roof Drain w/ Cast Iron Dome	1
78016	6"	PVC Roof Drain w/ Plastic Dome	1
88016	6"	ABS Roof Drain w/ Plastic Dome	1
78026	6"	PVC Roof Drain w/ Cast Iron Dome	1
88026	6"	ABS Roof Drain w/ Cast Iron Dome	1



Roof Drain With Dome And Dam Collar

Product No.	Size	Description	Ctn. Qty.
78032	2"	PVC Roof Drain w/ ABS Dome & Dam Collar	1
88032	2"	ABS Roof Drain w/ ABS Dome & Dam Collar	1
78042	2"	PVC Roof Drain w/ Cast Iron Dome & Dam Collar	1
88042	2"	ABS Roof Drain w/ Cast Iron Dome & Dam Collar	1
78033	3" or 4 "	PVC Roof Drain w/ ABS Dome & Dam Collar	1
88033	3" or 4 "	ABS Roof Drain w/ ABS Dome & Dam Collar	1
78043	3" or 4 "	PVC Roof Drain w/ Cast Iron Dome & Dam Collar	1
88043	3" or 4 "	ABS Roof Drain w/ Cast Iron Dome & Dam Collar	1
78034	4"	PVC Roof Drain w/ ABS Dome & Dam Collar	1
88034	4"	ABS Roof Drain w/ ABS Dome & Dam Collar	1
78044	4"	PVC Roof Drain w/ Cast Iron Dome & Dam Collar	1
88044	4"	ABS Roof Drain w/ Cast Iron Dome & Dam Collar	1
78036	6"	PVC Roof Drain w/ ABS Dome & Dam Collar	1
88036	6"	ABS Roof Drain w/ ABS Dome & Dam Collar	1
78046	6"	PVC Roof Drain w/ Cast Iron Dome & Dam Collar	1
88046	6"	ABS Roof Drain w/ Cast Iron Dome & Dam Collar	1



Underdeck Clamp Kit For Roof Drains

Product No.	Size	Description	Ctn. Qty.
47700		PVC Plastic Underdeck Clamp Kit	1



Roof Drain Dome

Product No.	Size	Description	Ctn. Qty.
71980		ABS Plastic Roof Drain Dome	1
71990		Cast Iron Roof Drain Dome	1



Receiver Pan

Product No.	Size	Description	Ctn. Qty.
47701		ABS Plastic Receiver Pan	1

COMPONENTS



Commercial Bases

Product No.	Size	Description	Ctn. Qty.
70002	2"	PVC Base	1
80002	2"	ABS Base	1
70003	3" or 4 "	PVC Base	1
80003	3" or 4 "	ABS Base	1
70004	4"	PVC Base	1
80004	4"	ABS Base	1
70006	6"	PVC Base	1
80006	6"	ABS Base	1



General Purpose Bases

Product No.	Size	Description	Ctn. Qty.
70009	4"	PVC Hub Fit Drain	1
80009	4"	ABS Hub Fit Drain	1
70008	4"	PVC Pipe Fit Drain	1
80008	4"	ABS Pipe Fit Drain	1
70007	3" or 4"	PVC Pipe Fit Drain Base	1
80007	3" or 4"	ABS Pipe Fit Drain Base	1

Roof Drains

Product No.	Size	Description	Ctn. Qty.
71970		Plastic Gravel Guard	1
71960		Dam Collar	1



Sediment Drains

Product No.	Size	Description	Ctn. Qty.
71740		Plastic Sediment Grate	1
71750		Plastic Sediment Grate Collar	1
71760		Plastic Sediment Debris Bucket	1
71770		Cast Iron Sediment Grate	1
71780		Cast Iron Sediment Grate Collar	1
71790		Cast Iron Sediment Debris Bucket	1



Barrels, Plugs & Collars

Product No.	Size	Description	Ctn. Qty.
71550	5"	Plastic Barrel	1
71560	6"	Plastic Barrel	1
71570	3"	Plastic Cleanout Plug	1
71580		Reversible Clamping Collar	1

Replacement Grates



Product No.	Size	Description	Ctn. Qty.
80010	5"	SS Grate	1
80020	5"	Round BR Grate	1
80030	5"	Round BR Grate & Ring	1
80040	5"	Round BR Grate & Square Ring	1
80050	5"	Round NI Grate	1
80060	5"	Round NI Grate & Ring	1
80070	5"	Round NI Grate & Square Ring	1
80080	5"	Round CHR Grate	1
80090	5"	Round CHR Grate & Ring	1
80100	5"	Round CHR Grate & Square Ring	1
80110	6"	SS Grate	1
80120	6"	Round BR Grate	1
80130	6"	Round BR Grate & Ring	1
80140	6"	Round BR Grate & Square Ring	1
80150	6"	Round NI Grate	1
80160	6"	Round NI Grate & Ring	1
80170	6"	Round NI Grate & Square Ring	1
80190	6"	Round CHR Grate & Ring	1
80200	6"	Round CHR Grate & Square Ring	1



Plastic Adjustable Barrels With Grates

Product No.	Size	Description	Ctn. Qty.
72010	5"	SS Grate & Plastic Barrel	1
72020	5"	Round BR Grate & Plastic Barrel	1
72030	5"	Round BR Grate & Ring & Plastic Barrel	1
72040	5"	Round BR Grate & Square Ring & Plastic Barrel	1
72050	5"	Round NI Grate & Plastic Barrel	1
72060	5"	Round NI Grate & Ring & Plastic Barrel	1
72070	5"	Round NI Grate & Square Ring & Plastic Barrel	1
72080	5"	Round CHR Grate & Plastic Barrel	1
72090	5"	Round CHR Grate & Ring & Plastic Barrel	1
72100	5"	Round CHR Grate & Square Ring & Plastic Barrel	1
72110	6"	SS Grate & Plastic Barrel	1
72120	6"	Round BR Grate & Plastic Barrel	1
72130	6"	Round BR Grate & Ring & Plastic Barrel	1
72140	6"	Round BR Grate & Square Ring & Plastic Barrel	1
72150	6"	Round NI Grate & Plastic Barrel	1
72160	6"	Round NI Grate & Ring & Plastic Barrel	1
72170	6"	Round NI Grate & Square Ring & Plastic Barrel	1
72180	6"	Round CHR Grate & Plastic Barrel	1
72190	6"	Round CHR Grate & Ring & Plastic Barrel	1
72200	6"	Round CHR Grate & Square Ring & Plastic Barrel	1

SS - Stainless Steel BR - Brass NI - Nickel CHR - Chrome

Vandalproof Screws

Product No.	Size	Description	Ctn. Qty.
81940	3/8"	10 x 24 Stainless Steel Vandal Proof Screw	10
81950	3/8 "	10 x 24 Brass Vandal Proof Screw	10



Cast Adjustable Barrels With Grates

Product No.	Size	Description	Ctn. Qty.
82210	4"	Cast NI Square Barrel & Square NI Grate	1
82220	4"	Cast CHR Square Barrel & Square CHR Grate	1
82230	5"	Cast NI Square Barrel & Square NI Grate	1
82240	5"	Cast CHR Square Barrel & Square CHR Grate	1
82250	6"	Cast NI Square Barrel & Square NI Grate	1
82260	6"	Cast CHR Square Barrel & Square CHR Grate	1
82270	5"	Cast NI Square Barrel & Round NI Grate	1
82280	5"	Cast CHR Square Barrel & Round CHR Grate	1
82290	6"	Cast NI Square Barrel & Round NI Grate	1
82300	6"	Cast CHR Square Barrel & Round CHR Grate	1
82310	5"	Cast NI Round Barrel & Round NI Grate	1
82320	5"	Cast CHR Round Barrel & Round CHR Grate	1
82330	6"	Cast NI Round Barrel & Round NI Grate	1
82340	6"	Cast CHR Round Barrel & Round CHR Grate	1
82350	8"	Cast NI Round Barrel & Round NI Grate	1
82360	8"	Cast CHR Round Barrel & Round CHR Grate	1
82370	10"	Cast NI Round Barrel & Round NI Grate	1
82380	10"	Cast CHR Round Barrel & Round CHR Grate	1

Extra Heavy Duty Barrels

Product No.	Size	Description	Ctn. Qty.
82390	6"	Cast Brass Barrel With Round Heavy Duty Grate With Round Ring	1
82400	6"	Cast Nickel Barrel With Round Heavy Duty Grate With Round Ring	1
82410	6"	Cast Chrome Barrel With Round Heavy Duty Grate With Round Ring	1

Replacement Covers



Product No.	Size	Description	Ctn. Qty.
81120	6"	Round BR Cover	1
81130	6"	Round BR Cover & Ring	1
81140	6"	Round BR Cover & Square Ring	1
81150	6"	Round NI Cover	1
81160	6"	Round NI BR Cover & Ring	1
81170	6"	Round NI Cover & Square Ring	1
81180	6"	Round CHR Cover	1
81190	6"	Round CHR Cover & Ring	1
81200	6"	Round CHR Cover & Square Ring	1





Plastic Barrel Cleanouts

Product No.	Size	Description	Ctn. Qty.
74120	6"	IPS Adj. Barrel & 6" Round BR Cover	1
74130	6"	IPS Adj. Barrel & 6" Round BR Cover & Ring	1
74140	6"	IPS Adj. Barrel & 6" Round BR Cover & Square Ring	1
74150	6"	IPS Adj. Barrel & 6" Round NI Cover	1
74160	6"	IPS Adj. Barrel & 6" Round NI Cover & Ring	1
74170	6"	IPS Adj. Barrel & 6" Round NI Cover & Square Ring	1
74180	6"	IPS Adj. Barrel & 6" Round CHR Cover	1
74190	6"	IPS Adj. Barrel & 6" Round CHR Cover & Ring	1
74200	6"	IPS Adj. Barrel & 6" Round CHR Cover & Square Ring	1



Cast Barrel Cleanouts

Product No.	Size	Description	Ctn. Qty.
84210	6"	Cast 6" BR Round Barrel w/Cleanout & Round BR Cover	1
84220	6"	Cast 6" NI Round Barrel w/Cleanout & Round NI Cover	1
84230	6"	Cast 6" CHR Plated BR Round Barrel w/ Cleanout & Round CHR Plated BR Cover	1

ACCESSORIES



Floor Sinks

Product No.	Size	Description	Ctn. Qty.
42720	2"	PVC Floor Sink	1
42721	3"	PVC Floor Sink	1
42722	4"	PVC Floor Sink	1



Top Grate For Floor Sinks

Product No.	Size	Description	Ctn. Qty.
42751		Half Top Grate For Floor Sink	1
42752		Three-Quarter Top Grate For Floor Sink	1
42753		Full Top Grate For Floor Sink	1

Cast Iron Drain Funnels

Product No.	Size	Description	Ctn. Qty.
71720		Cast Iron Round Drain Funnel	1
71730		Cast Iron Oval Drain Funnel	1

Reversible Dome Strainers/Buckets

Product No.	Size	Description	Ctn. Qty.
42754	2"	Bottom Aluminum Dome Strainer	1
42755	3"	Bottom Aluminum Dome Strainer	1
42756	4"	Bottom Aluminum Dome Strainer	1

SS - Stainless Steel BR - Brass NI - Nickel CHR - Chrome



Category 23

Rough-In Products

Count on Oatey rough-in products when you're tackling any plumbing job. Access Panels are great for allowing access to service areas for plumbing, electrical, security systems, telephone, computer cables, sprinkler systems and more. Can be flush or surface mounted. Tub protectors protect tub surfaces from debris during remodel or construction jobs. A wide variety of test caps are also available.

Keep the Pressure In with Oatey Test Caps (see pages 234)

Oatey introduces our new line of Test Caps. Consisting of Knock-Out™ Test Caps, End-Cap™ Test Caps, Push-Cap™ Covers and Multi-Size (MS) End-Cap™ Test Caps, Oatey offers a complete range to meet the needs of your particular application.

NEW!
From Oatey®

Knock-Out™ Test Caps

- Solvent cements to Sch. 40 ABS and PVC DWV pipe.
- **Deeper design** provides stronger leak-free connections.
- **Knock-out center** can be removed with "tab" preventing possible blockages.
- **"Tab" feature** keeps hands free of solvent cement.
- **Will withstand 17 PSI or 40' head pressure.**
- **Made of white ABS.**



End-Cap™ Test Cap

- Solvent cements to end of Sch. 40 ABS and PVC DWV pipe.
- **Deep design** provides extra sealing strength.
- **Heavy duty design** allows testing to 17 PSI or 40' head pressure.
- **Made of black ABS and white PVC.**



Push-Cap™ Cover

- **Friction-fit test cap.**
- **Do not use for pressure testing.**
- **No solvent cement necessary for installation.**
- **For use on Sch. 40 ABS and PVC DWV pipe and fittings.**
- **Made of polyethylene.**
- **Slips over DWV pipe or inside fitting.**



MS End-Cap™ Test Cap

- Solvent cements to end of Sch. 40 ABS and PVC DWV pipe.
- **Multi-size design** allows for use on 1.5" and 2" or 3" and 4" pipe.
- **Heavy duty construction** for testing to 17 PSI or 40' head pressure.
- **Deep design** provides extra sealing strength.
- **Made of black ABS and white PVC.**





#34055 shown

Access Panel

- Provides a service area for plumbing, electrical, security systems, telephone, TV, computer cables and sprinkler system applications.
- Eliminates costly repair.
- Special designed drill guides for cable or wire.
- Paint and wallpaper compatible.
- No lumber framing required. Ideal for new construction.
- Reversible outer frame allows for flush mounting.

Product No.	Size	Description	Ctn. Qty.
34054	4" x 6"	Plastic Access Panel	12
34055	6" x 9"	Plastic Access Panel	6
34053	6" x 9"	Plastic Access Panel – Display	6
34045	8" x 8"	Plastic Access Panel	6
34056	14" x 14"	Plastic Access Panel	6
34059	14" x 14"	Plastic Access Panel – Display	4
34044	14" x 29"	Plastic Access Panel	6



Toilet Base Plate

- Cover damaged and missing tile when replacing toilet.
- Manufactured from high impact ABS.

Product No.	Size	Description	Ctn. Qty.
31258		Square Nose Toilet Base Plate	12
31259		Round Nose Toilet Base Plate	12

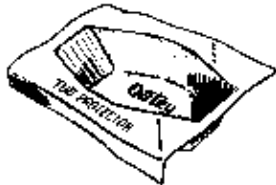

Bath Tub Protector

- Offers protection against tub damage during home construction.
- A semi-flexible, heavy, high-impact plastic with deep-fluted sidewalls.
- Includes a non-skid foampad to absorb shock and prevent scratched and dented tub finish.
- Nests for space-saving storage.

Product No.	Size	Description	Ctn. Qty.
34069	14"	Bath Tub Protector	35
34068	15"	15" Deep/57" Long Fits 14" Tubs	35
34070	16"	Bath Tub Protector	35
34076	16"	Bath Tub Protector – Oval	25
34125	14" - 16"	Multi-Size Adjustable Bath Tub Protector	35



Tub Box

- Provides a quick, economical and clean method of installing tub waste and drain.
- Built in cut-out for up to 2" Schedule 40 drain.
- Enables installer to form a clean cavity in a concrete slab so a trap can be easily connected to the drain system.
- Manufactured from semi-flexible, very durable, plastic polymer.
- Bottom I.D.: 11-1/2" x 11-1/2"
- Top I.D.: 13" x 13", Depth 6-1/2"

Product No.	Size	Description	Ctn. Qty.
34080		Standard Tub Box	12 Pair



TB-2000® Tub Box

- Provides a quick, economical and clean method of installing tub waste and drain.
- Pull tab access.
- For 1-1/2" and 2" pipe.
- Bottom I.D.: 11-3/8", Depth 7"
- Top I.D.: 13", Depth 7"

Product No.	Size	Description	Ctn. Qty.
34087		TB 2000 Tub Box	5 Pair





Pipe Guard

- Will not attack plastic pipe. Polyethylene sleeving is 4mils thick. The material accommodates 1/2" – 1" pipe in red (for hot water pipe) and blue (for cold water pipe).
- Protects copper and plastic in concrete.
- For non code installations.

Product No.	Size	Description	Ctn. Qty.
38707	200'	Pipe Guard – Blue	10
38708	200'	Pipe Guard – Red	10



Protect-A-Wrap Foam Wrap

- Adhesive backed foam tape.
- For ADA compliance on P-traps.

Product No.	Size	Description	Ctn. Qty.
38710	1/8"H x 2"W x 40'L	Protect-A-Wrap	24



#38711 shown

Foam Closet Spacer/Wrap

- Used to keep cement away from pipe penetrations during rough-in.
- Allows easy fitting installation after cement pour.

Product No.	Size	Description	Ctn. Qty.
38711	4" x 4"	Foam Closet Spacer	60
38712	4" x 82'	Foam Closet Wrap	9



#38600 shown

Quiet Pipes®

- Eliminates water pipe banging caused by quick closing valves.
- Can be installed in any position.

Product No.	Size	Description	Ctn. Qty.
38600		Quiet Pipes Washing Machine Supply Line Shock Absorber	6
38601		Quiet Pipes MIP Shock Absorber – Discontinued after 12/31/12**	6
39177		Quiet Pipes MIP Shock Absorber – Low Lead	6

**** Note:** Federal regulations require the discontinuation of products containing more than 0.25% lead as of January 1, 2014. Oatey is implementing this change a year early so customers do not buy products they can't use. Therefore, certain products will be discontinued as of December 31, 2012.



Knock-Out™ Test Cap

- Solvent cements to Sch. 40 ABS and PVC DWV pipe.
- Deeper design provides stronger leak-free connections.
- "Tab" feature keeps hands free of solvent cement.
- Will withstand 10 PSI or 30' head pressure.

Product No.	Size	Description	Ctn. Qty.
33460	1-1/2"	Knock-Out™ Inset Test Cap	1500
33461	2"	Knock-Out™ Inset Test Cap	1200
33462	3"	Knock-Out™ Inset Test Cap	500
33463	4"	Knock-Out™ Inset Test Cap	300
39100	1-1/2"	Knock-Out™ Test Cap w/Barcode	20
39101	2"	Knock-Out™ Test Cap w/Barcode	20
39102	3"	Knock-Out™ Test Cap w/Barcode	15
39103	4"	Knock-Out™ Test Cap w/Barcode	15



End-Cap™ Test Cap

- Solvent cements to end of Sch. 40 ABS and PVC DWV pipe.
- Deep design provides extra sealing strength.
- Heavy duty design allows testing to 15 PSI or 40' head pressure.

Product No.	Size	Description	Ctn. Qty.
33468	1-1/2"	End-Cap™ PVC	1000
33469	1-1/2"	End-Cap™ ABS	1000
33470	2"	End-Cap™ PVC	800
33471	2"	End-Cap™ ABS	800
33472	3"	End-Cap™ PVC	400
33473	3"	End-Cap™ ABS	400
33474	4"	End-Cap™ PVC	200
33475	4"	End-Cap™ ABS	200
33476	6"	End-Cap™ PVC	50
33477	6"	End-Cap™ ABS	50
39105	1-1/2"	End-Cap™ w/Barcode	25
39106	2"	End-Cap™ w/Barcode	25
39107	3"	End-Cap™ w/Barcode	25
39108	4"	End-Cap™ w/Barcode	25



Push-Cap™ Test Cap

- Friction-fit test cap for use up to 10' head pressure.
- For use on Sch. 40 ABS and PVC DWV pipe and fittings.
- Made of polyethylene.
- Slips over DWV pipe or inside fitting.
- No solvent cement necessary.

Product No.	Size	Description	Ctn. Qty.
33464	1-1/2"	Push-Cap™ Test Cap	250
33465	2"	Push-Cap™ Test Cap	150
33466	3"	Push-Cap™ Test Cap	100
33467	4"	Push-Cap™ Test Cap	50
39110	1-1/2"	Push-Cap™ Test Cap w/Barcode	25
39111	2"	Push-Cap™ Test Cap w/Barcode	25





MS End-Cap™ Test Cap

- Solvent cements to end of Sch. 40 ABS and PVC DWV pipe.
- Multi-size design allows for use on 1.5" and 2" or 3" and 4" pipe.
- Deep design provides extra sealing strength.
- Heavy duty construction for testing to 15 PSI or 40' head pressure.

Product No.	Size	Description	Ctn. Qty.
33478	1-1/2 -2"	MS End-Cap™ Test Cap PVC	500
33479	1-1/2 -2"	MS End-Cap™ Test Cap ABS	500
33480	3" - 4"	MS End-Cap™ Test Cap PVC	200
33481	3" - 4"	MS End-Cap™ Test Cap	200
39115	1-1/2 - 2"	2 in 1 End Cap w/Barcode	25
39116	3" - 4"	2 in 1 End Cap w/Barcode	25



PVC Test-Kap® Plugs

- Stainless steel hose clamp won't corrode.
- For use on plastic, steel, copper and cast-iron pipe.
- Reinforced cross-molded top increases strength.
- Tighten clamp with torque wrench or screwdriver to 60 inch pounds.

Product No.	Size	Description	Ctn. Qty.	Back Pressure P.S.I.	Feet of Head
270725	1-1/2"	Test-Kap® Plug	10	13 PSI	30 FT
270733	2"	Test-Kap® Plug	10	13 PSI	30 FT
270741	3"	Test-Kap® Plug	10	13 PSI	30 FT
270768	4"	Test-Kap® Plug	10	13 PSI	30 FT
270776	5"	Test-Kap® Plug	5	13 PSI	30 FT
270784	6"	Test-Kap® Plug	5	13 PSI	30 FT

Average Handling/Set Up Times For PVC/CPVC Solvent Cements

Handling/Set Up Time is the time required prior to handling the joint. In damp or humid weather, allow 50% additional time.

Temperature during assembly	Pipe Diameter ½" to 1-¼"	Pipe Diameter 1-½" to 3"	Pipe Diameter 4" to 5"	Pipe Diameter 6" to 8"	Pipe Diameter 10" to 16"	Pipe Diameter 18"+
60° - 100°F	2 minutes	5 minutes	15 minutes	30 minutes	2 hours	4 hours
40° - 60°F	5 minutes	10 minutes	30 minutes	90 minutes	8 hours	16 hours
20° - 40°F	8 minutes	12 minutes	60 minutes	3 hours	12 hours	24 hours
0° - 20°F	10 minutes	15 minutes	2 hours	6 hours	24 hours	48 hours

These figures should only be used as a general guide. Conditions in the field may vary.

Average Joint Cure Times for Oatey Solvent Cements

PVC & ABS

Pipe Diameter	Temperature during assembly and cure period	Temperature during assembly and cure period			
		60°-100°F 16°-38°C	40°-60°F 4°-16°C	20°-40°F -7°-4°C	0°-20°F -18°-7°C
1/2" to 1-1/4" 13 to 32mm	Up to 180 psi	15 min	20 min	30 min	60 min
	180 psi +	4 hrs	8 hrs	36 hrs	48 hrs
1-1/2" to 3" 40 to 80mm	Up to 180 psi	30 min	45 min	60 min	120 min
	180 psi +	8 hrs	16 hrs	72 hrs	96 hrs
4" to 5" 100 to 125mm	Up to 180 psi	2 hrs	4 hrs	36 hrs	48 hrs
	180 psi +	12 hrs	24 hrs	4 days	8 days
6" to 8" 150 to 200mm	Up to 180 psi	8 hrs	16 hrs	3 days	4 days
	180 psi +	24 hrs	48 hrs	9 days	12 days
10" to 16" 250 to 400 mm	Up to 100 psi	24 hrs	48 hrs	8 days	10 days
	Up to 100 psi	36 hrs	72 hrs	12 days	14 days

CPVC

Pipe Diameter	Temperature during assembly and cure period	Temperature during assembly and cure period			
		60°-100°F 16°-38°C	40°-60°F 4°-16°C	20°-40°F -7°-4°C	0°-20°F -18°-7°C
1/2" to 1-1/4" 13 to 32mm	Up to 180 psi	1 hr	2 hrs	6 hrs	8 hrs
	180 psi +	6 hrs	12 hrs	36 hrs	48 hrs
1-1/2" to 3" 40 to 80mm	Up to 180 psi	2 hrs	4 hrs	12 hrs	16 hrs
	180 psi +	12 hrs	24 hrs	72 hrs	96 hrs
4" to 5" 100 to 125mm	Up to 180 psi	6 hrs	12 hrs	36 hrs	48 hrs
	180 psi +	18 hrs	36 hrs	4 days	8 days
6" to 8" 150 to 200mm	Up to 180 psi	8 hrs	16 hrs	3 days	4 days
	180 psi +	24 hrs	48 hrs	9 days	12 days
10" to 16" 250 to 400 mm	Up to 100 psi	24 hrs	48 hrs	8 days	10 days
	Up to 100 psi	36 hrs	72 hrs	12 days	14 days

This data is applicable only for new piping installations and not recommended for repair or cut-ins on hot and cold mwater distribution systems. Please contact Oatey Technical Service for recommendations on Cure Times for such applications.

DO NOT test PVC and CPVC piping systems with compressed air or gas.

Notes: Cure schedule is the time required before pressure testing the system

- This chart can be used as a guideline to determine joint cure
- Cure times stated are for conditions with relative humidity of 60% or less
- + In damp or humid weather allow 50% additional cure time

Average Number of Joints Per Quart of Solvent Cement

Pipe Diameter	½"	¾"	1"	1-¼"	1-½"	2"	3"	4"	6"	8"	10"	12"	15"	18"
Number of Joints	325	250	150	125	90	70	50	30	10	8	3	2	¾	½

These figures are estimates based on laboratory testing. Conditions in the field may vary.



4700 W. 160th St. | Cleveland, OH 44135
800.321.9532 | Fax: 800.321.9535
www.oatey.com

This information is based on data believed to be reliable but Oatey makes no warranties, express or implied, as to its accuracy and assumes no liability arising out of its use. The data listed falls within the normal range of product properties but should not be used to establish specification limits or used alone as the basis of design. Oatey's liability to purchasers is expressly limited to the terms and conditions of sale. Oatey is a trademark of Oatey Co.

DISTRIBUTED BY

OATEYSCS[®]

Supply Chain Services

4675 W. 160th St. | Cleveland, OH 44135
800.321.9532 | Fax: 800.321.9535
www.oateyscs.com

Numerical Listing



Product No.	Size	Description	Ctn. Qty.	UPC	Category	Page Number
000628		0-30 psi Gauge 2" Face 0.5 psi Increments	1	675115000629	20	195
000638		0-60 psi Gauge 2" Face 1 psi Increments	1	675115000636	20	195
000648		0-100 psi Gauge 2" Face 2 psi Increments	1	675115000643	20	195
000658		Hex Test Body 1/8" Tap	1	675115000650	20	195
000698		0-15 psi Gauge 2" Face 0.1 psi Increments	1	675115000698	20	195
006193		Clog-Buster® Faucet Adapter	1	675115006195	20	194
010205		Manometer	1	675115010208	20	194
012678		Tub Plug Set (Overflow & Drain)	12	675115012677	19	191
019698		0-30 psi Gauge 2" Face 0.5 psi Increments	1	675115019690	20	195
019708		0-60 psi Gauge 2" Face 1 psi Increments	1	675115019706	20	195
019718		0-100 psi Gauge 2" Face 2 psi Increments	1	675115019713	20	195
024568		0-15 psi Gauge 2" Face 0.1 psi Increments	1	675115024564	20	195
034588		Replacement Hose Assembly w/ Thumb Lock	1	675115034587	20	191
041386	8"	Test-Ball® Plug	1	675115041387	18	184
041394	10"	Test-Ball® Plug	1	675115041394	18	184
041408	12"	Test-Ball® Plug	1	675115041400	18	184
048468		0-60 psi, 2.5" Dial, Plug Pressure Gauge With Retarded Increments To 160 Psi With Cover	1	675115048468	20	196
053458		0-60 psi, 2.5" Dial, Plug Pressure Gauge With Retarded Increments To 160 Psi	1	675115053458	20	196
055728		Replacement Hose Assembly w/ Thumb Lock	1	675115055728	20	191
055808		Inflator With Clamp (Male End)	1	675115055803	20	196
055816		Deflator With Clamp (Female End)	1	675115055810	20	196
059708		2" Ring With 12" Chain	1	675115059702	20	195
059718		3" Ring With 12" Chain	1	675115059719	20	195
059728		4" Ring With 12" Chain	1	675115059726	20	195
059748		6" Ring With 12" Chain	1	675115059740	20	195
059758		2" Ring With 24" Chain	1	675115059757	20	195
059768		3" Ring With 24" Chain	1	376115059764	20	195
059778		4" Ring With 24" Chain	1	675115059771	20	195
059788		5" Ring With 24" Chain	1	675115059788	20	195
059798		6" Ring With 24" Chain	1	675115059795	20	195
065808		Smoke Fluid: One Gallon	4	675115065802	20	194
065818		Smoke Fluid: Five Gallons	1	675115065819	20	194
065828		Smoke Fluid: Fifty-Five Gallon Drum	1	675115065826	20	194
068527		Replacement Snifter Valve 1/8"	1	675115068520	20	195
072608		Smoke Bomb: 30 Seconds	12	675115034340	20	194
072618		Smoke Bomb: 60-Seconds	12	675115034358	20	194
072628		Smoke Bomb: 3 Minutes	12	675115034365	20	194
072638		Smoke Bomb: 3 Minutes Double Wick	12	675115034372	20	194
10		Standard Sink Basket Strainer, Stainless Steel Body and Basket. Rubber Stopper w/ Metal Post	24	041193050410	17	169
100-17-1	1-1/2" x 13"	Center to End Disposer Kit - 17 Ga.	10	041193105905	15	141
100-20-1	1-1/2" x 13"	Center to End Disposer Kit - 20 Ga.	10	041193105912	15	141
100-22-1	1-1/2" x 13"	Center to End Disposer Kit - Budget Ga.	10	041193105943	15	141
1004		1-1/4" x 1-1/4" Male (Female Copper Sweat)	6	041193050434	17	174
1005		1-1/2" x 1-1/2" Male (Female Copper Sweat)	6	041193050441	17	174
1012		1-1/4" x 1-1/4" Female, Ground Joint Waste Connector	6	041193106339	17	174
1013		1-1/2" x 1-1/2" Female, Ground Joint Waste Connector	6	041193050458	17	174
1014		1-1/4" x 1-1/2" Female, Ground Joint Waste Connector	6	041193050465	17	174



Product No.	Size	Description	Ctn. Qty.	UPC	Category	Page Number
1023		3-1/4" - 4" Adj. Drum Trap Cover (Style A) w/ 5-1/4" Stainless Steel Cover & Rubber Gasket	10	041193057860	17	179
1024		3-1/4" - 4" Adj. Drum Trap Cover (Style B) w/ 5-1/4" Stainless Steel Cover & Rubber Gasket	10	041193057877	17	179
1032AD-1	2" x 5" x 7"	Closet Flush Elbow - 20 Ga.	5	041193050502	15	143
1032ADBN-1	2" x 5" x 7"	Closet Flush Elbow - 20 Ga. w/ Brass Nuts	5	041193090881	15	143
1032D-1	2" x 4" x 6"	Closet Flush Elbow - 20 Ga.	5	041193049827	15	143
1033D-1	2" x 6" x 8"	Closet Flush Elbow - 20 Ga.	5	041193049841	15	143
1033DBN-1	2" x 6" x 8"	Closet Flush Elbow - 20 Ga. w/ Brass Nuts	5	041193091055	15	143
104		Add-On Shower w/ No. 353 Tub Spout, 3/4" NPT w/ 3/4" x 1/2" Face Bushing	1	041193102041	17	180
1046-1	1-1/4"	Double Slip Joint Trap Offset - 20 Ga.	5	041193050199	15	141
1046-17BN-1	1-1/4"	Double Slip Joint Trap Offset - 17 Ga. w/ Brass Nuts	5	041193013262	15	141
1046A-1	1-1/2"	Double Slip Joint Trap Offset - 20 Ga.	5	041193050205	15	141
1046A-17BN-1	1-1/2"	Double Slip Joint Trap Offset - 17 Ga. w/ Brass Nuts	5	041193009746	15	141
1046ABN-1	1-1/2"	Double Slip Joint Trap Offset - 20 Ga. w/ Brass Nuts	5	041193106742	15	141
1056		1-3/8" Plated Steel Shower Curtain Pins	100	041193050533	17	180
10606	1.8 oz.	6-1 Dz. Display Packs	72	032628106062	3	44
10608	2 oz.	Display Pack, Screw Cap With Brush	48	032628106086	3	44
10616	1/2 lb.	Climate Smooth™ Soldering Paste	24	032628106161	3	44
10619	9 oz.	Screw Cap With Brush	24	032628106192	3	44
10621	1 lb.	Climate Smooth™ Soldering Paste	24	032628106215	3	44
107		1/2" x 21" Bent Riser Add-On Basement Shower w/Soap Dish	1	041193106766	17	180
10810	4 oz.	Dauber In Cap	24	032628108103	3	44
10815	8 oz.	Dauber In Cap	24	032628108158	3	44
108A-1	1-1/2" x 16"	Center To Center, Slip Joint - 20 Ga.	10	041193050540	15	137
108B-1	1-1/2" x 21"	Center To Center, Slip Joint - 20 Ga.	10	041193106797	15	137
109-20-1	1-1/2" x 24"	Center To Center, Slip Joint - 20 Ga.	1	041193106841	15	137
1097		3/8" O.D. for 1/4" Nom	50	041193107008	17	176
1098		1/2" O.D. for 3/8" Nom	50	041193107015	17	176
1099		5/8" O.D. for 1/2" Nom	50	041193102058	17	176
1099A		7/8" O.D. For 3/4" Nom Copper	50	041193102065	17	176
1099AB		7/8" O.D. For 3/4" Nom	250	041193107046	17	176
1099B		5/8" O.D. For 1/2" Nom	250	041193107053	17	176
10T		Same as 10 w/ 4" Chrome Plated Tailpiece	24	041193050557	17	169
11		Standard Sink Basket Strainer, Stainless Steel Body and Basket. Rubber Stopper w/ Chromed Plastic Post	24	041193014344	17	169
1100		3/8" NPT	50	041193032294	17	174
1100B		3/8" NPT	250	041193107312	17	174
1101		1/2" NPT	50	041193102072	17	174
1101R		Rubber Escutcheon	50		17	174
1101A		3/4" NPT	50	041193102089	17	174
1101AA		1" NPT	50	041193107343	17	174
1101B		1/2" NPT	250	041193107350	17	174
1102		1-1/4" O.D.	50	041193107367	17	174
1104		1-1/2" O.D.	50	041193107374	17	174
1104A		2" O.D.	50	041193107381	17	174
1105		1-1/4" NPT	50	041193102096	17	174
1106		1-1/2" NPT	50	041193107404	17	174
1106A		2" NPT	50	041193107411	17	174



Product No.	Size	Description	Ctn. Qty.	UPC	Category	Page Number
1106B		1-1/2" NPT	250	041193107428	17	174
1107A		3/8" O.D. For 1/4" Nom	50	041193107435	17	174
1107B		1/2" O.D. For 3/8" Nom	50	041193107442	17	174
1107C		5/8" O.D. For 1/2" Nom	50	041193107459	17	174
1107D		11/16" O.D. For Sweat Extension	50	041193107466	17	174
1109		3/8" I.P.S.	50	041193107473	17	174
1110		1/2" NPT	50	041193050021	17	174
1114		1-1/4" O.D.	50	041193107510	17	174
1114A		1-1/4" NPT	50	041193107527	17	174
1115		1-1/2" O.D.	50	041193107534	17	174
1115A		1-1/2" NPT	50	041193107541	17	174
1116		1-1/4" O.D.	12	041193107558	17	174
1116A		1-1/4" NPT	12	041193107565	17	174
1117		1-1/2" O.D.	12	041193107572	17	174
1117A		1-1/2" NPT	12	041193107589	17	174
1118		2" Deep Flange	12	041193015921	17	174
1119-1	3/8"	NPT Cast Brass Flange w/ Set Screw	12	041193107596	15	144
1119A-1	1/2"	NPT Cast Brass Flange w/ Set Screw	12	041193107602	15	144
1119D-1	5/8"	O.D. Cast Brass Flange w/ Set Screw	12	041193107633	15	144
111A-1	1-1/2" x 16"	Center To Center, Slip Joint - 17 Ga.	10	041193050564	15	137
111ABN-1	1-1/2" x 16"	Center To Center, Slip Joint - 17 Ga. w/ Brass Nuts	10	041193107480	15	137
1120E-1	1-1/2"	NPT Cast Brass Flange w/ Set Screw	12	041193107817	15	144
1121A-1	1-1/4"	O.D. Cast Brass Deep Flange w/ Set Screw	12	041193107824	15	144
1121B-1	1-1/2"	O.D. Cast Brass Deep Flange w/ Set Screw	12	041193107831	15	144
112941		Padlock with Key	1	675115112940	19	191
1138-1	1-1/4" x 6'	Brass Tubing - 17 Ga., Boxed	1	041193108456	15	143
1139-1	1-3/8" x 6'	Brass Tube - Budget (Cover 1" I.P.), Boxed	1	041193108463	15	143
1142-1	1-1/2" x 6'	Brass Tubing - 17 Ga., Boxed	1	041193108531	15	143
114A-1	1-1/2" x 16"	Center To Center, Slip Joint - 20 Ga.	5	041193108470	15	137
114B-1	1-1/2" x 21"	Center To Center, Slip Joint - 20 Ga.	5	041193108487	15	137
11536	1.25"	Galvanized ESM	25	038753115368	12	115
11549	1.5"	Galvanized ESM	25	038753115498	12	115
11552	2"	Galvanized ESM	25	038753115528	12	115
11565	2.5"	Galvanized ESM	25	038753115658	12	115
117A-1	1-1/2" x 16"	Center To Center, Slip Joint - 17 Ga.	5	041193050656	15	137
11795	1.5" - 3"	Galvanized All-Flash® 11" x 14.5" base	6	038753117954	12	115
11796	3" - 4"	Galvanized All-Flash® 12" x 15" base	6	038753117961	12	115
11830	.5" - 1"	Galvanized 9" x 12.5" base	12	038753118307	12	112
11831	.5" - 1"	Galvanized 18" x 18" base	12	038753118314	12	112
11832	.5" - 1"	Aluminum 9" x 12.5" base	12	038753118321	12	113
11833	.5" - 1"	Aluminum 18" x 18" base	12	038753118338	12	113
11840	1.25" - 1.5"	Galvanized 9" x 12.5" base	12	038753118406	12	112
11841	1.25" - 1.5"	Galvanized 9" x 12.5" base	6	038753118413	12	112
11853	2"	Galvanized 9" x 12.5" base	12	038753118536	12	112
11854	2"	Galvanized 9" x 12.5" base	6	038753118543	12	112
11859	.5" - 1"	Galvanized Black 11" x 14.5" base	12	038753118598	12	112
11866	3"	Galvanized 11" x 14.5" base	12	038753118666	12	112
11867	3"	Galvanized 11" x 14.5" base	6	038753118673	12	112
11871	1.5" - 3"	Galvanized All-Flash® 11" x 14.5" base	12	038753118710	12	115



Product No.	Size	Description	Ctn. Qty.	UPC	Category	Page Number
11872	1.5" – 3"	Galvanized Brown 11" x 14.5" base	12	038753118727	12	116
11873	1.5" – 3"	Galvanized Black 11" x 14.5" base	12	038753118734	12	116
11874	1.5" – 3"	Galvanized Gray 11" x 14.5" base	12	038753118741	12	116
11875	3" – 4"	Galvanized Brown 12" x 15" base	12	038753118758	12	116
11876	3" – 4"	Galvanized Black 12" x 15" base	12	038753118765	12	116
11877	3" – 4"	Galvanized All-Flash® 12" x 15" base	12	038753118772	12	115
11878	3" – 4"	Galvanized Gray 12" x 15" base	12	038753118789	12	116
11879	4"	Galvanized 12" x 15" base	12	038753118796	12	112
11860	4"	Galvanized 12" x 15" base	6	038753118602	12	112
11864	1.25" – 1.5"	Thermoplastic 12" x 18" base	12	038753118640	12	113
11867	1.25" – 1.5"	Thermoplastic 18" x 18" base	12	038753118671	12	113
11868	2"	Thermoplastic 18" x 18" base	12	038753118688	12	113
11869	3"	Thermoplastic 18" x 18" base	12	038753118695	12	113
11890	3"	Thermoplastic 11" x 15" base	6	038753118901	12	113
11891	4"	Thermoplastic 12" x 16" base	6	038753118918	12	113
11898	1.25" – 1.5"	Thermoplastic 9.25" x 13" base	6	038753118987	12	113
11899	2"	Thermoplastic 9.25" x 13" base	6	038753118994	12	113
11908	1.25" – 1.5"	Thermoplastic 9.25" x 13" base	12	038753119083	12	113
11909	2"	Thermoplastic 9.25" x 13" base	12	038753119090	12	113
11910	3"	Thermoplastic 11" x 15" base	12	038753119106	12	113
11911	4"	Thermoplastic 12" x 16" base	12	038753119113	12	113
11917	1.25" – 1.5"	Thermoplastic SW 11" x 15" base	12	038753119175	12	113
11918	2"	Thermoplastic SW 11" x 15" base	12	038753119182	12	113
11919	1.5" – 3"	Thermoplastic All-Flash® 11.25" x 15" base	12	038753119199	12	115
11920	3" – 4"	Thermoplastic All-Flash® 12" x 16" base	12	038753119205	12	115
11921	1.25" – 1.5"	Galvanized 18" x 18" base	12	038753119212	12	112
11923	1.25" – 1.5"	Galvanized 18" x 18" base	6	038753119236	12	112
11930	1.5" – 3"	All-Flash® High-Rise® 11" x 19" base	6	038753119304	12	115
11931	3" – 4"	All-Flash® High-Rise® 13" x 20" base	6	038753119311	12	115
11934	2"	Galvanized 18" x 18" base	12	038753119342	12	112
11936	2"	Galvanized 18" x 18" base	6	038753119366	12	112
11947	3"	Galvanized 18" x 18" base	12	038753119472	12	112
11950	4"	Galvanized 18" x 18" base	12	038753119502	12	112
11957	1.5" – 3"	Galvanized All-Flash® 18" x 18" base	12	038753119571	12	115
11958	3" – 4"	Galvanized All-Flash® 18" x 18" base	12	038753119588	12	115
11960	1.25" – 1.5"	Galvanized – 28 gauge 14" x 14" base	12	038753119601	12	112
11961	2"	Galvanized – 28 gauge 14" x 14" base	12	038753119618	12	112
11962	1.5" – 3"	Bent-Edge All-Flash® Galvanized 17" x 17" base	12	038753119625	12	115
11963	3" – 4"	Bent-Edge All-Flash® Galvanized 17" x 17" base	12	038753119632	12	115
11T		Same as Above w/ 4" Chrome Plated Tailpiece	24	041193055965	17	169
12		Medium Cup Basket Strainer, Stainless Steel Body and Basket, Medium Locking Cup, Neoprene Stopper, Bright Flange, Length 3-1/8" Fits Deep Cast Iron Sinks.	24	041193093653	17	167
121A-1	1-1/2" x 16"	Center To Center, Hi-Line - 20 Ga.	10	041193065438	15	137
121B-1	1-1/2" x 21"	Center To Center, Hi-Line - 20 Ga.	10	041193109163	15	137
1224	Gallon	PVC Medium Clear	6	083675012240	1	21
1226		2" Sink Hole Cover w/ 2-Piece Stainless Steel Head	12	041193050663	17	179
1227		1-3/4" Sink Hole Cover w/ 2-Piece Stainless Steel Head	24	041193109385	17	179
1228		1-3/4" Sink Hole Cover w/ 1-Piece Stainless Steel Head	24	041193109392	17	179



db Dearborn Brass.



Oatey

Product No.	Size	Description	Ctn. Qty.	UPC	Category	Page Number
1228E		1-3/4" Sink Hole Cover w/ 1-Piece Chrome Plated Steel Head	24	041193109408	17	177
122WS		Chrome Plated Brass Water Saving Shower Head	1	041193109248	17	178
1236S	32 oz.	PVC Medium Clear	12	083675012363	1	21
123A-1	1-1/2" x 16"	Center To Center, Hi-Line - 20 Ga.	5	041193109415	15	135
123B-1	1-1/2" x 21"	Center To Center, Hi-Line - 20 Ga.	5	041193109422	15	135
12403	1.5" – 3"	Copper No-Calk® 11" x 14.5" base	12	750405124039	12	113
12404	3" – 4"	Copper No-Calk® 11" x 14.5" base	12	750405124046	12	113
1246S	16 oz.	PVC Medium Clear	24	083675012462	1	21
1256		Strainer w/ 3 Prongs, 1-7/8"	25	041193050670	17	176
1256S	8 oz.	PVC Medium Clear	24	083675012561	1	21
1257		Strainer w/ 3 Prongs, 1-5/8"	25	041193050687	17	176
1266S	4 oz.	PVC Medium Clear	24	083675012660	1	21
1268		Shower Drain, Brass Body w/ 3-1/2" Grid, 2", Type M to Caulk	10	041193109644	17	176
126CWS		Chrome Plated Plastic Water Saving Shower Head w/ Plastic Ball Joint	6	041193006516	17	178
12801	1-1/2", 9-1/2" X 12-1/2"	Aurora™ Solar Flashing	12	038753128016	12	110
12802	1/2" - 1-1/2", 9-1/2" X 12-1/2"	Aurora™ Solar Flashing	12	038753128023	12	110
12805	1/2" – 2-1/2"	Sideflash Vertical Flashing	12	038753128054	12	110
12806	3" – 6"	Sideflash Vertical Flashing	12	038753128061	12	110
12836	1.25" – 1.5"	Soft Aluminum 18" x 18" base	12	038753128368	12	111
12849	2"	Soft Aluminum 18" x 18" base	12	038753128498	12	111
12852	3"	Soft Aluminum 18" x 18" base	12	038753128528	12	111
12865	4"	Soft Aluminum 18" x 18" base	12	038753128658	12	111
12920	1.25" – 1.5"	Aluminum 9" x 12.5" base	12	038753129204	12	111
12923	1.25" – 1.5"	Aluminum 9" x 12.5" base	6	038753129235	12	111
12933	2"	Aluminum 9" x 12.5" base	12	038753129334	12	111
12936	2"	Aluminum 9" x 12.5" base	6	038753129365	12	111
12942	1.5" – 3"	Aluminum Gray 11" x 14.5" base	12	038753129426	12	114
12943	1.5" – 3"	Aluminum Black 11" x 14.5" base	12	038753129433	12	114
12944	1.5" – 3"	Aluminum Brown 11" x 14.5" base	12	038753129440	12	114
12945	1.5" – 3"	Aluminum All-Flash® 11" x 14.5" base	12	038753129457	12	113
12946	3"	Aluminum 11" x 14.5" base	12	038753129464	12	111
12949	3"	Aluminum 11" x 14.5" base	6	038753129495	12	113
12953	3" – 4"	Aluminum Gray 12" x 15" base	12	038753129532	12	116
12954	3" – 4"	Aluminum Black 12" x 15" base	12	038753129549	12	116
12955	3" – 4"	Aluminum Brown 12" x 15" base	12	038753129556	12	116
12956	3" – 4"	Aluminum All-Flash® 12" x 15.5" base	12	038753129563	12	115
12958	4"	Aluminum 12" x 15" base	6	038753129587	12	113
12959	4"	Aluminum 12" x 15" base	12	038753129594	12	113
12974	1.5" – 3"	Aluminum All-Flash® 18" x 18" base	12	038753129747	12	115
12975	3" – 4"	Aluminum All-Flash® 18" x 18" base	12	038753129754	12	115
131A-1	1-1/2" x 16"	Center To Center, Hi-Line - 17 Ga.	10	041193109675	15	135
131ABN-3	1-1/2" x 16"	Center To Center, Hi-Line - 17 Ga. w/ Brass Nuts, Unfinished	10	041193013279	15	135
133A-1	1-1/2" x 16"	Center To Center, Hi-Line - 17 Ga.	5	041193050731	15	135
137-1	7"	Waste Arm w/ Slip Joint For 16" Center Outlet - 20 Ga.	10	041193109767	15	136
137-17BN-1	7"	Waste Arm w/ Slip Joint For 16" Center Outlet - 17 Ga. w/ Brass Nuts	10	041193019042	15	136



Product No.	Size	Description	Ctn. Qty.	UPC	Category	Page Number
137301	1 qt.	Cloroben PT-BIO1™	12	661000010415	6	61
137303	1 gal.	Cloroben PT-BIO1™	4	661000010422	6	61
137304	5 gal.	Cloroben PT-BIO1™ - Pail	1	661000010989	6	61
137307	15 gal.	Cloroben PT-BIO1™ - Drum	1	661000010439	6	61
137308	30 gal.	Cloroben PT-BIO1™ - Drum	1	661000010446	6	61
137309	55 gal.	Cloroben PT-BIO1™ - Drum	1	661000010453	6	61
137501	1 qt.	Cloroben PT-4™	12	661000010712	6	62
137503	1 gal.	Cloroben PT-4™	4	661000010729	6	62
137504	5 gal.	Cloroben PT-4™ - Pail	1	661000010972	6	62
137507	15 gal.	Cloroben PT-4™ - Drum	1	661000010743	6	62
137509	55 gal.	Cloroben PT-4™ - Drum	1	661000010767	6	62
137C-1	15"	Waste Arm w/ Slip Joint For 16" End Outlet - 20 Ga.	10	041193109811	15	136
137C-17-1	15"	Waste Arm w/ Slip Joint For 16" End Outlet - 17 Ga.	10	041193109798	15	136
137C-17BN-1	15"	Waste Arm w/ Slip Joint For 16" End Outlet - 17 Ga. w/ Brass Nuts	10	041193109804	15	136
137C-17BN-3	15"	Waste Arm w/ Slip Joint For 16" End Outlet - 17 Ga. w/ Brass Nuts, Unfinished	10	041193013156	15	136
137CBN-3	15"	Waste Arm w/ Slip Joint For 16" End Outlet - 20 Ga. w/ Brass Nuts, Unfinished	10	041193109842	15	136
137D-1	20"	Waste Arm w/ Slip Joint For 21" End Outlet - 20 Ga.	10	041193109859	15	136
137E-1	23"	Waste Arm w/ Slip Joint For 24" End Outlet - 20 Ga.	10	041193109897	15	136
137E-17-1	23"	Waste Arm w/ Slip Joint For 24" End Outlet - 17 Ga.	10	041193109873	15	136
137E-17BN-3	23"	Waste Arm w/ Slip Joint For 24" End Outlet - 17 Ga. w/ Brass Nuts, Unfinished	10	041193016324	15	136
137EBN-3	23"	Waste Arm w/ Slip Joint For 24" End Outlet - 20 Ga. w/ Brass Nuts, Unfinished	10	041193090966	15	136
138-1	7"	Waste Arm w/ Hi-Line For 16" Center Outlet - 20 Ga.	10	041193109910	15	136
138B-17-1	11"	Waste Arm w/ Hi-Line For 24" Center Outlet - 17 Ga.	10	041193013217	15	136
138C-1	15"	Waste Arm w/ Hi-Line For 16" End Outlet - 20 Ga.	10	041193109965	15	136
138C-17-1	15"	Waste Arm w/ Hi-Line For 16" End Outlet - 17 Ga.	10	041193109958	15	136
138D-1	20"	Waste Arm w/ Hi-Line For 21" End Outlet - 20 Ga.	10	041193109989	15	136
138E-17-1	23"	Waste Arm w/ Hi-Line For 24" End Outlet - 17 Ga.	10	041193109996	15	136
139302	1/2 gal.	Cloroben Septic-Flow™	6	661000020018	6	62
14		Shallow Cup Basket Strainer, Stainless Steel Body and Basket Shallow Locking Cup. Neoprene Stopper w/ Snap-In Basket w/ Bright. Flange. Length- 2-3/4". Fits Deep Cast Iron Sinks	24	041193006110	17	166
14009	1.25" – 1.5"	Flex-Flash™ 9" x 11" base	12	038753140094	12	112
14012	2"	Flex-Flash™ 9" x 11" base	12	038753140124	12	112
14025	2.5"	Flex-Flash™ 10" x 13.25" base	12	038753140254	12	112
14038	3"	Flex-Flash™ 10" x 13.25" base	12	038753140384	12	112
14041	4"	Flex-Flash™ 11.5" x 14" base	12	038753140414	12	112
14049	.25" – 4"	Retro Master Flash® 8" x 8" base	1	038753140490	12	114
14050	.25" – 2"	Master Flash® 4.5" x 4.5" base	6	038753140506	12	112
14051	1.25" – 3"	Master Flash® 6" x 6" base	6	038753140513	12	112
14052	.25" – 4"	Master Flash® 8" x 8" base	6	038753140520	12	112
14053	3" – 6"	Master Flash® 10" x 10" base	6	038753140537	12	112
14054	4" – 7"	Master Flash® 11" x 11" base	2	038753140544	12	112
14055	5" – 9"	Master Flash® 12" x 12" base	2	038753140551	12	112
14056	6" – 11"	Master Flash® 14" x 14" base	2	038753140568	12	112
14057	7" – 13"	Master Flash® 17" x 17" base	2	038753140575	12	112
14059	10" – 18"	Master Flash® 25" x 25" base	2	038753140599	12	112

NUMERICAL LISTING



Product No.	Size	Description	Ctn. Qty.	UPC	Category	Page Number
14122	1.25" – 1.5"	Collar	36	038753141220	12	114
14135	2"	Collar	24	038753141350	12	114
14136	1.5" – 3"	All Flash Collar	24	038753141367	12	114
14137	3" – 4"	All Flash Collar	24	038753141374	12	114
14193	3"	Collar	24	038753141930	12	114
14203	4"	Collar	12	038753142036	12	114
14205	1.25" – 1.5"	Collar – Carded	6	038753142050	12	114
14206	2"	Collar – Carded	6	038753142067	12	114
14207	3"	Collar – Carded	6	038753142074	12	114
14208	4"	Collar – Carded	6	038753142081	12	114
14209	2" x 3"	Mystic Rainwater Collection System – Display Box	4	038753142098	9	86
14722		Smoke Blower Replacement Fan (Left Pitch)	1		20	192
14751	.5" – 4"	Retro Master Flash® 8" x 8" base	10	750405147519	12	114
14752	4" – 9.25"	Retro Master Flash® 8" x 8" base	5	750405147526	12	114
14753	9.25" – 16.25"	Retro Master Flash® 8" x 8" base	5	750405147533	12	114
14T		Same as 14 w/ 4" Chrome Plated Tailpiece	24	041193102140	17	164
15		Snap-N-Tite Sink Basket Strainer, Stainless Steel Body and Basket. Locking Cup. Neoprene Stopper. Fits cast iron sinks. Length 3-3/4"	24	041193110091	17	164
15104	1/2" x 60"	TFE Pipe Joint Tape - Carded, Blister Pack	72	032628151048	2	35
15108	1/2" x 260"	TFE Pipe Joint Tape - Carded, Blister Pack	72	032628151086	2	35
15100	½"x1000"	Blue PTFE Tape	63		2	35
15110	¾"x 1000"	Blue PTFE Tape	45		2	35
15120	1"x1000"	Blue PTFE Tape	36		2	35
15111	1/4" x 200"	Tape Dope®	12	032628151116	2	35
15124	1/2" x 500"	Tape Dope®	24	032628151246	2	35
15127	1/2" x 750"	Tape Dope®	24	032628151277	2	35
15136	3/4" x 500"	Tape Dope®	12	032628151369	2	35
15162	1/2" x 260"	TFE Pipe Joint Tape	144	032628151628	2	35
15164	1/2" x 520"	TFE Pipe Joint Tape	144	032628151642	2	35
15169	1/2" x 1296"	TFE Pipe Joint Tape	36	032628151697	2	35
15176	3/4" x 520"	TFE Pipe Joint Tape	36	032628151765	2	35
15183	1" x 520"	TFE Pipe Joint Tape	36	032628151833	2	35
1524	Gallon	PVC Heavy Duty Clear	6	083675015241	1	21
153-1	1-1/2"	End Outlet Tee - 20 Ga. For Slip Joint End Outlet Waste	10	041193065414	15	136
15308	2 oz.	Pipe Joint Compound - Display, Plastic Tube (12 Trays)	144	032628153080	2	35
15308B	2 oz.	Pipe Joint Compound - Plastic Tube - Bulk Pk	144	032628153080	2	35
15311	1/4 pt.	Pipe Joint Compound	24	032628153110	2	35
15325	1/2 pt.	Pipe Joint Compound - Screw Cap With Brush	24	032628153257	2	35
15327	1 pt.	Pipe Joint Compound - Screw Cap With Brush	12	032628153271	2	35
15340	1 gal.	Pipe Joint Compound	4	032628153400	2	35
1536S	32 oz.	PVC Heavy Duty Clear	12	083675015364	1	21
15420	1/2 pt.	Pro Dope® - Screw Cap With Brush	24	032628154209	2	35
15427	1 pt.	Pro Dope® - Screw Cap With Brush	12	032628154278	2	35
15433	6 lb.	Pro Dope® - Plastic Pail With Handle	6	032628154339	2	35
15435	1 gal.	Pro Dope®	4	032628154353	2	35
15445	5 gal.	Pro Dope®	1	032628154452	2	35
1546S	16 oz.	PVC Heavy Duty Clear	24	083675015463	1	21
15510	1/4 pt.	Grrip™ - Industrial Black - Screw Cap With Brush	24	032628155107	2	36
15515	1/2 pt.	Grrip™ - Industrial Black - Screw Cap With Brush	24	032628155152	2	36



Product No.	Size	Description	Ctn. Qty.	UPC	Category	Page Number
15520	1 pt.	Grrip™ - Industrial Black - Screw Cap With Brush	12	032628155206	2	36
15525	1 qt.	Grrip™ - Industrial Black	12	032628155251	2	36
15550	1/4 pt.	Grrip™ Lite - Neutral Beige - Screw cap with brush	24		2	36
15555	1/2 pt.	Grrip™ Lite - Neutral Beige - Screw cap with brush	24		2	36
15560	1 pt.	Grrip™ Lite - Neutral Beige - Screw cap with brush	12		2	36
15565	1 qt.	Grrip™ Lite - Neutral Beige	12		2	36
15570	1 gal	Grrip™ Lite - Neutral Beige	4		2	36
1556S	8 oz.	PVC Heavy Duty Clear	24	083675015562	1	21
15605	2 oz.	Real Tuff™ - Display, Plastic Tube (4 Trays)	48	032628156050	2	36
15615	1/4 pt.	Real Tuff™ - Screw Cap With Brush	24	032628156159	2	36
15620	1/2 pt.	Real Tuff™ - Screw Cap With Brush	24	032628156203	2	36
15625	1 pt.	Real Tuff™ - Screw Cap With Brush	12	032628156258	2	36
15632	1 qt.	Real Tuff™ - Screw Cap With Brush	12	032628156326	2	36
15635	1 gal.	Real Tuff™	4	032628156357	2	36
15640	5 gal.	Real Tuff™	1	032628156401	2	36
1566S	4 oz.	PVC Heavy Duty Clear	24	083675015661	1	21
15703	1/4 pt.	Block™ - Screw Cap With Brush	24	032628157033	2	36
15707	1/2 pt.	Block™ - Screw Cap With Brush	24	032628157071	2	36
15711	1 pt.	Block™ - Screw Cap With Brush	12	032628157118	2	36
15716	1 qt.	Block™ - Screw Cap With Brush	12	032628157163	2	36
15802	1.1 fl oz.	Megaloc® - Display, Plastic Tube	24	032628158023	2	37
15804	1/4 pt.	Megaloc® - Screw Cap With Brush	24	032628158047	2	37
15806	1/2 pt.	Megaloc® - Screw Cap With Brush	24	032628158061	2	37
15808	1 pt.	Megaloc® - Screw Cap With Brush	12	032628158085	2	37
15811	1 qt.	Megaloc® - Screw Cap With Brush	12	032628158115	2	37
15814	1 gal.	Megaloc®	4	032628158146	2	37
15816	5 gal.	Megaloc®	1	032628158160	2	37
15818	55 gal.	Megaloc®	1	032628158184	2	37
15BN		Same as 15 w/ Brass Nuts. Neoprene Stopper with Brass Nuts. (Fits all cast iron)	24	041193011572	17	168
15T		Same as 15 w/ 4" Chrome Plated Tailpiece (Fits all cast iron)	24	041193085733	17	168
16		Sink Basket Strainer, Brass Body w/ Stainless Steel Basket. Heavy Locknut. Rubber Stopper. Length-3-3/4"	24	041193050816	17	169
1624	Gallon	PVC Medium Gray	6	083675016248	1	21
1636S	32 oz.	PVC Medium Gray	12	083675016361	1	21
163B-1	1-1/2"	Hi-Line Nipple Only	10	041193065421	15	138
1646S	16 oz.	PVC Medium Gray	24	083675016460	1	21
1656S	8 oz.	PVC Medium Gray	24	083675016569	1	21
1664SL-2	1-1/4"	45 Degree Cast Brass Solder Elbow	6	041193110206	15	144
1665SL-2	1-1/2"	45 Degree Cast Brass Solder Elbow	6	041193110213	15	144
1666S	4 oz.	PVC Medium Gray	24	083675016668	1	21
1667SL-2	1-1/2"	90 Degree Cast Brass Solder Elbow	6	041193110220	15	144
1674-2	1-1/4"	90 Degree Cast Brass Slip Joint Elbow	6	041193110237	15	144
1675-2	1-1/2"	90 Degree Cast Brass Slip Joint Elbow	6	041193110244	15	144
1679-2	1-1/2"	Cast Brass Slip Joint Tee	6	041193110251	15	144
16BN		Same as 16 w/ Brass Nuts	24	041193095411	17	169
16T		Same as 16 w/ 4" Chrome Plated Tailpiece	24	041193110145	17	169
17		Spin-N-Lock Sink Basket Strainer, Stainless Steel Body w/ Stainless Steel Screw-In Basket	24	041193050823	17	169
1724	Gallon	PVC Heavy Duty Gray – Wide Mouth Can	6	083675017245	1	22



db Dearborn Brass.



Oatey

Product No.	Size	Description	Ctn. Qty.	UPC	Category	Page Number
1736S	32 oz.	PVC Heavy Duty Gray	12	083675017368	1	22
1746S	16 oz.	PVC Heavy Duty Gray	24	083675017467	1	22
1756S	8 oz.	PVC Heavy Duty Gray	24	083675017566	1	22
17BN		Same as 17 w/ Brass Nuts	24	041193000149	17	169
17T		Same as 17 w/ 4" Chrome Plated Tailpiece	24	041193110275	17	169
18		Sink Basket Strainer, Stainless Steel Body and Basket. Deep Locking Cup. Neoprene Stopper. Length-3-3/4"	24	041193110329	17	168
1824	Gallon	Extra Heavy Duty Gray – Wide Mouth Can	6	083675018242	1	22
1836S	32 oz.	Extra Heavy Duty Gray	12	083675018365	1	22
18BN		Same as 18 w/ Brass Nuts	24	041193011596	17	166
18T		Same as 18 w/ 4" Chrome Plated Tailpiece	24	041193056023	17	166
20015	1 lb.	50/50 Wire Solder	10	038753200156	3	41
20019	1 lb.	50/50 Wire Solder	50	038753200194	3	41
20110	1 qt.	Wham®	12	032628201101	6	60
20115	1 gal.	Wham®	6	032628201156	6	60
20116	1 lb.	50/50 Acid Core Wire Solder	10	038753201160	3	41
20120	5 gal.	Wham®	1	032628201200	6	60
20130	55 gal.	Wham®	1	032628201309	6	60
202-1		Full Kit, Brass Tubular - 17 Ga. Chain & Stopper w/ Chrome Finish Trim w/ Chromed Pipes, Elbows & Tee	1	041193051141	16	155
202-3		Full Kit, Brass Tubular - 17 Ga. Chain & Stopper w/ Chrome Finish Trim		041193110688	16	155
20205	1 qt.	Clobber®	12	032628202054	6	60
20211	1/2 gal.	Clobber® - With Saf-T-Por Spout	6	032628202115	6	60
2024	Gallon	Plumb-Tite PVC Medium "Hot" Blue	6	083675020245	1	26
202C		Replacement Spray Head	12	041193007704	17	177
203-3		Full Kit, Brass Tubular - 17 Ga. Uni-Lift Stopper w/ Chrome Finish Trim For Whirlpool Tubs	1	041193110718	16	155
20305	1 qt.	Sizzle®	12	032628203051	6	60
20307	1-1/4 lb.	50% Tin / 50% Lead Bar	40	038753203072	3	42
20310	1 gal.	Sizzle® -With Saf-T-Por Spout	4	032628203105	6	60
2036S	32 oz.	Plumb-Tite PVC Medium "Hot" Blue	12	083675020368	1	26
20410	20 oz.	Glug® - Crystals	24	032628204102	6	61
20412	16 oz.	Glug® - Crystals	24	032628204126	6	61
20413	2 lb.	Glug® - Crystals	12	032628204133	6	61
20415	5 lb.	Glug® - Crystals	6	032628204157	6	61
20450	1 qt.	Glug® - Bath - Liquid	10	032628204508	6	61
20455	1/2 gal.	Glug® - Bath - Liquid	6	032628204553	6	61
2046S	16 oz.	Plumb-Tite PVC Medium "Hot" Blue	24	083675020467	1	26
20470	1 qt.	Glug® - Kitchen - Liquid	10	032628204706	6	61
20475	1/2 gal.	Glug® - Kitchen - Liquid	6	032628204751	6	61
20550	1 lb. (2-8oz. bags)	Root Force Foaming Root Destroyer	6	032628205505	6	61
2056S	8 oz.	Plumb-Tite PVC Medium "Hot" Blue	24	083675020566	1	26
20602	2 lb.	R-D™ - Root Destroyer	6	032628206021	6	61
20610	50 lb.	R-D™ - Root Destroyer	1	032628206106	6	61
2066S	4 oz.	Plumb-Tite PVC Medium "Hot" Blue	24	083675020665	1	26
20705	5 lb.	Hercules Septic Tank and Cesspool Cleaner	6		6	62
20715	25 lb.	Hercules Septic Tank and Cesspool Cleaner	1		6	62
208-3		Full Kit, Brass Tubular - 17 Ga. Chain & Stopper w/ Chrome Finish Trim 1-1/2" Outlet		041193051561	16	155
21018	1 lb.	40/60 Wire Solder	50	038753210186	3	41



Product No.	Size	Description	Ctn. Qty.	UPC	Category	Page Number
2108A-1	1-1/2" x 16"	Center To Center, Slip Joint - Budget Ga.	10	041193006073	15	135
21115	1 lb.	40/60 Acid Core Wire Solder	10	038753211152	3	41
2114A-1	1-1/2" x 16"	Center To Center, Slip Joint - Budget Ga.	5	041193006318	15	135
21212	1 lb.	40/60 Rosin Core	10	038753212128	3	42
2121A-1	1-1/2" x 16"	Center To Center, Hi-Line - Budget Ga.	10	041193006066	15	136
2123A-1	1-1/2" x 16"	Center To Center, Hi-Line - Budget Ga.	5	041193006295	15	136
21305	1-1/4 lb.	50% Tin / 50% Lead Bar	10	038753213057	3	42
2137-1	7"	Waste Arm w/ Slip Joint For 16" Center Outlet - Budget Ga.	10	041193051806	15	136
2137B-1	11"	Waste Arm w/ Slip Joint For 24" Center Outlet - Budget Ga.	10	041193050144	15	136
2137C-1	15"	Waste Arm w/ Slip Joint For 16" Center Outlet - Budget Ga.	10	041193006080	15	136
2138-1	7"	Waste Arm w/ Hi-Line For 16" Center Outlet - Budget Ga.	10	041193110855	15	136
2138C-1	15"	Waste Arm w/ Hi-Line For 16" End Outlet - Budget Ga.	10	041193006103	15	136
21603	1-1/4"	P-Trap - 17 Ga. w/ Deep Flange, Polished Brass	2	041193089366	15	131
21604	1-1/4"	P-Trap - 17 Ga. w/ Box Flange, Polished Brass	2	041193090300	15	129
2178A-1	1-1/2" x 16"	Center To Center, Slip Joint w/ Baffle Tee - Budget Ga.	10	041193111029	15	135
2179A-1	1-1/2" x 16"	Center To Center, Hi-Line w/ Baffle Tee - Budget Ga.	10	041193052018	15	135
2185-1	1-1/2"	Baffle Tee - 20 Ga. For Slip Joint End Outlet Waste	10	041193065445	15	136
2185-17-1	1-1/2"	Baffle Tee - 17 Ga. For Slip Joint End Outlet Waste	10	041193111036	15	136
2186-1	1-1/2"	Baffle Tee - 20 Ga. For Center Outlet Waste	10	041193111043	15	136
22004	1/2 lb.	95/5 Wire Solder	10	038753220048	3	40
22017	1 lb.	95/5 Wire Solder	25	038753220178	3	40
22018	1 lb.	95/5 Wire Solder	10	038753220185	3	40
22025	200g.	95/5 Wire Solder	10	038753220253	3	40
22027	200 g.	Silver Lead Free Wire Solder	10	038753220277	3	39
222031	1 lb.	Cloroben Bacta-Life®	12	661000010323	6	62
2224	Gallon	PVC Regular Clear	6	083675022249	1	22
2236S	32 oz.	PVC Regular Clear	12	083675022362	1	22
2246S	16 oz.	PVC Regular Clear	24	083675022461	1	22
2256S	8 oz.	PVC Regular Clear	24	083675022560	1	22
226-3		Full Kit, Brass Tubular - 17 Ga. Trip Lever Stopper w/ Chrome Finish Trim	1	041193042484	16	155
2266S	4 oz.	PVC Regular Clear	24	083675022669	1	22
227-3		Full Kit, Brass Tubular - 17 Ga. Uni-Lift Stopper w/ Chrome Finish Trim	1	041193111272	16	155
227C-3		Full Kit, Brass Tubular - 17 Ga. Uni-Lift Stopper w/ Chrome Finish Trim Condensate Elbow	1	041193111289	16	155
227D-3		Full Kit, Brass Tubular - 17 Ga. Uni-Lift Stopper w/ Chrome Finish Drain Direct Drain	1	041193111296	16	156
227S-3		Full Kit, Brass Tubular - 17 Ga. Uni-Lift Stopper w/ Chrome Finish Drain Side Drain	1	041193026743	16	156
228-3		Full Kit, Brass Tubular - 17 Ga. Touch Toe Stopper w/ Chrome Finish Trim	1	041193052131	16	155
230-3		Full Kit, Brass Tubular - 17 Ga. Trip Lever Stopper w/ Chrome Finish Trim For Whirlpool Tubs	1	041193111418	16	155
23000	1/2 lb.	Silver Lead Free Wire Solder	10	038753230009	3	39
23001	1 lb.	Silver Lead Free Wire Solder	25	038753230016	3	39
23002	5 lb.	Silver Lead Free Wire Solder	10	038753230023	3	39
23030		Bar Sink Strainer w/ Crumb Cup. Length 2-1/8", Polished Brass	1	041193111463	17	169

NUMERICAL LISTING



Product No.	Size	Description	Ctn. Qty.	UPC	Category	Page Number
2324	Gallon	Pool-Tite PVC Medium "Hot" Blue	6	083675023246	1	26
2336S	32 oz.	Pool-Tite PVC Medium "Hot" Blue	12	083675023369	1	26
2346S	16 oz.	Pool-Tite PVC Medium "Hot" Blue	24	083675023468	1	26
235-3		Full Kit, Brass Tubular - 17 Ga. Uni-Lift Stopper w/ Chrome Finish Trim 2 Hole Faceplate, Chicago Code Thru Wall	1	041193021779	16	155
2356S	8 oz.	Pool-Tite PVC Medium "Hot" Blue	24	083675023567	1	26
2366S	4 oz.	Pool-Tite PVC Medium "Hot" Blue	24	083675023666	1	26
240018	1-1/4"-1-1/2"	Test-Ball® Plug	24	675115240018	18	180
240028	2"	Test-Ball® Plug	24	675115240025	18	180
240038	3"	Test-Ball® Plug	24	675115240032	18	180
240048	4"	Test-Ball® Plug	24	675115240049	18	180
2401A-1	1-1/4"	Wall Tube 9.5" - Budget Ga.	25	041193071231	15	134
2402A-1	1-1/2"	Wall Tube 11.25" - Budget Ga.	10	041193084842	15	134
2403E		27" Stainless Steel Fit-All Hexagon Lug Lavatory Legs w/ Escutcheons for China Fixtures (one pair)	1	041193049865	17	177
2424	Gallon	Turf-Tite PVC Medium "Hot" Blue	6	083675024243	1	27
24336S	32 oz.	Spa-Tite PVC Heavy Duty Clear	12	083675243224	1	28
2436S	32 oz.	Turf-Tite PVC Medium "Hot" Blue	12	083675024366	1	27
24436S	32 oz.	Spa-Tite PVC Heavy Duty Blue	12	083675244320	1	28
2446S	16 oz.	Turf-Tite PVC Medium "Hot" Blue	24	083675024465	1	27
2456S	8 oz.	Turf-Tite PVC Medium "Hot" Blue	24	083675024564	1	27
2466S	4 oz.	Turf-Tite PVC Medium "Hot" Blue	24	083675024663	1	27
25101	14 oz.	Sta Put®	24	032628251014	4	51
25103	3 lb.	Sta Put®	12	032628251038	4	51
25105	5 lb.	Sta Put®	6	032628251052	4	51
25110	7 lb.	Sta Put® - Plastic Pail With Handle	6	032628251106	4	51
25120	20 lb.	Sta Put® - Plastic Pail With Handle	2	032628251205	4	51
25171	14 oz.	Sta Put® Ultra	12	032628251717	4	51
252034	9 lb.	Cloroben Aid-Ox®	4	661000010347	6	62
25215	10.3 oz.	Plastic Seal™ - Cartridge	12	032628252158	4	51
25403	10.3 oz.	Roof & Flashing Sealant - Cartridge	12	032628254039	4	52
25405	1 qt.	Roof & Flashing Sealant	12	032628254053	4	52
25410	1 gal.	Roof & Flashing Sealant	6	032628254107	4	52
25415	5 gal.	Roof & Flashing Sealant	1	032628254152	4	52
25515	4 oz.	Pro Poxo® 20 - Display Pack (2 - 1 Dz.)	24	032628255159	4	52
25527	4 oz.	Pro Poxo Triple Play Putty Display Pack	24	032628255272	4	52
25531	4 oz.	Plastic Poxo™ - Display Pack (2 - 1 Dz.)	24	032628255319	4	52
25605	6 fl oz.	Plumbers Caulk™ - White - Tube Display	24	032628256057	4	52
25615	11 fl oz.	Plumbers Caulk™ - White - Cartridge	12	032628256156	4	52
25620	5.5 fl oz.	Plumbers Caulk™ - Clear - Tube Display	24	032628256200	4	52
25625	10.3 fl oz.	Plumbers Caulk™ - Clear - Cartridge	12	032628256255	4	52
25631	5.5 fl oz.	Plumbers Caulk™ - Almond/Bone - Tube Display	24	032628256316	4	52
25636	10.3 fl oz.	Plumbers Caulk™ - Almond/Bone - Cartridge	12	032628256361	4	52
25641	6 fl. oz.	Plumbers Caulk™ - Biscuit/Linen - Tube Display	24	032628256415	4	52
25641R	6 fl. oz.	Plumbers Caulk™ - Linen - Tube Display	24	032628256415	4	52
25646	10 fl. oz.	Plumbers Caulk™ - Biscuit/Linen - Cartridge	12	032628256460	4	52
2565		1/2" x 21-1/2" Offset Bath Supply w/Nuts, Washers & Floor Flange (pair)	1	041193052285	17	178
2566		9/16" x 2-1/2" Offset Bath Supply w/Nuts Washers & Floor Flange (pair)	1	041193112002	17	178



Product No.	Size	Description	Ctn. Qty.	UPC	Category	Page Number
25666	10.1 fl. oz.	High Temp Red – Cartridge	12	032628256668	4	53
25676	11 oz.	Plumbers Caulk - Silicone™ - White - Cartridge	12	032628256767	4	53
25686	11 oz.	Plumbers Caulk - Silicone™ - Clear - Cartridge	12	032628256866	4	53
25696	10 oz.	Plumbers Firestop Sealant™ - Cartridge	12	032628256965	4	53
25698	5 gal.	Plumbers Firestop Sealant™ - Pail	1	032628256989	4	53
261084		20' Hose With Poly Lift Line, 3/16" ID	1	675115261082	20	194
261106		30' Hose With Poly Lift Line, 3/16" ID	1	675115261105	20	194
261114		40' Hose With Poly Lift Line, 3/16" ID	1	675115261112	20	194
261398		20' Hose With Poly Lift Line And Gauge, Dump Valve, 3/8" ID	1	675115261396	20	194
261408		30' Hose With Poly Lift Line And Gauge, Dump Valve, 3/8" ID	1	675115261402	20	194
261418		40' Hose With Poly Lift Line And Gauge, Dump Valve, 3/8" ID	1	675115261419	20	194
262008	1-1/2"	Muni-Ball® Plug 1/8" Bypass	1	675115262003	18	183
262008	1-1/2"	Muni-Ball® Plug 1/8" Bypass	1	675115262003	18	184
262010	2"	Muni-Ball® Plug 1/8" Bypass	1	675115262010	18	183
262021	3"	Muni-Ball® Plug 3/4" Bypass	1	675115262027	18	183
262048	4"	Muni-Ball® Plug 3/4" Bypass	1	675115262041	18	185
262064	6"	Muni-Ball® Plug 1-1/2" Bypass	1	675115262065	18	183
262080	8"	Muni-Ball® Plug 3" Bypass	1	675115262089	18	183
262110	10"	Muni-Ball® Plug 3" Bypass	1	675115262119	18	183
262129	12"	Muni-Ball® Plug 3" Bypass	1	675115262126	18	183
262137	15"-16"	Muni-Ball® Plug 3" Bypass	1	675115262133	18	183
262186	18"	Muni-Ball® Plug 4" Bypass	1	675115262186	18	183
262218	21"	Muni-Ball® Plug 4" Bypass	1	675115262218	18	185
262242	24"	Muni-Ball® Plug 4" Bypass	1	675115262249	18	183
2624	Gallon	Polar-Weld PVC All Weather	6	083675026247	1	23
2636S	32 oz.	Polar-Weld PVC All Weather	12	083675026360	1	23
2646S	16 oz.	Polar-Weld PVC All Weather	24	083675026469	1	23
2650-1	1-1/4"	J-Bend - Budget Ga.	10	041193006127	15	133
265048	4" - 6"	Muni-Ball® Plug 3/4" Bypass	1	675115265042	18	184
265068	6" - 8"	Muni-Ball® Plug 1-1/2" Bypass	1	675115265066	18	184
265078	8" - 10"	Muni-Ball® Plug 2" Bypass	1	675115265073	18	184
265098	8" - 12"	Muni-Ball® Plug 2" Bypass	1	675115265097	18	184
2651-1	1-1/2"	J-Bend - Budget Ga.	10	041193050113	15	133
265128	12" - 18"	Muni-Ball® Plug 4" Bypass	1	675115265127	18	184
2654W-1	1-1/2"	Sink J-Bend w/ Washer Joint - Budget Ga.	10	041193011770	15	133
2656S	8 oz.	Polar-Weld PVC All Weather	24	083675026568	1	23
2666S	4 oz.	Polar-Weld PVC All Weather	24	083675026667	1	23
269832	0.39"	Kwik 'n Sure® Plug	10	675115269835	19	186
269840	1/2"	Kwik 'n Sure® Plug	10	675115269842	19	186
269867	3/4"	Kwik 'n Sure® Plug	10	675115269866	19	186
269875	1"	Kwik 'n Sure® Plug	10	675115269873	19	186
269883	1-1/4"	Kwik 'n Sure® Plug	10	675115269880	19	186
269891	1-1/2"	Kwik 'n Sure® Plug	10	675115269897	19	186
269905	2"	Kwik 'n Sure® Plug	5	675115269903	19	186
269913	2-1/2"	Kwik 'n Sure® Plug	5	675115269910	19	186
269921	3"	Kwik 'n Sure® Plug	5	675115269927	19	186
269948	4"	Kwik 'n Sure® Plug	5	675115269941	19	186

NUMERICAL LISTING

db Dearborn
Brass.

Oatey®

Product No.	Size	Description	Ctn. Qty.	UPC	Category	Page Number
269956	5"	Kwik 'n Sure® Plug	5	675115269958	19	188
2700-1	1-1/4"	P-Trap - Budget Ga.	25	041193005892	15	131
270008	3/4"-1-1/4"	Test-Ball® Plug	6	675115270008	18	181
270016	1-1/4"-1-1/2"	Test-Ball® Plug	6	675115270015	18	181
270024	2"	Test-Ball® Plug	6	675115270022	18	181
270032	3"	Test-Ball® Plug	6	675115270039	18	181
270040	4"	Test-Ball® Plug	6	675115270046	18	181
270059	5"	Test-Ball® Plug	6	675115270053	18	181
270067	6"	Test-Ball® Plug	6	675115270060	18	181
2700A-1	1-1/4"	P-Trap - Budget Ga. w/ 9.50" Wall Tube	25	041193102003	15	131
2700DF-1	1-1/4"	P-Trap - Budget Ga. w/ Deep Flange	25	041193102133	15	131
270108	2-1/2"	Test-Ball® Plug	6	675115270107	18	181
270138	3-1/2"	Plug Seals 4" Threaded Opening	10	675115270138	19	186
270168	2"	Plug Seals 2-1/2" Threaded Opening	10	675115270169	19	186
270178	3"	Plug Seals 3-1/2" Threaded Opening	10	675115270176	19	186
270186	4"	Plug Seals 4-1/2" Threaded Opening	10	675115270183	19	186
2702-1	1-1/2"	P-Trap - Budget Ga.	25	041193005908	15	131
270210	1-1/2"	End of Pipe Gripper® Plug	10	675115270213	19	186
270229	2"	End of Pipe Gripper® Plug	10	675115270220	19	186
270237	3"	End of Pipe Gripper® Plug	10	675115270237	19	186
270245	4"	End of Pipe Gripper® Plug	10	675115270244	19	186
270253	6"	Inside of Pipe Gripper® Plug	5	675115270251	19	186
270261	6"	End of Pipe Gripper® Plug	5	675115270268	19	186
270270	8"	End of Pipe Gripper® Plug	1	675115270275	19	186
270288	8"	Inside of Pipe Gripper® Plug	1	675115270282	19	186
270296	4"	Inside of Pipe Gripper® Plug	10	675115270299	19	186
2702DF-1	1-1/2"	P-Trap - Budget Ga. w/ Deep Flange	25	041193084965	15	131
270528	2"	Hub-Fit Gripper® Plug	10	675115270527	19	186
270538	3"	Hub-Fit Gripper® Plug	10	675115270534	19	186
270548	4"	Hub-Fit Gripper® Plug	10	675115270541	19	186
270725	1-1/2"	Test-Kap® Plug	10		23	233
270733	2"	Test-Kap® Plug	10		23	233
270741	3"	Test-Kap® Plug	10		23	233
270768	4"	Test-Kap® Plug	10		23	233
270776	5"	Test-Kap® Plug	5		23	233
270784	6"	Test-Kap® Plug	5		23	233
271020	2"	Long Test-Ball® Plug	1	675115271029	18	183
271039	3"	Long Test-Ball® Plug	1	675115271036	18	183
271047	4"	Long Test-Ball® Plug	1	675115271043	18	183
271055	5"	Long Test-Ball® Plug	1	675115271050	18	183
271063	6"	Long Test-Ball® Plug	1	675115271067	18	183
271098	4"- 6"	Long Test-Ball® Plug	1	675115271098	18	183
271131	1 lb.	Cloroben Open Wide®	12	661000010361	6	62
271158	1-1/2"	Sure-Grip® Plug	10	675115271159	19	188
271208	2"	Sure-Grip® Plug	10	675115271203	19	188
271308	3"	Sure-Grip® Plug	10	675115271302	19	188
271408	4"	Sure-Grip® Plug	10	675115271401	19	188
271508	1-1/2"	Clean-Seal® Plug	6	675115271500	18	183
271519	1-1/2"	Econ-O-Grip® Plug	10	675115271517	19	187



Product No.	Size	Description	Ctn. Qty.	UPC	Category	Page Number
271527	2"	Econ-O-Grip® Plug	10	675115271524	19	187
271535	3"	Econ-O-Grip® Plug	10	675115271531	19	187
271543	4"	Econ-O-Grip® Plug	10	675115271548	19	187
271551	5"	Econ-O-Grip® Plug	5	675115271555	19	187
271578	6"	Econ-O-Grip® Plug	5	675115271579	19	187
271648	1"-1-1/4"	Monitor Well™ Locking Plug	12	675115271647	19	189
271669	3"	Monitor Well™ Locking Plug	75	675115271661	19	189
271675	2"	Monitor Well™ Locking Plug	50	675115271678	19	189
271683	4"	Monitor Well™ Locking Plug	25	675115271685	19	189
271691	6"	Monitor Well™ Locking Plug	8	675115271692	19	189
271705	2"	Clean-Seal® Plug	6	675115271708	18	183
271713	3"	Clean-Seal® Plug	6	675115271715	18	183
271721	4"	Clean-Seal® Plug	6	675115271722	18	183
271735	8"	Monitor Well™ Locking Plug	1	675115271739	19	189
271758	6"	Clean-Seal® Plug	1	675115271753	18	183
2718-1	1-1/4"	S-Trap - Budget Ga.	5	041193005915	15	134
2720-1	1-1/2"	S-Trap - Budget Ga.	5	041193005922	15	134
272888	18"	Gripper® Plug (Non By-Pass)*	1	675115272880	19	187
272892	6"	Gripper® Plug (Non By-Pass)	1	675115272897	19	187
272906	8"	Gripper® Plug (Non By-Pass)	1	675115272903	19	187
272914	10"	Gripper® Plug (Non By-Pass)	1	675115272910	19	187
272922	12"	Gripper® Plug (Non By-Pass)	1	675115272927	19	187
272930	15"	Gripper® Plug (Non By-Pass)*	1	675115272934	19	187
272949	6"	Gripper® Plug 1/4" Bypass	1	675115272941	19	187
272957	8"	Gripper® Plug 3/4" Bypass	1	675115272958	19	187
272965	10"	Gripper® Plug 3/4" Bypass	1	675115272965	19	187
272973	12"	Gripper® Plug 3/4" Bypass	1	675115272972	19	187
272981	15"	Gripper® Plug 3/4" Bypass*	1	675115272989	19	187
272998	18"	Gripper® Plug 3/4" Bypass*	1	675115272996	19	187
273318	1-1/2"	Stainless Steel Econ-O-Grip® Plug	2	675115273313	19	188
273328	2"	Stainless Steel Econ-O-Grip® Plug	2	675115273320	19	188
273338	3"	Stainless Steel Econ-O-Grip® Plug	2	675115273337	19	188
273348	4"	Stainless Steel Econ-O-Grip® Plug	2	675115273344	19	188
273358	5"	Stainless Steel Econ-O-Grip® Plug	1	675115273351	19	188
273368	6"	Stainless Steel Econ-O-Grip® Plug	1	675115273368	19	188
2736S	32 oz.	Multi-Tite PVC Medium "Hot" Blue	12	083675027367	1	27
273888		Econ-O-Pump™ Test Pump	1	675115273887	20	189
273958		Air-Max® Test Pump	1	675115273955	20	189
273968		Air-Max® Pro HV Test Pump	1	675115273962	20	189
274008		2' Hose, 3/16" ID Bagged Bulk Pak	24	675115274006	20	194
274011		2' Hose, 3/16" ID	6	675115274013	20	194
274018		3' Hose, 3/16" ID Bagged Bulk Pak	24	675115274013	20	194
274038		3' Hose, 3/16" ID	6	675115274037	20	194
274054		5' Hose, 3/16" ID	6	675115274051	20	194
274100		10' Hose, 3/16" ID	1	675115274105	20	194
274208		20' Hose, 3/16" ID	1	675115274204	20	194
274218		5' Hose With Gauge 3/16" ID	1	675115274211	20	193
274228		10' Hose With Gauge 3/16" ID	1	675115274228	20	193
274238		20' Hose With Gauge 3/16" ID	1	675115274235	20	193

NUMERICAL LISTING



Product No.	Size	Description	Ctn. Qty.	UPC	Category	Page Number
274518	2" - 3"	MS2® Plug	1	675115274518	18	183
274526	3" - 4"	MS2® Plug	1	675115274525	18	183
274534	4" - 6"	MS2® Plug	1	675115274532	18	183
2746S	16 oz.	Multi-Tite PVC Medium "Hot" Blue	24	083675027466	1	27
275048	4" - 6"	Test-Ball® Plug	1	675115275041	18	182
275058	6" - 8"	Test-Ball® Plug	1	675115275058	18	182
275088	8" - 12"	Test-Ball® Plug	1	675115275089	18	182
275128	12" - 18"	Test-Ball® Plug	1	675115275126	18	182
2756S	8 oz.	Multi-Tite PVC Medium "Hot" Blue	24	083675027565	1	27
276128	1-1/4"-2"	Test-Ball® Plug	6	675115276123	18	182
276238	2" - 3"	Test-Ball® Plug	6	675115276239	18	182
2763-1	1-1/4" x 5"	Patent Overflow Plug Ind. Boxed 1 Pc. - 20 Ga.	10	041193006035	15	141
276348	3" - 4"	Test-Ball® Plug	6	675115276345	18	182
276468	4" - 6"	Test-Ball® Plug	6	675115276468	18	182
2764A-1	1-1/4" x 8"	Patent Overflow Plug Ind. Boxed 1 Pc. - 20 Ga.	10	041193071262	15	141
2765-1	1-1/4" x 12"	Patent Overflow Plug Ind. Boxed 1 Pc. - 20 Ga.	10	041193103642	15	141
2766S	4 oz.	Multi-Tite PVC Medium "Hot" Blue	24	083675027664	1	27
2824	Gallon	PVC Regular Clear Fast Set	6	083675028241	1	23
2836S	32 oz.	PVC Regular Clear Fast Set	12	083675028364	1	23
2846S	16 oz.	PVC Regular Clear Fast Set	24	083675028463	1	23
2856S	8 oz.	PVC Regular Clear Fast Set	24	083675028562	1	23
2866S	4 oz.	PVC Regular Clear Fast Set	24	083675028661	1	23
29024	1/2 lb.	Safe-Flo Silver Wire Solder	10	038753290249	3	39
29024D	1/2 lb.	Safe-Flo Silver Wire Solder	24	038753290249	3	39
29025	1 lb.	Safe-Flo Silver Wire Solder	10	038753290256	3	39
29025D	1 lb.	Safe-Flo Silver Wire Solder	20	038753290256	3	39
29030	1 oz.	Safe-Flo Silver Wire Solder	20	038753290300	3	39
29031	1 oz.	95/5 Rosin Core Wire Solder	20	038753290317	3	40
29032	1 oz.	40/60 Acid Core Wire Solder	20	038753290324	3	41
29033	1 oz.	40/60 Rosin Core	20	038753290331	3	42
2936S	32 oz.	Pool-Clear PVC Medium Clear	12	083675029361	1	27
2946S	16 oz.	Pool-Clear PVC Medium Clear	24	083675029460	1	27
30011	1.7 oz.	No. 5 Flux	12	038753300115	3	43
30013	4 oz.	No. 5 Flux	24	038753300139	3	43
30014	8 oz.	No. 5 Flux	24	038753300146	3	43
3003		Strainer Locknut Wrench w/Hinged Jaw	6	041193052315	17	171
30038	8 oz.	No. 5 Flux	24	038753300382	3	43
30041	16 oz.	No. 5 Flux	12	038753300412	3	43
30041D	16 oz.	No. 5 Flux – Display	12	038753300412	3	43
30062	16 oz.	No. 5 Paste Flux – Hot Weather	12	038753300627	3	44
3010		Large Jaw Basin Wrench w/ 15" Handle	1	041193052353	17	171
30106	4 oz.	No. 11 Liquid Flux	12	038753301068	3	44
301005		Automatic Dispenser	1		6	62
301050		AC Power Adaptor	1		6	62
30115	1 qt.	Stop Leak	12	032628301153	7	65
30120	1 gal.	Stop Leak	6	032628301207	7	65
30125	5 gal.	Stop Leak	1	032628301252	7	65
30130	1.7 oz.	H-205 Water Soluble Paste Flux	12	038753301303	3	43
30131	4 oz.	H-205 Water Soluble Paste Flux	24	038753301310	3	43



Product No.	Size	Description	Ctn. Qty.	UPC	Category	Page Number
30132	8 oz.	H-205 Water Soluble Paste Flux	24	038753301327	3	43
30133	16 oz.	H-205 Water Soluble Paste Flux	12	038753301334	3	43
30140	1.7 oz.	H-2095 Water Soluble Tinning Flux	12	038753301402	3	43
30142	8 oz.	H-2095 Water Soluble Tinning Flux	24	038753301426	3	43
30143	16 oz.	H-2095 Water Soluble Tinning Flux	12	038753301433	3	43
30200	16 oz.	Clear Cutting Oil (Hand Threading)	12	038753302003	5	56
30201	32 oz.	Clear Cutting Oil (Hand Threading)	12	038753302010	5	56
30202	Gallon	Clear Cutting Oil (Hand Threading)	6	038753302027	5	56
30203	16 oz.	Dark Cutting Oil (Speed Threading)	12	038753302034	5	56
30204	32 oz.	Dark Cutting Oil (Speed Threading)	12	038753302041	5	56
30205	Gallon	Dark Cutting Oil (Speed Threading)	6	038753302058	5	56
30206	1 gal.	Stop Leak	6	032628302068	7	65
30209	8 oz.	All Purpose Leak Detector With Dauber	12	038753302096	2	34
30211	16 oz.	All Purpose Leak Detector With Trigger Spray	12	038753302119	2	34
30212	Gallon	All Purpose Leak Detector	4	038753302126	2	34
30213	12 oz.	Stop Leak	12	032628302013	7	65
30213R	12 oz.	Stop Leak - 6 Pack	6	032628302013	7	65
30214	5 gal.	Stop Leak	1	032628302112	7	65
30235	6 oz.	Tub-N-Tile Clear Sealant - Tube	12	038753302355	4	50
30236	10.3 oz.	Silicone Sealant, Clear - Cartridge	12	038753302362	4	51
30237	10.3 oz.	Silicone Sealant, White - Cartridge	12	038753302379	4	51
3024	Gallon	Well-Tite PVC Medium "Hot" Blue	6	083675302419	1	28
30240	6 oz.	Tub-N-Tile Caulk - Tube	24	038753302409	4	50
30241	10 oz.	Tub-N-Tile Caulk - Cartridge	24	038753302416	4	50
302443	8 oz.	PVC Medium & NSF Purple Primer	20	038753302447	1	16
30246	4 oz.	PVC Regular & NSF Purple Primer	12	038753302461	1	16
30246D	4 oz.	PVC Medium & NSF Purple Primer - Display Pack	24	038753302461	1	16
302483	8 oz.	PVC Regular & NSF Purple Primer - Display Pack	20	038753302485	1	16
3030		1" - 4" Spud Wrench for Removal or Installation of Closet Spuds, Sink Strainers, P.O Plugs, Waste & Overflow	10	041193052407	17	171
303008		Smoke Fluid Smoke Blower Kit: Briggs & Stratton Engine	1	675115303003	20	192
303018		Smoke Fluid Smoke Blower Kit: Honda Engine	1	675115303010	20	192
30310	1 lb.	Stop Leak	12	032628303102	7	65
303127	1"-2"	Clog-Buster® Drain Flusher	1	675115303126	20	192
303135	1-1/2"-3"	Clog-Buster® Drain Flusher	1	675115303133	20	192
303143	4"- 6"	Clog-Buster® Drain Flusher	1	675115303140	20	192
3032		Tub Waste Wrench - Fits 1-1/2" and 1-1/4" Sizes	1	041193071484	17	171
30320	200 lb.	Stop Leak	1		7	65
303550		Smoke Bomb Smoke Blower Kit: Briggs & Stratton Engine	1	675115303553	20	192
3036S	32 oz.	Well-Tite PVC Medium "Hot" Blue	12	083675303621	1	28
30372	8 oz.	No. 95 Tinning Flux - Lead Free	24	038753303727	3	43
30372D	8 oz.	No. 95 Tinning Flux - Lead Free - Display	24	038753303727	3	43
30373	1.7 oz.	No. 95 Tinning Flux - Lead Free - Carded	12	038753303734	3	43
30374	1.7 oz.	No. 95 Tinning Flux - Lead Free	12	038753303741	3	43
30374D	1.7 oz.	No. 95 Tinning Flux - Lead Free - Display	48	038753303741	3	43
30375	16 oz.	No. 95 Tinning Flux - Lead Free	12	038753303758	3	43
3040G		2" Heavy Duty Pliers with Vinyl Grips	1	041193112026	17	171
3046S	16 oz.	Well-Tite PVC Medium "Hot" Blue	24	083675304635	1	28
30599	16 oz.	Pipe Lubricant	24	038753305998	5	56
30600	32 oz.	Pipe Lubricant	12	038753306001	5	56



Product No.	Size	Description	Ctn. Qty.	UPC	Category	Page Number
30601	Gallon	Pipe Lubricant	4	038753306018	5	56
30602	3.5 Gallon	Pipe Lubricant	1	038753306025	5	56
30614	16 oz.	Pipe Seal	12	038753306148	4	50
3068		Socket Wrench Set with 5 Socket Wrenches	1	041193052421	17	171
30710	1/2"	Acid Brush – Carded	12	038753307107	3	44
30711	1/2"	Acid Brush – Bulk (per gross)	1	038753307114	3	44
30712	1/2"	Acid Brush – with Barcode	144	038753307121	3	44
30750	4 oz.	Clear Primer	24	038753307503	1	15
30751	8 oz.	Clear Primer	24	038753307510	1	15
30752	16 oz.	Clear Primer	24	038753307527	1	15
30753	32 oz.	Clear Primer	12	038753307534	1	15
30754	Gallon	Clear Primer	6	038753307541	1	15
30755	4 oz.	Purple Primer	24	038753307558	1	15
307553	4 oz.	Purple Primer – Display Pack	48	038753307558	1	15
30756	8 oz.	Purple Primer	24	038753307565	1	15
307563	8 oz.	Purple Primer – Display Pack	36		1	15
30757	16 oz.	Purple Primer	24	038753307572	1	15
307573	16 oz.	Purple Primer – Display Pack	10	038753307572	1	15
30758	32 oz.	Purple Primer	12	038753307589	1	15
307583	32 oz.	Purple Primer – Display Pack	6	038753307589	1	15
30759	Gallon	Purple Primer – Wide Mouth Can	6	038753307596	1	15
30766	Gallon	Cleaner – Wide Mouth Can	6	038753307664	1	16
30768	Gallon	Purple Primer/Cleaner	6	038753307688	1	16
30770	16 oz.	Purple Primer – Industrial Grade	24	038753307701	1	14
30771	32 oz.	Purple Primer – Industrial Grade	12	038753307718	1	14
30772	Gallon	Purple Primer – Industrial Grade	6	038753307725	1	14
30773	16 oz.	Clear Primer – Industrial Grade	24	038753307732	1	15
30774	32 oz.	Clear Primer – Industrial Grade	12	038753307749	1	15
30775	Gallon	Clear Primer – Industrial Grade	6	038753307756	1	15
30779	4 oz.	Cleaner	24	038753307794	1	16
307793	4 oz.	Cleaner – Display Pack	48	038753307794	1	16
30780	4 oz.	Purple Primer/Cleaner	24	038753307800	1	16
30782	8 oz.	Cleaner	24	038753307824	1	16
307823	8 oz.	Cleaner – Display Pack	36	038753307824	1	16
30783	8 oz.	Purple Primer/Cleaner	24	038753307831	1	16
30795	16 oz.	Cleaner	24	038753307954	1	16
307953	16 oz.	Cleaner	10	038753307954	1	16
30796	16 oz.	Purple Primer/Cleaner	24	038753307961	1	16
30805	32 oz.	Cleaner	12	038753308050	1	16
308053	32 oz.	Cleaner – Display Pack	6	038753308050	1	16
30806	32 oz.	Purple Primer/Cleaner	12	038753308067	1	16
30810	16 oz.	CPE Solvent w/ dauber	12	038753308104	10	89
30812	16 oz.	LO-VOC X-15 PVC Solvent w/ dauber	6	038753308128	10	89
30818	4 oz.	All Purpose	24	038753308180	1	11
308183	4 oz.	All Purpose – Display Pack	48	038753308180	1	11
30821	8 oz.	All Purpose	24	038753308210	1	11
308213	8 oz.	All Purpose – Display Pack	36	038753308210	1	11
30834	16 oz.	All Purpose	24	038753308340	1	11
308343	16 oz.	All Purpose – Display Pack	10	038753308340	1	11



Product No.	Size	Description	Ctn. Qty.	UPC	Category	Page Number
30847	32 oz.	All Purpose	12	038753308470	1	11
30848	Gallon	All Purpose	6	038753308487	1	11
30850	4 oz.	PVC Heavy Duty Clear	24	038753308500	1	7
30863	8 oz.	PVC Heavy Duty Clear	24	038753308630	1	7
308633	8 oz.	PVC Heavy Duty Clear - Display Pack	36	038753308630	1	7
30875	4 oz.	PVC Flexible Clear	12	038753308753	1	11
30876	16 oz.	PVC Heavy Duty Clear	24	038753308760	1	7
308763	16 oz.	PCV Heavy Duty Clear - Display Pack	10	038753308760	1	7
30879	32 oz.	PVC Flexible Clear	12	038753308791	1	11
30883	4 oz.	PVC Medium Gray	24	038753308838	1	8
308833	4 oz.	PVC Medium Gray – Display Pack	48	038753308838	1	8
30884	8 oz.	PVC Medium Gray	24	038753308845	1	8
30885	16 oz.	PVC Medium Gray	24	038753308852	1	8
30886	32 oz.	PVC Medium Gray	12	038753308869	1	8
30887	Gallon	PVC Medium Gray	6	038753308876	1	8
30889	8 oz.	ABS Medium Black	24	038753308890	1	12
308893	8 oz.	ABS Medium Black – Display Pack	36	038753308890	1	12
30890	4 oz.	PVC Rain-R-Shine® Blue	24	038753308906	1	9
308903	4 oz.	PVC Rain-R-Shine® Blue – Display Pack	48		1	9
30891	8 oz.	PVC Rain-R-Shine® Blue	24	038753308913	1	9
308913	8 oz.	PVC Rain-R-Shine® Blue – Display Pack	36	038753308913	1	9
30892	16 oz.	ABS Medium Black	24	038753308920	1	12
308923	16 oz.	ABS Medium Black – Display Pack	10	038753308920	1	12
30893	16 oz.	PVC Rain-R-Shine® Blue	24	038753308937	1	9
308933	16 oz.	PVC Rain-R-Shine® Blue – Display Pack	10	038753308937	1	9
30894	32 oz.	PVC Rain-R-Shine® Blue	12	038753308944	1	9
308943	32 oz.	PVC Rain-R-Shine® Blue – Display Pack	6	038753308944	1	9
30895	Gallon	PVC Rain-R-Shine® Blue – Wide Mouth Can	6	038753308951	1	9
30900	4 oz.	ABS To PVC Transition Green	24	038753309002	1	11
3090033	4 oz.	ABS To PVC Transition Green	24	038753309002	1	11
30901	1 Gallon	Wide Mouth Can	6	038753309019	1	29
30902	32 oz.	ABS Medium Black	12	038753309026	1	12
309023	32 oz.	ABS Medium Black – Display Pack	6	038753309026	1	12
30915	Gallon	ABS Medium Black	6	038753309156	1	12
30916	4 oz.	ABS Extra Special Black	24	038753309163	1	12
30917	8 oz.	ABS Extra Special Black	24	038753309170	1	12
309173	8 oz.	ABS Extra Special Black – Display Pack	36	038753309170	1	12
30918	16 oz.	ABS Extra Special Black	24	038753309187	1	12
30919	32 oz.	ABS Extra Special Black	12	038753309194	1	12
30920	Gallon	ABS Extra Special Black	6	038753309200	1	12
30922	16 oz.	ABS Special Milky Clear	24	038753309224	1	12
30923	32 oz.	ABS Special Milky Clear	12	038753309231	1	12
30924	Gallon	ABS Special Milky Clear	6	038753309248	1	12
30925	16 oz.	ABS To PVC Transition Green	6	038753309255	1	11
30926	32 oz.	ABS To PVC Transition Green	12	038753309262	1	11
30999	4 oz.	ABS Medium Black	24	038753309996	1	12
309993	4 oz.	ABS Medium Black – Display Pack	48	038753309996	1	12
31008	32 oz.	PVC Heavy Duty Clear	12	038753310084	1	7
310083	32 oz.	PVC Heavy Duty Clear - Display Pack	6	038753310084	1	7



db Dearborn Brass.



Oatey

Product No.	Size	Description	Ctn. Qty.	UPC	Category	Page Number
31011	Gallon	PVC Heavy Duty Clear - Wide Mouth Can	6	038753310114	1	7
31012	4 oz.	PVC Regular Clear	24	038753310121	1	8
310123	4 oz.	PVC Regular Clear – Display Pack	48	038753310121	1	8
31013	8 oz.	PVC Regular Clear	24	038753310138	1	8
310133	8 oz.	PVC Regular Clear – Display Pack	36	038753310138	1	8
31014	16 oz.	PVC Regular Clear	24	038753310145	1	8
310143	16 oz.	PVC Regular Clear – Display Pack	10	038753310145	1	8
31015	32 oz.	PVC Regular Clear	12	038753310152	1	8
310153	32 oz.	PVC Regular Clear – Display Pack	6	038753310152	1	8
31016	Gallon	PVC Regular Clear	6	038753310169	1	8
31017	4 oz.	PVC Medium Clear	24	038753310176	1	8
310173	4 oz.	PVC Medium Clear - Display Pack	72	038753310176	1	8
31018	8 oz.	PVC Medium Clear	24	038753310183	1	8
310183	8 oz.	PVC Medium Clear - Display Pack	36	038753310183	1	8
31019	16 oz.	PVC Medium Clear	24	038753310190	1	8
310193	16 oz.	PCV Medium Clear - Display Pack	10	038753310190	1	8
31020	32 oz.	PVC Medium Clear	12	038753310206	1	8
310203	32 oz.	PVC Medium Clear - Display Pack	6	038753310206	1	8
31021	Gallon	PVC Medium Clear	6	038753310213	1	8
31036	16 oz.	CPVC Heavy Duty Gray	24	038753310367	1	14
31037	32 oz.	CPVC Heavy Duty Gray	12	038753310374	1	14
310488	24" - 48"	I-Series Plug	1	675115310483	18	181
310600	24" - 60"	I-Series Plug	1	675115310605	18	181
310728	48" - 72"	I-Series Plug	1	675115310728	18	181
31082	16 oz.	CPVC Heavy Duty Orange	24	038753310824	1	14
31083	32 oz.	CPVC Heavy Duty Orange	12	038753310831	1	14
31084	Gallon	CPVC Heavy Duty Orange – Wide Mouth Can	6	038753310848	1	14
31093	4 oz.	PVC Heavy Duty Gray	24	038753310930	1	7
31094	8 oz.	PVC Heavy Duty Gray	24	038753310947	1	7
31095	16 oz.	PVC Heavy Duty Gray	24	038753310954	1	7
31105	32 oz.	PVC Heavy Duty Gray	12	038753311050	1	7
31118	Gallon	PVC Heavy Duty Gray - Wide Mouth Can	6	038753311180	1	7
31121	16 oz.	PVC Heavy Duty Gray Fast Set	24	038753311210	1	7
311213	16 oz.	PVC Heavy Duty Gray Fast Set - Display Pack	10	038753311210	1	7
31122	32 oz.	PVC Heavy Duty Gray Fast Set	12	038753311227	1	7
31123	Gallon	PVC Heavy Duty Gray Fast Set - Wide Mouth Can	6	038753311234	1	7
31127	Gallon	CPVC Medium Orange	6	038753311272	1	13
31128	4 oz.	CPVC Medium Orange	24	038753311289	1	13
311283	4 oz.	CPVC Medium Orange – Display Pack	48	038753311289	1	13
31129	8 oz.	CPVC Medium Orange	24	038753311296	1	13
311293	8 oz.	CPVC Medium Orange – Display Pack	36	038753311296	1	13
31130	16 oz.	CPVC Medium Orange	24	038753311302	1	13
31131	32 oz.	CPVC Medium Orange	12	038753311319	1	13
31132	16 oz.	PVC All Weather Clear	24	038753311326	1	10
311323	16 oz.	PVC All Weather Clear – Display Pack	10	038753311326	1	10
31133	32 oz.	PVC All Weather Clear	12	038753311333	1	10
31135	Gallon	PVC All Weather Clear – Wide Mouth Can	6	038753311357	1	10
31166	14 oz.	Putty – Plastic container	24	038753311661	4	50
311660	14 oz.	Putty – Plastic container – Mini Pallet	270	038753311661	4	50



Product No.	Size	Description	Ctn. Qty.	UPC	Category	Page Number
31166D	14 oz.	Putty – Plastic container – Display	30	038753311661	4	50
31170	3 lb.	Putty – Plastic container	6	038753311708	4	50
31174	5 lb.	Putty – Plastic container	6	038753311746	4	50
31174D	5 lb.	Putty – Plastic container	6	038753311746	4	50
31187		Urinal Wax Ring	24	038753311876	8	70
31186		MaxWax Bowl Ring with Sleeve	12	038753311863	8	70
31190		Heavy Duty Wax Bowl Ring	48	038753311906	8	70
31193		Flanged Gasket W/ 1/4" X 2-1/4" Brass Bolts And Nuts	24	038753311937	8	70
31194		Wax Bowl Ring With Polycarbonate Sleeve	24	038753311944	8	70
31195		Fiber Reinforced Wax Bowl Ring with Polycarbonate Sleeve	24	038753311951	8	70
31199	1/2" x 260"	PTFE White Thread Seal Tape	144	038753311999	2	34
31202	1/2" x 520"	PTFE White Thread Seal Tape	144	038753312026	2	34
31212	3/4" x 260"	PTFE White Thread Seal Tape	144	038753312125	2	34
31226	1 fl. oz.	Gray Pipe Joint Compound	12	038753312262	2	33
31226D	1 fl. oz.	Gray Pipe Joint Compound – Display	54	038753312262	2	33
31227	4 fl. oz.	Gray Pipe Joint Compound	12	038753312279	2	33
31228	8 fl. oz.	Gray Pipe Joint Compound	12	038753312286	2	33
31228D	8 fl. oz.	Gray Pipe Joint Compound – Display	30	038753312286	2	33
31229	1 fl. oz.	Great White® Pipe Joint Compound w/PTFE	12	038753312293	2	33
312291	1 fl. oz.	Great White® Pipe Joint Compound w/ PTFE – Gravity Feed	120	038753312293	2	33
31229D	1 fl. oz.	Great White® Pipe Joint Compound w/ PTFE – Display	54	038753312293	2	33
31230	4 fl. oz.	Great White® Pipe Joint Compound w/ PTFE	12	038753312309	2	33
31230D	4 fl. oz.	Great White® Pipe Joint Compound w/ PTFE	48	038753312309	2	33
31231	8 fl. oz.	Great White® Pipe Joint Compound w/ PTFE	12	038753312316	2	33
31231D	8 fl. oz.	Great White® Pipe Joint Compound w/ PTFE	30	038753312316	2	33
31232	16 fl. oz.	Great White® Pipe Joint Compound w/ PTFE	24	038753312323	2	33
31233	32 fl. oz.	Great White® Pipe Joint Compound w/ PTFE	12	038753312330	2	33
31235	16 fl. oz.	Gray Pipe Joint Compound	24	038753312354	2	33
31236	32 fl. oz.	Gray Pipe Joint Compound	12	038753312361	2	33
31250	32 oz. can	Cement Carrier	12	038753312507	1	29
31257	16/32 oz.	Brush Top Dauber 1-1/2" Length	48	038753312576	1	29
31258		Square Nose Toilet Base Plate	12		23	230
31259		Round Nose Toilet Base Plate	12		23	230
31261	4 fl. oz.	Great Blue® Pipe Joint Compound	12	038753312613	2	33
31262	8 fl. oz.	Great Blue® Pipe Joint Compound	12	038753312620	2	33
31263	16 fl. oz.	Great Blue® Pipe Joint Compound	24	038753312637	2	33
312636	16 fl. oz.	Great Blue® Pipe Joint Compound	6	038753312637	2	33
31265	1 fl. oz.	Great Blue® Pipe Joint Compound	12	038753312651	2	33
31270	4 oz.	Fix-It Stick Epoxy Putty	12	038753312705	4	51
31275	12"	Gallon Can Roller Applicator – Fits Wide And Standard Mouth Size	12	038753312750	1	29
31276	12"	Gallon Can Swab Applicator – Fits Wide And Standard Mouth Size	12	038753312767	1	29
31299	4 oz.	Dauber 3/4"	48	038753312996	1	29
31300	1/2"	Adjustable Plastic Dauber w/ 1/2" Ball	100	038753313009	1	29
31301	1"	Adjustable Plastic Dauber w/ 1" Ball	100	038753313016	1	29
31302	1"	Adjustable Plastic Dauber w/ 1" Ball	50	038753313023	1	29
31304	4 oz.	Cement Can	24	038753313047	1	29
31305	8 oz.	Cement Can	24	038753313054	1	29

NUMERICAL LISTING



Product No.	Size	Description	Ctn. Qty.	UPC	Category	Page Number
31306	16 oz.	Cement Can	24	038753313061	1	29
31307	32 oz.	Cement Can	12	038753313078	1	29
31309	8 oz.	Dauber 3/4"	48	038753313092	1	29
31310	16 oz.	Dauber 1-1/2"	48	038753313108	1	29
31312	32 oz.	Dauber 1-1/2"	48	038753313122	1	29
31313	16/32 oz.	Dauber For CPVC Cement 3/4"	48	038753313139	1	29
31315	1.5" x 2 yds.	120 Grit Abrasive Sandcloth	20	038753313153	3	45
31317	1.5" x 10 yds.	120 Grit Abrasive Sandcloth	24	038753313177	3	45
31318	1.5" x 25 yds.	120 Grit Abrasive Sandcloth	12	038753313184	3	45
31320	1.5" x 5 yds.	180 Open Mesh Cloth	24	038753313207	3	45
31321	1.5" x 10 yds.	180 Open Mesh Cloth	24	038753313214	3	45
31327	1/2"	ID Fitting Brush w/ Heavy Duty Handle	12	038753313276	3	45
31328	3/4"	ID Fitting Brush w/ Heavy Duty Handle Carded	12	038753313283	3	45
31329	1"	ID Fitting Brush w/ Heavy Duty Handle	12	038753313290	3	45
31330	1-1/4"	ID Fitting Brush w/ Heavy Duty Handle	12	038753313306	3	45
31331	1-1/2"	ID Fitting Brush w/ Heavy Duty Handle	6	038753313313	3	45
31332	2"	ID Fitting Brush w/ Heavy Duty Handle	6	038753313320	3	45
31336	1/2"	ID fitting brush w/ wire handle	12	038753313368	3	45
31337	3/4"	ID fitting brush w/ wire handle	12	038753313375	3	45
31338	1"	ID fitting brush w/ wire handle	12	038753313382	3	45
31339	1-1/4"	ID fitting brush w/ wire handle	12	038753313399	3	45
31340	1-1/2"	ID fitting brush w/ wire handle	6	038753313405	3	45
31341	2"	ID fitting brush w/ wire handle	6	038753313412	3	45
31345	1/2"	O.D. tube brush	12	038753313450	3	46
31346	3/4"	O.D. tube brush	12	038753313467	3	46
31347	1"	O.D. tube brush	12	038753313474	3	46
31348	1/2" & 3/4"	4-in-1 brush	12	038753313481	3	45
31400	9" x 12"	Bagged Flame Protector	5	038753314006	3	44
31402D	1/2" x 260"	PTFE Pink Thread Seal Tape – Display	50	038753314020	2	34
31403	1/2" x 260"	PTFE Yellow Thread Seal Tape – Dispenser Pack	100	038753314037	2	34
31403D	1/2" x 260"	PTFE Yellow Thread Seal Tape – Display	20	038753314037	2	34
31404	1/2"	ID Fitting Brush w/ Heavy Duty Handle Carded	10	038753314044	3	45
31405	3/4"	ID Fitting Brush w/ Heavy Duty Handle Carded	10	038753314051	3	45
31406	1"	ID Fitting Brush w/ Heavy Duty Handle Carded	10	038753314068	3	45
31407	1/2" & 3/4"	4-in-1 brush – Carded	10	038753314075	3	46
31408	1/4" & 1/2"	Power Brushes – Carded	10	038753314082	3	46
31409		Nylon grit pads – Carded	10	038753314099	3	46
31410		Specialty brushes – Carded	10	038753314105	3	46
31411	1.5" x 2 yds.	120 Grit Abrasive Sandcloth – Carded	10	038753314112	3	44
31412	1/2"	O.D. tube brush – Carded	10	038753314129	3	46
31413	3/4"	O.D. tube brush – Carded	10	038753314136	3	46
31414	1"	O.D. tube brush – Carded	10	038753314143	3	46
31416	0.6 oz.	Liquilock - Gel For Toilet Removal	24	038753314167	8	70
31417	0.6 oz.	Liquilock - Gel For Toilet Removal	50	038753314174	8	70
31417D	0.6 oz.	Liquilock - Gel For Toilet Removal - Display Pack	50	038753314174	8	70
314488	24" - 48"	I-Series Plug with 4" MNPT Bypass	1	675115314481	18	183
314600	24" - 60"	I-Series Plug with 4" MNPT Bypass	1	675115314603	18	183
314728	48" - 72"	I-Series Plug with 4" MNPT Bypass	1	675115314726	18	181
316488	24" - 48"	I-Series Plug with 6" MNPT Bypass	1	675115316485	18	181



Product No.	Size	Description	Ctn. Qty.	UPC	Category	Page Number
316600	24" - 60"	I-Series Plug with 6" MNPT Bypass	1	675115316607	18	181
317488	24" - 48"	I-Series Plug	1	675115317482	18	181
317600	24" - 60"	I-Series Plug	1	675115317604	18	181
317728	48" - 72-1/4"	I-Series Plug	1	675115317727	18	181
31910	4 oz.	CPVC Flowguard Gold® 1-Step Yellow	24	038753319100	1	13
31911	8 oz.	CPVC Flowguard Gold® 1-Step Yellow	24	038753319117	1	13
319113	8 oz.	CPVC Flowguard Gold® 1-Step Yellow – Display Pack	40	038753319117	1	13
31912	16 oz.	CPVC Flowguard Gold® 1-Step Yellow	24	038753319124	1	13
319123	16 oz.	CPVC Flowguard Gold® 1-Step Yellow	10	038753319124	1	13
31913	32 oz.	CPVC Flowguard Gold® 1-Step Yellow	12	038753319131	1	13
31914	Gallon	CPVC Flowguard Gold® 1-Step Yellow	6	038753319148	1	13
31917	8 oz.	1-Step CPVC Flowguard Gold® with UV Indicator	24	038753319179	1	13
31918	16 oz.	1-Step CPVC Flowguard Gold® with UV Indicator	24	038753319186	1	13
31919	32 oz.	1-Step CPVC Flowguard Gold® with UV Indicator	24	038753319193	1	13
31925	4 oz.	PVC Regular Clear Advanced	24	038753319254	1	9
31926	8 oz.	PVC Regular Clear Advanced	24	038753319261	1	9
31927	16 oz.	PVC Regular Clear Advanced	24	038753319278	1	9
31928	32 oz.	PVC Regular Clear Advanced	12	038753319285	1	9
31929	Gallon	PVC Regular Clear Advanced - Wide Mouth Can	6	038753319292	1	9
31936	8 oz.	PVC Hot Weather Plus Medium Clear	24	038753319360	1	10
31937	16 oz.	PVC Hot Weather Plus Medium Clear	24	038753319377	1	10
31938	32 oz.	PVC Hot Weather Plus Medium Clear	12	038753319384	1	10
32160	4 oz.	PVC Blue Lava Hot Cement	24	038753321608	1	9
32161	8 oz.	PVC Blue Lava Hot Cement	24	038753321615	1	9
32162	16 oz.	PVC Blue Lava Hot Cement	24	038753321622	1	9
32163	32 oz.	PVC Blue Lava Hot Cement	12	038753321639	1	9
32164	Gallon	PVC Blue Lava Hot Cement	6	038753321646	1	9
32167	16 oz.	Orange Lava CPVC Cut-In Cement	24		1	9
32168	32 oz.	Orange Lava CPVC Cut-In Cement	12		1	9
3236S	32 oz.	CPVC Medium Orange	12	083675032361	1	23
3246S	16 oz.	CPVC Medium Orange	24	083675032460	1	23
3256S	8 oz.	CPVC Medium Orange	24	083675032569	1	23
3266S	4 oz.	CPVC Medium Orange	24	083675032668	1	23
33440	1 2"	Clog Buster®	6	038753334400	6	60
33441	1-1/2" – 3"	Clog Buster®	6	038753334417	6	60
33442	4 – 6"	Clog Buster®	4	038753334424	6	60
33444		Faucet Adapter	12	038753334448	6	60
33445		Hose & Faucet Adapter Kit	4	038753334455	6	60
33460	1-1/2"	Knock-Out™ Inset Test Cap	1500		23	232
33461	2"	Knock-Out™ Inset Test Cap	1200		23	232
33462	3"	Knock-Out™ Inset Test Cap	500		23	232
33463	4"	Knock-Out™ Inset Test Cap	300		23	232
33464	1-1/2"	Push-Cap™ Test Cap	250		23	232
33465	2"	Push-Cap™ Test Cap	150		23	232
33466	3"	Push-Cap™ Test Cap	100		23	232
33467	4"	Push-Cap™ Test Cap	50		23	232
33468	1-1/2"	End-Cap™ PVC	1000		23	232
33469	1-1/2"	End-Cap™ ABS	1000		23	232
33470	2"	End-Cap™ PVC	800		23	232



db Dearborn Brass.



Product No.	Size	Description	Ctn. Qty.	UPC	Category	Page Number
33471	2"	End-Cap™ ABS	800		23	232
33472	3"	End-Cap™ PVC	400		23	232
33473	3"	End-Cap™ ABS	400		23	232
33474	4"	End-Cap™ PVC	200		23	232
33475	4"	End-Cap™ ABS	200		23	232
33476	6"	End-Cap™ PVC	50		23	232
33477	6"	End-Cap™ ABS	50		23	232
33478	1-1/2 -2"	MS End-Cap™ Test Cap PVC	500		23	233
33479	1-1/2 -2"	MS End-Cap™ Test Cap ABS	500		23	233
33480	3" - 4"	MS End-Cap™ Test Cap PVC	200		23	233
33481	3" - 4"	MS End-Cap™ Test Cap	200		23	233
33680	1/2"	Two-Pipe Clamps with Nails (20 in polybag)	10	038753336800	14	125
33681	1/2"	Two-Pipe Clamps with Screws (20 in polybag)	10	038753336817	14	125
33682	1/2"	One-Pipe Clamps	10	038753336824	14	125
33691	1/2"	Copper Plated Bell Hanger	25	038753336916	14	128
33692	3/4"	Copper Plated Bell Hanger	25	038753336923	14	128
33693	1"	Copper Plated Bell Hanger	25	038753336930	14	128
33694	1/2" x 6"	Copper Plated Milford Hanger	25	038753336947	14	128
33695	3/4" x 6"	Copper Plated Milford Hanger	25	038753336954	14	128
33696	1" x 6"	Copper Plated Milford Hanger	25	038753336961	14	128
33697	1/2" x 12"	Copper Plated Milford Hanger	25	038753336978	14	128
33698	3/4" x 12"	Copper Plated Milford Hanger	25	038753336985	14	128
33699	1" x 12"	Copper Plated Milford Hanger	25	038753336992	14	128
33730	3/4" x 10'	24 Ga. Galvanized Steel Hanger Strap – Bagged	12	038753337302	14	128
33740	1-1/2" x 7-1/2"	DWV J-Hook - White (25 In Polybag)	300	038753337401	14	126
33741	2" x 7-1/2"	DWV J-Hook - White (25 In Polybag)	300	038753337418	14	126
33742	3" x 7-1/2"	DWV J-Hook - White (25 In Polybag)	300	038753337425	14	126
33743	4" x 7-1/2"	DWV J-Hook - White (25 In Polybag)	300	038753337432	14	126
33745	1/2" x 4"	CTS Baby J-Hook (25 in polybag)	300	038753337456	14	127
33746	3/4" x 4"	CTS Baby J-Hook (25 in polybag)	300	038753337463	14	127
33747	1" x 4"	CTS Baby J-Hook (25 in polybag)	200	038753337470	14	127
33750	1/2" x 7-1/2"	CTS Long Baby J-Hook (25 in polybag)	200	038753337500	14	127
33751	3/4" x 7-1/2"	CTS Long Baby J-Hook (25 in polybag)	200	038753337517	14	127
33755	1-1/2" x 7"	DWV J-Hook - Black (25 In Polybag)	300	038753337555	14	126
33756	2" x 7"	DWV J-Hook - Black (25 In Polybag)	300	038753337562	14	126
33757	3" x 7"	DWV J-Hook - Black (25 In Polybag)	300	038753337579	14	126
33758	4" x 7"	DWV J-Hook - Black (25 In Polybag)	300	038753337586	14	126
33760	1-1/2" x 7-1/2"	DWV J-Hook - White (4 In Polybag)	6	038753337609	14	126
33761	2" X 7- 1/2"	DWV J-Hook - White (4 In Polybag)	6	038753337616	14	126
33762	3" X 7-1/2"	DWV J-Hook - White (4 In Polybag)	6	038753337623	14	126
33763	4" x 7-1/2"	DWV J-Hook - White (4 In Polybag)	6	038753337630	14	126
33764	1/2" x 4"	CTS Baby J-Hook (6 in polybag)	6	038753337647	14	127
33765	3/4" x 4"	CTS Baby J-Hook (6 in polybag)	6	038753337654	14	127
33766	1" x 4"	CTS Baby J-Hook (6 in polybag)	6	038753337661	14	127
33850	7-1/2"	Ties for 1-3/4" diameter (25 in polybag)	12	038753338507	14	127
33851	11"	Ties for 3" diameter (25 in polybag)	12	038753338514	14	127
33852	14"	Ties for 4" diameter (25 in polybag)	12	038753338521	14	127
33853	24"	Ties for 7" diameter (6 in polybag)	12	038753338538	14	127
33854	34"	Ties for 10" diameter (6 in polybag)	12	038753338545	14	127



Product No.	Size	Description	Ctn. Qty.	UPC	Category	Page Number
33855	48"	Ties for 15" diameter (6 in polybag)	12	038753338552	14	127
33856	1/2"	Metal Stud Insulating Pipe Clamp (50 in polybag)	250	038753338569	14	125
33857	3/4"	Metal Stud Insulating Pipe Clamp (50 in polybag)	250	038753338576	14	125
33858	1"	Metal Stud Insulating Pipe Clamp (25 in polybag)	250	038753338583	14	125
33875	1"	Insulating Pipe Clamp (6 in polybag)	6	038753338750	14	124
33876	1"	Suspension Pipe Clamp (6 in polybag)	6	038753338767	14	124
33877	1"	Standard Pipe Clamp (6 in polybag)	6	038753338774	14	124
33889	3/4" x 100'	28 Ga. Galvanized Steel Hanger Strap – Boxed	10	038753338897	14	128
33893	1-1/2" x 3"	16 Gauge Self-Nailing Stud Guard – 2-1/2" between points	100	038753338934	14	127
33894	1-1/2" x 5"	16 Gauge Self-Nailing Stud Guard – 4-1/2" between points	100	038753338941	14	127
33895	1-1/2" x 6"	16 Gauge Self-Nailing Stud Guard – 5-1/2" between points	100	038753338958	14	127
33897	5" x 8"	16 Gauge BOCA Plate Meets BOCA Code P-309.2	25	038753338972	14	127
33899	5" x 8"	16 Gauge Self-Nailing BOCA Plate Meets BOCA Code P-309.2	25	038753338996	14	127
33900	1/2"	Half Clamp w/ barbed nail (100 in polybag)	500	038753339009	14	123
33901	3/4"	Half Clamp w/ barbed nail (100 in polybag)	500	038753339016	14	123
33902	1"	Half Clamp w/ barbed nail (50 in polybag)	250	038753339023	14	123
33905	1/2"	Full Clamp w/ barbed nail (100 in polybag)	500	038753339054	14	123
33906	3/4"	Full Clamp w/ barbed nail (50 in polybag)	250	038753339061	14	123
33907	1"	Full Clamp w/ barbed nail (25 in polybag)	250	038753339078	14	123
33908	1"	Copper Tube Strap (12 in polybag)	6	038753339085	14	125
33909	1"	Half Clamp w/ barbed nail (6 in polybag)	6	038753339092	14	123
33910	1/2"	Half Clamp w/ barbed nail (12 in polybag)	6	038753339108	14	123
33911	3/4"	Half Clamp w/ barbed nail (12 in polybag)	6	038753339115	14	123
33912	1/2"	Full Clamp w/ barbed nail (12 in polybag)	6	038753339122	14	123
33913	3/4"	Full Clamp w/ barbed nail (12 in polybag)	6	038753339139	14	123
33914	1/2"	Suspension Pipe Clamp (6 in polybag)	6	038753339146	14	124
33915	3/4"	Suspension Pipe Clamp (6 in polybag)	6	038753339153	14	124
33916	1/2"	Standard Pipe Clamp (6 in polybag)	6	038753339160	14	124
33917	3/4"	Standard Pipe Clamp (6 in polybag)	6	038753339177	14	124
33918	3/4" x 10'	24 Ga. Copper-Plated Steel Hanger Strap – Bagged	12	038753339184	14	128
33919	1-1/2" x 6"	18 Gauge Self-Nailing Stud Guard – 5-1/2" between points	100	038753339191	14	127
33922	3/4" x 50'	28 Ga. Galvanized Steel Hanger Strap – Bulk	10	038753339221	14	128
33923	3/4" x 10'	28 Ga. Galvanized Steel Hanger Strap – Bagged	12	038753339238	14	128
33925	3/4" x 25'	Plastic Hanger Strap – Bagged	20	038753339252	14	128
33926	3/4" x 50'	Plastic Hanger Strap – Bagged	20	038753339269	14	128
33927	3/4" x 100'	Plastic Hanger Strap – Bagged	20	038753339276	14	128
339270	3/4" x 100'	Plastic Hanger Strap – Bagged	10	038753339276	14	128
33928	3/4" x 10'	Plastic Hanger Strap – Bagged	12	038753339283	14	128
33929	3/4" x 25'	28 Ga. Galvanized Steel Hanger Strap – Bagged	12	038753339290	14	128
33930	1-1/2" x 3"	18 Gauge Self-Nailing Stud Guard – 2-1/2" between points	100	038753339306	14	127
33931	1-1/2" x 5"	18 Gauge Self-Nailing Stud Guard – 4-1/2" between points	100	038753339313	14	127
33932	1-1/2" x 9"	18 Gauge FHA Plate -Barcoded	25	038753339320	14	127
33933	1-1/2" x 3"	18 Gauge Self-Nailing Stud Guard – Barcoded	25	038753339337	14	127
33934	1-1/2" x 5"	18 Gauge Self-Nailing Stud Guard – Barcoded	25	038753339344	14	127
33935	1/2"	Suspension Pipe Clamp (100 in polybag)	500	038753339351	14	124

NUMERICAL LISTING



Product No.	Size	Description	Ctn. Qty.	UPC	Category	Page Number
33936	3/4"	Suspension Pipe Clamp (100 in polybag)	500	038753339368	14	124
33937	1"	Suspension Pipe Clamp (50 in polybag)	250	038753339375	14	124
33940	1/2"	Standard Pipe Clamp (100 in polybag)	500	038753339405	14	124
33941	3/4"	Standard Pipe Clamp (100 in polybag)	500	038753339412	14	124
33942	1"	Standard Pipe Clamp (50 in polybag)	250	038753339429	14	124
33943	1-1/4"	Standard Pipe Clamp (25 in polybag)	250	038753339436	14	124
33944	1-1/2"	Standard Pipe Clamp (25 in polybag)	250	038753339443	14	124
33946	2"	Standard Pipe Clamp (25 in polybag)	250	038753339467	14	124
33950	1/2"	Insulating Pipe Clamp (50 in polybag)	250	038753339504	14	124
33951	3/4"	Insulating Pipe Clamp (50 in polybag)	250	038753339511	14	124
33952	1"	Insulating Pipe Clamp (25 in polybag)	250	038753339528	14	124
33953	1/2"	Insulating Pipe Clamp (6 in polybag)	6	038753339535	14	124
33954	3/4"	Insulating Pipe Clamp (6 in polybag)	6	038753339542	14	124
33955	1/2" x 6"	Steel Pipe Hook – 6 per Bag	12	038753339559	14	128
33956	1-1/4"	Suspension Pipe Clamp (25 in polybag)	250	038753339566	14	124
33957	1-1/2"	Suspension Pipe Clamp (25 in polybag)	250	038753339573	14	124
33958	2"	Suspension Pipe Clamp (25 in polybag)	250	038753339580	14	124
33964	1/2" x 6"	Steel Pipe Hook – 12 per Bag	12	038753339641	14	126
33965	1/2" – 3/4"	Copper Coated Tube Nailer (12 in polybag)	36	038753339658	14	125
33966	1/2" – 3/4"	Copper Coated Steel Nailer (100 in polybag)	1000	038753339665	14	125
33969	1" x 6"	Copper Pipe Hook – 6 per Bag	12	038753339696	14	126
33970	1/2" x 6"	Copper Pipe Hook – 12 per Bag	10	038753339702	14	126
33971	1/2" x 6"	Copper Pipe Hook – 50 per Box	500	038753339719	14	126
33972	3/4" x 6"	Copper Pipe Hook – 12 per Bag	10	038753339726	14	126
33973	3/4" x 6"	Copper Pipe Hook – 50 per Box	500	038753339733	14	126
33974	1" x 6"	Copper Pipe Hook – 12 per Bag	10	038753339740	14	126
33975	1" x 6"	Copper Pipe Hook – 50 per Box	500	038753339757	14	126
33977	1/2" x 6"	Copper Pipe Hook – 6 per Bag	12	038753339771	14	126
33979	3/4" x 6"	Steel Pipe Hook – 6 per Bag	12	038753339795	14	126
33980		Pipe Support Bracket	25	038753339801	14	125
33982	5/8" x 18"	Hyco-Bar – 14 Ga.	100	038753339825	14	128
33983	5/8" x 26"	Hyco-Bar – 14 Ga.	100	038753339832	14	128
33984	1-1/2" x 5"	16 Gauge Self-Nailing Stud Guard – 4-1/2" between points	100	038753339849	14	127
33989	3/4" x 10'	Galvanized Tab Tape – 28 Ga. – Bagged	12	038753339894	14	128
33992	1-1/2" x 50'	Galvanized Tab Tape – 26 Ga. – Boxed	5	038753339924	14	128
33993	1/2"	Copper Tube Strap (50 in polybag)	500	038753339931	14	125
33994	3/4"	Copper Tube Strap (50 in polybag)	500	038753339948	14	125
33995	1/2"	Copper Tube Strap (12 in polybag)	6	038753339955	14	125
33996	3/4"	Copper Tube Strap (12 in polybag)	6	038753339962	14	125
33997	1" x 6"	Steel Pipe Hook – 50 per Box	500	038753339979	14	126
33998	1/2" x 6"	Steel Pipe Hook – 50 per Box	500	038753339986	14	126
33999	3/4" x 6"	Steel Pipe Hook – 50 per Box	500	038753339993	14	126
34015		PEX Water Supply Kit with 1/4" Valve	6	038753340159	11	105
34018		PEX Celcon Compression Sleeve	48	038753340180	11	105
34044	14" x 29"	Plastic Access Panel	6		23	230
34045	8" x 8"	Plastic Access Panel	6		23	230
34049		High Density Polypropylene Stand & Pan	1	038753340494	21	198
34051	28" x 30"	Plastic Pan – Bagged	4	038753340517	21	198
34052	28" x 30"	Plastic Pan – Without Fitting	6	038753340524	21	198



Product No.	Size	Description	Ctn. Qty.	UPC	Category	Page Number
34053	6" x 9"	Plastic Access Panel – Display	6		23	230
34054	4" x 6"	Plastic Access Panel	12		23	230
34055	6" x 9"	Plastic Access Panel	6		23	230
34056	14" x 14"	Plastic Access Panel	6		23	230
34059	14" x 14"	Plastic Access Panel – Display	4		23	230
34057	21" Square x 18" High	Galvanized Water Heater Stand	4	038753340579	21	198
34058	24"	Plastic Pan	6	038753340586	21	197
34060	18"	Plastic Pan	12	038753340609	21	197
34061	20"	Plastic Pan	12	038753340616	21	197
34062	22"	Plastic Pan	12	038753340623	21	197
34063	24"	Plastic Pan	12	038753340630	21	197
34064	26"	Plastic Pan	12	038753340647	21	197
34065	30"	Plastic Pan	12	038753340654	21	197
34066	22"	Plastic Pan Without Hole / Adapter	12	038753340661	21	197
34067	28" x 30"	Plastic Pan	12	038753340678	21	199
34068	15"	15" Deep/57" Long Fits 14" Tubs	35		23	230
34069	14"	Bath Tub Protector	35		23	230
34070	16"	Bath Tub Protector	35		23	230
34072	28"	Plastic Pan	12	038753340722	21	197
34076	16"	Bath Tub Protector – Oval	25		23	230
34079	18"	Aluminum Pan	6	038753340791	21	196
34080		Standard Tub Box	12 Pair		23	230
34081	20"	Aluminum Pan	6	038753340814	21	196
34082	22"	Aluminum Pan	6	038753340821	21	196
34083	24"	Aluminum Pan	6	038753340838	21	196
34084	26"	Aluminum Pan	6	038753340845	21	196
34085	30"	Aluminum Pan	6	038753340852	21	196
34086	1" & 1-1/2"	PVC Adapter (1" inside adapter / 1-1/2" inside adapter)	12	038753340869	21	197
34087		TB 2000 Tub Box	5 Pair		23	230
34088	1" & 1-1/2"	PVC Adapter (1" inside adapter / 1-1/2" over adapter)	12	038753340883	21	197
34089	1"	CPVC Adapter	12	038753340890	21	197
34090	18"	Aluminum Pan Without Hole / Adapter	6	038753340906	21	196
34091	20"	Aluminum Pan Without Hole / Adapter	6	038753340913	21	196
34092	22"	Aluminum Pan Without Hole / Adapter	6	038753340920	21	196
34093	24"	Aluminum Pan Without Hole / Adapter	6	038753340937	21	196
34094	26"	Aluminum Pan Without Hole / Adapter	6	038753340944	21	196
34095	30"	Aluminum Pan Without Hole / Adapter	6	038753340951	21	196
34103	28"	Aluminum Pan	6	038753341033	21	196
34119	24"	Plastic Pan With Hole / Adapter	6	038753341194	21	199
34125	14" - 16"	Multi-Size Adjustable Bath Tub Protector	35		23	230
34140	18"	Plastic Pan	12	038753341408	21	197
34141	20"	Plastic Pan	12	038753341415	21	197
34142	22"	Plastic Pan	12	038753341422	21	197
34143	24"	Plastic Pan	12	038753341439	21	197
34144	26"	Plastic Pan	12	038753341446	21	197
34145	30"	Plastic Pan	12	038753341453	21	197
34146	28"	Plastic Pan	12	038753341460	21	197
34151	20"	Aluminum Pan	6	038753341514	21	196

NUMERICAL LISTING



Product No.	Size	Description	Ctn. Qty.	UPC	Category	Page Number
34152	22"	Aluminum Pan	6	038753341521	21	196
34153	24"	Aluminum Pan	6	038753341538	21	196
34154	26"	Aluminum Pan	6	038753341545	21	196
34156	28"	Aluminum Pan	6	038753341569	21	196
34157	24"	Aluminum Pan With Hole / Without Adapter	6	038753341576	21	196
34158	20"	Plastic Pan	12	038753341583	21	197
34159	22"	Plastic Pan	12	038753341590	21	197
34160	18"	Plastic Pan	12	038753341606	21	197
34161	20"	Plastic Pan	12	038753341613	21	197
34162	22"	Plastic Pan	12	038753341620	21	197
34163	24"	Plastic Pan	12	038753341637	21	197
34164	26"	Plastic Pan	12	038753341644	21	197
34165	30"	Plastic Pan	12	038753341651	21	197
34168	28"	Plastic Pan	12	038753341682	21	197
34170	18"	Aluminum Pan	6	038753341705	21	196
34171	20"	Aluminum Pan	6	038753341712	21	196
34172	22"	Aluminum Pan	6	038753341729	21	196
34173	24"	Aluminum Pan	6	038753341736	21	196
34174	26"	Aluminum Pan	6	038753341743	21	196
34175	30"	Aluminum Pan	6	038753341750	21	196
34176	28"	Aluminum Pan	6	038753341767	21	196
34247		Louvered Design Access Panel	12	038753342474	13	119
34285	1/2" - 3/4"	DuoFit Pipe Support System with Nail (100 in polybag)	500	038753342856	14	123
34286	1/2"	Stand-Off Pipe Clamp with Nail (100 in polybag)	500	038753342863	14	123
34287	3/4"	Stand-Off Pipe Clamp with Nail (100 in polybag)	500	038753342870	14	123
34288	1"	Stand-Off Pipe Clamp with Nail (50 in polybag)	250	038753342887	14	123
34295	1/2" - 3/4"	DuoFit Pipe Support System with Nail (12 in polybag)	6	038753342955	14	123
34297	1/2" - 3/4"	DuoFit Pipe Support System with Nail (400 in 2.1 Gal. Bucket)	1	038753342975	14	123
34298	1/2"	Stand-Off Pipe Clamp with Nail (500 in 2.1 Gal. Bucket)	1	038753342982	14	123
34299	3/4"	Stand-Off Pipe Clamp with Nail (300 in 2.1 Gal. Bucket)	1	038753342999	14	123
34300		PEX Riser Supply 3/8" Comp x 1/2" IPS Threads x 12"	12	038753343006	11	105
34301		PEX Riser Supply 3/8" Comp x 1/2" IPS Threads x 20"	12	038753343013	11	105
34302		PEX Riser Supply 3/8" Comp x 1/2" IPS Threads x 36"	12	038753343020	11	105
34305		PEX Riser Supply 3/8" Comp x 7/8" Ballcock x 12"	12	038753343051	11	105
34306		PEX Riser Supply 3/8" Comp x 7/8" Ballcock x 20"	12	038753343068	11	105
34310		PEX Sink Supply 12"	48	038753343105	11	105
34311		PEX Sink Supply 15"	48	038753343112	11	105
34312		PEX Sink Supply 20"	48	038753343129	11	105
34313		PEX Sink Supply 30"	48	038753343136	11	105
34314		PEX Sink Supply 36"	48	038753343143	11	105
34315		PEX Toilet Riser 12"	48	038753343150	11	105
34316		PEX Toilet Riser 15"	48	038753343167	11	105
34317		PEX Toilet Riser 20"	48	038753343174	11	105
34322		PEX Sink Supply 30" With Flag	48	038753343228	11	105
34351		PEX Dishwasher Supply 3/8" x 3/8" x 5'	6	038753343518	11	105
34405	4"	Flat Chrome Cover Plate	25	038753344058	9	85
34406	5"	Flat Chrome Cover Plate	25	038753344065	9	85
34410	4"	Flat White Cover Plate	25	038753344102	9	85
34411	5"	Flat White Cover Plate	25	038753344119	9	85



Product No.	Size	Description	Ctn. Qty.	UPC	Category	Page Number
34415	4"	Bell Chrome Cover Plate	25	038753344157	9	85
34416	5"	Bell Chrome Cover Plate	25	038753344164	9	85
34420	4"	Bell White Cover Plate	25	038753344201	9	85
34421	5"	Bell White Cover Plate	25	038753344218	9	85
34900	1/2"	Half Clamp w/ barbed nail (100 in polybag)	5	038753349008	14	123
34901	3/4"	Half Clamp w/ barbed nail (100 in polybag)	5	038753349015	14	123
35100	113 gram	Boiler Cleaner	12	032628351004	7	65
35151	16 oz.	Airspray	12	032628351516	7	65
35152	15 lb.	Reusable Plastic Pail	1	032628351523	7	65
35155	19 oz.	Shaker Top Can	12	032628351554	7	65
35180	11 oz.	Aerosol Can	12	032628351806	7	66
35185	17 oz.	Aerosol Can	12	032628351851	7	66
351C		Chrome Plated Die Cast Diverter Spout w/ Personal Shower Fitting w/ 3/4" x 1/2" Face Bushing	12	041193009050	17	178
35206	1 qt.	Boiler and Heating System Cleaner	12	032628352063	7	67
35211	1 gal.	Boiler and Heating System Cleaner	6	032628352117	7	67
35216	5 gal.	Boiler and Heating System Cleaner	1	032628352162	7	67
35220	1 qt.	Boiler and Heating System Cleaner		032628352209	7	67
35253	1 gal.	Cryo-Tek™ Original	6	032628352537	7	66
35255	55 gal.	Boiler and Heating System Cleaner			7	67
35260	5 gal.	Cryo-Tek™ Original	1	032628352605	7	66
35267	55 gal.	Cryo-Tek™ Original	1	032628352674	7	66
35271		Test Kit, 6 - 10 Packs	6	032628352711	7	67
35272		pH Test Meter	1	032628352726	7	67
35274	8 oz.	Cryo-Tek A1 Inhibitor	12	032628352742	7	67
35276	8 oz.	Cryo-Tek Inhibitor	24	032628352766	7	67
35277	1 qt.	Cryo-Tek A1 Inhibitor	12		7	67
35278	1 qt.	Cryo-Tek Inhibitor	12		7	67
35280	5 gal.	Cryo-Tek Solar System	1	032628352803	7	67
35281	1 gal.	Cryo-Tek™ -100	6	032628352810	7	66
35282	1 gal.	Cryo-Tek™ AG	6	032628352827	7	66
35283	5 gal.	Orange Container	1	032628352834	7	67
35284	5 gal.	Cryo-Tek™ -100	1	032628352841	7	66
35285	5 gal.	Cryo-Tek™ AG	1	032628352858	7	66
35286	30 gal.	Cryo-Tek™ -100	1	032628352865	7	66
35287	55 gal.	Cryo-Tek™ -100	1	032628352872	7	66
35288	30 gal.	Cryo-Tek™ AG	1	032628352889	7	66
35289	55 gal.	Cryo-Tek™ AG	1	032628352896	7	66
35290		Refractometer	1	032628352602	7	67
35291	55 gal.	Drum	1	032628352916	7	67
35292	55 gal.	Cryo-Tek Solar System	1	032628352926	7	67
35302	1 pt.	Power Flow™	1	032628353022	7	68
35302R	1 pt.	Power Flow™ - 6 pack			7	68
35310	1 qt.	Sludge Treat	12	032628353107	7	68
35315	1 gal.	Sludge Treat	6	032628353152	7	68
35320	5 gal.	Sludge Treat	1	032628353206	7	68
35427	85 g.	Display	72	032628354272	7	68
355		Tub Faucet for No. R100, Add-On Shower Frames	1	041193056313	17	178
35503	1/2 pt.	Regular Body	24	032628355033	7	68
35504	1 pt.	Regular Body	12	032628355040	7	68

NUMERICAL LISTING



Product No.	Size	Description	Ctn. Qty.	UPC	Category	Page Number
35509	11 oz.	Regular Body - Cartridge	12	032628355095	7	68
355128	6"- 12"	Muni-Ball® Plug 1" Bypass	1	675115355125	18	184
35515	1/2 gal.	Regular Body	6	032628355156	7	68
35521	1/2 gal.	Heavy Body	6	032628355217	7	68
355248	12"- 24"	Muni-Ball® Plug 2" Bypass	1	675115355248	18	184
35526	1 gal.	Heavy Body	4	032628355262	7	68
35610	1 gal.	Regular Body	4	032628356108	7	68
359A		Chrome Plated Brass Diverter Spout, 3/4" NPT Wall Connection w/ 3/4" x 1/2" Brass Face Bushing	12	041193052667	17	178
36308		Smoke Fluid Conversion Kit From Smoke Bomb Briggs & Stratton Engine	1		20	194
3713		Swedge Tool for 3/8", 1/2" & 3/4" I.D. Nominal sizes to 5/8" & 7/8" O.D. Tubing	1	041193071859	17	171
3784		Junior Duo Bar Sink Strainer, Stainless Steel Body and Basket. Length 1-1/8"	12	041193071194	17	168
3784BN		Same as 3784 w/ Brass Nuts	12	041193011732	17	168
3784T		Same as 3784 w/ 4" Chrome Plated Tailpiece	12	041193113511	17	168
3785A		Standard Bar Sink Strainer, Brass Body and Crumb Cup. Length - 2-1/8"	12	041193071200	17	168
3785ABN		Same as 3785A w/ Brass Nuts	12	041193011787	17	168
3785AT		Same as 3785A w/ 4" Chrome Plated Tailpiece	12	041193113528	17	168
38380		Centro, Plain Box, No Valves – Standard Pack	12	038753383800	11	96
38381		Centro, Plastic Faceplate	12	038753383017	11	96
38382		Brackets 4" Long Plastic	12	038753383824	11	96
38383		Brackets 12" Long Plastic	12	038753383831	11	96
38388		Centro, 1/4 Turn, F1960, Hammer – Standard Pack	12	038753383880	11	96
38389		Centro, 1/4 Turn, F1807, Hammer – Standard Pack	12	038753383897	11	96
38390		Centro, 1/4 Turn, Copper – Standard Pack	12	038753383903	11	96
38391		Centro, 1/4 Turn, F1807 – Standard Pack	12	038753383910	11	96
38392		Centro, 1/4 Turn, CPVC – Standard Pack	12	038753383927	11	96
38393		Centro, 1/4 Turn, Copper, Hammer – Standard Pack	12	038753383934	11	96
38394		Centro, 1/4 Turn, CPVC, Hammer – Standard Pack	12	038753383941	11	96
38395		Centro, Plain Box, No Valves – Standard Pack	12	038753383958	11	96
38396		Centro, 1/4 Turn, F1960 – Standard Pack	12	038753383965	11	96
38398		Double Outlet, 1/4 Turn, Copper - Display Pack	4	038753383989	11	97
38399		Offset Drain, 1/4 Turn, Copper – Display Box	4	038753383996	11	96
38400		WMOB Valve, 1/4 Turn, Copper, Hammer, Red	1	038753384009	11	106
38401		WMOB Valve, 1/4 Turn, Copper, Hammer, Blue	1	038753384016	11	106
38402		WMOB Valve, 1/4 Turn, CPVC, Hammer, Red	1	038753384023	11	106
38403		WMOB Valve, 1/4 Turn, CPVC, Hammer, Blue	1	038753384030	11	106
38404		WMOB Valve, 1/4 Turn, F1960, Hammer, Red	1	038753384047	11	106
38405		WMOB Valve, 1/4 Turn, F1960, Hammer, Blue	1	038753384054	11	106
38408		WMOB Valve, 1/4 Turn, F1807, Hammer, Red	1	038753384085	11	106
38409		WMOB Valve, 1/4 Turn, F1807, Hammer, Blue	1	038753384092	11	106
38412		WMOB Valve, Single Lever, Copper, Hammer	1	038753384122	11	106
38413		WMOB Valve, Single Lever, CPVC, Hammer	1	038753384139	11	106
38414		WMOB Valve, Single Lever, F1807, Hammer	1	038753384146	11	106
38415		WMOB Valve, Single Lever, F1960, Hammer	1	038753384153	11	106
38417		IMOB Valve, 1/4 Turn, Copper, Hammer	1	038753384177	11	107
38418		IMOB Valve, 1/4 Turn, CPVC, Hammer	1	038753384184	11	107
38419		IMOB Valve, 1/4 Turn, F1807, Hammer	1	038753384191	11	107



Product No.	Size	Description	Ctn. Qty.	UPC	Category	Page Number
38420		IMOB Valve, 1/4 Turn, F1960, Hammer	1	038753384207	11	107
38422		IMOB, Valve 1/4 Turn, F2080, Hammer	1	038753384221	11	107
38428		WMOB, Valve, 1/4 Turn, F1807 3/8", Hammer, Red	1	038753384283	11	106
38429		WMOB, Valve, 1/4 Turn, F1807 3/8", Hammer, Blue	1	038753384290	11	106
38430		WMOB Valve, 1/4 Turn, F1807 3/8", Red	1	038753384306	11	106
38431		WMOB Valve, 1/4 Turn, F1807 3/8", Blue	1	038753384313	11	106
38432		WMOB Valve, 1/4 Turn, Compression, Red	1	038753384320	11	106
38433		WMOB Valve, 1/4 Turn, Compression, Blue	1	038753384337	11	106
38434		WMOB Valve, Single Lever, CPVC	1	038753384344	11	106
38435		WMOB Valve, Single Lever, F1807	1	038753384351	11	106
38436		WMOB Valve, Single Lever, F1960	1	038753384368	11	106
38440		WMOB Valve, Boiler Drain, Copper	1	038753384405	11	106
38441		IMOB Valve, Boiler Drain, Copper	1	038753384412	11	107
38460		Quadro Test Cap and Gauge	1	038753384603	11	94
38470		Fire Rated, 1/4 Turn, Copper - Standard Pack	6	038753384702	11	99
38470SP		Fire Rated, 1/4 Turn, Copper - Single Pack	1	038753384702	11	99
38471		Fire Rated, 1/4 Turn, CPVC - Standard Pack	6	038753384719	11	99
38471SP		Fire Rated, 1/4 Turn, CPVC - Single Pack	1	038753384719	11	99
38472		Fire Rated, 1/4 Turn, F1807 - Standard Pack	6	038753384726	11	99
38472SP		Fire Rated, 1/4 Turn, F1807 - Single Pack	1	038753384726	11	99
38473		Fire Rated, 1/4 Turn, F1960 - Standard Pack	6	038753384733	11	99
38473SP		Fire Rated, 1/4 Turn, F1960 - Single Pack	1	038753384733	11	99
38474		Fire Rated, Single Lever, Copper - Standard Pack	6	038753384740	11	99
38474SP		Fire Rated, Single Lever, Copper - Single Pack	1	038753384740	11	99
38475		Fire Rated, Single Lever, CPVC - Standard Pack	6	038753384757	11	99
38475SP		Fire Rated, Single Lever, CPVC - Single Pack	1	038753384757	11	99
38476		Fire Rated, Single Lever, F1807 - Standard Pack	6	038753384764	11	99
38476SP		Fire Rated, Single Lever, F1807 - Single Pack	1	038753384764	11	99
38477		Fire Rated, Single Lever, F1960 - Standard Pack	6	038753384771	11	99
38477SP		Fire Rated, Single Lever, F1960 - Single Pack	1	038753384771	11	99
38478		Fire Rated, 1/4 Turn, Copper, Hammer - Standard Pack	6	038753384788	11	99
38478SP		Fire Rated, 1/4 Turn, Copper, Hammer - Single Pack	1	038753384788	11	99
38479		Fire Rated, 1/4 Turn, CPVC, Hammer - Standard Pack	6	038753384795	11	99
38479SP		Fire Rated, 1/4 Turn, CPVC, Hammer - Single Pack	1	038753384795	11	99
38480		Fire Rated, 1/4 Turn, F1807, Hammer - Standard Pack	6	038753384801	11	99
38480SP		Fire Rated, 1/4 Turn, F1807, Hammer - Single Pack	1	038753384801	11	99
38481		Fire Rated, 1/4 Turn, F1960, Hammer - Standard Pack	6	038753384818	11	99
38481SP		Fire Rated, 1/4 Turn, F1960, Hammer - Single Pack	1	038753384818	11	99
38482		Fire Rated, Single Lever, Copper, Hammer - Standard Pack	6	038753384825	11	99
38482SP		Fire Rated, Single Lever, Copper, Hammer - Single Pack	1	038753384825	11	99
38483		Fire Rated, Single Lever, CPVC, Hammer - Standard Pack	6	038753384832	11	99
38483SP		Fire Rated, Single Lever, CPVC, Hammer - Single Pack	1	038753384832	11	99
38484		Fire Rated, Single Lever, F1807, Hammer - Standard Pack	6	038753384849	11	99
38484SP		Fire Rated, Single Lever, F1807, Hammer - Single Pack	1	038753384849	11	99
38485		Fire Rated, Single Lever, F1960, Hammer - Standard Pack	6	038753384856	11	99
38485SP		Fire Rated, Single Lever, F1960, Hammer - Single Pack	1	038753384856	11	99
38486		Fire Rated, 1/4 Turn, Copper - Standard Pack	6	038753384863	11	104

NUMERICAL LISTING



Product No.	Size	Description	Ctn. Qty.	UPC	Category	Page Number
38486SP		Fire Rated, 1/4 Turn, Copper - Single Pack	1	038753384863	11	104
38487		Fire Rated, 1/4 Turn, CPVC - Standard Pack	6	038753384870	11	104
38487SP		Fire Rated, 1/4 Turn, CPVC - Single Pack	1	038753384870	11	104
38488		Fire Rated, 1/4 Turn, F1807 - Standard Pack	6	038753384887	11	104
38488SP		Fire Rated, 1/4 Turn, F1807 - Single Pack	1	038753384887	11	104
38489		Fire Rated, 1/4 Turn, F1960 - Standard Pack	6	038753384894	11	104
38489SP		Fire Rated, 1/4 Turn, F1960 - Single Pack	1	038753384894	11	104
38490		Fire Rated, 1/4 Turn, Copper, Hammer - Standard Pack	6	038753384900	11	104
38490SP		Fire Rated, 1/4 Turn, Copper, Hammer - Single Pack	1	038753384900	11	104
38491		Fire Rated, 1/4 Turn, CPVC, Hammer - Standard Pack	6	038753384917	11	104
38491SP		Fire Rated, 1/4 Turn, CPVC, Hammer - Single Pack	1	038753384917	11	104
38492		Fire Rated, 1/4 Turn, F1807, Hammer - Standard Pack	6	038753384924	11	104
38492SP		Fire Rated, 1/4 Turn, F1807, Hammer - Single Pack	1	038753384924	11	104
38493		Fire Rated, 1/4 Turn, F1960, Hammer - Standard Pack	6	038753384931	11	104
38493SP		Fire Rated, 1/4 Turn, F1960, Hammer - Single Pack	1	038753384931	11	104
38494		Fire Rated, Plain Box, No Valves, Faceplate, or Bracket	6	038753384948	11	99
38495		Fire Rated, Plain Box, No Valves - Standard Pack	6	038753384955	11	104
38496		Fire Rated, Faceplate	6	038753384962	11	99
38497		Fire Rated, Faceplate	6	038753384979	11	104
38498		Fire Rated, Bracket-2 Piece	12	038753384986	11	99
38528		Quadro, 1/4 Turn, F1807 – Display Box	4	038753385280	11	94
38529		Quadro, 1/4 Turn, Copper – Display Box	4	038753385297	11	94
38530		Quadro, 1/4 Turn, Copper – Standard Pack	12	038753385303	11	94
38531		Quadro, 1/4 Turn, CPVC – Standard Pack	12	038753385310	11	94
38532		Quadro, 1/4 Turn, F1807 – Standard Pack	12	038753385327	11	94
38533		Quadro, 1/4 Turn, F1960 – Standard Pack	12	038753385334	11	94
38535		Quadro, Single Lever, Copper – Standard Pack	12	038753385358	11	94
38536		Quadro, Single Lever, CPVC – Standard Pack	12	038753385365	11	94
38537		Quadro, Single Lever, F1807 – Standard Pack	12	038753385372	11	94
38538		Quadro, Single Lever, F1960 – Standard Pack	12	038753385389	11	94
38540		Quadro, 1/4 Turn, Copper, Hammer – Standard Pack	12	038753385402	11	94
38541		Quadro, 1/4 Turn, CPVC, Hammer – Standard Pack	12	038753385419	11	94
38542		Quadro, 1/4 Turn, F1807, Hammer – Standard Pack	12	038753385426	11	94
38543		Quadro, 1/4 Turn, F1960, Hammer – Standard Pack	12	038753385433	11	94
38545		Quadro, Single Lever, Copper, Hammer – Standard Pack	12	038753385457	11	94
38546		Quadro, Single Lever, Copper, Hammer – Standard Pack	12	038753385464	11	94
38547		Quadro, Single Lever, CPVC, Hammer – Standard Pack	12	038753385471	11	94
38548		Quadro, Single Lever, F1807, Hammer – Standard Pack	12	038753385488	11	94
38550		Quadro, Single Lever, F1960, Hammer – Standard Pack	12	038753385501	11	94
38551		Quadro, 1/4 Turn, Compression – Standard Pack	12	038753385518	11	94
38552		Quadro, Brass Boiler Drain, Copper – Standard Pack	12	038753385525	11	94
38553		Quadro, Brass Boiler Drain, Copper, Screw Driver Stop – Standard Pack	12	038753385532	11	94
38554		Quadro, North American Brass Boiler Drain, Copper, NAFTA – Standard Pack	12	038753385549	11	94
38555		Quadro, 1/4 Turn, F2080 – Standard Pack	12	038753385556	11	94
38558		Smoke Fluid Conversion Kit From Smoke Bomb Honda Engine Pre 2006	1		20	194
38560		Quadro, 1/4 Turn, Copper – Contractor Pack	12	038753385600	11	94
38561		Quadro, 1/4 Turn, CPVC – Contractor Pack	12	038753385617	11	94



Product No.	Size	Description	Ctn. Qty.	UPC	Category	Page Number
38562		Quadtro, 1/4 Turn, F1807 – Contractor Pack	12	038753385624	11	94
38563		Quadtro, 1/4 Turn, F1960 – Contractor Pack	12	038753385631	11	94
38570		Square, 1/4 Turn, Copper, Hammer - Standard Pack, 6' SS Hose	6	038753385709	11	101
38571		Square, 1/4 Turn, CPVC, Hammer - Standard Pack, 6' SS Hose	6	038753385716	11	101
38572		Square, 1/4 Turn, F1807, Hammer - Standard Pack, 6' SS Hose	6	038753385723	11	101
38573		I2K, 1/4 Turn, F2080, Hammer - Standard Pack	12	038753385730	11	103
38574		Square, 1/4 Turn, Copper - Standard Pack, 6' SS Hose	6	038753385747	11	100
38575		Square, 1/4 Turn, F1807 - Standard Pack, 6' SS Hose	6	038753385754	11	100
38576		Quadtro Test Cap	12	038753385761	11	94
38577		Quadtro Hub/O-Ring	24	038753385778	11	94
38580		I2K, 1/4 Turn, Copper, Hammer - Standard Pack	12	038753385808	11	103
38582		I2K, 1/4 Turn, CPVC, Hammer - Standard Pack	12	038753385822	11	103
38583		I2K, 1/4 Turn, F1807, Hammer - Standard Pack	12	038753385839	11	103
38584		I2K, 1/4 Turn, F1960, Hammer - Standard Pack	12	038753385846	11	103
38587		I2K, 1/4 Turn, Copper - Display Pack	4	038753385877	11	103
385961		Square, 1/4 Turn, F1960 - Standard Pack, 6' SS Hose	6	038753385983	11	100
38597		I2K, 1/4 Turn, F1807 3/8" - Standard Pack	6	038753385976	11	103
38600		Quiet Pipes Washing Machine Supply Line Shock Absorber	6		23	231
38601		Quiet Pipes MIP Shock Absorber – Discontinued after 12/31/12**	6		23	231
38602		Square, 1/4 Turn, CPVC, Hammer - Standard Pack	6	038753386027	11	101
38604		Square, 1/4 Turn, F1807, Hammer - Standard Pack	6	038753386041	11	101
38605		Square, 1/4 Turn, F1960, Hammer - Standard Pack	6	038753386058	11	101
38606		I2K, 1/4 Turn, F1960 - Contractor Pack	12	038753386065	11	103
38607		Square, 1/4 Turn, Copper, Hammer - Display Pack	6	038753386072	11	101
38608		Square, 1/4 Turn, Copper, Hammer - Standard Pack	6	038753386089	11	101
38610		I2K, 1/4 Turn, CPVC - Standard Pack	6	038753386102	11	103
38611		I2K, 1/4 Turn, Copper - Standard Pack	6	038753386119	11	103
38612		I2K, 1/4 Turn, Copper - Contractor Pack	12	038753386126	11	103
38613		I2K, 1/4 Turn, F1807 - Standard Pack	6	038753386133	11	103
38614		I2K, 1/4 Turn, CPVC - Contractor Pack	12	038753386140	11	103
38615		I2K, 1/4 Turn, F1807 - Contractor Pack	12	038753386157	11	103
38617		I2K, Boiler Drain, Copper, NAFTA - Standard Pack	6	038753386171	11	103
38619		I2K, Plain Box, No Valves - Standard Pack	6	038753386195	11	103
38621		I2K, Plastic Faceplate 1/2" Deep	12	038753386218	11	103
38622		I2K, Plastic Faceplate 1" Deep	12	038753386225	11	103
38623		Square, 1/4 Turn, CPVC - Standard Pack, 6' SS Hose	6	038753386232	11	100
38624		Square, 1/4 Turn, F1960 - Contractor Pack, 6' SS Hose	12	038753386249	11	100
38630		Eliminator, 1/4 Turn, Copper - Standard Pack	12	038753386300	11	97
38631		Eliminator, 1/4 Turn, Copper, Top Mount - Standard Pack	12	038753386317	11	97
38633		Eliminator, 1/4 Turn, F1807 - Standard Pack	12	038753386331	11	97
38634		Eliminator, Single Lever, Copper - Standard Pack	12	038753386348	11	97
38635		Eliminator, Single Lever, F1807 - Standard Pack	12	038753386355	11	97
38637		Eliminator, 1/4 Turn, CPVC - Standard Pack	12	038753386379	11	97
38640		Eliminator, Plain Box, No Valves - Contractor Pack	12	038753386409	11	97
38642		Eliminator, 1/4 Turn, Copper, Hammer - Standard Pack	12	038753386423	11	97
38644		Eliminator, 1/4 Turn, F1960 - Contractor Pack	12	038753386447	11	97



db Dearborn Brass.



Oatey

Product No.	Size	Description	Ctn. Qty.	UPC	Category	Page Number
38645		Eliminator, 1/4 Turn, F1960, Top Mount - Standard Pack	12	038753386454	11	97
38646		Eliminator, Plastic Steel Clamp	6	038753386461	11	97
38648		Plastic Brackets, 12" long, for Plastic Boxes	12	038753386485	11	94
38649		Eliminator, Plastic Faceplate	12	038753386492	11	97
38650		Double Outlet, Plain Box, No Valves	12	038753386508	11	97
38651		Eliminator, Single Lever, F1960 - Standard Pack	12	038753386515	11	97
38652		Eliminator, 1/4 Turn, CPVC, Hammer - Standard Pack	12	038753386522	11	97
38655		Eliminator, 1/4 Turn, Copper, Hammer, Top Mount - Contractor Pack	12	038753386553	11	97
38656		Eliminator, 1/4 Turn, CPVC, Hammer, Top Mount - Standard Pack	12	038753386560	11	97
38657		Eliminator, 1/4 Turn, F1807, Hammer, Top Mount - Contractor Pack	12	038753386577	11	97
38658		Eliminator, 1/4 Turn, F1960, Hammer, Top Mount - Contractor Pack	12	038753386584	11	97
38660		Double Outlet, Single Lever, Copper - Standard Pack	12	038753386607	11	97
38661		Eliminator, Single Lever, CPVC- Standard Pack	12		11	97
38666		Eliminator, Single Lever, F1807, Hammer - Standard Pack	12	038753386669	11	97
38667		Eliminator, Single Lever, F1960, Hammer - Standard Pack	12	038753386676	11	97
38669		Eliminator, 1/4 Turn, F1960, Hammer - Standard Pack	12	038753386690	11	97
38670		Double Outlet, 1/4 Turn, CPVC - Standard Pack	12	038753386706	11	97
38673		Double Outlet, 1/4 Turn, Copper - Standard Pack	12	038753386737	11	97
38674		Double Outlet, 1/4 Turn, F1807 - Standard Pack	12	038753386744	11	97
38680		Square, 1/4 Turn, CPVC - Standard Pack	6	038753386805	11	100
38681		Square, 1/4 Turn, Copper - Standard Pack	6	038753386812	11	100
38683		Square, 1/4 Turn, Copper - Contractor Pack	12	038753386836	11	100
38684		Square, 1/4 Turn, F1807 - Standard Pack	6	038753386843	11	100
38685		Square, 1/4 Turn, CPVC - Contractor Pack	12	038753386850	11	100
38686		Metal Faceplate	1	038753386867	11	100
38687		Metal, Plain Box, No Valves - Standard Pack	1	038753386874	11	100
38688		Metal, 1/4 Turn, Copper, Hammer - Standard Pack	1	038753386881	11	100
38689		Metal, 1/4 Turn, Copper - Standard Pack	1	038753386898	11	100
38691		Square, 1/4 Turn, F1807 - Contractor Pack	12	038753386911	11	100
38693		Square, 1/4 Turn, F1960 - Standard Pack	6	038753386935	11	100
38707	200'	Pipe Guard – Blue	10	038753387079	23	231
38708	200'	Pipe Guard – Red	10	038753387086	23	231
38710	1/8"H x 2"W x 40'L	Protect-A-Wrap	24	038753387109	23	231
38711	4" x 4"	Foam Closet Spacer	60	038753387116	23	231
38712	4" x 82"	Foam Closet Wrap	9	038753387123	23	231
38725		1/4 Turn, F1807, Hammer – Standard Pack	12	038753387253	11	95
38726		1/4 Turn, F1960, Hammer – Standard Pack	12	038753387260	11	95
38747		1/4 Turn, Copper, Hammer – Standard Pack	12	038753387475	11	95
38748		1/4 Turn Brass Hammer Ball Valves CPVC – Standard Pack	12	038753387482	11	95
38751		Plain Box No Valves – Standard Pack	12	038753387512	11	95
38753		Plain Box – No Valve – Display Box	12	038753387536	11	95
38768		Plastic Brackets, 4" long, for Plastic Boxes	12	038753387680	11	94
38769		Grommets 1/2"	12	038753387697	11	107
38779		Adapter 1/2" Female NPT X 1/2" Copper	1	038753387796	11	107
38787		Double Outlet - Bracket Set	12	038753387871	11	97



Product No.	Size	Description	Ctn. Qty.	UPC	Category	Page Number
38789		IMOB Valve, 1/4 Turn, F2080	1	038753387895	11	107
38791		Offset Drain, Plain Box, No Valves – Standard Pack	12	038753387918	11	96
38799		Plain Box No Valves – Standard Pack with Grommets	12	038753387994	11	95
38806		Square, Plain Box, No Valves, With Grommet - Standard Pack	6	038753388069	11	101
38807		Square, Boiler Drain, Copper, NAFTA - Standard Pack	6	038753388076	11	100
38810		Square, Plain Box, No Valves - Standard Pack	6	038753388106	11	101
38820		Plain Box No Valves – Display Pack with Grommets	12	038753388205	11	95
38822		Offset Drain, Single Lever, Copper – Display Box	4	038753388229	11	96
38823		Square, 1/4 Turn, Copper - Display Pack	6	038753388236	11	100
38824		Plain Box 1/2" No Valves – Bagged	12	038753388243	11	95
38825		1/4 Turn Brass Ball Valves Copper Sweat – Display Pack	4	038753388250	11	95
38826		WMOB Valve, Single Lever, Copper	1	038753388267	11	106
38829		Locknut 1/2" Plastic	1	038753388298	11	107
38870		WMOB Valve, 1/4 Turn, Copper, 3/4" Red	1	038753388700	11	106
38871		WMOB Valve, 1/4 Turn, Copper, 3/4" Blue	1	038753388717	11	106
38880		WMOB Valve, 1/4 Turn, F1960, 3/4" Blue	1	038753388809	11	106
38881		WMOB Valve, 1/4 Turn, F1960, 3/4" Red	1	038753388816	11	106
38884		IMOB Valve, 1/4 Turn, F1960	1	038753388847	11	107
38886		IMOB Valve, 1/4 Turn, F1807	1	038753388861	11	107
38887		IMOB Valve, 1/4 Turn, CPVC	1	038753388878	11	107
38894		Offset Drain, Single Lever, Copper – Standard Pack	12	038753388946	11	96
38928		Plain Box No Valves – Standard Pack – 1.5 -2" Drain Port	12	038753389288	11	95
38934		1/4 Turn Brass Ball Valves Copper Sweat – Standard Pack	12	038753389349	11	95
38937		1/4 Turn Brass Ball Valves CPVC – Standard Pack	12	038753389370	11	95
38940		Double Outlet - Plastic Faceplate	12	038753389400	11	97
38941		Offset Drain, Plastic Faceplate	12	038753389417	11	94
38942		Square, Plastic Faceplate	24	038753389424	11	101
38943		1/4 Turn Brass Ball Valves 1/2" ASTM F1960 PEX – Standard Pack	12	038753389431	11	95
38945		1/4 Turn Brass Ball Valves 1/2" ASTM F1807 PEX – Standard Pack	12	038753389455	11	95
38950		Square, 1/4 Turn, F1807 - Display Bag	6	038753389509	11	100
38951		Square, Boiler Drain, CPVC - Standard Pack	6	038753389516	11	100
38957		Offset Drain, 1/4 Turn, Copper, Hammer – Standard Pack	12	038753389578	11	96
38962		Offset Drain, 1/4 Turn, Copper – Standard Pack	12	038753389622	11	96
38965		WMOB Valve, 1/4 Turn, CPVC, 3/4" Red	1	038753389653	11	106
38969		WMOB Valve, 1/4 Turn, CPVC, 3/4" Blue	1	038753389691	11	106
38970		1/4 Turn Brass Hammer Ball Valves Copper Sweat – Display Box	4	038753389707	11	95
38974		IMOB Valve, 1/4 Turn, Copper	1	038753389745	11	107
38975		Metal, Faceplate	1	038753389752	11	98
38976		Metal, Brackets	1	038753389769	11	98
38977		WMOB Valve, 1/4 Turn, F1807, 3/4" Red	1	038753389776	11	106
38978		WMOB Valve, 1/4 Turn, F1807, 3/4" Blue	1	038753389783	11	106
38979		Metal, 1/4 Turn, CPVC, 2" Rubber Tailpiece - Standard Pack	1	038753389790	11	98
38980		Metal, Plain Box, No Valves, or Tailpiece - Standard Pack	1	038753389806	11	98
38981		Metal, 1/4 Turn, Copper, 2" PVC Tailpiece - Standard Pack	1	038753389813	11	98

NUMERICAL LISTING



Product No.	Size	Description	Ctn. Qty.	UPC	Category	Page Number
38982		Metal, Single Lever, Copper, 2" PVC Tailpiece - Standard Pack	1	038753389820	11	98
38983		Metal, 1/4 Turn, Copper, 2" ABS Tailpiece - Standard Pack	1	038753389837	11	98
38984		Metal, Single Lever, Copper, 2" ABS Tailpiece - Standard Pack	1	038753389844	11	98
38985		Metal, 1/4 Turn, Copper, 2" Rubber Tailpiece - Standard Pack	1	038753389851	11	98
38986		Metal, Single Lever, Copper, 2" Rubber Tailpiece - Standard Pack	1	038753389868	11	98
38987		Metal, 2" PVC Tailpiece	1	038753389875	11	98
38988		Metal, 2" ABS Tailpiece	1	038753389882	11	98
38989		Metal, 1-1/2" Rubber Tailpiece	1	038753389899	11	98
38990		Metal, 2" Rubber Tailpiece	1	038753389905	11	98
38993		Metal, 1/4 Turn, Copper, 2" NPT Tailpiece - Standard Pack	1	038753389936	11	98
38995		Metal, 1/4 Turn, Copper, Hammer, 2" Rubber Tailpiece - Standard Pack	1	038753389950	11	98
38996		Metal, 1/4 Turn, CPVC, Hammer, 2" Rubber Tailpiece - Standard Pack	1	038753389967	11	98
39000		Chrome In-Line Vent	6	038753390000	13	118
39010		Sure-Vent Wall Box with Metal Grille Faceplate	12	038753390109	13	118
39011		Metal Grille Faceplate For Wall Box	10	038753390116	13	118
39012		ABS In-Line Vent	6	038753390123	13	118
39016	1.5" - 2"	20 DFU Sure-Vent AAV	6	038753390161	13	117
39017	1.5" - 2"	20 DFU Sure-Vent AAV	50	038753390178	13	117
39018	1.5" - 2"	20 DFU Sure-Vent AAV	6	038753390185	13	117
39019	1.5" - 2"	20 DFU Sure-Vent AAV	50	038753390192	13	117
39020	1.5"	6 DFU Sure-Vent AAV No adapter	50	038753390208	13	117
39115	1-1/2 - 2"	2 in 1 End Cap w/Barcode	25		23	233
39116	3" - 4"	2 in 1 End Cap w/Barcode	25		23	233
39117		Fire Rated, 1/4 Turn, Copper, Low Lead - Standard Pack	6	038753391175	11	104
39117SP		Fire Rated, 1/4 Turn, Copper, Low Lead - Single Pack	1	038753391175	11	104
39118		Fire Rated, 1/4 Turn, CPVC, Low Lead - Standard Pack	6	038753391182	11	104
39118SP		Fire Rated, 1/4 Turn, CPVC, Low Lead - Single Pack	1	038753391182	11	104
39119		Fire Rated, 1/4 Turn, F1807, Low Lead - Standard Pack	6	038753391199	11	104
39119SP		Fire Rated, 1/4 Turn, F1807, Low Lead - Single Pack	1	038753391199	11	104
39120		Fire Rated, 1/4 Turn, F1960, Low Lead - Standard Pack	6	038753391205	11	104
39120SP		Fire Rated, 1/4 Turn, F1960, Low Lead - Single Pack	1	038753391205	11	104
39121		Fire Rated, 1/4 Turn, Copper, Hammer, Low Lead - Standard Pack	6	038753391212	11	104
39121SP		Fire Rated, 1/4 Turn, Copper, Hammer, Low Lead - Single Pack	1	600387533912	11	104
39122		Fire Rated, 1/4 Turn, CPVC, Hammer, Low Lead - Standard Pack	6	038753391229	11	104
39122SP		Fire Rated, 1/4 Turn, CPVC, Hammer, Low Lead - Single Pack	1	038753391229	11	104
39123		Fire Rated, 1/4 Turn, F1807, Hammer, Low Lead - Standard Pack	6	038753391236	11	104
39123SP		Fire Rated, 1/4 Turn, F1807, Hammer, Low Lead - Single Pack	1	038753391236	11	104
39124		Fire Rated, 1/4 Turn, F1960, Hammer, Low Lead - Standard Pack	6	038753391243	11	104
39124SP		Fire Rated, 1/4 Turn, F1960, Hammer, Low Lead - Single Pack	6	038753391243	11	104



Product No.	Size	Description	Ctn. Qty.	UPC	Category	Page Number
39125		I2K, 1/4 Turn, Copper, Hammer, Low Lead - Standard Pack	12	038753391250	11	103
39126		I2K, 1/4 Turn, CPVC, Hammer, Low Lead - Standard Pack	12	038753391267	11	103
39127		I2K, 1/4 Turn, F1807, Hammer, Low Lead - Standard Pack	12	038753391274	11	103
39128		I2K, 1/4 Turn, F1960, Hammer, Low Lead - Standard Pack	12	038753391281	11	103
39130		I2K, 1/4 Turn, Copper, Low Lead - Display Pack	4	038753391304	11	103
39132		I2K, 1/4 Turn, F1960, Low Lead - Contractor Pack	12	038753391328	11	103
39133		I2K, 1/4 Turn, CPVC, Low Lead - Standard Pack	6	038753391335	11	103
39134		I2K, 1/4 Turn, Copper, Low Lead - Standard Pack	6	038753391342	11	103
39135		I2K, 1/4 Turn, Copper, Low Lead - Contractor Pack	12	038753391359	11	103
39136		I2K, 1/4 Turn, F1807, Low Lead - Standard Pack	6	038753391366	11	103
39137		I2K, 1/4 Turn, CPVC, Low Lead - Contractor Pack	12	038753391373	11	103
39138		I2K, 1/4 Turn, F1807, Low Lead - Contractor Pack	12	038753391380	11	103
39139		I2K, Boiler Drain, Copper, Low Lead, NAFTA - Standard Pack	6	038753391397	11	103
39140		Metal, 1/4 Turn, Copper, Hammer, Low Lead - Standard Pack	1	038753391403	11	100
39141		Metal, 1/4 Turn, Copper, Low Lead - Standard Pack	1	038753391410	11	100
39142		Square, 1/4 Turn, Copper, Hammer, Low Lead - Standard Pack, 6' SS Hose	6	038753391427	11	101
39143		Square, 1/4 Turn, CPVC, Hammer, Low Lead - Standard Pack, 6' SS Hose	6	038753391434	11	101
39144		Square, 1/4 Turn, F1807, Hammer, Low Lead - Standard Pack, 6' SS Hose	6	038753391441	11	101
39145		Square, 1/4 Turn, Copper, Low Lead - Standard Pack, 6' SS Hose	6	038753391458	11	101
39146		Square, 1/4 Turn, F1807, Low Lead - Standard Pack, 6' SS Hose	6	038753391465	11	101
39148		Square, 1/4 Turn, CPVC, Hammer, Low Lead - Standard Pack	6	038753391489	11	101
39149		Square, 1/4 Turn, F1807, Hammer, Low Lead - Standard Pack	6	038753391496	11	101
39150		Square, 1/4 Turn, F1960, Hammer, Low Lead - Standard Pack	6	038753391502	11	101
39151		Square, 1/4 Turn, Copper, Hammer, Low Lead - Display Pack	6	038753391519	11	101
39152		Square, 1/4 Turn, Copper, Hammer, Low Lead - Standard Pack	6	038753391526	11	101
39153		Square, 1/4 Turn, CPVC, Low Lead - Standard Pack, 6' SS Hose	6	038753391533	11	101
39154		Square, 1/4 Turn, F1960 Low Lead - Standard Pack, 6' SS Hose	6	038753391540	11	101
39155		Square, 1/4 Turn, CPVC, Low Lead - Standard Pack	6	038753391557	11	101
39156		Square, 1/4 Turn, Copper, Low Lead - Standard Pack	6	038753391564	11	101
39157		Square, 1/4 Turn, Copper, Low Lead - Contractor Pack	12	038753391571	11	101
39158		Square, 1/4 Turn, F1807, Low Lead - Standard Pack	6	038753391588	11	101
39159		Square, 1/4 Turn, CPVC, Low Lead - Contractor Pack	12	038753391595	11	101
39160		Square, 1/4 Turn, F1807, Low Lead - Contractor Pack	12	038753391601	11	101
39161		Square, 1/4 Turn, F1960 Low Lead - Standard Pack	6	038753391618	11	101
39162		Square, Boiler Drain Copper, Low Lead, NAFTA - Standard Pack	6	038753391625	11	101
39166		IMOB Valve, 1/4 Turn, Copper, Hammer, Low Lead	1	038753391663	11	107
39167		IMOB Valve, 1/4 Turn, CPVC, Hammer, Low Lead	1	038753391670	11	107

NUMERICAL LISTING



Product No.	Size	Description	Ctn. Qty.	UPC	Category	Page Number
39168		IMOB Valve, 1/4 Turn, F1807, Hammer, Low Lead	1	038753391687	11	107
39169		IMOB Valve, 1/4 Turn, F1960, Hammer, Low Lead	1	038753391694	11	107
39171		IMOB Valve, Boiler Drain, Copper, Low Lead	1	038753391717	11	107
39173		IMOB Valve, 1/4 Turn, F1960 Low Lead	1	038753391731	11	107
39174		IMOB Valve, 1/4 Turn, F1807, Low Lead	1	038753391748	11	107
39175		IMOB Valve, 1/4 Turn, CPVC, Low Lead	1	038753391755	11	107
39176		IMOB Valve, 1/4 Turn, Copper, Low Lead	1	038753391762	11	107
39177		Quiet Pipes MIP Shock Absorber – Low Lead	6		23	231
39180		Round, 1/4 Turn, Copper - Standard Pack	6	038753391809	11	102
39179		Round, 1/4 Turn, CPVC - Standard Pack	6	038753391796	11	102
39182		Round, 1/4 Turn, F1807 - Standard Pack	6	038753391823	11	102
39183		Round, 1/4 Turn, F1960 - Standard Pack	6	038753391830	11	102
39184		Round, 1/4 Turn, Copper, Hammer - Standard Pack	6	038753391847	11	102
39185		Round, 1/4 Turn, CPVC, Hammer - Standard Pack	6	038753391854	11	102
39186		Round, 1/4 Turn, F1807, Hammer - Standard Pack	6	038753391861	11	102
39187		Round, 1/4 Turn, F1960, Hammer - Standard Pack	6	038753391878	11	102
39186		Round, 1/4 Turn, Copper - Contractor Pack	12	038753391865	11	102
39189		Round, 1/4 Turn, CPVC - Contractor Pack	12	038753391892	11	102
39190		Round, 1/4 Turn, F1807 - Contractor Pack	12	038753391908	11	102
39191		Round, 1/4 Turn, F1960 - Contractor Pack	12	038753391915	11	102
39192		Round, 1/4 Turn, Copper, Hammer - Contractor Pack	12	038753391922	11	102
39193		Round, 1/4 Turn, CPVC, Hammer - Contractor Pack	12	038753391939	11	102
39194		Round, 1/4 Turn, F1807, Hammer - Contractor Pack	6	038753391946	11	102
39196		Round, 1/4 Turn, F1960, Hammer - Contractor Pack	12	038753391960	11	102
39197		Round, 1/4 Turn, Copper - Standard Pack, 6' SS Hose	6	038753391977	11	102
39198		Round, 1/4 Turn, CPVC - Standard Pack, 6' SS Hose	6	038753391984	11	102
39199		Round, 1/4 Turn, F1807 - Standard Pack, 6' SS Hose	6	038753391991	11	102
39200		Round, 1/4 Turn, F1960 - Standard Pack, 6' SS Hose	6	038753392004	11	102
39201		Round, 1/4 Turn, Copper, Hammer - Standard Pack, 6' SS Hose	6	038753392011	11	102
39202		Round, 1/4 Turn, CPVC, Hammer - Standard Pack, 6' SS Hose	6	038753392028	11	102
39203		Round, 1/4 Turn, F1807, Hammer - Standard Pack, 6' SS Hose	6	038753392035	11	102
39204		Round, 1/4 Turn, F1960, Hammer - Standard Pack, 6' SS Hose	6	038753392042	11	102
39205		Round, 1/4 Turn, Copper - Contractor Pack, 6' SS Hose	12	038753392059	11	102
39206		Round, 1/4 Turn, F1960 - Contractor Pack, 6' SS Hose	12	038753392066	11	102
39207		Round, 1/4 Turn, Copper, Low Lead - Standard Pack	6	038753392073	11	102
39208		Round, 1/4 Turn, CPVC, Low Lead - Standard Pack	6	038753392080	11	102
39209		Round, 1/4 Turn, F1807, Low Lead - Standard Pack	6	038753392097	11	102
39210		Round, 1/4 Turn, F1960, Low Lead - Standard Pack	6	038753392103	11	102
39211		Round, 1/4 Turn, Copper, Hammer, Low Lead - Standard Pack	6	038753392110	11	102
39212		Round, 1/4 Turn, CPVC, Hammer, Low Lead - Standard Pack	6	038753392127	11	102
39213		Round, 1/4 Turn, F1807, Hammer, Low Lead - Standard Pack	6	038753392134	11	102
39214		Round, 1/4 Turn, F1960 Hammer, Low Lead - Standard Pack	6	038753392141	11	102
39215		Round, Plastic Faceplate	6	038753392158	11	102
39216		Round, Plain Box, No Valves - Standard Pack	6	038753392165	11	102



Product No.	Size	Description	Ctn. Qty.	UPC	Category	Page Number
39220	2" – 3"	160 DFU Sure-Vent AAV 2" x 3" Sch. 40 PVC adapter	6	038753392202	13	118
39221	2" – 3"	160 DFU Sure-Vent AAV 2" x 3" Sch. 40 ABS adapter	6	038753392219	13	118
39223	3" – 4"	500 DFU Sure-Vent AAV 3" x 4" Sch. 40 PVC adapter	6	038753392233	13	118
39224	3" – 4"	500 DFU Sure-Vent AAV 3" x 4" Sch. 40 ABS adapter	6	038753392240	13	118
39225	1.5"	6 DFU Sure-Vent AAV 1-1/2" Tubular adapter (white)	6	038753392257	13	117
39226	1.5"	6 DFU Sure-Vent AAV 1-1/2" Tubular adapter (black)	6	038753392264	13	117
39238	1.5" – 2"	20 DFU Sure-Vent AAV with mechanical adapter	12	038753392387	13	117
39239	1.5"	6 DFU AAV Installation Kit 1-1/2" P-trap, 6" extension tube, PVC threaded adapter & deep box flange	6	038753392394	13	117
39250	1.5" - 2"	6 DFU Sure-Vent AAV PVC Schedule 40, 90° adapter	6	038753392509	13	117
39251	1.5" - 2"	6 DFU Sure-Vent AAV ABS Schedule 40, 90° adapter	6	038753392516	13	117
39252	1.5" - 2"	6 DFU Sure-Vent AAV PVC Schedule 40, 90° adapter	50	038753392523	13	117
39253	1.5" - 2"	6 DFU Sure-Vent AAV ABS Schedule 40, 90° adapter	50	038753392530	13	117
39254	1.5" - 2"	6 DFU Sure-Vent AAV PVC Schedule 40 adapter	6	038753392547	13	117
39255	1.5" - 2"	6 DFU Sure-Vent PVC Schedule 40 Adapter	50	038753392554	13	117
39256	1.5" - 2"	6 DFU Sure-Vent AAV ABS Schedule 40 adapter	6	038753392561	13	117
39260		Box Kit	6	038753392608	13	118
39261		Louvered Faceplate	6	038753392615	13	118
39262		Box Kit with PVC Adapter and 20 DFU AAV	6	038753392622	13	118
39263		Box Kit with ABS Adapter and 20 DFU AAV	6	038753392639	13	118
395128	6"- 12"	Test-Ball® Plug	1	675115395121	18	182
395248	12"- 24"	Test-Ball® Plug	1	675115395244	18	182
3BN		Thumbscrew Sink Basket Strainer, Stainless Steel Body and Basket, Triangular Threaded Flange w/ Three Thumbscrews for Easy Installation and Brass Nuts, Neoprene Stopper	24	041193108593	17	166
401-17-1	1-1/4"	Wall Tube 7.5" - 17 Ga.	10	041193113634	15	134
40110	1 pt.	Cutting Oil - Clear	24	032628401105	5	58
40115	1 qt.	Cutting Oil - Clear	12	032628401150	5	58
40120	1 gal.	Cutting Oil - Clear	6	032628401204	5	58
40125	5 gal.	Cutting Oil - Clear	1	032628401259	5	58
40140	55 gal.	Cutting Oil - Clear	1	032628401402	5	58
401A-17-1	1-1/4"	Wall Tube 10" - 17 Ga.	10	041193113665	15	134
401B-17-1	1-1/4"	Wall Tube 15" - 17 Ga.	10	041193027085	15	134
401C-17-1	1-1/4"	Wall Tube 21" - 17 Ga.	25	041193027092	15	134
401D-17-1	1-1/4"	Wall Tube 33" - 17 Ga.	25	041193027061	15	134
401E-17-1	1-1/4"	Wall Tube 45" - 17 Ga.	20	041193027108	15	134
401F-17-1	1-1/4"	Wall Tube 57" - 17 Ga.	20	041193027115	15	134
402-17-1	1-1/2"	Wall Tube 8.25" - 17 Ga.	10	041193113719	15	134
40210	1 pt.	Cutting Oil - Dark	24	032628402102	5	58
40215	1 qt.	Cutting Oil - Dark	12	032628402157	5	58
40220	1 gal.	Cutting Oil - Dark	6	032628402201	5	58
40225	5 gal.	Cutting Oil - Dark	1	032628402256	5	58
40240	55 gal.	Cutting Oil - Dark	1	032628402409	5	58
4025		2" x 2" Closet Spud	6	041193052971	17	170
4026		2" x 1-1/2" Closet Spud	6	041193113894	17	170
4028		1-1/2" x 1-1/2" Closet Spud	6	041193052988	17	170
4028A		1-1/2" x 1-1/4" Closet Spud	6	041193113900	17	170
4029		1-1/4" x 1-1/4" Closet Spud	6	041193113917	17	170
402A-17-1	1-1/2"	Wall Tube 11.25" - 17 Ga.	10	041193113771	15	134
402B-17-1	1-1/2"	Wall Tube 15" - 17 Ga.	10	041193025814	15	134

NUMERICAL LISTING



Product No.	Size	Description	Ctn. Qty.	UPC	Category	Page Number
402C-17-1	1-1/2"	Wall Tube 21" - 17 Ga.	25	041193026927	15	134
402D-17-1	1-1/2"	Wall Tube 33" - 17 Ga.	25	041193025913	15	134
402E-17-1	1-1/2"	Wall Tube 45" - 17 Ga.	20	041193025661	15	134
402F-17-1	1-1/2"	Wall Tube 57" - 17 Ga.	20	041193025685	15	134
4030		1" x 3/4" Urinal Spud	6	041193113955	17	170
40300	12 oz.	Jet-Stream Penetrating Oil - Aerosol Can	12	032628403000	5	58
4031		1-1/4" x 3/4" Urinal Spud	6	041193113962	17	170
4032		1-1/2" x 3/4" Urinal Spud	6	041193113979	17	170
40404	4 oz.	Lube Oil With Extenda-Spout	24	032628404045	5	58
40501	2 lb.	Duck Butter®	12	032628405011	5	58
40506	8 lb.	Duck Butter®	4	032628405066	5	58
40601	2 oz.	300 Degree Plumbers Grease	24	032628406018	5	58
40610	2 oz.	Plumbers Silicone Grease	24		5	58
41584	6' x 33'	40 mil Black – Roll	1	038753415840	10	89
41588	4' x 50'	40 mil Black – Roll	1	038753415888	10	89
41590	5' x 40'	40 mil Black – Roll	1	038753415901	10	89
41593	4' x 50 ft.	40 mil Gray – Linear Foot, UPC barcode	50	038753415932	10	88
41594	5' x 40 ft.	40 mil Gray – Linear Foot, UPC barcode	40	038753415949	10	88
41596	4' x 50 ft.	40 mil Gray – Roll	1	038753415963	10	88
41597	5' x 40 ft.	40 mil Gray – Roll	1	038753415970	10	88
41598	4' x 50 ft.	30 mil Blue – Roll	1	038753415987	10	88
41599	5' x 40 ft.	30 mil Blue – Roll	1	038753415994	10	88
41600	6' x 50 ft.	30 mil Blue – Roll	1	038753416007	10	88
41601	6' x 50 ft.	40 mil Gray – Roll	1	038753416014	10	88
41602		Dam Corner – 40 mil PVC	48	038753416021	10	89
41604	5' x 100 ft.	40 mil Gray – Roll	1	038753416045	10	88
41606	5' x 100 ft.	40 mil Blue – Roll	1	038753416069	10	88
41611	6' x 100 ft.	40 mil Gray – Roll	1	038753416113	10	88
41612	6' x 100 ft.	30 mil Blue – Roll	1	038753416120	10	88
41614	4' x 50'	40 mil Black – Linear Foot	50	038753416144	10	89
41615	5' x 40'	40 mil Black – Linear Foot	40	038753416151	10	89
41616	4' x 50 ft.	30 mil Blue – Linear Foot	50	038753416168	10	88
41617	5' x 40 ft.	30 mil Blue – Linear Foot	40	038753416175	10	88
41618	6' x 50 ft.	30 mil Blue – Linear Foot	50	038753416182	10	88
41619	6' x 50 ft.	40 mil Gray – Linear Foot	50	038753416199	10	88
41620	5' x 6 ft.	40 mil Gray – Liner Kit	4	038753416205	10	88
41625	4' x 50 ft.	40 mil Gray – Linear Foot	50	038753416250	10	88
41626	5' x 40 ft.	40 mil Gray – Linear Foot	40	038753416267	10	88
41627	5' x 100 ft.	40 mil Gray – Linear Foot	100	038753416274	10	88
41628	6' x 100 ft.	40 mil Gray – Linear Foot	100	038753416281	10	88
41629	6' x 100 ft.	30 mil Blue – Linear Foot	100	038753416298	10	88
41630	5' x 6 ft.	40 mil Gray – Liner Kit w/o dam corners	4	038753416304	10	88
42001	3-1/4"	Carded Stainless Steel	12	038753420011	9	81
42003	4-1/4"	Carded White Plastic – carded	2	038753420035	9	81
42004	4-1/4"	UltraShine® PVD Polished Brass – carded	3	038753420042	9	81
42005	4-1/4"	Stainless Steel – carded	2	038753420059	9	81
4201-15-3		Replacement Basket for 15	1	041193114723	17	166
4201-17-3		Replacement Basket for 17	1	041193114730	17	167
4201-3-3		Replacement Basket for 10	1	041193093967	17	167



Product No.	Size	Description	Ctn. Qty.	UPC	Category	Page Number
4201-3-3		Replacement Basket for 16	1	041193093967	17	167
4201-4-3		Replacement Basket for 11	1	041193114754	17	167
4201-5-3		Replacement Basket for 3784	1	041193114761	17	168
4201-8-1		Replacement Basket for 3785A	1	041193114778	17	168
4201-L7-3		Replacement Basket for L7	1	041193114709	17	165
42010	3-1/4"	Crown Ring Set- Ultrashine® PVD polished brass – Carded	3	038753420103	9	80
42011	3-1/4"	Crown Ring Set – stainless steel – carded	3	038753420110	9	80
42012	6"x 6"	Square Tile Ring – stainless steel – carded	5	038753420127	9	80
42014	4-1/4"	UltraShine® PVD Satin Nickel – carded	3	038753420141	9	81
42015	4-1/4"	UltraShine® PVD Satin Chrome – carded	3	038753420158	9	81
42016	4-1/4"	Biscuit – carded	12	038753420165	9	81
42017	4-1/4"	Rubbed Bronze – carded	3	038753420172	9	81
42018	4-1/4"	Brushed Nickel – carded	3	038753420189	9	81
42019	4-1/4"	White Metal – carded	3	038753420196	9	81
4202-2-3		Rubber Washer For 6, 9, 10, 11, 14, 16, 17, 18, 815B And 816	1	041193114792	17	169
42020	4-1/4"	Antique Bronze – carded	3	038753420202	9	81
42021	6-3/4"	Replacement Strainer, White Plastic	12	038753420219	9	81
4204-00-3		Replacement Basket for DB1000	1	041193022349	17	165
4204-11-3		Replacement Basket for DB711	1	041193022363	17	165
4204-14-3		Replacement Basket for 14 (new style with metal snap-in spring)	1	041193028228	17	166
4204-18-3		Replacement Basket for 18 (new style with metal snap-in spring)	1	041193028235	17	166
4204-20-3		Replacement Basket for DB1120	1	041193022332	17	165
4204-3-3		Replacement Basket for 3BN	1	041193022080	17	166
4204-6-3		Replacement Basket for 6 (new style snap-in metal spring)		041193003683	17	167
4204-L7-3		Replacement Basket for L74 (4-Prongs)	1	041193028242	17	165
42041	4-1/4" x 4-1/4"	Square Tile Ring – Ultrashine® PVD polished brass – carded	1	038753420417	9	80
42042	4-1/4" x 4-1/4"	Square Tile Ring – stainless steel – carded	1	038753420424	9	80
42044	2"	2-part ABS Solvent Weld Shower Drain w/ stainless steel strainer	7	038753420448	9	79
42045	2"	2-part PVC Solvent Weld Shower Drain w/ stainless steel strainer	9	038753420455	9	79
42047	2"	2-part PVC Solvent Weld Shower Drain w/ Ultrashine® polished brass strainer	9	038753420479	9	79
42048	2"	2-part ABS Solvent Weld Shower Drain w/ plastic strainer	7	038753420486	9	79
42049	2"	2-part PVC Solvent Weld Shower Drain w/ plastic strainer	9	038753420493	9	79
42075	2"	101 PNC PVC NO-CALK shower drain w/ plastic strainer	12	038753420752	9	78
42077	2"	101 PNC ABS NO-CALK shower drain w/ plastic strainer	12	038753420776	9	78
42078	2"	101 PS PVC Solvent Weld Shower Drain w/ Ultrashine® polished brass strainer	6	038753420783	9	78
42080	2"	101 PNC PVC NO-CALK shower drain w/ Ultrashine® polished brass strainer	12	038753420806	9	78
42084	2"	101 PNC ABS NO-CALK shower drain w/ stainless steel strainer	12	038753420844	9	78
42086	2"	101 PS ABS Solvent Weld Shower Drain w/ plastic strainer	5	038753420868	9	78
42089	2"	101 PS PVC Solvent Weld Shower Drain w/ plastic strainer	8	038753420899	9	78

NUMERICAL LISTING



Product No.	Size	Description	Ctn. Qty.	UPC	Category	Page Number
42093	2"	101 PS ABS Solvent Weld Shower Drain w/ stainless steel strainer	6	038753420936	9	78
42097	2"	101 PS PVC Solvent Weld Shower Drain w/ stainless steel strainer	6	038753420974	9	78
42099	2"	101 PNC PVC NO-CALK shower drain w/ stainless steel strainer	12	038753420998	9	78
4211		Toilet Tank Cover	1	041193053213	17	171
42116	3-1/4"	Stainless Steel	12	038753421162	9	81
42136	4-1/4"	White Plastic	2	038753421360	9	81
42137	4-1/4"	UltraShine® PVD Polished Brass	3	038753421377	9	81
42138	4-1/4"	Stainless Steel	4	038753421384	9	81
42150	2"	140 NC Brass NO-CALK shower drain w/ stainless steel strainer	12	038753421506	9	78
42156		Rubber caulking gasket to fit 2" Sch. 40 DWV drain pipe in the NO-CALK shower drains	12	038753421568	9	78
42157		Rubber caulking gasket to fit 2" No-hub cast iron pipe in the NO-CALK shower drains	12	038753421575	9	78
42158		Rubber caulking gasket to fit 2" copper DWV drain pipe in the NO-CALK shower drains	12	038753421582	9	78
42159		Rubber caulking gasket to fit 1-1/2" copper DWV drain pipe in the NO-CALK shower drains	12	038753421599	9	78
42163		Rubber caulking gasket to fit 1-1/2" Sch. 40 DWV drain pipe in the NO-CALK shower drains	12	038753421636	9	78
42192	1-1/2"	151 cast iron w/1-1/2" NPT connection	27	038753421926	9	80
42197	2"	151 cast iron w/2" NPT connection	27	038753421971	9	80
42201	2"	151 cast iron w/2" Sch. 40 No-calk connection	29	038753422015	9	80
42202	2" or 3"	PVC drain w/ round stainless steel Snap-Tite strainer	17	038753422022	9	79
42203	2" or 3"	ABS drain w/ round stainless steel Snap-Tite strainer	17	038753422039	9	79
42206	2"	151 cast iron w/2" No Hub connection	30	038753422060	9	80
42210	2" or 3"	ABS drain w/ round stainless steel Screw-Tite strainer	14	038753422107	9	79
42211	2"	151 ABS drain w/2" solvent weld connection	6	038753422114	9	80
42213	2" or 3"	PVC drain w/ round stainless steel Screw-Tite strainer	17	038753422138	9	79
42215	2"	151 cast iron drain top & ABS bottom w/ 2" solvent weld connection	6	038753422152	9	80
42218	2" or 3"	ABS drain w/ round stainless steel Screw-Tite strainer w/ chrome plated brass barrel	19	038753422183	9	79
42219	2" or 3"	PVC drain w/ round stainless steel Screw-Tite strainer w/ chrome plated brass barrel	23	038753422190	9	79
4223		Alloy Rod Flush Lever, Chrome Plated w/Die Cast Spud	25	041193114846	17	171
42235	2" or 3"	PVC drain w/round stainless steel Screw-Tite strainer	22	038753422350	9	80
42236	2" or 3"	ABS drain w/round stainless steel Screw-Tite strainer	22	038753422367	9	80
42237	2" or 3"	PVC drain w/ square stainless steel Snap-Tite strainer	24	038753422374	9	80
42238	2" or 3"	ABS drain w/ square stainless steel Snap-Tite strainer	24	038753422381	9	80
42239		NO-CALK shower drain wrench – carded	4	038753422398	9	78
42245	2" or 3"	PVC drain w/ round stainless steel Snap-Tite Strainer, BARREL and STRAINER ONLY	12	038753422459	9	79
42246	2" or 3"	PVC drain w/ round stainless steel Snap-Tite Strainer, BASE DRAIN, COLLAR and FASTENERS ONLY	12	038753422466	9	79
42247	2" or 3"	PVC drain w/ square stainless steel Snap-Tite Strainer, BARREL and STRAINER ONLY	12	038753422473	9	79
42250	2" or 3"	ABS drain w/square brushed nickel Snap-Tite strainer	24	038753422503	9	80
42251	2" or 3"	PVC drain w/square brushed nickel Snap-Tite strainer	24	038753422510	9	80
42253	3"	Cast iron flange w/o test cap	6	038753422534	9	76
42255	4"	Cast iron flange w/o test cap	6	038753422558	9	76



Product No.	Size	Description	Ctn. Qty.	UPC	Category	Page Number
42256	4"	Cast iron flange w/test cap	6	038753422565	9	76
42257	4" x 4"	Cast iron closet flange w/o test cap	8	038753422572	9	76
4225B		Economy Flush Lever, Chrome Plated Plastic w/ Plastic Spud	25	041193033017	17	171
42358	4"	Stainless Steel	2	038753423586	9	81
42359	4"	UltraShine® PVD Polished Brass	2	038753423593	9	81
42365	2"	180 B Cleanout	12	038753423654	9	84
42366	3"	180 B Cleanout	12	038753423661	9	84
42367	4"	180 B Cleanout	12	038753423678	9	84
42368	6"	180 B Cleanout	12	038753423685	9	84
42369	1-1/2"	185 Brass cleanout plug	12	038753423692	9	84
42370	2"	185 Brass cleanout plug	12	038753423708	9	84
42371	2-1/2"	185 Brass cleanout plug	12	038753423715	9	84
42372	3"	185 Brass cleanout plug	12	038753423722	9	84
42373	3-1/2"	185 Brass cleanout plug	12	038753423739	9	84
42374	4"	185 Brass cleanout plug	12	038753423746	9	84
42380	2" or 3"	PVC drain w/round brass cast grate w/round ring	10	038753423807	9	80
42381	2" or 3"	ABS drain w/round brass cast grate w/round ring	10	038753423814	9	80
42382	2" or 3"	PVC drain w/round brass cast grate w/square ring	10	038753423821	9	80
42383	2" or 3"	ABS drain w/round brass cast grate w/square ring	10	038753423838	9	80
42384	2" or 3"	PVC round nickel cast grate w/round ring	10	038753423845	9	80
42385	2" or 3"	ABS round nickel cast grate w/round ring	10	038753423852	9	80
42386	2" or 3"	PVC round nickel cast grate w/square ring	10	038753423869	9	80
42387	2" or 3"	ABS round nickel cast grate w/square ring	10	038753423876	9	80
42388	2" or 3"	PVC drain w/square stainless steel Snap-Tite strainer	40	038753423883	9	80
42389	2" or 3"	ABS drain w/square stainless steel Snap-Tite strainer	40	038753423890	9	80
42393	2" or 3"	ABS drain w/ square stainless steel Screw-Tite strainer w/chrome plated brass barrel	26	038753423937	9	79
42394	2" or 3"	PVC drain w/ square stainless steel Screw-Tite strainer w/chrome plated brass barrel	26	038753423944	9	79
42396	2" or 3"	ABS drain w/square rubbed bronze Snap-Tite strainer	24	038753423968	9	80
42398	2" or 3"	PVC drain w/square rubbed bronze Snap-Tite strainer	24	038753423982	9	80
42399	2" or 3"	ABS drain w/ round Ultrashine® PVD Screw-Tite polished brass strainer	14	038753423999	9	79
42404	2" or 3"	PVC drain w/ round Ultrashine® PVD Screw-Tite polished brass strainer	17	038753424040	9	79
42720	2"	PVC Floor Sink	1	038753427201	22	227
42721	3"	PVC Floor Sink	1	038753427218	22	227
42722	4"	PVC Floor Sink	1	038753427225	22	227
42723	2"	ABS Floor drain with p-trap and cleanout	6	038753427232	9	83
42724	2"	PVC Floor drain with p-trap and cleanout	6	038753427249	9	83
42725	2"	Backwater valve device	1	038753427256	9	83
42730	2"	Snap-In Stainless Steel Strainer	12	038753427300	9	81
42731	3"	Snap-In Stainless Steel Strainer	12	038753427317	9	81
42732	4"	Snap-In Stainless Steel Strainer	12	038753427324	9	81
42740	1-1/2"	Brass cleanout plug	12	038753427409	9	84
42741	2"	Brass cleanout plug	12	038753427416	9	84
42742	2-1/2"	Brass cleanout plug	12	038753427423	9	84
42743	3"	Brass cleanout plug	12	038753427430	9	84
42744	3-1/2"	Brass cleanout plug	12	038753427447	9	84
42745	4"	Brass cleanout plug	12	038753427454	9	84

NUMERICAL LISTING



Product No.	Size	Description	Ctn. Qty.	UPC	Category	Page Number
42751		Half Top Grate For Floor Sink	1	038753427515	22	227
42752		Three-Quarter Top Grate For Floor Sink	1	038753427522	22	227
42753		Full Top Grate For Floor Sink	1	038753427539	22	227
42754	2"	Bottom Aluminum Dome Strainer	1	038753427546	22	227
42755	3"	Bottom Aluminum Dome Strainer	1	038753427553	22	227
42756	4"	Bottom Aluminum Dome Strainer	1	038753427560	22	227
42757	3/4"	PVC Condensate "P"-trap	24	038753427577	9	86
42758	3/4"	PVC Condensate running trap	24	038753427584	9	86
42759		Wax Free Gasket	12	038753427591	9	77
42777		Moss Bay Replacement Flange	12	038753427775	9	77
42778	3" or 4"	Stainless Steel Closet Flange	12	038753427782	9	77
42780	3"	Stainless steel cover plate	12	038753427805	9	85
42781	4"	Stainless steel cover plate	12	038753427812	9	85
42782	5"	Stainless steel cover plate	12	038753427829	9	85
42783	6"	Stainless steel cover plate	12	038753427836	9	85
42784	8"	Stainless steel cover plate	12	038753427843	9	85
42785	3" or 4"	ABS Snap-In Cleanout Assembly	12	038753427850	9	83
42786	3" or 4"	PVC Snap-In Cleanout Assembly	12	038753427867	9	83
42787	2"	Offset PVC Shower Drain w/ Stainless Steel Strainer	8		9	79
42788	2"	Offset ABS Shower Drain w/ Stainless Steel Strainer	8		9	79
43494	3" x 4"	ABS closet flange w/SS ring w/o test cap	12	038753434940	9	74
43495	3" x 4"	PVC closet flange w/SS ring w/o test cap	12	038753434957	9	74
43498	4"	ABS closet flange w/SS ring w/o test cap	12	038753434988	9	74
43499	4"	PVC closet flange w/SS ring w/o test cap	12	038753434995	9	74
43500	3" or 4"	ABS offset closet flange with metal ring w/o test cap	12	038753435008	9	75
43501	3" or 4"	PVC offset closet flange with metal ring w/o test cap	12	038753435015	9	75
43502	3" or 4"	ABS closet flange w/plastic ring w/o test cap	12	038753435022	9	74
43503	3" or 4"	PVC closet flange w/plastic ring w/o test cap	7	038753435039	9	74
43506	3"	ABS closet flange w/plastic ring w/ test cap	12	038753435060	9	74
43507	3"	PVC closet flange w/plastic ring w/ test cap	12	038753435077	9	74
43508	3"	ABS closet flange w/plastic ring w/o test cap	12	038753435084	9	74
43509	3"	PVC closet flange w/plastic ring w/o test cap	12	038753435091	9	74
43510	3" or 4"	ABS closet flange w/plastic ring, long mounting slots – w/o test cap	12	038753435107	9	75
43511	3" or 4"	PVC closet flange w/plastic ring, long mounting slots – w/o test cap	12	038753435114	9	75
43512	3" or 4"	ABS closet flange w/ metal ring w/o test cap	12	038753435121	9	74
43513	3" or 4"	PVC closet flange w/metal ring w/o test cap	12	038753435138	9	74
43519	1/4"	Closet flange spacer .38	12	038753435190	9	77
43520	4"	ABS closet flange w/ metal ring w/o test cap	12	038753435206	9	74
43521	4"	PVC closet flange w/ metal ring w/o test cap	12	038753435213	9	74
43522	3" or 4"	ABS long pattern closet flange w/plastic ring w/test cap	6	038753435220	9	75
43523	3" or 4"	PVC long pattern closet flange w/plastic ring w/test cap	6	038753435237	9	75
43524	3" or 4"	ABS long pattern closet flange w/plastic ring w/o test cap	6	038753435244	9	75
43525	3" or 4"	PVC long pattern closet flange w/plastic ring w/o test cap	6	038753435251	9	75
43526	3" or 4"	ABS closet flange w/plastic ring, long mounting slots – w/ test cap	12	038753435268	9	75
43527	3" or 4"	PVC closet flange w/plastic ring, long mounting slots – w/ test cap	12	038753435275	9	75
43528	3" or 4"	ABS closet flange w/plastic 2 slot/2 slide ring w/ test cap	12	038753435282	9	75
43529	3" or 4"	PVC closet flange w/plastic 2 slot/2 slide ring w/ test cap	12	038753435299	9	75



Product No.	Size	Description	Ctn. Qty.	UPC	Category	Page Number
43530	3" or 4"	ABS closet flange w/plastic 2 slot/2 slide ring w/o test cap	12	038753435305	9	75
43531	3" or 4"	PVC closet flange w/plastic 2 slot/2 slide ring w/o test cap	12	038753435312	9	75
43532	3" or 4"	ABS long pattern closet flange w/metal ring w/test cap	6	038753435329	9	75
43533	3" or 4"	PVC long pattern closet flange w/metal ring w/test cap	6	038753435336	9	75
43534	3" or 4"	ABS long pattern closet flange w/metal ring w/test cap	6	038753435343	9	75
43535	3" or 4"	PVC long pattern closet flange w/metal ring w/o test cap	6	038753435350	9	75
43538	4"	ABS closet flange replacement	2	038753435381	9	76
43539	4"	PVC closet flange replacement	2	038753435398	9	76
43540	2"	ABS horizontal adjustable urinal flange kit	10	038753435404	9	77
43541	2"	PVC horizontal adjustable urinal flange kit	10	038753435411	9	77
43542	2"	ABS horizontal spigot urinal flange kit	10	038753435428	9	77
43543	2"	PVC horizontal spigot urinal flange kit	10	038753435435	9	77
43548	4"	Over 4" Closet Flange, ABS, w/o test cap	12	038753007267	9	75
43549	4"	Over 4" Closet Flange, PVC, w/ test cap	12	038753435497	9	75
43550	4"	Over 4" Closet Flange, ABS, w/ test cap	12	038753007274	9	75
43551	3" or 4"	Brass Closet Flange Replacement Ring	12	038753007281	9	77
43552	3" or 4"	Easy Tap Closet Flange, ABS w/SS ring	12	038753435527	9	74
43553	3" or 4"	Easy Tap Closet Flange, PVC w/SS ring	12	038753435534	9	74
43555		Galvanized Wood Support Kit	12	038753435558	9	78
43556	3" or 4"	Easy Tap Closet Flange, ABS w/plastic ring	12	038753435565	9	74
43557	3" or 4"	Easy Tap Closet Flange, PVC w/plastic ring	12	038753435572	9	74
43558	3" or 4"	Easy Tap Closet Flange, ABS w/metal ring	12	038753435589	9	74
43559	3" or 4"	Easy Tap Closet Flange, PVC w/metal ring	12	038753435596	9	74
43560	2"	ABS Snap-In Drain	1	038753435602	9	82
43561	2"	PVC Snap-In Drain	6	038753435619	9	82
43562	3"	ABS Snap-In Drain w/ 3-1/2" Stainless Steel Strainer	3	038753435626	9	82
43563	3"	PVC Snap-In Drain w/ 3-1/2" Stainless Steel Strainer	3	038753435633	9	82
43564	3"	ABS Snap-In Drain	2	038753435640	9	82
43565	3"	PVC Snap-In Drain	2	038753435657	9	82
43566	4"	ABS Snap-In Drain w/ 4" Stainless Steel Strainer	8	038753435664	9	82
43567	4"	PVC Snap-In Drain w/ 4" Stainless Steel Strainer	9	038753435671	9	82
43568	4"	ABS Snap-In Drain	6	038753435688	9	82
43569	4"	PVC Snap-In Drain	12	038753435695	9	82
43570	2"	ABS Snap-In Drain Outlet Cover	6	038753435701	9	82
43571	2"	PVC Snap-In Drain Outlet Cover	6	038753435718	9	82
43572	3"	ABS Snap-In Drain Outlet Cover	2	038753435725	9	82
43573	3"	PVC Snap-In Drain Outlet Cover	2	038753435732	9	82
43578	2" or 3"	ABS general purpose drain w/4" stainless steel Screw-Tite strainer	12	038753435787	9	82
43579	2" or 3"	PVC general purpose drain w/4" stainless steel Screw-Tite strainer	12	038753435794	9	82
43580	2" or 3"	ABS short general purpose drain w/ 4" stainless steel Screw-Tite strainer	18	038753435800	9	82
43581	2" or 3"	PVC short general purpose drain w/ 4" stainless steel Screw-Tite strainer	5	038753435817	9	82
43582	3" or 4"	ABS general purpose drain w/5" stainless steel Screw-Tite strainer	12	038753435824	9	82
43583	3" or 4"	PVC general purpose drain w/5" stainless steel Screw-Tite strainer	12	038753435831	9	82
43584	3"	Spigot Fit Closet Flange, ABS, w/ plastic ring	12	038753435848	9	76

NUMERICAL LISTING



Product No.	Size	Description	Ctn. Qty.	UPC	Category	Page Number
43585	3"	Spigot Fit Closet Flange, PVC, w/ plastic ring	12	038753435855	9	76
43586	4"	Spigot Fit Closet Flange, ABS, w/ plastic ring	12	038753435862	9	76
43587	4"	Spigot Fit Closet Flange, PVC, w/ plastic ring	12	038753435879	9	76
43596	2" or 3"	Four-Way Area Drain, PVC	10	038753435961	9	83
43598	3" or 4"	ABS general purpose drain w/ 5" brass grate and metal ring	12	038753435985	9	82
43599	3" or 4"	PVC general purpose drain w/ 5" brass grate and metal ring	12	038753435992	9	82
43600	3" or 4"	ABS general purpose drain w/ 5" nickel alloy grate	12	038753436005	9	82
43601	3" or 4"	PVC general purpose drain w/ 5" nickel alloy grate	12	038753436012	9	82
43610	3" or 4"	Easy Tap Closet Flange, ABS w/plastic ring	24	038753436104	9	74
43611	3" or 4"	Easy Tap Closet Flange, ABS w/SS ring	24	038753436111	9	74
43612	3" or 4"	Easy Tap Closet Flange, PVC w/plastic ring	24	038753436128	9	74
43613	3" or 4"	Easy Tap Closet Flange, PVC w/SS ring	24	038753436135	9	74
43621	4"	Over 4" Closet Flange, PVC, w/o test cap	12	038753436210	9	75
43632	3" or 4"	ABS 9" x 9" bell trap drain	7	038753436326	9	83
43633	3" or 4"	PVC 9" x 9" bell trap drain	7	038753436333	9	83
43636	1-1/2"	ABS 6" x 6" bell trap drain	5	038753436364	9	83
43637	1-1/2"	PVC 6" x 6" bell trap drain	5	038753436371	9	83
43640	1-1/2"	ABS 6" x 6" utility drain	14	038753436401	9	83
43641	1-1/2"	PVC 6" x 6" utility drain	15	038753436418	9	83
43645		Closet Flange Spacer Kit	12	038753436456	9	77
43646	1/2"	Closet flange spacer .95	12	038753436463	9	77
43650	4"	ABS Twist-N-Set closet flange	2	038753436500	9	76
43651	4"	PVC Twist-N-Set closet flange	2	038753436517	9	76
43653	4"	Cast Iron Twist-N-Set closet flange	2	038753436531	9	76
43654	3"	PVC Twist-N-Set closet flange	2	038753436548	9	76
43655	3"	ABS Twist-N-Set closet flange	2	038753436555	9	76
43710	2" or 3"	ABS Snap-In Cleanout Assembly	12	038753437101	9	83
43711	2" or 3"	PVC Snap-In Cleanout Assembly	12	038753437118	9	83
43730	3"	ABS Snap-In Cleanout Assembly	12	038753437309	9	84
43731	3"	PVC Snap-In Cleanout Assembly	12	038753437316	9	84
43732	4"	ABS Snap-In Cleanout Assembly	12	038753437323	9	84
43733	4"	PVC Snap-In Cleanout Assembly	12	038753437330	9	84
43764	2.33"	ABS Replacement Plug for the 3" and the 2" or 3" cleanout assemblies	6	038753437644	9	84
43765	2.33"	PVC Replacement Plug for the 3" and the 2" or 3" cleanout assemblies	6	038753437651	9	84
43766	3-1/2"	ABS Replacement Plug for the 4" regular and the 3" Hub cleanout assemblies	6	038753437668	9	84
43767	3-1/2"	PVC Replacement Plug for the 4" regular and the 3" Hub cleanout assemblies	6	038753437675	9	84
43788	3" x 2"	ABS saddle tee kit	6	038753437880	9	86
43789	3" x 2"	PVC saddle tee kit	6	038753437897	9	86
43790	4" x 2"	ABS saddle tee kit	6	038753437903	9	86
43791	4" x 2"	PVC saddle tee kit	6	038753437910	9	86
43792	4" x 3"	ABS saddle tee kit	6	038753437927	9	86
43793	4" x 3"	PVC saddle tee kit	6	038753437934	9	86
43794	4" x 4"	ABS saddle tee kit	6	038753437941	9	86
43795	4" x 4"	PVC saddle tee kit	6	038753437958	9	86
43796		Gasket for tapping into cast iron soil pipe	12	038753437965	9	86



Product No.	Size	Description	Ctn. Qty.	UPC	Category	Page Number
43804	3" or 4"	PVC offset closet flange with metal ring w/o test cap	16	038753438047	9	75
43805	3" or 4"	Mushroom Vent Cap	12	038753438054	9	86
43815	3" or 4"	ABS 45° closet flange w/plastic ring w/o test cap	6	038753438153	9	76
43816	3" or 4"	PVC 45° closet flange w/plastic ring w/o test cap	6	038753438160	9	76
43819		Inside 2", PVC	12		9	83
43820		Inside 2", ABS	12		9	83
43821		Replacement Plug for Inside 2" Cleanout, PVC	6		9	83
43822		Replacement Plug for Inside 2" Cleanout, ABS	6		9	83
43861	4"	Stainless Steel – carded	3	038753438610	9	81
43862	4"	UltraShine® PVD Polished Brass – carded	3	038753438627	9	81
43900	3"	PVC backwater valve	4	038753439006	9	85
43901	3"	ABS backwater valve	4	038753439013	9	85
43904	4"	PVC backwater valve	2	038753439044	9	85
43905	4"	ABS backwater valve	2	038753439051	9	85
43908	6"	PVC backwater valve	1	038753439082	9	85
43909	6"	ABS backwater valve	1	038753439099	9	85
43915	3"	PVC threaded cap	1	038753439150	9	85
43916	3"	ABS threaded cap	1	038753439167	9	85
43918	4"	PVC threaded cap	1	038753439179	9	85
43919	4"	ABS threaded cap	1	038753439198	9	85
43921	6"	PVC threaded cap	1	038753439211	9	85
43922	6"	ABS threaded cap	1	038753439228	9	85
43924	3"	PVC flapper w/ "O" ring	1	038753439242	9	85
43925	3"	ABS flapper w/ "O" ring	1	038753439259	9	85
43927	4"	PVC flapper w/ "O" ring	1	038753439273	9	85
43928	4"	ABS flapper w/ "O" ring	1	038753439280	9	85
43929	6"	PVC flapper w/ "O" ring	1	038753439297	9	85
43930	6"	ABS flapper w/ "O" ring	1	038753439303	9	85
43LF		5' Aluminum Shower Rod, Less Flanges	50	041193114976	17	178
44016	3-1/4"	Antique Brass	2	038753440163	9	81
4424	Gallon	ABS Medium Black	6	083675044241	1	24
4436S	32 oz.	ABS Medium Black	12	083675044364	1	24
4446S	16 oz.	ABS Medium Black	24	083675044463	1	24
4456S	8 oz.	ABS Medium Black	24	083675044562	1	24
4466S	4 oz.	ABS Medium Black	24	083675044661	1	24
4497-1		Unit (1-1/2" NPT), Chrome	1	041193022387	16	163
4497X-1		Tap-Tap Replacement Cartridge, Brass, Chrome 3/8"-16 Stem	1	041193022394	16	163
4502-1		Faceplate, Two Hole, Chrome Plated w/ Screws	1	041193115225	16	163
4503-1		Faceplate, Trip Lever, Chrome Plated w/ Screws	1	041193115263	16	163
4504-1		Faceplate, One Hole, Chrome Plated w/ Screw (46250)	1	041193010445	16	163
4509-3		Washer for Top EII, Blue Foam (Oatey #46208)	1	041193115348	16	163
45210	1 gal.	Black Magic™ Asphalt Paint	6	032628452107	4	53
45304	14 oz.	Cream Hand Cleaner - Waterless	12	032628453043	5	57
45314	15 oz.	Hercules For Hands™ - Lemon Lotion Hand Cleaner - Flip Top Cap	12	032628453142	5	57
45316	1 gal.	Hercules For Hands™ - Lemon Lotion Hand Cleaner - Pump Dispenser	4	032628453166	5	57
45325	15 fl. oz.	Hercules For Hands™ - Pumice Lotion Hand Cleaner - Flip Top Cap	12	032628453258	5	57



Product No.	Size	Description	Ctn. Qty.	UPC	Category	Page Number
45328	1 gal.	Hercules For Hands™ - Pumice Lotion Hand Cleaner - Pump Dispenser	4	032628453289	5	57
45333	12" x 10"	Hercules For Hands™ - Pre-Moistened Towels - Dispenser Tub Of 70 Towels	6	032628453333	5	57
45333T	12" x 10"	Hercules For Hands™ - Pre-Moistened Towels - POP Display Of 30 Tubs	30	032628453333	5	57
45337	12" x 10"	Hercules For Hands™ - Pre-Moistened Towels - Thin Tub -25 Per Tub	6	032628453371	5	57
4534-3		Bottom Strainer (1-1/4")		041193115560	16	163
4534C-3		Cast Bottom Strainer (1-1/2")	1	041193115577	16	163
4537-1		Strainer Cover, Chrome w/ Screw, Stainless Steel	1	041193115584	16	163
4538-3		Drain Plug w/ Fulcrum Linkage, Nut & Plug Seat, Chrome	1	041193115614	16	163
45400	20 oz.	Iron Ike® Rust Remover	12	032628454002	6	61
45403	5 lb.	Iron Ike® Rust Remover	6	032628454033	6	61
4547-1		Uni-Lift Plug and Seat (1-1/4" NPT), Chrome	1	041193115676	16	163
45801	8 oz.	Megabubble® Leak Detector - With Dauber	24	032628458017	2	37
45802	32 oz.	Megabubble® Leak Detector - With Sprayer	12	032628458024	2	37
45803	1 gal.	Megabubble® Leak Detector - Refill Container	4	032628458031	2	37
45804	16 oz.	Megabubble® Leak Detector - With Sprayer - Display Pack	12	032628458048	2	37
4597-1		Drain Assembly, Uni-Lift 1-1/2" Chrome, 3/8"x 16 Stem	1	041193022172	16	163
4597X-1		Plug Only, Uni-Lift 1-1/2", Chrome 3/8"-16 Stem	1	041193020598	16	163
45C		5' Aluminum Shower Rod, w/ Flanges	6	041193044051	17	178
46206		Test Plug Kit	10	038753462066	16	162
46207		Conversion Bar Kit	10	038753462073	16	162
46266	4-1/4"	Stainless Steel – carded	3	038753462660	9	81
46267	4-1/4"	Rubbed Bronze – carded	3	038753462677	9	81
46268	4-1/4"	Brushed Nickel – carded	3	038753462684	9	81
47700		PVC Plastic Underdeck Clamp Kit	1	038753477008	22	223
47701		ABS Plastic Receiver Pan	1	038753477015	22	223
48324	16 fl. oz.	Gray Pipe Joint Compound	24	038753483245	2	33
50-3	1-1/2" x 16"	Center To Center, LA Code - 20 Ga., Unfinished	10	041193116031	15	135
50192	1/2 lb.	50/50 Wire Solder	10	038753501925	3	41
50193	1/2 lb.	40/60 Acid Core Wire Solder	10	038753501932	3	41
50194	1/2 lb.	60/40 Rosin Core	10	038753501949	3	42
50200	1"	Plastic Pipe Cement Brush - Natural Bristle	36	032628502000	1	29
50310	8"	Pipe Dope Brush - Wood Handle	144	032628503106	2	37
50350	NA	High Intensity UV Flashlight	1		1	19
50360	NA	Pocket Keychain UV Flashlight	5		1	19
50429	1/2 lb.	40/60 Acid Core Wire Solder	12	038753504292	3	41
50490	1/2 lb.	50/50 Wire Solder	12	038753504902	3	41
505-1	1-1/4" x 10"	Semi-Cast P-Trap w/ Cleanout 17 Ga. w/ Shallow Flange & Zinc Nuts	12	041193007896	15	141
50678	1/2 lb.	60/40 Rosin Core	12	038753506784	3	42
50683	8 oz.	Safe-Flo Silver Plumbing Kit	12	038753506838	3	39
50684	8 oz.	Safe-Flo Silver Plumbing Kit	12	038753506845	3	39
50691	8 oz.	Safe-Flo/H-205 Flux Solder Kit	12	038753506913	3	39
50692	1 oz.	Safe-Flo/H-2095 Flux Solder Kit	12	038753506920	3	39
507-1	1-1/4" x 12"	Semi-Cast P-Trap w/ Cleanout 17 Ga. w/ Deep Flange & Brass Nuts	12	041193116932	15	141
509-1	1-1/2" x 11"	Semi-Cast P-Trap w/ Cleanout 17 Ga. w/ Shallow Flange & Zinc Nuts	12	041193007889	15	141



Product No.	Size	Description	Ctn. Qty.	UPC	Category	Page Number
510-1	1-1/2" x 12"	Semi-Cast P-Trap w/ Cleanout 17 Ga. w/ Deep Flange & Brass Nuts	12	041193117972	15	141
5126		1/8" NPT Bright Plated Loose Key Coin Air Vent	25	041193049056	17	171
5130		1/4" NPT Bright Finish Vent Key	20	041193049063	17	171
515FLX-3	3/8" - 1/2"	Supply Line/Stop Cover Trap	1	041193079305	15	142
515FST-3	1-1/4" - 1-1/2"	Offset Cover Trap	1	041193079312	15	142
515KIT-3		Cover Trap Kit, (1) P-Trap & (2) Supply Line Covers	1	041193079282	15	142
515KOF-3		Cover Trap Kit, (1) P-Trap, (2) Supply Line Covers & (1) Offset Cover	1	041193016126	15	142
515TRP-3	1-1/4" - 1-1/2"	P-Trap Cover	1	041193079299	15	142
5236		1/4" NPT Straight Type Steel Siphon	12	041193119247	17	171
53010	1 oz.	50/50 Wire Solder	12	038753530109	3	41
53011	1.5 oz.	40/60 Acid Core Wire Solder	12	038753530116	3	41
53012	1 oz.	40/60 Rosin Core	12	038753530123	3	42
53013	1 oz.	Hobby Solder Kit	12	038753530130	3	39
53014	1/4 lb.	50/50 Wire Solder	12	038753530147	3	41
53015	1/4 lb.	40/60 Acid Core Wire Solder	12	038753530154	3	41
53016	1/4 lb.	40/60 Rosin Core	12	038753530161	3	42
53017	1.7 oz.	No. 5 Flux w/ Brush – Carded	12	038753530178	3	43
53019	1-1/2 oz.	Instant Solder	12	038753530192	3	40
53023	1 oz.	60/40 Rosin Core	12	038753530239	3	42
53026	1 oz.	95/5 Wire Solder	12	038753530260	3	40
53027	1/4 lb.	95/5 Wire Solder	12	038753530277	3	40
53061	1 oz.	Safe-Flo Silver Wire Solder	12	038753530611	3	39
53062	1/4 lb.	Safe-Flo Silver Wire Solder	12	038753530628	3	39
53064	1/2 lb.	Safe-Flo Silver Wire Solder	12	038753530642	3	39
53067	1.7 oz.	H-205 Water Soluble Paste Flux – Carded	12	038753530673	3	43
53068	1.7 oz.	H-2095 Water Soluble Tinning Flux – Carded	12	038753530680	3	43
53170	1/2 lb.	95/5 Acid Core Wire Solder	10	038753531700	3	40
53171	1/2 lb.	95/5 Rosin Core Wire Solder	10	038753531717	3	40
53172	1 lb.	95/5 Acid Core Wire Solder	10	038753531724	3	40
53173	1 lb.	95/5 Rosin Core Wire Solder	10	038753531731	3	40
53174	1.5 oz.	95/5 Acid Core Wire Solder	12	038753531748	3	40
53175	1 oz.	95/5 Rosin Core Wire Solder	12	038753531755	3	40
53176	1/4 lb.	95/5 Acid Core Wire Solder	12	038753531762	3	40
53177	1/4 lb.	95/5 Rosin Core Wire Solder	12	038753531779	3	40
53180	1 oz.	Safe-Flo Silver Wire Solder	12	038753531809	3	39
53179	1 oz.	95/5 Wire Solder	12	038753531796	3	40
53182	1 oz.	50/50 Wire Solder	12	038753531823	3	41
53183	1 oz.	40/60 Acid Core Wire Solder	12	038753531830	3	41
53184	1 oz.	40/60 Rosin Core	12	038753531847	3	42
53185	.8 oz.	60/40 Rosin Core		038753531854	3	42
53186	1 oz.	Hobby Solder Kit	12	038753531861	3	39
53186	1/4 lb.	Safe-Flo Silver Wire Solder	12	038753531865	3	39
53189	1/4 lb.	95/5 Wire Solder	12	038753531892	3	40
53190	1/4 lb.	95/5 Rosin Core Wire Solder	12	038753531908	3	40
53191	1/4 lb.	50/50 Wire Solder	12	038753531915	3	41
53192	1/4 lb.	40/60 Acid Core Wire Solder	12	038753531922	3	41
53193	1/4 lb.	40/60 Rosin Core	12	038753531939	3	42
53195	1/2 lb.	Safe-Flo Silver Wire Solder	12	038753531953	3	39

NUMERICAL LISTING



Product No.	Size	Description	Ctn. Qty.	UPC	Category	Page Number
53196	1/2 lb.	40/60 Acid Core Wire Solder	12	038753531960	3	41
53200	1.7 oz.	No. 5 Flux w/ Brush – Carded	12	038753532004	3	43
53201	1.7 oz.	No. 95 Tinning Flux – Lead Free – Carded	12	038753532011	3	43
53202	1-1/2 oz.	Instant Solder	12	038753532028	3	40
5340		1/2" Tube	12	041193054425	17	175
5340H		5/8" O.D. .5 Nom	12	041193102331	17	175
5340P		1/2" Nom	12	041193119940	17	176
5341		3/4" Tube	12	041193119957	17	175
5341H		7/8" O.D. 3/4" Nom	12	041193119964	17	175
5341P		3/4" Nom	12	041193119971	17	176
5342		1-1/8" O.D.	12	041193119988	17	175
5342H		1-1/8" O.D. 3/4"	12	041193102348	17	175
5342P		1" Nom	12	041193119995	17	176
5343		1-3/8" O.D.	12	041193120021	17	175
5343H		1-3/8" O.D. 1-1/4"	12	041193102355	17	175
5344		1 1/2" Nom	12	041193120045	17	175
5344H		1-5/8" O.D. 1.5	12	041193102362	17	175
5345H		2-1/8" O.D. 2 Nom	12	041193120069	17	175
5346H		2-5/8" O.D. 2.5	12	041193120106	17	175
5347H		3-1/8" O.D. 3 Nom	12	041193120137	17	175
5350		3/8" IPS	12	041193054456	17	175
5350H		3/8" IPS	12	041193120144	17	175
5351		1/2" IPS	12	041193054463	17	175
5351H		1/2" IPS	12	041193120175	17	175
5351P		1/2" IPS	12	041193120182	17	176
5352		3/4" IPS	12	041193054470	17	175
5352H		3/4" IPS	12	041193120199	17	175
5352P		3/4" IPS	12	041193120205	17	176
5353		1" IPS	12	041193054487	17	175
5353H		1" IPS	20	041193120212	17	175
5353P		1" IPS	12	041193120229	17	176
5354		1-1/4" IPS	12	041193054494	17	175
5354H		1-1/4" IPS	12	041193120236	17	175
5354P		1-1/4" IPS	12	041193120243	17	176
5355		1-1/2" IPS	12	041193054500	17	175
5355H		1.5" IPS	12	041193120250	17	175
5355P		1-1/2" IPS	12	041193120267	17	176
5356		2" IPS	12	041193102379	17	175
5356H		2" IPS	12	041193120274	17	175
5356P		2" IPS	12	041193120281	17	176
5357H		2.5" IPS	12	041193120298	17	175
5358H		3" IPS	12	041193120304	17	175
5359H		3.5" IPS	12	041193120311	17	175
5360H		4" IPS	12	041193120328	17	175
5507-1	1-1/4" x 12"	Semi-Cast P-Trap w/ Cleanout 17 Ga. w/ Deep Flange & Brass Nuts, White Box	12	041193018654	15	141
5507A-1	1-1/4" x 15"	Semi-Cast P-Trap w/ Cleanout 17 Ga. w/ Deep Flange & Brass Nuts	12	041193018661	15	141
5510-1	1-1/2" x 12"	Semi-Cast P-Trap w/ Cleanout 17 Ga. w/ Deep Flange & Brass Nuts, White Box	12	041193018678	15	141



Product No.	Size	Description	Ctn. Qty.	UPC	Category	Page Number
5510A-1	1-1/2" x 15"	Semi-Cast P-Trap w/ Cleanout 17 Ga. w/ Deep Flange & Brass Nuts	12	041193018685	15	141
58368		Smoke Bomb Holding Cage	1		20	194
59		26" x 45" Chrome Plated Brass Add- On Shower Frame w/Wall & Ceiling Supports. 3/4" Diameter	1	041193056368	17	178
6		Super 6 Sink Basket Strainer, Stainless Steel Body and Basket, Rubber Stopper w/ Metal Post, Extra Wide Locknut, Extra Thick Washer	24	041193054531	17	167
60003	4 oz.	PVC - Clear - Dauber In Cap	12	032628600034	1	17
60013	8 oz.	PVC - Clear - Dauber In Cap	12	032628600133	1	17
60015	16 oz.	PVC - Clear - Jumbo Dauber In Cap	12	032628600157	1	17
60020	32 oz.	PVC - Clear - Jumbo Dauber In Cap	12	032628600201	1	17
60025	1 gal.	PVC - Clear	6	032628600256	1	17
60043	4 oz.	PVC - Clear - Dauber In Cap	12	032628600430	1	17
60053	8 oz.	PVC - Clear - Dauber In Cap	12	032628600539	1	17
60055	16 oz.	PVC - Clear - Jumbo Dauber In Cap	12	032628600553	1	17
60060	32 oz.	PVC - Clear - Jumbo Dauber In Cap	12	032628600607	1	17
60065	1 gal.	PVC - Clear	6	032628600652	1	17
60103	4 oz.	PVC - Clear - Dauber In Cap	24	032628601031	1	17
60113	8 oz.	PVC - Clear - Jumbo Dauber In Cap	12	032628601130	1	17
60115	16 oz.	PVC - Clear - Jumbo Dauber In Cap	12	032628601154	1	17
60120	16 oz.	PVC - Clear - Jumbo Dauber In Cap	12	032628601208	1	17
60125	1 gal.	PVC - Clear	12	032628601253	1	17
60142	8 oz.	Below Zero PVC - Clear - Dauber In Cap	24	032628601420	1	17
60145	16 oz.	Below Zero PVC - Clear - Jumbo Dauber In Cap	12	032628601451	1	17
60148	32 oz.	Below Zero PVC - Clear - Jumbo Dauber In Cap	12	032628601482	1	17
60155	8 oz.	PVC - Clear - Dauber In Cap	24	032628601550	1	18
60160	16 oz.	PVC - Clear - Jumbo Dauber In Cap	12	032628601604	1	18
60165	32 oz.	PVC - Clear - Jumbo Dauber In Cap	12	032628601659	1	18
60210	8 oz.	PVC - Gray - Dauber In Cap	24	032628602106	1	18
60215	16 oz.	PVC - Gray - Jumbo Dauber In Cap	12	032628602151	1	18
60220	32 oz.	PVC - Gray - Jumbo Dauber In Cap	12	032628602205	1	18
60225	1 gal.	PVC - Gray	6	032628602250	1	18
60253	8 oz.	Wet Set PVC - Aqua Blue - Dauber In Cap	12	032628602533	1	18
60255	16 oz.	Wet Set PVC - Aqua Blue - Jumbo Dauber In Cap	12	032628602557	1	18
60260	32 oz.	Wet Set PVC - Aqua Blue - Jumbo Dauber In Cap	12	032628602601	1	18
60265	1 gal.	Wet Set PVC - Aqua Blue	6	032628602656	1	18
60303	4 oz.	CPVC Cement - Orange - Dauber In Cap	12	032628603035	1	18
60313	8 oz.	CPVC Cement - Orange - Dauber In Cap	12	032628603134	1	18
60315	16 oz.	CPVC Cement - Orange - Jumbo Dauber In Cap	12	032628603158	1	18
60320	16 oz.	CPVC Cement - Orange - Jumbo Dauber In Cap	12	032628603202	1	18
60353	4 oz.	CPVC Gold - Dauber In Cap	12	032628603530	1	19
60358	8 oz.	CPVC Gold - Dauber In Cap	12	032628603585	1	19
60360	16 oz.	CPVC Gold - Dauber In Cap	12	032628603608	1	19
60365	32 oz.	CPVC Gold - Dauber In Cap	12	032628603653	1	19
60403	4 oz.	Primer - Purple - Dauber In Cap	12	032628604032	1	19
60413	8 oz.	Primer - Purple - Dauber In Cap	12	032628604131	1	19
60415	16 oz.	Primer - Purple - Jumbo Dauber In Cap	12	032628604155	1	19
60420	32 oz.	Primer - Purple - Jumbo Dauber In Cap	12	032628604209	1	19
60425	1 gal.	Primer - Purple	6	032628604254	1	19
60445	16 oz.	Unpurple Primer For PVC And CPVC - Jumbo Dauber In Cap	12	032628604452	1	19

NUMERICAL LISTING



Product No.	Size	Description	Ctn. Qty.	UPC	Category	Page Number
60447	32 oz.	Unpurple Primer For PVC And CPVC - Jumbo Dauber In Cap	12	032628604476	1	19
60453	4 oz.	PVC Primer - Clear - Dauber In Cap	12	032628604537	1	19
60458	8 oz.	PVC Primer - Clear - Dauber In Cap	12	032628604582	1	19
60460	16 oz.	PVC Primer - Clear - Jumbo Dauber In Cap	12	032628604605	1	19
60465	32 oz.	PVC Primer - Clear - Jumbo Dauber In Cap	12	032628604650	1	19
60470	1 gal.	PVC Primer - Clear	6	032628604704	1	19
60473	4 oz.	PVC Primer-Purple- Dauber In Cap	12		1	19
60483	8 oz.	PVC Primer-Purple- Dauber In Cap	12		1	19
60485	16 oz.	Cleaner - Clear - Jumbo Dauber In Cap	12		1	19
60490	32 oz.	PVC Primer-Purple- Jumbo Dauber In Cap	12		1	19
60495	Gallon	PVC Primer- Purple	6		1	19
60503	4 oz.	ABS - Black - Dauber In Cap	12	032628605039	1	20
60513	8 oz.	ABS - Black - Dauber In Cap	12	032628605138	1	20
60515	16 oz.	ABS - Black - Jumbo Dauber In Cap	12	032628605152	1	20
60520	32 oz.	ABS - Black - Jumbo Dauber In Cap	12	032628605206	1	20
60525	1 gal.	ABS - Black	6	032628605251	1	20
60555	8 oz.	ABS/PVC Transition - Green - Dauber In Cap	24	032628605558	1	20
60560	16 oz.	ABS/PVC Transition - Green - Jumbo Dauber In Cap	12	032628605602	1	20
60652	4 oz.	Cleaner - Clear - Dauber In Cap	12	032628606524	1	20
60659	8 oz.	Cleaner - Clear - Dauber In Cap	12	032628606593	1	20
60664	16 oz.	Cleaner - Clear - Jumbo Dauber In Cap	12	032628606647	1	20
60667	32 oz.	Cleaner - Clear - Jumbo Dauber In Cap	12	032628606678	1	20
60703	4 oz.	Multi-Purpose - Milky - Dauber In Cap	12	032628607033	1	20
60713	8 oz.	Multi-Purpose - Milky - Dauber In Cap	12	032628607132	1	20
60715	16 oz.	Multi-Purpose - Milky - Jumbo Dauber In Cap	12	032628607156	1	20
60720	32 oz.	Multi-Purpose - Milky - Jumbo Dauber In Cap	12	032628607200	1	20
60725	1 gal.	Multi-Purpose - Milky	6	032628607255	1	20
61028		Smoke Fluid Conversion Kit From Smoke Bomb Honda Engine 2006 And Newer	1		20	194
6200C		1/8" x 24" Graphite Twist Packing w/individual strand - Bagged	48	041193023056	17	172
6200C		1/8" x 24" Graphite Twist Packing for Faucets, Valves & Pumps	48	041193023056	17	176
6236S	32 oz.	Multi Purpose Regular Clear	12	083675062368	1	24
6246S	16 oz.	Multi Purpose Regular Clear	24	083675062467	1	24
6256S	8 oz.	Multi Purpose Regular Clear	24	083675062566	1	24
6266S	4 oz.	Multi Purpose Regular Clear	24	083675062665	1	24
650-1	1-1/4"	J-Bend - 20 Ga.	10	041193005663	15	133
651-1	1-1/2"	J-Bend - 20 Ga.	10	041193005670	15	133
652-1	1-1/4"	J-Bend - 17 Ga.	10	041193054593	15	133
653-1	1-1/2"	J-Bend - 17 Ga.	10	041193122049	15	134
654-1	1-1/2"	Sink J-Bend w/ Ground Joint - 20 Ga.	10	041193122094	15	134
654W-1	1-1/2"	Sink J-Bend w/ Washer Joint - 20 Ga.	10	041193054616	15	134
655-1	1-1/2"	Sink J-Bend w/ Ground Joint - 17 Ga.	10	041193122100	15	134
655BN-1	1-1/2"	Sink J-Bend w/ Ground Joint - 17 Ga. w/ Brass Nuts	10	041193122117	15	134
655BN-3	1-1/2"	Sink J-Bend w/ Ground Joint - 17 Ga. w/ Brass Nuts, Unfinished	10	041193122124	15	134
655W-1	1-1/2"	Sink J-Bend w/ Washer Joint - 17 Ga.	10	041193054623	15	134
656W-1	1-1/4"	Sink J-Bend w/ Washer Joint - 20 Ga.	10	041193122131	15	134
6T		Same as Above w/ 4" Chrome Plated Tailpiece	24	041193121288	17	167
700-1	1-1/4"	P-Trap - 20 Ga.	25	041193005717	15	131



Product No.	Size	Description	Ctn. Qty.	UPC	Category	Page Number
70002	2"	PVC Base	1	038753700021	22	223
70003	3" or 4"	PVC Base	1	038753700038	22	223
70004	4"	PVC Base	1	038753700045	22	223
70006	6"	PVC Base	1	038753700069	22	223
70007	3" or 4"	PVC Pipe Fit Drain Base	1	038753700076	22	224
70008	4"	PVC Pipe Fit Drain	1	038753700083	22	224
70009	4"	PVC Hub Fit Drain	1	038753700090	22	224
700A-1	1-1/4"	P-Trap - 20 Ga. w/ 10" Wall Tube	25	041193122735	15	131
700BN-1	1-1/4"	P-Trap - 20 Ga. w/ Brass Nuts	25	041193122759	15	131
700DF-1	1-1/4"	P-Trap - 20 Ga. w/ Deep Flange	25	041193102416	15	131
700DFBN-1	1-1/4"	P-Trap - 20 Ga. w/ Deep Flange & Brass Nuts	25	041193122773	15	131
700R-1	1-1/4"	Repair Trap - 20 Ga.	10	041193122780	15	132
701-1	1-1/4"	P-Trap - 17 Ga.	25	041193006233	15	131
701A-1	1-1/4"	P-Trap - 17 Ga. w/ 10" Wall Tube	25	041193122827	15	131
701ADF-1	1-1/4"	P-Trap - 17 Ga. w/ Deep Flange 10" Wall Tube	25	041193122834	15	131
701BN-1	1-1/4"	P-Trap - 17 Ga. w/ Brass Nuts	25	041193122841	15	131
701DF-1	1-1/4"	P-Trap - 17 Ga. w/ Deep Flange	25	041193122865	15	131
701DFBN-1	1-1/4"	P-Trap - 17 Ga. w/ Deep Flange & Brass Nuts	25	041193122889	15	131
701G-1	1-1/4"	P-Trap - 17 Ga. w/ Ground Joint	25	041193122896	15	131
702-1	1-1/2"	P-Trap - 20 Ga.	25	041193005724	15	131
702007		Chrome, Plastic Spud And Nut, Round Brass Arm - 8"	100	041193123060	17	171
702034		Chrome, Zinc spud and Nut, Round Brass Arm - 8"	24	041193003928	17	171
702A-1	1-1/2"	P-Trap - 20 Ga. w/ 11.25" Wall Tube	25	041193122933	15	131
702BN-1	1-1/2"	P-Trap - 20 Ga. w/ Brass Nuts	25	041193122964	15	131
702DF-1	1-1/2"	P-Trap - 20 Ga. w/ Deep Flange	25	041193122988	15	131
702DFBN-1	1-1/2"	P-Trap - 20 Ga. w/ Deep Flange & Brass Nuts	25	041193123008	15	131
702R-1	1-1/2"	Repair Trap - 20 Ga.	10	041193050106	15	132
703-1	1-1/4" x 1-1/2"	P-Trap - 20 Ga. w/ Choked Throat	25	041193123183	15	131
704-1	1-1/2"	P-Trap - 17 Ga.	25	041193054661	15	131
704A-1	1-1/2"	P-Trap - 17 Ga. w/ 11.25" Wall Tube	25	041193123350	15	131
704BN-1	1-1/2"	P-Trap - 17 Ga. w/ Brass Nuts	25	041193123367	15	131
704DF-1	1-1/2"	P-Trap - 17 Ga. w/ Deep Flange	25	041193123381	15	131
704DFBN-1	1-1/2"	P-Trap - 17 Ga. w/ Deep Flange & Brass Nuts	25	041193123404	15	131
704G-1	1-1/2"	P-Trap - 17 Ga. w/ Ground Joint	25	041193123428	15	131
704GBN-1	1-1/2"	P-Trap - 17 Ga. w/ Ground Joint & Brass Nuts	25	041193058409	15	131
704GBN-3	1-1/2"	P-Trap - 17 Ga. w/ Ground Joint & Brass Nuts, Unfinished	25	041193123459	15	131
704GDFBN-1	1-1/2"	P-Trap - 17 Ga. w/ Ground Joint, Deep Flange & Brass Nuts	25	041193009661	15	131
705-1	1-1/4" x 1-1/2"	P-Trap - 17 Ga. w/ Choked Throat	25	041193123589	15	131
705BN-1	1-1/4" x 1-1/2"	P-Trap - 17 Ga. w/ Choked Throat & Brass Nuts	25	041193006172	15	131
705GBN-1	1-1/4" x 1-1/2"	P-Trap - 17 Ga. w/ Choked Throat, Ground Joint & Brass Nuts	25	041193123626	15	131
706-1	1-1/4"	P-Trap w/ Cleanout - 20 Ga.	10	041193054678	15	132
707-1	1-1/4"	P-Trap w/ Cleanout - 17 Ga.	10	041193054685	15	132
707A-1	1-1/4"	P-Trap w/ Cleanout - 17 Ga. w/ 10" Wall Tube	10	041193123787	15	132
707BN-1	1-1/4"	P-Trap w/ Cleanout - 17 Ga. w/ Brass Nuts	10	041193123794	15	132
707DF-1	1-1/4"	P-Trap w/ Cleanout - 17 Ga. w/ Deep Flange	10	041193123800	15	132
708-1	1-1/2"	P-Trap w/ Cleanout - 20 Ga.	10	041193054692	15	132
710-1	1-1/2"	P-Trap w/ Cleanout - 17 Ga.	10	041193054739	15	132
7101		1-1/2" Flanged Spud Washer	25	041193054708	17	170



Product No.	Size	Description	Ctn. Qty.	UPC	Category	Page Number
7102		2" Flanged Spud Washer	25	041193054715	17	170
7105		1" x 3/4" Flanged Spud Washer	25	041193123985	17	170
710ADF-1	1-1/2"	P-Trap w/ Cleanout - 17 Ga. w/ Deep Flange & 11.25" Wall Tube	10	041193123862	15	132
710BN-1	1-1/2"	P-Trap w/ Cleanout - 17 Ga. w/ Brass Nuts	10	041193123879	15	132
710DF-1	1-1/2"	P-Trap w/ Cleanout - 17 Ga. w/ Deep Flange	10	041193123909	15	132
710GBN-1	1-1/2"	P-Trap w/ Cleanout - 17 Ga. w/ Ground Joint & Brass Nuts	10	041193123947	15	132
710GDFBN-1	1-1/2"	P-Trap w/ Cleanout - 17 Ga. w/ Ground Joint, Deep Flange & Brass Nuts	10	041193009616	15	132
710GDFBN-3	1-1/2"	P-Trap w/ Cleanout - 17 Ga. w/ Ground Joint, Deep Flange & Brass Nuts, Unfinished	10	041193018946	15	132
711A-1	1-1/4"	P-Trap, Low Inlet - 17 Ga.	10	041193123992	15	132
714A-1	1-1/2"	P-Trap, Low Inlet - 17 Ga.	10	041193124005	15	132
71550	5"	Plastic Barrel	1	038753715506	22	224
71560	6"	Plastic Barrel	1	038753715605	22	224
71570	3"	Plastic Cleanout Plug	1	038753715704	22	224
71580		Reversible Clamping Collar	1	038753715803	22	224
71720		Cast Iron Round Drain Funnel	1	038753717203	22	227
71730		Cast Iron Oval Drain Funnel	1	038753717302	22	227
71740		Plastic Sediment Grate	1	038753717401	22	224
71750		Plastic Sediment Grate Collar	1	038753717500	22	224
71760		Plastic Sediment Debris Bucket	1	038753717609	22	224
71770		Cast Iron Sediment Grate	1	038753717708	22	224
71780		Cast Iron Sediment Grate Collar	1	038753717807	22	224
71790		Cast Iron Sediment Debris Bucket	1	038753717906	22	224
718-1	1-1/4"	S-Trap - 20 Ga.	5	041193054791	15	134
718DF-1	1-1/4"	S-Trap - 20 Ga. w/ Deep Flange	5	041193102461	15	134
719-1	1-1/4"	S-Trap - 17 Ga.	5	041193124265	15	134
7195		1-1/2" flanged washer, 1-5/16" I.D. x 1-23/32" O.D.	100	041193054814	17	173
7196		1-1/4" beveled S.J. washer, 1-1/4" I.D. x 1-29/64" O.D. x 7/64" thick.	100	041193054821	17	173
71960		Dam Collar	1	038753719603	22	224
71970		Plastic Gravel Guard	1	038753719702	22	224
7198		1-1/2" x 1-1/4" beveled washer, bulk	100	041193054845	17	173
71980		ABS Plastic Roof Drain Dome	1	038753719801	22	223
71990		Cast Iron Roof Drain Dome	1	038753719900	22	223
719DFBN-1	1-1/4"	S-Trap - 17 Ga. w/ Deep Flange & Brass Nuts	5	041193124289	15	134
720-1	1-1/2"	S-Trap - 20 Ga.	5	041193054876	15	134
72010	5"	SS Grate & Plastic Barrel	1	038753720104	22	225
72012	2"	PVC Adj. Commercial Drain w/ 5" SS Grate	1	038753720128	22	200
72013	3" or 4"	PVC Adj. Commercial Drain w/ 5" SS Grate	1	038753720135	22	200
72014	4"	PVC Adj. Commercial Drain w/ 5" SS Grate	1	038753720142	22	200
72016	6"	PVC Adj. Commercial Drain w/ 5" SS Grate	1	038753720166	22	200
72017	3" or 4"	PVC General Purpose Drain w/ 5" SS Grate	1	038753720173	22	209
72018	4"	PVC Pipe Base General Purpose Drain w/ 5" SS Grate	1	038753720180	22	209
72019	4"	PVC Hub Base General Purpose Drain w/ 5" SS Grate	1	038753720197	22	209
7202		1-1/4" Regular, rubber, 1-1/4" I.D. x 1-7/16" O.D., 5/32" thick	100	041193054852	17	173
72020	5"	Round BR Grate & Plastic Barrel	1	038753720203	22	225
72022	2"	PVC Adj. Commercial Drain w/ 5" BR Grate	1	038753720227	22	200



Product No.	Size	Description	Ctn. Qty.	UPC	Category	Page Number
72023	3" or 4"	PVC Adj. Commercial Drain w/ 5" BR Grate	1	038753720234	22	200
72024	4"	PVC Adj. Commercial Drain w/ 5" BR Grate	1	038753720241	22	200
72026	6"	PVC Adj. Commercial Drain w/ 5" BR Grate	1	038753720265	22	200
72027	3" or 4"	PVC General Purpose Drain w/ 5" BR Grate	1	038753720272	22	209
72028	4"	PVC Pipe Base General Purpose Drain w/ 5" BR Grate	1	038753720289	22	209
72029	4"	PVC Hub Base General Purpose Drain w/ 5" BR Grate	1	038753720296	22	209
7203		1-1/2" Regular, rubber, 1-1/2" I.D. x 1-3/4" O.D., 3/16" thick	100	041193054869	17	173
72030	5"	Round BR Grate & Ring & Plastic Barrel	1	038753720302	22	225
72032	2"	PVC Adj. Commercial Drain w/ 5" BR Grate & Round Ring	1	038753720326	22	201
72033	3" or 4"	PVC Adj. Commercial Drain w/ 5" BR Grate & Round Ring	1	038753720333	22	201
72034	4"	PVC Adj. Commercial Drain w/ 5" BR Grate & Round Ring	1	038753720340	22	201
72036	6"	PVC Adj. Commercial Drain w/ 5" BR Grate & Round Ring	1	038753720364	22	201
72037	3" or 4"	PVC General Purpose Drain w/ 5" BR Grate & Round Ring	1	038753720371	22	209
72038	4"	PVC Pipe Base General Purpose Drain w/ 5" BR Grate & Round Ring	1	038753720388	22	210
72039	4"	PVC Hub Base General Purpose Drain w/ 5" BR Grate & Round Ring	1	038753720395	22	210
7204		2" Regular, rubber, 1-15/16" I.D. x 2-1/8" O.D., 3/16" thick	100	041193049506	17	173
72040	5"	Round BR Grate & Square Ring & Plastic Barrel	1	038753720401	22	225
72042	2"	PVC Adj. Commercial Drain w/ 5" BR Grate & Square Ring	1	038753720425	22	202
72043	3" or 4"	PVC Adj. Commercial Drain w/ 5" BR Grate & Square Ring	1	038753720432	22	202
72044	4"	PVC Adj. Commercial Drain w/ 5" BR Grate & Square Ring	1	038753720449	22	202
72046	6"	PVC Adj. Commercial Drain w/5" BR Grate & Square Ring	1	038753720463	22	202
72047	3" or 4"	PVC General Purpose Drain w/ 5" BR Grate & Square Ring	1	038753720470	22	210
72048	4"	PVC Pipe Base General Purpose Drain w/ 5" Br Grate & Square Ring	1	038753720487	22	210
72049	4"	PVC Hub Base General Purpose Drain w/ 5" Br Grate & Square Ring	1	038753720494	22	210
72050	5"	Round NI Grate & Plastic Barrel	1	038753720500	22	225
72052	2"	PVC Adj. Commercial Drain w/ 5" NI Grate	1	038753720524	22	200
72053	3" or 4"	PVC Adj. Commercial Drain w/ 5" NI Grate	1	038753720531	22	200
72054	4"	PVC Adj. Commercial Drain w/ 5" NI Grate	1	038753720548	22	200
72056	6"	PVC Adj. Commercial Drain w/ 5" NI Grate	1	038753720542	22	200
72057	3" or 4"	PVC General Purpose Drain w/ 5" NI Grate	1	038753720579	22	209
72058	4"	PVC Pipe Base General Purpose Drain w/ 5" NI Grate	1	038753720586	22	209
72059	4"	PVC Hub Base General Purpose Drain w/ 5" NI Grate	1	038753720593	22	209
7206	1-1/4" x 1-1/2"	Reducing True Blue Washer	100	041193303547	15	151
72060	5"	Round NI Grate & Ring & Plastic Barrel	1	038753720609	22	225
72062	2"	PVC Adj. Commercial Drain w/ 5" NI Grate & Round Ring	1	038753720623	22	201
72063	3" or 4"	PVC Adj. Commercial Drain w/ 5" NI Grate & Round Ring	1	038753720630	22	201
72064	4"	PVC Adj. Commercial Drain w/ 5" NI Grate & Round Ring	1	038753720647	22	201
72066	6"	PVC Adj. Commercial Drain w/ 5" NI Grate & Round Ring	1	038753720661	22	201
72067	3" or 4"	PVC General Purpose Drain w/ 5" NI Grate & Round Ring	1	038753720678	22	209
72068	4"	PVC Pipe Base General Purpose Drain w/ 5" NI Grate & Round Ring	1	038753720685	22	210
72069	4"	PVC Hub Base General Purpose Drain w/ 5" NI Grate & Round Ring	1	038753720692	22	210

NUMERICAL LISTING



Product No.	Size	Description	Ctn. Qty.	UPC	Category	Page Number
7207	1-1/2"	Slip Joint True Blue Washer	100	041193303530	15	151
72070	5"	Round NI Grate & Square Ring & Plastic Barrel	1	038753720708	22	225
72072	2"	PVC Adj. Commercial Drain w/ 5" NI Grate & Square Ring	1	038753720722	22	202
72073	3" or 4"	PVC Adj. Commercial Drain w/ 5" NI Grate & Square Ring	1	038753720739	22	202
72074	4"	PVC Adj. Commercial Drain w/ 5" NI Grate & Square Ring	1	038753720746	22	202
72076	6"	PVC Adj. Commercial Drain w/ 5" NI Grate & Square Ring	1	038753720760	22	202
72077	3" or 4"	PVC General Purpose Drain w/ 5" NI Grate & Square Ring	1	038753720777	22	210
72078	4"	PVC Pipe Base General Purpose Drain w/ 5" NI Grate & Square Ring	1	038753720784	22	210
72079	4"	PVC Hub Base General Purpose Drain w/ 5" NI Grate & Square Ring	1	038753720791	22	210
72080	5"	Round CHR Grate & Plastic Barrel	1	038753720807	22	225
72082	2"	PVC Adj. Commercial Drain w/ 5" CHR Grate	1	038753720821	22	200
72083	3" or 4"	PVC Adj. Commercial Drain w/ 5" CHR Grate	1	038753720838	22	200
72084	4"	PVC Adj. Commercial Drain w/ 5" CHR Grate	1	038753720845	22	200
72086	6"	PVC Adj. Commercial Drain w/ 5" CHR Grate	1	038753720869	22	200
72087	3" or 4"	PVC General Purpose Drain w/ 5" CHR Grate	1	038753720876	22	209
72088	4"	PVC Pipe Base General Purpose Drain w/ 5" CHR Grate	1	038753720883	22	209
72089	4"	PVC Hub Base General Purpose Drain w/ 5" CHR Grate	1	038753720890	22	209
72090	5"	Round CHR Grate & Ring & Plastic Barrel	1	038753720906	22	225
72092	2"	PVC Adj. Commercial Drain w/ 5" CHR Grate & Round Ring	1	038753720920	22	201
72093	3" or 4"	PVC Adj. Commercial Drain w/ 5" CHR Grate & Round Ring	1	038753720937	22	201
72094	4"	PVC Adj. Commercial Drain w/ 5" CHR Grate & Round Ring	1	038753720944	22	201
72096	6"	PVC Adj. Commercial Drain w/ 5" CHR Grate & Round Ring	1	038753720968	22	201
72097	3" or 4"	PVC General Purpose Drain w/ 5" CHR Grate & Round Ring	1	038753720975	22	210
72098	4"	PVC Pipe Base General Purpose Drain w/ 5" CHR Grate & Round Ring	1	038753720982	22	210
72099	4"	PVC Hub Base General Purpose Drain w/ 5" CHR Grate & Round Ring	1	038753720999	22	210
720DF-1	1-1/2"	S-Trap - 20 Ga. w/ Deep Flange	5	041193124326	15	134
7210		1-1/2" x 1-1/4", rubber, 1-1/4" I.D. x 1-3/4" O.D., 5/32" thick	100	041193054890	17	173
72100	5"	Round CHR Grate & Square Ring & Plastic Barrel	1	038753721002	22	225
72102	2"	PVC Adj. Commercial Drain w/ 5" CHR Grate & Square Ring	1	038753721026	22	202
72103	3" or 4"	PVC Adj. Commercial Drain w/ 5" CHR Grate & Square Ring	1	038753721033	22	202
72104	4"	PVC Adj. Commercial Drain w/ 5" CHR Grate & Square Ring	1	038753721040	22	202
72106	6"	PVC Adj. Commercial Drain w/ 5" CHR Grate & Square Ring	1	038753721064	22	202
72107	3" or 4"	PVC General Purpose Drain w/ 5" CHR Grate & Square Ring	1	038753721071	22	210
72108	4"	PVC Pipe Base General Purpose Drain w/ 5" CHR Grate & Square Ring	1	038753721088	22	210
72109	4"	PVC Hub Base General Purpose Drain w/ 5" CHR Grate & Square Ring	1	038753721095	22	210
72110	6"	SS Grate & Plastic Barrel	1	038753721101	22	225
72112	2"	PVC Adj. Commercial Drain w/ 6" SS Grate	1	038753721125	22	203
72113	3" or 4"	PVC Adj. Commercial Drain w/ 6" SS Grate	1	038753721132	22	203



Product No.	Size	Description	Ctn. Qty.	UPC	Category	Page Number
72114	4"	PVC Adj. Commercial Drain w/ 6" SS Grate	1	038753721149	22	203
72116	6"	PVC Adj. Commercial Drain w/ 6" SS Grate	1	038753721163	22	203
72117	3" or 4"	PVC General Purpose Drain w/ 6" SS Grate	1	038753721170	22	211
72118	4"	PVC Pipe Base General Purpose Drain w/ 6" SS Grate	1	038753721187	22	211
72119	4"	PVC Hub Base General Purpose Drain w/ 6" SS Grate	1	038753721194	22	211
72120	6"	Round BR Grate & Plastic Barrel	1	038753721200	22	225
72122	2"	PVC Adj. Commercial Drain w/ 6" BR Grate	1	038753721224	22	203
72123	3" or 4"	PVC Adj. Commercial Drain w/ 6" BR Grate	1	038753721231	22	203
72124	4"	PVC Adj. Commercial Drain w/ 6" BR Grate	1	038753721248	22	203
72126	6"	PVC Adj. Commercial Drain w/ 6" BR Grate	1	038753721262	22	203
72127	3" or 4"	PVC General Purpose Drain w/ 6" BR Grate	1	038753721279	22	211
72128	4"	PVC Pipe Base General Purpose Drain w/ 6" BR Grate	1	038753721286	22	211
72129	4"	PVC Hub Base General Purpose Drain w/ 6" BR Grate	1	038753721293	22	211
72130	6"	Round BR Grate & Ring & Plastic Barrel	1	038753721309	22	225
72132	2"	PVC Adj. Commercial Drain w/ 6" BR Grate & Round Ring	1	038753721323	22	204
72133	3" or 4"	PVC Adj. Commercial Drain w/ 6" BR Grate & Round Ring	1	038753721330	22	204
72134	4"	PVC Adj. Commercial Drain w/ 6" BR Grate & Round Ring	1	038753721347	22	204
72136	6"	PVC Adj. Commercial Drain w/ 6" BR Grate & Round Ring	1	038753721361	22	204
72137	3" or 4"	PVC General Purpose Drain w/ 6" BR Grate & Round Ring	1	038753721378	22	212
72138	4"	PVC Pipe Base General Purpose Drain w/ 6" BR Grate & Round Ring	1	038753721385	22	212
72139	4"	PVC Hub Base General Purpose Drain w/ 6" BR Grate & Round Ring	1	038753721392	22	212
72140	6"	Round BR Grate & Square Ring & Plastic Barrel	1	038753721408	22	225
72142	2"	PVC Adj. Commercial Drain w/ 6" BR Grate & Square Ring	1	038753721422	22	205
72143	3" or 4"	PVC Adj. Commercial Drain w/ 6" BR Grate & Square Ring	1	038753721439	22	205
72144	4"	PVC Adj. Commercial Drain w/ 6" BR Grate & Square Ring	1	038753721446	22	205
72146	6"	PVC Adj. Commercial Drain w/ 6" BR Grate & Square Ring	1	038753721460	22	205
72147	3" or 4"	PVC General Purpose Drain w/ 6" BR Grate & Square Ring	1	038753721477	22	212
72148	4"	PVC Pipe Base General Purpose Drain w/ 6" BR Grate & Square Ring	1	038753721484	22	212
72149	4"	PVC Hub Base General Purpose Drain w/ 6" BR Grate & Square Ring	1	038753721491	22	212
72150	6"	Round NI Grate & Plastic Barrel	1	038753721507	22	225
72152	2"	PVC Adj. Commercial Drain w/ 6" NI Grate	1	038753721521	22	203
72153	3" or 4"	PVC Adj. Commercial Drain w/ 6" NI Grate	1	038753721538	22	203
72154	4"	PVC Adj. Commercial Drain w/ 6" NI Grate	1	038753721545	22	203
72156	6"	PVC Adj. Commercial Drain w/ 6" NI Grate	1	038753721569	22	203
72157	3" or 4"	PVC General Purpose Drain w/ 6" NI Grate	1	038753721576	22	211
72158	4"	PVC Pipe Base General Purpose Drain w/ 6" NI Grate	1	038753721583	22	211
72159	4"	PVC Hub Base General Purpose Drain w/ 6" NI Grate	1	038753721590	22	211
72160	6"	Round NI Grate & Ring & Plastic Barrel	1	038753721606	22	225
72162	2"	PVC Adj. Commercial Drain w/ 6" NI Grate & Round Ring	1	038753721620	22	204
72163	3" or 4"	PVC Adj. Commercial Drain w/ 6" NI Grate & Round Ring	1	038753721637	22	204
72164	4"	PVC Adj. Commercial Drain w/ 6" NI Grate & Round Ring	1	038753721644	22	204
72166	6"	PVC Adj. Commercial Drain w/ 6" NI Grate & Round Ring	1	038753721668	22	204
72167	3" or 4"	PVC General Purpose Drain w/ 6" NI Grate & Round Ring	1	038753721675	22	212

NUMERICAL LISTING



Product No.	Size	Description	Ctn. Qty.	UPC	Category	Page Number
72168	4"	PVC Pipe Base General Purpose Drain w/ 6" NI Grate & Round Ring	1	038753721682	22	212
72169	4"	PVC Hub Base General Purpose Drain w/ 6" NI Grate & Round Ring	1	038753721699	22	212
72170	6"	Round NI Grate & Square Ring & Plastic Barrel	1	038753721705	22	225
72172	2"	PVC Adj. Commercial Drain w/ 6" NI Grate & Square Ring	1	038753721729	22	205
72173	3" or 4"	PVC Adj. Commercial Drain w/ 6" NI Grate & Square Ring	1	038753721736	22	205
72174	4"	PVC Adj. Commercial Drain w/ 6" NI Grate & Square Ring	1	038753721743	22	205
72176	6"	PVC Adj. Commercial Drain w/ 6" NI Grate & Square Ring	1	038753721767	22	205
72177	3" or 4"	PVC General Purpose Drain w/ 6" NI Grate & Square Ring	1	038753721774	22	212
72178	4"	PVC Pipe Base General Purpose Drain w/ 6" NI Grate & Square Ring	1	038753721781	22	212
72179	4"	PVC Hub Base General Purpose Drain w/ 6" NI Grate & Square Ring	1	038753721798	22	212
72180	6"	Round CHR Grate & Plastic Barrel	1	038753721804	22	225
72182	2"	PVC Adj. Commercial Drain w/ 6" CHR Grate	1	038753721728	22	203
72183	3" or 4"	PVC Adj. Commercial Drain w/ 6" CHR Grate	1	038753721835	22	203
72184	4"	PVC Adj. Commercial Drain w/ 6" CHR Grate	1	038753721842	22	203
72186	6"	PVC Adj. Commercial Drain w/ 6" CHR Grate	1	038753721866	22	203
72187	3" or 4"	PVC General Purpose Drain w/ 6" CHR Grate	1	038753721873	22	211
72186	4"	PVC Pipe Base General Purpose Drain w/ 6" CHR Grate	1	038753721860	22	211
72189	4"	PVC Hub Base General Purpose Drain w/ 6" CHR Grate	1	038753721897	22	211
72190	6"	Round CHR Grate & Ring & Plastic Barrel	1	038753721903	22	225
72192	2"	PVC Adj. Commercial Drain w/ 6" CHR Grate & Round Ring	1	038753721927	22	205
72193	3" or 4"	PVC Adj. Commercial Drain w/ 6" CHR Grate & Round Ring	1	038753721934	22	204
72194	4"	PVC Adj. Commercial Drain w/ 6" CHR Grate & Round Ring	1	038753721941	22	204
72196	6"	PVC Adj. Commercial Drain w/ 6" CHR Grate & Round Ring	1	038753721965	22	204
72197	3" or 4"	PVC General Purpose Drain w/ 6" CHR Grate & Round Ring	1	038753721972	22	212
72198	4"	PVC Pipe Base General Purpose Drain w/ 6" CHR Grate & Round Ring	1	038753721989	22	212
72199	4"	PVC Hub Base General Purpose Drain w/ 6" CHR Grate & Round Ring	1	038753721996	22	212
722-1	1-1/2"	S-Trap - 17 Ga.	5	041193124357	15	133
72200	6"	Round CHR Grate & Square Ring & Plastic Barrel	1	038753722009	22	225
72202	2"	PVC Adj. Commercial Drain w/ 6" CHR Grate & Square Ring	1	038753722023	22	205
72203	3" or 4"	PVC Adj. Commercial Drain w/ 6" CHR Grate & Square Ring	1	038753722030	22	205
72204	4"	PVC Adj. Commercial Drain w/ 6" CHR Grate & Square Ring	1	038753722047	22	205
72206	6"	PVC Adj. Commercial Drain w/ 6" CHR Grate & Square Ring	1	038753722061	22	205
72207	3" or 4"	PVC General Purpose Drain w/ 6" CHR Grate & Square Ring	1	038753722078	22	212
72208	4"	PVC Pipe Base General Purpose Drain w/ 6" CHR Grate & Square Ring	1	038753722085	22	212
72209	4"	PVC Hub Base General Purpose Drain w/ 6" CHR Grate & Square Ring	1	038753722092	22	212
72212	2"	PVC Adj. Commercial Drain w/ 4" Cast NI Square Grate & Square Top	1	038753722122	22	207



Product No.	Size	Description	Ctn. Qty.	UPC	Category	Page Number
72213	3" or 4 "	PVC Adj. Commercial Drain w/ 4" Cast NI Square Grate & Square Top	1	038753722139	22	208
72214	4"	PVC Adj. Commercial Drain w/ 4" Cast NI Square Grate & Square Top	1	038753722146	22	208
72216	6"	PVC Adj. Commercial Drain w/ 4" Cast NI Square Grate & Square Top	1	038753722160	22	208
72217	3" or 4"	PVC General Purpose Pipe Fit Drain w/ 4" Cast NI Grate & Square Top	1	038753722177	22	213
72218	4"	PVC General Purpose Pipe Fit Drain w/ 4" Cast NI Grate & Square Top	1	038753722184	22	213
72219	4"	PVC General Purpose Hub Fit Drain w/ 4" Cast NI Grate & Square Top	1	038753722191	22	213
72222	2"	PVC Adj. Commercial Drain w/ 4" Cast CHR Square Grate & Square Top	1	038753722221	22	207
72223	3" or 4 "	PVC Adj. Commercial Drain w/ 4" Cast CHR Square Grate & Square Top	1	038753722238	22	208
72224	4"	PVC Adj. Commercial Drain w/ 4" Cast CHR Square Grate & Square Top	1	038753722245	22	208
72226	6"	PVC Adj. Commercial Drain w/ 4" Cast CHR Square Grate & Square Top	1	038753722269	22	208
72227	3" or 4"	PVC General Purpose Pipe Fit Drain w/ 4" Cast CHR Grate & Square Top	1	038753722276	22	213
72228	4"	PVC General Purpose Pipe Fit Drain w/ 4" Cast CHR Grate & Square Top	1	038753722283	22	213
72229	4"	PVC General Purpose Hub Fit Drain w/ 4" Cast CHR Grate & Square Top	1	038753722290	22	213
72232	2"	PVC Adj. Commercial Drain w/ 5" Cast NI Square Grate & Square Top	1	038753722320	22	207
72233	3" or 4 "	PVC Adj. Commercial Drain w/ 5" Cast NI Square Grate & Square Top	1	038753722337	22	208
72234	4"	PVC Adj. Commercial Drain w/ 5" Cast NI Square Grate & Square Top	1	038753722344	22	208
72236	6"	PVC Adj. Commercial Drain w/ 5" Cast NI Square Grate & Square Top	1	038753722368	22	208
72237	3" or 4"	PVC General Purpose Pipe Fit Drain w/ 5" Cast NI Grate & Square Top	1	038753722375	22	213
72238	4"	PVC General Purpose Pipe Fit Drain w/ 5" Cast NI Grate & Square Top	1	038753722382	22	213
72239	4"	PVC General Purpose Hub Fit Drain w/ 5" Cast NI Grate & Square Top	1	038753722399	22	213
72242	2"	PVC Adj. Commercial Drain w/ 5" Cast CHR Square Grate & Square Top	1	038753722429	22	208
72243	3" or 4 "	PVC Adj. Commercial Drain w/ 5" Cast CHR Square Grate & Square Top	1	038753722436	22	208
72244	4"	PVC Adj. Commercial Drain w/ 5" Cast CHR Square Grate & Square Top	1	038753722443	22	208
72246	6"	PVC Adj. Commercial Drain w/ 5" Cast CHR Square Grate & Square Top	1	038753722467	22	208
72247	3" or 4"	PVC General Purpose Pipe Fit Drain w/ 5" Cast CHR Grate & Square Top	1	038753722474	22	213
72248	4"	PVC General Purpose Pipe Fit Drain w/ 5" Cast CHR Grate & Square Top	1	038753722481	22	213
72249	4"	PVC General Purpose Hub Fit Drain w/ 5" Cast CHR Grate & Square Top	1	038753722498	22	213
72252	2"	PVC Adj. Commercial Drain w/ 6" Cast NI Square Grate & Square Top	1	038753722528	22	207
72253	3" or 4 "	PVC Adj. Commercial Drain w/ 6" Cast NI Square Grate & Square Top	1	038753722535	22	208
72254	4"	PVC Adj. Commercial Drain w/ 6" Cast NI Square Grate & Square Top	1	038753722542	22	208

NUMERICAL LISTING



db Dearborn
Brass.



Oatey

Product No.	Size	Description	Ctn. Qty.	UPC	Category	Page Number
72256	6"	PVC Adj. Commercial Drain w/ 6" Cast NI Square Grate & Square Top	1	038753722566	22	208
72257	3" or 4"	PVC General Purpose Pipe Fit Drain w/ 6" Cast NI Grate & Square Top	1	038753722573	22	213
72258	4"	PVC General Purpose Pipe Fit Drain w/ 6" Cast NI Grate & Square Top	1	038753722580	22	213
72259	4"	PVC General Purpose Hub Fit Drain w/ 6" Cast NI Grate & Square Top	1	038753722597	22	213
72262	2"	PVC Adj. Commercial Drain w/ 6" Cast CHR Square Grate & Square Top	1	038753722627	22	208
72263	3" or 4 "	PVC Adj. Commercial Drain w/ 6" Cast CHR Square Grate & Square Top	1	038753722634	22	208
72264	4"	PVC Adj. Commercial Drain w/ 6" Cast CHR Square Grate & Square Top	1	038753722641	22	208
72266	6"	PVC Adj. Commercial Drain w/ 6" Cast CHR Square Grate & Square Top	1	038753722665	22	208
72267	3" or 4"	PVC General Purpose Pipe Fit Drain w/ 6" Cast CHR Grate & Square Top	1	038753722672	22	213
72268	4"	PVC General Purpose Pipe Fit Drain w/ 6" Cast CHR Grate & Square Top	1	038753722689	22	213
72269	4"	PVC General Purpose Hub Fit Drain w/ 6" Cast CHR Grate & Square Top	1	038753722696	22	213
72272	2"	PVC Adj. Commercial Drain w/ 5" Cast NI Grate & Square Top	1	038753722726	22	207
72273	3" or 4 "	PVC Adj. Commercial Drain w/ 5" Cast NI Grate & Square Top	1	038753722733	22	207
72274	4"	PVC Adj. Commercial Drain w/ 5" Cast NI Grate & Square Top	1	038753722740	22	207
72276	6"	PVC Adj. Commercial Drain w/ 5" Cast NI Grate & Square Top	1	038753722764	22	207
72277	3" or 4"	PVC General Purpose Pipe Fit Drain w/ 5" Cast NI Grate & Square Top	1	038753722771	22	214
72278	4"	PVC General Purpose Pipe Fit Drain w/ 5" Cast NI Grate & Square Top	1	038753722788	22	214
72279	4"	PVC General Purpose Hub Fit Drain w/ 5" Cast NI Grate & Square Top	1	038753722795	22	214
72282	2"	PVC Adj. Commercial Drain w/ 5" Cast CHR Grate & Square Top	1	038753722825	22	207
72283	3" or 4 "	PVC Adj. Commercial Drain w/ 5" Cast CHR Grate & Square Top	1	038753722832	22	207
72284	4"	PVC Adj. Commercial Drain w/ 5" Cast CHR Grate & Square Top	1	038753722849	22	207
72286	6"	PVC Adj. Commercial Drain w /5" Cast CHR Grate & Square Top	1	038753722863	22	207
72287	3" or 4"	PVC General Purpose Pipe Fit Drain w/ 5" Cast CHR Grate & Square Top	1	038753722870	22	214
72288	4"	PVC General Purpose Pipe Fit Drain w/ 5" Cast CHR Grate & Square Top	1	038753722887	22	214
72289	4"	PVC General Purpose Hub Fit Drain w/ 5" Cast CHR Grate & Square Top	1	038753722894	22	214
72292	2"	PVC Adj. Commercial Drain w/ 6" Cast NI Grate & Square Top	1	038753722924	22	207
72293	3" or 4 "	PVC Adj. Commercial Drain w/ 6" Cast NI Grate & Square Top	1	038753722931	22	207
72294	4"	PVC Adj. Commercial Drain w/ 6" Cast NI Grate & Square Top	1	038753722948	22	207
72296	6"	PVC Adj. Commercial Drain w/ 6" Cast NI Grate & Square Top	1	038753722962	22	207
72297	3" or 4"	PVC General Purpose Pipe Fit Drain w/ 6" Cast NI Grate & Square Top	1	038753722979	22	214



Product No.	Size	Description	Ctn. Qty.	UPC	Category	Page Number
72298	4"	PVC General Purpose Pipe Fit Drain w/ 6" Cast NI Grate & Square Top	1	038753722986	22	214
72299	4"	PVC General Purpose Hub Fit Drain w/ 6" Cast NI Grate & Square Top	1	038753722993	22	214
722DFBN-1	1-1/2"	S-Trap - 17 Ga. w/ Deep Flange & Brass Nuts	5	041193124388	15	134
72302	2"	PVC Adj. Commercial Drain w/ 6" Cast CHR Grate & Square Top	1	038753723020	22	207
72303	3" or 4 "	PVC Adj. Commercial Drain w/ 6" Cast CHR Grate & Square Top	1	038753723037	22	207
72304	4"	PVC Adj. Commercial Drain w/ 6" Cast CHR Grate & Square Top	1	038753723044	22	207
72306	6"	PVC Adj. Commercial Drain w/ 6" Cast CHR Grate & Square Top	1	038753723068	22	207
72307	3" or 4"	PVC General Purpose Pipe Fit Drain w/ 6" Cast CHR Grate & Square Top	1	038753723075	22	214
72308	4"	PVC General Purpose Pipe Fit Drain w/ 6" Cast CHR Grate & Square Top	1	038753723082	22	214
72309	4"	PVC General Purpose Hub Fit Drain w/ 6" Cast CHR Grate & Square Top	1	038753723099	22	214
72312	2"	PVC Adj. Commercial Drain w/ 5" Cast NI Grate & Round Top	1	038753723129	22	205
72313	3" or 4 "	PVC Adj. Commercial Drain w/ 5" Cast NI Grate & Round Top	1	038753723136	22	205
72314	4"	PVC Adj. Commercial Drain w/ 5" Cast NI Grate & Round Top	1	038753723143	22	206
72316	6"	PVC Adj. Commercial Drain w/ 5" Cast NI Grate & Round Top	1	038753723167	22	206
72317	3" or 4"	PVC General Purpose Pipe Fit Drain w/ 5" Cast NI Grate & Round Top	1	038753723174	22	214
72318	4"	PVC General Purpose Pipe Fit Drain w/ 5" Cast NI Grate & Round Top	1	038753723179	22	215
72319	4"	PVC General Purpose Hub Fit Drain w/ 5" Cast NI Grate & Round Top	1	038753723198	22	215
72322	2"	PVC Adj. Commercial Drain w/ 5" Cast CHR Grate & Round Top	1	038753723228	22	205
72323	3" or 4 "	PVC Adj. Commercial Drain w/ 5" Cast CHR Grate & Round Top	1	038753723235	22	206
72324	4"	PVC Adj. Commercial Drain w/ 5" Cast CHR Grate & Round Top	1	038753723242	22	206
72326	6"	PVC Adj. Commercial Drain w/ 5" Cast CHR Grate & Round Top	1	038753723266	22	206
72327	3" or 4"	PVC General Purpose Pipe Fit Drain w/ 5" Cast CHR Grate & Round Top	1	038753723273	22	214
72328	4"	PVC General Purpose Pipe Fit Drain w/ 5" Cast CHR Grate & Round Top	1	038753723280	22	215
72329	4"	PVC General Purpose Hub Fit Drain w/ 5" Cast CHR Grate & Round Top	1	038753723297	22	215
72332	2"	PVC Adj. Commercial Drain w/ 6" Cast NI Grate & Round Top	1	038753723327	22	205
72333	3" or 4 "	PVC Adj. Commercial Drain w/ 6" Cast NI Grate & Round Top	1	038753723334	22	206
72334	4"	PVC Adj. Commercial Drain w/ 6" Cast NI Grate & Round Top	1	038753723341	22	206
72336	6"	PVC Adj. Commercial Drain w/ 6" Cast NI Grate & Round Top	1	038753723365	22	206
72337	3" or 4"	PVC General Purpose Pipe Fit Drain w/ 6" Cast NI Grate & Round Top	1	038753723372	22	214
72338	4"	PVC General Purpose Pipe Fit Drain w/ 6" Cast NI Grate & Round Top	1	038753723389	22	215

NUMERICAL LISTING



Product No.	Size	Description	Ctn. Qty.	UPC	Category	Page Number
72339	4"	PVC General Purpose Hub Fit Drain w/ 6" Cast NI Grate & Round Top	1	038753723396	22	215
72342	2"	PVC Adj. Commercial Drain w/ 6" Cast CHR Grate & Round Top	1	038753743426	22	205
72343	3" or 4 "	PVC Adj. Commercial Drain w/ 6" Cast CHR Grate & Round Top	1	038753743433	22	206
72344	4"	PVC Adj. Commercial Drain w/ 6" Cast CHR Grate & Round Top	1	038753723440	22	206
72346	6"	PVC Adj. Commercial Drain w/ 6" Cast CHR Grate & Round Top	1	038753723464	22	206
72347	3" or 4"	PVC General Purpose Pipe Fit Drain w/ 6" Cast CHR Grate & Round Top	1	038753723471	22	214
72348	4"	PVC General Purpose Pipe Fit Drain w/ 6" Cast CHR Grate & Round Top	1	038753723488	22	215
72349	4"	PVC General Purpose Hub Fit Drain w/ 6" Cast CHR Grate & Round Top	1	038753723495	22	215
72352	2"	PVC Adj. Commercial Drain w/ 8" Cast NI Grate & Round Top	1	038753723525	22	205
72353	3" or 4 "	PVC Adj. Commercial Drain w/ 8" Cast NI Grate & Round Top	1	038753723532	22	206
72354	4"	PVC Adj. Commercial Drain w/ 8" Cast NI Grate & Round Top	1	038753723549	22	206
72356	6"	PVC Adj. Commercial Drain w/ 8" Cast NI Grate & Round Top	1	038753723563	22	206
72357	3" or 4"	PVC General Purpose Pipe Fit Drain w/ 8" Cast NI Grate & Round Top	1	038753723570	22	214
72358	4"	PVC General Purpose Pipe Fit Drain w/ 8" Cast NI Grate & Round Top	1	038753723587	22	215
72359	4"	PVC General Purpose Hub Fit Drain w/ 8" Cast NI Grate & Round Top	1	038753723594	22	215
72362	2"	PVC Adj. Commercial Drain w/ 8" Cast CHR Grate & Round Top	1	038753743624	22	205
72363	3" or 4 "	PVC Adj. Commercial Drain w/ 8" Cast CHR Grate & Round Top	1	038753743631	22	206
72364	4"	PVC Adj. Commercial Drain w /8" Cast CHR Grate & Round Top	1	038753723648	22	206
72366	6"	PVC Adj. Commercial Drain w/ 8" Cast CHR Grate & Round Top	1	038753723662	22	206
72367	3" or 4"	PVC General Purpose Pipe Fit Drain w/ 8" Cast CHR Grate & Round Top	1	038753723679	22	214
72368	4"	PVC General Purpose Pipe Fit Drain w/ 8" Cast CHR Grate & Round Top	1	038753723686	22	215
72369	4"	PVC General Purpose Hub Fit Drain w/ 8" Cast CHR Grate & Round Top	1	038753723693	22	215
72372	2"	PVC Adj. Commercial Drain w/ 10" Cast NI Grate & Round Top	1	038753723723	22	205
72373	3" or 4 "	PVC Adj. Commercial Drain w/ 10" Cast NI Grate & Round Top	1	038753723730	22	206
72374	4"	PVC Adj. Commercial Drain w/ 10" Cast NI Grate & Round Top	1	038753723747	22	206
72376	6"	PVC Adj. Commercial Drain w/ 10" Cast NI Grate & Round Top	1	038753723761	22	206
72377	3" or 4"	PVC General Purpose Pipe Fit Drain w/ 10" Cast NI Grate & Round Top	1	038753723778	22	214
72378	4"	PVC General Purpose Pipe Fit Drain w/ 10" Cast NI Grate & Round Top	1	038753723785	22	215
72379	4"	PVC General Purpose Hub Fit Drain w/ 10" Cast NI Grate & Round Top	1	038753723792	22	215
72382	2"	PVC Adj. Commercial Drain w/ 10" Cast CHR Grate & Round Top	1	038753743822	22	205



Product No.	Size	Description	Ctn. Qty.	UPC	Category	Page Number
72383	3" or 4"	PVC Adj. Commercial Drain w/ 10" Cast CHR Grate & Round Top	1	038753743839	22	206
72384	4"	PVC Adj. Commercial Drain w/ 10" Cast CHR Grate & Round Top	1	038753723846	22	206
72386	6"	PVC Adj. Commercial Drain w/ 10" Cast CHR Grate & Round Top	1	038753723860	22	206
72387	3" or 4"	PVC General Purpose Pipe Fit Drain w/ 10" Cast CHR Grate & Round Top	1	038753723877	22	214
72388	4"	PVC General Purpose Pipe Fit Drain w/ 10" Cast CHR Grate & Round Top	1	038753723884	22	215
72389	4"	PVC General Purpose Hub Fit Drain w/ 10" Cast CHR Grate & Round Top	1	038753723891	22	215
725BN-1	1-1/4"	S-Trap - 17 Ga. w/ Cleanout & Brass Nuts	5	041193009548	15	134
726BN-1	1-1/2"	S-Trap - 17 Ga. w/ Cleanout & Brass Nuts	5	041193009524	15	134
727DFBN-6-1	1-1/2" x 1-1/4"	Sink Trap w/ Cleanout & 6" (SWT) Extension, Deep Flange & Brass	10	041193003966	15	132
730GABN-6-1	1-1/2" x 1-1/4"	Sink Trap w/ Schedule 40 ABS Adapter, Ground Joint, Cover Tube & Escutcheon & Brass Nuts	5	041193009623	15	132
730GPBN-6-1	1-1/2" x 1-1/4"	Sink Trap w/ Schedule 40 PVC Adapter, Ground Joint, Cover Tube & Escutcheon & Brass Nuts	5	041193003997	15	132
730GPPB-3	1-1/2" x 1-1/4"	Sink Trap w/ Schedule 40 PVC Adapter, Ground Joint, Cover Tube & Escutcheon, Polished Brass & Brass Nuts	5	041193009715	15	132
7324	Gallon	Clear Cleaner	6	083675073241	1	24
732GPBN-6-1	1-1/2" x 1-1/4"	Sink Trap w/ Cleanout, Schedule 40 PVC Adapter, Ground Joint, Cover Tube & Escutcheon & Brass Nuts	5	041193009678	15	133
7336S	32 oz.	Clear Cleaner	12	083675073364	1	24
7346S	16 oz.	Clear Cleaner	24	083675073463	1	24
7356S	8 oz.	Clear Cleaner	24	083675073562	1	24
7366S	4 oz.	Clear Cleaner	24	083675073661	1	24
736W-1	1-1/4"	Sink Trap w/ Washer Joint NPT - 20 Ga.	10	041193124500	15	133
738-1	1-1/2"	Sink Trap w/ Ground Joint NPT - 20 Ga. w/ Reducing Poly Washer	10	041193124524	15	133
738CS-1	1-1/2"	Sink Trap w/ Ground Joint w/ Copper Sweat Elbow - 20 Ga.	10	041193015440	15	133
738W-1	1-1/2"	Sink Trap w/ Washer Joint NPT - 20 Ga.	10	041193065469	15	133
740-1	1-1/2"	Sink Trap w/ Ground Joint NPT - 17 Ga. w/ Reducing Poly Washer	10	041193124555	15	133
740W-1	1-1/2"	Sink Trap w/ Washer Joint NPT - 17 Ga.	10	041193055019	15	133
74120	6"	IPS Adj. Barrel & 6" Round BR Cover	1	038753741208	22	227
74122	2"	PVC Adj. Commercial Cleanout w/ 6" BR Cover	1	038753741222	22	216
74123	3" or 4"	PVC Adj. Commercial Cleanout w/ 6" BR Cover	1	038753741239	22	216
74124	4"	PVC Adj. Commercial Cleanout w/ 6" BR Cover	1	038753741246	22	216
74126	6"	PVC Adj. Commercial Cleanout w/ 6" BR Cover	1	038753741260	22	216
74127	3" or 4"	PVC General Purpose Cleanout w/ 6" BR Cover	1	038753741277	22	219
74128	4"	PVC Pipe Base General Purpose Cleanout w/ 6" BR Cover	1	038753741284	22	219
74129	4"	PVC Hub Base General Purpose Cleanout w/ 6" BR Cover	1	038753741291	22	219
74130	6"	IPS Adj. Barrel & 6" Round BR Cover & Ring	1	038753741307	22	227
74132	2"	PVC Adj. Commercial Cleanout w/ 6" BR Cover & Round Ring	1	038753741321	22	216
74133	3" or 4"	PVC Adj. Commercial Cleanout w/ 6" BR Cover & Round Ring	1	038753741338	22	216
74134	4"	PVC Adj. Commercial Cleanout w/ 6" BR Cover & Round Ring	1	038753741345	22	217
74136	6"	PVC Adj. Commercial Cleanout w/ 6" BR Cover & Round Ring	1	038753741369	22	217



NUMERICAL LISTING

Product No.	Size	Description	Ctn. Qty.	UPC	Category	Page Number
74137	3" or 4"	PVC General Purpose Cleanout w/ 6" BR Cover & Round Ring	1	038753741376	22	219
74138	4"	PVC Pipe Base General Purpose Cleanout w/ 6" BR Cover & Round Ring	1	038753741383	22	219
74139	4"	PVC Hub Base General Purpose Cleanout w/ 6" BR Cover & Round Ring	1	038753741390	22	219
74140	6"	IPS Adj. Barrel & 6" Round BR Cover & Square Ring	1	038753741406	22	227
74142	2"	PVC Adj. Commercial Cleanout w/ 6" BR Cover & Square Ring	1	038753741420	22	217
74143	3" or 4 "	PVC Adj. Commercial Cleanout w/ 6" BR Cover & Square Ring	1	038753741437	22	217
74144	4"	PVC Adj. Commercial Cleanout w/ 6" BR Cover & Square Ring	1	038753741444	22	217
74146	6"	PVC Adj. Commercial Cleanout w/ 6" BR Cover & Square Ring	1	038753741468	22	217
74147	3" or 4"	PVC General Purpose Cleanout w/ 6" BR Cover & Square Ring	1	038753741475	22	220
74148	4"	PVC Pipe Base General Purpose Cleanout w/ 6" BR Cover & Square Ring	1	038753741482	22	220
74149	4"	PVC Hub Base General Purpose Cleanout w/ 6" BR Cover & Square Ring	1	038753741499	22	220
74150	6"	IPS Adj. Barrel & 6" Round NI Cover	1	038753741505	22	227
74152	2"	PVC Adj. Commercial Cleanout w/ 6" NI Cover	1	038753741529	22	216
74153	3" or 4 "	PVC Adj. Commercial Cleanout w/ 6" NI Cover	1	038753741536	22	216
74154	4"	PVC Adj. Commercial Cleanout w/ 6" NI Cover	1	038753741543	22	216
74156	6"	PVC Adj. Commercial Cleanout w/ 6" NI Cover	1	038753741567	22	216
74157	3" or 4"	PVC General Purpose Cleanout w/ 6" NI Cover	1	038753741574	22	219
74158	4"	PVC Pipe Base General Purpose Cleanout w/ 6" NI Cover	1	038753741581	22	219
74159	4"	PVC Hub Base General Purpose Cleanout w/ 6" NI Cover	1	038753741598	22	219
74160	6"	IPS Adj. Barrel & 6" Round NI Cover & Ring	1	038753741604	22	227
74162	2"	PVC Adj. Commercial Cleanout w/ 6" NI Cover & Round Ring	1	038753741628	22	216
74163	3" or 4 "	PVC Adj. Commercial Cleanout w/ 6" NI Cover & Round Ring	1	038753741635	22	216
74164	4"	PVC Adj. Commercial Cleanout w/ 6" NI Cover & Round Ring	1	038753741642	22	217
74166	6"	PVC Adj. Commercial Cleanout w/ 6" NI Cover & Round Ring	1	038753741666	22	217
74167	3" or 4"	PVC General Purpose Cleanout w/ 6" NI Cover & Round Ring	1	038753741673	22	219
74168	4"	PVC Pipe Base General Purpose Cleanout w/ 6" NI Cover & Round Ring	1	038753741680	22	219
74169	4"	PVC Hub Base General Purpose Cleanout w/ 6" NI Cover & Round Ring	1	038753741697	22	219
74170	6"	IPS Adj. Barrel & 6" Round NI Cover & Square Ring	1	038753741703	22	227
74173	3" or 4 "	PVC Adj. Commercial Cleanout w/ 6" NI Cover & Square Ring	1	038753741734	22	217
74174	4"	PVC Adj. Commercial Cleanout w/ 6" NI Cover & Square Ring	1	038753741741	22	217
74176	6"	PVC Adj. Commercial Cleanout w/ 6" NI Cover & Square Ring	1	038753741765	22	217
74177	3" or 4"	PVC General Purpose Cleanout w/ 6" NI Cover & Square Ring	1	038753741772	22	220
74178	4"	PVC Pipe Base General Purpose Cleanout w/ 6" NI Cover & Square Ring	1	038753741789	22	220
74179	4"	PVC Hub Base General Purpose Cleanout w/ 6" NI Cover & Square Ring	1	038753741796	22	220



Product No.	Size	Description	Ctn. Qty.	UPC	Category	Page Number
74180	6"	IPS Adj. Barrel & 6" Round CHR Cover	1	038753741802	22	227
74182	2"	PVC Adj. Commercial Cleanout w/ 6" CHR Cover	1	038753741826	22	216
74183	3" or 4 "	PVC Adj. Commercial Cleanout w/ 6" CHR Cover	1	038753741833	22	216
74184	4"	PVC Adj. Commercial Cleanout w/ 6" CHR Cover	1	038753741840	22	216
74186	6"	PVC Adj. Commercial Cleanout w/ 6" CHR Cover	1	038753741864	22	216
74187	3" or 4"	PVC General Purpose Cleanout w/ 6" CHR Cover	1	038753741871	22	220
74186	4"	PVC Pipe Base General Purpose Cleanout w/ 6" CHR Cover	1	038753741868	22	219
74189	4"	PVC Hub Base General Purpose Cleanout w/ 6" CHR Cover	1	038753741895	22	219
74190	6"	IPS Adj. Barrel & 6" Round CHR Cover & Ring	1	038753741901	22	227
74192	2"	PVC Adj. Commercial Cleanout w/ 6" CHR Cover & Round Ring	1	038753741925	22	216
74193	3" or 4 "	PVC Adj. Commercial Cleanout w/ 6" CHR Cover & Round Ring	1	038753741932	22	216
74194	4"	PVC Adj. Commercial Cleanout w/ 6" CHR Cover & Round Ring	1	038753741949	22	217
74196	6"	PVC Adj. Commercial Cleanout w/ 6" CHR Cover & Round Ring	1	038753741963	22	217
74197	3" or 4"	PVC General Purpose Cleanout w/ 6" CHR Cover & Round Ring	1	038753741970	22	219
74198	4"	PVC Pipe Base General Purpose Cleanout w/ 6" CHR Cover & Round Ring	1	038753741987	22	219
74199	4"	PVC Hub Base General Purpose Cleanout w/ 6" CHR Cover & Round Ring	1	038753741994	22	219
74200	6"	IPS Adj. Barrel & 6" Round CHR Cover & Square Ring	1	038753742007	22	227
74202	2"	PVC Adj. Commercial Cleanout w/ 6" CHR Cover & Square Ring	1	038753742021	22	217
74203	3" or 4 "	PVC Adj. Commercial Cleanout w/ 6" CHR Cover & Square Ring	1	038753742038	22	217
74204	4"	PVC Adj. Commercial Cleanout w/ 6" CHR Cover & Square Ring	1	038753742045	22	217
74206	6"	PVC Adj. Commercial Cleanout w/ 6" CHR Cover & Square Ring	1	038753742069	22	217
74207	3" or 4"	PVC General Purpose Cleanout w/ 6" CHR Cover & Square Ring	1	038753742076	22	220
74208	4"	PVC Pipe Base General Purpose Cleanout w/ 6" CHR Cover & Square Ring	1	038753742083	22	220
74209	4"	PVC Hub Base General Purpose Cleanout w/ 6" CHR Cover & Square Ring	1	038753742090	22	220
74212	2"	PVC Adj. Commercial Cleanout w/ 6" Cast BR Cover & Round Top	1	038753742120	22	218
74214	4"	PVC Adj. Commercial Cleanout w/ 6" Cast BR Cover & Round Top	1	038753742144	22	218
74216	6"	PVC Adj. Commercial Cleanout w/ 6" Cast BR Cover & Round Top	1	038753742168	22	218
74217	3" or 4"	PVC General Purpose Cleanout w/ 6" Cast BR Cover & Round Top	1	038753742175	22	220
74218	4"	PVC Pipe Base General Purpose Cleanout w/ 6" Cast BR Cover & Round Top	1	038753742182	22	220
74219	4"	PVC Hub Base General Purpose Cleanout w/ 6" Cast BR Cover & Round Top	1	038753742199	22	220
74222	2"	PVC Adj. Commercial Cleanout w/ 6" Cast NI Cover & Round Top	1	038753742229	22	218
74223	3" or 4 "	PVC Adj. Commercial Cleanout w/ 6" Cast NI Cover & Round Top	1	038753742236	22	218
74224	4"	PVC Adj. Commercial Cleanout w/ 6" Cast NI Cover & Round Top	1	038753742243	22	218

NUMERICAL LISTING



Product No.	Size	Description	Ctn. Qty.	UPC	Category	Page Number
74226	6"	PVC Adj. Commercial Cleanout w/ 6" Cast NI Cover & Round Top	1	038753742267	22	218
74227	3" or 4"	PVC General Purpose Cleanout w/ 6" Cast NI Cover & Round Top	1	038753742274	22	220
74228	4"	PVC Pipe Base General Purpose Cleanout w/ 6" Cast NI Cover & Round Top	1	038753742281	22	220
74229	4"	PVC Hub Base General Purpose Cleanout w/ 6" Cast NI Cover & Round Top	1	038753742298	22	220
74232	2"	PVC Adj. Commercial Cleanout w/ 6" Cast CHR Cover & Round Top	1	038753742328	22	218
74233	3" or 4 "	PVC Adj. Commercial Cleanout w/ 6" Cast CHR Cover & Round Top	1	038753742335	22	218
74234	4"	PVC Adj. Commercial Cleanout w/ 6" Cast CHR Cover & Round Top	1	038753742342	22	218
74236	6"	PVC Adj. Commercial Cleanout w/ 6" Cast CHR Cover & Round Top	1	038753742366	22	218
74237	3" or 4"	PVC General Purpose Cleanout w/ 6" Cast CHR Cover & Round Top	1	038753742373	22	220
74238	4"	PVC Pipe Base General Purpose Cleanout w/ 6" Cast CHR Cover & Round Top	1	038753742380	22	220
74239	4"	PVC Hub Base General Purpose Cleanout w/ 6" Cast CHR Cover & Round Top	1	038753742397	22	220
743GDFBN-1	1-1/2" x 1-1/4"	Wash Code P-Trap w/Deep Flange & Brass Nuts	10	041193003980	15	132
747GDFBN-1	1-1/2" x 1-1/4"	Wash Code P-Trap w/Cleanout, Deep Flange & Brass Nuts	10	041193003973	15	132
750-1	1-1/2"	Repair Trap - 17 Ga. w/ Reducing Poly Washer	10	041193124616	15	132
750-3	1-1/2"	Repair Trap - 17 Ga. w/ Reducing Poly Washer, Unfinished	10	041193124623	15	132
7505		Samson Force Cup Plunger w/ 18" Handle	5	041193024879	17	171
7520		Three Way Rubber Flapper	25	041193124685	17	171
7536C		1" - 1-3/8" Fit-All White Sink Stopper w/Metal Ring	24	041193025708	17	177
7537C		1-1/2" -2" White Tub Stopper w/ Metal Ring	24	041193025807	17	178
7555		6-3/4" Form Fit Closet Bowl Sponge Rubber Gasket	10	041193055101	17	171
7556		5-3/4" O.D. x 3-1/2" Closet Bowl Sponge Rubber Gasket	10	041193124739	17	171
7557		3-1/4" O.D x 2-1/8" Tank to Bowl Sponge Rubber Gasket for Close Couple Connection	24	041193055118	17	171
758-1	1-1/4"	Pop-Up Assembly, 2 Piece, Chrome	10	041193013873	15	140
758U-3	1-1/4"	Pop-Up Assembly, 2 Piece, UltraShine® Polished Brass	10	041193013903	15	140
759-1	1-1/4"	Pop-Up Assembly, 1 Piece, Chrome - 20 Ga.	10	041193055132	15	140
759PB-3	1-1/4"	Pop-Up Assembly, 1 Piece, Polished Brass - 20 Ga.	12	041193093943	15	140
760-1		Semi-Cast Grid Patent Overflow Plug w/ 1-1/4" x 6" - 17 Ga. Tailpiece	25	041193124777	15	140
76012	2"	PVC Sediment Drain, Plastic Grate w/ Bucket	1	038753760124	22	221
76013	3"	PVC Sediment Drain, Plastic Grate w/ Bucket	1	038753760131	22	221
76014	4"	PVC Sediment Drain, Plastic Grate w/ Bucket	1	038753760148	22	221
76016	6"	PVC Sediment Drain, Plastic Grate w/ Bucket	1	038753760162	22	221
76022	2"	PVC Sediment Drain, Plastic Grate w/o Bucket	1	038753760223	22	221
76023	3" or 4 "	PVC Sediment Drain, Plastic Grate w/o Bucket	1	038753760230	22	221
76024	4"	PVC Sediment Drain, Plastic Grate w/o Bucket	1	038753760237	22	221
76026	6"	PVC Sediment Drain, Plastic Grate w/o Bucket	1	038753760261	22	221
76032	2"	PVC Sediment Drain, Cast Iron Grate w/ Bucket	1	038753760322	22	221
76033	3" or 4 "	PVC Sediment Drain, Cast Iron Grate w/ Bucket	1	038753760339	22	221
76034	4"	PVC Sediment Drain, Cast Iron Grate w/ Bucket	1	038753760346	22	221
76036	6"	PVC Sediment Drain, Cast Iron Grate w/ Bucket	1	038753760360	22	221



Product No.	Size	Description	Ctn. Qty.	UPC	Category	Page Number
76042	2"	PVC Sediment Drain, Cast Iron Grate w/o Bucket	1	038753760421	22	221
76043	3" or 4 "	PVC Sediment Drain, Cast Iron Grate w/o Bucket	1	038753760438	22	221
76044	4"	PVC Sediment Drain, Cast Iron Grate w/o Bucket	1	038753760445	22	221
76046	6"	PVC Sediment Drain, Cast Iron Grate w/o Bucket	1	038753760469	22	221
760W-1		Semi-Cast Grid Wheelchair Patent Overflow Plug w/ 1-1/4" - 17 Ga. Tailpiece	10	041193124821	15	142
761-1		Semi-Cast Grid Patent Overflow Plug w/ 1-1/2" x 6" - 17 Ga. Tailpiece	25	041193124890	15	142
763-1	1-1/4" x 5"	Patent Overflow Plug Ind. Boxed 2 Pc. - 20 Ga.	10	041193012463	15	141
7633C		6' High Pressure Washing Machine Hose	6	041193026200	17	177
763K-1	1-1/4" x 5"	Center Outlet Plug Ind. Boxed 2 Pc. Less Overflow - 20 Ga.	10	041193124937	15	141
764-1	1-1/4" x 6"	Patent Overflow Plug Ind. Boxed 2 Pc. - 20 Ga.	10	041193125255	15	141
764A-1	1-1/4" x 8"	Patent Overflow Plug Ind. Boxed 2 Pc. - 20 Ga.	10	041193006028	15	141
765-1	1-1/4" x 12"	Patent Overflow Plug Ind. Boxed 2 Pc. - 20 Ga.	10	041193050175	15	141
774		Duplex Sink Strainer, Brass Body w/ Flat Stainless Steel Strainer for 2-1/2" Opening	12	041193055187	17	168
774A		Tray Plug Sink Basket Strainer, Brass Body w/ Rubber Stopper for 2-1/2" Opening	12	041193049940	17	168
774BN		Same as 774 w/ Brass Nuts	12	041193011725	17	168
774T		Same as 774 w/ 4" Chrome Plated Tailpiece	12	041193125422	17	168
780-1	6"	Bell Flange Escutcheon, covers 1-1/2" Schedule 40 Pipe	10	041193014498	15	141
78012	2"	PVC Roof Drain w/ Plastic Dome	1	038753780122	22	222
78013	3" or 4 "	PVC Roof Drain w/ Plastic Dome	1	038753780139	22	222
78014	4"	PVC Roof Drain w/ Plastic Dome	1	038753780146	22	222
78016	6"	PVC Roof Drain w/ Plastic Dome	1	038753780160	22	222
78022	2"	PVC Roof Drain w/ Cast Iron Dome	1	038753780221	22	222
78023	3" or 4 "	PVC Roof Drain w/ Cast Iron Dome	1	038753780238	22	222
78024	4"	PVC Roof Drain w/ Cast Iron Dome	1	038753780245	22	222
78026	6"	PVC Roof Drain w/ Cast Iron Dome	1	038753780269	22	222
78032	2"	PVC Roof Drain w/ ABS Dome & Dam Collar	1	038753780320	22	222
78033	3" or 4 "	PVC Roof Drain w/ ABS Dome & Dam Collar	1	038753780337	22	222
78034	4"	PVC Roof Drain w/ ABS Dome & Dam Collar	1	038753780344	22	222
78036	6"	PVC Roof Drain w/ ABS Dome & Dam Collar	1	038753780368	22	222
78042	2"	PVC Roof Drain w/ Cast Iron Dome & Dam Collar	1	038753780429	22	222
78043	3" or 4 "	PVC Roof Drain w/ Cast Iron Dome & Dam Collar	1	038753780436	22	222
78044	4"	PVC Roof Drain w/ Cast Iron Dome & Dam Collar	1	038753780443	22	222
78046	6"	PVC Roof Drain w/ Cast Iron Dome & Dam Collar	1	038753780467	22	222
786-1	1-1/4" x 6"	Extension Tube w/ Solder Joint - Budget Ga.	10	041193050250	15	137
786A-1	1-1/4" x 8"	Extension Tube w/ Solder Joint - Budget Ga.	10	041193050267	15	137
787A-1	1-1/4" x 12"	Extension Tube w/ Solder Joint - Budget Ga.	10	041193050274	15	137
787A-17-1	1-1/4" x 12"	Extension Tube w/ Solder Joint - 17 Ga.	10	041193080035	15	137
788A-1	1-1/2" x 8"	Extension Tube w/ Solder Joint - Budget Ga.	10	041193050298	15	137
789A-1	1-1/2" x 12"	Extension Tube w/ Solder Joint - Budget Ga.	10	041193125590	15	137
789A-17-1	1-1/2" x 12"	Extension Tube w/ Solder Joint - 17 Ga.	10	041193080059	15	137
789A-17-3	1-1/2" x 12"	Extension Tube w/ Solder Joint - 17 Ga., Unfinished	10	041193015808	15	137
78A-1	1-1/2" x 16"	Center To Center, Slip Joint w/ Baffle Tee - 20 Ga.	10	041193125453	15	135
78A-17-1	1-1/2" x 16"	Center To Center, Slip Joint w/ Baffle Tee - 17 Ga.	10	041193125439	15	135
78A-17BN-1	1-1/2" x 16"	Center To Center, Slip Joint w/ Baffle Tee - 17 Ga. w/ Brass Nuts	10	041193125446	15	135
790-1	1-1/4" x 6"	Extension Tube w/ Slip Joint - Budget Ga.	10	041193005779	15	137

NUMERICAL LISTING



Product No.	Size	Description	Ctn. Qty.	UPC	Category	Page Number
790-17-1	1-1/4" x 6"	Extension Tube w/ Slip Joint - 17 Ga.	10	041193055200	15	137
790-17BN-1	1-1/4" x 6"	Extension Tube w/ Slip Joint - 17 Ga. w/ Brass Nut	10	041193125620	15	137
790-20-1	1-1/4" x 6"	Extension Tube w/ Slip Joint - 20 Ga.	10	041193125637	15	137
790A-1	1-1/4" x 8"	Extension Tube w/ Slip Joint - Budget Ga.	10	041193050229	15	137
790A-17-1	1-1/4" x 8"	Extension Tube w/ Slip Joint - 17 Ga.	10	041193055194	15	137
790A-17BN-1	1-1/4" x 8"	Extension Tube w/ Slip Joint - 17 Ga. w/ Brass Nut	10	041193125644	15	137
790A-20-1	1-1/4" x 8"	Extension Tube w/ Slip Joint - 20 Ga.	10	041193125651	15	137
791A-1	1-1/4" x 12"	Extension Tube w/ Slip Joint - Budget Ga.	10	041193005946	15	137
791A-17-1	1-1/4" x 12"	Extension Tube w/ Slip Joint - 17 Ga.	10	041193055217	15	137
791A-17BN-1	1-1/4" x 12"	Extension Tube w/ Slip Joint - 17 Ga. w/ Brass Nut	10	041193125682	15	137
791A-20-1	1-1/4" x 12"	Extension Tube w/ Slip Joint - 20 Ga.	10	041193125699	15	137
791A-20BN-1	1-1/4" x 12"	Extension Tube w/ Slip Joint- 20 Ga. w/ Brass Nuts	10	041193125705	15	137
791B-1	1-1/4" x 12"	Double Slip Joint Extension Tube - Budget Ga.	5	041193125712	15	140
791B-17BN-1	1-1/4" x 24"	Extension Tube w/ Slip Joint - 17 Ga. w/ Brass Nut	10	041193015686	15	137
791BD-1	1-1/4" x 16"	Double Slip Joint Extension Tube - Budget Ga.	5	041193125729	15	140
791BD-20BN-1	1-1/4" x 16"	Double Slip Joint Extension Tube - 20 Ga. w/ Brass Nuts	5	041193125736	15	140
792-1	1-1/2" x 6"	Extension Tube w/ Slip Joint - Budget Ga.	10	041193005786	15	137
792-17-1	1-1/2" x 6"	Extension Tube w/ Slip Joint - 17 Ga.	10	041193055231	15	137
792-20-1	1-1/2" x 6"	Extension Tube w/ Slip Joint - 20 Ga.	10	041193125767	15	137
792A-1	1-1/2" x 8"	Extension Tube w/ Slip Joint - Budget Ga.	10	041193050236	15	137
792A-17-1	1-1/2" x 8"	Extension Tube w/ Slip Joint - 17 Ga.	10	041193055224	15	137
792A-17BN-1	1-1/2" x 8"	Extension Tube w/ Slip Joint - 17 Ga. w/ Brass Nut	10	041193125781	15	137
792A-20-1	1-1/2" x 8"	Extension Tube w/ Slip Joint - 20 Ga.	10	041193125798	15	137
792A-20BN-1	1-1/2" x 8"	Extension Tube w/ Slip Joint - 20 Ga. w/ Brass Nut	10	041193125811	15	137
793A-1	1-1/2" x 12"	Extension Tube w/ Slip Joint - Budget Ga.	10	041193050243	15	137
793A-17-1	1-1/2" x 12"	Extension Tube w/ Slip Joint - 17 Ga.	10	041193055248	15	137
793A-17BN-1	1-1/2" x 12"	Extension Tube w/ Slip Joint - 17 Ga. w/ Brass Nut	10	041193125835	15	137
793A-17BN-3	1-1/2" x 12"	Extension Tube w/ Slip Joint - 17 Ga. w/ Brass Nut, Unfinished	10	041193015716	15	137
793A-20-1	1-1/2" x 12"	Extension Tube w/ Slip Joint - 20 Ga.	10	041193125842	15	137
793A-20BN-1	1-1/2" x 12"	Extension Tube w/ Slip Joint - 20 Ga. w/ Brass Nut	10	041193125859	15	137
793A-20BN-3	1-1/2" x 12"	Extension Tube w/ Slip Joint - 20 Ga. w/ Brass Nut, Unfinished	10	041193125866	15	137
793B-1	1-1/2" x 12"	Double Slip Joint Extension Tube - Budget Ga.	5	041193125873	15	140
793BD-1	1-1/2" x 16"	Double Slip Joint Extension Tube - Budget Ga.	5	041193125880	15	140
793BD-20BN-1	1-1/2" x 16"	Double Slip Joint Extension Tube - 20 Ga. w/ Brass Nuts	5	041193125897	15	140
793BD-20BN-3	1-1/2" x 16"	Double Slip Joint Extension Tube - 20 Ga. w/ Brass Nuts, Unfinished	5	041193125903	15	140
793C-1	1-1/4" x 2"	Double Slip Joint Connection - 20 Ga.	10	041193011794	15	140
793D-1	1-1/2" x 2"	Double Slip Joint Connection - 20 Ga.	10	041193012432	15	140
794-17BN-1	1-1/2" x 24"	Extension Tube w/ Slip Joint - 17 Ga. w/ Brass Nut	10	041193009722	15	137
795-1	1-1/2" x 1-1/4" x 6"	Flanged Strainer Tailpiece - 20 Ga.	10	041193065476	15	138
796-1	1-1/2" x 1-1/4" x 8"	Flanged Strainer Tailpiece - 20 Ga.	10	041193125910	15	138
798-1	1-1/2" x 1-1/4" x 12"	Flanged Strainer Tailpiece - 20 Ga.	10	041193125958	15	138
7981FW		Four Way Key	12	041193125965	17	171
7983		Dishwasher Disposal Hose Connector	50	041193125972	17	177
799-1	1-1/2" x 4"	Flanged Strainer Tailpiece - Budget Ga.	10	041193006059	15	138
799-17-1	1-1/2" x 4"	Flanged Strainer Tailpiece, 17 Ga., Unfinished	10	041193007025	15	138



Product No.	Size	Description	Ctn. Qty.	UPC	Category	Page Number
799-17-3	1-1/2" x 4"	Flanged Strainer Tailpiece -17 Ga.	10	041193019035	15	138
799-3	1-1/2" x 4"	Flanged Strainer Tailpiece - Budget Ga., Unfinished	10	041193125989	15	138
79A-1	1-1/2" x 16"	Center To Center, Slip Joint w/ Baffle Tee - 20 Ga.	5	041193125606	15	135
80		Shower Rod Flange w/Screws (bagged 1 pair)	24	041193055439	17	178
800-1	1-1/2" x 6"	Flanged Strainer Tailpiece - Budget Ga.	10	041193005731	15	138
800-17-1	1-1/2" x 6"	Flanged Strainer Tailpiece -17 Ga.	10	041193055446	15	138
800-17-3	1-1/2" x 6"	Flanged Strainer Tailpiece -17 Ga., Unfinished	10	041193013224	15	138
800-20-1	1-1/2" x 6"	Flanged Strainer Tailpiece - 20 Ga.	10	041193126023	15	138
80002	2"	ABS Base	1	038753800028	22	223
80003	3" or 4 "	ABS Base	1	038753800035	22	223
80004	4"	ABS Base	1	038753800042	22	223
80006	6"	ABS Base	1	038753800066	22	223
80007	3" or 4"	ABS Pipe Fit Drain Base	1	038753800073	22	224
80008	4"	ABS Pipe Fit Drain	1	038753800080	22	224
80009	4"	ABS Hub Fit Drain	1	038753800097	22	224
8000E		Air Gap, Plastic, Boxed	24	041193089410	15	152
80010	5"	SS Grate	1	038753800103	22	225
80020	5"	Round BR Grate	1	038753800202	22	225
80030	5"	Round BR Grate & Ring	1	038753800301	22	225
80040	5"	Round BR Grate & Square Ring	1	038753800400	22	225
80050	5"	Round NI Grate	1	038753800509	22	225
8006		1-1/2" x 1-1/2" Slip Nut w/ Washer, Chrome Plated	50	041193126146	17	172
80060	5"	Round NI Grate & Ring	1	038753800608	22	225
8006R		1-1/2" x 1-1/2" Brass Nut, Unfinished	50	041193015938	17	172
8007		1-1/4" x 1-1/4" Slip Nut w/ Washer, Chrome Plated	50	041193126153	17	172
80070	5"	Round NI Grate & Square Ring	1	038753800707	22	225
8008		1-1/2" x 1-1/4" Slip Nut w/ Washer, Chrome Plated	50	041193126160	17	172
80080	5"	Round CHR Grate	1	038753800806	22	225
8009		1-1/2" x 1-3/8" Slip Nut w/ Washer, Chrome Plated	50	041193126177	17	172
80090	5"	Round CHR Grate & Ring	1	038753800905	22	225
801-1	1-1/2" x 8"	Flanged Strainer Tailpiece - Budget Ga.	10	041193005748	15	138
801-17-1	1-1/2" x 8"	Flanged Strainer Tailpiece -17 Ga.	10	041193126184	15	138
801-17-3	1-1/2" x 8"	Flanged Strainer Tailpiece -17 Ga., Unfinished	10	041193013231	15	138
801-20-1	1-1/2" x 8"	Flanged Strainer Tailpiece - 20 Ga.	10	041193126191	15	138
801-20-3	1-1/2" x 8"	Flanged Strainer Tailpiece - 20 Ga., Unfinished	10	041193126207	15	138
80100	5"	Round CHR Grate & Square Ring	1	038753801001	22	225
8011		2" x 2" Slip Nut w/ Washer, Chrome Plated	25	041193126238	17	172
80110	6"	SS Grate	1	038753801100	22	225
80120	6"	Round BR Grate	1	038753801209	22	225
80130	6"	Round BR Grate & Ring	1	038753801308	22	225
80140	6"	Round BR Grate & Square Ring	1	038753801407	22	225
80150	6"	Round NI Grate	1	038753801506	22	225
80160	6"	Round NI Grate & Ring	1	038753801605	22	225
80170	6"	Round NI Grate & Square Ring	1	038753801704	22	225
80190	6"	Round CHR Grate & Ring	1	038753801902	22	225
80200	6"	Round CHR Grate & Square Ring	1	038753802008	22	225
803-1	1-1/2" x 12"	Flanged Strainer Tailpiece - Budget Ga.	10	041193005762	15	138
803-17-1	1-1/2" x 12"	Flanged Strainer Tailpiece -17 Ga.	10	041193126269	15	138
803-17-3	1-1/2" x 12"	Flanged Strainer Tailpiece -17 Ga., Unfinished	10	041193016102	15	138

NUMERICAL LISTING



Product No.	Size	Description	Ctn. Qty.	UPC	Category	Page Number
803-20-1	1-1/2" x 12"	Flanged Strainer Tailpiece - 20 Ga.	10	041193126276	15	138
803-20-3	1-1/2" x 12"	Flanged Strainer Tailpiece - 20 Ga., Unfinished	10	041193126283	15	138
8030		1-1/4" x 1-1/4" Die Cast Nut, Chrome Plated	50	041193006332	17	173
8030LW		1-1/4" x 1-1/4" Die Cast Nut, Chrome Plated, Less Washer	100	041193055453	17	173
8031		1-1/2" x 1-1/4" Die Cast Nut, Chrome Plated	50	041193050083	17	173
8031LW		1-1/2" x 1-1/4" Die Cast Nut, Chrome Plated, Less Washer	100	041193055460	17	173
8032		1-1/2" x 1-3/8" Die Cast Nut, Chrome Plated	50	041193055477	17	173
8033		1-1/2" x 1-1/2" Die Cast Nut, Chrome Plated	50	041193006349	17	173
8033LW		1-1/2" x 1-1/2" Die Cast Nut, Chrome Plated, Less Washer	100	041193055491	17	173
8034		2" x 2" Die Cast Nut, Chrome Plated	25	041193049384	17	173
8035		2" x 1-1/2" Die Cast Nut, Chrome Plated	25	041193126351	17	173
8036S	32 oz.	Prime-Tite Blue Primer	12	083675080362	1	25
803A-1	1-1/2" x 1-1/4" x 8"	Extension Tube, Threaded One End - 17 Ga.	10	041193126306	15	138
803BD-1	1-1/2" x 12"	Double Flanged Strainer Tailpiece - Budget Ga.	10	041193126313	15	138
803ED-1	1-1/2" x 16"	Double Flanged Strainer Tailpiece - Budget Ga.	10	041193126320	15	138
803ED-17-1	1-1/2" x 16"	Double Flanged Strainer Tailpiece -17 Ga.	10	041193081445	15	138
803ED-17-3	1-1/2" x 16"	Double Flanged Strainer Tailpiece -17 Ga., Unfinished	10	041193013248	15	138
803ED-20-1	1-1/2" x 16"	Double Flanged Strainer Tailpiece. - 20 Ga.	10	041193126337	15	138
803ED-20-3	1-1/2" x 16"	Double Flanged Strainer Tailpiece - 20 Ga., Unfinished	10	041193126344	15	138
8046S	16 oz.	Prime-Tite Blue Primer	24	083675080461	1	25
8056S	8 oz.	Prime-Tite Blue Primer	24	083675080560	1	25
81120	6"	Round BR Cover	1	038753811208	22	226
81130	6"	Round BR Cover & Ring	1	038753811307	22	226
81140	6"	Round BR Cover & Square Ring	1	038753811406	22	226
81150	6"	Round NI Cover	1	038753811505	22	226
81160	6"	Round NI BR Cover & Ring	1	038753811604	22	226
81170	6"	Round NI Cover & Square Ring	1	038753811703	22	226
81180	6"	Round CHR Cover	1	038753811802	22	226
81190	6"	Round CHR Cover & Ring	1	038753811901	22	226
81200	6"	Round CHR Cover & Square Ring	1	038753812007	22	226
812A-1	1-1/2" x 6"	Branch Tailpiece, 1/2" Nominal Sweat Branch, Budget Ga.	10	041193126443	15	139
812B-1	1-1/2" x 8"	Branch Tailpiece, 1/2" Nominal Sweat Branch, Budget Ga.	10	041193126450	15	139
812B-17BN-3	1-1/2" x 8"	Branch Tailpiece DC, 1/2" Nominal Sweat Branch, 17 Ga. w/ Brass Nut, Unfinished	10	041193016096	15	139
812B-3	1-1/2" x 8"	Branch Tailpiece, 1/2" Nominal Sweat Branch, Budget Ga., Unfinished	10	041193126467	15	139
813B-1	1-1/2" x 8"	Branch Tailpiece, 3/4" Hose or 1/2" Nominal Sweat, Budget Ga.	10	041193055569	15	139
814A-1	1-1/2" x 6"	Branch Tailpiece, Hose & Clamp - Budget Ga.	10	041193071286	15	139
814B-1	1-1/2" x 8"	Branch Tailpiece, Hose & Clamp - Budget Ga.	10	041193049834	15	139
814B-17-1	1-1/2" x 8"	Branch Tailpiece, Hose & Clamp - 17 Ga.	10	041193007278	15	139
814BBN-1	1-1/2" x 8"	Branch Tailpiece, Hose & Clamp w/ Brass Nuts - 20 Ga.	10	041193090324	15	139
814ET-1	1-1/2" x 8"	Branch Tailpiece, Hose & Clamp, Slip Joint Top - 20 Ga., 7/8" Branch (Nut Down)	10	041193126511	15	139
814ET-17-1	1-1/2" x 8"	Branch Tailpiece, Hose & Clamp, Slip Joint Top - 17 Ga., 7/8" Branch (Nut Down)	10	041193007292	15	139



Product No.	Size	Description	Ctn. Qty.	UPC	Category	Page Number
814ETBN-1	1-1/2" x 8"	Branch Tailpiece, Hose & Clamp, Slip Joint Top, 20 Ga. w/ Brass Nut, 7/8" Branch (Nut Down)	10	041193126528	15	139
814ETBN-3	1-1/2" x 8"	Branch Tailpiece, Hose & Clamp, Slip Joint Top - 20 Ga. w/ Brass Nut, 7/8" Branch (Nut Down), Unfinished	10	041193126535	15	139
814TA-1	1-1/2" x 6"	Branch Tailpiece, Hose & Clamp, Threaded Top - 20 Ga.	10	041193126559	15	139
814TB-1	1-1/2" x 8"	Branch Tailpiece, Hose & Clamp, Threaded Top - 20 Ga.	10	041193055576	15	139
815B		Flat Top Sink Basket Strainer, Brass Body and Stainless Steel Strainer. Length - 1-7/8"	12	041193006134	17	168
815BT		Same as 815B w/ 4" Chrome Plated Tailpiece	12	041193126634	17	168
816		Cast Brass Body Sink Basket Strainer, Stainless Steel Basket w/ Brass Slide Post, Cast Brass Stopper and Brass Locknut. Heavy Duty Commercial Grade.	24	041193057648	17	167
816T		Same as Above w/ 4" Chrome Plated 17 Ga. Tailpiece	24	041193126719	17	167
817ET-1	1-1/4" x 8"	Branch Tailpiece, Hose & Clamp, Slip Joint Top - 20 Ga., (Nut Down)	10	041193126764	15	139
817ETBN-1	1-1/4" x 8"	Branch Tailpiece, Hose & Clamp, Slip Joint Top - 20 Ga. w/ Brass Nut (Nut Down)	10	041193090331	15	139
817ETBN-3	1-1/4" x 8"	Branch Tailpiece, Hose & Clamp, Slip Joint Top - 20 Ga. w/ Brass Nut, Unfinished (Nut Down)	10	041193093639	15	139
817TB-1	1-1/4" x 8"	Branch Tailpiece, Hose & Clamp, Threaded Top - 20 Ga., 7/8" Branch	10	041193126771	15	139
819-1	1-1/4" x 6"	Extension Tube, Threaded Both Ends - 20 Ga.	10	041193126894	15	138
81940	3/8"	10 x 24 Stainless Steel Vandal Proof Screw	10	038753819402	22	226
81950	3/8 "	10 x 24 Brass Vandal Proof Screw	10	038753819501	22	226
81A-1	1-1/2" x 16"	Center To Center, Hi-Line w/ Baffle Tee - 20 Ga.	10	041193126412	15	135
8201		1/2" NPT Cadmium Plated Steel Pipe Repair Clamp w/ Neoprene Gasket	6	041193049193	17	172
82012	2"	ABS Adj. Commercial Drain w/ 5" SS Grate	1	038753820125	22	200
82013	3" or 4"	ABS Adj. Commercial Drain w/ 5" SS Grate	1	038753820132	22	200
82014	4"	ABS Adj. Commercial Drain w/ 5" SS Grate	1	038753820149	22	200
82016	6"	ABS Adj. Commercial Drain w/ 5" SS Grate	1	038753820163	22	200
82017	3" or 4"	ABS General Purpose Drain w/ 5" SS Grate	1	038753820170	22	209
82018	4"	ABS Pipe Base General Purpose Drain w/ 5" SS Grate	1	038753820187	22	209
82019	4"	ABS Hub Base General Purpose Drain w/ 5" SS Grate	1	038753820194	22	209
8202		3/4" NPT Cadmium Plated Steel Pipe Repair Clamp w/ Neoprene Gasket	6	041193049216	17	172
82022	2"	ABS Adj. Commercial Drain w/ 5" BR Grate	1	038753820224	22	200
82023	3" or 4"	ABS Adj. Commercial Drain w/ 5" BR Grate	1	038753820231	22	200
82024	4"	ABS Adj. Commercial Drain w/ 5" BR Grate	1	038753820248	22	200
82026	6"	ABS Adj. Commercial Drain w/ 5" BR Grate	1	038753820262	22	200
82027	3" or 4"	ABS General Purpose Drain w/ 5" BR Grate	1	038753820279	22	209
82028	4"	ABS Pipe Base General Purpose Drain w/ 5" BR Grate	1	038753820286	22	209
82029	4"	ABS Hub Base General Purpose Drain w/ 5" BR Grate	1	038753820293	22	209
8203		1" NPT Cadmium Plated Steel Pipe Repair Clamp w/ Neoprene Gasket	10	041193049209	17	172
82032	2"	ABS Adj. Commercial Drain w/ 5" BR Grate & Round Ring	1	038753820323	22	203
82033	3" or 4"	ABS Adj. Commercial Drain w/ 5" BR Grate & Round Ring	1	038753820330	22	203
82034	4"	ABS Adj. Commercial Drain w/ 5" BR Grate & Round Ring	1	038753820347	22	203
82036	6"	ABS Adj. Commercial Drain w/ 5" BR Grate & Round Ring	1	038753820361	22	203
82037	3" or 4"	ABS General Purpose Drain w/ 5" BR Grate & Round Ring	1	038753820378	22	212
82038	4"	ABS Pipe Base General Purpose Drain w/ 5" BR Grate & Round Ring	1	038753820385	22	212
82039	4"	ABS Hub Base General Purpose Drain w/ 5" BR Grate & Round Ring	1	038753820392	22	212

NUMERICAL LISTING



Product No.	Size	Description	Ctn. Qty.	UPC	Category	Page Number
8204		1-1/4" NPT Cadmium Plated Steel Pipe Repair Clamp w/ Neoprene Gasket	6	041193049223	17	172
82042	2"	ABS Adj. Commercial Drain w/ 5" BR Grate & Square Ring	1	038753820422	22	202
82043	3" or 4"	ABS Adj. Commercial Drain w/ 5" BR Grate & Square Ring	1	038753820439	22	202
82044	4"	ABS Adj. Commercial Drain w/ 5" BR Grate & Square Ring	1	038753820446	22	202
82046	6"	ABS Adj. Commercial Drain w/ 5" BR Grate & Square Ring	1	038753820460	22	202
82047	3" or 4"	ABS General Purpose Drain w/ 5" BR Grate & Square Ring	1	038753820477	22	210
82048	4"	ABS Pipe Base General Purpose Drain w/ 5" Br Grate & Square Ring	1	038753820484	22	210
82049	4"	ABS Hub Base General Purpose Drain w/ 5" Br Grate & Square Ring	1	038753820491	22	210
82052	2"	ABS Adj. Commercial Drain w/ 5" NI Grate	1	038753820521	22	200
82053	3" or 4"	ABS Adj. Commercial Drain w/ 5" NI Grate	1	038753820538	22	200
82054	4"	ABS Adj. Commercial Drain w/ 5" NI Grate	1	038753820545	22	200
82056	6"	ABS Adj. Commercial Drain w/ 5" NI Grate	1	038753820569	22	200
82057	3" or 4"	ABS General Purpose Drain w/ 5" NI Grate	1	038753820576	22	209
82058	4"	ABS Pipe Base General Purpose Drain w/ 5" NI Grate	1	038753820583	22	209
82059	4"	ABS Hub Base General Purpose Drain w/ 5" NI Grate	1	038753820590	22	209
8205B		1-1/2" NPT Cadmium Plated Steel Pipe Repair Clamp w/ Neoprene Gasket	1	041193049230	17	172
82062	2"	ABS Adj. Commercial Drain w/ 5" NI Grate & Round Ring	1	038753820620	22	201
82063	3" or 4"	ABS Adj. Commercial Drain w/ 5" NI Grate & Round Ring	1	038753820637	22	201
82064	4"	ABS Adj. Commercial Drain w/ 5" NI Grate & Round Ring	1	038753820644	22	201
82066	6"	ABS Adj. Commercial Drain w/ 5" NI Grate & Round Ring	1	038753820668	22	201
82067	3" or 4"	ABS General Purpose Drain w/ 5" NI Grate & Round Ring	1	038753820675	22	210
82068	4"	ABS Pipe Base General Purpose Drain w/ 5" NI Grate & Round Ring	1	038753820682	22	210
82069	4"	ABS Hub Base General Purpose Drain w/ 5" NI Grate & Round Ring	1	038753820699	22	210
82072	2"	ABS Adj. Commercial Drain w/ 5" NI Grate & Square Ring	1	038753820729	22	202
82073	3" or 4"	ABS Adj. Commercial Drain w/ 5" NI Grate & Square Ring	1	038753820736	22	202
82074	4"	ABS Adj. Commercial Drain w/ 5" NI Grate & Square Ring	1	038753820743	22	202
82076	6"	ABS Adj. Commercial Drain w/ 5" NI Grate & Square Ring	1	038753820767	22	202
82077	3" or 4"	ABS General Purpose Drain w/ 5" NI Grate & Square Ring	1	038753820774	22	210
82078	4"	ABS Pipe Base General Purpose Drain w/ 5" NI Grate & Square Ring	1	038753820781	22	210
82079	4"	ABS Hub Base General Purpose Drain w/ 5" NI Grate & Square Ring	1	038753820798	22	210
82082	2"	ABS Adj. Commercial Drain w/ 5" CHR Grate	1	038753820828	22	200
82083	3" or 4"	ABS Adj. Commercial Drain w/ 5" CHR Grate	1	038753820835	22	200
82084	4"	ABS Adj. Commercial Drain w/ 5" CHR Grate	1	038753820842	22	200
82086	6"	ABS Adj. Commercial Drain w/ 5" CHR Grate	1	038753820866	22	200
82087	3" or 4"	ABS General Purpose Drain w/ 5" CHR Grate	1	038753820873	22	209
82088	4"	ABS Pipe Base General Purpose Drain w/ 5" CHR Grate	1	038753820880	22	209
82089	4"	ABS Hub Base General Purpose Drain w/ 5" CHR Grate	1	038753820897	22	209
82092	2"	ABS Adj. Commercial Drain w/ 5" CHR Grate & Round Ring	1	038753820827	22	201
82093	3" or 4"	ABS Adj. Commercial Drain w/ 5" CHR Grate & Round Ring	1	038753820934	22	201



Product No.	Size	Description	Ctn. Qty.	UPC	Category	Page Number
82094	4"	ABS Adj. Commercial Drain w/ 5" CHR Grate & Round Ring	1	038753820941	22	201
82096	6"	ABS Adj. Commercial Drain w/ 5" CHR Grate & Round Ring	1	038753820965	22	201
82097	3" or 4"	ABS General Purpose Drain w/ 5" CHR Grate & Round Ring	1	038753820972	22	210
82098	4"	ABS Pipe Base General Purpose Drain w/ 5" CHR Grate & Round Ring	1	038753820989	22	210
82099	4"	ABS Hub Base General Purpose Drain w/ 5" CHR Grate & Round Ring	1	038753820996	22	210
820A-1	1-1/4" x 8"	Extension Tube, Threaded Both Ends - 20 Ga.	10	041193005991	15	138
820C-1	1-1/4" x 8"	Extension Tube, Threaded Both Ends - 17 Ga.	10	041193126948	15	138
82102	2"	ABS Adj. Commercial Drain w/ 5" CHR Grate & Square Ring	1	038753821023	22	202
82103	3" or 4"	ABS Adj. Commercial Drain w/ 5" CHR Grate & Square Ring	1	038753821030	22	202
82104	4"	ABS Adj. Commercial Drain w/ 5" CHR Grate & Square Ring	1	038753821047	22	202
82106	6"	ABS Adj. Commercial Drain w/ 5" CHR Grate & Square Ring	1	038753821061	22	202
82107	3" or 4"	ABS General Purpose Drain w/ 5" CHR Grate & Square Ring	1	038753821078	22	210
82108	4"	ABS Pipe Base General Purpose Drain w/ 5" CHR Grate & Square Ring	1	038753821085	22	210
82109	4"	ABS Hub Base General Purpose Drain w/ 5" CHR Grate & Square Ring	1	038753821092	22	210
82112	2"	ABS Adj. Commercial Drain w/ 6" SS Grate	1	038753821122	22	203
82113	3" or 4"	ABS Adj. Commercial Drain w/ 6" SS Grate	1	038753821139	22	203
82114	4"	ABS Adj. Commercial Drain w/ 6" SS Grate	1	038753821146	22	203
82116	6"	ABS Adj. Commercial Drain w/ 6" SS Grate	1	038753821160	22	203
82117	3" or 4"	ABS General Purpose Drain w/ 6" SS Grate	1	038753821177	22	211
82118	4"	ABS Pipe Base General Purpose Drain w/ 6" SS Grate	1	038753821184	22	211
82119	4"	ABS Hub Base General Purpose Drain w/ 6" SS Grate	1	038753821191	22	211
82122	2"	ABS Adj. Commercial Drain w/ 6" BR Grate	1	038753821221	22	203
82123	3" or 4"	ABS Adj. Commercial Drain w/ 6" BR Grate	1	038753821238	22	203
82124	4"	ABS Adj. Commercial Drain w/ 6" BR Grate	1	038753821245	22	203
82126	6"	ABS Adj. Commercial Drain w/ 6" BR Grate	1	038753821269	22	203
82127	3" or 4"	ABS General Purpose Drain w/ 6" BR Grate	1	038753821276	22	211
82128	4"	ABS Pipe Base General Purpose Drain w/ 6" BR Grate	1	038753821283	22	211
82129	4"	ABS Hub Base General Purpose Drain w/ 6" BR Grate	1	038753821290	22	211
82132	2"	ABS Adj. Commercial Drain w/ 6" BR Grate & Round Ring	1	038753821320	22	204
82133	3" or 4"	ABS Adj. Commercial Drain w/ 6" BR Grate & Round Ring	1	038753821337	22	204
82134	4"	ABS Adj. Commercial Drain w/ 6" BR Grate & Round Ring	1	038753821344	22	204
82136	6"	ABS Adj. Commercial Drain w/ 6" BR Grate & Round Ring	1	038753821368	22	204
82137	3" or 4"	ABS General Purpose Drain w/ 6" BR Grate & Round Ring	1	038753821375	22	212
82138	4"	ABS Pipe Base General Purpose Drain w/ 6" BR Grate & Round Ring	1	038753821382	22	212
82139	4"	ABS Hub Base General Purpose Drain w/ 6" BR Grate & Round Ring	1	038753821399	22	212
82142	2"	ABS Adj. Commercial Drain w/ 6" BR Grate & Square Ring	1	038753821429	22	205
82143	3" or 4"	ABS Adj. Commercial Drain w/ 6" BR Grate & Square Ring	1	038753821436	22	205
82144	4"	ABS Adj. Commercial Drain w/ 6" BR Grate & Square Ring	1	038753821443	22	205



Product No.	Size	Description	Ctn. Qty.	UPC	Category	Page Number
82146	6"	ABS Adj. Commercial Drain w/ 6" BR Grate & Square Ring	1	038753821467	22	205
82147	3" or 4"	ABS General Purpose Drain w/ 6" BR Grate & Square Ring	1	038753821474	22	212
82148	4"	ABS Pipe Base General Purpose Drain w/ 6" BR Grate & Square Ring	1	038753821481	22	212
82149	4"	ABS Hub Base General Purpose Drain w/ 6" BR Grate & Square Ring	1	038753821498	22	212
82152	2"	ABS Adj. Commercial Drain w/ 6" NI Grate	1	038753841526	22	203
82153	3" or 4"	ABS Adj. Commercial Drain w/ 6" NI Grate	1	038753821535	22	203
82154	4"	ABS Adj. Commercial Drain w/ 6" NI Grate	1	038753821542	22	203
82156	6"	ABS Adj. Commercial Drain w/ 6" NI Grate	1	038753821566	22	203
82157	3" or 4"	ABS General Purpose Drain w/ 6" NI Grate	1	038753821573	22	211
82158	4"	ABS Pipe Base General Purpose Drain w/ 6" NI Grate	1	038753821580	22	211
82159	4"	ABS Hub Base General Purpose Drain w/ 6" NI Grate	1	038753821597	22	211
82162	2"	ABS Adj. Commercial Drain w/ 6" NI Grate & Round Ring	1	038753821627	22	204
82163	3" or 4"	ABS Adj. Commercial Drain w/ 6" NI Grate & Round Ring	1	038753821634	22	204
82164	4"	ABS Adj. Commercial Drain w /6" NI Grate & Round Ring	1	038753821641	22	204
82166	6"	ABS Adj. Commercial Drain w/ 6" NI Grate & Round Ring	1	038753821665	22	204
82167	3" or 4"	ABS General Purpose Drain w/ 6" NI Grate & Round Ring	1	038753821672	22	212
82168	4"	ABS Pipe Base General Purpose Drain w/ 6" NI Grate & Round Ring	1	038753821689	22	212
82169	4"	ABS Hub Base General Purpose Drain w/ 6" NI Grate & Round Ring	1	038753821696	22	212
82172	2"	ABS Adj. Commercial Drain w/ 6" NI Grate & Square Ring	1	038753821726	22	205
82173	3" or 4"	ABS Adj. Commercial Drain w/ 6" NI Grate & Square Ring	1	038753821733	22	205
82174	4"	ABS Adj. Commercial Drain w/ 6" NI Grate & Square Ring	1	038753821740	22	205
82176	6"	ABS Adj. Commercial Drain w/ 6" NI Grate & Square Ring	1	038753821764	22	205
82177	3" or 4"	ABS General Purpose Drain w/ 6" NI Grate & Square Ring	1	038753821771	22	212
82178	4"	ABS Pipe Base General Purpose Drain w/ 6" NI Grate & Square Ring	1	038753821788	22	212
82179	4"	ABS Hub Base General Purpose Drain w/ 6" NI Grate & Square Ring	1	038753821795	22	212
82182	2"	ABS Adj. Commercial Drain w/ 6" CHR Grate	1	038753821825	22	203
82183	3" or 4"	ABS Adj. Commercial Drain w/ 6" CHR Grate	1	038753821832	22	203
82184	4"	ABS Adj. Commercial Drain w/ 6" CHR Grate	1	038753821849	22	203
82186	6"	ABS Adj. Commercial Drain w/ 6" CHR Grate	1	038753821863	22	203
82187	3" or 4"	ABS General Purpose Drain w/ 6" CHR Grate	1	038753821870	22	211
82186	4"	ABS Pipe Base General Purpose Drain w/ 6" CHR Grate	1	038753821867	22	211
82189	4"	ABS Hub Base General Purpose Drain w/ 6" CHR Grate	1	038753821894	22	211
82192	2"	ABS Adj. Commercial Drain w/ 6" CHR Grate & Round Ring	1	038753821924	22	204
82193	3" or 4"	ABS Adj. Commercial Drain w/ 6" CHR Grate & Round Ring	1	038753821931	22	204
82194	4"	ABS Adj. Commercial Drain w /6" CHR Grate & Round Ring	1	038753821948	22	204
82196	6"	ABS Adj. Commercial Drain w/ 6" CHR Grate & Round Ring	1	038753821962	22	204
82197	3" or 4"	ABS General Purpose Drain w/ 6" CHR Grate & Round Ring	1	038753821979	22	212
82198	4"	ABS Pipe Base General Purpose Drain w/ 6" CHR Grate & Round Ring	1	038753821986	22	212
82199	4"	ABS Hub Base General Purpose Drain w/ 6" CHR Grate & Round Ring	1	038753821993	22	212



Product No.	Size	Description	Ctn. Qty.	UPC	Category	Page Number
822-1	1-1/4" x 12"	Extension Tube, Threaded Both Ends - 20 Ga.	10	041193005816	15	138
822-3	1-1/4" x 12"	Extension Tube, Threaded Both Ends - 20 Ga., Unfinished	10	041193126955	15	138
82202	2"	ABS Adj. Commercial Drain w/ 6" CHR Grate & Square Ring	1	038753822020	22	205
82203	3" or 4"	ABS Adj. Commercial Drain w/ 6" CHR Grate & Square Ring	1	038753822037	22	205
82204	4"	ABS Adj. Commercial Drain w/ 6" CHR Grate & Square Ring	1	038753822044	22	205
82206	6"	ABS Adj. Commercial Drain w/ 6" CHR Grate & Square Ring	1	038753822068	22	205
82207	3" or 4"	ABS General Purpose Drain w/ 6" CHR Grate & Square Ring	1	038753822075	22	212
82208	4"	ABS Pipe Base General Purpose Drain w/ 6" CHR Grate & Square Ring	1	038753822082	22	212
82209	4"	ABS Hub Base General Purpose Drain w/ 6" CHR Grate & Square Ring	1	038753822099	22	212
82210	4"	Cast NI Square Barrel & Square NI Grate	1	038753822105	22	226
82212	2"	ABS Adj. Commercial Drain w/ 4" Cast NI Square Grate & Square Top	1	038753822129	22	207
82213	3" or 4 "	ABS Adj. Commercial Drain w/ 4" Cast NI Square Grate & Square Top	1	038753822136	22	208
82214	4"	ABS Adj. Commercial Drain w/ 4" Cast NI Square Grate & Square Top	1	038753822143	22	208
82216	6"	ABS Adj. Commercial Drain w/ 4" Cast NI Square Grate & Square Top	1	038753822167	22	208
82217	3" or 4"	ABS General Purpose Pipe Fit Drain w/ 4" Cast NI Grate & Square Top	1	038753822174	22	213
82218	4"	ABS General Purpose Pipe Fit Drain w/ 4" Cast NI Grate & Square Top	1	038753822179	22	213
82219	4"	ABS General Purpose Hub Fit Drain w/ 4" Cast NI Grate & Square Top	1	038753822198	22	213
82220	4"	Cast CHR Square Barrel & Square CHR Grate	1	038753822204	22	226
82222	2"	ABS Adj. Commercial Drain w/ 4" Cast CHR Square Grate & Square Top	1	038753822228	22	207
82223	3" or 4 "	ABS Adj. Commercial Drain w/ 4" Cast CHR Square Grate & Square Top	1	038753822235	22	208
82224	4"	ABS Adj. Commercial Drain w/ 4" Cast CHR Square Grate & Square Top	1	038753822242	22	208
82226	6"	ABS Adj. Commercial Drain w/ 4" Cast CHR Square Grate & Square Top	1	038753822266	22	208
82227	3" or 4"	ABS General Purpose Pipe Fit Drain w/ 4" Cast CHR Grate & Square Top	1	038753822273	22	213
82228	4"	ABS General Purpose Pipe Fit Drain w/ 4" Cast CHR Grate & Square Top	1	038753822280	22	213
82229	4"	ABS General Purpose Hub Fit Drain w/ 4" Cast CHR Grate & Square Top	1	038753822297	22	213
82230	5"	Cast NI Square Barrel & Square NI Grate	1	038753822303	22	226
82232	2"	ABS Adj. Commercial Drain w/ 5" Cast NI Square Grate & Square Top	1	038753822327	22	207
82233	3" or 4 "	ABS Adj. Commercial Drain w/ 5" Cast NI Square Grate & Square Top	1	038753822334	22	208
82234	4"	ABS Adj. Commercial Drain w/ 5" Cast NI Square Grate & Square Top	1	038753822341	22	208
82236	6"	ABS Adj. Commercial Drain w/ 5" Cast NI Square Grate & Square Top	1	038753822365	22	208
82237	3" or 4"	ABS General Purpose Pipe Fit Drain w/ 5" Cast NI Grate & Square Top	1	038753822372	22	213
82238	4"	ABS General Purpose Pipe Fit Drain w/ 5" Cast NI Grate & Square Top	1	038753822389	22	213

NUMERICAL LISTING



Product No.	Size	Description	Ctn. Qty.	UPC	Category	Page Number
82239	4"	ABS General Purpose Hub Fit Drain w/ 5" Cast NI Grate & Square Top	1	038753822396	22	213
82240	5"	Cast CHR Square Barrel & Square CHR Grate	1	038753822402	22	226
82242	2"	ABS Adj. Commercial Drain w/ 5" Cast CHR Square Grate & Square Top	1	038753822426	22	208
82243	3" or 4 "	ABS Adj. Commercial Drain w/ 5" Cast CHR Square Grate & Square Top	1	038753822433	22	208
82244	4"	ABS Adj. Commercial Drain w/ 5" Cast CHR Square Grate & Square Top	1	038753822440	22	208
82246	6"	ABS Adj. Commercial Drain w/ 5" Cast CHR Square Grate & Square Top	1	038753822464	22	208
82247	3" or 4"	ABS General Purpose Pipe Fit Drain w/ 5" Cast CHR Grate & Square Top	1	038753822471	22	213
82248	4"	ABS General Purpose Pipe Fit Drain w/ 5" Cast CHR Grate & Square Top	1	038753822488	22	213
82249	4"	ABS General Purpose Hub Fit Drain w/ 5" Cast CHR Grate & Square Top	1	038753822495	22	213
82250	6"	Cast NI Square Barrel & Square NI Grate	1	038753822501	22	226
82252	2"	ABS Adj. Commercial Drain w/ 6" Cast NI Square Grate & Square Top	1	038753822525	22	207
82253	3" or 4 "	ABS Adj. Commercial Drain w/ 6" Cast NI Square Grate & Square Top	1	038753822532	22	208
82254	4"	ABS Adj. Commercial Drain w/ 6" Cast NI Square Grate & Square Top	1	038753822549	22	208
82256	6"	ABS Adj. Commercial Drain w/ 6" Cast NI Square Grate & Square Top	1	038753822563	22	208
82257	3" or 4"	ABS General Purpose Pipe Fit Drain w/ 6" Cast NI Grate & Square Top	1	038753822570	22	213
82258	4"	ABS General Purpose Pipe Fit Drain w/ 6" Cast NI Grate & Square Top	1	038753822587	22	213
82259	4"	ABS General Purpose Hub Fit Drain w/ 6" Cast NI Grate & Square Top	1	038753822594	22	213
82260	6"	Cast CHR Square Barrel & Square CHR Grate	1	038753822600	22	226
82262	2"	ABS Adj. Commercial Drain w/ 6" Cast CHR Square Grate & Square Top	1	038753822624	22	208
82263	3" or 4 "	ABS Adj. Commercial Drain w/ 6" Cast CHR Square Grate & Square Top	1	038753822631	22	208
82264	4"	ABS Adj. Commercial Drain w/ 6" Cast CHR Square Grate & Square Top	1	038753822648	22	208
82266	6"	ABS Adj. Commercial Drain w/ 6" Cast CHR Square Grate & Square Top	1	038753822662	22	208
82267	3" or 4"	ABS General Purpose Pipe Fit Drain w/ 6" Cast CHR Grate & Square Top	1	038753822679	22	213
82268	4"	ABS General Purpose Pipe Fit Drain w/ 6" Cast CHR Grate & Square Top	1	038753822686	22	213
82269	4"	ABS General Purpose Hub Fit Drain w/ 6" Cast CHR Grate & Square Top	1	038753822693	22	213
82270	5"	Cast NI Square Barrel & Round NI Grate	1	038753822709	22	226
82272	2"	ABS Adj. Commercial Drain w/ 5" Cast NI Grate & Square Top	1	038753822723	22	207
82273	3" or 4 "	ABS Adj. Commercial Drain w/ 5" Cast NI Grate & Square Top	1	038753822730	22	207
82274	4"	ABS Adj. Commercial Drain w/ 5" Cast NI Grate & Square Top	1	038753822747	22	207
82276	6"	ABS Adj. Commercial Drain w/ 5" Cast NI Grate & Square Top	1	038753822761	22	207
82277	3" or 4"	ABS General Purpose Pipe Fit Drain w/ 5" Cast NI Grate & Square Top	1	038753822778	22	214



Product No.	Size	Description	Ctn. Qty.	UPC	Category	Page Number
82278	4"	ABS General Purpose Pipe Fit Drain w/ 5" Cast NI Grate & Square Top	1	038753822785	22	214
82279	4"	ABS General Purpose Hub Fit Drain w/ 5" Cast NI Grate & Square Top	1	038753822792	22	214
82280	5"	Cast CHR Square Barrel & Round CHR Grate	1	038753822808	22	226
82282	2"	ABS Adj. Commercial Drain w/ 5" Cast CHR Grate & Square Top	1	038753822822	22	207
82283	3" or 4 "	ABS Adj. Commercial Drain w/ 5" Cast CHR Grate & Square Top	1	038753822839	22	207
82284	4"	ABS Adj. Commercial Drain w/ 5" Cast CHR Grate & Square Top	1	038753822846	22	207
82286	6"	ABS Adj. Commercial Drain w/ 5" Cast CHR Grate & Square Top	1	038753822860	22	207
82287	3" or 4"	ABS General Purpose Pipe Fit Drain w/ 5" Cast CHR Grate & Square Top	1	038753822877	22	214
82288	4"	ABS General Purpose Pipe Fit Drain w/ 5" Cast CHR Grate & Square Top	1	038753822884	22	214
82289	4"	ABS General Purpose Hub Fit Drain w/ 5" Cast CHR Grate & Square Top	1	038753822891	22	214
82290	6"	Cast NI Square Barrel & Round NI Grate	1	038753822907	22	226
82292	2"	ABS Adj. Commercial Drain w/ 6" Cast NI Grate & Square Top	1	038753822921	22	207
82293	3" or 4 "	ABS Adj. Commercial Drain w/ 6" Cast NI Grate & Square Top	1	038753822938	22	207
82294	4"	ABS Adj. Commercial Drain w/ 6" Cast NI Grate & Square Top	1	038753822945	22	207
82296	6"	ABS Adj. Commercial Drain w/ 6" Cast NI Grate & Square Top	1	038753822969	22	207
82297	3" or 4"	ABS General Purpose Pipe Fit Drain w/ 6" Cast NI Grate & Square Top	1	038753822976	22	214
82298	4"	ABS General Purpose Pipe Fit Drain w/ 6" Cast NI Grate & Square Top	1	038753822983	22	214
82299	4"	ABS General Purpose Hub Fit Drain w/ 6" Cast NI Grate & Square Top	1	038753822990	22	214
822A-1	1-1/4" x 12"	Extension Tube, Threaded Both Ends - 17 Ga.	10	041193018779	15	138
822A-3	1-1/4" x 12"	Extension Tube, Threaded Both Ends - 17 Ga., Unfinished	10	041193013293	15	138
82300	6"	Cast CHR Square Barrel & Round CHR Grate	1	038753823003	22	226
82302	2"	ABS Adj. Commercial Drain w/ 6" Cast CHR Grate & Square Top	1	038753823027	22	207
82303	3" or 4 "	ABS Adj. Commercial Drain w/ 6" Cast CHR Grate & Square Top	1	038753823034	22	207
82304	4"	ABS Adj. Commercial Drain w/ 6" Cast CHR Grate & Square Top	1	038753823041	22	207
82306	6"	ABS Adj. Commercial Drain w/ 6" Cast CHR Grate & Square Top	1	038753823065	22	207
82307	3" or 4"	ABS General Purpose Pipe Fit Drain w/ 6" Cast CHR Grate & Square Top	1	038753823072	22	214
82308	4"	ABS General Purpose Pipe Fit Drain w/ 6" Cast CHR Grate & Square Top	1	038753823089	22	214
82309	4"	ABS General Purpose Hub Fit Drain w/ 6" Cast CHR Grate & Square Top	1	038753823096	22	214
82310	5"	Cast NI Round Barrel & Round NI Grate	1	038753823102	22	226
82312	2"	ABS Adj. Commercial Drain w/ 5" Cast NI Grate & Round Top	1	038753823126	22	205
82313	3" or 4 "	ABS Adj. Commercial Drain w/ 5" Cast NI Grate & Round Top	1	038753823133	22	205
82314	4"	ABS Adj. Commercial Drain w/ 5" Cast NI Grate & Round Top	1	038753823140	22	206

NUMERICAL LISTING



Product No.	Size	Description	Ctn. Qty.	UPC	Category	Page Number
82316	6"	ABS Adj. Commercial Drain w/ 5" Cast NI Grate & Round Top	1	038753823164	22	206
82317	3" or 4"	ABS General Purpose Pipe Fit Drain w/ 5" Cast NI Grate & Round Top	1	038753823171	22	214
82318	4"	ABS General Purpose Pipe Fit Drain w/ 5" Cast NI Grate & Round Top	1	038753823186	22	215
82319	4"	ABS General Purpose Hub Fit Drain w/ 5" Cast NI Grate & Round Top	1	038753823195	22	215
82320	5"	Cast CHR Round Barrel & Round CHR Grate	1	038753823201	22	228
82322	2"	ABS Adj. Commercial Drain w/ 5" Cast CHR Grate & Round Top	1	038753823225	22	205
82323	3" or 4 "	ABS Adj. Commercial Drain w/ 5" Cast CHR Grate & Round Top	1	038753823232	22	206
82324	4"	ABS Adj. Commercial Drain w/ 5" Cast CHR Grate & Round Top	1	038753823249	22	206
82326	6"	ABS Adj. Commercial Drain w/ 5" Cast CHR Grate & Round Top	1	038753823263	22	206
82327	3" or 4"	ABS General Purpose Pipe Fit Drain w/ 5" Cast CHR Grate & Round Top	1	038753823270	22	214
82328	4"	ABS General Purpose Pipe Fit Drain w/ 5" Cast CHR Grate & Round Top	1	038753823287	22	215
82329	4"	ABS General Purpose Hub Fit Drain w/ 5" Cast CHR Grate & Round Top	1	038753823294	22	215
82330	6"	Cast NI Round Barrel & Round NI Grate	1	038753823300	22	226
82332	2"	ABS Adj. Commercial Drain w/ 6" Cast NI Grate & Round Top	1	038753823324	22	205
82333	3" or 4 "	ABS Adj. Commercial Drain w/ 6" Cast NI Grate & Round Top	1	038753823331	22	206
82334	4"	ABS Adj. Commercial Drain w/ 6" Cast NI Grate & Round Top	1	038753823348	22	206
82336	6"	ABS Adj. Commercial Drain w/ 6" Cast NI Grate & Round Top	1	038753823362	22	206
82337	3" or 4"	ABS General Purpose Pipe Fit Drain w/ 6" Cast NI Grate & Round Top	1	038753823379	22	214
82338	4"	ABS General Purpose Pipe Fit Drain w/ 6 " Cast NI Grate & Round Top	1	038753823386	22	215
82339	4"	ABS General Purpose Hub Fit Drain w/ 6" Cast NI Grate & Round Top	1	038753823393	22	215
82340	6"	Cast CHR Round Barrel & Round CHR Grate	1	038753823409	22	226
82342	2"	ABS Adj. Commercial Drain w/ 6" Cast CHR Grate & Round Top	1	038753823423	22	205
82343	3" or 4 "	ABS Adj. Commercial Drain w/ 6" Cast CHR Grate & Round Top	1	038753823430	22	206
82344	4"	ABS Adj. Commercial Drain w /6" Cast CHR Grate & Round Top	1	038753823447	22	206
82346	6"	ABS Adj. Commercial Drain w/ 6" Cast CHR Grate & Round Top	1	038753823461	22	206
82347	3" or 4"	ABS General Purpose Pipe Fit Drain w/ 6" Cast CHR Grate & Round Top	1	038753823478	22	214
82348	4"	ABS General Purpose Pipe Fit Drain w/ 6" Cast CHR Grate & Round Top	1	038753823485	22	215
82349	4"	ABS General Purpose Hub Fit Drain w/ 6" Cast CHR Grate & Round Top	1	038753823492	22	215
82350	8"	Cast NI Round Barrel & Round NI Grate	1	038753823508	22	226
82352	2"	ABS Adj. Commercial Drain w/ 8" Cast NI Grate & Round Top	1	038753823522	22	205
82353	3" or 4 "	ABS Adj. Commercial Drain w/ 8" Cast NI Grate & Round Top	1	038753823539	22	206



Product No.	Size	Description	Ctn. Qty.	UPC	Category	Page Number
82354	4"	ABS Adj. Commercial Drain w/ 8" Cast NI Grate & Round Top	1	038753823546	22	206
82356	6"	ABS Adj. Commercial Drain w/ 8" Cast NI Grate & Round Top	1	038753823560	22	206
82357	3" or 4"	ABS General Purpose Pipe Fit Drain w/ 8" Cast NI Grate & Round Top	1	038753823577	22	214
82358	4"	ABS General Purpose Pipe Fit Drain w/ 8" Cast NI Grate & Round Top	1	038753823584	22	215
82359	4"	ABS General Purpose Hub Fit Drain w/ 8" Cast NI Grate & Round Top	1	038753823591	22	215
82360	8"	Cast CHR Round Barrel & Round CHR Grate	1	038753823607	22	226
82362	2"	ABS Adj. Commercial Drain w/ 8" Cast CHR Grate & Round Top	1	038753823621	22	205
82363	3" or 4 "	ABS Adj. Commercial Drain w/ 8" Cast CHR Grate & Round Top	1	038753823638	22	206
82364	4"	ABS Adj. Commercial Drain w/ 8" Cast CHR Grate & Round Top	1	038753823645	22	206
82366	6"	ABS Adj. Commercial Drain w/ 8" Cast CHR Grate & Round Top	1	038753823669	22	206
82367	3" or 4"	ABS General Purpose Pipe Fit Drain w/ 8" Cast CHR Grate & Round Top	1	038753823676	22	215
82368	4"	ABS General Purpose Pipe Fit Drain w/ 8" Cast CHR Grate & Round Top	1	038753823683	22	215
82369	4"	ABS General Purpose Hub Fit Drain w/ 8" Cast CHR Grate & Round Top	1	038753823690	22	215
82370	10"	Cast NI Round Barrel & Round NI Grate	1	038753823706	22	226
82372	2"	ABS Adj. Commercial Drain w/ 10" Cast NI Grate & Round Top	1	038753823720	22	205
82373	3" or 4 "	ABS Adj. Commercial Drain w/ 10" Cast NI Grate & Round Top	1	038753823737	22	206
82374	4"	ABS Adj. Commercial Drain w/ 10" Cast NI Grate & Round Top	1	038753823744	22	206
82376	6"	ABS Adj. Commercial Drain w/ 10" Cast NI Grate & Round Top	1	038753823768	22	206
82377	3" or 4"	ABS General Purpose Pipe Fit Drain w/ 10" Cast NI Grate & Round Top	1	038753823775	22	214
82378	4"	ABS General Purpose Pipe Fit Drain w/ 10" Cast NI Grate & Round Top	1	038753823782	22	215
82379	4"	ABS General Purpose Hub Fit Drain w/ 10" Cast NI Grate & Round Top	1	038753823799	22	215
82380	10"	Cast CHR Round Barrel & Round CHR Grate	1	038753823805	22	226
82382	2"	ABS Adj. Commercial Drain w/ 10" Cast CHR Grate & Round Top	1	038753823829	22	205
82383	3" or 4 "	ABS Adj. Commercial Drain w/ 10" Cast CHR Grate & Round Top	1	038753823836	22	206
82384	4"	ABS Adj. Commercial Drain w/ 10" Cast CHR Grate & Round Top	1	038753823843	22	206
82386	6"	ABS Adj. Commercial Drain w/ 10" Cast CHR Grate & Round Top	1	038753823867	22	206
82387	3" or 4"	ABS General Purpose Pipe Fit Drain w/ 10" Cast CHR Grate & Round Top	1	038753823874	22	214
82388	4"	ABS General Purpose Pipe Fit Drain w/ 10" Cast CHR Grate & Round Top	1	038753823881	22	215
82389	4"	ABS General Purpose Hub Fit Drain w/ 10" Cast CHR Grate & Round Top	1	038753823898	22	215
82390	6"	Cast Brass Barrel With Round Heavy Duty Grate With Round Ring	1	038753823904	22	226
824-1	1-3/8" x 12"	Extension Tube, Threaded Both Ends - 17 Ga.	10	041193126993	15	138

NUMERICAL LISTING



Product No.	Size	Description	Ctn. Qty.	UPC	Category	Page Number
82400	6"	Cast Nickel Barrel With Round Heavy Duty Grate With Round Ring	1	038753824000	22	226
82410	6"	Cast Chrome Barrel With Round Heavy Duty Grate With Round Ring	1	038753824109	22	226
825A-1	1-1/2" x 8"	Extension Tube, Threaded Both Ends - 20 Ga.	10	041193006004	15	138
827-1	1-1/2" x 12"	Extension Tube, Threaded Both Ends - 20 Ga.	10	041193005823	15	138
827-3	1-1/2" x 12"	Extension Tube, Threaded Both Ends - 20 Ga., Unfinished	10	041193127037	15	138
827A-1	1-1/2" x 12"	Extension Tube, Threaded Both Ends - 17 Ga.	10	041193127044	15	138
827A-3	1-1/2" x 12"	Extension Tube, Threaded Both Ends - 17 Ga., Unfinished	10	041193013309	15	138
828-1	1-1/2" x 6"	Extension Tube, Threaded Both Ends - 20 Ga.	10	041193071293	15	138
83		Adjustable Plastic Shower Rod Holder	50	041193127068	17	178
831-1	1-1/4"	Trap Primer Tailpiece - 17 Ga.	10	041193000118	15	139
832-1	1-1/2"	Trap Primer Tailpiece w/ Captured Nut - 17 Ga.	10	041193000125	15	139
83A-1	1-1/2" x 16"	Center to Center, Hi-Line w/ Baffle Tee - 20 Ga.	5	041193127082	15	135
84122	2"	ABS Adj. Commercial Cleanout w/ 6" BR Cover	1	038753841229	22	216
84123	3" or 4 "	ABS Adj. Commercial Cleanout w/ 6" BR Cover	1	038753841236	22	216
84124	4"	ABS Adj. Commercial Cleanout w/ 6" BR Cover	1	038753841243	22	216
84126	6"	ABS Adj. Commercial Cleanout w/ 6" BR Cover	1	038753841267	22	216
84127	3" or 4"	ABS General Purpose Cleanout w/ 6" BR Cover	1	038753841274	22	219
84128	4"	ABS Pipe Base General Purpose Cleanout w/ 6" BR Cover	1	038753841281	22	219
84129	4"	ABS Hub Base General Purpose Cleanout w/ 6" BR Cover	1	038753841298	22	219
84132	2"	ABS Adj. Commercial Cleanout w/ 6" BR Cover & Round Ring	1	038753841328	22	216
84133	3" or 4 "	ABS Adj. Commercial Cleanout w/ 6" BR Cover & Round Ring	1	038753841335	22	216
84134	4"	ABS Adj. Commercial Cleanout w/ 6" BR Cover & Round Ring	1	038753841342	22	217
84136	6"	ABS Adj. Commercial Cleanout w/ 6" BR Cover & Round Ring	1	038753841366	22	217
84137	3" or 4"	ABS General Purpose Cleanout w/ 6" BR Cover & Round Ring	1	038753841373	22	219
84138	4"	ABS Pipe Base General Purpose Cleanout w/ 6" BR Cover & Round Ring	1	038753841380	22	219
84139	4"	ABS Hub Base General Purpose Cleanout w/ 6" BR Cover & Round Ring	1	038753841397	22	219
84143	3" or 4 "	ABS Adj. Commercial Cleanout w/ 6" BR Cover & Square Ring	1	038753841434	22	217
84144	4"	ABS Adj. Commercial Cleanout w/ 6" BR Cover & Square Ring	1	038753841441	22	217
84146	6"	ABS Adj. Commercial Cleanout w/ 6" BR Cover & Square Ring	1	038753841465	22	217
84147	3" or 4"	ABS General Purpose Cleanout w/ 6" BR Cover & Square Ring	1	038753841472	22	220
84148	4"	ABS Pipe Base General Purpose Cleanout w/ 6" BR Cover & Square Ring	1	038753841489	22	220
84149	4"	ABS Hub Base General Purpose Cleanout w/ 6" BR Cover & Square Ring	1	038753841496	22	220
84152	2"	ABS Adj. Commercial Cleanout w/ 6" NI Cover	1	038753841526	22	216
84153	3" or 4 "	ABS Adj. Commercial Cleanout w/ 6" NI Cover	1	038753841533	22	216
84154	4"	ABS Adj. Commercial Cleanout w/ 6" NI Cover	1	038753841540	22	216
84156	6"	ABS Adj. Commercial Cleanout w/ 6" NI Cover	1	038753841564	22	216
84157	3" or 4"	ABS General Purpose Cleanout w/ 6" NI Cover	1	038753841571	22	219
84158	4"	ABS Pipe Base General Purpose Cleanout w/ 6" NI Cover	1	038753841588	22	219
84159	4"	ABS Hub Base General Purpose Cleanout w/ 6" NI Cover	1	038753841595	22	219



Product No.	Size	Description	Ctn. Qty.	UPC	Category	Page Number
84162	2"	ABS Adj. Commercial Cleanout w/ 6" NI Cover & Round Ring	1	038753841625	22	216
84163	3" or 4 "	ABS Adj. Commercial Cleanout w/ 6" NI Cover & Round Ring	1	038753841632	22	216
84164	4"	ABS Adj. Commercial Cleanout w/ 6" NI Cover & Round Ring	1	038753841649	22	217
84166	6"	ABS Adj. Commercial Cleanout w/ 6" NI Cover & Round Ring	1	038753841663	22	217
84167	3" or 4"	ABS General Purpose Cleanout w/ 6" NI Cover & Round Ring	1	038753841670	22	219
84168	4"	ABS Pipe Base General Purpose Cleanout w/ 6" NI Cover & Round Ring	1	038753841687	22	219
84169	4"	ABS Hub Base General Purpose Cleanout w/ 6" NI Cover & Round Ring	1	038753841694	22	219
84173	3" or 4 "	ABS Adj. Commercial Cleanout w/ 6" NI Cover & Square Ring	1	038753841731	22	217
84174	4"	ABS Adj. Commercial Cleanout w/ 6" NI Cover & Square Ring	1	038753841748	22	217
84176	6"	ABS Adj. Commercial Cleanout w/ 6" NI Cover & Square Ring	1	038753841762	22	217
84177	3" or 4"	ABS General Purpose Cleanout w/ 6" NI Cover & Square Ring	1	038753841779	22	220
84178	4"	ABS Pipe Base General Purpose Cleanout w/ 6" NI Cover & Square Ring	1	038753841786	22	220
84179	4"	ABS Hub Base General Purpose Cleanout w/ 6" NI Cover & Square Ring	1	038753841793	22	220
84182	2"	ABS Adj. Commercial Cleanout w/ 6" CHR Cover	1	038753841823	22	216
84183	3" or 4 "	ABS Adj. Commercial Cleanout w/ 6" CHR Cover	1	038753841830	22	216
84184	4"	ABS Adj. Commercial Cleanout w/ 6" CHR Cover	1	038753841847	22	216
84186	6"	ABS Adj. Commercial Cleanout w/ 6" CHR Cover	1	038753841861	22	216
84187	3" or 4"	ABS General Purpose Cleanout w/ 6" CHR Cover	1	038753841878	22	219
84186	4"	ABS Pipe Base General Purpose Cleanout w/ 6" CHR Cover	1	038753841865	22	219
84189	4"	ABS Hub Base General Purpose Cleanout w/ 6" CHR Cover	1	038753841892	22	219
84192	2"	ABS Adj. Commercial Cleanout w/ 6" CHR Cover & Round Ring	1	038753841922	22	216
84193	3" or 4 "	ABS Adj. Commercial Cleanout w/ 6" CHR Cover & Round Ring	1	038753841939	22	216
84194	4"	ABS Adj. Commercial Cleanout w/ 6" CHR Cover & Round Ring	1	038753841946	22	217
84196	6"	ABS Adj. Commercial Cleanout w/ 6" CHR Cover & Round Ring	1	038753841960	22	217
84197	3" or 4"	ABS General Purpose Cleanout w/ 6" CHR Cover & Round Ring	1	038753841977	22	219
84198	4"	ABS Pipe Base General Purpose Cleanout w/ 6" CHR Cover & Round Ring	1	038753841984	22	219
84199	4"	ABS Hub Base General Purpose Cleanout w/ 6" CHR Cover & Round Ring	1	038753841991	22	219
84202	2"	ABS Adj. Commercial Cleanout w/ 6" CHR Cover & Square Ring	1	038753842028	22	217
84203	3" or 4 "	ABS Adj. Commercial Cleanout w/ 6" CHR Cover & Square Ring	1	038753842035	22	217
84204	4"	ABS Adj. Commercial Cleanout w/ 6" CHR Cover & Square Ring	1	038753842042	22	217
84206	6"	ABS Adj. Commercial Cleanout w/ 6" CHR Cover & Square Ring	1	038753842066	22	217
84207	3" or 4"	ABS General Purpose Cleanout w/ 6" CHR Cover & Square Ring	1	038753842073	22	220

NUMERICAL LISTING



Product No.	Size	Description	Ctn. Qty.	UPC	Category	Page Number
84208	4"	ABS Pipe Base General Purpose Cleanout w/ 6" CHR Cover & Square Ring	1	038753842080	22	220
84209	4"	ABS Hub Base General Purpose Cleanout w/ 6" CHR Cover & Square Ring	1	038753842097	22	220
84210	6"	Cast 6" BR Round Barrel w/Cleanout & Round BR Cover	1	038753842103	22	227
84212	2"	ABS Adj. Commercial Cleanout w/ 6" Cast BR Cover & Round Top	1	038753842127	22	218
84214	4"	ABS Adj. Commercial Cleanout w/ 6" Cast BR Cover & Round Top	1	038753842141	22	218
84216	6"	ABS Adj. Commercial Cleanout w/ 6" Cast BR Cover & Round Top	1	038753842165	22	218
84217	3" or 4"	ABS General Purpose Cleanout w/ 6" Cast BR Cover & Round Top	1	038753842172	22	220
84218	4"	ABS Pipe Base General Purpose Cleanout w/ 6" Cast BR Cover & Round Top	1	038753842189	22	220
84219	4"	ABS Hub Base General Purpose Cleanout w/ 6" Cast BR Cover & Round Top	1	038753842196	22	220
84220	6"	Cast 6" NI Round Barrel w/Cleanout & Round NI Cover	1	038753842202	22	227
84223	3" or 4 "	ABS Adj. Commercial Cleanout w/ 6" Cast NI Cover & Round Top	1	038753842233	22	218
84224	4"	ABS Adj. Commercial Cleanout w/ 6" Cast NI Cover & Round Top	1	038753842240	22	218
84226	6"	ABS Adj. Commercial Cleanout w/ 6" Cast NI Cover & Round Top	1	038753842264	22	218
84227	3" or 4"	ABS General Purpose Cleanout w/ 6" Cast NI Cover & Round Top	1	038753842271	22	220
84228	4"	ABS Pipe Base General Purpose Cleanout w/ 6" Cast NI Cover & Round Top	1	038753842288	22	220
84229	4"	ABS Hub Base General Purpose Cleanout w/ 6" Cast NI Cover & Round Top	1	038753842295	22	220
84230	6"	Cast 6" CHR Plated BR Round Barrel w/ Cleanout & Round CHR Plated BR Cover	1	038753842301	22	227
84233	3" or 4 "	ABS Adj. Commercial Cleanout w/ 6" Cast CHR Cover & Round Top	1	038753842332	22	218
84234	4"	ABS Adj. Commercial Cleanout w/ 6" Cast CHR Cover & Round Top	1	038753842349	22	218
84236	6"	ABS Adj. Commercial Cleanout w/ 6" Cast CHR Cover & Round Top	1	038753842363	22	218
84237	3" or 4"	ABS General Purpose Cleanout w/ 6" Cast CHR Cover & Round Top	1	038753842370	22	220
84238	4"	ABS Pipe Base General Purpose Cleanout w/ 6" Cast CHR Cover & Round Top	1	038753842387	22	220
84239	4"	ABS Hub Base General Purpose Cleanout w/ 6" Cast CHR Cover & Round Top	1	038753842394	22	220
8477	1-1/4"	45 Degree Slip Joint Elbow, Chrome - 20 Ga.	5	041193055675	15	140
8478	1-1/2"	45 Degree Slip Joint Elbow, Chrome - 20 Ga.	5	041193055682	15	140
8480	1-1/4"	Tee Slip Joint, Chrome - 20 Ga.	5	041193055699	15	140
8481	1-1/2"	Tee Slip Joint, Chrome - 20 Ga.	5	041193055705	15	140
8482	1-1/4"	90 Degree Slip Joint Elbow, Chrome - 20 Ga.	5	041193012470	15	140
8483	1-1/2"	90 Degree Slip Joint Elbow, Chrome - 20 Ga.	5	041193012487	15	140
8512C		Toilet Screw Set, 5/16" x 2-1/2" Brass Closet Screws 2 Brass Screws w/ Nuts and Washers	50	041193094490	17	171
8525C		Toilet Bolts, 1/4" x 2-1/2" Plated, Oregon Pattern	50	041193030115	17	171
8545C		Tank to Bowl Bolt Kit w/ Galvanized Spud Washer	50	041193030207	17	171
8546		Tank to Bowl Bolt Kit w/ Brass Spud Washer	50	041193057907	17	171
86012	2"	ABS Sediment Drain, Plastic Grate w/ Bucket	1	038753860121	22	221
86013	3"	ABS Sediment Drain, Plastic Grate w/ Bucket	1	038753860138	22	221



Product No.	Size	Description	Ctn. Qty.	UPC	Category	Page Number
86014	4"	ABS Sediment Drain, Plastic Grate w/ Bucket	1	038753860145	22	221
86016	6"	ABS Sediment Drain, Plastic Grate w/ Bucket	1	038753860169	22	221
86022	2"	ABS Sediment Drain, Plastic Grate w/o Bucket	1	038753860220	22	221
86023	3" or 4 "	ABS Sediment Drain, Plastic Grate w/o Bucket	1	038753860237	22	221
86024	4"	ABS Sediment Drain, Plastic Grate w/o Bucket	1	038753860244	22	221
86026	6"	ABS Sediment Drain, Plastic Grate w/o Bucket	1	038753860268	22	221
86032	2"	ABS Sediment Drain, Cast Iron Grate w/ Bucket	1	038753860329	22	221
86033	3" or 4 "	ABS Sediment Drain, Cast Iron Grate w/ Bucket	1	038753860336	22	221
86034	4"	ABS Sediment Drain, Cast Iron Grate w/ Bucket	1	038753860343	22	221
86036	6"	ABS Sediment Drain, Cast Iron Grate w/ Bucket	1	038753860367	22	221
86042	2"	ABS Sediment Drain, Cast Iron Grate w/o Bucket	1	038753860428	22	221
86043	3" or 4 "	ABS Sediment Drain, Cast Iron Grate w/o Bucket	1	038753860435	22	221
86044	4"	ABS Sediment Drain, Cast Iron Grate w/o Bucket	1	038753860442	22	221
86046	6"	ABS Sediment Drain, Cast Iron Grate w/o Bucket	1	038753860466	22	221
8636		1/2" NPT x 1/4" NPT Basin Cock Coupling Nut	25	041193049131	17	177
8724	Gallon	Purple Primer	6	083675087248	1	25
8736S	32 oz.	Purple Primer	12	083675087361	1	25
8746S	16 oz.	Purple Primer	24	083675087460	1	25
8756S	8 oz.	Purple Primer	24	083675087569	1	25
8766S	4 oz.	Purple Primer	24	083675087668	1	25
88012	2"	ABS Roof Drain w/ Plastic Dome	1	038753880129	22	222
88013	3" or 4 "	ABS Roof Drain w/ Plastic Dome	1	038753880136	22	222
88014	4"	ABS Roof Drain w/ Plastic Dome	1	038753880143	22	222
88016	6"	ABS Roof Drain w/ Plastic Dome	1	038753880167	22	222
88022	2"	ABS Roof Drain w/ Cast Iron Dome	1	038753880228	22	222
88023	3" or 4 "	ABS Roof Drain w/ Cast Iron Dome	1	038753880235	22	222
88024	4"	ABS Roof Drain w/ Cast Iron Dome	1	038753780242	22	222
88026	6"	ABS Roof Drain w/ Cast Iron Dome	1	038753880266	22	222
88032	2"	ABS Roof Drain w/ ABS Dome & Dam Collar	1	038753880327	22	222
88033	3" or 4 "	ABS Roof Drain w/ ABS Dome & Dam Collar	1	038753880334	22	222
88034	4"	ABS Roof Drain w/ ABS Dome & Dam Collar	1	038753880341	22	222
88036	6"	ABS Roof Drain w/ ABS Dome & Dam Collar	1	038753880365	22	222
88042	2"	ABS Roof Drain w/ Cast Iron Dome & Dam Collar	1	038753880426	22	222
88043	3" or 4 "	ABS Roof Drain w/ Cast Iron Dome & Dam Collar	1	038753880433	22	222
88044	4"	ABS Roof Drain w/ Cast Iron Dome & Dam Collar	1	038753880440	22	222
88046	6"	ABS Roof Drain w/ Cast Iron Dome & Dam Collar	1	038753880464	22	222
8824	Gallon	Purple Primer/Cleaner	6	083675088245	1	25
8836S	32 oz.	Purple Primer/Cleaner	12	083675088368	1	25
8846S	16 oz.	Purple Primer/Cleaner	24	083675088467	1	25
8856S	8 oz.	Purple Primer/Cleaner	24	083675088566	1	25
8866S	4 oz.	Purple Primer/Cleaner	24	083675088665	1	25
89-17-1	1-1/2" x 25-1/2"	Washing Machine Trap NPT-17 Ga.	1	041193081452	15	134
89CF		6" Shower Arm w/ Die Cast Flange	20	041193128065	17	178
89F		6" Shower Arm w/Flange	10	041193033673	17	178
9		Economy Sink Basket Strainer, ABS Body w/ Stainless Steel Rim and Basket. Rubber Stopper w/ Plastic Post, ABS Locknut	24	041193102522	17	167
9002	1-1/2" x 1-1/2"	Polyethylene Washer	100	041193128157	15	151
9002		Plastic Washers	100	041193128157	17	173
9002A	1-1/4" x 1-1/4"	Polyethylene Washer	100	041193128164	15	151

NUMERICAL LISTING



Product No.	Size	Description	Ctn. Qty.	UPC	Category	Page Number
9003	1-1/2" x 1-1/4"	Polyethylene Reducing Washer	100	041193128171	15	151
90104	1/4" diameter	Johni-Bolts®	100	032628901049	8	71
90124	5/16" diameter	Johni-Bolts®	100	032628901247	8	71
90154	1/4" diameter	Johni-Bolts® Extra-Long	100	032628901544	8	71
90174	5/16" diameter	Johni-Bolts® Extra-Long	100	032628901742	8	71
90203	3" or 4"	Johni-Rings - Jumbo W/Plastic Horn & XI Bolts, Combo Pack	24	032628902039	8	72
90210	3" or 4"	Johni-Rings - Standard Size	48	032628902107	8	71
90211	3" or 4"	Johni-Rings - Standard Size - Contractor Pack	24	032628902114	8	71
90214	3" or 4"	Johni-Rings - Regular Flat Ring, Combo Pack	48	032628902145	8	72
90220	3" or 4"	Johni-Rings - Standard Size With Plastic Horn	24	032628902206	8	71
90221	3" or 4"	Johni-Rings - Standard Size/Plastic Horn - Contractor Pack	24	032628902213	8	71
90224	4"	Johni-Rings - With Plastic Horn, Combo Pack	24	032628902244	8	72
90230	4"	Johni-Rings - Standard Size With Plastic Horn	24	032628902305	8	71
90234	3" or 4"	Johni-Rings - With Plastic Horn, Combo Pack	24	032628902343	8	72
90241	3" or 4"	Johni-Rings - Jumbo Size With Plastic Horn	24	032628902411	8	71
90243	3" or 4"	Johni-Rings - Jumbo Size	24	032628902435	8	71
90260	2"	Johni-Rings - For Urinal	24	032628902602	8	72
90270	4"	Johni-Rings - For Back Outlet Toilets	24	032628902701	8	72
90904	1/4" diameter	Johni Quick Bolts	100	032628909045	8	71
90905	5/16" diameter	Johni Quick Bolts	100	032628909052	8	71
90906	1/4" diameter	Johni Quick Bolts - Extra-Long	50	032628909069	8	71
90907	5/16" diameter	Johni Quick Bolts - Extra-Long	50	032628909076	8	71
930042TR		Timed Rate Flapper Kit (Bagged) Vinyl flapper w/ 9" chain, hook and baffles	24	041193081209	17	170
930100		Wing Coupling Nut - 5/8" Center Hole, plastic (1911-2)	100	041193128942	17	170
930103		9" Vinyl Refill Tube (190617)	100	041193128973	17	170
930118		Plastic Tank Float (Bulk). High Buoyancy, Black Polypropylene (P83)	100	041193129055	17	170
930133		Tank Lever Nut, Brass	100	041193129116	17	170
9324	Gallon	Clear Primer – NSF Listed	6	083675093249	1	26
9336S	32 oz.	Clear Primer – NSF Listed	12	083675093362	1	26
9346S	16 oz.	Clear Primer – NSF Listed	24	083675093461	1	26
9356S	8 oz.	Clear Primer – NSF Listed	24	083675093560	1	26
9366S	4 oz.	Clear Primer – NSF Listed	24	083675093669	1	26
96401	3" or 4"	Johni-Rings - Regular Flat Ring, Combo Pack	48	032628964013	8	72
96402	3" or 4"	Johni-Rings - With Plastic Horn, Combo Pack	24	032628964020	8	72
96403	4"	Johni-Rings - With Plastic Horn, Combo Pack	24	032628964037	8	72
971GBN-1	1-1/2"	Anti-Siphon P-Trap - 17 Ga., Chrome Plated, Brass Nuts	1	041193013347	15	133
979GBN-1	1-1/4"	Anti-Siphon P-Trap - 17 Ga., Chrome Plated, Brass Nuts	1	041193013354	15	133
983GBN-1	1-1/2"	Anti-Siphon P-Trap - 17 Ga., Chrome Plated, Brass Nuts	1	041193013361	15	133
9BC		Plastic Strainer Assembly, Biscuit Color, Clamshell	6	041193084897	17	169
9BC-BX		Plastic Strainer Assembly, Biscuit Color, Boxed	12	041193018274	17	169
9BL		Plastic Strainer Assembly, Black Color, Clamshell	6	041193084880	17	169
9BL-BX		Plastic Strainer Assembly, Black Color, Boxed	12	041193018298	17	169
9BNE		Plastic Strainer Assembly, Bone Color, Clamshell	6	041193084866	17	169
9BNE-BX		Plastic Strainer Assembly, Bone Color, Boxed	12	041193011797	17	169
9EWH		Plastic Strainer Assembly, Euro-White Color, Clamshell	6	041193084873	17	169
9EWH-BX		Plastic Strainer Assembly, Euro-White Color, Boxed	12	041193018281	17	169
9WH		Plastic Strainer Assembly, White Color, Clamshell	6	041193084859	17	169



Product No.	Size	Description	Ctn. Qty.	UPC	Category	Page Number
9WH-BX		Plastic Strainer Assembly, White Color, Boxed	12	041193011718	17	169
A3225Z		Quarter Kit, Schedule 40 - ABS Uni-Lift Stopper w/ Chrome Finish Trim Zinc Drain Unit, 90 Degree Elbow	20	041193004321	16	160
A7223RK		Rough-In Kit, Schedule 40 - ABS	30	041193016652	16	160
A7224		Full Kit, Schedule 40 – ABS Touch-Toe Stopper w/ Chrome Finish Trim	10	041193010261	16	158
A7224B		Half Kit, Schedule 40 - ABS Touch-Toe Stopper w/ Chrome Finish Trim	20	041193095145	16	158
A7225		Full Kit, Schedule 40 - ABS Uni-Lift Stopper w/ Chrome Finish Trim	10	041193095169	16	158
A7225B		Half Kit, Schedule 40 - ABS Uni-Lift Stopper w/ Chrome Finish Trim	20	041193095183	16	159
A7225BZ		Half Kit, Schedule 40 - ABS Uni-Lift Stopper w/ Chrome Finish Trim w/ Zinc Drain Unit	20	041193004215	16	159
A7323		DBLue Rough-In Kit, Schedule 40 - ABS	30	041193006837	16	158
A7323RKZ		Rough-In Kit, Schedule 40 - ABS w/ Zinc Spud	30	041193732347	16	160
A7325		DBLue Half Kit, Schedule 40 - ABS Uni-Lift Stopper w/ Chrome Finish Trim and Test Plug	20	041193006820	16	159
A7325BN		DBLue Half Kit, Schedule 40 - ABS Uni-Lift Stopper w/ Brushed Nickel Finish Trim and Test Plug	20	041193007056	16	159
A7325BZ		DBLue Half Kit, Schedule 40 - ABS Uni-Lift Stopper w/ Chrome Finish Trim w/Zinc Spud and Test Plug	20	041193732545	16	159
A7325RB		DBLue Half Kit, Schedule 40 - ABS Uni-Lift Stopper w/ Oil Rubbed Bronze Finish Trim and Test Plug	20	041193006899	16	159
A7544		DBLue Full Kit, Schedule 40 - ABS Uni-Lift Stopper w/ Chrome Finish Trim and Test Plug	10	041193006868	16	158
A7644		DBLue Full Kit, Schedule 40 - ABS Touch-Toe Stopper w/ Chrome Finish Trim and Test Plug	10	041193006813	16	158
A7725		DBLue Half Kit, Schedule 40 - ABS Touch-Toe Stopper w/ Chrome Finish Trim and Test Plug	20	041193006875	16	158
A7725BN		DBLue Half Kit, Schedule 40 - ABS Touch-Toe Stopper w/ Brushed Nickel Finish Trim and Test Plug	20	041193007162	16	158
A8227		Full Kit, Plastic Tubular - Black Uni-Lift Stopper w/ Chrome Finish Trim	10	041193100030	16	157
A8227BG		Full Kit, Plastic Tubular - Black Uni-Lift Stopper w/ Chrome Finish Trim Zinc Drain Unit, 2 Hole Faceplate	10	041193007971	16	157
A8227C		Full Kit, Plastic Tubular - Black Uni-Lift Stopper w/ Chrome Finish Trim Condensate Elbow	10	041193026699	16	157
A8227D		Full Kit, Plastic Tubular – Black Uni-Lift Stopper w/ Chrome Finish Trim Direct Drain	10	041193027016	16	157
A9001	1-1/2"	Slip Joint Nut	100	041193100061	15	151
A9046A	1-1/2"	Double Slip Joint Trap Offset	25	041193019202	15	150
A9100	1-1/2"	Disposer Kit For In-Sink-Erator®	25	041193100108	15	149
A9100B	1-1/2"	Disposer Kit For In-Sink-Erator®, Bagged	25	041193007261	15	149
A9100GEB	1-1/2" x 15"	Disposer Kit For GE®, Bagged	25	041193074829	15	149
A9100T	1-1/2"	Telescopic Disposer Kit For In-Sink-Erator® or GE®	25	041193058423	15	149
A9100TB	1-1/2"	Telescopic Disposer Kit For In-Sink-Erator®, Bagged	25	041193100139	15	149
A9100WB	1-1/2"	Disposer Kit For In-Sink Erator, Bagged w/ True Blue Washer	25	041193009036	15	149
A9108A	1-1/2" x 16"	Center to Center, Slip Joint w/ Baffle Tee	25	041193100160	15	146
A9108AB	1-1/2" x 16"	Center to Center, Slip Joint w/ Baffle Tee, Bagged	25	041193003614	15	146
A9108AT	1-1/2" x 11"-17"	Slip Joint w/ Telescopic Waste Arm	25	041193100177	15	146
A9108ATB	1-1/2" x 11"-17"	Slip Joint w/ Telescopic Waste Arm, Bagged	25	041193100184	15	146
A9108AWB	1-1/2" X 16"	Center to Center, Slip Joint with Baffle Tee, Bagged w/ True Blue Washer	25	041193009081	15	146
A9108B	1-1/2" x 21"	Center to Center, Slip Joint w/ Baffle Tee	25	041193100191	15	146

NUMERICAL LISTING



Product No.	Size	Description	Ctn. Qty.	UPC	Category	Page Number
A9114A	1-1/2" x 16"	Center to Center, Slip Joint w/ Baffle Tee	25	041193100207	15	147
A9121	1-1/2" x 16"	Center to Center, Hi-Line w/ Baffle Tee	25	041193100221	15	146
A9121A	1-1/2" x 16"	Center to Center, Hi-Line/ Slip Joint Combination w/ Baffle Tee	25	041193100238	15	146
A9121AT	1-1/2" x 11"-17"	Hi-Line/Slip Joint Combination w/ Telescopic Waste Arm	25	041193100245	15	146
A9121AWB	1-1/2" x 16"	Center to Center, Hi-Line/ Slip Joint Combination w/ Baffle Tee w/ True Blue Washer	25	041193007193	15	146
A9123A	1-1/2" x 16"	Center to Center, Hi-Line/Slip Joint Combination w/ Baffle Tee	25	041193100269	15	147
A9123AW	1-1/2" X 16"	Center to Center, Hi-Line/Slip Joint Combination with Baffle Tee, Bagged w/ True Blue Washer	25	0	15	147
A9137C	1-1/2" x 15"	Waste Arm w/ Slip Joint	25	041193100306	15	147
A9138C	1-1/2" x 15"	Waste Arm w/ Hi-Line	25	041193100320	15	147
A9185	1-1/2"	Baffle Tee, For Slip Joint End Outlet Waste	25	041193100337	15	147
A9185W	1-1/2"	Baffle Tee, For Slip Joint End Outlet Waste w/ True Blue Washer	25	041193007131	15	147
A9225BBG		Half Kit, Schedule 40 - ABS Uni-Lift Stopper w/ Chrome Finish Trim w/ Zinc Drain Unit No Test Kit, 2 Hole Faceplate	25	041193007728	16	159
A9226		Full Kit, Plastic Tubular - Black Trip-Lever Stopper w/ Chrome Finish	10	041193058379	16	156
A9228		Full Kit, Plastic Tubular - Black Touch-Toe Stopper w/ Chrome Finish Trim	10	041193057594	16	157
A9701BG	1-1/4"	P-Trap, Bagged	25	041193019394	15	144
A9703WBG	1-1/2"	P-Trap with Threaded ABS Adapter, and Reversible J-Bend, Bagged w/ True Blue Washer	50	041193999238	15	144
A9704	1-1/2"	P-Trap w/ Threaded ABS Adapter	25	041193100566	15	145
A9704B	1-1/2"	P-Trap w/ Threaded ABS Adapter, Bagged	50	041193100573	15	145
A9704DF	1-1/2"	P-Trap w/ Threaded ABS Adapter & Deep Flange	25	041193100580	15	145
A9722	1-1/2"	S-Trap w/ ABS Threaded Adapter	25	041193100610	15	145
A9786A	1-1/2" x 8"	Solvent Weld Extension Tube, ABS	25	041193100658	15	148
A9787A	1-1/2" x 12"	Solvent Weld Extension Tube, ABS	25	041193100665	15	148
A9787E	1-1/2" x 16"	Double Connect Solvent Weld Extension Tube, ABS	25	041193100672	15	148
A9791E	1-1/4" x 16"	Double Connect Slip Joint Extension Tube	25	041193019400	15	148
A9792	1-1/2" x 6"	Slip Joint Extension Tube	25	041193100689	15	148
A9792A	1-1/2" x 8"	Slip Joint Extension Tube	25	041193100696	15	148
A9792AW	1-1/2" X 8"	Slip Joint Extension Tube w/ True Blue Washer	25	041193009111	15	148
A9793A	1-1/2" x 12"	Slip Joint Extension Tube	25	041193108043	15	148
A9793E	1-1/2" x 16"	Double Connect Slip Joint Extension Tube	25	041193058447	15	148
A9793EW	1-1/2" X 16"	Double Connect Slip Joint Extension Tube w/ True Blue Washer	25	041193009166	15	148
A9799	1-1/2" x 4"	Flanged Strainer Tailpiece	25	041193100702	15	148
A9800	1-1/2" x 6"	Flanged Strainer Tailpiece	25	041193100719	15	148
A9801	1-1/2" x 8"	Flanged Strainer Tailpiece	25	041193100726	15	148
A9803	1-1/2" x 12"	Flanged Strainer Tailpiece	25	041193058461	15	148
A9803E	1-1/2" x 16"	Double Flanged Strainer Tailpiece	25	041193058478	15	148
AP9816	1-1/2" x 8"	Branch Tailpiece, Slip Joint Top w/ 1/2" Branch	25	041193073747	15	149
AP9816W	1-1/2" x 8"	Branch Tailpiece, Slip Joint Top w/ 1/2" Branch w/ True Blue Washer	25	041193009173	15	149
AP9817	1-1/2" x 8"	Branch Tailpiece, Slip Joint Top w/ 3/4" Branch	25	041193058485	15	149
AP9817W	1-1/2" x 8"	Branch Tailpiece, Slip Joint Top w/ 3/4" Branch w/ True Blue Washer	25	041193009180	15	149
AP9818	1-1/2" x 8"	Branch Tailpiece, Hi-Line w/ 1/2" Branch	25	041193100016	15	149
AP9819	1-1/2" x 8"	Branch Tailpiece, Hi-Line w/ 3/4" Branch	25	041193100023	15	149



Product No.	Size	Description	Ctn. Qty.	UPC	Category	Page Number
B1004		1-1/4" Brass Ring	10	041193055897	17	172
B1005		1-1/2" Brass Ring	10	041193055903	17	172
DB-CD-3		Air Gap, Copper w/ Chrome Plated Metal Cap	48	041193019233	15	152
DB-CD-4P		Air Gap, Plastic w/ Chrome Plated Metal Cap	48	041193019226	15	152
D7CHR		Disposer Flange and Stopper, Brass Polished Chrome Finish, Boxed	6	041193010551	17	169
D7U		Disposer Flange and Stopper, UltraShine® Polished Brass Finish, Boxed	6	041193010544	17	169
D9BC		Disposer Flange Assembly, Biscuit Color, Clamshell	6	041193084941	17	169
D9BC-BX		Disposer Flange Assembly, Biscuit Color, Boxed	12	041193018304	17	169
D9BL		Disposer Flange Assembly, Black Color, Clamshell	6	041193084934	17	169
D9BL-BX		Disposer Flange Assembly, Black Color, Boxed	12	041193018328	17	169
D9BNE		Disposer Flange Assembly, Bowl, Bone Color, Clamshell	6	041193084910	17	169
D9BNE-BX		Disposer Flange Assembly, Bowl, Bone Color, Boxed	12	041193011664	17	169
D9EWH		Disposer Flange Assembly, Euro-White Color, Clamshell	6	041193084927	17	169
D9EWH-BX		Disposer Flange Assembly, Euro-White Color, Boxed	12	041193018311	17	169
D9WH		Disposer Flange Assembly, White Color, Clamshell	6	041193084903	17	169
D9WH-BX		Disposer Flange Assembly, White Color, Boxed	12	041193011640	17	169
DB711		Spin-N-Lock Sink Basket Strainer, Chrome Plated Brass Body w/ Stainless Steel Screw-In Basket, Brass Turning Nut	24	041193011541	17	165
DB711BN		Same as DB711 w/ Brass Nuts	24	041193014832	17	165
DB711EZ		Spin-N-Lock Sink Basket Strainer, Chrome Plated Brass Body w/ Stainless Steel Screw-In Basket and EZ-Mount Connection	24	041193014962	17	165
DB1000		Locking Cup Sink Basket Strainer, Stainless Steel Body and Basket, Galvanized Steel Locking Cup, Plastic Post and Rubber Stopper.	24	041193014993	17	165
DB1000EZBN		EZ-Mount Sink Basket Strainer with Stainless Steel Body and Basket with EZ-Mount Connection and Brass Nut, Plastic Post and Rubber Stopper.	24	041193014948	17	165
DB1120		Deep Locking Cup Sink Basket Strainer, Stainless Steel Body and Basket, Rubber Stopper w/ Snap-In Basket. Length - 3-3/4".	24	041193011534	17	165
DB1120BN		Same as DB1120 w/ Brass Nuts.	24	041193014849	17	165
DB7416	1-1/4" x 16"	Stainless Steel Grab Bar w/ Exposed Flange, Satin Finish	4	041193008411	15	143
DB7424	1-1/4" x 24"	Stainless Steel Grab Bar w/ Exposed Flange, Satin Finish	4	041193008435	15	143
DB7436	1-1/4" x 36"	Stainless Steel Grab Bar w/ Exposed Flange, Satin Finish	4	041193008565	15	143
DB7442	1-1/4" x 42"	Stainless Steel Grab Bar w/ Exposed Flange, Satin Finish	4	041193008572	15	143
DB7512	1-1/2" x 12"	Stainless Steel Grab Bar w/ Exposed Flange, Satin Finish	4	041193008602	15	143
DB7518	1-1/2" x 18"	Stainless Steel Grab Bar w/ Exposed Flange, Satin Finish	4	041193008626	15	143
DB7524	1-1/2" x 24"	Stainless Steel Grab Bar w/ Exposed Flange, Satin Finish	4	041193008633	15	143
DB7530	1-1/2" x 30"	Stainless Steel Grab Bar w/ Exposed Flange, Satin Finish	4	041193008640	15	143
DB7532	1-1/2" x 32"	Stainless Steel Grab Bar w/ Exposed Flange, Satin Finish	4	041193008657	15	143
DB7536	1-1/2" x 36"	Stainless Steel Grab Bar w/ Exposed Flange, Satin Finish	4	041193008664	15	143
DB7542	1-1/2" x 42"	Stainless Steel Grab Bar w/ Exposed Flange, Satin Finish	4	041193008688	15	143
DB7548	1-1/2" x 48"	Stainless Steel Grab Bar w/ Exposed Flange, Satin Finish	4	041193008718	15	143
DB8712	1-1/4" x 12"	Stainless Steel Grab Bar w/ Concealed Flange, Satin Finish	4	041193008732	15	143
DB8712P	1-1/4" x 12"	Stainless Steel Grab Bar w/ Concealed Flange, Peened Finish	4	041193013538	15	144
DB8716	1-1/4" x 16"	Stainless Steel Grab Bar w/ Concealed Flange, Satin Finish	4	041193008756	15	143
DB8716P	1-1/4" x 16"	Stainless Steel Grab Bar w/ Concealed Flange, Peened Finish	4	041193013545	15	144

NUMERICAL LISTING



Product No.	Size	Description	Ctn. Qty.	UPC	Category	Page Number
DB8718	1-1/4" x 18"	Stainless Steel Grab Bar w/ Concealed Flange, Satin Finish	4	041193008800	15	143
DB8724	1-1/4" x 24"	Stainless Steel Grab Bar w/ Concealed Flange, Satin Finish	4	041193008862	15	143
DB8724P	1-1/4" x 24"	Stainless Steel Grab Bar w/ Concealed Flange, Peened Finish	4	041193013576	15	144
DB8730	1-1/4" x 30"	Stainless Steel Grab Bar w/ Concealed Flange, Satin Finish	4	041193008886	15	143
DB8732	1-1/4" x 32"	Stainless Steel Grab Bar w/ Concealed Flange, Satin Finish	4	041193008923	15	143
DB8736	1-1/4" x 36"	Stainless Steel Grab Bar w/ Concealed Flange, Satin Finish	4	041193008947	15	143
DB8736P	1-1/4" x 36"	Stainless Steel Grab Bar w/ Concealed Flange, Peened Finish	4	041193013637	15	144
DB8742	1-1/4" x 42"	Stainless Steel Grab Bar w/ Concealed Flange, Satin Finish	4	041193008954	15	143
DB8742P	1-1/4" x 42"	Stainless Steel Grab Bar w/ Concealed Flange, Peened Finish	4	041193013644	15	144
DB8748	1-1/4" x 48"	Stainless Steel Grab Bar w/ Concealed Flange, Satin Finish	4	041193008978	15	143
DB8912	1-1/2" x 12"	Stainless Steel Grab Bar w/ Concealed Flange, Satin Finish	4	041193009005	15	143
DB8912P	1-1/2" x 12"	Stainless Steel Grab Bar w/ Concealed Flange, Peened Finish	4	041193013736	15	144
DB8916	1-1/2" x 16"	Stainless Steel Grab Bar w/ Concealed Flange, Satin Finish	4	041193009012	15	143
DB8918	1-1/2" x 18"	Stainless Steel Grab Bar w/ Concealed Flange, Satin Finish	4	041193009029	15	143
DB8918P	1-1/2" x 18"	Stainless Steel Grab Bar w/ Concealed Flange, Peened Finish	4	041193013781	15	144
DB8924	1-1/2" x 24"	Stainless Steel Grab Bar w/ Concealed Flange, Satin Finish	4	041193009043	15	143
DB8924P	1-1/2" x 24"	Stainless Steel Grab Bar w/ Concealed Flange, Peened Finish	4	041193013798	15	144
DB8930	1-1/2" x 30"	Stainless Steel Grab Bar w/ Concealed Flange, Satin Finish	4	041193009067	15	143
DB8932	1-1/2" x 32"	Stainless Steel Grab Bar w/ Concealed Flange, Satin Finish	4	041193009074	15	143
DB8932P	1-1/2" x 32"	Stainless Steel Grab Bar w/ Concealed Flange, Peened Finish	4	041193013811	15	144
DB8936	1-1/2" x 36"	Stainless Steel Grab Bar w/ Concealed Flange, Satin Finish	4	041193009128	15	143
DB8936P	1-1/2" x 36"	Stainless Steel Grab Bar w/ Concealed Flange, Peened Finish	4	041193013828	15	144
DB8942	1-1/2" x 42"	Stainless Steel Grab Bar w/ Concealed Flange, Satin Finish	4	041193009135	15	144
DB8942P	1-1/2" x 42"	Stainless Steel Grab Bar w/ Concealed Flange, Peened Finish	4	041193013835	15	144
DB8948	1-1/2" x 48"	Stainless Steel Grab Bar w/ Concealed Flange, Satin Finish	4	041193009142	15	143
DB8948P	1-1/2" x 48"	Stainless Steel Grab Bar w/ Concealed Flange, Peened Finish	4	041193013859	15	144
HD72C		1/4" O.D. Tube, Bagged	20	041193005557	17	174
HD73C		1/2" O.D. Tube, Bagged	20	041193005601	17	174
HD75C		Flange 1/2" IPS, Bagged	20	041193005656	17	174
HD76C		5/8" O.D. for 1/2" Nom Copper, Bagged	20	041193005700	17	174
H137-17-3	7"	Waste Arm w/ Slip Joint For 16" Center Outlet- 17 Ga., Unfinished, Cutcase Box	6	041193005571	15	136



Product No.	Size	Description	Ctn. Qty.	UPC	Category	Page Number
H137B-17-3	1 1/2"	Waste Arm w/ Slip Joint For 24" Center Outlet- 17 Ga., Unfinished, Cutcase Box	6	041193005199	15	136
H402B-17-3	1-1/2"	Wall Tube 15" - 17 Ga., Unfinished, Cutcase Box	6	041193005540	15	134
H704-3	1-1/2"	P-Trap - 17 Ga., Unfinished, Cutcase Box	6	041193004963	15	131
H751-3	1-1/2" x 2"	L.A. Trap - 17 Ga., Unfinished, Cutcase Box	6	041193004833	15	132
H752-3	1-1/4" x 1-1/2"	N.Y. Trap - 17 Ga., Unfinished, Cutcase Box	6	041193004840	15	132
H753-3	1-1/2" x 2"	N.Y. Trap - 17 Ga., Unfinished, Cutcase Box	6	041193004864	15	132
H1046A-17-3	1-1/2"	Double Slip Joint Trap Offset - 17 Ga. Unfinished, Cutcase Box	6	041193005564	15	139
H1099A		Flat Escutcheon 7/8" Copper, Bagged	20	041193025838	17	174
H1116		1-1/4" O.D. Tube In Bag, Display Box	20	041193107558	17	174
H1117		1-1/2" O.D. Tube In Bag, Display Box	20	041193107572	17	174
HD1831C		Flange 3/8" IPS, Bagged	20	041193012555	17	174
H2401-1	1-1/4"	Wall Tube 6.5" - Budget Ga., Ind. UPC	10	041193056092	15	134
H2402-1	1-1/2"	Wall Tube 7.5" - Budget Ga., Ind. UPC	10	041193084958	15	134
HD2661C	1-1/2"	Repair Trap w/ Compression Elbow & 1-1/2" or 1-1/4" Washer, Printed Bag, Display Box	12	041193014405	15	145
HD2670C		Elbow for Waste King® Disposer, Plastic	12	041193005380	15	152
HD2672C		Disposal Gasket For In-Sink-Erator®, Printed Bag	24	041193005397	15	152
HD2673C		Elbow For In-Sink-Erator® Plastic, Display Box	10	041193005410	15	152
HD2688B	1-1/2" & 1-1/4"	Reducer Adapter, Printed Bag	12	041193033505	15	152
HD2698C		Nut and Washer Slip Joint 1-1/2" Plastic, Ind. Printed Bag, Display Box	20	041193015303	15	151
HD2699C		Polyethylene Beveled Washers Assorted, Ind. Printed Bag, Display Box	20	041193006691	15	151
HD2798C		Nut and Washer Slip Joint 1-1/4" Plastic, Ind. Printed Bag, Display Box	20	041193093790	15	151
HD5340C		1/2" Tube, Bagged	20	041193054432	17	175
HD5341C		3/4" Tube, Bagged	20	041193005793	17	175
HD5351C		1/2" IPS, Bagged	20	041193041319	17	175
HD5352C		3/4" IPS, Bagged	20	041193041326	17	175
HD5353C		1" IPS, Bagged	24	041193025821	17	175
HD5354C		1-1/4" IPS, Bagged	20	041193038975	17	175
HD5355C		1-1/2" IPS, Bagged	20	041193038982	17	175
HD5356C		2" IPS, Bagged	20	041193025845	17	175
HD7195C		Polyethylene Flanged Washers, 1-1/2", Ind. Printed Bag, Display Box	20	041193038654	15	151
HD7196C		Polyethylene Beveled Washers 1-1/4", Ind. Printed Bag, Display Box	20	041193024558	15	151
HD7197C		Polyethylene Beveled Washers 1-1/2", Ind. Printed Bag, Display Box	20	041193024602	15	151
HD7198C		Polyethylene Beveled Washers 1-1/2" x 1-1/4", Ind. Printed Bag, Display Box	20	041193024619	15	151
HD7202C		Rubber Slip Joint Washer 1-1/4", 3/Card, Ind. Printed Bag, Display Box	20	041193024633	17	173
HD7203C		Rubber Slip Joint Washer 1-1/2", 3/Card, Ind. Printed Bag, Display Box	20	041193024640	17	173
HD7210		Rubber Slip Joint Reducing Washers 1-1/2" x 1-1/4", Ind. Printed Bag, Display Box	25	041193054890	17	173
HD7983C		Dishwasher Disposal Connector, Printed Bag, Display Box	20	041193028655	15	152
HD8030C		Zinc Nut & Washer Slip Joint 1-1/4", Ind. Printed Bag, Display Box	20	041193028907	17	173
HD8031C		Zinc Nut & Washer Slip Joint 1-1/4" x 1-1/2", Ind. Printed Bag, Display Box	20	041193028952	17	173

NUMERICAL LISTING



db Dearborn Brass.



Oatey

Product No.	Size	Description	Ctn. Qty.	UPC	Category	Page Number
HD8033C		Zinc Nut & Washer Slip Joint 1-1/2", Ind. Printed Bag, Display Box	20	041193029058	17	173
HP9005	1-1/4"	Wall Tube, Display Box, Ind. UPC	20	041193094766	15	145
HP9006	1-1/2"	Wall Tube, Display Box, Ind. UPC	12	041193056948	15	145
HP9650BG	1-1/4"	J-Bend, Printed Bag, Display Box	12	041193006141	15	145
HDP9651B	1-1/2"	J-Bend, Printed Bag, Display Box	12	041193033086	15	145
HP9654	1-1/2"	Repair J-Bend w/ 1-1/2" or 1-1/4" Washer, Printed Bag, Display Box	12	041193104618	15	145
HP9786	1-1/2" x 6"	Solvent Weld Extension Tube, PVC, Display Box, Ind. UPC	12	041193057198	15	148
HD3522215		Form-N-Fit Pop-Up Unit 1-1/4" Plastic, DB Cutcase, Bagged	8	041193015433	15	152
HD3522355		Connects To 1-1/2" Or 1-1/4" Metal Or Plastic Tailpiece. Extends From 5-1/2" To Over 11", Printed Bag, Display Box	10	041193014733	15	152
HD3522605		Connects To Kitchen Or Bath Drain Systems. J-Bend Neck Extends From 3-1/2" To Over 6", Printed Bag, Display Box	12	041193014740	15	152
HD3522845		Connects To All Drain Systems. Extends From 3-1/2" To Over 7" To Make Offsets Up To 2-1/2", Will Bend Over 90 Degree, Printed Bag, Display Box	10	041193014788	15	152
HD3526945		Connects To 1-1/4" Metal Or Plastic Tailpiece. Extends From 4-1/2" To Over 7-3/4", Printed Bag, Display Box	10	041193015426	15	152
HD3526955		Connects To Hi-Line And Slip Joint Applications. Adapts To 1-1/2" And 1-1/4" Drain Systems. Tailpiece Extends From 5-1/2" To Over 11" And Offsets Up To 4-1/2", Printed Bag, Display Box	10	041193014795	15	152
K20		Conversion Kit, Cable Stopper w/ Chrome Finish Trim	2	041193026149	16	156
K20BC		Conversion Kit, Cable Stopper w/ Biscuit Finish Trim	2	041193026163	16	156
K20BN		Conversion Kit, Cable Stopper w/ Brushed Nickel Finish Trim	2	041193027283	16	156
K20PB		Conversion Kit, Cable Stopper w/ UltraShine® Polished Brass Finish Trim	2	041193026170	16	156
K20RB		Conversion Kit, Cable Stopper w/ Rubbed Bronze Finish Trim	2	041193026187	16	156
K20SN		Conversion Kit, Cable Stopper w/ UltraShine® Satin Nickel Finish Trim	2	041193026248	16	156
K20WH		Conversion Kit, Cable Stopper w/ White Finish Trim	2	041193026262	16	156
K22BN		DBlue Trim Kit, for Schedule 40 - Rough-In Kit Uni-Lift Stopper w/ Brushed Nickel Finish Trim	10	041193007308	16	161
K22RB		DBlue Trim Kit, for Schedule 40 - Rough-In Kit Uni-Lift Stopper w/ Oil Rubbed Bronze Finish Trim	10	041193007223	16	161
K22TB		DBlue Trim Kit, for Schedule 40 - Rough-In Kit Uni-Lift Stopper w/ Chrome Finish Trim	10	041193006745	16	161
K22WH		Trim Kit, for Schedule 40 - Rough-In Kit Uni-Lift Stopper w/ White Finish Trim	10	041193007032	16	161
K22TB		DBlue Trim Kit, for Schedule 40 - Rough-In Kit Uni-Lift Stopper w/ Chrome Finish Trim	10		16	161
K22RB		DBlue Trim Kit, for Schedule 40 - Rough-In Kit Uni-Lift Stopper w/ Oil Rubbed Bronze Finish Trim	10		16	161
K22BN		DBlue Trim Kit, for Schedule 40 - Rough-In Kit Uni-Lift Stopper w/ Brushed Nickel Finish Trim	10		16	161
K23TB		DBlue Trim Kit, for Schedule 40 - Rough-In Kit Touch-Toe Stopper w/ Chrome Finish Trim	10		16	161
K23RB		DBlue Trim Kit, for Schedule 40 - Rough-In Kit Touch-Toe Stopper w/ Oil Rubbed Bronze Finish Trim	10		16	161
K23BN		DBlue Trim Kit, for Schedule 40 - Rough-In Kit Touch-Toe Stopper w/ Brushed Nickel Finish Trim	10		16	161



Product No.	Size	Description	Ctn. Qty.	UPC	Category	Page Number
K23BN		DBlue Trim Kit, for Schedule 40 - Rough-In Kit Touch-Toe Stopper w/ Brushed Nickel Finish Trim	10	041193007315	16	161
K23RB		DBlue Trim Kit, for Schedule 40 - Rough-In Kit Touch-Toe Stopper w/ Oil Rubbed Bronze Finish Trim	10		16	161
K23TB		DBlue Trim Kit, for Schedule 40 - Rough-In Kit Touch-Toe Stopper w/ Chrome Finish Trim	10	041193006776	16	161
K24TB		Trim Kit, for Schedule 40 - Rough-In Kit Touch-Toe Stopper w/ Chrome Finish Trim	10	041193026293	16	161
K25TB		Trim Kit, for Schedule 40 - Rough-In Kit Uni-Lift Stopper w/ Chrome Finish Trim	10	041193026330	16	161
K25TBZ		Trim Kit, for Schedule 40 - Rough-In Kit Uni-Lift Stopper Zinc Drain Unit w/ Chrome Finish Trim	10	041193027269	16	161
K26		Conversion Kit, Trip Lever Stopper w/ Chrome Finish Trim	2	041193026408	16	162
K26BN		Conversion Kit, Trip Lever Stopper w/ Brushed Nickel Finish Trim	2	041193026460	16	162
K26PB		Conversion Kit, Trip Lever Stopper w/ UltraShine® Polished Brass Finish Trim	2	041193026415	16	162
K26RB		Conversion Kit, Trip Lever Stopper w/ Rubbed Bronze Finish Trim	2	041193026439	16	162
K26SC		Conversion Kit, Trip Lever Stopper w/ UltraShine® Satin Chrome Finish Trim	2	041193026446	16	162
K26SN		Conversion Kit, Trip Lever Stopper w/ UltraShine® Satin Nickel Finish Trim	2	041193026422	16	162
K27		Conversion Kit, Uni-Lift Stopper w/ Chrome Finish Trim	2	041193026477	16	164
K27AB		Conversion Kit, Uni-Lift Stopper w/ Antique Bronze Finish Trim	2	041193004246	16	164
K27BN		Conversion Kit, Uni-Lift Stopper w/ Brushed Nickel Finish Trim	2	041193026545	16	162
K27PB		Conversion Kit, Uni-Lift Stopper w/ UltraShine® Polished Brass Finish Trim	2	041193026484	16	162
K27RB		Conversion Kit, Uni-Lift Stopper w/ Rubbed Bronze Finish Trim	2	041193026521	16	162
K27SC		Conversion Kit, Uni-Lift Stopper w/ UltraShine® Satin Chrome Finish Trim	2	041193026538	16	162
K27SN		Conversion Kit, Uni-Lift Stopper w/ UltraShine® Satin Nickel Finish Trim	2	041193026514	16	162
K27WH		Conversion Kit, Uni-Lift Stopper w/ White Finish Trim	2	041193026491	16	162
K28		Conversion Kit, w Two-Hole Cover Plate, Uni-Lift Stopper w/ Chrome Finish Trim	2	041193004239	16	162
K28BN		Conversion Kit, w Two-Hole Cover Plate, Uni-Lift Stopper w/ Brushed Nickel Finish Trim	2	041193004253	16	162
K28RB		Conversion Kit, w Two-Hole Cover Plate, Uni-Lift Stopper w/ Rubbed Bronze Finish Trim	2	041193004260	16	162
K28SN		Conversion Kit, w Two-Hole Cover Plate, Uni-Lift Stopper w/ UltraShine® Satin Nickel Finish Trim	2	041193004277	16	162
K74TBN		Trim Kit, for Schedule 40 - Rough-In Kit Touch-Toe Stopper w/ Brushed Nickel Finish Trim	10	041193027313	16	161
K74TSN		Trim Kit, for Schedule 40 - Rough-In Kit Touch-Toe Stopper w/ UltraShine® Satin Nickel Finish Trim	10	041193027290	16	161
K74TWH		Trim Kit, for Schedule 40 - Rough-In Kit Touch-Toe Stopper w/ White Finish Trim	10	041193027320	16	161
K75AB		Trim Kit, for Schedule 40 - Rough-In Kit Uni-Lift Stopper w/ Antique Bronze Finish Trim	10	041193004291	16	161
K75TPB		Trim Kit, for Schedule 40 - Rough-In Kit Uni-Lift Stopper w/ UltraShine® Polished Brass Finish Trim	10	041193026361	16	161
K75TRB		Trim Kit, for Schedule 40 - Rough-In Kit Uni-Lift Stopper w/ Rubbed Bronze Finish Trim	10	041193026385	16	161
K75TSC		Trim Kit, for Schedule 40 - Rough-In Kit Uni-Lift Stopper w/ UltraShine® Satin Chrome Finish Trim	10	041193026392	16	161

NUMERICAL LISTING



Product No.	Size	Description	Ctn. Qty.	UPC	Category	Page Number
K75TSN		Trim Kit, for Schedule 40 - Rough-In Kit Uni-Lift Stopper w/ UltraShine® Satin Nickel Finish Trim	10	041193026378	16	161
L7		Lucky 7 Sink Basket Strainer, Chrome Plated Brass Body w/ Stainless Steel Basket, Metal Post, Heavy Locknut, Rubber Stopper, Extra Thick Washer, Machine Cut Threads.	24	041193071002	17	165
L7BN		Same as L7 w/ Brass Nuts	24	041193103635	17	165
L7T		Same as L7 w/ 4" Chrome Plated Tailpiece	24	041193071019	17	165
L74		Lucky 7 Sink Basket Strainer, w/ Stainless Steel 4-Prong Basket, Chrome Plated Brass Body, Metal Post, Rubber Stopper, Heavy Locknut, Extra Thick Washer, Machine Cut Threads.	24	041193016034	17	165
L74T		Same as L74 w/ 4" Tailpiece.	24	041193016041	17	165
P220		Rough-In Kit, Plastic Tubular – White Cable Stopper - No Trim	1	041193027276	16	156
P3225D		Quarter Kit, Schedule 40 - PVC Uni-Lift Stopper w/ Chrome Finish Trim Direct Drain	20	041193005885	16	160
P7220BF		Rough-In Kit, Schedule 40 - PVC Cable Stopper w/ Chrome Finish Trim	20	041193004352	16	160
P7223CRK		Rough-In Kit, Schedule 40 – PVC w/Condensate Elbow	30	041193004208	16	160
P7223RK		Rough-In Kit, Schedule 40 - PVC	30	041193016638	16	160
P7224		Full Kit, Schedule 40 - PVC Touch-Toe Stopper w/ Chrome Finish Trim	10	041193003140	16	158
P7224B		Half Kit, Schedule 40 - PVC Touch-Toe Stopper w/ Chrome Finish Trim	20	041193003157	16	158
P7225		Full Kit, Schedule 40 - PVC Uni-Lift Stopper w/ Chrome Finish Trim	10	041193095176	16	158
P7225B		Half Kit, Schedule 40 - PVC Uni-Lift Stopper w/ Chrome Finish Tr	20	041193095190	16	159
P7225BAB		Half Kit, Schedule 40 - PVC Uni-Lift Stopper w/ Antique Bronze Finish Trim	20	041193004307	16	159
P7225BBC		Half Kit, Schedule 40 - PVC Uni-Lift Stopper w/ Biscuit Finish Trim	20	041193027122	16	159
P7225BBN		Half Kit, Schedule 40 - PVC Uni-Lift Stopper w/ Brushed Nickel Finish Trim	20	041193004437	16	159
P7225BC		Half Kit, Schedule 40 - PVC Uni-Lift Stopper w/ Chrome Finish Trim Condensate Elbow	20	041193026729	16	160
P7225BRB		Half Kit, Schedule 40 - PVC Uni-Lift Stopper w/ Rubbed Bronze Finish Trim	20	041193027153	16	159
P7225BSC		Half Kit, Schedule 40 - PVC Uni-Lift Stopper w/ UltraShine® Satin Chrome Finish Trim	20	041193027139	16	159
P7225BSN		Half Kit, Schedule 40 - PVC Uni-Lift Stopper w/ UltraShine® Satin Nickel Finish Trim	20	041193027146	16	159
P7225BWH		Half Kit, Schedule 40 - PVC Uni-Lift Stopper w/ White Finish Trim	20	041193095237	16	159
P7225BZ		Half Kit, Schedule 40 - PVC Uni-Lift Stopper w/ Chrome Finish Trim w/ Zinc Drain Unit	20	041193004222	16	159
P7323		DBlue Rough-In Kit, Schedule 40 - PVC	30	041193006790	16	158
P7323RKZ		Rough-In Kit, Schedule 40 - PVC w/ Zinc Spud	30	041193732330	16	160
P7325		DBlue Half Kit, Schedule 40 - PVC Uni-Lift Stopper w/ Chrome Finish Trim and Test Plug	20	041193006783	16	159
P7325BCZ		Half Kit, Schedule 40 - PVC Condensate Elbow, Uni-Lift Stopper w/ Chrome Finish Trim and Zinc Spud	35	041193732552	16	160
P7325BN		DBlue Half Kit, Schedule 40 - PVC Uni-Lift Stopper w/ Brushed Nickel Finish Trim and Test Plug	20	041193007049	16	159
P7325BZ		DBlue Half Kit, Schedule 40 - PVC Uni-Lift Stopper w/ Chrome Finish Trim w/ Zinc Spud and Test Plug	20	041193732538	16	159
P7325RB		DBlue Half Kit, Schedule 40 - PVC Uni-Lift Stopper w/ Oil Rubbed Bronze Finish Trim and Test Plug	20	041193006882	16	159



Product No.	Size	Description	Ctn. Qty.	UPC	Category	Page Number
P7444		Full Kit, Schedule 40 - PVC Tap-Tap Stopper w/ Chrome Finish Trim	10	041193003881	16	158
P7444B		Half Kit, Schedule 40 - PVC Tap-Tap Stopper w/ Chrome Finish Trim	20	041193003874	16	158
P7544		DBLue Full Kit, Schedule 40 - PVC Uni-Lift Stopper w/ Chrome Finish Trim and Test Plug	10	041193006806	16	158
P7644		DBLue Full Kit, Schedule 40 - PVC Touch-Toe Stopper w/ Chrome Finish Trim and Test Plug	10	041193006851	16	158
P7725		DBLue Half Kit, Schedule 40 - PVC Touch-Toe Stopper w/ Chrome Finish Trim and Test Plug	20	041193006844	16	158
P7725BN		DBLue Half Kit, Schedule 40 - PVC Touch-Toe Stopper w/ Brushed Nickel Finish Trim and Test Plug	20	041193007148	16	158
P8220		Full Kit, Plastic Tubular – White Cable Stopper w/ Chrome Finish Trim	1	041193022110	16	156
P8227		Full Kit, Plastic Tubular - White Uni-Lift Stopper w/ Chrome Finish Trim	10	041193103918	16	157
P8227BG		Full Kit, Plastic Tubular - White Uni-Lift Stopper w/ Chrome Finish Trim Zinc Drain Unit, 2 Hole Faceplate	10	041193103932	16	157
P8227BN		Full Kit, Plastic Tubular - White Uni-Lift Stopper w/ Brushed Nickel Finish Trim	10	041193006271	16	157
P8227C		Full Kit, Plastic Tubular – White Uni-Lift Stopper w/ Chrome Finish Trim Condensate Elbow	10	041193100740	16	157
P8227D		Full Kit, Plastic Tubular – White Uni-Lift Stopper w/ Chrome Finish Trim Direct Drain	10	041193026712	16	157
P8227RB		Full Kit, Plastic Tubular - White Uni-Lift Stopper w/ Rubbed Bronze Finish Trim	10	041193027191	16	157
P9000	1-1/2"	PVC Solvent Weld Adapter	25	041193050076	15	150
P9000A	1-1/2"	PVC Threaded Adapter w/ Nut & Washer Printed Bag, Display Box	25	041193056900	15	150
P9001	1-1/2"	Slip Joint Nut	100	041193056924	15	151
P9001A	1-1/4"	Slip Joint Nut	100	041193103970	15	151
P9009	1-1/4"	I.D. Deep Flange	25	041193093691	15	151
P9010	1-1/2"	I.D. Deep Flange	25	041193104014	15	151
P9046A	1-1/2"	Double Slip Joint Trap Offset	25	041193085467	15	150
P9100	1-1/2"	Disposer Kit For In-Sink-Erator®	25	041193104021	15	149
P9100B	1-1/2"	Disposer Kit For In-Sink-Erator®, Bagged	25	041193104038	15	149
P9100GE	1-1/2" x 15"	Disposer Kit For GE®	25	041193104045	15	149
P9100GEB	1-1/2" x 15"	Disposer Kit For GE®, Bagged	25	041193104052	15	149
P9100T	1-1/2"	Telescopic Disposer Kit For In-Sink-Erator® or GE®	25	041193104069	15	149
P9100TB	1-1/2"	Telescopic Disposer Kit For In-Sink-Erator®, Bagged	25	041193042828	15	149
P9100WB	1-1/2"	Disposer Kit For In-Sink Erator, Bagged w/ True Blue Washer	25	041193009197	15	149
P9103	1-1/2" x 13"	Master Disposer Kit	25	041193056962	15	149
P9108A	1-1/2" x 16"	Center to Center, Slip Joint w/ Baffle Tee	25	041193104090	15	146
P9108AB	1-1/2" x 16"	Center to Center, Slip Joint w/ Baffle Tee, Bagged	25	041193104106	15	146
P9108AT	1-1/2" x 11"-17"	Slip Joint w/ Telescopic Waste Arm	25	041193104113	15	146
P9108ATB	1-1/2" x 11"-17"	Slip Joint w/ Telescopic Waste Arm, Bagged	25	041193104120	15	146
P9108AWB	1-1/2" X 16"	Center to Center, Slip Joint with Baffle Tee, Bagged w/ True Blue Washer	25	041193009203	15	146
P9108B	1-1/2" x 21"	Center to Center, Slip Joint w/ Baffle Tee	25	041193104137	15	146
P9114A	1-1/2" x 16"	Center to Center, Slip Joint w/ Baffle Tee	25	041193104144	15	147
P9114AB	1-1/2" x 16"	Center to Center, Slip Joint w/ Baffle Tee	25	041193104151	15	147
P9121	1-1/2" x 16"	Center to Center, Hi-Line w/ Baffle Tee	25	041193104175	15	146
P9121A	1-1/2" x 16"	Center to Center, Hi-Line/ Slip Joint Combination w/ Baffle Tee	25	041193056979	15	146

NUMERICAL LISTING



Product No.	Size	Description	Ctn. Qty.	UPC	Category	Page Number
P9121ABG	1-1/2" x 16"	Center to Center, Hi-Line/ Slip Joint Combination w/ Baffle Tee, Bagged	25	041193000101	15	146
P9121AT	1-1/2" x 11"-17"	Hi-Line/Slip Joint Combination w/ Telescopic Waste Arm	25	041193104182	15	146
P9121AT-12	1-1/2" x 11"-17"	Hi-Line/Slip Joint Combination w/ Telescopic Waste Arm & 3/4" Branch	25	041193074379	15	146
P9121AT-8	1-1/2" x 11"-17"	Hi-Line/Slip Joint Combination w/ Telescopic Waste Arm & 1/2" Branch	25	041193074362	15	146
P9121ATBG	1-1/2" x 11"-17"	Hi-Line/Slip Joint Combination w/ Telescopic Waste Arm, Bagged	25	041193010339	15	146
P9121ATWBG	1-1/2" X 11"-17"	Hi-Line/Slip Joint Combination w/ Telescopic Waste Arm, Bagged w/ True Blue Washer	25	041193009210	15	146
P9121B	1-1/2" x 21"	Center to Center, Hi-Line/ Slip Joint Combination w/ Baffle Tee	25	041193104199	15	146
P9121T	1-1/2" x 21"	End Outlet Waste Hi-Line w/Telescopic Tee	25	041193089427	15	146
P9123	1-1/2" x 16"	Center to Center, Hi-Line w/ Baffle Tee	25	041193019080	15	147
P9123A	1-1/2" x 16"	Center to Center, Hi-Line/Slip Joint Combination w/ Baffle Tee	25	041193104205	15	147
P9123ABG	1-1/2" x 16"	Center to Center, Hi-Line/Slip Joint Combination w/ Baffle Tee, Bagged	25	041193000156	15	147
P9123AW	1-1/2" X 16"	Center to Center, Hi-Line/Slip Joint Combination with Baffle Tee, Bagged w/ True Blue Washer	25	041193009227	15	147
P9123B	1-1/2" x 21"	Center to Center, Hi-Line/Slip Joint Combination w/ Baffle Tee	25	041193056993	15	147
P9137	1-1/2" x 7"	Waste Arm w/ Slip Joint	25	041193057006	15	147
P9137C	1-1/2" x 15"	Waste Arm w/ Slip Joint	25	041193057020	15	147
P9137D	1-1/2" x 20"	Waste Arm w/ Slip Joint	25	041193057037	15	147
P9138C	1-1/2" x 15"	Waste Arm w/ Hi-Line	25	041193104229	15	147
P9141A	1-1/2"	O.D. x 6 Ft. Tubing, PVC	10	041193057044	15	151
P9185	1-1/2"	Baffle Tee, For Slip Joint End Outlet Waste	25	041193057051	15	147
P9185W	1-1/2"	Baffle Tee, For Slip Joint End Outlet Waste w/ True Blue Washer	25	041193009234	15	147
P9186	1-1/2"	Baffle Tee, For Slip Joint Center Outlet Waste	25	041193057068	15	147
P9187	1-1/2"	Baffle Tee, For Hi-Line End Outlet Waste	25	041193057075	15	147
P9225BBG		Half Kit, Schedule 40 - PVC Uni-Lift Stopper w/ Chrome Finish Trim w/ Zinc Drain Unit No Test Kit, 2 Hole Faceplate	25	041193104366	16	159
P9226		Full Kit, Plastic Tubular - White Trip-Lever Stopper w/ Chrome Finish	10	041193057099	16	156
P9228		Full Kit, Plastic Tubular - White Touch-Toe Stopper w/ Chrome Finish Trim	10	041193057112	16	157
P9665	1-1/2"	45 Degree Slip Joint Elbow	25	041193057136	15	150
P9675	1-1/2"	90 Degree Slip Joint Elbow	25	041193057143	15	150
P9679	1-1/2"	Tee Slip Joint Connector	25	041193057150	15	150
P9700	1-1/4"	Choked Throat Outlet P-Trap w/ 1-1/2" Inlet	25	041193104625	15	144
P9700BG	1-1/4"	Choked Throat Outlet P-Trap w/ 1-1/2" Inlet, Bagged	25	041193094780	15	144
P9701	1-1/4"	P-Trap	25	041193104632	15	144
P9701B	1-1/4"	P-Trap less Flange, Bagged	25	041193104649	15	144
P9701BG	1-1/4"	P-Trap, Bagged	25	041193094797	15	144
P9701DFB	1-1/4"	P-Trap w/ Deep Flange, Bagged	25	041193093738	15	144
P9701PBDFB	1-1/4"	P-Trap w/ Deep Flange, Polished Brass Finish, Bagged	25	041193095046	15	144
P9702	1-1/2"	P-Trap w/ PVC Quarter Bend & Solvent Weld Adapter	25	041193104656	15	144
P9702B	1-1/2"	P-Trap w/ PVC Quarter Bend & Solvent Weld Adapter, Bagged	50	041193104663	15	144
P9702DF	1-1/2"	P-Trap w/ PVC Quarter Bend, Solvent Weld Adapter & Deep Flange	25	041193104670	15	144



Product No.	Size	Description	Ctn. Qty.	UPC	Category	Page Number
P9702DFB	1-1/2"	P-Trap w/ PVC Quarter Bend, Solvent Weld Adapter & Deep Flange, Bagged	50	041193104687	15	144
P9702R	1-1/2"	Repair Trap w/ 1-1/2" or 1-1/4" Washer	25	041193104694	15	145
P9702T	1-1/2"	P- Trap w/ PVC Quarter Bend & Threaded PVC Adapter	25	041193104717	15	144
P9703BG	1-1/2"	P-Trap w/ Threaded PVC Adapter & Reversible J-Bend, Bagged	25	041193018616	15	144
P9703W	1-1/2"	P-Trap with Threaded PVC Adapter and Reversible J-Bend in a Carton w/ True Blue Washer	25	041193097033	15	144
P9703WBG	1-1/2"	P-Trap with Threaded PVC Adapter, and Reversible J-Bend, Bagged w/ True Blue Washer	50	041193009241	15	144
P9704	1-1/2"	P-Trap w/ Threaded PVC Adapter	25	041193057167	15	145
P9704A	1-1/2"	P-Trap (White) w/ Threaded ABS Adapter	25	041193104724	15	145
P9704AB	1-1/2"	P-Trap (White) w/ Threaded ABS Adapter, Bagged	50	041193104731	15	145
P9704BG	1-1/2"	P-Trap w/ Threaded PVC Adapter, Bagged	50	041193104755	15	145
P9704DF	1-1/2"	P-Trap w/ Threaded PVC Adapter & Deep Flange	25	041193104779	15	145
P9704DFB	1-1/2"	P-Trap w/ Threaded PVC Adapter & Deep Flange, Bagged	50	041193104786	15	145
P9718	1-1/4"	S-Trap w/ PVC Solvent Weld Adapter	25	041193093721	15	145
P9720	1-1/2"	S-Trap w/ PVC Solvent Weld Adapter	25	041193104793	15	145
P9722	1-1/2"	S-Trap w/ PVC Threaded Adapter	25	041193057174	15	145
P9722BG	1-1/2"	S-Trap w/ PVC Threaded Adapter, Bagged	10	041193095374	15	145
P9722W	1-1/2"	S-Trap w/ PVC Threaded Adapter w/ True Blue Washer	25	041193009265	15	145
P9786A	1-1/2" x 8"	Solvent Weld Extension Tube, PVC	25	041193057204	15	148
P9787A	1-1/2" x 12"	Solvent Weld Extension Tube, PVC	25	041193057211	15	148
P9787E	1-1/2" x 16"	Double Connect Solvent Weld Extension Tube, PVC	25	041193057228	15	148
P9790	1-1/4" x 6"	Slip Joint Extension Tube	25	041193093714	15	148
P9791A	1-1/4" x 12"	Slip Joint Extension Tube	25	041193093707	15	148
P9791E	1-1/4" x 16"	Double Connect Slip Joint Extension Tube	25	041193093684	15	148
P9792	1-1/2" x 6"	Slip Joint Extension Tube	25	041193057235	15	148
P9792A	1-1/2" x 8"	Slip Joint Extension Tube	25	041193057242	15	148
P9792AW	1-1/2" X 8"	Slip Joint Extension Tube w/ True Blue Washer	25	041193009272	15	148
P9793A	1-1/2" x 12"	Slip Joint Extension Tube	25	041193057259	15	148
P9793AC	1-1/2" x 12"	Slip Joint Extension Tube, PVC	25	041193003850	15	148
P9793D	1-1/2" x 2"	Double Slip Connector	25	041193057266	15	150
P9793E	1-1/2" x 16"	Double Connect Slip Joint Extension Tube	25	041193104823	15	148
P9793EC	1-1/2" x 16"	Double Connect Slip Joint Extension Tube, PVC	25	041193003836	15	148
P9793EW	1-1/2" X 16"	Double Connect Slip Joint Extension Tube w/ True Blue Washer	25	041193009333	15	148
P9799	1-1/2" x 4"	Flanged Strainer Tailpiece	25	041193057280	15	148
P9800	1-1/2" x 6"	Flanged Strainer Tailpiece	25	041193057297	15	148
P9801	1-1/2" x 8"	Flanged Strainer Tailpiece	25	041193057303	15	148
P9803	1-1/2" x 12"	Flanged Strainer Tailpiece	25	041193057310	15	148
P9803C	1-1/2" x 12"	Flanged Strainer Tailpiece, PVC	25	041193003843	15	148
P9803E	1-1/2" x 16"	Double Flanged Strainer Tailpiece	25	041193057327	15	148
P9803EC	1-1/2" x 16"	Double Flanged, Strainer Tailpiece, PVC	25	041193003829	15	148
PP9816	1-1/2" x 8"	Branch Tailpiece, Slip Joint Top w/ 1/2" Branch	25	041193103789	15	149
PP9816BD	1-1/2" x 8"	Branch Tailpiece, Hi-Line/ Slip Joint Combination w/ 1/2" Branch	25	041193103796	15	149
PP9816W	1-1/2" x 8"	Branch Tailpiece, Slip Joint Top w/ 1/2" Branch w/ True Blue Washer	25	041193009340	15	149
PP9817	1-1/2" x 8"	Branch Tailpiece, Slip Joint Top w/ 3/4" Branch	25	041193103802	15	149

NUMERICAL LISTING



Product No.	Size	Description	Ctn. Qty.	UPC	Category	Page Number
PP9817BD	1-1/2" x 8"	Branch Tailpiece, Hi-Line/ Slip Joint Combination Top w/ 3/4" Branch	25	041193103819	15	151
PP9817W	1-1/2" x 8"	Branch Tailpiece, Slip Joint Top w/ 3/4" Branch w/ True Blue Washer	25	041193009357	15	149
PP9818	1-1/2" x 8"	Branch Tailpiece, Hi-Line w/ 1/2" Branch	25	041193103826	15	149
PP9819	1-1/2" x 8"	Branch Tailpiece, Hi-Line w/ 3/4" Branch	25	041193058508	15	149
R100		26" x 45" Chrome Plated Brass Add- On Shower Frame w/Wall & Ceiling Supports for Fixture w/Bath Faucet in Tub Includes No. 355 Tub Spout, No. 126WS Shower Head w/ 3/4" NPT, 3-3/8" Centers. 3/4" Diameter	1	041193050427	17	178
R1006		1-1/4" x 1-1/2" Male (Female Copper Sweat)	6	041193105493	17	172



The Oatey® Network

Through seven production facilities located throughout North America and China, Oatey designs, manufactures and sources over 10,000 plumbing related products. Nearly 80% of our products are manufactured in the United States, distributed in more than 70 countries worldwide.



OATEY**SCS**®
Supply Chain Services

4675 W. 160th St. | Cleveland, OH 44135
216.267.7100 / 800.321.9532
Fax: 800.321.9535
www.oatey.com

© 2012 Oatey. All Rights Reserved.
© Oatey SCS is a registered trademark of Oatey Co.
This information is based on data believed to be reliable but Oatey makes no warranties, express or implied, as to its accuracy and assumes no liability arising out of its use. The data listed falls within the normal range of product properties but should not be used to establish specification limits or used alone as the basis of design. Oatey's liability to purchasers is expressly limited to the terms and conditions of sale.
LCS 911C