

## PRODUCT CATALOG







## PROFESSIONAL-GRADE TOOLS. WORLD-CLASS INNOVATION.

Cutting, scraping, sawing and removing grout are hard work. But they don't have to be. Now there's a smarter way to tackle the time-consuming, labor-intensive, sweat-inducing jobs that you do every day.

Spyder Tools are engineered to make your jobs easier. With these tough-as-nails power tool attachments, it doesn't take nearly as much time or effort to cut through metal pipe, rip up stubborn tile or plunge cut through drywall.

Since our inception in 2008, when the Spyder Scraper® won New Product of the Year at the National Hardware Show, Spyder has been driven by quality and innovation. From the perfect alignment of saw teeth to the ingenious design of a blade that produces less friction, every tool is meticulously constructed to provide significant advantages over the standard way of doing things. The result is an entire line of high-quality attachments for reciprocating saws and oscillating tools that save you time, effort and money.

**TOOLS YOU'LL LOVE FOR THE JOBS YOU DON'T™**





## THE ORIGINAL SPYDER SCRAPER®

Finish the job in a fraction of the time with a fraction of the effort with the award-winning tool that started it all.

4



## SPYDER GROUT-OUT™

Whether you're replacing just one tile or all of them, Spyder Grout-Out provides the speed and precision to make your job easy.

6



## NEW SPYDER SANDER

This versatile reciprocating saw attachment makes quick work of tight spaces, curved surfaces and hard-to-reach corners.

8



## NEW SPYDER BRUSHES

Available with durable nylon or tough carbon steel wire bristles, Spyder brushes fit any reciprocating saw and make clean-up and surface prep a snap.

9

10



**NEW**

## SPYDER HOLE SAWS

Our patented Rapid Switch™ and Rapid Core Eject™ systems provide unmatched versatility and efficiency to make cutting holes a snap.



14



**NEW**

## SPYDER DOUBLE-SIDED OSCILLATING TOOL ATTACHMENTS

Useful on almost any project, our double-sided oscillating tool attachments will quickly become the go-to tools in your accessory toolbox.



20



**NEW**

## SPYDER JIG SAW BLADES

Our double-sided jig saw blades pivot on a dime to deliver extraordinarily tight cuts. And our unique Skeleton jig saw blades dissipate frictional heat.



22

## SPYDER BORE-BLADE™

With its rounded tip and a double-edged blade for multi-directional cuts, the Spyder Bore-Blade™ saves time and makes your job easier.



28

## SPYDER TOOL KITS

Spyder tool kits are a convenient and money-saving way to sample Spyder innovation.

# THE ORIGINAL SPYDER SCRAPER®

Rip through stubborn tile, linoleum, thinset, wallpaper and paint like a kid rips through wrapping paper on a birthday present. With its resharpenable carbon steel blade, the Spyder Scraper reciprocating saw attachment helps you finish the job in a fraction of the time with a fraction of the effort.

## ■ Features

- › Quenched and tempered high-carbon spring steel to retain edge sharpness
- › Fits all reciprocating saws
- › Multiple application uses
- › Re-sharpenable blade

## ■ Awards

**New Product Launch of the Year**  
*(2011 International Builders Show)*

**Seal of Approval from  
the Handyman Club of America**  
*(2011)*

**A "Top Pick" of home improvement  
expert Danny Lipford**  
*(2009 International Builders Show)*

**New Product of the Year**  
*(2008 National Hardware Show)*

**Do It Best Members Choice Awards**  
*(2008)*



2" Scraper provides accurate, precision scraping and chiseling on tough materials.



4" Scraper is designed for removing semi-tough materials.



6" Scraper is designed for larger projects with softer materials.

**MULTIPLE APPLICATIONS**  
**RE-SHARPENABLE BLADE**

**QUENCHED AND TEMPERED**  
**HIGH-CARBON SPRING STEEL**



2"	4"	6"	Materials
			Ceramic tile adhesive
			Thin-set
			Vinyl composition tile
			Linoleum
			Tough glue
			Drywall mud
			Paint
			Rubber-backed carpet
			Wallpaper

## SPYDER GROUT-OUT™

Grinding it out can take less time than you think. Spyder Grout-Out provides both speed and precision to make your job easy – whether you're replacing just one tile or all of them.

### ■ Features

- › Fits all reciprocating saws
- › 10x faster than hand removal
- › Vacuum-braised tungsten carbide grit
- › Power through any grout in a fraction of the time – including urethane and epoxy

### VACUUM-BRAISED TUNGSTEN CARBIDE GRIT

Spyder Grout-Out performs **10x faster** than hand removal.



**1/16"**  
100227



**3/16"**  
100231





■ 2 Sizes

1/16"

For joints 1/16"-3/16"

3/16"

For joints 3/16"-3/4"



**NEW**

## SPYDER SANDER

Finish a tough project in record time without gritting your teeth. Smooth things over with the Spyder Sander. This versatile reciprocating saw attachment makes quick work of tight spaces, curved surfaces and hard-to-reach corners.



500010

### 80, 120 AND 220 GRIT SANDPAPER INCLUDED

Far faster than orbital sanders, the Spyder Sander gives a smooth finish to tight spaces.

#### ■ Features

- › Quickly sand tight spaces, curved surfaces and outside and inside corners
- › Tough insert-molded attachment blade for maximum durability
- › Hook-and-loop sandpaper for quick and easy replacement
- › Compatible with Mouse® sandpaper
- › Fits all reciprocating saws

#### ■ Includes 3-piece corner sandpaper set





**NEW**

## SPYDER BRUSHES

Brush off stubborn layers of rust, paint, dirt and grime without breaking a sweat. Featuring durable nylon or tough carbon steel wire bristles, Spyder brushes fit any reciprocating saw and make clean-up and surface prep a snap.

### ■ Nylon Brush

- › Nylon bristles provide tough cleaning power without scratching surfaces
- › Use on grout, carpet, tile, laminates, rubber, concrete, brick and more
- › Makes quick work of stubborn layers of grime
- › Fits all reciprocating saws



### NYLON BRISTLES CLEAN WITHOUT SCRATCHING

For no-sweat surface prep, choose the durable Spyder nylon brush.

### ■ Wire Brush

- › Removes flaking paint, rust, scratches, dirt and small imperfections
- › Tough carbon steel bristles are shorter, for reduced flaring
- › Use on concrete, metal, stone and wood surfaces
- › Fits all reciprocating saws



### TOUGH CARBON STEEL BRISTLES

With its powerful carbon steel wire bristles, the Spyder wire brush helps you clean up in less time.



**NEW**

## SPYDER HOLE SAWS

Cut holes in a snap – even at an angle. Drop out the core at the touch of a button. Push the button again to change blade diameters. Faster. Easier. Smarter. With the Spyder Rapid Switch™ and Rapid Core Eject™ features, it's the most efficient hole saw system ever made.

### RAPID SWITCH AND RAPID CORE EJECT HOLE SAWS



#### Change diameter with one click

Quickly install or remove saw diameters. Just push the button to slide one hole saw off and slide another one on.

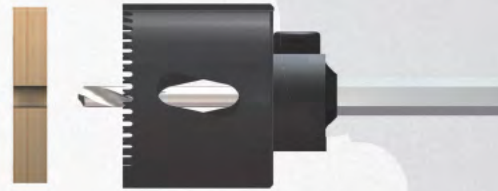

#### Drop out the core

Simply push the button and slide the blade back to remove the plug. No screwdriver required.

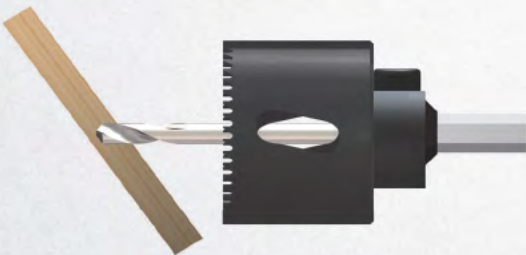

#### Cut at an angle

Click and pull the hole saw back to extend the pilot drill's length enough to cut at an angle. Release to complete the hole.



#### Enlarge holes that were drilled too small

Use your hole saw as a guide to turn a small-diameter hole into a larger one by using a wider-diameter saw.

## SPYDER PRO TCT HOLE SAWS

### ■ Extremely clean entry and exit cuts.

- › 5x faster than standard hole saws
- › Carbide tipped for extended life and clean cuts
- › Up to 50x more cuts than bi-metal hole saws
- › Cutting depth of up to 2" (51 mm)



*Carbide tipped  
for extended life  
and clean cuts*

## SPYDER BI-METAL HOLE SAWS (HSS)

### ■ Tough bi-metal steel for long life.

- › Variable tooth pitch guarantees a fast and clean cut through all thicknesses
- › Smooth cuts even at slow speed
- › Integrated arbor
- › Cutting depth of up to 1-7/8" (48 mm)



*Variable tooth  
pitch for a fast  
and clean cut*

## ARBORS AND PILOT DRILL BITS

- › For use with patented Rapid Switch and Rapid Core Eject hole saws
- › Smooth cuts even at slow speed
- › Delivers immediate and effortless plug removal
- › Available in 10 mm and 13 mm sizes
- › Included in combo kits or sold separately



**SPYDER RAPID CORE EJECT DROPS  
OUT THE CORE 6X FASTER THAN  
THE COMPETITION.**

**WITH SPYDER RAPID SWITCH, YOU  
CAN CHANGE YOUR DRILL BIT WITH  
ONE CLICK!**

Pro TCT	Bi-Metal (HSS)	Materials
		Wood
		Tropical hardwoods
		MDF
		Brick
		Tile (hardness up to 6)
		Fiber cement
		Gypsum
		Cellular concrete
		Plastics (PVC, nylon, polyester)
		Steel
		Cast iron
		Non-ferrous metals
		Acrylic glass



## BI-METAL HOLE SAW BLADE BENEFITS

- [  $b$  ] Width of blade
- [  $s$  ] Thickness of saw blade
- [  $h$  ] Gullet depth
- [  $t$  ] Tooth pitch
- [  $a$  ] Rake angle
- [  $c$  ] Clearance angle
- [  $w$  ] Width of set

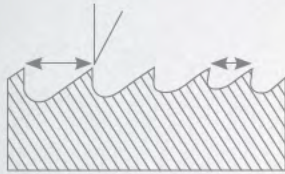
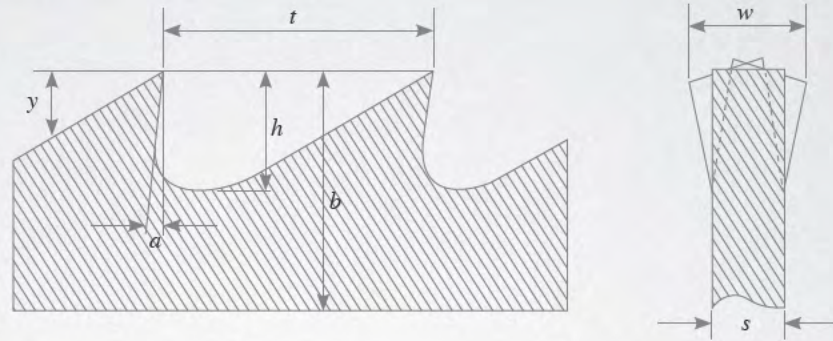

Designed for:

- > Low-vibration cutting
- > Solid materials

Data:

- > Positive rake angle
- > Variable pitch teeth of 0.55/0.75 to 4/6

### Positive and aggressive tooth rake angle

The bi-metal blade provides smooth chip clearing in a wide range of applications and materials, for maximum penetration and fast, deep cuts.

### Different depth of gullets

Smooth chip clearing in deep-cutting applications supports longer tooth life.

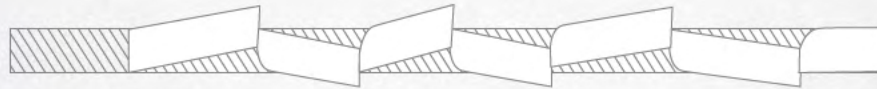

### Variable teeth setting

More teeth to share the cutting load helps ensure that cutting forces are evenly distributed. As a result, our bi-metal blade offers smoother cutting and longer life.

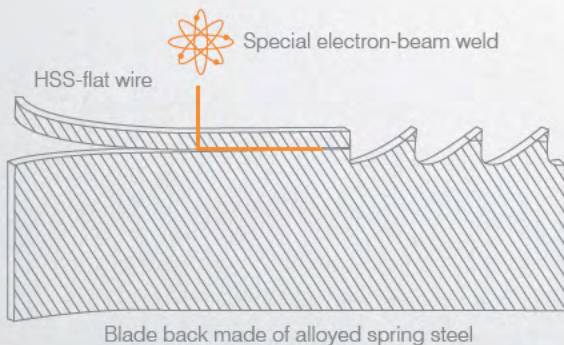

The high-quality bi-metal band combines the flexibility of a spring steel backing with the enormous wear resistance of high-speed steel. Each tooth tip is made of hardened high-speed steel, so they're extremely durable and provide fast, clean cuts.



**SPYDER**



 **NEW**

## SPYDER DOUBLE-SIDED OSCILLATING TOOL ATTACHMENTS

Make precise cuts and put the finishing touch on your job in a fraction of the time. Useful on almost any project, our double-sided oscillating tool attachments will quickly become the go-to items in your accessory toolbox.

### UNIVERSAL BLADES

These blades are great for cutting through virtually any material, including wood with nails, drywall, plastics, non-ferrous metals and fiberglass.



700000

#### ■ Universal Blade – Offset/Short

- › Double-sided, short offset blade for flush cuts
- › For use at any speed
- › Cutting width/depth: 1-3/4" (45 mm) x 1-3/8" (35 mm)
- › HSS – High Speed Steel
- › 18 TPI



7000001

#### ■ Universal Blade – Offset/Medium

- › Double-sided, medium offset blade for flush cuts
- › For use at medium/high speed
- › Cutting width/depth: 1-3/8" (35 mm) x 1-7/8" (48 mm)
- › HSS – High Speed Steel
- › 18 TPI



7000002

#### ■ Universal Blade – Offset/Wide Duo

- › Double-sided, dual use for multiple applications, wide offset blade for flush cuts
- › For use at medium/high speed
- › Cutting width/depth: 2-1/2" (65 mm) x 1-3/8" (35 mm)
- › HSS – High Speed Steel
- › 18 TPI

## JAPANESE BLADE

Our Japanese blade makes fast cuts in all types of wood, drywall and plastics with extremely close tolerances. The blade's thin kerf means you cut faster with less effort. Not for use with metal.



710000

### ■ Japanese Blade – Offset/Short

- › Double-sided, short offset blade for flush cuts
- › For use at any speed
- › Cutting width/depth: 1-3/4" (45 mm) x 1-3/8" (35 mm)
- › HCS – High Carbon Steel
- › 14 TPI

---

## SCRAPERS

Our rigid scraper is best for harder materials such as vinyl flooring, carpeting, adhesives, caulking and peeling paint. Our flexible scraper makes quick work of softer materials, including silicone joints, soft compounds and stickers.



720000

### ■ Scraper – Offset/Rigid

- › Double-sided, offset for flush scraping, rigid for hard materials
- › For use at any speed
- › Cutting width/depth: 1-3/4" (45 mm) x 1-3/8" (35 mm)
- › SS – Stainless Steel



720001

### ■ Scraper – Flexible

- › Double-sided, flat for long reach, flexible for soft materials
- › For use at any speed
- › Cutting width/depth: 1-3/4" (45 mm) x 2-1/4" (58 mm)
- › SS – Stainless Steel

## GROUT BLADE

Our unique egg-shaped grout blade gives you fluid motion, long reach and effortless use. Its longer arc makes it perfect for grout, mortar, brick, plaster, drywall, tile, fiberglass and cement board, and its tungsten carbide grit helps ensure long blade life.



730000

### ■ Grout Blade – Flat Carbide

- › Egg-shaped blade for fluid motion with long reach
- › For use at medium/high speed
- › Blade size: 2-1/2" (65 mm) x 3-1/2" (90 mm)
- › Carbide Grit: 2 mm

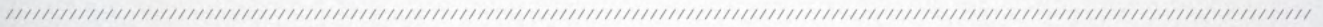

## RASP

Our unique nine-edged rasp is best for larger surface areas, allowing for fluid circular motion with an edge. Made from tungsten carbide grit, it offers long blade life. It's perfect for coarse grinding, sanding or removal of cement, wood, paint, thinset mortar, tile adhesives, natural and artificial stone, plaster and concrete.



740000

### ■ Rasp Blade – Nonagonal Carbide

- › Nonagon-shaped for larger areas, extra-coarse for an aggressive approach
- › Grit size: 3-1/8" (80 mm) x 3-1/8" (80 mm)
- › Carbide Grit: 20 Extra Coarse





## SANDING PADS

Our unique nine-edged pad is best for larger surface areas, allowing for fluid circular motion with an edge. Our fast-cutting sandpaper is made from silicon carbide (one of the hardest and sharpest abrasives available) and can be used either wet or dry.



### ■ Nonagonal Sander Attachment with 10 Sandpaper Sheets/Variou Grits

- › Nonagon-shaped hook-and-loop pad for sandpaper and accessories
- › Sandpaper can be used either wet or dry
- › Includes 2 x 40 grit, 2 x 80 grit, 2 x 120 grit, 2 x 180 grit and 2 x 240 grit sheets
- › Size: 3-1/8" (80 mm) x 3-1/8" (80 mm)
- › Silicon Carbide



### ■ Assorted Nonagonal Sandpaper – 20 Sheet Pack/Variou Grits

- › Can be used either wet or dry
- › 4 x 40 grit, 4 x 80 grit, 4 x 120 grit, 4 x 180 grit, 4 x 240 grit sheets
- › Size: 3-1/8" (80 mm) x 3-1/8" (80 mm)
- › Silicon Carbide





**NEW**

## SPYDER DOUBLE-SIDED JIG SAW BLADES

Cut your way out of any delicate situation. Our durable, hardened-steel, double-sided jig saw blades pivot on a dime to deliver extraordinarily tight cuts with unmatched precision, speed and cleanliness.

### ■ Features

- › Innovative double-sided, variable-pitch laser-tech teeth
- › Designed to create extreme curved cuts
- › Fast and smooth splinter-free cuts for reduced cleanup
- › Cuts all kinds of wood and wood-based products 1/8" – 1-1/2" in thickness
- › Manufactured in Germany

### QUALITY GERMAN CHROME AND VANADIUM STEEL

Our innovative **double-sided** jig saw blades cut in all directions, for superior performance on intricate cuts.



300010

300011

300033

300034



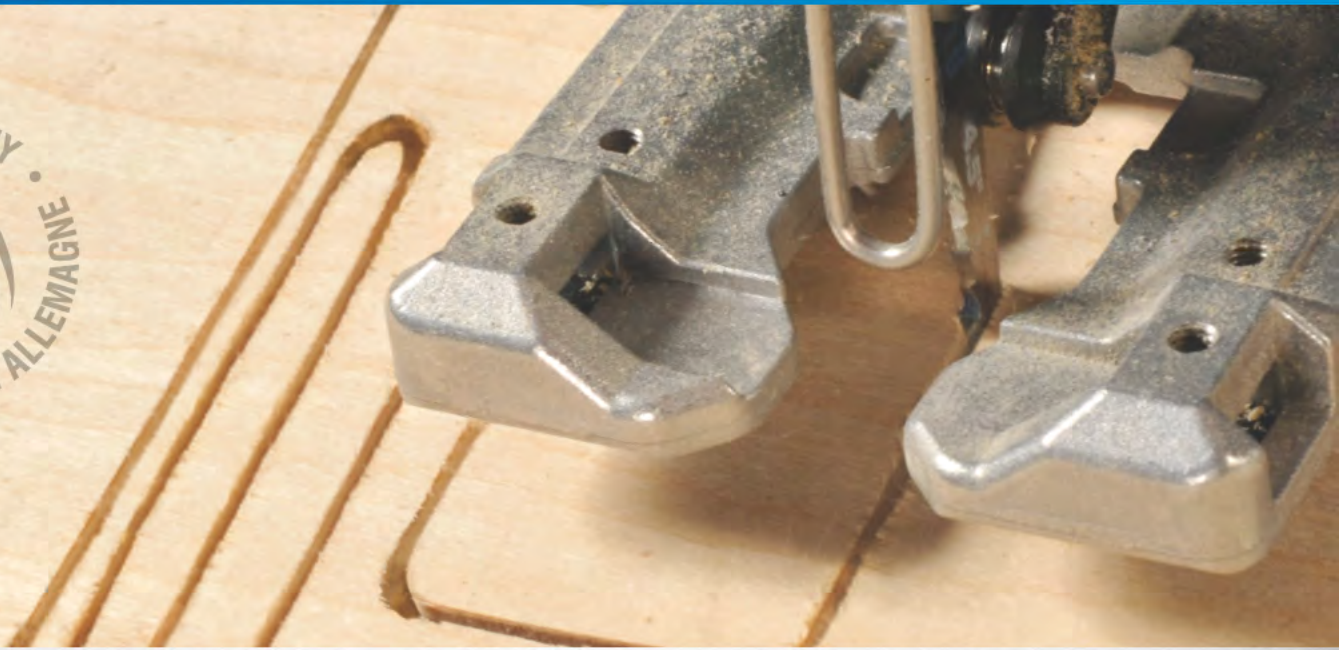

**NEW**

## SPYDER SKELETON™ JIG SAW BLADES

Cut 100% straight without losing your cool. Made in Germany using patented laser technology, Spyder Skeleton jig saw blades feature a parallel-cut, open framework design that helps dissipate frictional heat.

### ■ Features

- › Unique blade design
- › Edges of the blade barely touch the sides of the cutting channel
- › Frictional heat is dissipated through notches in the blade
- › The straightest-cutting jig saw blade on the market
- › Rip-cut notches for highly precise cuts and superior durability
- › Manufactured in Germany

### OPEN FRAMEWORK DESIGN DISSIPATES FRICTIONAL HEAT

With a unique shape that creates a rectangular channel, Spyder Skeleton jig saw blades offer highly precise cuts while maintaining superior blade durability.



300017

300032

300018

300036

## SPYDER BORE-BLADE™ PATENT PENDING

Plunge cut through wood without rattling your teeth. With its rounded tip and a double-edged blade for multi-directional cuts, the Spyder Bore-Blade reciprocating saw attachment will save you time and make your job easier.

### Features

- › Cuts 3 ways
- › Rounded tip plunge cuts with ease
- › Double-edged blade cuts both ways
- › Cuts wood, pipe, sheet metal, plastic, fiberglass and other materials
- › Double-sided, bi-metal, shatter-resistant steel
- › Optimized blade grind, set and kerf
- › Cost effective – two blades for the price of one!

### ROUNDED TIP PLUNGE CUTS WITH EASE

The double-edged Spyder Bore-Blade lets you make multi-directional cuts without flipping your saw over.



200017

200009

200001





7 TPI	10 TPI	14 TPI	Materials
			Wood
			Drywall
			Vinyl
			Laminate
			Wood with nails
			Fiberglass
			Metal
			Metal pipe

**SPYDER SCRAPER®**

(PAGE 4)

Item Number	Blade Width (in.)	Applications
00138	2	Tough material: remove paint, tile, thinset, linoleum, drywall mud and adhesive from wood, sheetrock, hardboard and concrete floors
00108	4	Semi-tough materials: remove paint, linoleum, drywall mud, and rubber-backed carpet and adhesive from wood, sheetrock, hardboard and concrete floors
00137	6	Soft materials: remove drywall mud, paint, rubber-backed carpet and wallpaper
00134	Multi-Pack (1 each of 2", 4" and 6" blades)	Complete package to accomplish any job

**SPYDER HOLE SAWS:  
BI-METAL (HSS) WITH RAPID CORE EJECT**

(PAGE 10-13)

Item Number	Diam. (in.)	Pipe Tap (in.)	Pipe Entrance (in.)	Use Arbor
600061	3/4	1/2	3/8	Hex 8
600064	7/8	3/4	1/2	Hex 8
600066	1			Hex 8
600068	1-1/8	1	3/4	Hex 8
600070	1-1/4			Hex 10
600072	1-3/8			Hex 10
600074	1-1/2	1-1/4		Hex 10
600076	1-5/8			Hex 10
600078	1-3/4	1-1/2	1-1/4	Hex 10
600080	1-7/8			Hex 10
600081	2			Hex 10
600083	2-1/8			Hex 10
600084	2-1/4	2		Hex 10
600086	2-3/8			Hex 10
600087	2-1/2		2	Hex 10
600089	2-5/8			Hex 10
600091	2-3/4	2-1/2		Hex 10
600093	3			Hex 10
600095	3-1/4		2-1/2	Hex 10
600097	3-1/2	3		Hex 10
600098	3-5/8			Hex 10
600101	4		3	Hex 10
600102	4-1/8			Hex 10
600103	4-1/4		3-1/2	Hex 10
600105	4-1/2	4		Hex 10
600107	5	4-1/2	4	Hex 10
600111	6			Hex 10
600113	6-5/8			Hex 10

**SPYDER GROUT-OUT™**

(PAGE 6)

Item Number	Blade Width (in.)	Pack Quantity	Use on Joints
100227	1/16	1	1/16" - 3/16"
100231	3/16	1	3/16" - 3/4"
100234	Grout-Out Kit	2 (1 each 1/8" and 3/16")	1/16" - 3/4"

**SPYDER HOLE SAWS:  
PRO TCT WITH RAPID CORE EJECT**

(PAGE 10-13)

Item Number	Diam. (in.)	Pipe Tap (in.)	Pipe Entrance (in.)	Use Arbor
600002	3/4	1/2	3/8	Hex 8
600005	7/8	3/4	1/2	Hex 8
600007	1			Hex 8
600009	1-1/8	1	3/4	Hex 8
600011	1-1/4			Hex 10
600013	1-3/8			Hex 10
600015	1-1/2	1-1/4		Hex 10
600017	1-5/8			Hex 10
600019	1-3/4	1-1/2	1-1/4	Hex 10
600021	1-7/8			Hex 10
600022	2			Hex 10
600024	2-1/8			Hex 10
600025	2-1/4	2		Hex 10
600027	2-3/8			Hex 10
600028	2-1/2		2	Hex 10
600029	2-9/16			Hex 10
600030	2-5/8	2-1/2		Hex 10
600032	2-3/4			Hex 10
600034	3		2-1/2	Hex 10
600036	3-1/4	3		Hex 10
600038	3-1/2			Hex 10
600039	3-5/8		3	Hex 10
600042	4			Hex 10
600043	4-1/8		3-1/2	Hex 10
600044	4-1/4	4		Hex 10
600046	4-1/2	4-1/2	4	Hex 10
600048	5			Hex 10
600052	6			Hex 10
600054	6-5/8			Hex 10

**SPYDER HOLE SAWS:  
PRO TCT WITH RAPID SWITCH AND RAPID CORE EJECT** (PAGE 10-13)

Item Number	Diam. (in.)	Pipe Tap (in.)	Pipe Entrance (in.)	Use Arbor
600232	3/4	1/2	3/8	Hex 8
600235	7/8	3/4	1/2	Hex 8
600237	1			Hex 8
600239	1-1/8	1	3/4	Hex 8
600241	1-1/4			Hex 8
600243	1-3/8			Hex 8
600245	1-1/2	1-1/4		Hex 10
600247	1-5/8			Hex 10
600249	1-3/4	1-1/2	1-1/4	Hex 10
600251	1-7/8			Hex 10
600252	2			Hex 10
600254	2-1/8			Hex 10
600255	2-1/4	2		Hex 10
600257	2-3/8			Hex 10
600674	2-1/2		2	Hex 10
600258	2-9/16			Hex 10
600259	2-5/8	2-1/2		Hex 10
600261	2-3/4			Hex 10
600263	3		2-1/2	Hex 10
600265	3-1/4	3		Hex 10
600267	3-1/2			Hex 10
600268	3-5/8		3	Hex 10
600271	4			Hex 10
600272	4-1/8		3-1/2	Hex 10
600273	4-1/4	4		Hex 10
600275	4-1/2	4-1/2	4	Hex 10
600277	5			Hex 10
600281	6			Hex 10
600283	6-5/8			Hex 10

**SPYDER SANDER** (PAGE 9)

Item Number	Description	Applications
500010	Spyder Sander with 3-piece Corner Sandpaper Set	Quickly and easily sands tight spaces, curved surfaces and hard-to-reach corners

**SPYDER HOLE SAWS:  
BI-METAL (HSS) WITH RAPID SWITCH  
AND RAPID CORE EJECT** (PAGE 10-13)

Item Number	Diam. (in.)	Pipe Tap (in.)	Pipe Entrance (in.)	Use Arbor
600289	3/4	1/2	3/8	Hex 8
600292	7/8	3/4	1/2	Hex 8
600294	1			Hex 8
600296	1-1/8	1	3/4	Hex 8
600298	1-1/4			Hex 8
600300	1-3/8			Hex 8
600302	1-1/2	1-1/4		Hex 10
600304	1-5/8			Hex 10
600306	1-3/4	1-1/2	1-1/4	Hex 10
600308	1-7/8			Hex 10
600309	2			Hex 10
600311	2-1/8			Hex 10
600312	2-1/4	2		Hex 10
600314	2-3/8			Hex 10
600315	2-1/2		2	Hex 10
600317	2-5/8			Hex 10
600319	2-3/4	2-1/2		Hex 10
600321	3			Hex 10
600323	3-1/4		2-1/2	Hex 10
600325	3-1/2	3		Hex 10
600326	3-5/8			Hex 10
600329	4		3	Hex 10
600330	4-1/8			Hex 10
600331	4-1/4		3-1/2	Hex 10
600333	4-1/2	4		Hex 10
600335	5	4-1/2	4	Hex 10
600339	6			Hex 10
600341	6-5/8			Hex 10

**SPYDER HOLE SAW ARBORS AND PILOT DRILL BITS** (PAGE 11)

Item Number	Description	Size
600634	Rapid Core Eject Arbor Complete HSS Drill	Hex 10-18UNF
600635	Rapid Core Eject Arbor Complete TCT Drill	Hex 10-18UNF
600637	Rapid Core Eject Arbor Complete HSS Drill	Hex 8-20UNF
600638	Rapid Core Eject Arbor Complete TCT Drill	Hex 8-20UNF
600645	Pilot Drill HSS – Hex 10	Hex 10
600646	Pilot Drill TCT – Hex 10	Hex 10
600648	Pilot Drill HSS – Hex 8	Hex 8
600649	Pilot Drill TCT – Hex 8	Hex 8

## SPYDER DOUBLE-SIDED OSCILLATING TOOL ATTACHMENTS

(PAGE 14-19)

Item Number	Description	Material	Cutting Width/Depth (in.)	Applications
700000	Universal Blade – Offset/Short	HSS	1-3/4 (45 mm) x 1-3/8 (35 mm)	Use at any speed on wood, wood with nails, drywall, plastic, non-ferrous metals and fiberglass
700001	Universal Blade – Offset/Medium	HSS	1-3/8 (35 mm) x 1-7/8 (48 mm)	Use at medium/high speed on wood, wood with nails, drywall, plastic, non-ferrous metals and fiberglass
700002	Universal Blade – Offset/Wide Duo	HSS	2-1/2 (65 mm) x 1-3/8 (35 mm)	Dual-use flat and radiused blades for wood, wood with nails, drywall, plastic, non-ferrous metals and fiberglass
710000	Japanese Blade – Offset/Short	HCS	1-3/4 (45 mm) x 1-3/8 (35 mm)	Close tolerance, fast cutting of wood, drywall and plastics
720000	Scraper – Offset/Rigid	SS	1-3/4 (45 mm) x 1-3/8 (35 mm)	Hard materials including vinyl flooring, carpeting, adhesives, caulking and peeling paint
720001	Scraper – Flexible	SS	1-3/4 (45 mm) x 2-1/4 (58 mm)	Best for soft materials: silicone joints, soft compounds and stickers
730000	Grout Blade – Flat Carbide	Carbide Grit	2-1/2 (65 mm) x 3-1/2 (90 mm)	Grout, mortar, brick, plaster, drywall, tiles, fiberglass and cement board
740000	Rasp – Nonagon Carbide	Carbide Grit	3-1/8 (80 mm) x 3-1/8 (80 mm)	Best for grinding, sanding and removal of cement, wood, paint, thinset, mortar, tile adhesives, natural and artificial stone, plaster and concrete over large surface areas
750000	Nonagonal Sanding Pad w/10 Sheets Various Grit Sandpaper	Silicon Carbide	3-1/8 (80 mm) x 3-1/8 (80 mm)	Hook-and-loop quick-change pad, best used for large surface areas
750001	Assorted Nonagonal Sandpaper – 20 Sheets Various Grit	Silicon Carbide	3-1/8 (80 mm) x 3-1/8 (80 mm)	Use wet or dry on wood, hard metals, soft metals, plastics and fiberglass

## SPYDER DOUBLE-SIDED JIG SAW BLADES

(PAGE 20)

Item Number	Attachment Type	TPI	Length (in.)	Material	Thickness (in.)	Blades per pack	Applications
300002	T-Shank	Variable	4.5	CV Steel	0.057	2	Hard and soft wood
300004	T-Shank	10	4	CV Steel	0.042	2	Wood fiberboard and synthetic materials
300009	T-Shank	Variable	4-4.5	CV Steel	0.042 – 0.057	2	Hard wood, soft wood, wood fiberboard and synthetic materials
300013	U-Shank	Variable	4.5	CV Steel	0.057	2	Hard and soft wood
300014	U-Shank	10	4	CV Steel	0.042	2	Wood fiberboard and synthetic materials
300015	U-Shank	Variable	4-4.5	CV Steel	0.042-0.057	2	Hard wood, soft wood, wood fiberboard and synthetic materials

## SPYDER SKELETON™ JIG SAW BLADES

(PAGE 21)

Item Number	Attachment Type	TPI	Length (in.)	Material	Thickness (in.)	Blades per pack	Applications
300012	T-Shank	10	4	CV Steel	0.057	2	Laminated wood fiberboard and synthetics
300022	T-Shank	12	4	CV Steel	0.057	2	Hard and soft woods, coated fiberboard and synthetics
300020	T-Shank	Variable	4	CV Steel	0.057	2	Wood fiberboard and synthetics
300016	U-Shank	10	4	CV Steel	0.057	2	Laminated wood fiberboard and synthetics
300021	U-Shank	12	4	CV Steel	0.057	2	Hard and soft woods, coated fiberboard and synthetics
300019	U-Shank	Variable	4	CV Steel	0.057	2	Wood fiberboard and synthetics

## SPYDER DOUBLE-SIDED AND SKELETON™ JIG SAW BLADE MULTI-PACK

(PAGE 20-21)

Item Number	Attachment Type	TPI	Length (in.)	Material	Thickness (in.)	Blades per pack	Applications
300037	T-Shank	Variable	4-4.5	CV Steel	0.042 – 0.057	8	Hard wood, soft wood, coated fiberboard and synthetic materials

## SPYDER BORE-BLADE™

(PAGE 22)

Item Number 1/Pack	Item Number 3/Pack	Item Number 25/Pack	Item Number 50/Pack	Item Number 100/Pack	TPI	Length (in.)	Material (both sides)	Blade width (in.)	Thickness (in.)	Applications
200001	200002	200120	200140	200150	7x7	6	Bi-Metal	1	1/20	Wood, nails, wood products, demolition, some synthetics
200007	200008	200123	200143	200153	7x7	8	Bi-Metal	1	1/20	Wood, nails, wood products, demolition, some synthetics
200013	200014	200126	200146	200156	7x7	10	Bi-Metal	1	1/20	Wood, nails, wood products and embedded nails
200003	200004	200121	200141	200151	7x10	6	Bi-Metal	1	1/20	Wood, nails, wood products and embedded nails
200009	200010	200124	200144	200154	7x10	8	Bi-Metal	1	1/20	Multi-products and metals
200015	200016	200127	200147	200157	7x10	10	Bi-Metal	1	1/20	Multi-products and metals
200005	200006	200122	200142	200152	10x14	6	Bi-Metal	1	1/20	Wood, nails, wood products, demolition and some synthetics
200011	200012	200125	200145	200155	10x14	8	Bi-Metal	1	1/20	Wood, nails, wood products, demolition, some synthetics
200017	200018	200128	200148	200158	10x14	10	Bi-Metal	1	1/20	Wood, wood products, demolition, some synthetics

## SPYDER BORE-BLADE™ MULTI-PACK

(PAGE 22)

Item Number	TPI	Length (in.)	Material (both sides)	Blade width (in.)	Thickness (in.)	Applications
200095	10x14 7x10 7x7	6 8 10	Bi-Metal Bi-Metal Bi-Metal	1 1 1	1/20 1/20 1/20	Wood, nails, wood products, demolition, embedded nails, some synthetics, multi-products and metals

## SPYDER BRUSHES

(PAGE 9)

Item Number	Description	Quantity	Length (in.)	Applications
400002	Wire Brush	1	4.5	Concrete, metal, stone and wood surface cleaning
400004	Nylon Brush	1	4.5	Grout, carpet, tile, laminate, rubber, concrete, brick and other surface prep

## SPYDER TOOL KITS

(PAGE 28)

Item Number	Description	Items Included
900404	Remodeling Kit	8 pieces: 1/16" Spyder Grout-Out, 6" 10/14 TPI Spyder Bore-Blade, 4.5" Spyder Wire Brush, 2" Spyder Scraper, Spyder Corner Sanding Pad, 3-piece corner sandpaper set
300037	Jig Saw Variety Pack	8 pieces: 2 x 8-11.5 TPI double-sided jig saw blades, 2 x 10 TPI double-sided jig saw blades, 2 x 10 TPI Skeleton blades, 2 x 12 TPI Skeleton blades
100234	Grout-Out Kit	2 pieces: 1/16" Spyder Grout-Out, 3/16" Spyder Grout-Out
900309	Starter Kit	3 pieces: 1/16" Spyder Grout-Out, 2" Spyder Scraper, 6" Spyder Bore-Blade



# SPYDER TOOL KITS

From starter kits that give users a taste of what the Spyder brand is all about to complete remodeling kits that help make quick work of tough projects, Spyder tool kits are a convenient and money-saving way for customers to sample Spyder innovation.



REMODELING KIT 900404



JIG SAW VARIETY PACK 300037



GROUT-OUT KIT 100234



STARTER KIT 900309





TOOLS YOU'LL LOVE FOR THE JOBS YOU DON'T



Call us at 1-888-471-2239  
Email us at [info@spyderproducts.com](mailto:info@spyderproducts.com)

Retailers in Canada, please contact us by  
phone (877-932-6579) or email ([gmsmanagement@sympatico.ca](mailto:gmsmanagement@sympatico.ca)).

©2013 SM Products, LLC. Spyder, the Spyder logo, Spyder Bore-Blade, Spyder Grout-Out, Spyder Skeleton, Rapid Core Eject and Rapid Switch are trademarks and Spyder Scraper is a registered trademark of SM Products, LLC. All rights reserved. Mouse® denotes a registered trademark of Stanley Black & Decker, Inc., in the United States and elsewhere. Spyder Scraper, Spyder Bore-Blade, Spyder Wire Brush, Spyder Corner Sanding Pad and Spyder Oscillating Tools patents pending. The Spyder Hole Saw Arbor System is patented in the US and Canada, patent nos. 7,934,893 and 2,589,999, respectively.