



PLUMBING & HEATING INDEX

A

ABRASIVE
CLOTH C64

ACCESSORIES
WATER FILTER C140

ACID
TABLETS C142

ACTUATING UNIT C130

ADAPTER C18
DISHWASHER C115
EXTENSION C50
FEMALE C48, C66
HOSE C80
MALE C48, C66, C83
NYLON C83
REDUCING GENOGRIP C43
STOP, ICE MAKER C115

ADAPTERS
AERATOR C101
DISHWASHER C100
FEMALE C48
MALE C48
PEX C44
SCH 40 PVC-DWV C36
SCHEDULE 40 C36
UNIVERSAL C44

ADJUSTABLE THERMOSTAT C26

AERATOR
ADAPTERS C101
DISHWASHER C100
GAUGE C101
REPAIR C101
WASHERS C101

AERATORS C100, C101

AEROSOL
CEMENT C31
CLEANER C31
PRIMER C31

AEROSOL PRIMER C31

AIR FILTER C8

AIR VOLUME CONTROL C142

ALUMINUM
ELBOW C16

ALUMINUM PIPE C16

APPLIANCE
GAS CONNECTOR C28

ARM
SHOWER C91

ASH SHOVEL C20

AUGERS C137

B

BALL
RODS C120

BALLCOCK C126
COUPLING NUTS C127
REPAIR PARTS C126, C127
SHANK NUTS C127

BALL VALVE C88
STAINLESS STEEL C88

BARB, HOSE C80

BASIN
FAUCET C95
HANGER C119
WRENCH C136

BASKET
SINK STRAINERS C118
STRAINERS C117, C118

BATH
DRAIN C94
DRAIN REPAIR C94
WASTE C94

BELL TRAP
SCH 40 PVC-DWV C37

BIB SEAT
WRENCH C136

BLAZING FITTINGS C50

BOILER DRAIN C86

BOLT CAPS
TOILET C135

BOLTS
TOILET SEAT HINGE C134

BOLT WASHERS
TANK C133

BONNET PACKING C103

BOTTOM SEALS
FAUCET C105

BRASS
CAST TEE C123
CENTER OUTLET WASTE C123
END OUTLET WASTE C123
EXTENSION TUBE C123
J BEND C123
SLIP-JOINT COUPLING C123
TAILPIECE C123
TUBE SUPPORTS C77
WASTE SHOE C94

BRASS TUBULAR C123
NUTS C122
WASHERS C122

BRUSH
4 IN 1 C64
CHIMNEY C19
COPPER TUBE CLEANING C64
FITTING C64
PELLET STOVE C19
STOVE C19

BUMPER
TOILET SEAT C134

BUSHING C111

BUSHINGS
SCH 40 PVC-DWV C33

BUTANE LIGHTER
REFILLABLE C23

C

CABLE
CLIPS, GUTTER C30
PIPE HEAT C29
ROOF & GUTTER C30

CANOPY
FLANGE C115

CAP C66
COMPRESSION C72
DRIVE C141
FLARE C68
FLARE SEAL C68
GALVANIZED C12
RAIN C11
THREAD C103
WITH CRIMP C13

CAPS
PIPE C56
SCH 40 PVC-DWV C33

CAST DAMPER C14

CAST TEE
BRASS C123

CEILING COVER PLATES C115

CEMENT
CPVC, PVC C31
FURNACE C9

CENTER OUTLET TEE
PLASTIC C124

CENTER OUTLET WASTE
BRASS C123

CHAIN
BEADED C121

CHECK VALVE
BRASS C89
PVC C89
SUMP PUMP C143

CHIMNEY
BRUSH C19
BRUSH RODS C18
CLEANER C24

CHIMNEY BRUSH
RECTANGLE WIRE C19
ROUND POLY C19
ROUND WIRE C19

CLAMP
1-EAR C47
HOSE C47
WORM GEAR C47

CLEANER
AEROSOL C31
CHIMNEY C24
CPVC, PVC C31
DRAIN C139
TOILET C139

CLIPS
ROOF & GUTTER CABLE C30

CLOSET
SCREWS C133

CLOSET FLANGE
SCH 40 PVC-DWV C37
SPACER C37

CLOTH
ABRASIVE C64

COLLAR
STORM C11

COMPRESSION
BRASS FITTINGS
C72, C73, C74, C75
NUT C72, C116
SLEEVES C72, C77, C116
TEE C72



PLUMBING & HEATING INDEX

CONERINGS C116
WASHERS C116**CONNECTOR C74**COMPRESSION C74
GAS APPLIANCE C69
GAS APPLIANCE C28
WASHING MACHINE C138
WATER C112, C113
WATER HEATER C28**CONNECTORS**

NUT C68

CONTINUOUS WASTE

PLASTIC C124

COPPER PIPE

TYPE M C65

COPPER TUBING C66**COUPLING**BATHTUB C93
COMPRESSION C74
COPPER C65
DRIVE C141
FEMALE C69, C74
FLEX C38
MERCHANT C57
NYLON C80
PEX C44
PIPE, COMPRESSION C38
PLASTIC C124
REDUCING C48, C57, C65
SCH 40 PVC-DWV C33**COVER PLATES**

FLOOR & CEILING C115

CPVCELBOWS C43
WING ELBOW C42**CPVC CEMENT C31****CPVC CLEANER C31****CPVC PIPE C42**BUSHING C42
CAP C42
COUPLING C42
ELBOWS C43
FEMALE ADAPTER C42
MALE ADAPTER C42
REDUCING COUPLING C42
TEES C42, C43
UNIONS C43
WING ELBOW C42**CPVC PRIMER C31****CPVC TEES C42****CPVC UNIONS C43****CPVC WING ELBOW C42****CREOSOTE REMOVER C24****CRIMP RINGS**

PEX COPPER C44

CROSS MALLEABLE C58**CTS J-HOOK C63****CUP**

LEATHER C142

CURTAIN HOOKS

SHOWER C92

CUTOFF RISER C50**CUTTER**

PIPE C46

D**DAMPER**

STOVE PIPE C14

DIELECTRIC UNIONS C61**DISCHARGE HOSE**

WASHING MACHINE C138

DISCHARGE KIT

PUMP C143

DISCONNECT TOOL C67**DISHWASHER**ADAPTER C100, C115
AERATOR C100
AIR GAP C125
CONNECTION FITTING C115
CONNECTOR C121
FITTING C115
TAILPIECE C124**DISPENSER**

SOAP C96

DISPOSALCONNECTOR C121
GENIE C121**DRAIN**BATH C94
BATH STOPPERS C94
BOILER C86
CLEANER/OPENER C139
GASKET C119
REPAIR, BATH C94
SHOWER C93
STOPPER C119
STRAINER C117
TAPE C137
TUB C93**DRAIN KING C136****DRAIN TAILPIECE**WASHER C122
WASHERS C122**DRAIN TAPE C137****DRAW BAND**

GALVANIZED C11

DRILL PUMP C144**DRIVE CAP C141****DRIVE COUPLING C141****DRUM TRAP COVER C38****DRYER**

VENT CLAMP C16

DUCTCLAMP C16
VENT C17
VENT HOOD C17**DWV J-HOOK C63****E****ELBOW C49, C66, C71, C75**ALUMINUM C16
BLACK ADJUSTABLE C13
BLACK CORRUGATED C13
COMBINATION C49
COMPRESSION C75COPPER C65
FLARE C70, C71
MALLEABLE C58, C59
NYLON C82
PEX C44
REDUCING C49**ELBOWS**

SCH 40 PVC-DWV C34

ELEMENTS

WATER HEATER C27

EMERGENCY REPAIR TAPE C62**END OUTLET TEE**

PLASTIC C124

END OUTLET WASTEBRASS C123
PLASTIC C124**EVAPORATOR PLATES**

HUMIDIFIER C9

EXTENSION ADAPTER C50**EXTENSION ROD**

FIBERGLASS C18

EXTENSION TUBEBRASS C123
PLASTIC C124**F****FAUCET**BASIN C95
BOTTOM SEALS C105
GREASE C62
HANDLE BUSHING C111
HANDLE FLANGES C111
HANDLE REMOVER C136
HANDLES C109, C110
HANDLE SCREWS C111
HOLE COVER C96
LOCKNUT C116
"O" RINGS C103
REPAIR C98
REPAIR KITS C105
RESEATING TOOL C136
SCREWS C102, C103
STEM REPAIR C105
STEM REPAIR KITS C105
STEMS C106, C107
SUPPLY TUBE NUTS C116
WASHERS C102**FAUCET REPAIR C98**BRADLEY-COLE C98
DELTA C97
DELTA / PEERLESS C97
MOEN C98
PRICE PFISTER C98
STERLING C99
VALLEY C99**FAUCETS**KITCHEN C95
LAVATORY C95
SHOWER C90
TUB C93**FAUCET & VALVE**

GREASE C62

FEMALE ADAPTER C48



PLUMBING & HEATING INDEX

FEMALE COUPLING C69**FIBERGLASS**

INSULATION C29

FILTER

FUEL OIL C20

MEDIA C9

WATER C140

FILTER MATERIAL

POLY SNIP TO FIT C9

FILTER MEDIA C9**FILTERS**

AIR C8

FURNACE C8

FIRE

BRICK C18

STARTERS C24

SUPPRESSANT C25

FIREPLACE MATCHES C18**FIRE STARTER**

GEL C24

SAFE-LITE C24

FIRE SUPPRESSANT C25**FITTING**

DISHWASHER C115

FITTING BRUSH C64**FITTING CLEANOUT**

SCHEDULE 40 C36

FITTINGS C50

BLAZING C50

INSERT C48, C49, C50

PROBITE C67

SWING PIPE C50

WATER SUPPLY C116

FLAME STICKS C24**FLANGE**

CANOPY C115

FLOOR C60

POP-TOP CLOSET C37

SHOWER C91

SPACER C37

FLANGES C115

HANDLE C111

TOILET C132

FLAPPERS

CHAIN C129

TOILET C129

FLARE

BRASS FITTINGS

C68, C69, C70, C71

FLARE NUT C68**FLARE SEAL**

CAP C68

FLARE TEE C69**FLASHING**

ROOF C15

FLOAT

KIT C145

ROD C127

TANK C127

FLO INTAKE SCREEN C141

REPLACEMENT C141

FLOOR COVER PLATES C115**FLOOR FLANGE C60****FLOOR STRAINER**

SCH 40 PVC-DWV C37

FLUE STOP C14**FLUSH LEVERS C128****FLUSH VALVE**

REPAIR C130

FLUSH VALVES C126**FOOT VALVE C89****FUEL**

OIL FILTER C20

FURNACE

CEMENT C9

FILTERS C8, C9

G**GARBAGE DISPOSAL**

GASKET C121

SPLASH GUARD C121

STOPPER C121

GAS

CONNECTOR C28

GAS APPLIANCE

CONNECTOR C69

GAS APPLIANCE

INSTALLATION KIT C28

GAS BALL VALVES C85**GAS CONNECTOR**

APPLIANCE C28

GASKET

BASIN MACK C119

BATH SHOE C94

CAP THREAD C103

TANK-TO-BOWL C132

GASKET KIT

GRAPHO-GLAS C25

GAS VALVE

BALL VALVE C85

FLARE X FLARE C85

GATE VALVE C84**GAUGE**

AERATOR C101

GEL FIRE STARTER C24**GREASE**

FAUCET & VALVE C62

GUARDS

SHOWER C92

GUIDE ARMS C130**GUTTER**

& ROOF CABLE C30

GUTTER CABLE

CLIPS C30

H**HAIR SNARE C117****HALF UNION C70****HANDLE**

BUSHING C111

FLANGES C111

REMOVER C136

SCREWS C111

SILLCOCK C87

WHEEL C87

HANDLES

FAUCET C109, C110

OEM C109

READY FIT C110

HANGER

BASIN C119

PIPE C63

SINK C119

STRAP C63

HEADS

KITCHEN FAUCETS C96

KITCHEN SPRAYER C96

HEAT CABLE

PIPE C29

HEATER

REPLACEMENT WICK C22

HINGE

TOILET SEAT C134

HINGE BOLTS

TOILET SEAT C134

HOOD

VENT C17

HOOK C63**HOOKS**

SHOWER CURTAIN C92

HOSE C79

ADAPTERS C80

BARB C80

BIBB C86

CLAMP C47

FILTER WASHER C138

KITCHEN SPRAYERS C96

PVC C79

RUBBER C79

WASHER, RUBBER C138

WASHING MACHINE C138

HUMIDIFIER

EVAPORATOR PLATES C9

HYDRANT

YARD C85

I**ICE MAKER**

INSTALLATION KIT C115

STOP ADAPTER C115

VALVES C115

IGNITER C23

KEROSENE HEATER C23

IMPELLER C145**INSERT FITTINGS****C48, C49, C50****INSTA-FIRE CHARCOAL C25****INSTALLATION KITS**

GAS APPLIANCE C28

INSTALLATION TOOL C47**INSULATION**

FIBERGLASS C29

PIPE C29

INTAKE SCREEN C141**IRON OUT C139****J****J BEND**

BRASS C123

PLASTIC C124



PLUMBING & HEATING INDEX

J-HOOK C63

CTS C63

DWV C63

JOINT COMPOUND

PIPE C62

K**KEROSENE**

ADDITIVE C23

HEATER IGNITER C23

SYPHON C23

WICK C22

KEY

SILLCOCK C87

KITCHEN

FAUCET C95

SPRAY HOSE GUIDE C96

L**LAMP OIL C22****LAVATORY**

FAUCETS C95

LEATHER CUP C142**LEVERS**

FLUSH C128

LIFT

WIRES C130

LIGHTER BUTANE C23**LINES**

SUPPLY C112

LINT TRAP C138**LOWER VALVE C142****M****MAGICAL FLAMES DISPLAY C25****MALE ADAPTER C48****MALE ADAPTERS C48****MALLEABLE**

BUSHING C56

CROSS C58

ELBOW C58, C59

PIPE CAPS C56

REDUCING TEE C61

MATCHES

FIREPLACE C18

MEDIA

FILTER C9

MERCHANT COUPLING C57**MINI SNAKE C139****N****NIPPLE C55**

PIPE C52, C53, C54

PVC C55

NUT

BRASS TUBULAR C122

COMPRESSION C72, C116

CONNECTORS C68

FLARE C68

PLASTIC TUBULAR C122

SHORT FLARE C68

NYLON COUPLINGS C80**NYLON ELBOW C82****NYLON PLUG C82****NYLON TEE C81****O****OEM HANDLES C109****OIL**

LAMP C22

OIL FILTER

MASTER C20

REPLACEMENT C20

STANDARD C20

"O" RING C104**"O" RING**

PICK C105

"O" RINGS

FAUCET C103

OVAL REDUCER

BLACK C13

OVERFLOW

BATH & WASTE C94

OVERFLOW PLATE C94**P****PACKING**

BONNET C103

SHEETS C64

STEM C103

PEDESTAL SUMP PUMP C143**PELLET STOVE**

BRUSH C19

PELLET STOVE BRUSH C19**PERFECT SEAL C131****PET SPA C90****PEX BARBED VALVES C46****PEX COPPER**

CRIMP RINGS C44

PEX COPPER STUB-OUT C44**PEX CRIMP FITTINGS C45****PEX PIPE**

ADAPTERS C44

COUPLING C44

ELBOW C44

TEE C44

PEX TUBING

HOT C44

PEX TUBING HOT C44**PIPE**

ADAPTERS PVC C40, C41

ADAPTERS, SCH 40 DWV C36

ALUMINUM C16

BELL TRAP, SCH 40 DWV C37

BUSHING CPVC C42

BUSHINGS PVC C40

BUSHINGS, SCH 40 DWV C33

CAP CPVC C42, C43

CAP PVC C39, C40

CAPS C56

CAPS, SCH 40 DWV C33

CLOSET FLANGE, SCH 40 DWV

C37

COPPER C65

COUPLING, COMPRESSION C38

COUPLING CPVC C42

COUPLING, PVC C39

COUPLINGS, SCH 40 DWV C33

COUPLING, THREADED C39

CPVC C42

CUTTER C46

ELBOW C10

ELBOWS CPVC C43

ELBOWS, SCH 40 DWV C34

FEMALE ADAPTER CPVC C42

FITTINGS C13

FITTINGS, ALUMINUM C16

FLOOR STRAINER C37

HANGER C63

HEAT CABLE C29

INSULATION C29

JOINT COMPOUND C62

MALE ADAPTER CPVC C42

PLASTIC, FLEXIBLE C46

PLUG C60

PLUG PVC C40

PRESSURE PVC C39

P-TRAP, SCH 40 DWV C36

REDUCING COUPLING CPVC C42

SCHEDULE 30, PVC-DWV C32

SCHEDULE 40, PRESSURE C39

SCHEDULE 40, PVC-DWV C33

SEWER & DRAIN, PVC C32

STEEL C51

STOVE C10, C12

STRAPS C44, C63

STRAPS, STEEL C63

SWING C50

TEE C10

TEE, SCH 40 DWV C35

TEES CPVC C42, C43

TEES PVC C41

U-BENDS, SCH 40 DWV C36

UNION PVC C41

UNIONS CPVC C43

WING ELBOW, CPVC C42

WYE, SCH 40 DWV C35

PIPE BUSHINGS C40**PIPE CAPS**

MALLEABLE C56

PIPE COUPLING C39

CAST IRON C38

PLASTIC C38

PIPE CUTTER C46**PIPE FITTINGS**

COPPER C65, C66

CPVC C42

INSERT C48

PEX C45

PVC C32, C55

SCHEDULE 30, PVC-DWV C32

SCHEDULE 40 PRESSURE C39

SCHEDULE 40 PVC-DWV C33

SEWER & DRAIN, PVC C32

STEEL C52, C53, C54, C56, C

57, C58, C59, C60, C61



PLUMBING & HEATING INDEX

UNIVERSAL C44
PIPE HANGER
COPPER C63
PIPE HEAT CABLE C29
PIPE INSULATION C29
SNAP-ON C29
PIPE NIPPLE C52, C53, C54
PIPE PLUG C40, C60
PIPE STRAPS
COPPER TWO HOLE C63
PIPE TEE
STOVE C13
PIPE THREAD TAPE C62
PITCHER SPOUT PUMP C141
PLASTIC
90° ELBOW C124
CENTER OUTLET TEE C124
CONTINUOUS WASTE C124
COUPLING C124
DISHWASHER AIR GAP C125
DISHWASHER TAILPIECE C124
END OUTLET TEE C124
END OUTLET WASTE C124
EXTENSION TUBE C124
J BEND C124
P TRAP C124
SLIP JOINT COUPLING C124
S TRAP C124
TAILPIECE C124, C125
TEE C124
TRAP ADAPTER C124
TRAP VENT C125
WALL BEND C125
WALL TUBE C125
WASTE ARM C124
PLASTIC PIPE
FLEXIBLE C46
PLASTIC PIPE COUPLING C38
PLASTIC TUBULAR C124, C125
NUTS C122
WASHERS C122
PLATE
OVERFLOW C94
PLATES
FLOOR & CEILING C115
PLUG C49
NYLON C82
PIPE C60
PLUGS
TEST C38
PLUMBER'S PUTTY C62
PLUNGER C137
POLY SNIP TO FIT
FILTER MATERIAL C9
P.O. PLUGS C120
POP-UP ASSEMBLY C120
POP-UP STOPPERS C119
PRESSURE
GAUGES C142
SWITCH C142
PRESSURE PIPE
ADAPTERS SCH 40 C40, C41
BUSHINGS SCH 40 C40
CAP SCH 40 C39, C40

COUPLING SCH 40 C39
ELBOWS C41
PLUG SCH 40 C40
PVC SCH 40 C39
TEES SCH 40 C41
THREADED COUPLING C39
UNION SCH 40 C41
PRESSURE PIPE CAP
PVC C39
PRIMER
AEROSOL C31
CPVC, PVC C31
P-TRAPS
PLASTIC C124
SCH 40 PVC-DWV C36
PULL RING C18
PULL ROD C120
PUMP
DISCHARGE KIT C143
DRILL C144
LAWN SPRINKLING C144
PITCHER SPOUT C141
SEWER EJECTOR C144
SHALLOW WELL C144
SUMP C143
SUMP, CHECK VALVE C143
SWITCH C145
UTILITY C143
PUTTY
PLUMBER'S C62
PVC CEMENT C31
PVC CLEANER C31
PVC HOSE C79
PVC PRESSURE PIPE
BUSHINGS C40
PLUG C40
PVC PRIMER C31

R

RAIN CAP C11
READY FIT HANDLES C110
REDUCER C16
OVAL C13
REDUCING COUPLING C57
REDUCING COUPLING C48
REDUCING ELBOW C49
REDUCING SANITARY TEST TEE
SCHEDULE 40 C35
REDUCING TEE C49
MALLEABLE C61
RELIEF VALVE C89
REMOVER
HANDLE C136
LIQUID CREOSOTE C24
REPAIR
AERATOR C101
FAUCET C98
GLACIER BAY C98
KOHLER C98
MILWAUKEE FAUCET C98
MOEN FAUCET C98
PRICE PFISTER FAUCET C98
STERLING FAUCET C99
VALLEY FAUCET C99

REPLACEMENT CAP
STOP & WASTE VALVE C87
REPLACEMENT THERMOSTAT
C27
RESEATING TOOL
FAUCET C136
RINGS
BOWL WAX C131
CONE C116
RISER
CUTOFF C50
ROD
EXTENSION C18
FLOAT C127
ROD KIT
FIBERGLASS C18
RODS
BALL C120
CHIMNEY BRUSH C18
FLOAT C127
SHOWER C91
ROOF
CABLE C30
FLASHING C15
ROOF FLASHING
THERMOPLASTIC C15
ROOF & GUTTER
CABLE C30
ROOT KILLER C139
ROUND REDUCER
BLACK C13
RUBBER HOSE C79

S

SANITARY TEE
SCHEDULE 40 C35
SCHEDULE 30
PIPE & FITTINGS C32
SCHEDULE 30 PVC C32
SCHEDULE 40 C33, C34
ADAPTERS C36
BUSHINGS C33
CAPS C33
COUPLINGS C33
FITTING CLEANOUT C36
POP-TOP CLOSET FLANGE C37
P-TRAPS C36
REDUCING SANITARY TEE C35
REDUCING SANITARY TEST TEE C35
REDUCING WYE C35
SANITARY TEE C35
THREADED PLUG C36
VINYL BELL TRAP C37
VINYL HUB FIT FLOOR STRAIN-
ER C37
WYE C35
SCREENS C101
SCREWS
BUSHING C111
CLOSET C133
FAUCET C102
HANDLE C111



PLUMBING & HEATING INDEX

- SEAL CAP**
FLARE C68
- SEALS**
BOTTOM, FAUCET C105
- SEATS**
TOILET C134
- SEPTIC TANK TREATMENT C139**
- SEWAGE EJECTOR PUMP C144**
- SEWER & DRAIN PIPE C32**
- SHALLOW WELL PUMP C144**
- SHANK NUTS**
BALLCOCK C127
- SHEETS**
PACKING C64
- SHOE GASKET**
BATH C94
- SHORT FLARE**
NUT C68
- SHOVEL, ASH C20**
- SHOWER**
ARMS C91
BLASTER C90
CURTAIN HOOKS C92
DRAIN C93
FAUCETS C90
GUARDS C92
HEADS C90, C91
REPAIR C94
RODS & FLANGES C91
SHUT-OFF VALVE C90
STRAINERS C117
- SHOWER HEADS C91**
HAND HELD C90
- SHOWER REPAIR C90, C93, C94**
- SHOWER VALVE**
SOCKET WRENCHES C136
WRENCH C136
- SHUT-OFF VALVE C76**
- SILLCOCK C86**
FAUCET C86
FROST FREE C85
HANDLES C87
KEY C87
- SINK**
HANGER C119
STRAINERS C117
- SINK SPRAY**
HEADS & HOSE C96
- SLEEVE, COMPRESSION C72**
- SLEEVES**
COMPRESSION C77, C116
- SLIP-JOINT COUPLING**
BRASS C123
PLASTIC C124
- SNAKE**
MINI C139
- SNIP**
POLY C9
- SOAP**
DISPENSER C96
- SOAP DISPENSER C96**
- SOCKET WRENCHES**
SHOWER VALVE C136
- SOOT DESTROYER C24**
- SOOT STOPPER C24**
- SPRAY HEADS C96**
- SPUD**
WRENCH, ADJUSTABLE C136
- STEEL PIPE C51**
- STEM**
REPAIR KITS C105
- STEM LIGHTER**
BUTANE FLEXIBLE C23
- STEM PACKING C103**
- STEM REPAIR**
FAUCET C105
- STEMS**
FAUCET C106, C107
- STOP ADAPTER**
ICE MAKER C115
- STOPPERS C121**
BATH DRAIN C94
BEADED CHAIN C121
POP-UP C119
- STOP VALVE C86**
- STOP & WASTE VALVE C86**
- STORM COLLAR C11**
- STOVE**
BRUSH C19
POLISH C25
WILLIAMS C25
- STOVEBOARD C21**
- STOVE BRUSH**
PELLET C19
- STOVE PIPE C10, C12**
BLACK C13
COLLAR C13, C14
FITTINGS C13, C14
REDUCING BUSHING C12
TEE C13
- STOVE PIPE COLLAR**
BLACK C13
- STRAINER**
SINK C117
- STRAINERS**
BASKET C118
SHOWER C117
TUB C117
- STRAINER/STOPPER**
MICROBAN C118
- S TRAP**
PLASTIC C124
- STRAP**
HANGER C63
WRENCH C136
- STRAPS**
PIPE C63
TUBING C44, C47
- STREAM REGULATORS C101**
- SUMP PUMP C143**
PEDESTAL C143
- SUPPLY LINES C112**
- SUPPLY VALVE**
ANGLE C43
- SUPPLY VALVES C114**
- SWING PIPE C50**
FITTINGS C50
- SWITCH**
JET PUMP C145
PRESSURE C142
PUMP C145
- SWITCH KIT**
SUMP PUMP C145
TETHERED C145
- SYPHON**
BATTERY C23
MANUAL C23
- T**
- TABLETS**
ACID C142
- TAILPIECE**
BRASS C123
DISHWASHER C124
PLASTIC C124, C125
- TANK**
BALLS C130
BOLT WASHERS C133
FLOAT C127
- TANK BALLS**
TOILET C130
- TANK-TO-BOWL KIT C133**
- TAPE**
DRAIN C137
EMERGENCY REPAIR C62
PIPE THREAD C62
- TEE C49, C60**
COMBINATION C49
COMPRESSION C72
FLARE C69
NYLON C81
PEX C44
PLASTIC C124
REDUCING C49, C65
SANITARY C35
SCH 40 PVC-DWV C35
- TEES**
CPVC C42
- TEST CAP C38**
- TEST PLUGS C38**
- TEST TEE**
SANITARY C35
- THERMOSTAT**
ADJUSTABLE C26
- THERMOCOUPLE**
WATER HEATER C27
- THERMOSTAT C26, C29, C30**
PROGRAMMABLE C26
REPLACEMENT C27
WATER HEATER C27
- THERMOSTATS C26**
- THREADED PLUG**
SCHEDULE 40 C36
- TOILET**
BOLT CAPS C135
BOWL RING C131
CLOSET BOLTS C133
FLANGES C132



PLUMBING & HEATING INDEX

FLAPPERS C129
FLUSH VALVE C126
OPENER/CLEANER C139
PAPER ROLLER C135
PLUNGER C137
SEATS C134
TANK BALLS C130
TANK REPAIR PARTS C126
TOILET BOWL RINGS
PERFECT SEAL C131
TOILET & DRAIN
OPENER/CLEANER C139
TOILET FLANGE REPAIR KIT
HYDROSEAT C131
TOILET REPAIR
EZ WEDGE C132
WASHERS AND GASKETS C132
TOILET SEAT
BUMPER C134
HINGE C134
WASHERS C134
TOILET TANK
BALLS C130
FLOAT C127
REPAIR PARTS C126
TOILET WAX RINGS C131
TOOL
DISCONNECT C67
TRANSFER PUMP C143
TRAP ADAPTER
PLASTIC C124
TRAP DRAIN CONNECTORS
UNIVERSAL C38
TRAP VENT
PLASTIC C125
TRIM KIT
TUB C92
TUB
COUPLING C93
DRAIN C93
FAUCETS C93
REPAIR C94
STRAINERS C117
TRIM KIT C92
TUBE
REFILL & OVERFLOW C126
TOILET OVERFLOW C126
TUBE SUPPORTS
BRASS C77
TUBING
COPPER C66
POLYETHYLENE C78
SOFT COPPER C66
VINYL C78
TUBING STRAPS C44, C47
TUB & SHOWER
DRAIN STRAINERS C117
REPAIR C93
TRIM KIT C92
TUBULAR
BRASS C123
PLASTIC C124, C125

U**U-BENDS**

SCH 40 PVC-DWV C36

UNION C66, C68, C73

COMPRESSION C73

DIELECTRIC C61

FLARE C68

HALF C70

REDUCING C73

UNIONS C61

DIELECTRIC C61

V**VALVE**

ANGLE SUPPLY C43

CHROME C114

BALL C88

CHECK C89

FLUSH C129

FOOT C89

GAS BALL C85

GATE C84

ICE MAKER C115

LOWER C142

RELIEF C89

REPLACEMENT CAP C87

SHUT-OFF C76

STOP C86

STOP & WASTE C86

SUPPLY C114

UNIVERSAL LINE C43

VALVE GREASE C62**VALVES**

PEX BARBED C46

VENT DUCT C17**VENT HOOD C17****VINYL BELL TRAP C37****VINYL TUBING C78****W****WALL BEND**

PLASTIC C125

WALL TUBE

PLASTIC C125

WASHER

DRAIN TAILPIECE C122

FILTER, HOSE C138

RUBBER HOSE C138

WASHERS

AERATOR C101

BRASS TUBULAR C122

CONE C116

DRAIN TAILPIECE C122

FAUCET C102

FLUSH VALVE C130

PLASTIC TUBULAR C122

SLIP-JOINT C122

TOILET SEAT C134

WASHERS AND GASKETS

TOILET REPAIR C132

WASHING MACHINE

CONNECTORS C138

DISCHARGE HOSE C138

HOSE C138

WASTE

BATH C94

WASTE ARM

PLASTIC C124

WASTE SHOE

BRASS C94

WATER

CONNECTORS C112, C113

SUPPLY FITTINGS C116

WATER FILTER

HOUSING WRENCH C140

O RING C140

WATER FILTERS C140**WATER HEATER**

CONNECTORS C28

ELEMENTS C27

THERMOCOUPLE C27

THERMOSTAT C27

WAX RINGS C131**WELL POINT C141****WHEEL**

HANDLE C87

WICK, REPLACEMENT C22**WILLIAMS STOVE C25****WING ELBOW**

CPVC C42

WINTER WATCHMAN C26**WIRES**

LIFT C130

WOOD PELLET C21**WORM GEAR CLAMP C47****WRENCH**

4-IN-1 C136

ADJUSTABLE SPUD C136

BASIN C136

BIB SEAT C136

PLUMBERS 4-IN-1 C136

SHOWER VALVE C136

STRAP C136

WYE

SCH 40 PVC-DWV C35

Y**YARD HYDRANT C85**



PLUMBING & HEATING



AIR FILTERS

AMERICAN AIR FILTER

Item	Pack	Part #	HDI #
Air Filters - Made of glass fibers bound on the edges. For use in fan forced air conditioning units and residential warm air furnaces.			
1"			
10 x 20	12	220-200-051	105101
10 x 24	12	220-208-051	105102
12 x 20	12	220-314-051	105104
12 x 24	12	220-319-051	105105
12 x 25	12	220-321-051	105106
14 x 20	12	220-371-051	105107
14 x 24	12	220-412-051	105117
14 x 25	12	220-375-051	105108
15 x 20	12	220-400-051	105109
16 x 16	12	220-448-051	105110
16 x 20	12	220-500-051	105111
16 x 24	12	220-524-051	105119
16 x 25	12	220-600-051	105112
20 x 20	12	220-700-051	105113
20 x 25	12	220-800-051	105114
22 x 22	12	220-839-051	105115
24 x 24	12	220-863-051	105118
25 x 25	12	220-870-051	105116
2"			
16 x 20	12	198-500-051	105121
16 x 25	12	198-600-052	105122
20 x 20	12	198-700-052	105124
20 x 25	12	198-800-052	105125



105215



105132

FURNACE FILTERS

AMERICAN AIR FILTER

Item	Pack	Part #	HDI #
Dust Shield Pleated Furnace Filter - Rated 6 times better than standard furnace air filters. Stops 95% of household dust and lint. Removes 90% of particles 10 microns and larger including pollen.			
1"			
10 x 20	12	222-200-051	105215
12 x 24	12	222-319-051	105217
14 x 20	12	222-371-051	105218
14 x 24	12	222-412-051	105214
14 x 25	12	222-375-051	105219
15 x 20	12	222-400-051	105220
16 x 20	12	222-500-051	105221
16 x 25	12	222-600-051	105222
20 x 20	12	222-700-051	105223
20 x 25	12	222-800-051	105224
25 x 25	12	222-870-051	105226

MIDWEST AIR FILTER

Item	Pack	Part #	HDI #
DP-40 Extended Surface Pleated Panel Filters - Moisture resistant, double wall frame. Consistent pleat alignment enhances dust holding capacity for longer service life.			
4"			
16 x 20	6		105132
16 x 25	6		105134
18 x 24	6		105136
20 x 20	6		105138
20 x 24	6		105140
20 x 25	6		105142
24 x 24	6		105144



PLUMBING & HEATING

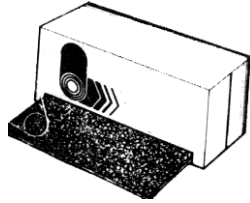

1/2" POLY SNIP TO FIT FILTER MATERIAL

MIDWEST AIR FILTER

Item	Pack	Part #	HDI #
Can be cut to desired length and width.			
30" x 120"	1	70-8097	105127
36" x 120"	1	70-8098	105128



1/4" FOAM FILTER MEDIA

MIDWEST AIR FILTER

Item	Pack	Part #	HDI #
Black Foam Filter Media			
1/4" x 24" x 10'	1		105130

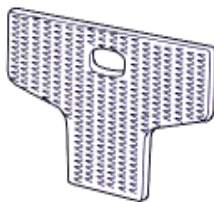

HUMIDIFIER - PLATES

GENERAL

Item	Pack	Part #	HDI #
Universal fiber glass type. Fits model 800 humidifier as well as most other types. 5 plates in a set.			
	10	880	140159



FURNACE CEMENT

RUTLAND

Item	Pack	Part #	HDI #
For installation and repair of wood coal stoves, furnaces and boilers.			
10.3 oz. cartridge	6	#64-C	350025
#64 - pints	6	20642	350027
#65 - quarts	6	20643	350029



PLUMBING & HEATING

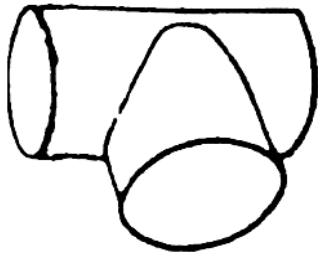

**GALVANIZED STOVE
PIPE TEE**

Jones Mfg
Made to match galvanized stove
pipe. No crimped ends.

3" - 26 ga	
(140001)	TJ036
4" - 26 ga	
(140003)	TJ046
5" - 26 ga	
(140026)	TJ056
6" - 26 ga	
(140005)	TJ066
7" - 26 ga	
(140007)	TJ076
8" - 26 ga	
(140009)	TJ086
pk 1	



**GALVANIZED STOVE
PIPE ELBOW**

Gray Metals
Four piece adjustable from
straight to 90°. Crimped on one
end. Made to match galvanized
stove pipe.

3" - 30 ga	
(140069)	3-30-302
4" - 30 ga	
(140071)	4-30-302
pk 24	
5" - 28 ga	
(140073)	5-28-302
6" - 30 ga	
(140075)	6-30-302
6" - 26 ga	
(140077)	6-26-302
6" - 24 ga	
(140079)	6-24-302
7" - 24 ga	
(140082)	7-24-302
8" - 24 ga	
(140083)	8-24-302
9" - 24 ga	
(140085)	9-24-302
pk 12	
10" - 24 ga	
(140087)	10-24-302
12" - 24 ga	
(140089)	12-24-302
pk 8	

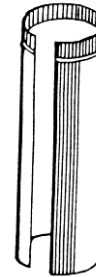

**GALVANIZED STOVE
PIPE**

Gray Metals
Self locking. Requires no tools.
Crimped on one end.

24" length	
3" - 30 ga	
(140047)	3-30-300
4" - 30 ga	
(140049)	4-30-300
5" - 28 ga	
(140051)	5-28-300
6" - 30 ga	
(140053)	6-30-300
6" - 26 ga	
(140055)	6-26-300
pk 25	
6" - 24 ga	
(140057)	6-24-300
7" - 24 ga	
(140060)	7-24-300
8" - 24 ga	
(140061)	8-24-300
9" - 24 ga	
(140063)	9-24-300
10" - 24 ga	
(140065)	10-24-300
12" - 24 ga	
(140067)	12-24-300
pk 12	

60" length

Jones Mfg

6" - 30 ga	
(140023)	PO650
pk 10	





PLUMBING & HEATING



**GALVANIZED RAIN
CAP**

S & K Products

Keeps rain and snow from entering stack.

- 3"
(140029) _____ D-283
 - 4"
(140031) _____ D-284
 - 5"
(140033) _____ D-285
 - 6"
(140035) _____ D-286
 - 7"
(140038) _____ 287
 - 8"
(140036) _____ 288
- pk 6

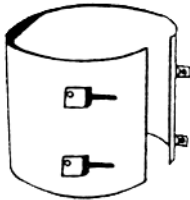

**GALVANIZED DRAW
BAND**

Jones Mfg

- 4"
(140425) _____ D04B
 - 5"
(140426) _____ D05B
 - 6"
(140427) _____ D06B
 - 7"
(140428) _____ D07B
 - 8"
(140429) _____ D08B
- pk 1



STORM COLLAR

Gray Metal

Secondary flashing helps insure leakproof installation.

- 6"
(140091) _____ 6-335
 - 8"
(140093) _____ 8-335
- pk 12



PLUMBING & HEATING

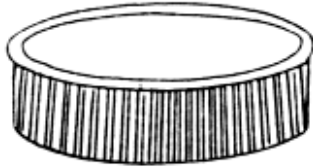

GALVANIZED CAP

Jones Mfg
Crimped

3"	
(140421)	RCC03
4"	
(140432)	RCC04
5"	
(140423)	RCC05
6"	
(140019)	RCC06
7"	
(140424)	RCC07
8"	
(140021)	RCC08
pk 1	

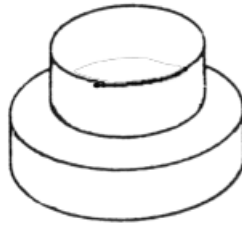

**GALVANIZED STOVE
PIPE REDUCING
BUSHING**

Jones Mfg
Non-crimped

4 x 3"	
(140010)	B00043
5 x 3"	
(140430)	B00543
5 x 4"	
(140431)	B00543
6 x 3"	
(140032)	B06543
6 x 4"	
(140011)	B06543
6 x 5"	
(140024)	B06543
7 x 6"	
(140013)	B07654
8 x 6"	
(140015)	B08765
8 x 7"	
(140017)	B08765f
9 x 6"	
(140434)	B08765
10 x 6"	
(140018)	B10987
10 x 8"	
(140433)	B10987
12 x 6"	
(140435)	B12086
pk 1	



PLUMBING & HEATING

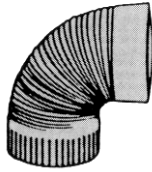

BLACK CORRUGATED ELBOW

Gray Metals
One piece, crimped one end.

6" - 24 ga
(140141) 6-24-602C
8" - 24 ga
(140145) 8-24-602C
pk 12



BLACK ADJUSTABLE ELBOW

Gray Metals
Four piece adjustable from straight to 90°. Crimped on one end.

6" - 24 ga
(140135) 6-24-602
7" - 24 ga
(140137) 7-24-602
8" - 24 ga
(140139) 8-24-602
pk 12



BLACK STOVE PIPE

Gray Metals
Self locking, requires no tools.
Crimped on one end.

6" - 24 ga
(140129) 6-24-600
7" - 24 ga
(140131) 7-24-600
8" - 24 ga
(140133) 8-24-600
pk 12

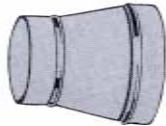

BLACK ROUND REDUCER

Gray Metals

7 x 6" - 24 ga
(140113) 7X6-611P
8 x 6" - 24 ga
(140115) 8X6-611P
8 x 7" - 24 ga
(140116) 8X7-611P
pk 4

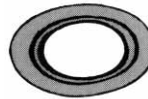

BLACK STOVE PIPE COLLAR

Gray Metals

6" - 24 ga
(140123) 6-605
7" - 24 ga
(140125) 7-605
8" - 24 ga
(140127) 8-605
pk 12

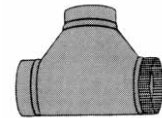

BLACK STOVE PIPE TEE

Gray Metals
Crimped on upright end.

6" - 24 ga
(140107) 6-604
7" - 24 ga
(140109) 7-604
8" - 24 ga
(140111) 8-604
pk 4



BLACK CAP - WITH CRIMP

Gray Metals

6" - 24 ga
(140147) 6-603SE
8" - 24 ga
(140149) 8-603SE
pk 12

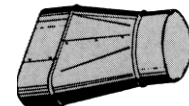

BLACK OVAL REDUCER

Gray Metals
Type A

7 x 6" - 24 ga
(140161) 7X6-610
pk 4



PLUMBING & HEATING



CAST DAMPER

Gray Metals

Cast iron with coil handle. One-piece steel spindle. Reversible plate.

3"
(140237) _____ 3-CID

4"
(140239) _____ 4-CID

5"
(140241) _____ 5-CID

6"
(140243) _____ 6-CID

7"
(140245) _____ 7-CID

8"
(140247) _____ 8-CID
pk 12

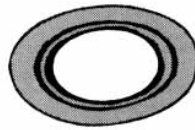

STOVE PIPE COLLAR

Gray Metals

TIn, gold lacquer finish. Outside diameter 10-1/8"

3"
(145983) _____ 3-gold

4"
(145984) _____ 4-gold

5"
(145985) _____ 5-gold

6"
(145986) _____ 6-gold

pk 12



FLUE STOP

Gray Metals

Folding wire fastener for use in 4" - 7 3/4" flue holes. 8-3/16" diameter.

(145982) _____ FLUESTOP-IV
pk 12



PLUMBING & HEATING

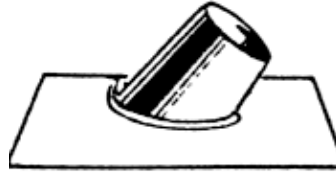

ROOF FLASHING

Gray Metals
Galvanized. Adjusts from flat to
6 / 12 pitch.

3"	
(140037)	3-1200
4"	
(140039)	4-1200
5"	
(140041)	5-1200
6"	
(140043)	6-1200
8"	
(140045)	8-1200
pk 12	

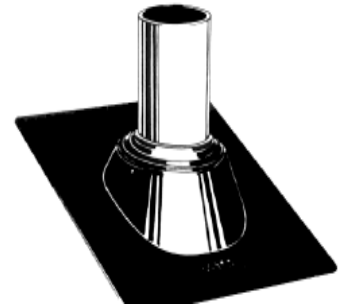

**THERMOPLASTIC
ROOF FLASHING**

Oatey
One piece construction elimi-
nates the possibility of the collar
coming off. Double seal insures
leak-free fit around vent stack and
allows collar to expand and con-
tract with the vent pipe. Fits all
roofs from flat to 45°. Use with
all pipe - PVC, copper, galvanized,
aluminum, etc.

1 1/4 - 1 1/2"	
(60042)	11898
2"	
(60045)	11899
3"	
(60048)	11890
4"	
(60050)	11891
pk 6	



PLUMBING & HEATING

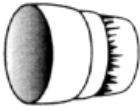

REDUCER

Deflecto
Heavy gauge aluminum reducer allows connection between ducting, pipe or dryer outlets of different diameters. Crimped end provides snug connection.

4" to 3"
(140289) _____ DIRB43
pk 12



ALUMINUM PIPE

Deflecto
Heavy gauge aluminum construction with snap-lock design that is crimped on one end for assembly and insertion.

3" x 2"
(140271) _____ DP243

4" x 2"
(140273) _____ DP244
pk 24



ALUMINUM ELBOW

Deflecto
Heavy gauge 4-piece aluminum elbow adjusts from 0° to 90° to provide installation flexibility. Elbows are crimped at one end for snug installation.

3"
(140275) _____ DE903

4"
(140277) _____ DE904
pk 12



4" DUCT CLAMP

Deflecto
Plated steel with slotted hex-head screw and nut for easy tightening with hex or screwdriver.

(140283) _____ MBC4
pk 50



PLUMBING & HEATING



RK8W

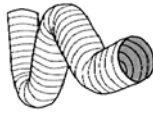

BH350W



AO48C/9



FLO450

VENT DUCT

DEFLECTO

Item	Pack	Part #	HDI #
White Vinyl Duct - Aluminum vent hood with pre-punched mounting holes, freeze free flapper and pre-riveted tailpipe. Oversized white vinyl duct in 8' length slips over tailpipe. Kit includes two plastic screw clamps.	12	RK8W	140261
Flexible White Vinyl Duct - Manufacturing process heat seals polyvinyl over wire helix that completely encloses the wire resulting in a smooth interior for maximum airflow.			
3" x 50'	1	BH350W	140269
4" x 50'	1	BH450W	140265
Flexible Aluminum Duct - Nonflammable aluminum, continuous lockseam construction. Shipped compressed, forms any angle and is self-supporting so it won't sag or bunch at bends. Aluminum allows duct to be pulled open, compressed, bent and rebent without damage. Duct is crimped at one end to allow simple joining with duct tape to traditional duct lengths or attachment to a vent hood.			
4" x 8'	9	AO48C/9	140288
Flame Resistant Silverduct - Silverduct combines the safety of aluminum with the convenience of vinyl. Construction is flexible aluminum with polyester laminate for flame resistance and strength.			
4" x 50'	1	FLO450	140263

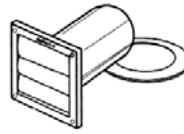

SVHAW4



DAVHA4

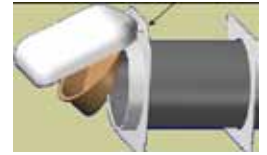

No Pest Vent

VENT HOOD

DEFLECTO

Item	Pack	Part #	HDI #
Louvered Vent Hood - Low Profile - Low profile plastic louvered hood provides minimal airflow resistance, low energy consumption and weather resistance. Includes mounting holes, backplate and pre-riveted tailpipe. Factory assembled.			
White	6	SVHAW4	140287
Brown	6	SVHAB4	140286
Aluminum Vent Hood - Aluminum vent hood with pre-punched mounting holes, freeze free flapper and aluminum back plate. Completely factory assembled, weather-proof and includes a pre-riveted tailpipe.			
Bulk 3"	12	DAVHA3 /12	140257
Boxed 4"	6	DAVHCA4	140259

P-TEC

Item	Pack	Part #	HDI #
No Pest Vent - Special door design cannot be opened from the outside by birds. Reliable closure to eliminate drafts. Door opens freely for adequate venting. Removable hood allows easy access for cleaning. No screens that plug up with lint reducing dryer efficiency and create a fire hazard. Tested in bird infested areas with 100% success with annual cleaning.			
White	4		140300
Tan	4		140305



PLUMBING & HEATING



18' FIBERGLASS ROD KIT

Rutland

Kit contains: 6 each 36" fiberglass rod. Rods have both male and female 1/4 npt ends

(160270) _____ KRK-18
pk 10



FIBERGLASS EXTENSION ROD

Rutland

48" length - .350 diameter. Both male and female 1/4 npt connections.

(160260) _____ 10624
pk 24



PULL RING

Rutland

1/4 npt for adding weight or two person cleaning.

(160265) _____ K-14-PTL
pk 12



1/4" X 3/8" ADAPTER

Rutland

Adapts 3/8 npt rods to 1/4 npt rods.

(160290) _____ 1438
pk 12



FIRE BRICK

Sandkuhl Tile Co

4 1/2 x 9 x 1 1/4". For all stoves.

1#
(160120) _____ 1
pk 1



FIREPLACE MATCHES

Rutland

Long wooden fireplace matches are suitable for lighting either fireplace or barbeque fires. Decorative box.

90 per box; 10 1/2" long.

(160295) _____ 716
pk 12



PLUMBING & HEATING

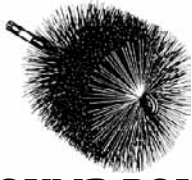

**ROUND POLY
CHIMNEY BRUSH**

Rutland

Heavy duty polypropylene bristles for the wiping action needed for cleaning chimneys used by coal and oil furnaces.

1/4" nipple

6"
(160200) 16906

8"
(160203) 16908

pk 1



PELLET STOVE BRUSH

Rutland

Poly brushes flexible handle used to clean pellet stoves and dryer vents. It is designed to navigate corners without getting caught in elbows and offsets.

3" Brush, 10' Handle
(160305) 17409

4" Brush, 10' Handle
(160310) 17410

pk 4



**ROUND WIRE
CHIMNEY BRUSH**

Rutland

Single spiral brush made for the do-it-yourselfer. It is the best quality brush available to the homeowner. 1/4" nipple

6"
(160210) 16406

7"
(160215) 16407

8"
(160220) 16408

10"
(160225) 16410

pk 1



**RECTANGLE WIRE
CHIMNEY BRUSH**

Rutland

Single spiral brush made for the do-it-yourselfer. The best quality brush available to the homeowner. 1/4" nipple

6 x 6"
(160230) 16506

7 x 7"
(160235) 16507

8 X 8"
(160240) 16508

7 x 11"
(160245) 16532

8 x 12"
(160250) 16533

12 x 12"
(160255) 16512

pk 1



PLUMBING & HEATING



GALVANIZED ASH SHOVEL

Behrens Metals
Flat 12" handle. 7-1/4" scoop.
Use for fireplace and stove.

19" Galvanized
(145981) _____ 17GCS
pk 12



FUEL OIL FILTER

General Filter
Completely leakproof cap.
Adapts to gravity or pressure type burners. Quick cartridge replacement. Removes moisture and particles from 1, 2 and 3 fuel oils. Cast iron and steel construction. 3/8" pipe openings.

STANDARD MODEL

for small to average sized homes
5-1/8" H x 3-5/8" D

(45045) _____ 1A-25A

MASTER MODEL

for average and large size homes
6-5/32" H x 4-3/8" D

(45050) _____ 2A-700A
pk 12



REPLACEMENT FOR FUEL OIL FILTER

General Filter
Step design wool felt filter element. Includes gaskets.

For 1A-25A
(45055) _____ 1A-30A
pk 36

For 2A-700A
(45060) _____ 2A-710
pk 12



PLUMBING & HEATING

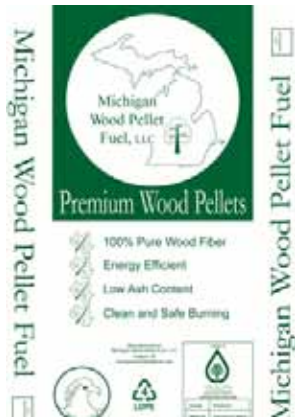

PREMIUM WOOD PELLET FUEL

MICHIGAN WOOD PELLETS

Item	Pack	Part #	HDI #
North Country Pellet Fuel - 100% Pure Wood Fiber, energy efficient, low ash content, clean and safe burning			
40# Bags	50		160725

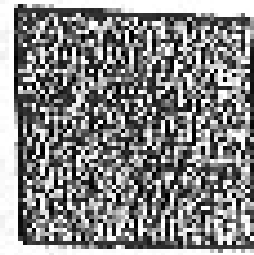

UL LISTED STOVEBOARD

GRAY METAL PRODUCTS

Item	Pack	Part #	HDI #
Protects floors and floor coverings from ashes, coals, sparks and heat from wood, coal, or oil burning stoves.			
Black 36 x 48"	1	UL3648BLK-S	160928
Black 36 x 36"	1	UL3636BLK-S	160936



PLUMBING & HEATING

**KEROSENE HEATER
REPLACEMENT WICK**



21st Century

Refer to cross reference chart for
additional wick applications.

Aladdin TR10, Radiant Kin 220,
Toyokuni 80e
(160501) G100

Aladdin S181U, Corona SX2,
Toyo 84EU
(160505) G101

Corona 22DK, Aladdin TR600,
Comfort Glow C226000
(160507) G110

Kerosun/Toyo Rad 8, 10, 22
Sanyo OHRG28
(160515) G112

Kerosun Rad 36,
Toyostove RC37, RC36
(160519) G113
pk 5

Aladdin, TR16, Robeson 2606-38,
Sanyo 420
(160525) G114

Kerosun Omni 105, Turco 3105,
Corona 11-DK
(160530) G115

Kerosun Omni 15 & Moonlighter
(160535) G116

117 Wick 21st Century
Sengoku OR77, Sanyo
OHRG25A, Yuasa J10
(160540) 117

Robeson 2602-38, 2602-49,
Turco 2000
(160545) G126
pk 5

Comfort Glow GC19,
Sears 40302, Fanco
(160550) 129

Kerosun Omni 120
Toyostove KSA 120
(160551) 138

Sears, 40305, 40309, 40311,
40314
(160555) 142

Comfort Glow GRB
Sears 40201 (top only)
(160560) 143

Comfort Glow GR9
Sears 40202
(160565) 144

Toyostove DC100 KRA 105
(160566) 157

Toyostove DC60, DC80,
RCA87
(160569) 158

171 Wick 21st Century,
Corona Fits 23-DK
(160567) 171

169 Wick 21st Century,
Corona Fits SX-2E
(160568) 169
pk 5



GLO-BRITE LAMP OIL

21st Century
20 oz. Bottle
Clear, Gardenia

(160595) L-500
pk 12



PLUMBING & HEATING



KEROSENE ADDITIVE

21st Century
Fuel additive. Treats 80 gallons.
Reduces odor. Disperses water.
Cleans wick. Mixed scents in
case.

8 oz.
(160570) AO8
pk 24



MANUAL SYPHON

21st Century
Fits 5 gallon cans. Individually
packaged.

(160330) A40
pk 24



BATTERY SYPHON

21st Century
Fits 5 gallon cans. Uses two "D"
batteries. For easy transfer of
kerosene from can to heater.

(160580) A50
pk 24

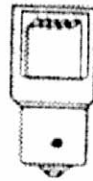

IGNITER

21st Century
Most popular igniter, fits 80% of
all heaters.

(160585) P10A
pk 1

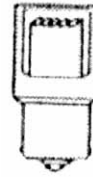

IGNITER

21st Century
Second most popular size. Fits
Sanyo, Turco, Hamai and others.

(160590) P30A
pk 1

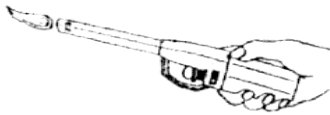

**HOT SHOT
REFILLABLE BUTANE
LIGHTER**

King
Hand held lighter with piezo elec-
tric spark. Child resistant.

(170905) VL8-1
pk 12

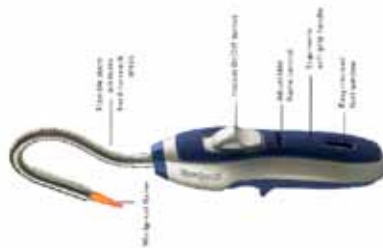

**BUTANE FLEXIBLE
STEM LIGHTER**

Bernzomatic
Ideal for Lighting Candles,
Camping, Grilling. Features In-
stant On/Off, Adjustable Flame
Control, Ergonomic Soft Grip
Handle, Easy to Read Fuel Win-
dow, Flexible Stem Can Be Bent

(35021) BZ02MPP
pk 10

PLUMBING & HEATING



**SAFE-T-FLUE
CHIMNEY CLEANER**

Rutland

Chimney cleaning compound is formulated to combine with flue gases to change chemical composition of creosote. Reduces the chance of chimney fires by turning flammable creosote into a dry flaky compound.

1#
(160526) WI-21124
pk 24

2#
(160528) WI-21212
pk 12



**ONE MATCH GEL FIRE
STARTER**

Rutland

The Superior Fire Starter For Pellet Stoves! Burns 25% longer, you use less for greater economy. Rutland One Match® Gel Fire Starter is a gelled alcohol formulation that is especially effective for starting fires in pellet stoves. This clean burning firestarter will not affect catalytic combustors.

(160630) 49
pk 12



**LIQUID CREOSOTE
REMOVER**

Rutland

Chimney cleaning compound is formulated to combine with flue gases to change chemical composition of creosote. Reduces the chance of chimney fires by turning flammable creosote into a dry flaky compound.

32 oz. trigger spray
(160500) 97L
pk 12



**SAFE-LITE FIRE
STARTERS**

Rutland

Environmentally sensible, economical, safe firelighter. Lights quickly and burns 8 to 12 minutes even when wet. Suitable for charcoal grills, fireplaces, wood and pellet stoves and campfires. Non-explosive, non-toxic.

(160300) 50C
pk 24



**POWDERED SOOT
DESTROYER**

Rutland

Helps cut fuel costs. Improves heating system efficiency. Improves the performance of all non-airtight free-burning fireplaces, woodstoves and furnaces.

38 oz.
(350022) C-38
pk 6



**KWIK-SHOT SOOT
STOPPER**

Rutland

Easy toss-in stick that controls soot buildup in free burning fireplaces. No measuring, no mess.

3 oz. Tubes
(160648) 100S
pk 36



RAINBOW FLAME STICKS

Rutland

Enjoy the warmth and natural beauty of softly dancing colorful flames. The granular crystals provide the relaxing enjoyment of a romantic fiesta of intense blue to green colored flames when the stick is added to a wood fire. Do not add Rainbow Flame Sticks to fires that are to be used for cooking.

(160635) 715C
pk 36



PLUMBING & HEATING

GRAPHO-GLAS GASKET KIT



RUTLAND

Item	Pack	Part #	HDI #
This handy repair kit replaces burnt off and worn out gaskets on air-tight heating appliances such as wood stoves, coal stoves, furnaces, stokers, fireplace insert stoves, etc. The customer has a choice of tape or rope in the right size gasket for his needs.			
3/8 x 7' Rope - Black	6	96-6	160602
1/2 x 7' Rope - Black	6	96N-6	160604
5/8 x 7' Rope - Black	6	96W-6	160606
5/8 x 7' Tape - Black	6	95-6	160608
Bulk			
3/8" x 132' Grapho-Glass Rope	1	722	160610
1/2" x 88' Grapho-Glass Rope	1	723	160612
5/8" x 65' Grapho-Glass Rope	1	724	160614
3/4" x 47' Grapho-Glass Rope	1	725	160616

STOVE GASKET CEMENT



RUTLAND

Item	Pack	Part #	HDI #
Withstands temperatures up to 3000° and insures an air-tight seal when used with fiberglass gasket. Can be used to reseal stove joint and repair cracked firebrick.			
4 oz	12	77	160524

CHIMFEX FIRE SUPPRESSANT



RUTLAND

Item	Pack	Part #	HDI #
This fire suppressant is indispensable as the first line of defense for controlling fires that occur from creosote build-up in chimneys. Suppresses chimney fire in 22 seconds.			
	8	3412	160650

WILLIAMS STOVE POLISH



RUTLAND

Item	Pack	Part #	HDI #
Black, semi-paste. Brings black satin finish to cast iron and sheet metal stoves. Use on Franklin fireplaces, irons, fireplace screens, stove pipe, antique iron pots and kettles. Water based, has no odor or flammability.			
2.7 oz.	12	WI-00710	300060



MAGICAL FLAMES DISPLAY

EVERGREEN RESEARCH

Item	Pack	Part #	HDI #
Great for camp fires, bon fires, and other wood burning fires. Easy to use. Gives vibrant, rainbow colored flames.			
50 per display	4		790795

INSTA-FIRE STARTER



INSTA-FIRE

Item	Pack	Part #	HDI #
Burns "green" - no harmful chemicals or vapors. Each pouch lights up to 4 fires. Burns 1000° - dries and burns wet wood. Burns in wind, rain, sleet and snow. Optimal fire starter that lights the first time. Lightweight - easily carried anywhere. Safely stores near food. Each pouch burns 10-15 minutes. No risk for unexpected fires or flare-ups. The leftover ash is a natural fertilizer that nourishes the Earth.			
3 pk	10	PK-FSSO	161000
12 on clip	24	12C-CS FSO	161001
Bulk 2 gal bucket	1	2GB-FSSO	161002

INSTA-FIRE CHARCOAL



INSTA-FIRE

Item	Pack	Part #	HDI #
The Charcoal Starter pouches contain 1/2 cup of Insta-Fire product. Each pouch allows the customer a safe, clean way to light up to 75 charcoal briquettes. It is made from recycled wood, inert materials, and shielded with a patented blend of paraffin, making it inherently safe and environmentally friendly.			
12 on clip	24	12C-CCCBL	161004

PLUMBING & HEATING



THERMOSTAT

Honeywell
Heat only, economy, low voltage. (15 - 30V) for use with gas, oil, hot water, gravity and steam. Replaces most two wire 24V thermostats. Bimetal Temperature Sensor. Snap action switch requires no leveling. Mercury Free

(20504) YCT30
pk 6



WINTER WATCHMAN

Honeywell
Low Temperature Signal turns plugged in light on when inside home temperature falls below desired level. For alerting neighbors to a low temperature in an unoccupied home. Prevents frozen and burst pipes. 35° to 60°F sensing range.

(20506) CW200A
pk 6



**THERMOSTAT
"The Round"**

Honeywell
Easy to install and use. Mercury free switch. Decorative cover ring hides wall marks. Temperature range 42° to 87°F. Use with oil, gas, steam or hot water heating.

heat only
(20503) YCT87K

heat & air conditioning
(20505) YCT87N
pk 6



**5-2 DAY
PROGRAMMABLE
THERMOSTAT**

Honeywell
One program for the weekdays and a separate program for the weekend with 4 program periods per day. Energy Savings - Program to save up to 33 percent on annual heating and cooling costs. Backlit Display - Easy to read even in dimly lit rooms and hallways. Universal Thermostat: Conventional and heat pump compatible.

(20507) RTH6350D
pk 6



**HEAVY DUTY ADJUSTABLE
THERMOSTAT**

WRAP-ON

Item	Pack	Part #	HDI #
Automatically turns heaters ON/OFF at dialed temperature. No additional wiring needed. Conserves energy. 1800 watt capacity			
•Voltage : 110VAC, 3 prong plug and grounded receptacle			
•Amps : 13.80 A			
•Temp. Range : 0.0 °F [Min], -18.0 °C [Min], 100.0 °F [Max], 38.0 °C [Max]			
•Watts : 1800.00 W			
•Wt. : 1/2 lb			
	1	18700	165049



PLUMBING & HEATING



WATER HEATER ELEMENTS

KNOX

Item	Pack	Part #	HDI #
Universal offset flange. 2½" square flange with raised corners. 2½" bolt circle, 1-49/64" bolt centers. "O" ring gasket included.			
4500W/240V	1	U245SK	157070
3500W/240V	1	U235SK	157088
1500W/120V	1	U115SK	157077
Knox 1" NPT No-taper screw plug. Fits many models of Rheem, State, Ruud, Norge, and others. One gasket included.			
4500W/240V	1	S245SK	157072
3500W/240V	1	S235SK	157087
3000W/240V	1	S230SK	157089
1500W/120V	1	S115SK	157076
Wrench for screw type element			
	1	SW-2SK	157090



REPLACEMENT THERMOSTAT

KNOX

Item	Pack	Part #	HDI #
Non-simultaneous operation. Adjustable			
<i>Lower</i>			
Lower thermostat for double element heaters	1	4000SK	157079
<i>Upper</i>			
Combination upper thermostat with high limit reset button for double element heaters	1	4100HLSK	157078



UNIVERSAL COPPER THERMOCOUPLE

KNOX

Item	Pack	Part #	HDI #
All copper with brass fittings. Adjustable to five different mountings.			
18"	10	UT-18	157081
24"	10	UT-24	157082
30"	10	UT-30	157083
36"	10	UT-36	157086



PLUMBING & HEATING



59779

WATER HEATER CONNECTORS

DANCO

Item	Pack	Part #	HDI#
Water Heater Connectors - Features Chloramine-resistant inner core and soft cone washer. Flexible. Suitable for water temperatures 33°F to 140°F. Stainless Steel			
3/4" MIP x 3/4" FIP x 18"	10	59779	87574
3/4" MIP x 3/4" FIP x 24"	10	59780	87576
3/4" FIP x 3/4" FIP x 12"	10	59781	125224
3/4" FIP x 3/4" FIP x 18"	10	59782	87578
3/4" FIP x 3/4" FIP x 24"	10	59783	87580
Copper Corrugated Water Heater Connectors - Corrugated copper tube with brass ends with built-in dielectric. UPC & NSF-64 Approved.			
<i>Copper</i>			
3/4" FIP x 3/4" FIP x 18"	25	WCP118PP	87590
3/4" FIP x 3/4" FIP x 24"	25	WCP124PP	87592
<i>Stainless Steel</i>			
3/4" FIP x 3/4" FIP x 18"	25	WCS118PP	87594
3/4" FIP x 3/4" FIP x 24"	25	WCS124PP	87596



509-1536SS

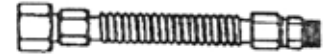

509-1024SS

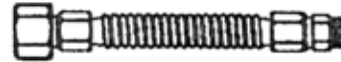

509-1124

FLEXIBLE APPLIANCE GAS CONNECTOR

LDR

Item	Pack	Part #	HDI #
Stainless Steel - Coated. Recommended for gas ranges/ovens/furnace/boiler. 1 per bag. 5/8" OD (1/2" ID), 3/4" FIP x 3/4" FIP			
36"	5	509-1536SS	86505
48"	5	509-1548SS	86506
Stainless Steel - Recommended for gas stove/furnace/wall heater. 1 per bag. 3/8" OD (1/4" ID) corrugated tube. 1/2" FIP x 1/2" MIP or 3/8" FIP			
24"	5	509-1024SS	86518
36"	5	509-1036SS	86515
48"	5	509-1048SS	86517
Stainless Steel - Recommended for space heaters, water heaters and dryers. 1 per bag. 1/2" OD (3/8" ID) corrugated tube. 1/2" FIP x 1/2" MIP or 3/8" FIP			
24"	5	509-1124	86512
36"	5	509-1136	86514
48"	5	509-1148	86516



509-1100SS



509-1400SS

GAS APPLIANCE INSTALLATION KITS

LDR

Item	Pack	Part #	HDI#
Gas Dryer - Fits new and older brands and models. Kits includes: (1) 1/4" ID (3/8" OD) x 48" stainless steel gas connector (2) 3/8" OD Flare x 1/2" MIP fittings, (1) 3/8" OD Flare x 1/2" FIP fittings, (1) leak detection solution and (1) teflon thread tape.			
	5	509-1100SS	86520
Gas Range - Fits most new and older brands and models. Kit includes: (1) 1/2" ID (5/8" OD) x 48" stainless steel gas connector, (2) 5/8" OD Flare (15/16-16) x 1/2" MIP fittings, (2) 5/8" OD Flare (15/16-16 x 3/4" MIP fittings, (1) leak detection solution and (1) teflon thread tape.			
	5	509-1400SS	125306



PLUMBING & HEATING



FIBERGLASS INSULATION

WRAP-ON

Item	Pack	Part #	HDI #
Easy installation for all hot and cold water pipes. Comes with vapor seal wrap to seal out moisture and weather.			
1/2" x 3" x 25'	24	16525	165093
1/2" x 6" x 36'	6	16506	165095



SNAP-ON PIPE INSULATION

WJ DENNIS

Item	Pack	Part #	HDI #
3/8" wall thickness. Cuts heat loss 60%. 4 - 3' pieces per pkg. Black			
5/8" ID for 1/2" Copper/CPVC or 3/8" Galvanized/PVC	16	PC1	55111
7/8" ID for 3/4" Copper/CPVC or 1/2" Galvanized/PVC	18	PC2	55113
1 1/8" ID for 1" Cooper/CPVC or 3/4" Galvanized/PVC	14	PC3	55114



PIPE HEAT CABLE

WRAP-ON

Item	Pack	Part #	HDI #
UL listed. Grounded. With thermostat and pilot light. Automatically comes on at 38°F. Residential, mobile home heating cable for metal or rigid plastic pipe.			
3'	12	31003	165001
6'	12	31006	165003
9'	12	31009	165005
13'	12	31013	165007
15'	12	31015	165009
18'	12	31018	165011
24'	6	31024	165013
30'	6	31030	165015
45'	6	31045	165017
60'	3	31060	165019
80'	3	31080	165021
100'	3	31100	165023



PLUMBING & HEATING



ROOF & GUTTER CABLE

EASY HEAT/WRAP-ON

Item	Pack	Part #	HDI #
Gutter cable provides an escape channel for melting ice and snow. Extend along bottom of gutter & into down-spout. A second row zigzagged along lower edge of roof is essential where there is overhang. Use manual switch for control. Turn on when temperature approaches thawing conditions. Use 3½' of cable per linear foot of roof.			
20'	5	ADKS-100	165083
30'	5	ADKS-150	165085
60'	5	ADKS-300	165121
80'	5	ADKS-400	165123
100'	5	ADKS-500	165125
120'	2	ADKS-600	165127
140'	2	14140	165099
160'	2	ADKS-800	165129
200'	2	ADKS-1000	165131
240'	2	ADKS-1200	165133

GUTTER CABLE CLIPS

WRAP-ON

Item	Pack	Part #	HDI #
Aluminum clips for attaching gutter cable to roof on zig zag installations. 23 per bag = 15 roof clips and 8 down-spout clips.			
	1	14500	165101



PLUMBING & HEATING



31128



31012



30818

CEMENT

OATEY

Item	Pack	Part #	HDI #
CPVC Cement - Orange label. Medium bodied for CPVC pipe and fittings up to 6" diameter. FOR CTS and sch 80 potable water pressure pipe. Apply at temperatures 40 - 90°F.			
4 oz.	24	31128	60074
8 oz.	24	31129	60075
Regular Cement - Gold label. For PVC pipe fittings. Regular bodied clear cement for use on PVC pipe & fittings. Up to 4" for DWV or sch 40 & up to 2" for sch 80. Potable water, pressure pipe, gas, conduit, drain-waste-vent. Apply at temperatures 40 - 100°F.			
4 oz.	24	31012	60063
8 oz.	24	31013	60066
All Purpose Cement - Red label. For ABS, PVC and CPVC pipe fittings. Heavy bodied clear cement for all pipe schedules, potable water, pressure pipe, gas, conduit & drain-waste-vent up to 6". Apply at temperatures 40 - 100°F.			
4 oz.	24	30818	60054
8 oz.	24	30821	60057
16 oz.	24	30834	60060



HANDY PACK

OATEY

Item	Pack	Part #	HDI #
Contains one can of PVC cement and one can of NSF Purple Primer.			
4 oz.	12	30246	60080



30755



30779

PRIMER / CLEANER

OATEY

Item	Pack	Part #	HDI #
Purple Primer/Cleaner - Purple label. For PVC and CPVC pipe and fittings. All purpose primer and cleaner removes all surface dirt, grease, and grime and softens pipe surface to allow for a fast, secure solvent weld. Purple tint shows positive verification that a primer has been used. Apply at temperatures 40 - 100°F.			
4 oz.	24	30755	60076
8 oz.	24	30756	60078
All Purpose Primer/Cleaner - Yellow label. Clear cleaner for use on ABS, PVC and CPVC pipe and fittings; all schedules & sizes. Fast acting cleaner removes surface dirt, grease and grime and softens pipe surface to allow for a fast, secure solvent weld. Apply at temperatures 40 - 100°F. LO-VOC			
4 oz.	24	30779	60067
8 oz.	24	30782	60070
16 oz.	24	30795	60073

Purple



Conduit



AEROSOL PRIMER / CLEANER / CEMENT

GO AEROSOL SPRAY WELD

Item	Pack	Part #	HDI #
GoAerosol SPRAYWELD PURPLE - It's a cleaner/primer and cement all in one! No mess! No waste! No contamination! Easy-to-use one handed operation! One can goes twice as far as other primers and wipe ons. Certified by IAPMO to ASTM D -2564 and NSF/ANSI - 61.			
11 oz.	12	SWCP-100	155105
GoAerosol SPRAYWELD CONDUIT - For use with electrical PVC conduit. It's a cleaner/primer and cement all in one! No mess! No waste! No contamination! Easy-to-use one handed operation! Meets ASTM D-2564, NEMA TC-2, NEMA TC-6 and NEMA TC-8.			
11 oz.	12	SWCG-100	155110



PLUMBING & HEATING

PVC SEWER & DRAIN PIPE & FITTINGS

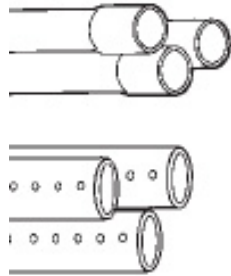

SEWER & DRAIN PIPE

GENOVA

Item	Pack	Part #	HDI #
Solid - PVC - DS pipe. Belled end. Solvent weld. Use for septic tank systems and house to sewer lines.			
4" x 10'	5	40040	60082
Perforated - PVC - DS pipe. Belled end. 2 rows of 5/8" holes on 5" centers 120° apart, meets Michigan standard. Solvent weld.			
4" x 10'	5	40041	60084



SEWER & DRAIN PIPE FITTINGS - 4" PVC

GENOVA

Item	Pack	Part #	HDI #
90° Elbow	10	40740	60087
90° Sanitary Elbow	10	42840	60088
90° Street Elbow	10	42940	60089
45° Elbow	10	40640	60090
45° Street Elbow	10	42740	60092
Coupling	10	40140	60086
Cap	10	40154	60098
Wye	10	41040	60101
Tee	10	41140	60094
Cross	10	43240	60096
Drain Grate	10	49240	60100

SCHEDULE 30 PVC-DWV PIPE & FITTINGS

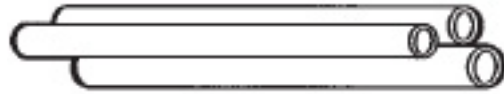

SCHEDULE 30 PVC-DWV PIPE - 3"

GENOVA

Item	Pack	Part #	HDI #
Meets ASTM D2949. NSF Listed. Fits inside a 2" x 4" wall.			
3" x 10'	5	60031	60700



SCHEDULE 30 PVC-DWV PIPE FITTINGS - 3"

GENOVA

Item	Pack	Part #	HDI #
Coupling	20	60130	60705
3" x 1½" Reducing Coupling	20	60131	60710
3" x 2" Reducing Bushing	20	60232	60720
Sch. 40 to Sch. 30 Adapter	20	65330	60330
Wye	20	61030	60730
Sanitary Tee	20	61130	60740
Cap	20	60153	60712
45° Elbow	20	60630	60725
45° Street Elbow	20	62730	60755
90° Sanitary Elbow	20	62830	60760
90° Sanitary Street Elbow	20	62936	60765
Cleanout w/Threaded Plug	20	61630	60750
4" x 3" Pop Top Closet Flange	20	65134	60770



SCHEDULE 40 PVC-DWV PIPE & FITTINGS

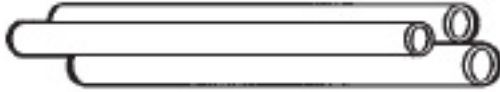

SCHEDULE 40 PVC-DWV PIPE

GENOVA

Item	Pack	Part #	HDI #
Cellular core. Meets ASTM F891. NSF Listed			
1½" x 10'	5	70011F	60170
2" x 10'	5	70021F	60226
3" x 10'	5	70031F	60272
4" x 10'	3	70041F	60332



SCHEDULE 40 COUPLINGS

GENOVA

Item	Pack	Part #	HDI #
Coupling			
1½"	10	70115	60172
2"	10	70120	60228
3"	10	70130	60274
4"	10	70140	60334
Repair Coupling - Furnished without center stop so that stationary lengths of pipe can be spliced together.			
4"	10	70144	60338
Reducing Coupling			
2" x 1½"	20	70121	60230
3" x 1½"	20	70131	60276
3" x 2"	20	70132	60278
4" x 2"	20	70142	60335
4" x 3"	20	70143	60336



SCHEDULE 40 CAPS

GENOVA

Item	Pack	Part #	HDI #
1½"	10	70151	60174
2"	10	70152	60231
3"	10	70153	60279
4"	10	70154	60340



SCHEDULE 40 BUSHINGS

GENOVA

Item	Pack	Part #	HDI #
Reducing Bushing			
2" x 1½"	10	70221	60232
3" x 1½"	10	70231	60280
3" x 2"	10	70232	60281
4" x 2"	10	70242	60342
4" x 3"	10	70243	60344



PLUMBING & HEATING

SCHEDULE 40 PVC-DWV PIPE & FITTINGS



SCHEDULE 40 22 1/2° ELBOWS

GENOVA

Item	Pack	Part #	HDI #
1 1/2"	10	70815	60188
2"	10	70820	60242
3"	10	70830	60290
4"	10	70840	60351

SCHEDULE 40 45° ELBOWS



GENOVA

Item	Pack	Part #	HDI #
45° Elbow			
1 1/2"	20	70615	60184
2"	20	70620	60238
3"	20	70630	60286
4"	10	70640	60348
45° Street Elbow			
1 1/2"	20	72715	60206
2"	20	72720	60260
3"	20	72730	60314
4"	10	72740	60380

SCHEDULE 40 60° ELBOWS



GENOVA

Item	Pack	Part #	HDI #
Used to change direction in piping.			
1 1/2"	20	70915	60190
2"	20	70920	60244
4"	10	70940	60350



60208 60216 60186 60212 60210

SCHEDULE 40 90° ELBOWS

GENOVA

Item	Pack	Part #	HDI #
90° Sanitary Elbow			
1 1/2"	10	72815	60208
2"	10	72820	60262
3"	10	72830	60316
4"	10	72840	60382
90° Long Sweep Elbow			
1 1/2"	20	73815	60216
2"	20	73820	60268
3"	20	73830	60322
4"	20	73840	60388
90° Vent Elbow			
1 1/2"	30	70715	60186
2"	30	70720	60240
3"	30	70730	60288
90° Sanitary Street Elbow			
1 1/2"	20	72916	60212
2"	20	72926	60265
3"	20	72936	60318
4"	10	72946	60384
90° Vent Street Elbow			
1 1/2"	20	72915	60210
2"	20	72920	60264



SCHEDULE 40 PVC-DWV PIPE & FITTINGS

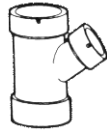

SCHEDULE 40 REDUCING WYE

GENOVA

Item	Pack	Part #	HDI #
Used when connecting a branch line into a horizontal drain pipe. Also used with a "Twist-Lok" plug to provide a cleanout in a drain pipe.			
2 x 2 x 1 1/2"	10	71021	60248
3 x 3 x 2"	10	71032	60296
4 x 4 x 2"	10	71042	60356
4 x 4 x 3"	10	71043	60358



SCHEDULE 40 WYE

GENOVA

Item	Pack	Part #	HDI #
Used when connecting a branch line into a horizontal drain pipe. Also used with a "Twist-Lok" plug to provide a cleanout in a drain pipe.			
1 1/2"	25	71015	60192
2"	20	71020	60246
3"	20	71030	60292
4"	5	71040	60352



SCHEDULE 40 REDUCING SANITARY TEE

GENOVA

Item	Pack	Part #	HDI #
Used when connecting a branch line into a vertical drain pipe.			
2 x 2 x 1 1/2"	10	71121	60252
3 x 3 x 1 1/2"	10	71131	60300
3 x 3 x 2"	10	71132	60302
4 x 4 x 2"	10	71142	60364

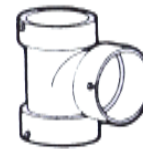

SCHEDULE 40 SANITARY TEE

GENOVA

Item	Pack	Part #	HDI #
Used when connecting a branch line into a vertical drain pipe.			
1 1/2"	10	71115	60194
2"	10	71120	60250
3"	10	71130	60298
4"	10	71140	60360



SCHEDULE 40 REDUCING SANITARY TEST TEE

GENOVA

Item	Pack	Part #	HDI #
Used at the base of a vertical drain pipe to provide a cleanout opening flush with the finished wall.			
4" Toe saver plug	10	71340	60368



PLUMBING & HEATING

SCHEDULE 40 PVC-DWV PIPE & FITTINGS



SCHEDULE 40 ADAPTERS



GENOVA

Item	Pack	Part #	HDI #
Sewer Pipe (Sewer Hub x Sch 40 Hub) - Adapts schedule 40 pipe to 4" sewer pipe.			
4" sewer to 3" sch 40	20	71543	60306
4" sewer to 4" sch 40	10	71544	60372
Trap Adapter (Hub x Slip Jamnut) - Adapts PVC pipe to tubular traps at wall or floor. Solvent welds over 1/2" DWV pipe.			
1/2" x 1/4"/1/2"	20	72211	60200
Fitting Trap Adapter (Spigot x Slip Jamnut) - Adapts PVC pipe to tubular traps at wall or floor. Solvent welds into 1/2" DWV fitting hub.			
1/2" x 1/4"/1/2"	20	72311	60202
Fitting Adapter (Spigot x MIP) - Adapts fitting hub to standard female pipe threads.			
1/2"	20	72415	60204
Female Adapters (Hub x FIP) - Adapts PVC-DWV pipe to standard threaded female pipe threads			
1/2" x 1/4"	10	70311	60176
1/2"	10	70315	60178
2"	10	70320	60234
3"	10	70330	60282
4"	10	70340	60347
Male Adapters (Hub x MIP) - Adapts PVC-DWV pipe to standard male pipe threads			
1/2" x 1/4"	10	70411	60180
1/2"	10	70415	60182
2"	10	70420	60236
3"	10	70430	60284
4"	10	70440	60349

SCHEDULE 40 U-BENDS



GENOVA

Item	Pack	Part #	HDI #
U-Bend (Hub x Hub) - Bottom part of trap furnished without cleanout.			
1/2"	20	78015	60214

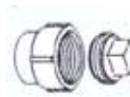

SCHEDULE 40 FITTING CLEANOUT W/ THREADED PLUG

GENOVA

Item	Pack	Part #	HDI #
Solvent welds into fitting hub to provide access to piping.			
1/2"	10	71615	60196
2"	10	71620	60256
3"	10	71630	60308
4"	10	71640	60374



SCHEDULE 40 THREADED PLUG (MIP)

GENOVA

Item	Pack	Part #	HDI #
Threaded plugs offer an alternative to metal plugs.			
1/2"	10	71815	60198
2"	10	71820	60258
3"	10	71830	60312
4"	10	71840	60378



SCHEDULE 40 P-TRAPS

GENOVA

Item	Pack	Part #	HDI #
Adjustable P-Trap w/Union & Cleanout - Used to prevent passage of sewer gas from the plumbing system into house through the plumbing fixture drain.			
1/2"	20	78215	60220
P-Trap w/Cleanout - Used to prevent passage of sewer gas from the plumbing system into house through the plumbing fixture drain.			
1/2"	20	78415	60222
2"	20	78420	60270
P-Trap (No Cleanout) - Used to prevent passage of sewer gas from the plumbing system into house through the plumbing fixture drain.			
1/2"	20	78515	60224
2"	20	78520	60225



PLUMBING & HEATING

SCHEDULE 40 PVC-DWV PIPE & FITTINGS



SCHEDULE 40 VINYL BELL TRAP

GENOVA

Item	Pack	Part #	HDI #
Designed to solvent weld to schedule 40 IPS PVC. Installs easily and is a direct replacement for cast bell traps.			
6" x 6" 1 1/2" Socket or 2" Spigot	5	78860	60780
9" x 9" 3" Sch 30 Socket or 3" Sch 40 Spigot	5	78890	60785
9" x 9" Replacement Strainer	1	78888	60788



SCHEDULE 40 POP-TOP CLOSET FLANGE

GENOVA

Item	Pack	Part #	HDI #
Solvent welds over 3" Schedule 40 pipe.			
4" x 3"	20	75134	60324



SCHEDULE 40 VINYL HUB FIT FLOOR STRAINER

GENOVA

Item	Pack	Part #	HDI #
Prevents debris from entering a drain opening on the floor.			
3"	20	79230	60328
4"	20	79240	60390



TWIST-N-SET CAST IRON CLOSET FLANGE

OATEY

Item	Pack	Part #	HDI #
Replaces broken cast iron closet flange. Gasket expands to fit service weight, heavy weight, and no hub.			
4"	2	43651	155021



CLOSET FLANGE SPACER

OATEY

Item	Pack	Part #	HDI #
1/4" spacer builds up an existing closet flange when new flooring is installed. Multiples up to three can be stacked to desired height.			
	12	43519	155019



PLUMBING & HEATING



CAST IRON OR PLASTIC PIPE COUPLING

BOSHART

Item	Pack	Part #	HDI #
Designed to connect cast iron or plastic to cast iron or plastic pipe, but will connect any two pipes. Furnished with stainless steel clamp.			
1 1/4" x 1 1/4"	30	PE56-12	124010
1 1/2" x 1 1/2"	24	PE56-15	124011
2" x 1 1/2"	18	PE56-2015	85008
2" x 2"	18	PE56-20	124013
3" x 1 1/2"	24	PE56-3015	85009
3" x 2"	24	PE56-3020	85021
3" x 3"	15	PE56-30	124015
4" x 1 1/2"	5	PE56-4015	85042
4" x 2"	24	PE56-4020	85044
4" x 3"	15	PE56-4030	124017
4" x 4"	24	PE56-40	124019
6" x 4"	9	PE56-6040	50137



TRAP DRAIN CONNECTORS

BOSHART

Item	Pack	Part #	HDI #
Designed to connect cast iron, PVC, copper, tubular pipe			
1 1/2" x 1 1/4"	20	PE06-DTC1215	124009
2" x 1 1/4"	12	PE06-DTC1220	85081



TEST PLUGS

LDR

Item	Pack	Part #	HDI #
Galvanized steel flange. Molded rubber. No-leak gasket.			
1 1/2" Bulk	10	6105390	110118
2" Bulk	10	6105400	110131
3" Bulk	10	6105410	110345
4" Bulk	10	6105420	110412



CLEANOUT OR TEST CAP

BOSHART

Item	Pack	Part #	HDI #
Quick easy way to cap pipe ends, cleanouts and open test pipes. Permanent or temporary use. Furnished with stainless steel clamp.			
1 1/2"	24	PE01-EC15	124031
2"	24	PE01-EC20	124033
3"	24	PE01-EC30	124035
4"	24	PE01-EC40	124037

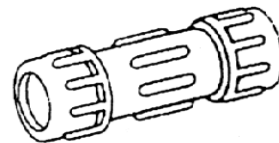

COMPRESSION COUPLING PVC

LDR

Item	Pack	Part #	HDI #
PVC body and nuts with rubber gaskets. Rated at 150 PSI Iron pipe sizes for use in any cold water piping repair application on galvanized or plastic pipe.			
1/2"	20	FPV-RCC-12	120140
3/4"	20	FPV-RCC-34	120141
1"	20	FPV-RCC-1	120142
1 1/4"	5	FPV-RCC-114	120143
1 1/2"	5	FPV-RCC-112	120144
2"	5	FPV-RCC-2	120145



DRUM TRAP COVER

LDR

Item	Pack	Part #	HDI #
Chrome plated die cast zinc with gasket			
3"	5	510-5110	85089



SCHEDULE 40 PRESSURE PIPE & FITTINGS



PVC PRESSURE PIPE SCHEDULE 40

GENOVA

Item	Pack	Part #	HDI #
Used in cold water pressure applications only, such as irrigation and sprinkler systems. Pipe and fitting sizes are the same as iron pipe sizes. 10' lengths - plain end. NSF Approved			
1/2"	5	310057	60902
3/4"	5	310077	60904
1"	5	310107	60905
1 1/4"	5	310117	60906
1 1/2"	5	70011	60907
2"	5	70021	60908



PVC PRESSURE PIPE COUPLING

GENOVA

Item	Pack	Part #	HDI #
Schedule 40 - Used to join lengths of pipe.			
1/2"	10	30105	60911
3/4"	10	30107	60920
1"	10	30110	60927
1 1/4"	10	30114	60934
1 1/2"	10	30115	60941
2"	10	30120	60948



PVC PRESSURE PIPE COUPLING THREAD

GENOVA

Item	Pack	Part #	HDI #
Schedule 40 - FIP x FIP			
1/2"	10	30125	60408
3/4"	10	30127	60410

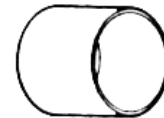

PVC PRESSURE PIPE CAP

GENOVA

Item	Pack	Part #	HDI #
Schedule 40 - Used to cap pipes.			
1/2"	10	30155	60914
3/4"	10	30157	60923
1"	10	30158	60930
1 1/4"	10	30159	60937
1 1/2"	10	30151	60944
2"	10	30152	60951



PLUMBING & HEATING

SCHEDULE 40 PRESSURE PIPE & FITTINGS



PVC PRESSURE PIPE PLUG

GENOVA

Item	Pack	Part #	IBM #
Schedule 40 - MIP. Adapts to standard female pipe threads.			
1/2"	10	31805	60981
3/4"	10	31807	60982
1"	10	31810	60983
1 1/4"	25	31814	60984



PVC PRESSURE PIPE BUSHINGS

GENOVA

Item	Pack	Part #	IBM #
Schedule 40 Spigot x Slip - Reducing bushing inserts into fitting hub to reduce to smaller size pipe			
3/4" x 1/2"	10	30275	60960
1" x 3/4"	10	30217	60964
1 1/4" x 1"	25	30240	60968
1 1/2" x 1 1/4"	10	30254	60974
2" x 1 1/2"	10	30221	60980
Schedule 40 MIP x FIP - Inserts into threaded fitting socket to reduce to smaller threaded opening.			
3/4" x 1/2"	10	34375	60987
1" x 3/4"	10	34317	60989
1 1/4" x 1"	25	34340	60992
1 1/2" x 1 1/4"	25	34354	60996
2" x 1 1/2"	10	34321	60999
Schedule 40 Spigot x FIP - Reducing bushing inserts into fitting hub to reduce to standard male pipe threads. Teflon thread tape is recommended for threaded joints.			
1 1/2" x 1 1/4"	25	34254	60703



PVC PRESSURE PIPE ADAPTERS

GENOVA

Item	Pack	Part #	IBM #
Schedule 40 Female - Slip x FIP. Adapts pressure pipe to standard male pipe threads.			
1/2"	10	30305	60910
3/4"	10	30307	60919
1"	10	30310	60926
1 1/4"	25	30314	60933
1 1/2"	10	30315	60940
2"	10	30320	60947
Schedule 40 Male - Slip x MIP. Adapts pressure pipe to standard female pipe threads.			
1/2"	10	30405	60909
3/4"	10	30407	60918
1"	10	30410	60925
1 1/4"	25	30414	60932
1 1/2"	10	30415	60939
2"	10	30420	60946



SCHEDULE 40 PRESSURE PIPE & FITTINGS



PVC PRESSURE PIPE ELBOWS

GENOVA

Item	Pack	Part #	IBM #
Schedule 40 45° Elbow - Slip x Slip. Used to change direction in piping.			
1/2"	10	30605	60913
3/4"	10	30607	60922
1"	10	30610	60929
1 1/4"	10	30614	60936
1 1/2"	10	30615	90643
2"	5	30620	60950
Schedule 40 90° Elbow - Slip x Slip. Used to change direction in piping.			
1/2"	10	30705	60912
3/4"	10	30707	60921
1"	10	30710	60928
1 1/4"	10	30714	60935
1 1/2"	10	30715	60942
2"	5	30720	60949
Schedule 40 90° Street Elbow - Slip x Spigot. Used to change direction in piping.			
1/2"	50	32905	60401
3/4"	50	32907	60402
1"	10	32910	60403
1 1/4"	25	32914	60404
1 1/2"	25	32915	60405
2"	10	32920	60406



PVC PRESSURE PIPE TEES

GENOVA

Item	Pack	Part #	IBM #
Schedule 40 - Slip x Slip x Slip. Used to provide a branch supply line from a main line.			
1/2"	10	31405	60916
3/4"	10	31407	60924
1"	10	31410	60931
1 1/4"	10	31414	60938
1 1/2"	10	31415	60945
2"	10	31420	60952

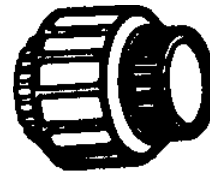

PVC PRESSURE PIPE UNION

GENOVA

Item	Pack	Part #	IBM #
Schedule 40 - Slip x Slip. This union solvent welds directly to PVC pipe and provides a method for future disassembly of piping without cutting.			
1/2"	10	37205	60953
3/4"	10	37207	60954
1"	10	37210	60955
1 1/4"	5	37214	60956
1 1/2"	5	37215	60957
2"	5	37220	60958



PLUMBING & HEATING

CPVC PIPE & FITTINGS

CPVC PIPE

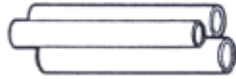

GENOVA

Item	Pack	Part #	HDI #
Used in hot and cold water pressure applications, from water main to fixtures. Sizing equals copper pipe size. 10' lengths.			
1/2"	10	50005	60104
3/4"	10	50007	60124

CPVC COUPLING



GENOVA

Item	Pack	Part #	HDI #
Slip x Slip. Used to join straight lengths of CPVC pipe.			
1/2"	20	50105	60106
3/4"	20	50107	60126

CPVC REDUCING COUPLING



GENOVA

Item	Pack	Part #	HDI #
Slip x Slip. Used to reduce from 3/4" CPVC pipe to 1/2" CPVC pipe			
3/4" x 1/2"	10	50175	60109

CPVC CAP



GENOVA

Item	Pack	Part #	HDI #
Slip. Used to permanently or temporarily cap CPVC piping.			
1/2"	10	50155	60108
3/4"	10	50157	60128

CPVC REDUCING BUSHING



GENOVA

Item	Pack	Part #	HDI #
Spigot x Slip. Used to reduce from fitting socket to CPVC pipe			
1/2" x 3/4"	10	50275	60110

CPVC FEMALE ADAPTER

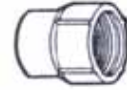

GENOVA

Item	Pack	Part #	HDI #
Slip x FIP. Used to adapt metal MIP threaded fittings to CPVC. Special gasket insures leakproof seal.			
1/2"	20	50305	60111
3/4"	10	50307	60129

CPVC MALE ADAPTER



GENOVA

Item	Pack	Part #	HDI #
MIP x Slip. Used to adapt metal FIP threaded fittings in COLD WATER APPLICATIONS ONLY. Where hot water is present, use a transition union.			
1/2"	20	50405	60112
3/4"	10	50407	60130

CPVC TEES



GENOVA

Item	Pack	Part #	HDI #
Slip x Slip x Slip. Used to provide a branch supply line from a main line.			
1/2"	20	51405	60118
3/4"	20	51407	60136
3/4" x 3/4" x 1/2"	20	51471	60137

CPVC WING ELBOW



GENOVA

Item	Pack	Part #	HDI #
Slip x FIP. Adapts 1/2" CPVC to 1/2" FIP with a special lug for fastening to wall. Solvent weld. Used on tub and shower faucets to adapt CPVC riser to shower arm. Carded.			
1/2"	10	530551	60158



PLUMBING & HEATING

CPVC PIPE & FITTINGS

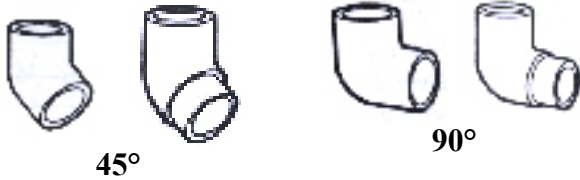

CPVC 45° & 90° ELBOWS

GENOVA

Item	Pack	Part #	HDI #
45° - Slip x Slip. Used to change direction in piping			
1/2"	20	50605	60114
3/4"	20	50607	60132
45° Street Elbow - Slip x Spigot. Used to offset piping over and around existing piping mounted on flat surfaces.			
3/4"	20	52707	60140
90° - Slip x Slip. Used to change direction in piping			
1/2"	20	50705	60116
3/4"	20	50707	60134
90° Street Elbow - Slip x Spigot. Used to change direction in piping 90° from fitting socket. Also a 3/4" x 1/2" reducing elbow			
1/2"	10	52905	60122
3/4"	10	52907	60139



CPVC UNIONS

GENOVA

Item	Pack	Part #	HDI #
Slip x Slip. Solvent welds to CPVC to provide a future method of disassembly without cutting tubing. Carded.			
1/2"	10	530211	60790
3/4"	10	530261	60795
Transition Union - Slip x Brass MIP. Designed to compensate differences in expansion when connecting CPVC and metal piping in hot water applications. Carded.			
3/4" x 3/4"	5	530501	60156



REDUCING GENOGRIP ADAPTER

GENOVA

Item	Pack	Part #	HDI #
Slip x Tubing. Solvent welds to 1/2" CPVC and adapts mechanically to 3/8" OD poly or copper tube. Used to adapt 1/2" CPVC risers through floor to 3/8" OD poly closet/lavatory risers. Carded.			
1/2" x 1/4"	10	530101	60141

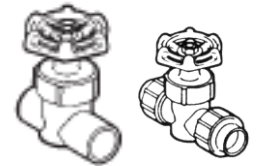

UNIVERSAL LINE VALVE

GENOVA

Item	Pack	Part #	HDI #
Slip x Slip. Solvent welds to 1/2" to 3/4" CPVC. Carded.			
	10	530151	60142
This unique valve mechanically joins water supply tubing utilizing a special locking ring and an elastomeric seal. It can be used to join PEX, copper or CPVC tubing.			
1/2"	5	540051	60845
3/4"	5	540071	60848



UNIVERSAL ANGLE SUPPLY VALVE

GENOVA

Item	Pack	Part #	HDI #
Adapts mechanically from 1/2" CPVC copper or poly tubing to 3/8" OD chromed metal or plastic supply tubes. Used where water supply piping comes through the wall.			
1/2" CPVC/Copper x 3/8" OD	10	530651	60853



PLUMBING & HEATING

UNIVERSAL FITTINGS



PEX TUBING

AMERICAN COPPER & BRASS

Item	Pack	Part #	HDI #
Red Pex Tubing - Hot			
1/2" x 100'	1	PX12RS100	120230
1/2" x 10'	10	PX12RS10	120220
3/4" x 100'	1	PX34RS100	120233
3/4" x 10'	10	PX34RS10	120225
Blue Pex Tubing - Cold			
1/2" x 100'	1	PX12BS100	120215
1/2" x 10'	10	PX12BS10	120205
3/4" x 100'	1	PX34BS100	120217
3/4" x 10'	10	PX34BS10	120210



PEX COPPER CRIMP RINGS

AMERICAN COPPER & BRASS

Item	Pack	Part #	HDI #
1/2 Ring	100	PXR3	120190
3/4 Ring	100	PXR4	120191



PEX COPPER STUB-OUT

AMERICAN COPPER & BRASS

Item	Pack	Part #	HDI #
1/2" Pex A 3 1/2" x B 8" Length Elbow	1	PXSTUB12	120196

TUBING STRAPS



GENOVA

Item	Pack	Part #	HDI #
Incorporates a special design which allows for a pipe expansion. Can be used on copper, CPVC, and PEX tubing. Nails are not included. 25 per pack. Sold Per Pack			
1/2"	25	52115	60120
3/4"	25	52117	60138



PEX & UNIVERSAL COUPLING

GENOVA

Item	Pack	Part #	HDI #
Designed to join poly, copper, or CPVC tubing. Carded			
1/2"	10	541051	60812
3/4"	10	541071	60815



PEX & UNIVERSAL ADAPTERS

GENOVA

Item	Pack	Part #	HDI #
Female FIP - Designed to adapt from metal male pipe thread to poly, copper, or CPVC tubing. Carded			
1/2"	10	543051	60830
3/4"	10	543071	60833
Male MIP - Designed to adapt from metal female pipe thread to poly, copper, or CPVC tubing. Cold Water Only. Carded			
1/2"	10	544051	60836
3/4"	10	544071	60839
Reducing Assembly - This allows any 3/4" Universal Fitting socket to be reduced to accept any 1/2" I.D., 5/8" O.D. water supply tubing, including copper and CPVC.			
3/4" - 1/2"	5	540011	60842

PEX & UNIVERSAL TEE



GENOVA

Item	Pack	Part #	HDI #
Used to provide a branch supply line from a main line. Designed to join poly, copper, or CPVC tubing. Carded			
1/2"	5	545051	60818
3/4"	5	545071	60821

PEX & UNIVERSAL 90° ELBOW



GENOVA

Item	Pack	Part #	HDI #
Used to change direction in piping. Designed to join poly, copper, or CPVC tubing. Carded.			
1/2"	5	547051	60824
3/4"	5	547071	60827



PLUMBING & HEATING

PEX FITTINGS



PLASTIC PEX CRIMP FITTINGS



BRASS PEX CRIMP FITTINGS

AMERICAN COPPER & BRASS

Item	Pack	Part #	HDI #
Tees			
1/2 Tee	5	PLXT333	120255
3/4 x 1/2 Tee	5	PLXT443	120256
3/4 Tee	5	PLXT444	120257
Elbows			
1/2 Elbow	5	PLXE33	120244
3/4 Elbow	5	PLXE44	120245
1/2 Male Elbow	5	PLXME33	120246
Couplings			
1/2 Coupling	5	PLXC33	120241
3/4 x 1/2 Coupling	5	PLXC43	120242
3/4 Coupling	5	PLXC44	120243
Female Adapters			
1/2 Female Adapter	5	PLXSW33	120253
3/4 Female Adapter	5	PLXSW44	120254
Male Adapters			
1/2 Male Adapter	5	PLXMA33	120247
1/2 x 3/4 MPT Adapter	5	PLXMA34	120248
3/4 x 1/2 MPT Adapter	5	PLXMA43	120249
3/4 Male Adapter	5	PLXMA44	120250
Test Plugs			
1/2 Test Plug	5	PLXP3	120251
3/4 Test Plug	5	PLXP4	120252

AMERICAN COPPER & BRASS

Item	Pack	Part #	HDI #
Tees			
1/2 Barb Tee	5	PXT333	120170
3/4 x 3/4 x 1/2 Barb Tee	5	PXT443	120171
3/4 Barb Tee	5	PXT444	120172
Elbows			
1/2 Barb Elbow	5	PXE33	120173
3/4 Barb Elbow	5	PXE44	120174
1/2 Barb x 1/2 MPT Elbow	5	PXE33BT	120175
1/2 Barb x 1/2 FPT Drop Elbow	5	PXE33DE	120176
Couplings			
1/2 Barb Coupling	5	PXC33	120177
3/4 x 1/2 Barb Coupling	5	PXC43	120178
3/4 Barb Coupling	5	PXC44	120179
Female Adapters			
1/2 Barb x 1/2 FPT Adapter	5	PXNS33BT	120180
3/4 Barb x 3/4 FPT Adapter	5	PXNS44BT	120181
Male Adapters			
1/2 Barb x 1/2 MPT Adapter	5	PXA33BT	120182
1/2 Barb x 3/4 MPT Adapter	5	PXA34BT	120183
3/4 Barb x 1/2 MPT Adapter	5	PXA43BT	120184
3/4 Barb x 3/4 MPT Adapter	5	PXA44BT	120185
Poly Pipe X Pex Transition Coupling			
1/2 PB x 1/2 PEX Coupling	5	PXBC33	120186
3/4 PB x 3/4 PEX Coupling	5	PXBC44	120187
Test Plugs			
1/2 Test Plug	5	PXP3	120188
3/4 Test Plug	5	PXP4	120189



PLUMBING & HEATING

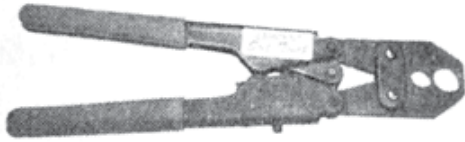

PEX CRIMP TOOLS

AMERICAN COPPER & BRASS

Item	Pack	Part #	HDI #
1/2" Pex Crimp Tool	1	69PTKH00143	120235
3/4" Pex Crimp Tool	1	69PTKH00144	120240



PEX BARBED VALVES

AMERICAN COPPER & BRASS

Item	Pack	Part #	HDI #
Ball Valves			
1/2 x 1/2 Barb Ball Value	10	PXV33	120192
3/4 x 3/4 Barb Ball Valve	10	PXV44	120193
Chrome Ball-Type Stop Valve			
1/2" PEX x 3/8 Comp Angle Valve	1	BVA20	120194
1/2 Pex x 3/8 Comp Straight Valve	1	BVS20	120195



PEX COPPER MANIFOLDS

AMERICAN COPPER & BRASS

Item	Pack	Part #	HDI #
3/4"PEX x 1/2 PEX 3-Port Manifold	1	PXMAN-3	120197
3/4"PEX x 1/2 PEX 4-Port Manifold	1	PXMAN-4	120198
3/4"PEX x 1/2 PEX 5-Port Manifold	1	PXMAN-5	120199
3/4"Pex x 1/2 PEX 8-Port Manifold	1	PXMAN-8	120200

POLYETHYLENE FLEXIBLE PLASTIC PIPE



SPARTAN

Item	Pack	Part #	HDI #
For irrigation and non-potable applications.			
100' Roll			
1" - 80#	1	21020	50007
2" - 80#	1	21060	50016
300' Roll			
1" - 80#	1	21025	50006
1 1/4" - 80#	1	21040	50003

CRESLINE

Item	Pack	Part #	HDI #
National Sanitation Approved (NSF) for the transmission of potable water and other liquids for human and animal consumption. Will not rust, rot, or cause electrolytic corrosion. ASTMD2239-PE3408			
100' Roll			
1/2" - 125#	1	18201	50019
3/4" - 100#	1	18315	50022
1" - 100#	1	18335	50025
1 1/4" - 100#	1	18355	50028
1 1/2" - 100#	1	18375	50031

PLASTIC PIPE CUTTER

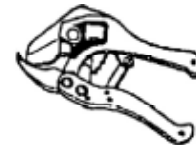

BOSHART

Item	Pack	Part #	HDI #
For up to 1 1/4" OD PVC, CPVC, plastic and rubber tube. Carded.			
	10	PE-PC12	86577

BOSHART



Item	Pack	Part #	HDI #
Ergo Poly Pipe Cutter 1" Capacity			
	10	PE-PC10	800111



PLUMBING & HEATING



25 PIECE CONTRACTOR ALL STAINLESS STEEL HOSE CLAMP PACKS

IDEAL

Item	Pack	Part #	HDI #
Packs come in all stainless steel, Uniform Plumber Code (UPC) Certified, and designed with the contractor or big jobs in mind. Durable resealable bag for future use and easy accessibility. Made in the U.S.A.			
7/32" to 7/8" SS Clamp Hose	10	6260450	50350
5/16" to 7/8" SS Clamp Hose	10	6260650	50351
3/8" x to 7/8" SS Clamp Hose	10	6706550	50352
7/16" to 1" SS Clamp Hose	10	6708550	50353
9/16" to 1-1/16" SS Clamp Hose	10	6710550	50354
9/16" to 1-1/4" SS Clamp Hose	10	6712550	50355
11/16" to 1-1/2" SS Clamp Hose	10	6716550	50356
3/4" to 1-3/4" SS Clamp Hose	10	6720550	50357
1 1/16" to 2" SS Clamp Hose	10	6724550	50358
1-5/16" to 2-1/4" SS Clamp Hose	10	6728550	50359

1-EAR CLAMPS WITH MECHANICAL INTERLOCK



IDEAL

Item	Pack	Part #	HDI #
Narrow band, lightweight, fast, simple and secure installation. Economical, quality clamp for low-pressure applications. Stainless Steel Band			
Range: .945 - 1.067" Spartan 3/4"/100#	100	61271-5B	50404
Range: 1.181 - 1.303" Spartan 1"/80# & 100# Cresline 1"	100	61331-5B	50406
Range: 1.551 - 1.673" Spartan 1 1/4"/100#	100	61425-5B	50408

INSTALLATION TOOL



IDEAL

Item	Pack	Part #	HDI #
	1	61001-58	50412

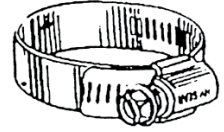

WORM GEAR CLAMP

IDEAL

Item	Pack	Part #	HDI #
Use with flexible plastic pipe to make leakproof connections. Clamps have 5/16 slotted hex/ screw. Micro clamps have 1/4 slotted hex screw. Pipe Size x Min Open x Max Open			
Stainless Band & Screw			
Micro x 1/4 x 5/8	10	62604	50038
Mirco x 1/4 x 7/8	10	62606	50039
1/2 x 1/4 x 25/32	10	6706-1	50041
1/2 x 1/2 x 1 1/16	10	6708-1	50042
1/2 - 3/4 x 9/16 x 1 1/16	10	6710-1	50044
1/2 - 3/4 x 11/16 x 1 1/4	10	6712-1	50045
3/4 - 1 x 13/16 x 1 1/2	10	6716-1	50047
1 - 1 1/4 x 13/16 x 1 3/4	10	6720-1	50048
1 1/4 - 1 1/2 x 1 1/16 x 2	10	6724-1	50050
1 1/2 x 1 5/16 x 2 1/4	10	6728-1	50065
2 x 1 9/16 x 2 1/2	10	6732-1	50068
2 x 1 13/16 x 2 3/4	10	6736-1	50071
2 - 2 1/2 x 2 1/16 x 3	10	6740-1	50074
2 - 2 1/2 x 2 9/16 x 3 1/2	10	6748-1	50077
3 x 3 1/16 x 4	10	6756-1	50080
3 x 3 9/16 x 4 1/2	10	6764-1	50083
4 x 4 1/16 x 5	10	6772-1	50086
6 x 6 1/8 x 7	10	6799-1	50089
Combination Plated Screw w/Stainless Steel Band			
Micro x 1/4 x 5/8	10	6204	50037
Mirco x 1/4 x 7/8	10	6206	50040
1/2 x 1/4 x 25/32	10	5706	50043
1/2 x 1/2 x 1 1/16	10	5708	50046
1/2 - 3/4 x 9/16 x 1 1/16	10	5710	50049
1/2 - 3/4 x 11/16 x 1 1/4	10	5712	50052
3/4 - 1 x 13/16 x 1 1/2	10	5716	50055
1 - 1 1/4 x 13/16 x 1 3/4	10	5720	50058
1 1/4 - 1 1/2 x 1 1/16 x 2	10	5724	50061
1 1/2 x 1 5/16 x 2 1/4	10	5728	50064
2 x 1 9/16 x 2 1/2	10	5732	50067
2 x 1 13/16 x 2 3/4	10	5736	50070
2 - 2 1/2 x 2 1/16 x 3	10	5740	50073
2 - 2 1/2 x 2 9/16 x 3 1/2	10	5748	50076
3 x 3 1/16 x 4	10	5756	50079
3 x 3 9/16 x 4 1/2	10	5764	50082
4 x 4 1/16 x 5	10	5772	50085
6 x 6 1/8 x 7	10	57104	50088



PLUMBING & HEATING

MALE ADAPTERS



BOSHART

Item	Pack	Part #	HDI #
MIP x Insert.			
Plastic - Made from PVC			
1/2"	50	75003	50127
3/4" x 1/2"	50	75093	50145
3/4"	50	75005	50130
1/2" x 3/4"	50	75140	50146
1"	50	75007	50133
1" x 1 1/4"	25	75151	50135
1 1/4"	20	75009	50136
1 1/2"	25	75011	50139
2"	10	75013	50142
Galvanized Steel - No Lead			
1/2"	25	MAS-050	50091
3/4"	25	MAS-075	50094
1"	20	MAS-100	50097
1 1/4"	20	MAS-125	50100
1 1/2"	10	MAS-150	50103
2"	10	MAS-200	50106



FEMALE ADAPTERS

BOSHART

Item	Pack	Part #	HDI #
Insert x FIP			
Plastic - Made from PVC			
1/2"	50	75190	50234
3/4"	50	75192	50237
1"	50	75194	50240

COUPLING



BOSHART

Item	Pack	Part #	HDI #
Insert x Insert			
Plastic - Made from PVC			
1/2"	50	75023	50148
3/4"	50	75025	50151
1"	50	75027	50154
1 1/4"	25	75030	50157
1 1/2"	25	75032	50160
2"	10	75035	50163
Galvanized Steel - No Lead			
1/2"	30	CS-050	50109
3/4"	30	CS-075	50112
1"	20	CS-100	50115
1 1/4"	20	CS-125	50118
1 1/2"	10	CS-150	50121
2"	10	CS-200	50124



REDUCING COUPLING

BOSHART

Item	Pack	Part #	HDI #
Insert x Insert			
Plastic - Made from PVC			
3/4" x 1/2"	50	75500	50166
1" x 3/4"	50	75510	50172
1 1/4" x 3/4"	25	75512	50175
1 1/4" x 1"	25	75516	50178
1 1/2" x 1"	25	75518	50181
1 1/2" x 1 1/4"	25	75522	50183
2" x 1 1/2"	10	75526	50185



PLUMBING & HEATING

TEE



Item	Pack	Part #	HDI #
Insert x Insert x Insert			
Plastic - Made from PVC			
1/2"	50	75049	50261
3/4"	50	75051	50264
1"	25	75053	50267
1 1/4"	10	75055	50270
1 1/2"	10	75057	50273
2"	10	75059	50276

REDUCING TEE



Item	Pack	Part #	HDI #
Insert x Insert x Insert			
Plastic - Made from PVC			
3/4" x 3/4" x 1/2"	25	75211	50324
1" x 3/4" x 3/4"	25	75215	50326
1" x 1" x 1/2"	25	75217	50327
1" x 1" x 3/4"	25	75219	50330
1 1/4" x 1 1/4" x 3/4"	25	75225	50336
1 1/4" x 1 1/4" x 1"	25	75227	50339

COMBINATION TEE / REDUCING COMBINATION TEE



Item	Pack	Part #	HDI #
Insert x Insert x FiP			
Plastic - Made from PVC			
Combination Tee			
1/2" x 1/2" x 1/2"	50	75280	50279
3/4" x 3/4" x 3/4"	50	75286	50285
1" x 1" x 1"	25	75296	50294
Reducing Comb. Tee			
3/4" x 3/4" x 1/2"	25	75284	50282
1" x 1" x 1/2"	25	75292	50288
1" x 1" x 3/4"	25	75294	50291
1 1/4" x 1 1/4" x 1/2"	25	75303	50297
1 1/4" x 1 1/4" x 3/4"	25	75305	50300
1 1/4" x 1 1/4" x 1"	25	75307	50303
1 1/2" x 1 1/2" x 1/2"	10	75319	50306
1 1/2" x 1 1/2" x 3/4"	10	75321	50309
1 1/2" x 1 1/2" x 1"	10	75323	50312

PLUG

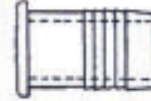

Item	Pack	Part #	HDI #
Insert			
Plastic - Made from PVC			
1/2"	100	75564	50243
3/4"	100	75566	50246
1"	50	75568	50249
1 1/4"	25	75570	50252
1 1/2"	25	75572	50255
2"	10	75574	50258

ELBOW

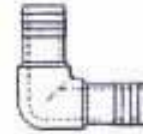

Item	Pack	Part #	HDI #
Insert x Insert			
Plastic - Made from PVC			
1/2"	50	75070	50186
3/4"	50	75072	50189
1"	25	75075	50192
1 1/4"	10	75077	50195
1 1/2"	10	75079	50198
2"	10	75081	50201

COMBINATION / REDUCING ELBOW



Item	Pack	Part #	HDI #
Insert x FiP			
Plastic - Made from PVC			
1/2" x 1/2"	50	75425	50204
3/4" x 1/2"	50	75427	50207
3/4" x 3/4"	50	75453	50210
1" x 1/2"	25	75431	50213
1" x 3/4"	25	75455	50216
1" x 1"	25	75463	50219
1 1/4" x 1/2"	25	75437	50222
1 1/4" x 3/4"	25	75457	50225
1 1/2" x 1 1/2"	10	75475	50231



PLUMBING & HEATING

CUTOFF RISER



Item	Pack	Part #	HDI #
Polyethylene MPT x MPT. May be cut to desired length - 3 to 6 inches.			
1/2"	50	37069D	800290
3/4"	25	37113	50347
1/2" x 3/4"	40	37114	50349

EXTENSION ADAPTER



Item	Pack	Part #	HDI #
1/2" X 3/4" Mnpt Poly Adapter	50	37217	125096



Swing Pipe



Swing Pipe Fittings

SWING PIPE & FITTINGS

Item	Pack	Part #	HDI #
Swing Pipe & Fittings			
3/4" MPT x Insert Elbow	50	37162	125067
1/2" MPT x Insert Elbow	50	37159	125068
1/2" Fnpt x Barb 90 Elbow; Dbx	50	37259	125100
1/2" Mnpt x Barb Adapter	50	37160	125090
3/4" Mnpt x 1/2" Barb Adapter	25	37161	125092
1/2" Fnpt x Barb Adapter	25	37260	125132
1/2" Barb Coupling	25	37165	125088
1/2" Barb Tee	25	37166	125094
Riser-Flex Pipe			
1/2" x 24" Riser Flex Pipe	24	37151	125134
37154 - 1/2" x 100' Riser Flex Pipe	1	SPX-FLEX100	125066

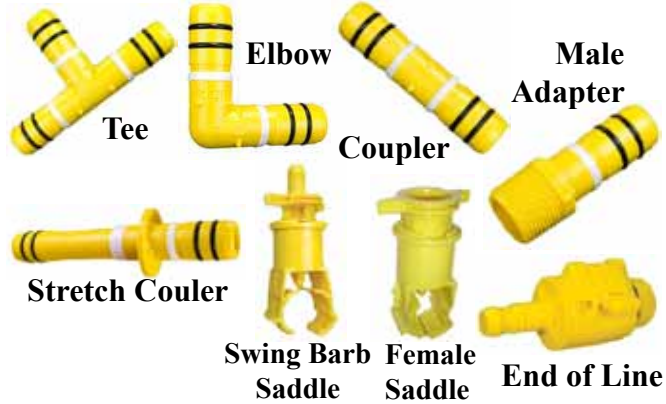

BLAZING FITTINGS

Item	Pack	Part #	HDI #
Blazing Fast Fittings require no tools, clamps, or other materials. Slips into the pipe quickly and easily. Patented lock ring technology slides back to lock the fittings into place. Double O-Ring seal prevents leaks and provides a secure fit. Tested in the field by contractors for over a year, Blazing Fast Fittings are ready for your next installation. Not for use with Pipe Dope (causes stress cracking/deterioration). Use Teflon Tape on threaded connections.			
Blazing Fast Fittings			
1" Tee	5	BLZ1401-010	125001
1" Elbow	5	BLZ1406-010	125002
1" Coupler	5	BLZ1429-010	125003
1" Male Adapter	5	BLZ1436-010	125004
1" Stretch Coupler	5	BLZPSC-010	125005
1" x Swing Barb End of Line	5	EL1009	125064
Blazing Saddles			
3/4" x Swing Pipe Barb	1	BS4000	125006
3/4" x 1/2" FIPT	1	BS5000	125008
3/4" x 3/4" FIPT	1	BS6000	125026
1" x 3/4" FIPT	1	BS8000	125029
1 1/4" x 3/4" FIPT	1	BS12750	125062
1 1/4" x Swing Pipe Barb	1	BS12900	125063



PLUMBING & HEATING



BLACK STEEL PIPE

10' lengths. Standard weight.
Threaded both ends.

1/2"
(100100) 314 12x120

3/4"
(100105) 314 34x120
pk 5

1"
(100110) 314 1x120
pk 1

Cut Length

Threaded both ends

1/2 x 18"
(100159) 306 12x18

1/2 x 24"
(100160) 306 12x24

1/2 x 36"
(100163) 306 12x36

1/2 x 48"
(100165) 306 12x48

1/2 x 60"
(100166) 306 12x60

1/2 x 72"
(100167) 306 12x72

3/4 x 18"
(100170) 306 34x18

3/4 x 24"
(100175) 306 34x24

3/4 x 36"
(100180) 306 34x36

3/4 x 48"
(100185) 306 34x48

3/4 x 60"
(100190) 306 34x60

3/4 x 72"
(100195) 306 34x72
pk 5



GALVANIZED STEEL PIPE

10' lengths Standard weight.
Threaded both ends.

1/2"
(100130) 315 12x120

3/4"
(100135) 315 34x120
pk 5

1"
(100140) 315 1x120

1 1/4"
(100145) 315 114x120

1 1/2"
(100150) 315 112x120
pk 3

2"
(100155) 315 2x120
pk 2

Cut Lengths

Threaded both ends

1/2 x 18"
(100200) 307 12x18

1/2 x 24"
(100205) 307 12x24

1/2 x 36"
(100210) 307 12x36

1/2 x 48"
(100215) 307 12x48

1/2 x 60"
(100220) 307 12x60

1/2 x 72"
(100225) 307 12x72

3/4 x 18"
(100230) 307 34x18

3/4 x 24"
(100235) 307 34x24

3/4 x 36"
(100240) 307 34x36

3/4 x 48"
(100245) 307 34x48

3/4 x 60"
(100250) 307 34x60

3/4 x 72"
(100255) 307 34x72
pk 5



PLUMBING & HEATING

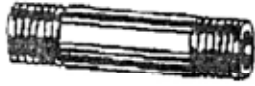

1/8" STANDARD PIPE NIPPLE

GALVANIZED

(110001)	CLOSE
(110002)	1 1/2"
(110003)	2"
(110004)	2 1/2"
(110005)	3"
(110006)	3 1/2"
(110007)	4"
(110008)	4 1/2"
(110009)	5"
(110010)	5 1/2"
(110011)	6"

pk 10

BLACK

(110520)	CLOSE
(110521)	1 1/2"
(110522)	2"
(110523)	2 1/2"
(110524)	3"
(110525)	3 1/2"
(110526)	4"
(110527)	4 1/2"
(110528)	5"
(110529)	5 1/2"
(110530)	6"

pk 10



1/4" STANDARD PIPE NIPPLE

GALVANIZED

(110012)	CLOSE
(110013)	1 1/2"
(110014)	2"
(110015)	2 1/2"
(110016)	3"
(110017)	3 1/2"
(110018)	4"
(110019)	4 1/2"
(110020)	5"
(110021)	5 1/2"
(110022)	6"

pk 10

BLACK

(110540)	CLOSE
(110541)	1 1/2"
(110542)	2"
(110543)	2 1/2"
(110544)	3"
(110545)	3 1/2"
(110546)	4"
(110547)	4 1/2"
(110548)	5"
(110549)	5 1/2"
(110550)	6"

pk 10

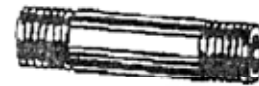

3/8" STANDARD PIPE NIPPLE

GALVANIZED

(110023)	CLOSE
(110024)	1 1/2"
(110025)	2"
(110026)	2 1/2"
(110027)	3"
(110028)	3 1/2"
(110029)	4"
(110030)	4 1/2"
(110031)	5"
(110032)	5 1/2"
(110033)	6"

pk 10

BLACK

(110500)	CLOSE
(110501)	1 1/2"
(110502)	2"
(110503)	2 1/2"
(110504)	3"
(110505)	3 1/2"
(110506)	4"
(110507)	4 1/2"
(110508)	5"
(110509)	5 1/2"
(110510)	6"

pk 10

pk 10



PLUMBING & HEATING



1/2" STANDARD PIPE NIPPLE

GALVANIZED

(110037)	CLOSE
(110038)	1 1/2"
(110039)	2"
(110041)	2 1/2"
(110042)	3"
(110043)	3 1/2"
(110044)	4"
(110045)	4 1/2"
(110046)	5"
(110047)	5 1/2"
(110048)	6"
(110049)	7"
(110050)	8"
(110051)	9"
(110052)	10"
(110053)	11"
(110054)	12"

pk 25

BLACK

(110135)	CLOSE
(110136)	1 1/2"
(110137)	2"
(110138)	2 1/2"
(110139)	3"
(110140)	3 1/2"
(110141)	4"
(110142)	4 1/2"
(110143)	5"
(110199)	5 1/2"
(110144)	6"
(110145)	7"
(110146)	8"
(110147)	9"
(110148)	10"
(110149)	11"
(110150)	12"

pk 25



3/4" STANDARD PIPE NIPPLE

GALVANIZED

(110055)	CLOSE
(110056)	1 1/2"
(110057)	2"
(110058)	2 1/2"
(110059)	3"
(110060)	3 1/2"
(110061)	4"
(110062)	4 1/2"
(110063)	5"
(110064)	5 1/2"
(110065)	6"
(110066)	7"
(110067)	8"
(110068)	9"
(110069)	10"
(110070)	11"
(110071)	12"

pk 25

BLACK

(110151)	CLOSE
(110152)	1 1/2"
(110153)	2"
(110154)	2 1/2"
(110155)	3"
(110156)	3 1/2"
(110157)	4"
(110158)	4 1/2"
(110159)	5"
(110160)	5 1/2"
(110161)	6"
(110162)	7"
(110163)	8"
(110164)	9"
(110165)	10"
(110166)	11"
(110167)	12"

pk 25



1" STANDARD PIPE NIPPLE

GALVANIZED

(110072)	CLOSE
(110073)	2"
(110074)	2 1/2"
(110075)	3"
(110076)	3 1/2"
(110077)	4"
(110078)	4 1/2"
(110079)	5"
(110080)	5 1/2"
(110081)	6"
(110082)	7"
(110083)	8"
(110084)	9"
(110085)	10"
(110086)	11"
(110087)	12"

pk 10

BLACK

(110168)	CLOSE
(110169)	2"
(110170)	2 1/2"
(110171)	3"
(110172)	3 1/2"
(110173)	4"
(110174)	4 1/2"
(110175)	5"
(110176)	5 1/2"
(110177)	6"
(110178)	7"
(110179)	8"
(110180)	9"
(110181)	10"
(110182)	11"
(110183)	12"

pk 10



PLUMBING & HEATING

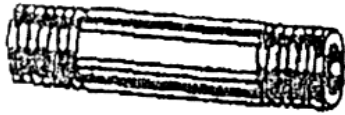

1 1/4" STANDARD PIPE NIPPLE

GALVANIZED

(110088)	CLOSE
(110089)	2"
(110090)	2 1/2"
(110091)	3"
(110092)	3 1/2"
(110093)	4"
(110094)	4 1/2"
(110095)	5"
(110096)	5 1/2"
(110097)	6"
(110098)	7"
(110099)	8"
(110100)	9"
(110101)	10"
(110102)	11"
(110103)	12"

pk 5

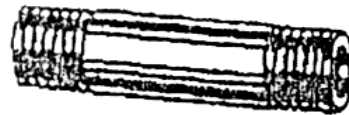

1 1/2" STANDARD PIPE NIPPLE

GALVANIZED

(110104)	CLOSE
(110105)	2"
(110106)	2 1/2"
(110107)	3"
(110108)	3 1/2"
(110109)	4"
(110110)	4 1/2"
(110111)	5"
(110112)	5 1/2"
(110113)	6"
(110114)	7"
(110115)	8"
(110116)	9"
(110117)	10"
(110119)	12"

pk 5

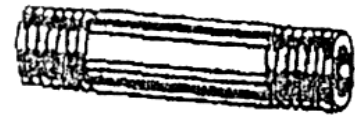

2" STANDARD PIPE NIPPLE

GALVANIZED

(110120)	CLOSE
(110121)	2 1/2"
(110122)	3"
(110123)	3 1/2"
(110124)	4"
(110125)	4 1/2"
(110126)	5"
(110127)	5 1/2"
(110128)	6"
(110129)	7"
(110130)	8"
(110132)	10"
(110133)	11"
(110134)	12"

pk 5



PLUMBING & HEATING

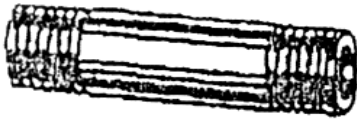

SCHEDULE 80 PVC NIPPLE

Cresline

1/2 x Close	
(50501)	86501
1/2 x 1 1/2	
(50502)	86503
1/2 x 3	
(50503)	86505
1/2 x 4	
(50504)	86507
1/2 x 5	
(50505)	86508
1/2 x 6	
(50506)	86509
1/2 x 8	
(50507)	86511
1/2 x 12	
(50508)	86513
pk 1	
Genova	
1/2 x 18	
(50520)	3403180
pk 25	
1/2 x 24	
(50521)	3403240
1/2 x 36	
(50522)	3403360
1/2 x 48	
(50523)	3403480
pk 10	

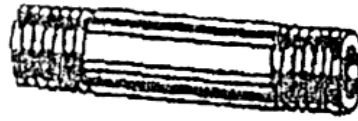

SCHEDULE 80 PVC NIPPLE

Cresline

3/4 x Close

(50511)	86525
3/4 x 2	
(50512)	86527
3/4 x 3	
(50513)	86529
3/4 x 4	
(50514)	86531
3/4 x 5	
(50515)	86532
3/4 x 6	
(50516)	86533
3/4 x 8	
(50517)	86535
3/4 x 12	
(50518)	384120
3/4 x 18	
(50525)	3404180
3/4 x 24	
(50526)	3404240
3/4 x 36	
(50527)	3404360
3/4 x 48	
(50528)	3404480
pk 1	



PLUMBING & HEATING



HEX REDUCING
BUSHING MALLEABLE

GALVANIZED

(110201) 1/4 X 1/8
pk 25

(110202) 3/8 X 1/8

(110204) 3/8 X 1/4
pk 10

(110205) 1/2 X 1/8

(110206) 1/2 X 1/4

(110208) 1/2 X 3/8

(110209) 3/4 X 1/8

(110210) 3/4 X 1/4

(110212) 3/4 X 3/8

(110214) 3/4 X 1/2
pk 25

BLACK

(110200) 1/4 X 1/8
pk 25

(110203) 3/8 X 1/4
pk 10

(110454) 1/2 X 1/4

(110207) 1/2 X 3/8

(110444) 3/4 X 1/4

(110211) 3/4 X 3/8

(110213) 3/4 X 1/2
pk 25



HEX REDUCING
BUSHING MALLEABLE

GALVANIZED

(110215) 1 X 1/4

(110216) 1 X 3/8

(110218) 1 X 1/2

(110220) 1 X 3/4
pk 10

(110221) 1 1/4 X 1/4

(110222) 1 1/4 X 3/8

(110223) 1 1/4 X 1/2

(110225) 1 1/4 X 3/4

(110227) 1 1/4 X 1

(110228) 1 1/2 X 1/2

(110229) 1 1/2 X 3/4

(110231) 1 1/2 X 1

(110232) 1 1/2 X 1 1/4

(110233) 2 X 1/2

(110234) 2 X 3/4

(110235) 2 X 1

(110236) 2 X 1 1/4

(110238) 2 X 1 1/2
pk 5

BLACK

(110217) 1 X 1/2

(110219) 1 X 3/4
pk 10

(110446) 1 1/4 X 1/4

(110224) 1 1/4 X 3/4

(110226) 1 1/4 X 1

(110230) 1 1/2 X 1

(110237) 2 X 1 1/2
pk 5



PIPE CAPS
MALLEABLE

GALVANIZED

(110239) 1/8

(110241) 1/4

(110242) 3/8
pk 10

(110244) 1/2

(110246) 3/4
pk 25

(110248) 1

pk 10

(110250) 1 1/4

(110252) 1 1/2

(110254) 2
pk 5

BLACK

(110435) 1/8

(110240) 1/4

(110368) 3/8
pk 10

(110243) 1/2

(110245) 3/4
pk 25

(110247) 1

pk 10

(110249) 1 1/4

(110251) 1 1/2

(110253) 2
pk 5



PLUMBING & HEATING

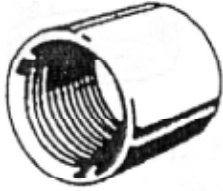

**MERCHANT
COUPLING**

GALVANIZED

(110260)	1/8
(110261)	1/4
(110263)	3/8
<hr/>	
pk 10	
(110265)	1/2
(110267)	3/4
<hr/>	
pk 25	
(110269)	1
<hr/>	
pk 10	
(110271)	1 1/4
(110273)	1 1/2
(110275)	2
<hr/>	
pk 5	
BLACK	
(110466)	1/8
(110468)	1/4
(110262)	3/8
<hr/>	
pk 10	
(110264)	1/2
(110266)	3/4
<hr/>	
pk 25	
(110268)	1
<hr/>	
pk 10	
(110270)	1 1/4
(110272)	1 1/2
(110274)	2
<hr/>	
pk 5	

**REDUCING
COUPLING**
Malleable

GALVANIZED

(110276)	1/4 X 1/8
(110277)	3/8 X 1/8
(110279)	3/8 X 1/4
<hr/>	
pk 10	
(110280)	1/2 X 1/8
(110281)	1/2 X 1/4
(110283)	1/2 X 3/8
(110456)	3/4 X 1/8
(110284)	3/4 X 1/4
(110285)	3/4 X 3/8
(110287)	3/4 X 1/2
<hr/>	
pk 25	
(110288)	1 X 3/8
(110290)	1 X 1/2
(110292)	1 X 3/4
<hr/>	
pk 10	
(110293)	1 1/4 X 1/2
(110294)	1 1/4 X 3/4
(110296)	1 1/4 X 1
(110297)	1 1/2 X 3/4
(110298)	1 1/2 X 1
(110299)	1/2 X 1 1/4
(110300)	2 X 1
(110301)	2 X 1 1/4
(110302)	2 X 1 1/2
<hr/>	
pk 5	

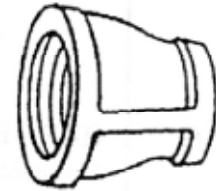

BLACK

(110278)	3/8 X 1/4
<hr/>	
pk 10	
(110282)	1/2 X 3/8
<hr/>	
pk 25	
(110286)	3/4 X 1/2
(110289)	1 X 1/2
(110291)	1 X 3/4
<hr/>	
pk 10	
(110295)	1 1/4 X 1
<hr/>	
pk 5	



PLUMBING & HEATING



**CROSS
MALLEABLE**

GALVANIZED

(110255)	1/2
(110256)	3/4
(110257)	1
<hr/>	
pk 10	

(110258)	1 1/4
(110259)	1 1/2
<hr/>	
pk 5	



**45° ELBOW
MALLEABLE**

GALVANIZED

(110460)	1/8
(110320)	1/4
(110322)	3/8
<hr/>	
pk 10	

(110324)	1/2
(110326)	3/4
<hr/>	
pk 25	

(110328)	1
<hr/>	
pk 10	

(110330)	1 1/4
(110332)	1 1/2
<hr/>	
pk 5	

(110333)	2
<hr/>	
pk 4	

BLACK

(110440)	1/8
(110319)	1/4
(110321)	3/8
<hr/>	
pk 10	

(110323)	1/2
(110325)	3/4
<hr/>	
pk 25	

(110327)	1
<hr/>	
pk 10	

(110329)	1 1/4
<hr/>	
pk 5	

(110470)	2
<hr/>	
pk 4	

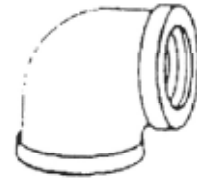

**90° ELBOW
MALLEABLE**

GALVANIZED

(110303)	1/8
(110304)	1/4
(110306)	3/8
<hr/>	
pk 10	

(110308)	1/2
(110310)	3/4
<hr/>	
pk 25	

(110312)	1
<hr/>	
pk 10	

(110314)	1 1/4
(110316)	1 1/2
(110318)	2
<hr/>	
pk 5	

BLACK

(110472)	1/8
(110439)	1/4
(110305)	3/8
<hr/>	
pk 10	

(110307)	1/2
(110309)	3/4
<hr/>	
pk 25	

(110311)	1
<hr/>	
pk 10	

(110313)	1 1/4
(110315)	1 1/2
<hr/>	
pk 5	

(110317)	2
<hr/>	
pk 5	



PLUMBING & HEATING

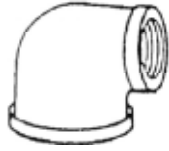

90° REDUCING ELBOW
MALLEABLE

GALVANIZED

(110340)	$\frac{3}{4}$ X $\frac{1}{2}$
pk 25	
(110343)	1 X $\frac{3}{4}$
pk 10	
(110344)	1 $\frac{1}{4}$ X 1
pk 5	

BLACK

(110334)	$\frac{3}{8}$ X $\frac{1}{4}$
(110337)	$\frac{1}{2}$ X $\frac{3}{8}$
(110339)	$\frac{3}{4}$ X $\frac{1}{2}$
pk 25	
(110341)	1 X $\frac{1}{2}$
pk 10	
(110458)	1 $\frac{1}{4}$ X 1
pk 5	

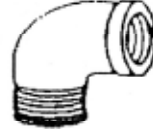

90° STREET ELBOW
MALLEABLE

GALVANIZED

(110346)	$\frac{1}{8}$
(110348)	$\frac{1}{4}$
(110350)	$\frac{3}{8}$
pk 10	
(110352)	$\frac{1}{2}$
(110354)	$\frac{3}{4}$
pk 25	
(110356)	1
pk 10	
(110358)	1 $\frac{1}{4}$
(110360)	1 $\frac{1}{2}$
pk 5	
(110362)	2
pk 4	

BLACK

(110474)	$\frac{1}{8}$
(110347)	$\frac{1}{4}$
(110349)	$\frac{3}{8}$
pk 10	
(110351)	$\frac{1}{2}$
(110353)	$\frac{3}{4}$
pk 25	
(110355)	1
pk 10	
(110357)	1 $\frac{1}{4}$
(110359)	1 $\frac{1}{2}$
pk 5	
(110361)	2
pk 4	



45° STREET ELBOW
MALLEABLE

GALVANIZED

(110364)	$\frac{1}{2}$
(110365)	$\frac{3}{4}$
pk 25	
(110366)	1
pk 10	
(110367)	1 $\frac{1}{4}$
pk 5	

BLACK

(110476)	$\frac{1}{2}$
(110478)	$\frac{3}{4}$
pk 25	
(110480)	1
pk 10	



PLUMBING & HEATING

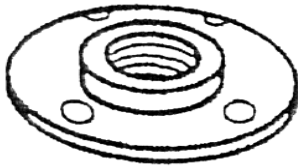

FLOOR FLANGE

Cast Iron

GALVANIZED

(110492) 1/2
(110493) 3/4
pk 25

(110494) 1
pk 10

(110495) 1 1/4
(110496) 1 1/2
(110497) 2
pk 5

BLACK

(110370) 1/2
(110371) 3/4
pk 25

(110372) 1
pk 10

(110373) 1 1/4
(110374) 1 1/2
(110375) 2
pk 5

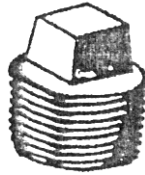

PIPE PLUG

Cast Iron

GALVANIZED

(110376) 1/8
(110377) 1/4
(110379) 3/8
pk 10

(110381) 1/2
(110383) 3/4
pk 25

(110385) 1
pk 10

(110387) 1 1/4
(110389) 1 1/2
(110391) 2
pk 5

BLACK

(110457) 1/8
(110484) 1/4
(110378) 3/8
pk 10

(110380) 1/2
(110382) 3/4
pk 25

(110384) 1
pk 10

(110386) 1 1/4
(110388) 1 1/2
pk 5

(110390) 2
pk 4

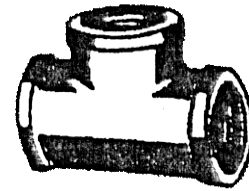

TEE

Malleable

GALVANIZED

(110392) 1/8
(110393) 1/4
(110395) 3/8
pk 10

(110397) 1/2
(110399) 3/4
pk 25

(110401) 1
pk 10

(110403) 1 1/4
(110405) 1 1/2
pk 5

(110407) 2
pk 4

BLACK

(110486) 1/8
(110488) 1/4
(110394) 3/8
pk 10

(110396) 1/2
(110398) 3/4
pk 25

(110400) 1
pk 10

(110402) 1 1/4
(110404) 1 1/2
pk 5

(110406) 2
pk 4



PLUMBING & HEATING



**REDUCING TEE
MALLEABLE**

GALVANIZED

(110411) 3/4 X 3/4 X 1/2
pk 25

(110413) 1 X 1 X 3/4
pk 10

BLACK

(110459) 3/8 X 3/8 X 1/4
pk 25

(110414) 1 X 1 X 3/4
pk 10

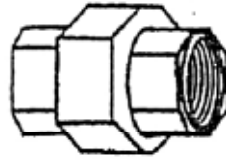

**UNIONS
BRASS TO IRON SEAT**

GALVANIZED

(110418) 1/8
(110420) 1/4
(110422) 3/8
pk 10

(110424) 1/2
(110426) 3/4
pk 25

(110428) 1
pk 10

(110430) 1 1/4
(110432) 1 1/2
(110434) 2
pk 5

BLACK

(110417) 1/8
(110490) 1/4
(110421) 3/8
pk 10

(110423) 1/2
(110425) 3/4
pk 25

(110427) 1
pk 10

(110429) 1 1/4
(110431) 1 1/2
(110433) 2
pk 5

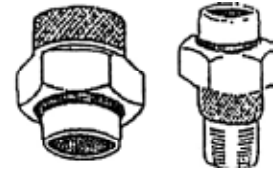

DIELECTRIC UNIONS

Knox

Prevents electrolysis when joining dissimilar metals. For residential or commercial use. Forged steel. Zinc plated. pressure rated at 250psi at 180°.

FIP X COPPER SWEAT

1/2 X 1/2"
(157092) DU50

3/4 X 3/4"
(157093) DU75

1 X 1"
(157094) DU100

MIP X COPPER SWEAT

3/4 X 3/4"
(157095) DUM7575
pk 12

WASHERS

1/2"
(157096) DU650

3/4"
(157097) DU675

1"
(157098) DU6100

pk 1



PLUMBING & HEATING



PLUMBER'S PUTTY

OATEY

Item	Pack	Part #	HDI #
A stainless fixture setting compound for setting frames, faucets, bowls, and sinks. Stays flexible and will not crack or shrink.			
14 oz.	24	31166	155004



PIPE JOINT COMPOUND

123030

OATEY

Item	Pack	Part #	HDI #
Pipe Joint Compound with Teflon - White non-hardening or separating paste seals all threaded connections against leakage from internal pressure. For use on water, steam, LP and natural gas, oil, caustics or diluted acid lines. Withstands pressure to 10,000 psi.			
1 oz. Tube	12	31229	155014
4 oz. Can w/Brush	12	31230	155015
Gray Pipe Joint Compound - Fast set non-hardening paste which lubricates and seals threaded joints. Non-toxic and may be used on water, natural gas, steam and air lines.			
1 oz. Tube	12	31226	155001
8 oz. Can w/Brush	12	31228	155003

JOMAR

Item	Pack	Part #	HDI #
Thread Sealant - "Gimme the Green Stuff" Slow drying, soft setting, non-hardening pipe thread compound. Lead free. Non-toxic. Will not harden in can.			
2 oz. Tube	12	AGTG-2	123030
4 oz. Can	24	AGTG-4	123040



FAUCET & VALVE GREASE

DANCO

Item	Pack	Part #	HDI #
Use as a lubricant on faucets and stems.			
1/2 oz. Waterproof Grease	6	80360A	87100
1/2 oz. Silicone Grease	6	88693	87138

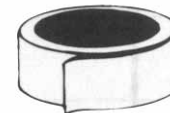

96427X

25027

PIPE THREAD TAPE

DANCO

Item	Pack	Part #	HDI #
Packaged Teflon Pipe Thread Tape - 3 mil thick Seals pipe threads quickly & easily. Self-lubricating. Stays soft & flexible. Eliminates need for fittings. Resists all acids, solvents, & oil			
1/2" x 260"	24	96427X	87694

LAKE CITY

Item	Pack	Part #	HDI #
Bulk Pack Teflon Pipe Thread Tape - Stops leaks on metal or plastic pipes. Makes lead free joints on pipes for steam, oil, or acids.			
1/2" x 260"	10		25027
1/2" x 520"	10		25029
Yellow Gas Pipe Teflon Tape			
1/2" x 260"	12		25028

EMERGENCY REPAIR TAPE



DANCO

Item	Pack	Part #	HDI #
Seals all leaks and cuts wet or dry. For homes, cars, or boats. Apply in temperatures from 0° to 212°F Water & air tight at 100 PSI			
1" x 16'	12	88823	87686

PLUMBING & HEATING



CTS J-HOOK

American Copper
Support copper, CPVC, PB and PEX water supply lines from joists and rafters. Hook nails or staples flush against a wall or stud. Two staples furnished. Made of high impact ABS plastic.

1/2" x 6"
(100060) _____ SH500

3/4" x 7"
(100065) _____ SH750
pk 25



GALVANIZED METAL PERFORATED HANGER IRON

Dundee Mfg
24 ga galvanized metal.
3/4" x 10'
Boxed

(120120) _____ IPI-24
pk 24



DWV J-HOOK

American Copper
Support drain, waste and vent pipe from joists and rafters. Nail holes on all four sides allow for attachment at various angles for pipe runs. Use for Sch. 30 and Sch. 40 pipe. Made of high impact ABS plastic.

1 1/2" x 7 1/2"
(100080) _____ RH1500

2" x 7 1/2"
(100085) _____ RH2000

3" x 7 1/2"
(100090) _____ RH3000
pk 25

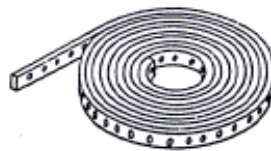

PLASTIC HANGER STRAP

Oatey
3/4" x 10"
Plastic strapping provides strong, economical, easy to cut material for use with plastic pipe.
Bagged

(155017) _____ 33928
pk 12

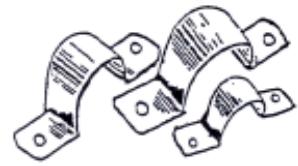

COPPER TWO HOLE PIPE STRAPS

American Copper
Steel, copper coated.

1/2"
(100058) _____ A440-1/2

3/4"
(100059) _____ A440-3/4
pk 100



COPPER PIPE HANGER

American Copper
3/4" x 6"
11 ga
Copper coated basic wire hooks. Points deflected for easy driving.

(100039) _____ A5736C
pk 1



PLUMBING & HEATING

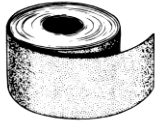

ABRASIVE CLOTH

Danco
For plumbing joints. 1 1/2" x 6'
roll.

1 per card

(86597) _____ 86643
pk 5



4 IN 1 BRUSH

OATEY
1 per card

_____ 31407
(80015) _____
pk 5



FITTING BRUSH

1 per card

LDR

For 1/2" tube 511-4140
(086585) _____

3/4" 511-4150

(086587) _____
pk 5



PACKING SHEETS

Danco
6" x 6". 2 Sheets. Packed in bag
with header tag.

1/16" Thick
(87642) _____ 59849
pk 10



PLUMBING & HEATING

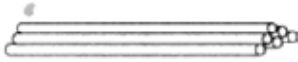

**COPPER PIPE
TYPE M**

LDR

Hard and thin. For light domestic water lines and is not permitted in some location codes for underground use. Use with soldered fittings. 10' length.

1/2" ID x 5/8 OD
(100010) 12M10
pk 25

3/4" ID x 7/8 OD
(100012) 34M10
pk 10

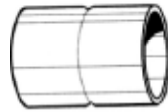

**WROT COPPER
COUPLING /
REDUCING
COUPLING**

LDR

Copper to copper with stop.

1/2"
(100015) FSWCO-12
pk 100

3/4"
(100016) FSWCO-34
pk 25



REDUCING COUPLING

Copper x Copper

3/4 x 1/2"
(100017) FSWRC-3412
pk 25



**WROT COPPER
90° ELBOW**

LDR

Short radius. Copper x Copper

1/2"
(100018) FSWE90-12

3/4"
(100019) FSWE90-34
pk 25

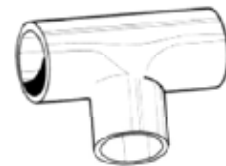

**WROT COPPER TEE
REDUCING TEE**

LDR

Copper x Copper x Copper

1/2"
(100020) FSWT-12
pk 25

3/4"
(100021) FSWT-34
pk 10

REDUCING TEE

Copper x Copper x Copper

3/4 x 3/4 x 1/2"
(100022) FSWRT-343412
pk 10



PLUMBING & HEATING



WROT COPPER 45° ELBOW
LDR
Copper x copper

1/2"
(100023) FSWE45-12

3/4"
(100024) FSWE45-34
pk 25

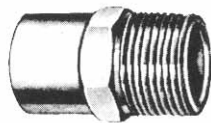

WROT COPPER MALE ADAPTER

LDR
Copper x MIP

1/2"
(100027) FSWMA-12

3/4"
(100028) FSWMA-34
pk 25



CAST COPPER DROP EAR ELBOW

LDR
Copper x FIP

1/2"
(100055) FSWDE-12
pk 25



WROT COPPER 90° STREET ELBOW

LDR
Copper x copper

1/2"
(100035) FSWSE90-12

3/4"
(100036) FSWSE90-34
pk 25

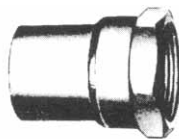

WROT COPPER FEMALE ADAPTER

LDR
Copper x FIP

1/2"
(100025) FSWFA-12
pk 25

3/4"
(100026) FSWFA-34
pk 10



CAST COPPER 90° DROP EAR ELBOW

LDR
Copper x copper

1/2"
(100037) FSWDE90-12
pk 10
3/4"
(100038) 47075-K
pk 25



SOFT COPPER TUBING

American Copper
Refrigeration. Has moisture removed and ends sealed. For air conditioning and refrigeration. Intended for use in the field as connection, repair and alteration. 50' coil. [wall thickness]

1/8 - OD [.030]
(100001) 18R50

3/16 - OD [.030]
(100002) 316R50

1/4 - OD [.030]
(100003) 14R50

3/8 - OD [.032]
(100005) 38R50

1/2 - OD [.032]
(100006) 12R50

5/8 - OD [.035]
(100007) 58R50

pk 1



WROT COPPER CAP

LDR
Copper for tube end.

1/2"
(100029) FSWCA-12

3/4"
(100030) FSWCA-34

pk 25



WROT COPPER UNION

LDR
Copper x copper

1/2"
(100031) FSW4-12

pk 25
3/4"
(100032) FSW4-34

pk 10



PLUMBING & HEATING

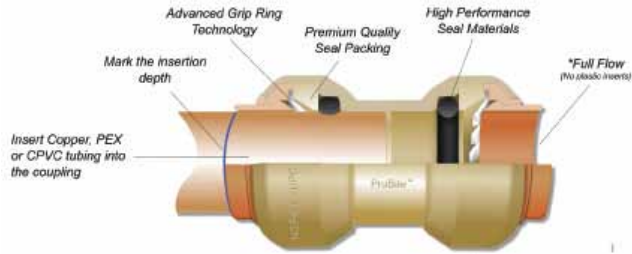

PROBITE FITTINGS - Lead Free

QUICK FITTING

Item	Pack	Part #	HDI #
Couplings			
3/8" x 3/8"	6	LF801R	128032
1/2" x 1/2"	6	LF811R	128001
3/4" x 3/4"	6	LF821R	128002
Reducer			
1/2" x 3/8"	4	LF8401R	128003
3/4" x 1/2"	6	LF841R	128004
Female Adapters - PC x FIP			
3/8" x 3/8"	6	LF802FR	128033
1/2" x 1/2"	6	LF812FR	128005
3/4" x 3/4"	6	LF822FR	128006
1/2" x 3/4"	4	LF842FR	128007
Male Adapters - PC x MIP			
3/8" x 3/8"	4	LF802MR	128034
1/2" x 1/2"	4	LF812MR	128008
3/4" x 3/4"	4	LF822MR	128009
1/2" x 3/4"	4	LF842MR	128010
Elbow			
3/8" x 3/8"	4	LF803R	128035
1/2" x 1/2"	4	LF813R	128011
3/4" x 3/4"	4	LF823R	128012
3/4" x 1/2" Red Elbow	4	LF843R	128013
Elbow Adapters			
1/2" x 1/2" PC x FIP	4	LF813FR	128014
1/2" x 1/2" PC x MIP	4	LF813MR	128015
1/2" x 1/2" PC x MIP Drop Ear	4	LF813DR	128016
Tee			
3/8" x 3/8" x 3/8"	4	LF804R	128036
1/2" x 1/2" x 1/2"	4	LF814R	128017
3/4" x 3/4" x 3/4"	3	LF824R	128018
3/4" x 1/2" x 1/2" Red Tee	3	LF815R	128019
3/4" x 1/2" x 3/4"	3	LF825R	128020
3/4" x 3/4" x 1/2" Red Tee	3	LF844R	128031
End Stop			
3/8"	6	LF806R	128037
1/2"	6	LF816R	128021
3/4"	6	LF826R	128022



Couplings Reducer Female Adapter Male Adapter



Elbow Female Elbow Male Elbow Drop Ear Elbow



Tee Red Tee End Stop Ball Valve



PROBITE FITTINGS

Valve Slip Couplings

QUICK FITTING

Item	Pack	Part #	HDI #
Ball Valves			
3/8" x 3/8"	3	LF902R	128038
1/2" x 1/2"	3	LF912R	128023
3/4" x 3/4"	3	LF922R	128024
Valves - PC x OD			
1/2" x 3/8" Angle	4	LF953AR	128025
1/2" x 3/8" Straight	4	LF953SR	128026
Slip Couplings with Disconnect Tool			
1/2"	4	LF817R	128029
3/4"	4	LF827R	128030



DISCONNECT TOOL

QUICK FITTING

Item	Pack	Part #	HDI #
Used to disconnect fittings from pipe.			
3/8"	10	PB701R	128039
1/2"	10	PB711R	128027
3/4"	10	PB721R	128028



PLUMBING & HEATING

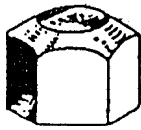

FLARE SEAL CAP

Carded
LDR
3/8" 508-56-6
(125318) P666
1/2" 508-56-8
(125320) P668
pk 5

BULK
Holyoke
3/8" 56-6-3/8
(130002)
1/2" 56-8-1/2
(130003)
5/8" 56-10-5/8
(130005)
pk 1



FORGED FLARE SWIVEL NUT CONNECTORS

American Copper & Brass

1/4 OD
(130006) AUS4C
3/8 OD
(130007) AUS4E
3/8 x 1/4 OD
(130008) AUS4EC
1/2 OD
(130009) AUS4F
1/2 x 3/8 OD
(130010) AUS4FE
5/8 OD
(130011) AUS4I
5/8 x 1/2 OD
(130012) AUS4IF
pk 25

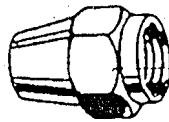

SHORT FLARE NUT

Carded
LDR
1/4" 508-41-4
(125322) P503
3/8" 508-41-6
(125324) P505
1/2" 508-41-8
(125326) P508
pk 5

BULK
Holyoke
1/4" 41S-4-1/4
(130020)
5/16" 41S-5-5/16
(130021)
3/8" 41S-6-3/8
(130022)
1/2" 41S-8-1/2
(130023)
5/8" 41S-10-5/8
(130024)
pk 1



FLARE UNION & FLARE REDUCING UNION

Carded
LDR
3/8" 508-42-6
(125332) P524
1/2" 508-42-8
(125334) P527
pk 5

BULK
Holyoke
5/16" 42-5-5/16
(130071)
3/8" 42-6-3/8
(130072)
1/2" 42-8-1/2
(130073)
5/8" 42-10-5/8
(130074)
pk 1



1/2 x 3/8"
(130075) 42-86-1/2x3/8
pk 1



PLUMBING & HEATING

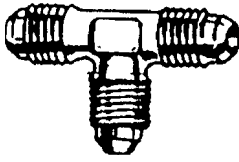

FLARE TEE
(FLARE THREE ENDS)

LDR
Carded

3/8"	P543
(125344)	508-44-6
1/2"	P544
(125346)	508-44-8

pk 5

BULK
Holyoke

3/8"	
(130037)	44-6-3/8
1/2"	
(130038)	44-8-1/2
5/8"	
(086603)	44-10-5/8

pk 1

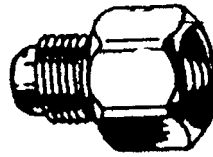

FEMALE COUPLING
Flare to female pipe

LDR
Carded

3/8 x 3/8"	P560
(125354)	508-46-6-6
3/8 x 1/2"	P562
(125356)	508-46-6-8
1/2 x 1/2"	P567
(125360)	508-46-8-8
5/8 x 1/2"	P570
(125362)	508-46-10-8

pk 5

BULK
Holyoke

1/4 x 1/4"	
(086605)	46-44-1/4x1/4
3/8 x 1/4"	
(130043)	46-64-3/8x1/4
3/8 x 3/8"	
(130044)	46-66-3/8x3/8
3/8 x 1/2"	
(130045)	46-68-3/8x1/2
3/8 x 3/4"	
(130046)	46-612-3/8x3/4
1/2 x 3/8"	
(130048)	46-86-1/2x3/8
1/2 x 1/2"	
(130049)	46-88-1/2x1/2
1/2 x 3/4"	
(130050)	46-812-1/2x3/4
5/8 x 1/2"	
(130051)	46-108-5/8x1/2
5/8 x 3/4"	
(086607)	46-1012-5/8x3/4

pk 1

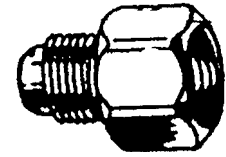

GAS APPLIANCE CONNECTOR
Flare to FIP

BULK
Holyoke

15/16 x 1/2 FIP	
(130162)	46GA-108
15/16 x 3/4 FIP	
(130160)	46GA-1012

pk 1
CARDED
LDR

15/16" x 3/4 FIP	
(87028)	509 18-14-12
15/16" x 1/2 FIP	
(87027)	509 18-14-8

pk 5

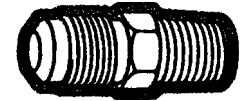

GAS APPLIANCE CONNECTOR
Flare to MIP

BULK
Holyoke

15/16 x 1/2 MIP	
(130164)	48GA-108
15/16 x 3/4 MIP	
(130166)	48GA-1012

pk 1
CARDED
LDR

15/16 x 3/4 MIP	
(87030)	509 19-14-12
15/16 x 1/2 MIP	
(87029)	509 19-14-8

pk 5



PLUMBING & HEATING

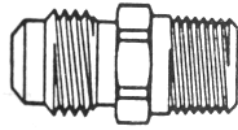

HALF UNION

LDR
Flare to MIP

Carded

3/8 x 3/8"	P591
(125372)	508-48-6-6
3/8 x 1/2"	P593
(125374)	508-48-6-8
1/2 x 1/2"	P598
(125378)	508-48-8-8
1/2" x 3/4"	P599
(125380)	508-48-8-12
5/8 x 1/2"	P602
(125382)	508-48-10-8

pk 5

Bulk

Holyoke

1/4 x 1/4"	
(130056)	48-44-1/4x1/4
5/16 x 1/4"	
(86609)	48-54-5/16x1/4
3/8 x 1/4"	
(130059)	48-64-3/8x1/4
3/8 X 3/8"	
(130060)	48-66-3/8X3/8
3/8 x 1/2"	
(130061)	48-68-3/8x1/2
3/8 x 3/4"	
(130062)	48-612-3/8x3/4
1/2 x 3/8"	
(130063)	48-86-1/2x3/8
1/2 x 1/2"	
(130064)	48-88-1/2x1/2
1/2 x 3/4"	
(130065)	48-812-1/2x3/4
5/8 x 1/2"	
(130066)	48-108-5/8x1/2
5/8 x 3/4"	
(130067)	48-1012-5/8x3/4

pk 1



FLARE FEMALE ELBOW

LDR
Flare to FIP

Carded

1/2 x 1/2"	P634
(125404)	508-50-8-8

pk 5

Bulk

Holyoke

3/8 x 3/8"	
(86611)	50-66-3/8x3/8
3/8 x 1/2"	
(86613)	50-68-3/8x1/2
1/2x 3/8"	
(86616)	50-86-1/2x3/8
1/2 x 1/2"	
(86615)	50-88-1/2x1/2

pk 1



PLUMBING & HEATING

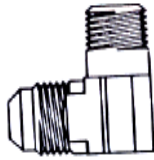

ELBOW

Flare to MIP

Bulk

Holyoke

3/8" x 1/4"

(130140) 49-64-3/8x1/4

3/8" x 3/8"

(130143) 49-66-3/8x3/8

3/8" x 1/2"

(130145) 49-68-3/8x1/2

1/2" x 1/2"

(130150) 49-88-1/2x1/2

1/2" x 3/4"

(130153) 49-812-1/2x3/4

5/8" x 1/2"

(130155) 49-108-5/8x1/2

5/8" x 3/4"

(130158) 49-1012-5/8x3/4

pk 1

Carded

LDR

3/8" x 3/8"

P621

(130138) 508-49-6-6

pk 5

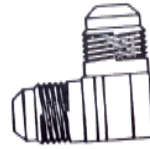

ELBOW

Flare to Flare

Bulk

Holyoke

5/16"

(130171) 55-5 5/16

3/8"

(130172) 55-6 3/8

1/2"

(130173) 55-8 1/2

5/8"

(130174) 55-10 5/8

pk 1



PLUMBING & HEATING



BRASS COMPRESSION SLEEVE

Carded	
LDR - 3 per card	
1/4"	P53
(125422)	508-60-4
3/8"	P55
(125426)	508-60-6
1/2"	P57
(125428)	508-60-8
pk 5	
Bulk	
Holyoke	
1/4"	
(130095)	60-4-1/4
5/16"	
(86619)	60-5-5/16
3/8"	
(130096)	60-6-3/8
1/2"	
(130097)	60-8-1/2
5/8"	
(86623)	60-10-5/8
pk 1	



COMPRESSION NUT

Carded	
LDR - 3 per card	
1/4"	P68
(125432)	508-61-4
3/8"	P70
(125436)	508-61-6
1/2"	P72
(86771)	508-61-8
pk 5	
Bulk	
Holyoke	
1/4"	
(130100)	61-4-1/4
5/16"	
(86631)	61-5-5/16
3/8"	
(130101)	61-6-3/8
1/2"	
(130102)	61-8-1/2
5/8"	
(86637)	61-10-5/8
pk 1	



COMPRESSION CAP

American Copper & Brass

Bulk	
3/8"	
(130148)	N5CT-6
pk 5	

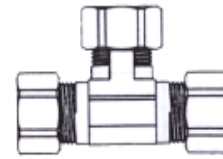

COMPRESSION TEE
(compression three ends)

Carded	
LDR - 1 per card	
3/8"	P133
(125454)	508-64-6
1/2"	P135
(86779)	508-64-8
pk 5	
Bulk	
Holyoke	
1/4"	
(130110)	64-4-1/4
3/8"	
(130111)	64-6-3/8
7/16"	
(86653)	64-7-7/16
1/2"	
(130112)	64-8-1/2
5/8"	
(130113)	64-10-5/8
pk 1	



PLUMBING & HEATING

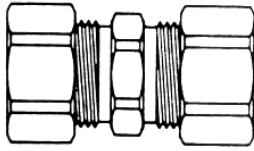

UNION

Compression x compression
LDR

Carded

1/4"	P108
(125442)	508-62-4
5/16"	P110
(125444)	508-62-5
3/8"	P113
(125446)	508-62-6
1/2"	P117
(125448)	508-62-8
5/8"	P120
(125450)	508-62-10

pk 5

Bulk
Holyoke

1/4"	
(130106)	62-4-1/4
5/16"	
(130105)	62-5-5/16
3/8"	
(130107)	62-6-3/8
1/2"	
(130108)	62-8-1/2
5/8"	
(86649)	62-10-5/8

pk 1

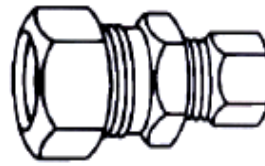

REDUCING UNION

Compression x compression
LDR

Carded

5/8 x 1/2"	P119
(86777)	508-62-10-8

pk 5

Bulk
Holyoke

3/8 x 1/4"	
(86641)	62R-64-3/8-1/8
1/2 x 3/8"	
(86647)	62R-86-1/2x3/8
5/8 x 3/8"	
(86651)	62R-106-5/8x3/8
5/8 x 1/2"	
(86652)	62R108-5/8x1/2

pk 1



PLUMBING & HEATING

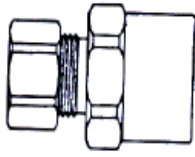

FEMALE COUPLING

Compression x FIP

Carded	
LDR	
3/8 x 3/8"	P171
(125466)	508-66-6-6
3/8 x 1/2"	P172
(125468)	508-66-6-8
1/2 x 1/2"	P175
(125472)	508-66-8-8
5/8 x 1/2"	P177
(86783)	508-66-10-8
pk 5	

Bulk
Holyoke

1/4 x 1/4"	
(130118)	66-44-1/4x1/4
3/8 x 1/4"	
(86657)	66-64-3/8x1/4
3/8 x 3/8"	
(130119)	66-66-3/8x3/8
3/8 x 1/2"	
(130121)	66-68-3/8x1/2
1/2 x 3/8"	
(130122)	66-86-1/2x3/8
1/2 x 1/2"	
(130120)	66-88-1/2x1/2
5/8 x 1/2"	
(86659)	66-108-5/8x1/2
pk 1	

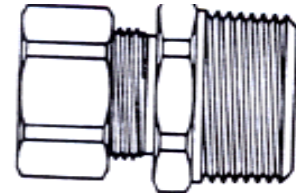

CONNECTOR

Compression x MIP

Carded	
LDR	
1/4 x 1/4"	P190
(125476)	508-68-4-4
3/8 x 1/4"	P197
(125482)	508-68-6-4
3/8 x 3/8"	P198
(125484)	508-68-6-6
3/8 x 1/2"	P199
(125486)	508-68-6-8
1/2 x 1/2"	P204
(125490)	508-68-8-8
pk 5	

Bulk
Holyoke

1/4 x 1/8"	
(86661)	68-42-1/4x1/8
1/4 x 1/4"	
(130126)	68-44-1/4x1/4
1/4 x 3/8"	
(86663)	68-46-1/4x3/8
1/4 x 1/2"	
(86665)	68-48-1/4x1/2
5/16 x 1/4"	
(86667)	68-54-5/16x1/4
3/8 x 1/8"	
(86669)	68-62-3/8x1/8
3/8 x 1/4"	
(130127)	68-64-3/8x1/4
3/8 x 3/8"	
(130128)	68-66-3/8x3/8
3/8 x 1/2"	
(130129)	68-68-3/8x1/2
1/2 x 3/8"	
(130130)	68-86-1/2x3/8
1/2 x 1/2"	
(130131)	68-88-1/2x1/2
5/8 x 1/2"	
(86673)	68-108-5/8x1/2
5/8 x 3/4"	
(86674)	68-1012-5/8x3/4
pk 1	



PLUMBING & HEATING

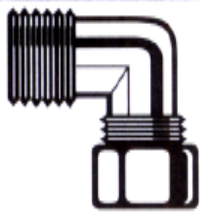

ELBOW
Compression X MIP

Carded
LDR
3/8 x 1/4" P229
(125500) 508-69-6-4
3/8 x 3/8" P230
(125502) 508-69-6-6
pk 5

Bulk
Holyoke
1/4 x 1/8"
(86675) 69-42-1/4x1/8
3/8 x 1/4"
(86677) 69-64-3/8x1/4
3/8 x 3/8"
(130134) 69-56-3/8x3/8
3/8 x 1/2"
(130136) 69-68-3/8x1/2
1/2 x 3/8"
(86679) 69-86-1/2x3/8
1/2 x 1/2"
(130135) 69-88-1/2x1/2
pk 1

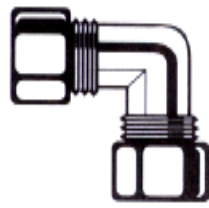

ELBOW
Compression x compression

Bulk
Holyoke
1/4"
(130114) 65-4-1/4
3/8"
(130115) 65-6-3/8
1/2"
(130116) 65-8-1/2
5/8"
(130117) 65-10-5/8
pk 1



PLUMBING & HEATING

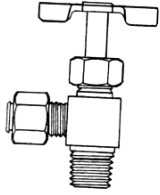

**NEEDLE SHUT-OFF
VALVE**

Holyoke
Compression to MIP. 90°

1/4 x 1/8"

(86757) 149-42

pk 1

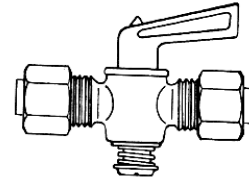

**NEEDLE SHUT-OFF
VALVE**

Holyoke
Compression x compression
Straight

1/4"

(86755) 142-4

pk 1



PLUMBING & HEATING



**BRASS INSERTS & PLASTIC
COMPRESSION SLEEVES**

LDR

Carded - 2 per card

1/4" P263
(85118) 508-760-4

3/8" P265
(85120) 508-760-6

pk 5



**PLASTIC COMPRESSION
SLEEVE**

Holyoke

Delrin sleeve for plastic tubing.

Bulk
1/4" (86625) 760-4S

3/8" 60PT-6
(86627) 760-6S

1/2" 60PT-8
(86629) 760-8S

pk 5



BRASS TUBE SUPPORTS

Holyoke

Bulk
1/4" 760-4INS
(86634) P61-4

3/8" 760-6INS
(86635) P61-6

1/2" 760-8INS
(86636) P61-8

pk 5



PLUMBING & HEATING



TUBING

DANCO

Item	Pack	Part #	HDI #
Vinyl Tubing			
Vinyl 1/8" ID x 3/16" OD 400'	1	51350	87302
Vinyl 1/8" ID x 1/4" OD 400'	1	51351	87304
Vinyl 3/16" ID x 5/16" OD 300'	1	51352	87306
Vinyl 1/4" ID x 3/8" OD 300'	1	51353	87308
Vinyl 5/16" ID x 7/16" OD 250'	1	51354	87310
Vinyl 5/16" ID x 1/2" OD 150'	1	51355	87312
Vinyl 3/8" ID x 1/2" OD 200'	1	51356	87314
Vinyl 1/2" ID x 5/8" OD 150'	1	51357	87316
Vinyl 1/2" ID x 3/4" OD 100'	1	51358	87318
Vinyl 5/8" ID x 7/8" OD 150'	1	51359	87320
Vinyl 3/4" ID x 1" OD 100'	1	51360	87322
Vinyl 1" ID x 1 1/4" OD 50'	1	51361	87324
Vinyl 1 1/4" ID x 1 1/2" OD 50'	1	51362	87326
Polyethylene Tubing			
Polyethylene 1/4" OD 400'	1	51363	87328
Polyethylene 5/16" OD 400'	1	51364	87330
Polyethylene 3/8" OD 300'	1	51365	87332
Polyethylene 1/2" OD 200'	1	51366	87334

TUBING

Item	Pack	Part #	HDI #
Non-Toxic Polyethylene Tubing - For use with refrigeration, humidifiers, water softeners, boats, potable water lines, ice makers.			
<i>100' Dispenser Reels</i>			
15/64" ID X 5/16" OD, 120 PSI	1	9002P	85454
1/4" ID x 3/8" OD, 120 PSI	1	9003P	85456
3/8" ID x 1/2" OD, 90 PSI	1	9004P	85458
Non-Toxic Vinyl Tubing - Clear. For use with hobby and pets, livestock, swimming pools, mobile homes, rope, chain and cord covers, boats.			
<i>100' Dispenser Reel</i>			
1/8" ID x 1/4" OD, 65 PSI	1	7001P	85462
3/16" ID x 5/16" OD, 55 PSI	1	7002P	85464
1/4" ID x 3/8" OD, 55 PSI	1	7003P	85466
5/16" ID x 7/16" OD, 50 PSI	1	7004P	85468
5/16" ID x 1/2" OD, 50 PSI	1	7044P	85470
3/8" ID x 1/2" OD, 45 PSI	1	7005P	85472
3/8" ID x 9/16" OD, 50 PSI	1	7045P	85474
1/2" ID x 5/8" OD, 30 PSI	1	7006P	85476
1/2" ID x 3/4" OD, 45 PSI	1	7007P	85478



PLUMBING & HEATING



HOSE

DANCO

Item	Pack	Part #	HDI #
Braided PVC 1/4" ID x 1/2" OD 200'	1	51367	87336
Braided PVC 3/8" ID x 5/8" OD 100'	1	51368	87338
Braided PVC 1/2" ID X 3/4" OD 100'	1	51369	87340
Braided PVC 5/8" ID x 7/8" OD 75'	1	51370	87342
Braided PVC 3/4" ID x 1" OD 75'	1	51371	87344
Braided PVC 1" ID x 1 3/8" OD 75'	1	51372	87346
Braided PVC 1 1/4" ID x 1 3/4" OD 50'	1	51373	87348
Air Hose 1/4" ID x 1/2" OD 100'	1	51374	87350
Air Hose 3/8" ID x 5/8" OD 100'	1	51375	87352
Reinf. Rub. Hose 3/16" ID x 13/32" OD 100'	1	51377	87356
Reinf. Rub. Hose 1/4" ID x 1/2" OD 100'	1	51378	87358
Reinf. Rub. Hose 3/8" ID x 5/8" OD 100'	1	51379	87360
Reinf. Rub. Hose 1/2" ID x 51/64" OD 100'	1	51380	87362
Reinf. Rub. Hose 5/8" ID x 7/8" OD 50'	1	51381	87364
Reinf. Rub. Hose 7/8" ID x 1 1/8" OD 25'	1	51382	87366
Reinf. Rub. Hose 1" ID x 1 11/32" OD 75'	1	51383	87368
Garden Hose 5/8" ID x 75'	1	51388	87370



PLUMBING & HEATING



BRASS HOSE BARB

LDR
Tube x MIP
Carded

1/4 x 3/8"	P922
(86797)	508-139-4-6
3/8 x 1/2"	P929
(86800)	508-139-6-8
pk 5	

Bulk Tube x MIP

Holyoke	
1/4 x 1/8"	
(086742)	139-42
5/16 x 1/8"	
(086743)	139-52
1/4 x 1/4"	
(086745)	139-44
3/8 x 1/4"	
(086747)	139-64
3/8 x 3/8"	
(086749)	139-66
3/8" x 1/2"	
(086751)	139-86
1/2 x 1/2"	
(086753)	139-88
pk 1	

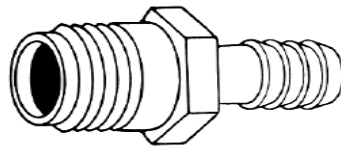

NYLON GARDEN HOSE ADAPTER

Danco
Plastic tube x garden hose fitting

sold / price each

1/4"	FP-81-4
(86001)	52670
3/8"	FP-81-6
(86002)	52675
1/2"	FP-81-8
(86111)	52680
5/8"	FP-81-10
(86004)	52613
3/4"	FP-81-12
(86005)	52614
pk 3	

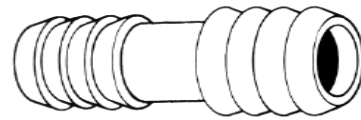

NYLON COUPLINGS

Danco
Plastic tube x plastic tube

sold / price each

1/8 x 1/8"	FP-82-2
(86006)	52616
3/16 x 3/16"	FP-82-3
(86007)	52617
1/4 x 1/4"	FP-82-4
(86008)	52437
1/4 x 3/16"	FP-82-4-3
(86009)	52618
5/16"	FP-82-5
(86010)	52619
3/8"	FP-82-6
(86011)	52438
3/8 x 1/4"	FP-82-6-4
(86012)	52620
1/2"	FP-82-8
(86013)	52439
1/2 x 3/8"	FP-82-8-6
(86015)	52622
5/8"	FP-82-10
(86016)	52623
5/8 x 3/8"	FP-82-10-6
(86017)	52624
5/8 x 1/2"	FP-82-10-8
(86018)	52625
3/4"	FP-82-12
(86019)	52626
1"	FP-82-16
(86020)	52627
pk 3	



PLUMBING & HEATING

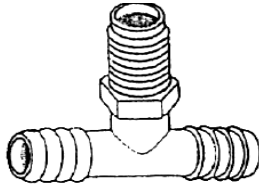

NYLON TEE

Danco
Plastic tube x plastic tube x
MIP

sold / price each

$1/4 \times 1/4 \times 1/8$	FP-83-4-2
<u>(86022)</u>	<u>52629B</u>
$1/4 \times 1/4 \times 1/4$	FP-83-4
<u>(86021)</u>	<u>52628</u>
$1/4 \times 1/4 \times 3/8$	FP-83-4-6
<u>(86023)</u>	<u>52630</u>
$3/8 \times 3/8 \times 3/8$	FP-83-6
<u>(86024)</u>	<u>52631</u>
$3/8 \times 3/8 \times 1/4$	FP-83-6-4
<u>(86025)</u>	<u>52632</u>
$3/8 \times 3/8 \times 1/2$	FP-83-6-8
<u>(86026)</u>	<u>52633B</u>
$1/2 \times 1/2 \times 3/8$	FP-83-8-6
<u>(86028)</u>	<u>52635</u>
$1/2 \times 1/2 \times 1/2$	FP-83-8-8
<u>(86027)</u>	<u>52634</u>
$3/4 \times 3/4 \times 3/4$	FP-83-12
<u>(86029)</u>	<u>52636</u>

pk 3

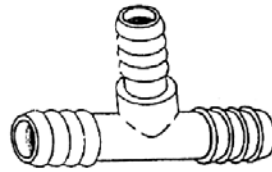

NYLON TEE

Danco
Plastic tube x plastic tube x
plastic tube

sold / price each

$1/8 \times 1/8 \times 1/8$	FP84-2
<u>(86031)</u>	<u>52638</u>
$3/16 \times 3/16 \times 3/16$	FP-84-3
<u>(86032)</u>	<u>52639</u>
$1/4 \times 1/4 \times 1/4$	FP-84-4
<u>(86033)</u>	<u>52640</u>
$5/16 \times 5/16 \times 5/16$	FP-84-5
<u>(86034)</u>	<u>52641</u>
$3/8 \times 3/8 \times 3/8$	FP-84-6
<u>(86035)</u>	<u>52642</u>
$3/8 \times 3/8 \times 1/4$	FP-86-6-4
<u>(86036)</u>	<u>52643</u>
$3/8 \times 3/8 \times 1/2$	FP-84-6-8
<u>(86037)</u>	<u>52644</u>
$1/2 \times 1/2 \times 1/2$	FP-84-8
<u>(86038)</u>	<u>52645</u>
$1/2 \times 1/2 \times 3/8$	FP-84-8-6
<u>(86039)</u>	<u>52646</u>
$1/2 \times 1/2 \times 3/4$	FP84-8-12
<u>(86043)</u>	<u>52650</u>
$5/8 \times 5/8 \times 5/8$	FP-84-10
<u>(86040)</u>	<u>52647</u>
$5/8 \times 5/8 \times 1/2$	FP-84-10-8
<u>(86041)</u>	<u>52648</u>
$3/4 \times 3/4 \times 3/4$	FP-84-12
<u>(86042)</u>	<u>52649</u>
$1 \times 1 \times 1$	FP-84-16
<u>(86044)</u>	<u>52651</u>

pk 3



PLUMBING & HEATING

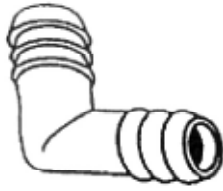

NYLON ELBOW

Danco
Plastic tube x plastic tube

sold / price each

<u>1/4 x 1/4</u>	<u>FP-85-4</u>
<u>(86045)</u>	<u>52652</u>
<u>3/8 x 3/8</u>	<u>FP-85-6</u>
<u>(86046)</u>	<u>52653</u>
<u>3/8 x 1/2</u>	<u>FP-85-8-6</u>
<u>(86047)</u>	<u>52654</u>
<u>1/2 x 1/2</u>	<u>FP-85-8</u>
<u>(86048)</u>	<u>52655</u>
<u>5/8 x 5/8</u>	<u>FP-85-10</u>
<u>(86049)</u>	<u>52656</u>
<u>3/4 x 3/4</u>	<u>FP-85-12</u>
<u>(86050)</u>	<u>52657</u>
pk 3	



NYLON ELBOW

Danco
MIPX Plastic Tube

sold / price each

<u>1/8 x 1/4</u>	<u>FP-89-2-4</u>
<u>(86082)</u>	<u>52685</u>
<u>1/8 x 3/8</u>	<u>FP-89-2-6</u>
<u>(86083)</u>	<u>52686</u>
<u>1/4 x 1/4</u>	<u>FP-89-4</u>
<u>(86084)</u>	<u>52687</u>
<u>1/4 x 5/16</u>	<u>FP-89-4-5</u>
<u>(86085)</u>	<u>52688</u>
<u>3/8 x 3/8</u>	<u>FP-89-6</u>
<u>(86086)</u>	<u>52689</u>
<u>3/8 x 1/4</u>	<u>FP-89-6-4</u>
<u>(86087)</u>	<u>52690</u>
<u>3/8 x 1/2</u>	<u>FP-89-6-8</u>
<u>(86088)</u>	<u>52691</u>
<u>1/2 x 1/2</u>	<u>FP-89-8</u>
<u>(86089)</u>	<u>52692</u>
<u>1/2 x 3/8</u>	<u>FP-89-8-6</u>
<u>(86090)</u>	<u>52693</u>
<u>1/2 x 5/8</u>	<u>FP-89-8-10</u>
<u>(86091)</u>	<u>52694</u>
<u>1/2 x 3/4</u>	<u>FP-89-8-12</u>
<u>(86092)</u>	<u>52695</u>
<u>3/4 x 3/4</u>	<u>FP-89-12</u>
<u>(86093)</u>	<u>52696</u>
<u>3/4 x 5/8</u>	<u>FP-89-12-10</u>
<u>(86098)</u>	<u>52697</u>
<u>3/4 x 1</u>	<u>FP-89-12-16</u>
<u>(86102)</u>	<u>52698</u>
<u>1 x 1</u>	<u>FP-89-16</u>
<u>(86104)</u>	<u>52699</u>
pk 3	



NYLON PLUG

Danco
MIP

sold / price each

<u>1/8</u>	<u>FP-86-2</u>
<u>(86052)</u>	<u>52659</u>
<u>1/4</u>	<u>FP-86-4</u>
<u>(86053)</u>	<u>52660</u>
<u>3/8</u>	<u>FP-86-6</u>
<u>(86054)</u>	<u>52661</u>
<u>1/2</u>	<u>FP-86-8</u>
<u>(86055)</u>	<u>52662</u>
<u>3/4</u>	<u>FP-86-12</u>
<u>(86056)</u>	<u>52663</u>
<u>1</u>	<u>FP-86-16</u>
<u>(86057)</u>	<u>52664</u>
pk 3	



PLUMBING & HEATING

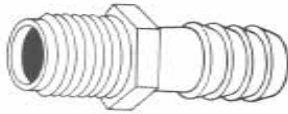

NYLON MALE ADAPTER

Danco
MIP x plastic tube

sold/price each

1/8 x 3/16	FP-88-2-3	3/8 x 5/8	FP-88-6-10
<u>(86058)</u>	<u>52665</u>	<u>(86070)</u>	<u>52677</u>
1/8 x 1/4	FP-88-2-4	1/2 x 1/4	FP-88-8-4
<u>(86059)</u>	<u>52666</u>	<u>(86071)</u>	<u>52678</u>
1/8 x 5/16	FP-88-2-5	1/2 x 3/8	FP-88-8-6
<u>(86060)</u>	<u>52667</u>	<u>(86072)</u>	<u>52679</u>
1/8 x 3/8	FP-88-2-6	1/2 x 1/2	FP-88-8-8
<u>(86061)</u>	<u>52668</u>	<u>(86073)</u>	<u>52436</u>
1/4 x 3/16	FP-88-4-3	1/2 x 5/8	FP-88-8-10
<u>(86062)</u>	<u>52669</u>	<u>(86074)</u>	<u>52681</u>
1/4 x 1/4	FP-88-4-4	1/2 x 3/4	FP-88-8-12
<u>(86063)</u>	<u>52434</u>	<u>(86075)</u>	<u>52682</u>
1/4 x 5/16	FP-88-4-5	3/4 x 1/2	FP-88-12-8
<u>(86064)</u>	<u>52671</u>	<u>(86076)</u>	<u>52683</u>
1/4 x 3/8	FP-88-4-6	3/4 x 5/8	FP-88-12-10
<u>(86065)</u>	<u>52672</u>	<u>(86077)</u>	<u>52609</u>
1/4 x 1/2	FP-88-4-8	3/4 x 3/4	FP-88-12-12
<u>(86066)</u>	<u>52673</u>	<u>(86078)</u>	<u>52611</u>
3/8 x 1/4	FP-88-6-4	3/4 x 1	FP-88-12-16
<u>(86067)</u>	<u>52674</u>	<u>(86079)</u>	<u>52684</u>
3/8 x 3/8	FP-88-6-6	1 x 3/4	FP-88-16-12
<u>(86068)</u>	<u>52435</u>	<u>(86080)</u>	<u>52610</u>
3/8 x 1/2	FP-88-6-8	1 x 1	FP-88-16-16
<u>(86069)</u>	<u>52676</u>	<u>(86081)</u>	<u>52612</u>
pk 3		pk 3	



PLUMBING & HEATING

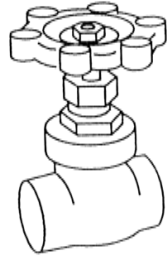

**GATE VALVE -
FORGED BRASS**

LDR
150 PSI WOG
Solder ends

1/2"
(110464) _____ 022-1213
pk 10

3/4"
(110465) _____ 020-1214
pk 10



**GATE VALVE - ECONOMY
LEAD FREE**

LDR
High quality, heavy pattern brass
construction. Use for water, oil
or air. FIP threaded connect.

1/2"
(120129) _____ 022-1113
pk 10

3/4"
(120130) _____ 022-1114
pk 10

1"
(120131) _____ 022-1115
pk 5

1 1/4"
(120132) _____ 020-1116
pk 5

1 1/2"
(120133) _____ 022-1117
pk 2

2"
(120134) _____ 022-1118
pk 2



PLUMBING & HEATING



**FROST FREE SILLCOCK
- ANTI-SIPHON**

BOSHART

Heavy chrome plated brass, silver soldered construction, notched flange for stable installation. Built-in backflow prevention, automatic draining. 3/4" hose thread outlet. Dual connection: 1/2" threaded or 1/2" solder.

10"
(120034) PEWFV-510
pk 2

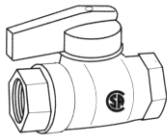

**GAS VALVE - BALL VALVE
TYPE**

LDR

Heavy forged brass construction, one piece body through 3/4 hard chrome plated forged brass ball, coated aluminum handle. UL, CGA approved.

3/8"
(120018) 020-1512
pk 12

1/2"
(120019) 020-1503
pk 12

3/4"
(120020) 020-1504
pk 12

1"
(120021) 020-1515
pk 6

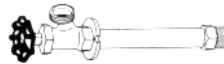

FROST FREE SILLCOCK

BOSHART

Heavy chrome plated brass, silver soldered construction, notched flange for stable installation. Chrome plated casting and tube. 3/4" hose thread outlet. Dual connection: 1/2" male threaded and 1/2" sweat.

8"
(120029) PEWF-58

10"
(120030) PEWF-510

12"
(120031) PEWF-512
pk 2

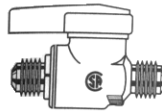

**GAS VALVE - FLARE X
FLARE**

American Copper and Brass
125#

Water, oil, and gas.

1/4 turn.

CGA approved.

3/8 x 3/8
(100050) A1361EE
pk 5



YARD HYDRANT

BOSHART

Frost proof - No Lead
Inlet pipe threaded for 3/4" pipe.
Outlet threaded for garden hose.
1" galvanized pipe body. Drained below frost line when off. Can be padlocked.

OA 6' Bury 3'
(40330) PENL-YH07-03

OA 7' Bury 4'
(40332) PENL-YH07-04

OA 8' Bury 5'
(40334) PENL-YH07-05
pk 1



**GAS BALL VALVES
FIP X FLARE**

LDR

Heavy forged brass construction, two piece body. Hard chrome plated forged brass ball for use w/natural, manufactured, mixed, liquefied petroleum and LP gas/air mixtures.

1/2 x 3/8
(87025) 509 1740

1/2 x 1/2
(87026) 509 1741
pk 5



PLUMBING & HEATING



HOSE BIBB - STANDARD

LDR

Brass construction, neoprene seal disc. 3/4" hose thread outlet. MIP threaded connection.

1/2"
1/2" MIP or 1/2" solder connection
(120121) 020-7703

3/4"
(120122) 020-7704
pk 12

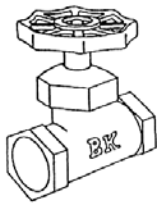

CPVC STOP VALVE

LDR

For use in hot or cold water systems up to 180°. Solvent weld slip connection.

1/2"
(121005) 027-V-12

3/4"
(121006) 027-V-34
pk 12



SILLCOCK

LDR

Heavy brass construction, convenient notched flange for stable installation. Neoprene seal disc. 3/4" hose thread outlet. FIP threaded connection.

1/2"
(120118) 020-6103

3/4"
(120119) 020-6104
pk 12

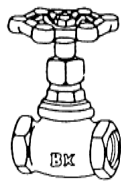

STOP VALVE

LDR

Lead Free
Heavy brass construction for use with water, oil or air. Neoprene seal disc, large flow area. Used primarily where valve will be opened and closed frequently. FIP threaded connection.

1/2"
(120123) 022-5103

3/4"
(120124) 022-5104
pk 12

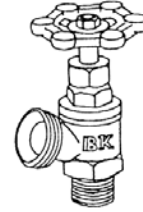

BOILER DRAIN

LDR

Heavy duty brass construction, with stuffing box, neoprene seal disc. 3/4" hose thread outlet. MIP* threaded connection.

1/2"
(120127) 020-7203

3/4"
(120128) 020-7204
pk 12

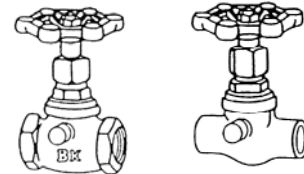

STOP & WASTE VALVE

LDR

Lead Free
Heavy brass construction, for use with water, oil or air. Neoprene disc seal, large flow area. Stop waste and valves allow draining of non pressure side of valve.

FIP THREADED CONNECTION
1/2"
(120125) 022-5303

3/4"
(120126) 022-5304
pk 12

SOLDER CONNECTION
1/2"
(120027) 022-5403
3/4"
(120028) 022-5404
pk 12



81081



81084



86664



10006

SILLCOCK HANDLES

DANCO

Item	Pack	Part #	HDI #
Square Broach - For square stem. 1 per card			
1/4" Wheel Handle	6	81081	87654
5/16" Wheel Handle	6	80416	87648
Round Broach - 1 per card			
12 pt. Wheel Handle	6	81084	87390
16 pt. Wheel Handle	6	80417	87650
Mansfield Frostproof Sillcock Replacement Handle			
Metal	6	88664	87676
Plastic	6	88754	87684
Tee Handles - 1 per card			
12 pt. Tee Handle	3	88685	87682
16 pt. Tee Handle	3	88683	87678
Square Tee Handles - 1 per card			
5/16"	3	88684	87680
Universal Outdoor Faucet Handle - Larger design is easier to grasp. Includes adapters. Universal design fits American Value, Arrowhead Brass, Mansfield, Moen, Mueller, Nibco, and Woodford.			
	6	10006	88386



SILLCOCK KEY

DANCO

Item	Pack	Part #	HDI #
For Square Stem. 1 per card			
	6	80132	85152



STOP & WASTE VALVE REPLACEMENT CAP

LDR

Item	Pack	Part #	HDI #
Includes rubber gasket. 2 per bag			
Small 5/16-24	25	020-5406	120135



WHEEL HANDLE FOR WOODFORD

DANCO

Item	Pack	Part #	HDI #
For Woodford Freezeless Wall Hydrant			
Metal	3	88863	87688
Plastic	3	88864	87690



PLUMBING & HEATING



FORGED BRASS BALL VALVE

LDR
Lead Free
Designed for use of steam, water, oil, or gas in residential, commercial, or industrial applications.
150 psi WSP steam
600 psi non-shock WOG

Full port
FIP threaded connection
1/4"
(110453) 22-2201
3/8"
(110455) 022-2232
pk 12

1/2"
(110447) 022-2233
3/4
(110448) 022-2234
1"
(110449) 022-2235
pk 6

1 1/4"
(110450) 022-2236
1 1/2"
(110451) 022-2237
2"
(110452) 022-2238
pk 2

Conventional Port Solder Connection



1/2"
(110462) 022-2270
3/4"
(110463) 022-2271
pk 6

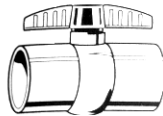

PVC BALL VALVE

LDR
White schedule 40 PVC fits both schedule 40 and schedule 80 PVC pipe. Quarter turn operation. Solvent weld ends.

1/2"
(120160) 024-BV-12
pk 10

3/4
(120161) 024-BV-34
pk 10

1"
(120162) 024-BV-1

1 1/4
(120163) 024-BV-114

1 1/2"
(120164) 024-BV-112
pk 5

2"
(120165) 024-BV-2
pk 2

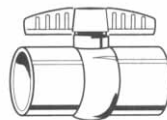

CPVC BALL VALVE

LDR
CPVC construction for use with CPVC pipe with hot or cold water. Quarter turn operation. Solvent weld ends.

1/2"
(120150) 027-BV-12

3/4"
(120151) 027-BV-34
pk 10



STAINLESS STEEL BALL VALVE

BOSHART
Max Temp Rating: 450⁰F (232⁰C).
Blow-out proof stem. Stainless Steel ball. PTFE Seats / PTFE Stem packing. NSF/ANSI Standard 372 Certified.

1/2"
(40207) PEBVSS-805
pk 9

3/4"
(40208) PEBVSS-807
pk 6

1"
(40209) PEBVSS-810
pk 4

1 1/4"
(40210) PEBVSS-812
pk 2

1 1/2"
(40211) PEBVSS-815
pk 6

2"
(40212) PEBVSS-820
pk 3



PLUMBING & HEATING



FOOT VALVE

Boshart
Bronze body with brass strainer.
Rubber poppet. FIP connection.
Used normally at the bottom of a
pump suction line to prevent loss
of prime.

- $\frac{3}{4}$ "
(40308) PENL-FV075
- 1"
(40309) PENL-FV100
- 1 $\frac{1}{4}$ "
(40310) PENL-FV125
- 2"
(40312) PEFVB-200
pk 1



RELIEF VALVE

CASH ACME
 $\frac{3}{4}$ x $\frac{3}{4}$ " 150# psi. Temperature
and pressure. UL listed. AGA
certified. With test lever. 3"
probe.
Boxed.

- (85959) NCLX-5
pk 1



CHECK VALVE

Boshart
No Lead
Bronze body. Use in any system
where back flow is not desired.
Works in all positions. FIP
threaded connection.

- $\frac{1}{2}$ "
(40201) PE-NL-CV050
- $\frac{3}{4}$ "
(40202) PE-NL-CV075
- 1"
(40203) PE-NL-CV100
- 1 $\frac{1}{4}$ "
(40204) PE-NL-CV125
- 1 $\frac{1}{2}$ "
(40205) PE-NL-CV150
- 2"
(40206) PE-NL-CV200
pk 1

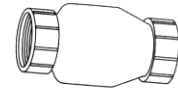

CHECK VALVE

LDR
Hi-impact PVC
Use in any system where back
flow is not desired.
 $\frac{1}{4}$ pound spring gives positive
seat even when there is no back
pressure. Reinforced poppet. UL
listed. FIP threaded connections.

- $\frac{1}{2}$ "
(121015) 024-CVT-12
- $\frac{3}{4}$ "
(121016) 024-CVT-34
pk 10
- 1"
(121017) FP4-CVT-1
pk 8
- 1 $\frac{1}{4}$ "
(121018) 024-CVT-114
pk 6
- 1 $\frac{1}{2}$ "
(121019) 024-CVT-112
- 2"
(121020) 024-CVT-2
pk 4



PLUMBING & HEATING



SHOWER FAUCETS

LDR

Item	Pack	Part #	HDI #
Tub Filler & Shower Faucet - 8" centers. Brass body, heavy duty chrome plated with acrylic handles. 1/2" combination unions for threaded or solder installation. Replaceable quarter turn washerless cartridge.			
2 Valve Diverter	3	011-8700	126016
Tub & Shower Faucet - 8" centers. Brass body, heavy chrome plated with acrylic handles. 1/2" combination unions for threaded or solder installation. Replaceable quarter turn washerless cartridge.			
3 Valve Diverter	6	011-8500	120093
Single Valve Shower Faucet - Shower only chrome faucet.			
	6	011-7600	126030
Single Handle Tub & Shower - Acrylic handle, metal ball, machined brass washerless control valve. Chrome plated with 1/2" FIP			
	6	11-7100	126032

SHOWER REPAIR



89171

DANCO

Item	Pack	Part #	HDI #
Shower Shut-off Valve - For use between shower arm & showerhead. 1/2" IPS Female x 1/2" IPS Male Brass			
	3	89171	87942

SHOWER BLASTER



DANCO

Item	Pack	Part #	HDI #
Quick connect adapters allow for easy snap on connection to shower arm; Powerful jet spray; Press and release trigger saves water; 7' long hose			
Chrome	3	10074	86434



HAND HELD SHOWER HEADS

LDR

Item	Pack	Part #	HDI #
Bath Spray Hose - Molded bristle head. Fits most faucet spouts 5/8" to 1 1/8" diameter. 1 per box.			
	5	502-2900	85019
Shampoo Spray - Slips over tub spouts. Includes adjustable wall bracket. With molded bristle accessory.			
	3	502-2950	86444

DANCO

Item	Pack	Part #	HDI #
Luxtra Hand-Held Shower Assembly - Water saving design - reduces flow to 2.5 gpm. Adjustable spray and pulse function. Includes: Shower Head, 59" Hose, Wall Bracket			
White	1	26963	86438

PET SPA BATHING SYSTEM



DANCO

Item	Pack	Part #	HDI #
4 Comfort settings for a gentle rinse and clean 7-foot hose Easy switch in 3 steps Indoor and outdoor use Have fun washing your pet			
Chrome	3	10075	86441



PLUMBING & HEATING



520-5305WT
520-3325WT

89202

80779

89077

80768

80480

89245

SHOWERHEADS

LDR

Item	Pack	Part #	HDI #
Massage Showerhead - Fits all 1/2" IPS shower arms. Water saving design - reduces flow to 2.5 gpm.			
5 Function - White	2	520-5305WT	86436
3 Function - White	2	520-3325WT	86435

DANCO

Item	Pack	Part #	HDI #
Adjustable Showerhead - 1/2" IPS connection. Brass. Adjustable water jets. Energy saving - reduces flow to 2.5 gpm			
4-Jet	3	89202	87946
6-Jet	3	89203	87948
Luxtra Economy Showerhead - Full spray. Water saving design - reduces flow to 2.5 gpm. Easy do-it-yourself installation. Guaranteed Reliability			
ABS Shower Head White	3	26968	86442
Energy Saving Showerhead - 1/2" IPS connection. Chrome plated ABS. 1/2" IPS Ball-Joint. Reduces flow to 2.5 gpm			
Carded	3	80779	87868
Energy Saver Showerhead - 1/2" IPS connection. Solid Brass. Energy saving - reduces flow to 2.5 gpm			
Carded	3	89077	87936
Premium Showerhead - 1/2" IPS connection. Face diameter 1 11/16". Flow control washer. Energy saving - reduces flow to 2.5 gpm.			
Chrome Plated	3	80768	87864
Energy Saving Showerhead - Chrome plated ABS. 1/2" IPS Ball-joint. Reduces flow to 2.5 gpm			
	3	80480	87854
Premium Showerhead - Scratch resistant finish. Will not tarnish or fade. Solid brass with brass ball joint. Energy saving - reduces flow to 2.5 gpm			
Brushed Nickel	3	89245	87966



PP8050AL

PP22521

80924

88214

89172

SHOWER RODS & FLANGES

PLUMB PAK

Item	Pack	Part #	HDI #
Shower Rod - 1" x 60" tubular aluminum with flanges.			
	10	PP8050AL	123345

DANCO

Item	Pack	Part #	HDI #
Shower Rod Flange - Chrome plated. Fits standard round shower rods. Includes screws. Carded			
	3	89172	87944
Adjustable Shower Curtain Rod Holder - Plastic ABS. Pressure sensitive backing. 1 per card.			
	3	80924	87874
Shower Curtain Rod Holders - For standard 1" diameter shower rods. Mounting screws included.			
2 per card	3	88214	87890



SHOWER ARMS & FLANGES

DANCO

Item	Pack	Part #	HDI #
Shower Arm - 8" metal shower arm and flange. 1/2" IPS, Bell-Style Flange			
Chrome Plated	3	80769	87866
Shower Arm & Flange - 1/2" IPS			
6" Brass	3	89180	87984
6" Oil Rubbed Bronze	3	89411	87986



PLUMBING & HEATING



SHOWER CURTAIN HOOKS

KENNEY

Item	Pack	Part #	HDI #
12 per package			
Poly Bag	25	960	860158

DANCO

Item	Pack	Part #	HDI #
Shower Curtain Hooks - Chrome plated. Use on standard 1" diameter shower rods. Packaged 12 per card			
	3	89046	87930



SHOWER GUARDS

DANCO

Item	Pack	Part #	HDI #
Stops after shower mop-ups. Protects walls & floors. Packaged in pairs.			
7" High, White	5	88108	87882



10001



10004



10003



10004

TUB & SHOWER TRIM KIT

DANCO

Item	Pack	Part #	HDI #
Moen Tub/Shower - Give your shower a new look by installing an updated trim kit. Replacement is easy and only requires a screwdriver. offering two handle options, you can choose which style works best for yu bath. Kit replaces Moen Moentrol 2200, 2400, 2600 and 2700 series with and without diverters in chrome and Moen Posi Temp(R) series 2300 with and without diverters in chrome. Includes: 2 handle options, screws, adapters and Allen wrench. Metal handle style only works with valves without diverters. Easy to install.			
Chrome	2	10001	88392
Brushed Nickel	2	10002	88394
Delta Tub/Shower - Give your shower a new look by installing an updated trim kit. Replacement is easy and only requires a screwdriver. offering two handle options, you can choose which style works best for your bath. Kit replaces Delta 600 series with and without diverters in chrome (#70 or #212 Ball) and Delta Monitor 14 series (without volume control) with and without diverters in chrome. Includes: 2 handle options, screws, adapters and Allen wrench. Metal handle style only works with valves without diverters. Easy to install.			
Chrome	2	10003	88396
Brushed Nickel	2	10004	88398



PLUMBING & HEATING



TUB FAUCETS

DANCO

Item	Pack	Part #	HDI #
Tub Spout w/Diverter - Installs on 1/2" IPS connection. Die Cast. Front Connection.			
Chrome	3	88052	87880
Tub Spout w/Diverter - Installs on 1/2" or 3/4" IPS connections. Personal shower connection included.			
Chrome	3	34230	85408
Universal Tub Spouts Less Diverter - Fast & easy install. Includes adapters, allen wrench, & plumbers tape. Installs on existing connections: 1/2" coppler slip fit, 1/2" thread, 1/2" thread in nose, 3/4" thread.			
Chrome	3	88702	87908
Brushed Nickel	3	89247	87968
Tub Spout w/Diverter - 1/2" or 3/4" IPS. Die Cast. Front Connection.			
Chrome	3	80765	87860
Adjustable Tub Spout - Installs on 1/2" slip connection. Chrome plated die cast. Set Screw. Rear connection.			
Less Diverter	3	89162	85409
With Diverter	3	88434	87900
Universal Tub Spouts w/Diverter - Fast & easy install. Includes adapters, allen wrench, & plumbers tape. Installs on existing connections: 1/2" coppler slip fit, 1/2" thread, 1/2" thread in nose, 3/4" thread.			
Chrome	3	88703	87910
Chrome, Personal Shower Adapter	6	89266	87980
Brushed Nickel	3	89249	87970
Brushed Nickel, Personal Shower Adapter	6	89263	87976
Polished Brass	6	89265	87978
Tub Spout w/Diverter - 1/2" or 3/4" IPS. Die Cast. Front Connection.			
Chrome	3	80764	87858

BATHTUB COUPLING



DANCO

89131

Item	Pack	Part #	HDI #
Bathtub Coupling Kit - For old-fashioned tubs with legs. Attaches faucet to pipes. 2 per card.			
	3	89131	87938



TUB & SHOWER REPAIR

OATEY

Item	Pack	Part #	HDI #
No-Calk Shower Drain - Designed for use with pre-formed shower bases: fiberglass, acrylic, nylon, or metal. Mechanically attaches over 2" Sch. 40 DWV pipe. Fiber and rubber gasket provides a tight seal to the base. 4 1/4" snap-in strainer.			
2"	12	42099	155023

DANCO

Item	Pack	Part #	HDI #
Tub Drain Conversion Assemblies - Converts bath drains to a push close-push open style.			
Cartridge Gasket	3	88209	87888
Bath Shoe - Chrome	3	89204	87950
Stopper Cartridge 5/16 Stud Brushed Nickel	3	89260	87974
Stopper Cartridge 5/16" & 3/8" Stud Chrome	3	80811	87872
Touch-Toe Style Tub Drain Assemblies - Complete assembly comes with stopper cartridge, overflow plate, bath shoe, plastic adapter bushing.			
Chrome	3	88981A	87928
Brushed Nickel	3	89237A	87958
Lift & Twist Style Tub Drain Assemblies - Complete assembly with stopper cartridge, overflow plate, bath shoe, plastic adapter bushing.			
Brushed Nickel	3	89239A	87960
Trip Lever Style Tub Drain Assemblies - Complete assembly with stopper cartridge, overflow plate, bath shoe, plastic adapter bushing.			
Chrome	3	80977	87876
Brushed Nickel	3	89242	87964
Repair Kit for Tub Spout Diverter - Repairs most diverter tub spouts.			
	3	89205	87952



PLUMBING & HEATING



BATH DRAIN STOPPERS

DANCO

Item	Pack	Part #	HDI #
Replacement Stoppers for "Rapid-Fit" Bath Drains			
3/8"	3	88194	87884
5/16"	3	88195	87886
Lift & Twist Replacement Stopper - For use in place of foot operated stopper made by Rapid Fit, Sterling, Casper's, Duracraft			
Chrome	3	88599	87906
Brushed Nickel	3	89258	87972



BATH DRAIN REPAIRS

DANCO

Item	Pack	Part #	HDI #
Universal Linkage & Plunger			
	3	88924	87918
Universal Drain Strainer			
Brushed Nickel	3	89269	87982
Strainer for Gerber - New style trip waste			
	3	88926	87920
Tub Drain Strainer			
Chrome	3	88930	87922



BATH OVERFLOW PLATE SCREWS

DANCO

Item	Pack	Part #	HDI #
1 1/2" x 1/4" x 20 thread. Packaged 2 per card			
Chrome Plated	6	88933	87926



TUB & SHOWER REPAIR

DANCO

Item	Pack	Part #	HDI #
Bath Waste & Overflow - White Plastic & Chrome Finish			
Trip Lever	1	51932	87378
EZ Touch	1	51930	87376
Twist 'N' Close	1	51933	87380
Bath & Waste Overflow - 20 gauge brass. Comes boxed.			
Trip Lever	1	50962	123385
EZ Touch	1	94951	123490
Bath Overflow Plates - Chrome plated. Complete w/ Screws. Screw holes 2" Center to Center			
Round w/Lever Chrome	3	80991	87878
Round One-Hole Chrome	3	89052	87932
Round w/Lever Brushed Nickel	3	89231	87954
Round One-Hole Brushed Nickel	3	89235	87956
Round w/Lever Oil Rubbed Bronze	3	89472	87988
Round One-Hole Oil Rubbed Bronze	3	89473	87990
Flat Bath Shoe Gasket - Quality rubber gasket can be used on a wide range of bath shoes or tub drains.			
2 15/16" OD, 1 7/8" ID, 3/8" Thick	1	36550B	86329
2 15/16" OD, 1 7/8" ID, 3/8" Thick	6	88349	87894
Flat Bath Shoe Gasket - Used between the tub and the shank nut on the bath shoe or tub drain.			
3" OD, 1 7/8" ID, 1/8" Thick	3	88416	87898
Overflow Plate Gasket - Quality sponge rubber gasket is entirely adjustable and can be used on all connected waste and overflow connections.			
3 3/16" OD, 2 1/8" ID	1	36548B	86328
3 3/16" OD, 2 1/8" ID	3	88350	87896
Waste Shoe - Heavy gauge brass construction. 11 1/2" threads per inch.			
	1	86721	123425



PLUMBING & HEATING



LAVATORY FAUCETS

KITCHEN FAUCETS

LDR

LDR

Item	Pack	Part #	HDI #	
Laundry Tray Faucet Rough Brass - Brass tubular spout, cast brass body. Top feed brass waterway, brass compression stems.				
	12	011-5300	120098	
Laundry Tray Faucet - Double acrylic handles, brass compressions stems, brass tubular spout, brass waterway.				
	12	011-5200	120099	
Code Pattern Bath Cock - Polished chrome, gooseneck spout, cast brass, replaceable seats and stems, 3-3/8" center metal double handles.				
	24	011-5950	120095	
Single Basin Faucet - Standard. Chrome plated brass construction, replaceable seat and stem. Packed with hot and cold index buttons.				
	1/2"	12	011-5700	120072
Lavatory - 4" centers. All brass waterway with metal housing. Chrome finish. Acrylic single handle. Washerless cartridge.				
With ABS Pop-up	6	011-2120CP	126005	
Lavatory - Plastic waterway. 4" centers. Chrome finish. Acrylic handles Washerless cartridge.				
Less Pop-up	6	011-4170CP	126013	
With Pop-up	6	011-4120CP	120078	
Lavatory - Non-Metallic, Lead Free. Includes pop-up, ceramic cartridge. lever handle, 4" center set, Chrome				
With ABS Pop-up	3	952-22305CP	126006	

Item	Pack	Part #	HDI #
Kitchen Faucet - Plastic Waterway Acrylic handles, brass "D" spout, washerless. Chrome Finish			
Less Hose & Spray	6	011-3101	126014
With Hose & Spray	6	011-3401	126010
Kitchen Faucet - Chrome Finish. All brass waterway with metal housing. Lever handle. Washerless with replaceable ball and seats.			
Less Hose & Spray	3	011-1101	126011
With Hose & Spray	3	011-1401	126012
Kitchen Faucet - Dual Acrylic Handle Non-Metalic Kitchen Faucet without spray, chrome			
	6	012-3105CP	120097



PLUMBING & HEATING



80760



80762



81049



88266



89215



80830



80247



89225

SINK SPRAY HEADS & HOSE & ACCESSORIES

DANCO

Item	Pack	Part #	HDI #
Repairs for Spray head assembly - Spray head will attach to any existing spray hose to replace the on/off spray head.			
Spray Head Only, Black	3	80760	87736
Spray Head Only, White	3	88740	87816
Spray Head Only, Chrome	3	88760	87818
Spray Head Only, Brushed Nickel	3	89270	87844
Universal Sink Spray Hose, Clear	3	80761	87738
Universal Spray Head & Hose Assembly, Black	3	80762	87740
Universal Spray Head & Hose Assembly, White	3	16560	87696
Universal Spray Head & Hose Assembly, Chrome	3	88814	87820
Replacement Kitchen Pull-out Hose & Heads for Pull-out Faucets - Fits American Standard, Delta/Peerless, Euro, Grohe, Glacier Bay, Kohler, KWC, Moen, Price Pfister, Sterling, Universal Rundle/Milwaukee/Carefree & Valley			
Kitchen Faucet Sprayer Only Chrome	3	81049	87756
Kitchen Faucet Sprayer Only White	3	81050	87758
Kitchen Faucet Sprayer Only Brushed Nickel	3	89223	87838
Pull-out Hose	4	88266	87790
Decorative Kitchen Sink Spray - New quick connect adapter allows for easy snap-on connection to most faucets. Universal design even works with new Moen, Delta, and Kohler styles. New kink resistant.			
Chrome	3	89215	88388
Brushed Nickel	3	89216	88390

SINK SPRAY HEADS & HOSE & ACCESSORIES

DANCO

Item	Pack	Part #	HDI #
Spray Hose Guides - High impact plastic core to prevent excessive hose wear. The 2" raised excutcheon prevents water from running into the area under the sink.			
Chrome	3	86948	87788
PVD Brushed Nickel	3	89225	87840
Faucet Hole Covers			
Bolt Style 1 3/4" Chrome	6	80830	87750
Snap-in Style 1 1/4" Chrome	6	80246	87722
Snap-in Style 1 1/2" Chrome	6	80247	87724



10037



10038

SOAP DISPENSER

DANCO

Item	Pack	Part #	HDI #
Soap Dispenser Straight - 4-foot hose with universal plug fits most one-gallon soap bottles or top fill under-counter mount with 12-ounce bottle. Longer shank fits any countertop. Install with or without bottle. Microban built-in antimicrobial protection.			
Chrome	3	10037	85404
Soap Dispenser Curved - 4-foot hose with universal plug fits most one-gallon soap bottles or top fill under-counter mount with 12-ounce bottle. Longer shank fits any countertop. Install with or without bottle. Microban built-in antimicrobial protection.			
Chrome	3	10038	85405



PLUMBING & HEATING



80701



80702

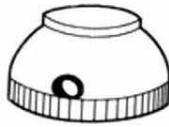

88756

DELTA / PEERLESS FAUCET REPAIR

DANCO

Item	Pack	Part #	HDI #
DL-3 Repair Kit - For Delta. Fits all faucets with #70 ball. Includes wrench.	5	80701	87458
DL-4 Seats & Springs - Repairs for faucets manufactured prior to 1976	6	80703	87462
DL-5 Spray Diverter - For Delta	6	80093	87438
DL-7 Repair Kit - For Delta/Peerless Faucets. Fits all faucets with #212 ball. Includes wrench.	5	80702	87460
DL-9 Seats & Springs - Repairs for faucets manufactured after 1976.	6	80684	87452
DL-10 Single Lever Bath Cartridge - For Delta Scald-Guard tub/shower faucets	3	80964	87468
DL-11 Repair Kit - For Delta Scald Guard	6	80465	87442
DL-15 Spout O-Rings - Used on most popular kitchen faucets. For Delta	6	80973	87472
DL-16 Single Lever Bath Diverter - Used on most popular tub/shower faucets	3	80971	87470
DL-17 Seats & Springs - For Delta/Peerless	6	88050	87488
Cap Assembly - Used on most popular kitchen, lavatory, and tub/shower faucets. Chrome plated.	3	88756	87514



80973



88050



18003W



88101

DELTA / PEERLESS FAUCET REPAIR

DANCO

Item	Pack	Part #	HDI #
Replacement Seats & Springs - For Delta, Delex, & Peerless Single Control Faucets.	1	18003W	85194
Short Seat	1	18013W	85195
#70 Style Replacement Ball - For Delta Single Lever Faucets. Used on most popular kitchen, lavatory, and tub/shower faucets with lever style handles.	1	80698	85083
DL-2 Plastic	6	88119	87500
#212 Style Replacement Ball - Used on most popular kitchen, lavatory, and tub/shower faucets with knob style handles	6	88120	87502
DL-18 Stainless Steel	6	88101	87660
DL-19 Stainless Steel	6	88103	87490
Seats & Springs for Delex	6	80704	87104
Delta Monitor Cartridge Assembly	3	30801	87434
Universal Seats & Springs - For Delta	6	86968	87480
Faucet Repair Kit - Used with #70 Stainless Steel ball. Includes hex wrench.	6	86970	87482
Faucet Repair Kit - Use with #212 Stainless Steel ball	6	86971	87484
Faucet Stem Repair Kit - Fits stems 3S-1, 3S-2	3	88101	87660
Faucet Repair Kit - Fits faucet with Either #70 or #212 ball. Includes Wrench	3	88103	87490
Single Lever Cam Assembly - Used on most popular kitchen, lavatory, and tub/shower faucets with lever style handles. Use with #70 ball	6	88104	87492
Single Lever Cam Assembly - Used on most popular kitchen, lavatory, and tub/shower faucets with knob style handles. Use with #212 ball	6	88105	87494



PLUMBING & HEATING



BRADLEY-COLE FAUCET REPAIR

DANCO

Item	Pack	Part #	HDI #
BR-1 Single Lever Cartridge Kit - Used on Kitchen, Lavatory and Bath faucets. Complete with Cam			
	3	80461	87440



GLACIER BAY REPAIR

DANCO

Item	Pack	Part #	HDI #
GB-1 Ceramic Cartridge for Lav Faucet			
	3	89902	100301



KOHLER REPAIR

DANCO

Item	Pack	Part #	HDI #
KO-1 Cartridge for Coralis Lav/Tub/Shower			
	3	88739	100299



MILWAUKEE FAUCET REPAIR

DANCO

Item	Pack	Part #	HDI #
Seats & Springs -For stems 2S-1H/C, 3S-7H/C, 4S-6H/C			
	6	88005	87120



DANCO

Item	Pack	Part #	HDI #
MO-1 Brass Cartridge - Used on most popular kitchen, lavatory, and tub/shower faucets			
	3	80993	87476
MO-2 Cartridge Repair Kit - For Moen Brass Cartridges			
	6	80491	87444
MO-4 Cartridge Repair Kit - For Moen Plastic Cartridges			
	6	80500	87446
MO-5 "O" Ring Repair Kit - For Moen Spouts			
	3	80502	87448
MO-8 Plastic Cartridge - Used on most popular kitchen, lavatory, and tub/shower faucets			
	3	88431	85955
MO-9 Cartridge - Designed and manufactured to exceed the highest quality standards. Includes plastic installation wrench			
	3	88675	87510
Faucet Repair Kit - For Moen single handle brass cartridge			
	6	86647	87478
Cartridge Repair Kit - For Moen Posi-Temp			
	3	88538	87508



PRICE PFISTER FAUCET REPAIR

DANCO

Item	Pack	Part #	HDI #
PP-8 Single Lever Cartridge - Used on Avante Kitchen, Lavatory, and Tub/Shower faucets			
	3	80550	87450
PP-15 Ceramic Faucet Cartridge - Used on model 533 Kitchen Faucets with Pull-Out Sprayhead.			
	3	41034	87802
	3	89051	87516



PLUMBING & HEATING



88100

STERLING FAUCET REPAIR

DANCO

Item	Pack	Part #	HDI #
Seats & Springs Assembly - Used on Hybrid Tub/Shower faucets model numbers 021 thru 026			
	3	88745	87512
Faucet Stem Repair Kits - For 3Z-7, 8, 14 (with seats & springs)			
	6	88100	87658



88197

88118

VALLEY FAUCET REPAIR

DANCO

Item	Pack	Part #	HDI #
VA-1 Single Lever Cartridge - Used on most popular kitchen, lavatory, and tub/shower faucets manufactured before October 1986			
	3	80978	87474
VA-2 Seals & Springs - Used on most popular kitchen, lavatory, and tub/shower faucets manufactured before October 1986			
2 Per Package	6	80686	87454
VA-3 Single Lever Faucet Repair Kit - Used on most popular kitchen faucets manufactured before October 1986 with V-6680 cartridge. Includes Hex Wrench			
	6	80688	87456
Faucet Cartridge - Used on most popular kitchen and lavatory faucets manufactured after 1986.			
VA-4 Less Diverter	3	88197	87504
VA-5 With Diverter	3	88198	87506
VA-500 "O" Ring Repair Kit - For lavatory and kitchen faucets manufactured after October 1986			
	3	88117	87496
OEM Seats & Springs - For Delta single control lavatory and bath faucets			
	6	88118	87498



PLUMBING & HEATING



10515



10506



10509



10514

DISHWASHER ADAPTERS

DANCO

Item	Pack	Part #	HDI #
Dishwasher Aerator - Long aerator. Female. 55/64", 27 Thread	6	10515	85016
Snap Nipple for Dishwashers - Dual thread 55/64" 27 thread or 15/16" 27 thread.	6	10506	85014
Dishwasher Aerator Adapter - Nickel Plated Brass. Complete w/Washer.			
55/64" - 27T Female x 3/4" Male Hose Thread x 15/16" 27T Male	6	10509	85011
15/16" 27T Female x 3/4" Male Hose Thread	6	10512	87236
55/64" 27T Male x 3/4" Female Hose Thread	6	10511	87238
15/16" 27T Dual x 3/4" Male Hose Thread x Std. Dishwasher Thread	6	10513	87240
Couplings for Dishwashers - 3/4" male hose thread with built-in snap nipple 27T female.			
	6	10521	87234
Clamp-on Dishwasher Adapter - Metal parts - Chrome Plated Brass. Hose adapter 9/16" ID Hose x 3/4" Male Hose Thread			
	6	10514	85022



DISHWASHER AERATOR

DANCO

Item	Pack	Part #	HDI #
Large dishwasher snap adapter dual thread. 55/64" 27T or 15/16" 27T	6	10507	87242



10487



10488



10476



10501



10500
AERATORS



10499



81072



89288



10486

DANCO

Item	Pack	Part #	HDI #
2.0 GPM Aerators - Reduces waterflow to 2.0 gpm. Slotless design			
Chrome Small Male 13/16"	6	10487	85005
Chrome Female 3/4" x 27T for Male Spout	6	10488	85012
Polished Brass Univer. 15/16"	6	10478	87228
Chrome Female 15/16"	6	10481	85003
Chrome Universal 15/16"	6	10476	85002
Chrome Male 15/16"	6	10483	85001
PVD Brushed Nickel Universal 15/16"	6	10477	87266
Swivel Aerator - Swivels a full 360°. Universal fit. Chrome plated. Enables cleaning and rinsing of those hard to reach corners in sinks and basins.			
Dual Thread 55/64" or 15/16"	6	10500	85004
Premium Sprayrator - Swivels a full 360° to every corner of the sink. Dual thread 15/16". Push-Pull feature allows for choice of stream or spray. Fits 98% of faucets.			
2.0 gpm Carded	3	10499	85024
Rubber Aerators w/Spray			
Slip On	3	81072	85038
Screw On	3	88271	87264
Quick Rinse Swivel Spray Aerators - New sleek design w/exceptional performance. Compact design allows use in either kitchen or lavatory sink. Swivels 360°. Dual thread 55/64" x 27T or 15/16" x 27T			
2.0 gpm Chrome	6	10501	87254
2.0 gpm PVD Brushed Nickel	6	89211	87268
Decorative Aerators - 2.0 gpm. Includes adapters to allow for both male and female application			
Bell Style PVD Polished Brass	3	89288	87270
Bell Style Chrome	3	89438	87272
Bell Style PVD Brushed Nickel	3	89439	87274
Water-Saving Aerators - 15/16 in x 27M thread x 55/64 in x 27F dual thread, watersaving, removable/replaceable insert, microban, laminar spray pattern applications.			
1.5 gpm. - chrome	3	10486	85154



PLUMBING & HEATING



10520



10510



10519

AERATOR ADAPTERS

DANCO

Item	Pack	Part #	HDI #
Adapters for Spouts w/Female Threads - Nickel plated brass. Complete with washers.			
15/16" 27 thread All Manufacturers	6	10520	85020
13/16" 27 thread. Kohler, Central, Union-Brass, Indiana Brass, Speakman, Chicago	6	10508	87232
Adapters for Spouts w/Male Threads - Nickel plated brass. Complete with washers.			
13/16" 24 thread Chicago faucet w/outside male thread	6	10510	87244
3/4" 27 thread Kohler, Price-Pfister	6	10519	87246

AERATOR REPAIR

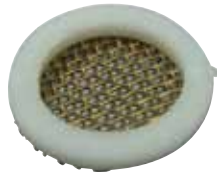

DANCO

Item	Pack	Part #	HDI #
Aerator Washer & Screen - This washer is used between the end of the spout and aerator. Contains (1) 36173, and (1) 36190			
	3	89133	85007



AERATOR SEALING WASHERS

DANCO

Item	Pack	Part #	HDI #
Assorted Aerator Sealing Washers - Contains 5 assorted washers. For 13/16" x 15/16" aerators			
	6	36450B	87258



STREAM REGULATORS & SCREENS

DANCO

Item	Pack	Part #	HDI #
Used in place of an aerator on all 13/16" or 15/16" spouts having a male thread. Triple chrome plated brass			
15/16" Female Retainer w/Screen & Washer	6	36191E	87262



AERATOR GAUGE

DANCO

Item	Pack	Part #	HDI #
	6	60989	87276



PLUMBING & HEATING



FAUCET WASHERS

DANCO

Item	Pack	Part #	HDI #
Tough, flexible, positive shut-off. High abrasive resistance, high temperature resistance. Sold/Price Per Kit			
Flat Washers - Bulk			
00 (30 per box)	1	35062K	86267
0 (24 per box)	1	35063K	86269
1/4 (24 per box)	1	35064K	86271
1/4M (24 per box)	1	35074K	86273
1/4L (20 per box)	1	35065K	86275
3/8 (18 per box)	1	35066K	86277
3/8M (18 per box)	1	35067K	86279
3/8L (16 per box)	1	36068K	86281
1/2 (12 per box)	1	35069K	86283
Flat Washers - 10 per Card			
00	6	88569	87122
0	6	88570	87124
1/4	6	88571	87126
1/4M	6	88572	87128
1/4L	6	88573	87130
3/8	6	88574	87132
3/8M	6	88575	87134
3/8L	6	88576	87136
1/2	6	88577	87662
1/2L	6	88578	87664
Beveled Washers - Bulk			
000 (30 per Box)	1	35089K	86255
00 (30 per box)	1	35090K	86257
0 (24 per box)	1	35091K	86258
1/4 (24 per box)	1	35092K	86259
1/4L (20 per box)	1	35093K	86261
3/8 (18 per box)	1	35094K	86263
3/8M (18 per box)	1	35095K	86264
3/8L (16 per box)	1	35096K	86265
Beveled Washers - 10 per card			
00	6	88579	87666
0	6	88580	87668
1/4	6	88581	87670
1/4L	6	88582	87672
3/8L	6	88585	87674
Assortments - 100 per pack			
Flat Washers	3	34441	87636
Beveled Washers	3	34442	87638



FAUCET WASHER ASSORTMENTS

DANCO

Item	Pack	Part #	HDI #
Assorted Faucet Washers - Flat - 14 washers and 6 brass screws. Rubber			
Carded	6	80790	87110
Assorted Faucet Washers - Beveled - 14 washers and 6 brass screws. Rubber			
Carded	6	80789	87108
Home Washer Assortment - Contains: Faucet Washers, Hose Washers, Slip Joint Washers, "O" Rings, Sink Strainer Washers, Bibb Screws.			
42 pc. Assortment	6	80817	87116

FAUCET SCREWS



DANCO

Item	Pack	Part #	HDI #
Screw Assortment - Contains 3 each of 35141 and 35153			
	6	85194	87118



PLUMBING & HEATING

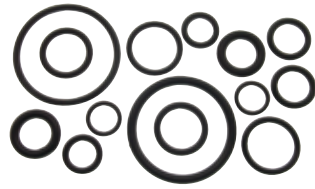

FAUCET "O" RINGS

DANCO

Item	Pack	Part #	HDI #
Rubber "O" Rings Assortment - Contains: 2 each of 35721, 35724, 35725, 35726, 35728, 35729, and 1 each of 35739, 35748	10	80788	87106
#8 "O" Rings - 9/16" OD x 3/8" ID x 3/32" Wall. 10 per card	6	96725	87144



80793



80794

STEM PACKING

DANCO

Item	Pack	Part #	HDI #
Graphite Packing - Self forming. Contains rubber and zinc oxides.			
3/32" x 24"	6	80793	87112
TEF Packing			
3/32" x 36" Rope	6	80794	87114
5/32" x 18" Rope	3	80074	87094



35231C



35189

BONNET PACKING

DANCO

Item	Pack	Part #	HDI #
Universal Felt. Carded			
11/16 x 3/8 x 5/16	6	35231C	87088
7/8 x 9/32 x 13/32	6	35232C	87090
5/8 x 3/8 x 15/16	6	35233C	87640
Univeral Ruddle. Milwaukee facuet, Price Pfister, Sayco, Rheem, Repeal, Chase Bros.			
10	1	35189	86135

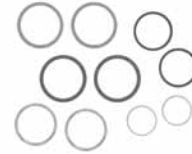

CAP THREAD GASKET ASSORTMENT

DANCO

Item	Pack	Part #	HDI #
Contains 2 each of 35549, 35562, 35564, 35570, 35574	6	80229	87096



PLUMBING & HEATING



“O” RINGS

DANCO

Item	Pack	Part #	HDI #
OD x ID x Thickness [pc per pack]		sold/price per pack	
5/16 x 3/16 x 1/16 [36]	1	#36 35750K	85314
3/8 x 1/4 x 1/16 [36]	1	#5 35722K	85244
7/16 x 5/16 x 1/16 [36]	1	#6 35723K	85240
1/2 x 3/8 x 1/16 [36]	1	#7 35724K	85270
9/16 x 5/16 x 1/8 [36]	1	#31 35745K	85286
9/16 x 3/8 x 3/32 [36]	1	#8 35725K	85252
9/16 x 7/16 x 1/16 [36]	1	#41 35755K	85245
5/8 x 3/8 x 1/8 (12)	1	#48 35762K	85251
5/8 x 7/16 x 3/32 [36]	1	#9 35726K	85246
5/8 x 15/32 x 3/64 [36]	1	#21 35738K	85282
5/8 x 1/2 x 1/16 [36]	1	#28 35742K	85236
21/32 x 13/32 x 1/8 [24]	1	#1 35721K	85266
11/16 x 1/2 x 3/32 [36]	1	#10 35727K	85238
11/16 x 1/2 x 3/32 (24)	1	#42 35756K	85247
11/16 x 9/16 x 1/16 [36]	1	#54 35768K	85258
3/4 x 9/16 x 3/32 [30]	1	#11 35728K	85248
3/4 x 5/8 x 1/16 [36]	1	#40 35754K	85296
13/16 x 5/8 x 3/32 [24]	1	#12 35729K	85254
13/16 x 11/16 x 1/16 [36]	1	#67 35784K	85316
7/8 x 11/16 x 3/32 [24]	1	#13 35730K	85250
7/8 x 3/4 x 1/16 [36]	1	#30 35744K	85274
15/16 x 3/4 x 3/32 [18]	1	#14 35731K	85256
15/16 x 13/16 x 1/16 (36)	1	#32 35746K	85312

Item	Pack	Part #	HDI #
1 x 3/4 x 1/8 [12]	1	#15 35732K	85242
1 x 13/16 x 3/32 [18]	1	#57 35771K	85263
1 x 7/8 x 1/16 [39]	1	#66 35780K	85292
1 1/16 x 13/16 x 1/8 [28]	1	#16 35733K	85260
1 1/16 x 7/8 x 3/32 [18]	1	#17 35734K	85262
1 1/16 x 15/16 x 1/16 [36]	1	#33 35747K	85284
1 1/8 x 7/8 x 1/8 [12]	1	#27 35741K	85268
1 1/8 x 15/16 x 3/32 [12]	1	#62 35776K	85298
1 3/16 x 15/16 x 1/8 [12]	1	#18 35735K	86223
1 3/16 x 1 x 3/32 [18]	1	#20 35737K	85280
1 3/16 x 1 1/16 x 1/16 [24]	1	#26 35740K	85278
1 1/4 x 1 1/8 x 1/16 [24]	1	#29 35743K	85304
1 5/16 x 1 1/16 x 1/8 (12)	1	#63 35777K	85264
1 5/16 x 1 1/8 x 3/32 [12]	1	#64 35778K	85265
1 5/16 x 1 3/16 x 1/16 (24)	1	#55 35769K	85259
1 3/8 x 1 1/8 x 1/8 (8)	1	#43 35757K	85272
1 1/2 x 1 1/4 x 1/8 [8]	1	#34 35748K	85306
1 1/2 x 1 5/16 x 3/32 [12]	1	#25 35739K	85276
1 9/16 x 1 5/16 x 1/8 [8]	1	#44 35758K	85288
1 5/8 x 1 7/16 x 3/32 (12)	1	#50 35764K	85253
1 5/8 x 1 1/2 x 1/16 (18)	1	#51 35765K	85255
1 3/4 x 1 9/16 x 3/32 [8]	1	#38 35752K	85241
2 3/16 x 2 x 3/32 [6]	1	#73 35720K	85310



PLUMBING & HEATING



80359



80410



80413



88005

FAUCET STEM REPAIR KITS

DANCO

Item	Pack	Part #	HDI #
Faucet repair kit for Crain Diazeze			
For Stem 5A-1, 2, 3, 4	6	80042	87092
Faucet repair kit for Price Pfister			
3H-8H/C Seat Washer	6	80359	87098
Faucet repair kit for American Standard			
2K-1, 2 less Seats	6	80410	87102
Faucet repair for American Standard			
Nu-Seal Diaphragm	6	80413	87646
Faucet repair kit for Milwaukee			
2S-1 w/Seats & Springs	6	88005	87120



FAUCET BOTTOM SEALS

DANCO

Item	Pack	Part #	HDI #
Price Pfister			
For 3H-10H/C Stem	6	89035	87140
For 9H-8H/C Stem	6	89045	87142



“O” RING PICK

DANCO

Item	Pack	Part #	HDI #
Provides a quick and easy means of removing worn out “O” rings that need to be replaced.			
	1	86713	85190



REPLACEMENT FAUCET STEMS FROM DANCO

Item	Pack	Part #	HDI #
Picture perfect replacement faucet stems for:			
American Standard			
1Z-6H Amer. Stand. Hot	3	15027B	87036
1Z-6C Amer. Stand. Cold	3	15028B	87038
2C-6H/C Amer. Std Hot/Cold	3	15919B	85910
2C-14H/C Amer Std Hot/Cold	3	17423B	87040
2K-2H Amer. Stand. Hot	3	15729B	85872
2K-2C Amer. Stand. Cold	3	15730B	85874
2K-4H Faucet Stem	3	15744B	85742
2K-4C Faucet Stem	3	15745B	85744
9C-23H/C Amer Std Hot/Cold	3	15700B	85818
11C-1D Faucet	3	15702B	85982
11K-3H/C Faucet	3	15054B	85984
Central Brass			
1C-6H Central Brass Hot	3	15835B	85820
1C-6C Central Brass Cold	3	15836B	85822
1C-7H Central Brass Hot	3	15083B	85746
1C-7C Central Brass Cold	3	15084B	85748
10L-11 H/C Faucet Stem	3	17310B	85981
11C-11 H/C Faucet Stem	3	15098B	85983
Crane			
5A-1H Crane Hot	3	15119B	85830
5A-1C Crane Cold	3	15120B	87068
10I-1H Faucet Stem	3	17105B	85977
10I-1C Faucet Stem	3	17106B	85979
Delex			
3S-2H/C Delex Hot/Cold	3	16030B	85914
3S-9H/C Delex Hot/Cold	3	10405	87052
Delta			
3S-10H/C Delta Hot/Cold	3	16219B	87054
3S-16 H/C Faucet Stem	3	10474	85826
7S-4D Delta	3	17450B	87072
7S-4D Delta Extension	3	18026B	87074
7S-10D Faucet Stem	3	15607B	85912
Eljer			
10C-5H Faucet Stem	3	15693B	85906
10C-5C Faucet Stem	3	15694B	85908
Gerber			
1B-2H Gerber Hot	3	15339B	85750
1B-2C Gerber Cold	3	15340B	85752
3B-2H Faucet Stem	3	17291B	85758
3B-2C Faucet Stem	3	17292B	85760
11B-1H/C Gerber Hot/Cold	3	15354B	85946
11B-4D Gerber	3	15352B	85924

Item	Pack	Part #	HDI #
Glacier Bay			
3S-10H Faucet Stem	3	04998E	85834
3S-10C Faucet Stem	3	04999E	85836
3S-11H Faucet Stem	3	04990E	87056
3S-11C Faucet Stem	3	04991E	87058
3S-12C Faucet Stem	3	04995E	85891
Indiana Brass			
1E-1H Indiana Brass Hot	3	15347B	85754
1E-1C Indiana Brass Cold	3	15348B	85756
7E-5H Indiana Brass Hot	3	15525B	85798
7E-5C Indiana Brass Cold	3	15526B	87070
Kohler			
1C-3H Kohler Hot	3	15801B	85776
1C-3C Kohler Cold	3	15802B	85774
1Z-4H/C Kohler Hot/Cold	3	15737B	85763
6N-2H Kohler Hot	3	15553B	85850
6N-2C Kohler Cold	3	15554B	85852
9C-26H/C Faucet Stem	3	17491B	85918
Lifetime			
3J-2H/C Lifetime Hot/Cold	3	17323B	87048
Milwaukee			
4S-2H Milwaukee Hot	3	17241B	85790
4S-2C Milwaukee Cold	3	17242B	85792
4S-6H/C Milwaukee Hot/Cold	3	18545B	87066
Moen			
6S-71H/C Faucet Stem	3	14191B	85902

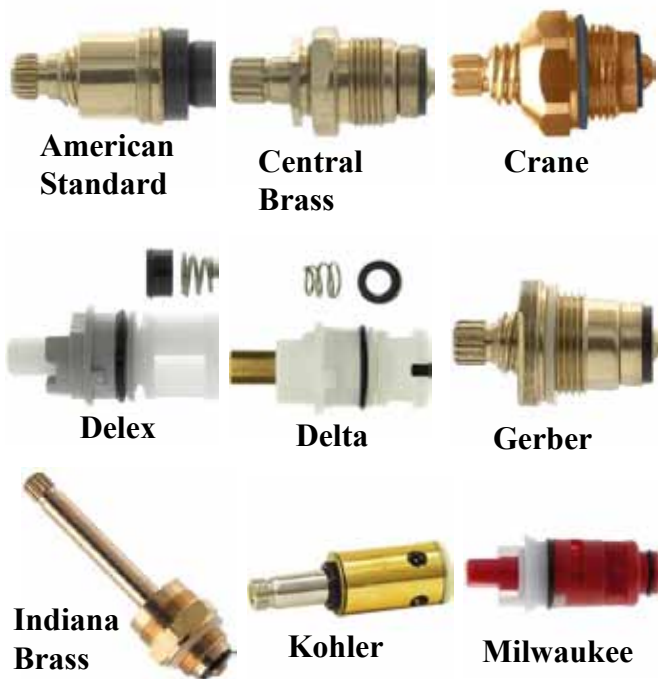

American Standard

Central Brass

Crane

Delex

Delta

Gerber

Indiana Brass

Kohler

Milwaukee



PLUMBING & HEATING

REPLACEMENT FAUCET STEMS FROM DANCO

Item	Pack	Part #	HDI #
Nibco			
3J-4H/C Nibco Hot/Cold	3	16015B	85788
Phoenix			
2J-8H/C Phoenix Hot/Cold	3	17451B	85828
3J-9H/C Phoenix Hot/Cold	3	18593B	87050
Price Pfister			
1H-1H Price Pfister Hot	3	15289B	85762
1H-1C Price Pfister Cold	3	15290B	85764
2H-1H/C Price Pfister Hot/Cold	3	15625B	85880
3G-3H Price Pfister Hot	3	18864B	87042
3G-3C Price Pfister Cold	3	18865B	87044
3H-2H Price Pfister Hot	3	15287B	85782
3H-2C Price Pfister Cold	3	15288B	85784
3H-8H/C Price Pfister Hot/Cold	3	16110B	85786
3H-10HC Hot/Cold	3	09330B	87046
3I-11H/C Hot/Cold	3	15624B	85824
9H-8H/C Faucet Stem	3	05850B	85975
10I-7H/C Hot/Cold	3	17099B	85870
12H-1H/C Hot/cold	3	15716B	85840
12H-2H/C Hot/Cold	3	17335B	85882
12H-4D Price Pfister	3	15718B	85816
12H-18D Price Pfister	3	17328B	87086
Sayco			
1B-1H Sayco Hot	3	15431B	85766
1B-1C Sayco Cold	3	15432B	85768
9B-3H Sayco Hot	3	15884B	85808
9B-3C Sayco Cold	3	17093B	85810
9B-5D Sayco	3	15886B	85920
Stanadyne			
6S-1H/C Stanadyne Hot/Cold	3	18326B	85944
Streamway			
2J-3H Streamway Hot	3	15918B	85900
2J-3C Streamway Cold	3	16000B	85898
2J-6H Streamway Hot	3	15641B	85896
2J-6C Streamway Cold	3	15642B	85894
3J-1H/C Streamway Hot/Cold	3	16112B	85916

Item	Pack	Part #	HDI #
Sterling			
2L-4H Sterling Hot	3	15643B	85876
2L-4C Sterling Cold	3	15644B	85878
3S-13H Sterling Hot	3	18700B	87060
3S-13C Sterling Cold	3	18701B	87062
3Z-8H/C Faucet Stem	3	17457B	85862
3Z-14H/C Sterling Hot/Cold	3	18603B	87064
8L-1H/C Sterling Hot/Cold	3	17315B	87076
9S-4H/C Faucet Stem	3	17469B	85976
10L-1H/C Sterling Hot/Cold	3	15420B	85814
10L-3D Sterling	3	15402B	87078
10L-15H/C Sterling Hot/Cold	3	17417B	87080
10S-6C Sterling Cold	3	18703B	87084
Union Brass			
1E-2H Union Brass Hot	3	15333B	85770
1E-2C Union Brass Cold	3	15334B	85772
Union Gopher			
7E-1H Union Gopher Hot	3	15363B	85934
7E-1C Union Gopher Cold	3	15364B	85932
Valley			
3Z-6H/C Valley Hot/Cold	3	17312B	85778
6Z-82 H/C Faucet Stem	3	14190B	85904





PLUMBING & HEATING

See Next Page For Item Listing



80401



88089



10420



31229



80969



88049



88439



88695



88697



80003



80681



88088



88090



88860



88861



88798



88799



88810



88976



10424



80004



88170



88171



80456



80457



88085



88262



88263



14884



80680



88092



88168



88169



88304



88379



88743



OEM HANDLES

DANCO

Item	Pack	Part #	HDI #
Central Brass Style Handle - For Kitchen & Lavatory			
Hot/Cold Pair per Card	3	80401	87611
Crane - Fits Kitchen & Lavatory			
Hot/Cold Pair per Card	3	88089	87616
Delta Long Lever - Single metal handle. Fits Delta kitchen faucets. Fits #70 and #212 ball faucets.			
	3	10420	100283
Delta Single Handle Style - Clear Acrylic. For Tub & Shower, Scald Guard.			
Carded	3	31229	87610
Delta Single Handle Style - Lavatory			
Carded	3	80976	85663
Delta Single Handle Style - For Kitchen, Lavatory, or Utility			
Carded	3	80969	87613
Delta (Delex) Handle - For Kitchen & Lavatory			
Hot/Cold Pair per Card	3	88049	85665
Delta Single Handle Style - Clear Acrylic. Tub & Shower. Old Style			
Carded	3	88439	85667
Delta (Delex) Handle - For Kitchen, Lavatory, Tub & Shower. New Style			
Hot/Cold Pair per Card	3	10304	87627
Delta Single Handle Style - Lavatory. New Style			
Carded	3	10305	87628
Delta Single Handle Style - Tub & Shower. New Style			
Carded	3	88697	87629
Delta Multi Fit - Single lever for Delta.			
	3	80003	100287
Gerber Handle - For Kitchen & Lavatory			
Hot/Cold Pair per Card	3	80681	87612
Gerber Handle - For Kitchen & Lavatory			
Hot/Cold Pair per Card	3	88088	87615
Gerber Handle - For Tub & Shower			
Hot/Cold Pair per Card	3	88090	87617
Gerber Handle - Multi-Fit Tub & Shower. Fits both short and long stems.			
Hot/Cold Pair per Card	3	88106	85669
Diverter - 1 per Card	3	88861	85671
Moen Single Handle Style - Shallow Broach. For Tub & Shower			
Carded	3	88061	100295
Moen Single Handle Style - Acrylic			
Lavatory/Tub/Shower Handle Assembly	3	10303	100293

OEM HANDLES

DANCO

Item	Pack	Part #	HDI #
Moen Single Handle Style - Touch Control			
Lavatory Carded	3	88798	87631
Tub & Shower Carded	3	88799	87632
Moen Handle - Acrylic. Tub & Shower			
Hot/Cold Pair per Card	3	88810	87633
Moen Single Handle Style - Fits Posi Temp. Tub & Shower			
Carded	3	10302	87634
Moen Multi Fit - Single lever handle for Moen.			
	3	80004	100291
Monitor Lever - Single metal handle. Fits Delta Monitor 1700 Series tub and shower faucets. 2" x 5" tall			
	3	10424	100285
Phoenix Handle - Clear Acrylic. For Kitchen, Lavatory, Tub & Shower			
Hot/Cold Pair per Card	3	88170	87621
Diverter - 1 per Card	3	88171	87622
Price Pfister Handle - Small. Fits Verve Kitchen & Lavatory Old Style			
Hot/Cold Pair per Card	3	80456	85685
Price Pfister Handle - Large. Fits Verve Kitchen & Lavatory Old Style			
Hot/Cold Pair per Card	3	80457	85687
Diverter - 1 per Card	3	88085	85688
Price Pfister Handle - Clear Acrylic. For Tub & Shower. Fits Contessa/Windsor			
Hot/Cold Pair per Card	3	88262	87623
Diverter - 1 per Card	3	88263	87624
Sterling Style Handle - Clear Acrylic. Square broach. For Kitchen, Lavatory, Tub & Shower			
Hot/Cold Pair per Card	3	14884	87609
Sterling (Rockwell) Handle - Kitchen & Lavatory			
Hot/Cold Pair per Card	3	80680	85683
Sterling (Rockwell) Handle - For Tub & Shower			
Hot/Cold Pair per Card	3	88092	87618
Streamway Handle - Clear Acrylic. For Kitchen, Lavatory, Tub & Shower			
Hot/Cold Pair per Card	3	88168	87619
Diverter - 1 per Card	3	88169	87620
Valley Handle - Clear Acrylic. For Kitchen, Lavatory, Tub & Shower			
Hot/Cold Pair per Card	3	88304	87625
Valley Single Handle Style - Clear Acrylic. For Kitchen, Lavatory, Tub & Shower			
Carded	3	88379	87626
Valley Single Handle Style - Acrylic. Lavatory			
Carded	3	88743	87630



READY FIT HANDLES

DANCO

Item	Pack	Part #	HDI #
Lever Handle - Single metal handle. Fits Delta, Price Pfister, American Standard bath and tub and shower faucets. 4" long x 2" tall			
	3	10419	100273
Lever Faucet Handle - Chrome metal. Universal replacement handles for use with Danco handle adapters. 2½" center of hole to tip.			
Hot/Cold Pair per Card	3	80833	85601
Cross Faucet Handle - Chrome metal. Universal replacement handles for use with Danco handle adapters. 3" tip to tip.			
Hot/Cold pair per Card	3	80835	85605
Diverter Handle - 1 per Card	3	80836	85607
Small Canopy Lever Handle - Chrome metal. Universal replacement handle for use with Danco handle adapters. 1 1/16" center of hole to tip.			
Hot/Cold Pair per Card	3	80837	85609
Large Canopy Lever Handle - Chrome metal. Universal replacement handle for use with Danco handle adapters. 1 7/8" center of hole to tip.			
Hot/Cold Pair per Card	3	80838	85611
Diverter Handle - 1 per Card	3	80839	85613
Large Decorator Style Faucet Handle - Clear. Bath. Replacement handle for use with Danco handle adapters.			
Hot/Cold Pair per Card	3	80852	85635
Large Decorator Style Faucet Handle - Clear. Bath. For Price Pfister, Central, and Sayco			
Hot/Cold Pair per Card	3	80906	85643
Diverter Handle - 1 per Card	3	80907	85645
Large Decorator Style Faucet Handle - Clear. For Price Pfister Windsor Style			
Diverter - 1 per Card	3	88446	87602
Large Metal Faucet Handle - For Price Pfister Verve Style			
Diverter - 1 per Card	3	88448	87604
Small Metal Faucet Handle - For Price Pfister Verve Style			
Hot/Cold Pair per Card	3	88449	87605



PLUMBING & HEATING

See Previous Page For Picture

READY FIT HANDLES

DANCO

Item	Pack	Part #	HDI #
Vice Grip Lever Handle - Chrome metal. Universal replacement handles. No adapter needed.			
Hot/Cold Pair per Card	3	88516	85600
Vice Grip Cross Arm Handle - Chrome metal. Universal replacement handles. No adapter needed.			
Hot/Cold Pair per Card	3	88517	85602
Acrylic Vice Grip Handle - Slotted set screw design allows for a proper fit on most kitchen & lavatory faucets.			
Hot/Cold per Card	3	88889	87606
Small Acrylic - Pair of acrylic handles. Universal fit design works with a variety of faucets. 1 3/4" diameter x 2 9/16" tall			
	3	80010	100275
Large Acrylic - Pair of acrylic handles. Canopy style handles. Universal design works with a variety of faucets. 2 5/16" diameter x 2 13/16" tall			
	3	80014	100269
Large Acrylic Div - Single acrylic handle. Canopy style handle. Universal design works with a variety of faucets. 2 5/16" diameter x 2 13/16" tall			
	3	80015	100271
Small Metal Handle - Pair of small metal canopy handle.			
	3	80016	100265
Large Metal Handle - Pair of large metal canopy handle.			
	3	80019	100267
Large Metal Div - Single large metal canopy handle.			
	3	80020	100261
Deco Lever Handle - Single decorative lever			
	3	80021	100263
Ergo Lever Handle - Pair of ergo lever handles.			
	3	80022	100257
Ergo Lever Div - Single ergo lever diverter handle.			
	3	80023	100259
Acrylic Div - Single acrylic handle. Canopy style handle. Universal design works with a variety of faucets. 2 3/8" diameter x 1 7/8" tall			
	3	80024	100277
Crossarm Div - Single metal handle. Cross-arm style handle. Universal design works with a variety of faucets. For use on tub and shower faucets.			
	3	80025	100279
Lever Div Handle - Single metal handle. Lever style handle. Universal fit design works with a variety of faucets.			
	3	80026	100281



HANDLE FLANGES

DANCO

Item	Pack	Part #	HDI #
Bell Style Bath Escutcheon - Carded. Old Style			
Chrome	3	80616	85651
Adjustable Style Bath Escutcheon - Carded. New Style			
Chrome	3	80619	85653
Replacement Bath Escutcheon Set - For Gerber. 1 1/8" Flange with 3 3/8" Tube. Also fits Briggs			
Carded	3	80889	87607
Replacement Bath Escutcheon Set - Price Pfister Verve Fits stems 12H-1, 12H-2, 12H-4, 12H-18			
Carded	3	88457	87608



HANDLE SCREWS & BUSHING

DANCO

Item	Pack	Part #	HDI #
Universal Handle Bushing			
Carded	3	80654	87635
Replacement Kits for Handle Screws - For American Standard, Gerber, & Price Pfister. 2 each 10/24 x 1/2 Oval Head, 2 each 10/24 x 1/2 Truss Head			
Carded	3	88354	85657
Replacement Kits for Handle Screws - For Central, Sayco, & Sterling. 2 each 10/32 x 3/4 Oval Head, 2 each 10/32 x 1/2 Oval Head, 2 each 10/24 x 1/2 Oval Head			
Carded	3	88355	85659
Replacement Kits for Handle Screws - Assorted. 2 each 10/24 x 1/2 Oval Head, 2 each 10/24 x 3/4 Oval Head, 2 each 10/24 x 1/2 Truss Head, 2 each 8/32 x 3/4 Oval Head, 2 each 10/32 x 3/4 Oval Head			
Carded	3	88356	85661



PLUMBING & HEATING

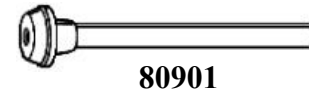

WATER CONNECTORS

WATER CONNECTORS

DANCO

DANCO

Item	Pack	Part #	HDI #
Faucet Poly Water Connectors - Features Chloramine-Resistant inner core and soft cone washer. Suitable for water temperatures from 33°F to 140°. IAPMO, NSF-61, and UPC Approved			
3/8" Comp x 1/2" FIP x 12"	25	59919	86534
3/8" Comp x 1/2" FIP x 16"	25	59921	125310
3/8" Comp x 1/2" FIP x 20"	25	59923	86535
3/8" Comp x 1/2" FIP x 24"	25	59925	125184
3/8" Comp x 1/2" FIP x 30"	25	59927	87428
3/8" Comp x 1/2" FIP x 36"	25	59929	87430
Faucet Stainless Steel Water Connectors - Features Chloramine-Resistant inner core and soft cone washer. Suitable for water temperature from 33°F to 140°F. IAPMO, NSF-61 and UPC Approved.			
3/8" Soft Comp x 1/2" Soft Cone FIP x 12"	25	59827	86544
3/8" Soft Comp x 1/2" Soft Cone FIP x 16"	25	59829	86543
3/8" Soft Comp x 1/2" Soft Cone FIP x 20"	25	59831	86545
3/8" Soft Comp x 1/2" Soft Cone FIP x 24"	25	59703	87792
3/8" Soft Comp x 1/2" Soft Cone FIP x 30"	25	59705	87862
3/8" Soft Comp x 1/2" Soft Cone FIP x 36"	25	59707	87420
1/2" Soft Cone FIP x 1/2" Soft Cone FIP x 12"	25	59821	86547
1/2" Soft Cone Comp x 1/2" Soft Cone FIP x 12"	25	59839	88002
1/2" Soft Cone FIP x 1/2" Soft Cone FIP x 20"	25	59825	86549
Faucet Poly Water Connector - For Price-Pfister wide-spread lavatory faucets. Features Chloramine-Resistant inner core and soft cone washer. Flexible. Suitable for water temperatures from 33°F to 140°F			
3/8" Comp x 3/8" Comp x 6 3/4"	3	81212	88036
Single Lever Faucet Stainless Steel Water Connectors - For use on Delta and other single lever kitchen & lavatory faucets. Features Chloramine-Resistant inner core and soft cone washer. Flexible. Suitable for water temperatures from 33°F to 140°F			
3/8" Comp x 3/8" OD Comp Coupling x 12"	12	81232	88044

Item	Pack	Part #	HDI #
Toilet Stainless Steel Water Connectors - Features Chloramine-Resistant inner core and soft cone washer. Suitable for water temperature from 33°F to 140°F. IAPMO, NSF-61 and UPC Approved.			
3/8" Soft Comp. x 7/8" Soft Cone Ballcock x 6"	25	59876	88006
3/8" Soft Comp x 7/8" Soft Cone Ballcock x 9"	25	59857	87424
3/8" Soft Comp x 7/8" Soft Cone Ballcock x 12"	25	59860	86551
3/8" Soft Comp x 7/8" Soft Cone Ballcock x 16"	25	59862	87426
1/2" Soft Cone Comp x 7/8" Soft Cone Ballcock x 12"	25	59871	88004
Toilet Poly Water Connectors - Features Chloramine-resistant soft cone washer. Suitable for water temperatures 33°F to 140°F.			
3/8" Comp x 7/8" Ballcock Nut x 9"	25	59979	87432
3/8" Comp x 7/8" Ballcock x 12"	25	59981	125314
3/8" Comp x 7/8" Ballcock Nut x 16"	25	59794	87422
3/8" Comp. x 7/8" Ballcock Nut x 20"	25	59983	88008
Supply Tubes - 2 per poly bag with header. Made of crosslinked polyethylene (PEX). Flexible. NSF Approved			
<i>Lavatory</i>			
Metal 3/8" x 12"	6	80901	88022
PEX 3/8" x 12"	6	89146	88084
<i>Toilet Tank</i>			
Metal 3/8" x 12"	6	80902	88024



PLUMBING & HEATING



WATER CONNECTORS

DANCO

Item	Pack	Part #	HDI #
Dishwasher Connectors - Features Chloramine-resistant inner core and soft cone washer. Flexible. Suitable for water temperatures 33°F to 140°F with a burst pressure up to 2000 psi. Includes 90° Elbow. Stainless Steel			
3/8" Comp x 1/2" FIP x 48"	10	50485	87558
3/8" Comp x 1/2" FIP x 60"	10	50479	87556
3/8" Comp x 3/8" Comp x 48"	10	59637	87560
3/8" Comp x 3/8" Comp x 60"	10	59899	87582
3/8" Comp x 3/8" Comp x 72"	10	59639	87562
Ice Maker Connectors - Features Chloramine-resistant inner core and soft cone washer. Flexible. Suitable for water temperatures 33°F to 140°F. Stainless Steel			
1/4" Comp x 1/4" Comp x 12"	10	59734	87566
1/4" Comp x 1/4" Comp x 60"	10	59736	87568
1/4" Comp x 1/4" Comp x 84"	10	59738	87570
1/4" Comp x 1/4" Comp x 96"	10	59730	87564

OATEY

Item	Pack	Part #	HDI #
Polybutylene Ballcock Supply Tube - Easily installed, can be cut with a knife and are impossible to kink. 3/8" Comp x 7/8" Ballcock			
<i>Bulk with delrin sleeve</i>			
12"	48	34315	60865



WATER CONNECTORS

FLUIDMASTER

Item	Pack	Part #	HDI #
No Burst Stainless Steel Faucet Connectors - High burst strength. Each foot of No-Burst contains 220 feet of stainless steel wire. NSF Approved			
3/8" Female Compression x 1/2" IP Female Straight Thread x 12"	25	BIF12	87006
3/8" Female Compression x 1/2" IP Female Straight Thread x 16"	25	BIF16	87007
3/8" Female Compression x 1/2" IP Female Straight Thread x 20"	25	BIF20	87017
3/8" Female Compression x 1/2" IP Female Straight Thread x 30"	25	BIF30	87014
No Burst Stainless Steel Toilet Connectors - High burst strength. Each foot of No-Burst contains 220 feet of stainless steel wire. NSF Approved			
3/8" Female Compression x 7/8" Female Ballcock x 9"	25	BIT09	87018
3/8" Female Compression x 7/8" Female Ballcock x 12"	25	BIT12	87010
3/8" Female Compression x 7/8" Female Ballcock x 20"	25	BIT20	87016
No Burst Stainless Steel Dishwasher Connectors - Fits all connectors - fits four shut-off valve sizes - 3/8", 7/8", 1/2" Male Compression and 1/2" MIP			
72"	10	IW72CV	87011



PLUMBING & HEATING



59200



59201



59202



81222

SUPPLY VALVES

SUPPLY VALVES

DANCO

DANCO

Item	Pack	Part #	HDI #
Angle Stop 1/4 Turn Mini Ball Valves - Chrome plated, heavy brass construction for years of reliable service. Washerless design w/hi-temp viton seats. NSF-61, UPC and CSA Approved. E-Z Turn			
3/8" OD Comp x 3/8" OD Comp	3	59213	88074
3/8" Comp x 1/2" Sweat	3	59209	88026
3/8" Comp x 5/8" OD Comp	3	59200	88066
3/8" Comp x 3/8" FIP	3	59204	88070
3/8" Comp x 1/2" FIP	3	59201	87552
1/2" CPVC x 3/8" Comp	3	59211	87526
5/8" OD x 1/4" Comp	3	59219	87542
Straight Stop 1/4 Turn Mini Ball Valves - Chrome plated, heavy brass construction for years of reliable service. Washerless design w/hi-temp viton seats. NSF-61, UPC and CSA Approved. E-Z Turn			
3/8" OD Comp x 3/8" OD Comp	3	59214	87546
3/8" Comp x 3/8" FIP	3	59205	88072
3/8" Comp x 1/2" Sweat	3	59210	87520
3/8" Comp x 5/8" OD Comp	3	59202	88068
3/8" Comp x 1/2" FIP	3	59203	87554
1/2" CPVC x 3/8" Comp	3	59212	87528
Hose Thread x Female Swivel Hose Thread	3	59216	87536
5/8" OD x 1/4" Comp	3	59220	87544
Retrofit Stop 1/4 Turn Mini Ball Valves - Chrome plated, heavy brass construction for years of reliable service. Washerless design w/hi-temp viton seats. Creates a new stop by piggy-backing onto existing defective 3/8" OD compression angle stop, straight stop, or adapter without effecting the existing piping. NSF-61, UPC and CSA Approved. E-Z Turn			
3/8" OD Comp x 3/8" OD Female Comp	3	59215	87534
Washing Machine Valve 1/4 Turn Mini Ball Valves - Chrome plated, heavy brass construction for years of reliable service. Washerless design w/hi-temp viton seats. NSF-61, UPC and CSA Approved. E-Z Turn			
Cold Valve	3	59217	87538
Hot Valve	3	59218	87540

Item	Pack	Part #	HDI #
Dual Outlet Stops			
5/8" Comp x 3/8" Comp x 3/8" Comp	3	81222	88038
1/2" IPS x 3/8" Comp x 3/8" Comp	3	81223	88040



REPAIR FOR BRASSCRAFT STOPS

DANCO

Item	Pack	Part #	HDI #
Stop repair kit includes packing, friction ring & bibb washer			
	3	88001	88050
Stop Handle			
	3	88000	88048



PLUMBING & HEATING

ICE MAKER VALVES



DANCO

Item	Pack	Part #	HDI #
Includes inserts and brass sleeves. Carded			
<i>Line Valve</i>			
3/8" OD x 1/4" ID	3	88277	88054
5/8" OD x 1/4" ID	3	81233	88046
<i>Saddle Valve</i>			
3/8" to 1 3/8" OD Saddle x 1/4" ID	3	88650	85508
3/8" Saddle x 1/4"	3	88276	88052

ICE MAKER INSTALLATION KIT



DANCO

Item	Pack	Part #	HDI #
Includes Ice Maker Valve & Tubing			
Kit w/1/4" x 25' Vinyl Tubing	5	50512	88000
Kit w/1/4" x 15' Copper Tubing	5	81209	88030

ICE MAKER STOP ADAPTER



DANCO

Item	Pack	Part #	HDI #
3/8" x 3/8" x 1/4"			
	12	88605A	87548

ICE MAKER ADAPTERS



DANCO

Item	Pack	Part #	HDI #
Compression Adapter			
	3	88381	88058



FLANGES

DANCO

Item	Pack	Part #	HDI #
Canopy Flanges - Chrome Plated			
1/2" Water Tube	5	80962	88028
3/8" IPS	5	80961	125046
1/2" IPS	3	89070	125048

FLOOR & CEILING PLATES



DANCO

Item	Pack	Part #	HDI #
Chrome plated metal			
1/2" Copper	3	80886	88020
3/4" Copper	3	81210	88032
3/8" IPS	3	81211	88034
1/2" IPS	3	88465	88064

DISHWASHER STOP ADAPTER



DANCO

Item	Pack	Part #	HDI #
3/8" x 3/8" x 3/8"			
	12	88608A	87550

DISHWASHER CONNECTION FITTING



Item	Pack	Part #	HDI #
3/4 FGH x 3/8 COMP, 90° Elbow installation fitting. Brass			
	1	DEHF3438	100095



PLUMBING & HEATING



FAUCET SUPPLY TUBE NUTS

DANCO

Item	Pack	Part #	HDI #
Die Cast - 1/2" OR 3/8"			
2 per card	3	89138	88076
Plastic - 1/2" IPS			
2 per card	3	88410	87806
Brass - 1/2" IPS Chrome Plated			
1 per card	1	88738	86427



88652

FAUCET LOCKNUT



56030

DANCO

Item	Pack	Part #	HDI #
Plastic - 1/2" IPS.			
Flat Washer	6	80344	87726
Includes nut and washer	3	88652	87814
Kitchen & Lavatory Faucet Nuts & Washers - 1/2" Contains 2 nuts and 2 washers.			
	3	56030	85023



CONE WASHERS & RINGS

DANCO

Item	Pack	Part #	HDI #
For Lavatory & Sink or Toilet Ballcock			
3/8" Style OD Tube	6	80330	88012
Flanged for 3/8" OD Tube	6	80331	88014
1/2" OD Tube	6	80332	88016



507-7201



507-7100

CHROME WATER SUPPLY FITTINGS

LDR

Item	Pack	Part #	HDI #
Female straight fitting. Pipe Thread x Compression Fitting. 2 per card			
1/2" FIP x 3/8" OD Tube	5	507-7201	86527
Male straight fitting. Pipe Thread x Compression Fitting. 2 per card			
3/8" MIP x 3/8" OD Tube	5	507-7100	86525
1/2" MIP x 3/8" OD Tube	5	507-7101	86528



COMPRESSION NUTS & SLEEVES

DANCO

Item	Pack	Part #	HDI #
Chrome - Contains 2 nuts and 2 sleeves per card.			
3/8"	3	80235	88010

LDR

Item	Pack	Part #	IBM #
Chrome - Carded			
3/8"	5	507-8200	125034



PLUMBING & HEATING



10306

HAIR SNARE

DANCO

Item	Pack	Part #	HDI #
Fits all basins and tubs			
	5	10306	87904

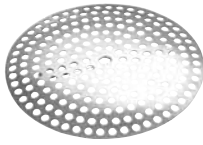

88923



88921



88821

TUB & SHOWER DRAIN STRAINERS

DANCO

Item	Pack	Part #	HDI #
Clip Style Shower Drain Cover - 3 3/8" Diameter			
	5	88923	87916
Shower Drain Strainer - Screw-in style. 3 3/8" diameter. Chrome plated brass			
	3	88921	87914
Bathtub Strainer - Easy to use. Prevents clogged drains. Catches hair, lint, soap, paper, small toys, bottle caps. Stainless Steel			
	3	88821	87912

80058

88967

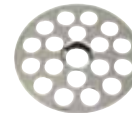

80061



88886

SINK STRAINERS

88949



DANCO

Item	Pack	Part #	HDI #
Basket Strainer for Lavatory - Less Post. Used in lavatories where the cross bar is missing or the pop-up has been removed. Chrome plated brass.			
1 1/32" OD x 3/4" Depth	5	80058	87702
Basket Strainer Less Post - Used in combination sinks and utility tubs. Chrome Plated Brass			
1 1/2" OD x 7/8" Depth	3	89049	87832
Basket Strainer - With Post. Used in sinks with small openings or in combination sinks and utility tubs. Chrome plated brass.			
1 7/8" OD x 1 1/4" Depth	5	88967	87828
Flat Sink Strainer - For Lavatory, Sink, and Utility Tubs. Keeps drain lines clear and prevents costly repairs. Chrome plated brass			
1 5/8"	6	80061	87704
Flat Sink Strainers - 3 prong snap-in style. Chrome plated brass.			
1 5/8"	5	80062	87706
1 7/8"	5	80064	87708
Mesh Strainers - Prevents cloges drains. Catches hair, lint, soap, paper, small toys, bottle caps. Stainless steel			
2 1/2" for Lavatory Sinks	3	88820	87822
4 1/2" for Kitchen Sinks	3	88822	87824
Variety Pak (2 1/2", 2 3/4", 4 1/2")	6	88886	87692
Laundry Tray Cup - Sits on cross bar and allows stopper to be used. Chrome Plated			
1 31/64"W x 1/2" H	3	88949	87826



PLUMBING & HEATING



REPLACEMENT BASKET STRAINERS

DANCO

Item	Pack	Part #	HDI #
Stainless Steel Drop Center Post			
3 3/4" OD x 1 3/16"	5	80900	87752
Stainless Steel Stationary Post			
3 1/4" OD x 1 1/4"	5	88275	87800
Plastic w/Rubber Stopper			
3 1/4" OD x 1 1/4"	5	86792	123285
Brass Ground Joint			
3 1/4" OD x 1 5/8"	3	51275	87698
Stainless Steel Arrow Clip			
3 1/4" OD x 3/4"	3	81079	87766
Stainless Steel w/Rubber Stopper			
3 1/16" OD x 1 1/2"	3	86720	87774
Chrome Plated Basket - Fits Spin-n-Grin Strainer 81077			
	3	86800	87782
Lock-In Basket Strainer - Fist Premium Sink Strainer 81090			
	3	81091	87772
Microban Strainer/Stopper - Combo pack features a strainer and stopper in one package. Durable, flexible, stain-resistant rubber, dishwasher safe, universal, fits all sinks, and microban built-in antimicrobial protection.			
Combo, Black	3	10009	87742



BASKET SINK STRAINERS

DANCO

Item	Pack	Part #	HDI #
Sink Strainer - Basket type. Complete with nuts and washers.			
PVD Brushed Nickel - Metal	4	89302	87846
Stainless - Metal	4	89305	87848
3 1/2" Sink Opening - Plastic	4	88287	123265
Replacement Strainer for Spin-n-Grin - Extra heavy brass stainless steel basket. Patented locking action. 3 1/2" Strainer			
Polished Stainless Steel Strainer & Basket	5	81077	87764
Flat Sink Strainer Assembly - Heavy wrought brass construction. Triple chrome plated. Designed for combination sinks and laundry trays with small hole drillings			
3" Flange x 2" Opening	5	89072	87834
Basket Sink Strainer - Installs in most sinks. Heavy-weight double cup feature. Lock-in closure on the basket post provides a water-tight seal. Stainless steel construction. Full length threaded shank			
Premium Sink Strainer	3	81090	87770
Basket Sink Strainer - Stainless Steel body and basket. Cast brass coupling nut. Complete with nuts and washers			
3 1/2" x 4" Sink Opening	3	86803	87784
Mini Bar Strainers			
2 13/16" x 1 3/4" Assembly	3	86805	87786



BASKET SINK STRAINER REPAIRS

DANCO

Item	Pack	Part #	HDI #
Washers and Shank Nuts Assortment - Contains 1 each of: 50532, 50592, 50534			
	5	81080	87768
Sink & Basket Strainer Washers - Contains 1 each of 50592, 50532			
	3	88438	87808
Washers - Use between locknut and sink bottom when installing basket strainer.			
Rubber 4 3/8" OD x 3 7/16" ID x 1/8" Thick	1	50532	86334
Fiber 4 3/8" OD x 3 3/8" ID x 1/32" Thick	1	50592	86335



PLUMBING & HEATING



SINK/BASIN HANGER

LDR

Item	Pack	Part #	HDI #
Basin hanger holds and supports most types of wall hung sinks			
2 per card	5	501-7100	86129



POP-UP STOPPERS 80381



80418

DANCO

Item	Pack	Part #	HDI #
Replacement Stopper for Sinclair/Price Pfister - Series 41 Flo Matic. Series 49 verve. Marquis 43			
Chrome	3	80381	87732
Universal Replacement Pop-up Stopper - Replaces lavatory stoppers for American Standard, Crane, Delta, Kohler, Moen, and more.			
Chrome	3	80418	87734
PVD Brushed Nickel	3	89257	87842



BASIN MACK GASKET

DANCO

Item	Pack	Part #	HDI #
Used as a seal between the PO plug and underside of the lavatory basin.			
2" OD x 3/8" ID x 3/8" Thick - Bagged	1	36563	86330
2" OD x 1 1/4" ID x 3/8" Thick - Carded	6	80346	87728
2 3/8" OD x 1 1/4" ID x 3/8" Thick - Bagged	1	36562	86331
2 3/8" OD x 1 1/4" ID x 3/8" Thick - Carded	3	88347	87804
2 3/8" OD x 1 7/16" ID x 3/8" Thick - Bagged	1	36564	86332



PLUMBING & HEATING



88116



80767



86780

POP-UP ASSEMBLY

DANCO

Item	Pack	Part #	HDI #
Flexibility allows for offset connections of up to 2". Includes lift rod and plunger.			
1 1/4"	5	88116	123520
ABS Lavatory Pop-up Assembly - Fits 90% of all lavatories. Complete pop-up assembly.			
Chrome Plated	5	80767	87388
Brass Pop-up Assembly - 1 1/4" OD Drain Tee. Chrome plated brass			
Chrome	5	86780	123430
ABS Lavatory Pop-up Assembly - Fits 90% of all lavatories. Complete Pop-up Assembly.			
Polished Brass Plated	3	80885	123420



PO PLUGS

DANCO

Item	Pack	Part #	HDI #
Steel Basin Drain - One piece style. Includes stopper & chain. Chrome Finish			
1 1/4" x 6", 22 Gauge	3	86781	123070
PVC PO Plug with Stainless Steel Ring - One piece style with chrome stopper.			
1 1/4" x 5"	1	88163	125242
Steel Basin Drain - Two-piece style with overflow. Includes stopper and chain. Chrome Finish			
1 1/4" x 9", 22 gauge	1	86782	123435



PULL RODS

DANCO

Item	Pack	Part #	HDI #
Universal Pull Rod - Replaces most existing lavatory lift rod extensions.			
Pull Rod Assembly 3/16" x 12"	3	81075	87762

86783



88532



BALL RODS

DANCO

Item	Pack	Part #	HDI #
6" Ball Rod Assembly for Price Pfister			
	3	86783	87778
Universal Style Ball Rod Assembly - Replaces most existing lavatory ball rod assemblies. Eliminates waste and reduces inventory. Includes 6" brass rod, balls, cone washers			
	6	88532	87812



BEADED CHAIN FOR STOPPERS

DANCO

Item	Pack	Part #	HDI #
Includes couplings.			
11"	3	80038	87852
15"	3	80039	87700



STOPPERS 80223

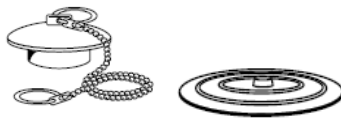

80784 89042

DANCO

Item	Pack	Part #	HDI #
White Rubber Stoppers - Split type ring. Long wearing. Stain proof.			
1"	3	80223	87710
1 1/8"	3	80224	87712
1 1/4"	3	80225	87714
1 3/8"	3	80226	87716
1 1/2"	6	80227	87718
1 5/8"	3	80228	87720
1 3/4"	3	88272	87796
Universal Stoppers - Beaded chain included.			
Basin Stopper 1" to 1 3/8"	3	80784	87744
Tub Stopper 1 1/2" to 2"	6	80783	87870
Flat Suction Stopper			
5"	6	89042	85386



10429



80785

GARBAGE DISPOSAL PRODUCTS

DANCO

Item	Pack	Part #	HDI #
Reversible Disposal Strainer - Prevents utensils, etc. from falling into disposals. Keeps drain open while working at sink. Fits most disposals.			
White Plastic	3	88274	87798
Garbage Disposal Stopper - Plastic Stopper Universal Fit			
Black	3	10429	87776
Disposal Stopper - 4" OD, White Rubber, Fits most garbage disposals			
4" Sink Opening	3	80785	87746
Garbage Disposal Splash Guard - 3 3/8" OD. Black rubber. Fits most garbage disposals. Black Rubber			
Fits 3 3/8" Sink Opening	3	10428	87748
Disposal Gasket - Waste bend tailpiece gasket for In-Sink-Erator			
	6	80348	87730



UNIVERSAL DISHWASHER / DISPOSAL CONNECTOR

DANCO

Item	Pack	Part #	HDI #
Installs quickly and easily. Simply cut the rubber adapter at required diameter and attach with the correct size clamp.			
1 per card	3	80935	87754

DISPOSAL GENIE



DANCO

Item	Pack	Part #	HDI #
Prevents silverware and other valuables from slipping into drain. Allows water and food particles to flow freely. Disposal runs with genie in place. Fits 99% of disposals.			
Black	3	10051	88384



PLUMBING & HEATING



BRASS TUBULAR NUTS

DANCO

Item	Pack	Part #	HDI #
Slip Joint - Die cast with triple chrome finish.			
1 1/4" Carded w/Poly Washer	3	80750	123400
1 1/2" Carded w/Poly Washer	3	80751	123405



RUBBER SLIP-JOINT WASHERS

DANCO

Item	Pack	Part #	HDI #
<i>2 per Card</i>			
1 1/4"	3	80791	123410
1 1/2"	6	80792	123415
<i>1 per Poly Bag</i>			
1 1/4"	5	36644B	85626
1 1/2"	5	36649B	85630
1 1/2" x 1 1/4"	5	36647B	85636

DRAIN TAILPIECE WASHER

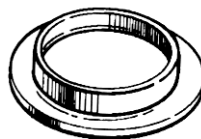

DANCO

Item	Pack	Part #	HDI #
1 3/4" x 1 3/8" Rubber Bagged	5	36459B	86342
1 3/4" X 1 3/8" Rubber & Poly Carded	5	80046	87386
1 3/4" x 1 3/8" Poly Washer Bagged	1	36460B	85608

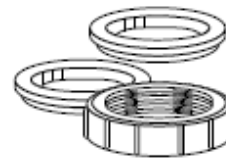

PLASTIC TUBULAR NUTS

DANCO

Item	Pack	Part #	HDI #
Slip-Joint - Impervious to all acids, detergents, minerals, and pipe cleaning chemicals.			
1 1/2" Nut w/1/2 - 1/4" Washer Carded	6	86786	87394
1 1/4" Nut w/ Washer Carded	6	86809	87400
1 1/2" Nut w/ Washer Carded	6	86797	87396

PLASTIC TUBULAR WASHERS

DANCO

Item	Pack	Part #	HDI #
Slip-Joint - Impervious to all acids, detergents, minerals, and pip cleaning chemicals.			
1 1/4" Poly Washer 4 Each Carded	6	89136	87406
1 1/2" Poly Washer 4 Each Carded	6	89137	87408
1 1/2" & 1 1/4" Poly Washer 4 Each Carded	3	81086	87392
1 1/4" Poly Washer Bagged	5	36660B	86343
1 1/2" Poly Washer Bagged	5	36661B	86345
1 1/2" Poly Washers 20 per Bag	1	36661W	123335



PLUMBING & HEATING



BRASS TUBULAR

DANCO

Item	Pack	Part #	HDI #
End Outlet Waste - Slip joint or direct connect. Comes in display polybag. Includes nuts and washer			
1 1/2" x 16"	1	94924	123075
Center Outlet Waste - Slip joint or direct connect. Comes in display polybag.			
Satin	1	94928	123470
Waste Arm - 1 1/2", Slip joint or direct connect			
1 1/2" x 15" Slip Joint or Direct Connect Satin	1	94926	123465
J Bend - Slip Joint. Comes in display polybag			
1 1/4" x 1 1/4"	1	94922	123005
1 1/4" x 1 1/2"	1	94923	123455
1 1/2" x 1 1/2"	1	94874	123010
Sink J Bend LA Code - 22 Gauge. Comes in display polybag			
1 1/2" x 1 1/2"	1	53568	123035

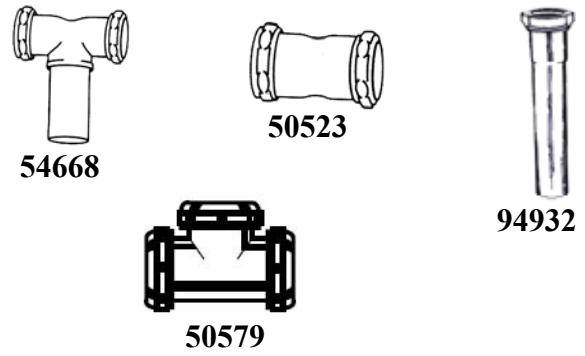

BRASS TUBULAR

DANCO

Item	Pack	Part #	HDI #
Center Outlet Waste Tee - Slip Joint			
Chrome Plated	25	54668	123395
Slip-Joint Coupling - 3" Length. Includes nuts and washers. Comes in polybag			
1 1/4" x 1 1/4"	5	50523	123360
Tailpiece - 22 Gauge. Comes in a polybag. Flanged one end.			
1 1/2" to 1 1/4" x 8" Reducing	5	50550	123370
Slip-Joint Extension Tube - 22 Gauge. Comes in display polybag			
1 1/4" x 6" Chrome Plated	25	94932	123045
1 1/2" x 6" Chrome Plated	25	94934	123050
1 1/4" x 12" Chrome Plated	25	94945	123090
1 1/2" x 12" Chrome Plated	25	94936	123095
Slip Joint Cast Tee - Includes nuts and washers. Comes in polybag			
1 1/2" x 1 1/2" x 1 1/2"	1	50579	123380



PLUMBING & HEATING

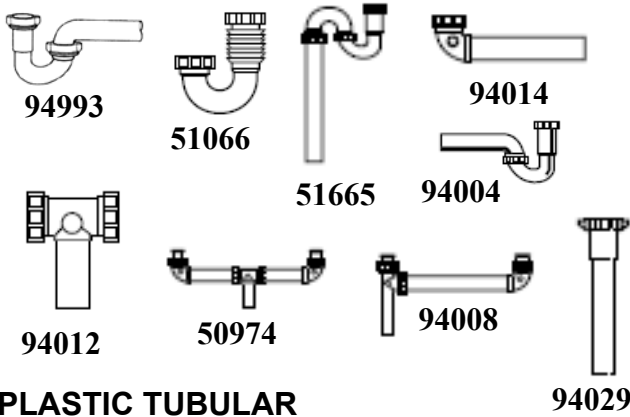

PLASTIC TUBULAR

DANCO

Item	Pack	Part #	HDI #
P Trap LA Code - Polypro plastic. Includes 2 easy tight slip joint nuts & washers. Come in display polybag.			
1 1/2"	1	94993	123320
P Trap - Polypro plastic. Includes 2 easy tight slip joint nuts. Comes in display polybag.			
1 1/4"	1	94004	123310
1 1/2"	1	94003	123305
1 1/2" Swivel	1	94005	87410
Flexible J Bend - Compatible with all existing drain systems. Flexibility allows for offset connections for up to 2". Connects to either plastic or metal.			
1 1/2" x 1 1/2" x 1 1/4"	5	51066	123495
J Bend - 1 1/2". Slip Joint. Polypro Plastic. Comes in Display Polybag			
1 1/2" x 1 1/2" x or 1 1/4"	1	94006	123245
S Trap - Polypro plastic. Includes 3 nuts and washers			
1 1/4"	5	51665	123311
1 1/2"	5	94007	123255
Waste Arm - Slip joint or direct connect. Polypro plastic. Comes in display polybag.			
1 1/2" x 7"	1	94013	87412
1 1/2" x 15"	1	94014	123280
Center Outlet Tee - Slip joint. Polypro plastic with baffle. Comes in display polybag.			
1 1/2"	1	94012	123270
PVC Continuous Waste - Slip joint or direct connect. Center outlet.			
1 1/2" x 16"	1	50974	123300
End Outlet Waste - Slip joint or direct connect. Polypro plastic with baffle. Comes in display polybag.			
1 1/2" x 16"	1	94008	123295
Slip Joint Extension Tube - Polypro plastic. Comes in display polybag.			
1 1/4" x 8"	1	51668	125530
1 1/4" x 12"	1	51669	123312
1 1/2" x 6"	1	94029	123210
1 1/2" x 12"	1	94031	123240

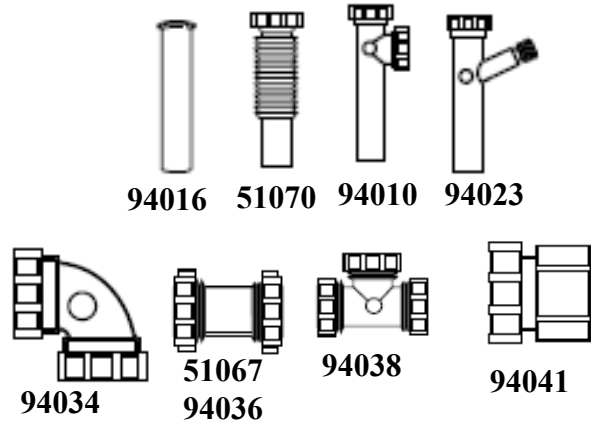

PLASTIC TUBULAR

DANCO

Item	Pack	Part #	HDI #
Flanged Tailpiece - Polypro plastic. Comes in display polybag.			
1 1/2" x 4"	1	94016	87414
1 1/2" x 6"	1	94018	123200
1 1/2" x 12"	1	94020	123205
Flexible Tailpiece Extensions - Compatible with all existing drain systems. Flexibility allows for offset connections for up to 2". Connects to either plastic or metal.			
1 1/4" x 9"	1	51070	123515
1 1/2" x 11 1/2"	1	51069	123510
1 1/2" x 12"	1	51068	123505
End Outlet Tee - Slip joint or direct connect. Polypro plastic with baffle. Comes in display polybag.			
1 1/2"	1	94010	123275
Dishwasher Tailpiece - Slip joint or direct connect styles. Polypro plastic. Comes in display polybag.			
1 1/2" x 8" Direct Connect	1	94023	123260
1 1/2" x 8" Slip Joint	1	94057	87416
90° Elbow - Polypro plastic. Comes in display polybag.			
1 1/2" x 1 1/2"	1	94034	123220
Flexible Slip Joint Coupling - 6"			
1 1/2" x 1 1/2" x 1 1/4"	1	51067	123500
Tee - Polypro plastic. Comes in display polybag. Includes 3 nuts and washers			
1 1/4" x 1 1/2"	1	94038	123225
Coupling - Polypro plastic. Comes in display polybag. Includes 2 nuts and washers.			
1 1/4" x 1 1/2"	1	94036	123215
PVC Trap Adapter - Comes in display polybag. Slip joint solvent weld. Includes nut and washer			
1 1/2"	1	94041	123325



PLUMBING & HEATING

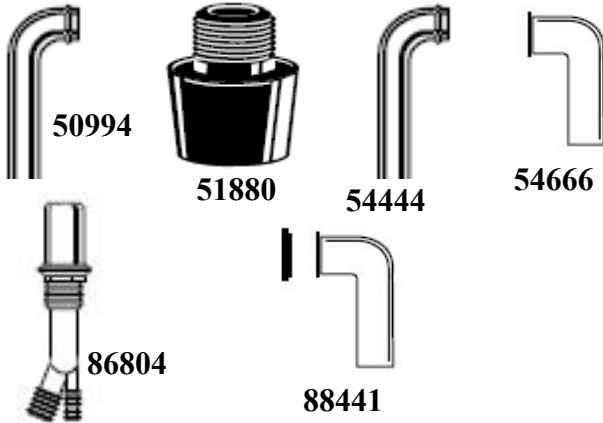

PLASTIC TUBULAR

DANCO

Item	Pack	Part #	HDI #
1 1/2" Molded Wall Tube - Ground Joint. PVC Plastic. Comes in Display Polybag			
1 1/2" x 7 3/4"	1	50994	87372
1 1/2" Trap Vent - ABS Plastic. Air automatically enters drainage line to prevent syphonage. Seal closes as drainage stops to prevent sewage gas from entering home. For use with sinks, tubs, showers, & washing machines.			
1 1/2"	1	51880	87374
1 1/4" Wall Bend - Ground Joint. Polypro Plastic. Comes in display polybag.			
1 1/4" x 8"	1	54444	87382
Disposal Bend for Waste King - White PVC. Slip Joint Style.			
1 1/2" x 8"	1	54666	87384
Complete Dishwasher Air Gap - Prevents waste from backing up into dishwasher. No moving parts.			
Extruded Plastic	1	86804	87398
Tailpiece for In-Sink-Erator			
1 1/2" x 8"	1	88441	87402



PLUMBING & HEATING



TOILET TANK REPAIR PARTS

DANCO

Item	Pack	Part #	HDI #	
Universal Plastic Flush Valve - Faster and greater flush with angled valve body. Includes flapper. Provides a positive seal with no hang-ups. 8" Tube	5	80815	85116	
Toilet Tank Repair Kit - Contains universal flapper with adapter, Spring, Float with Rod and Ballcock with Refill Tube.	5	80816	85056	
Anti-Siphon Toilet Repair Kit - Includes Flapper with Adapter	5	88286	86489	
Universal 8" Plastic Ballcock - Positive snap shut-off. Concentrate hush tube for silent filling. Nylon screw for adjusting desired water level.	3	80814	88166	
Anti-Siphon Ballcock - Includes brass float rod, vinyl refill tube, lock nut, coupling nut and washers. Plastic one piece design.	12"	5	88919	88348
"Touch Flush" Unit for Eljer - Includes bracket and lever arm assembly	3	88017	88196	
Coast Mark IV Anti-Syphon Ballcock - Includes float, flapper, and tank lever. 10 3/4" height. Durable plastic	3	88915	88346	
Anti-Syphon Fill Valve - Fits most toilets. Includes metal refill tube, rubber washer, refill tube, washer & nut	3	80008	85053	
Watersaver Flush Valve for Mansfield - Replaces models #208 & #209	3	88907	88330	



TOILET TANK REPAIR PARTS

DANCO

Item	Pack	Part #	HDI #
Danco HC630 Fast Fill Valve - Universal - Saves water and detects leaks and signals when a leak is found. Other features of this valve include easy installation without tools and in-tank repairs without turning off the water source.	10	HC630	125268

FLUIDMASTER

Item	Pack	Part #	HDI #
Anti-Siphon Ballcock - Plastic. 9" to 14" height adjustment. Fits most tank sizes. Operates with high or low water pressure.	25	400A	87002
Anti-Siphon Repair Valve Kit - Kit includes 400A valve and flapper tank ball replacement.	10	400C	87003

MANSFIELD

Item	Pack	Part #	HDI #
Anti-Siphon Ballcock - 10" plastic. Competitive code approved. With float rod and refill tube. Boxed	20	08	85951
Flush Valve - Replaces all other types of flush valves. Fits virtually any tank type toilet. Won't hand up or stick open. Seals tight every time.	1	210	85953

OVERFLOW TUBES



DANCO

Item	Pack	Part #	HDI #
Overflow Tube - 1" x 11" Long			
Molded ABS	3	80805	88150
Overflow Tube - 1" x 11" Long.			
Brass	3	88914	88344



PLUMBING & HEATING



BALLCOCK REPAIR PARTS

DANCO

Item	Pack	Part #	HDI #
Diaphragm for Fluidmaster Ballcocks - Used on models #100, #200, #300A and #400A Ballcocks			
Carded	6	80141	88106
Ballcock Piston for American Standard - Used on series B1939 & N3010. Replacement cups are not interchangeable.			
Complete Replacement Piston for Either Series	3	80150	88108
Repair Kit for Coast Ballcocks - Used on 1B1 and Coastmaster Series ballcocks			
	3	80408	88134
Repair Kit for American Standard Ballcocks - Used on models #N3015 and #N3025 ballcocks			
	6	80409	88136
Repair Kit for Amerline 4-Screw Ballcocks - Used in all Amerline (Hoov-R-Line) ballcocks			
	3	80411	88138
Top Assembly for Coast Ballcocks - Used on Mark III series ballcocks.			
Carded	3	88375	88254
Top Assembly for Mansfield Ballcock - Used on model #08 ballcock			
Complete Kit	3	88377	88256
Top Assembly for Coast 3-Screw Ballcock - Used on Coastmaster series ballcock			
	3	80923	88188
Top Assembly for Amerline 4-Screw Ballcock - Used in Pre-1985 ballcocks. Includes vinyl tube			
	3	88362	88236
Repair Kit for Coast Ballcocks - Used on 1B1-X series ballcock. Kit contains seal ring, 3 brass screws, piston assembly (complete)			
Complete Repair Kit	3	88378	88258
Kohler Ballcock Piston			
	12	88409	88262
Repair Kit for Mansfield Ballcocks - Used on model #08 ballcock			
	6	88908	88332



40121

TOILET TANK FLOAT

DANCO

Item	Pack	Part #	HDI #
Tank Floats - Black plastic with internal stop for positive shut off.			
	5	40121	88090

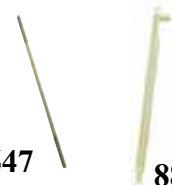

FLOAT ROD 88647

88146

DANCO

Item	Pack	Part #	HDI #
Adjustable Float Rod - Brass plated steel. Float rod with extra long threads.			
8"	3	80809	88158
10"	3	88647	88282
Float Rod for Coast - 8" Plastic			
	3	88146	88216



80140

BALLCOCK SHANK NUTS 88373 88372

DANCO

Item	Pack	Part #	HDI #
Ballcock Shank Nuts - Used to hold ballcock in tank.			
Universal Cast Brass	6	80140	88104
Ballcock Supply Coupling Nuts - 1/2" w/ 5/8" Knock-Out			
	6	88373	88252
Ballcock Coupling Nut Washers - Poly with insert 13/16" x 5/16" x 1/8"			
	6	88372	88056
Ballcock Supply Nut - Plastic w/rubber washer and brass ring.			
	6	81422	86513



PLUMBING & HEATING



FLUSH LEVERS
DANCO

Item	Pack	Part #	HDI #
Tank Levers for Mansfield - 10" Metal Arm. Use with Watersaver Flush Valve.			
Chrome	3	80371	88124
Tank Levers for Mansfield - 9" Arm. Used with Water-saver Flush Valves #208 & #209			
Blue Plastic Arm - Chrome	3	88364	88240
White Plastic Arm - Chrome	3	88365	88242
Tank Levers for Kohler - 8 3/4" Arm. Chrome plated handle. Trip arms do not included flush handle & support bracket			
Complete Tank Lever	3	88900	88318
Brass Trip Arm	3	88093	88202
Sidemount Tank Levers for Kohler - 8 1/2" Plastic Arm.			
Chrome	3	88367	88246
Plastic Universal Tank Levers - Fits most toilets on the market today. 8" arm.			
Chrome Plated	3	80372	88126
Univeral Tank Lever - Fits most toilets on the market today. 8" arm. Metal arm with plastic shank and nut. Chrome plated handle.			
	3	80373	88128
Universal Tank Lever - 8" Arm. All metal construction			
	3	80806	85206
Push Button Universal Tank Lever - Replaces 90% of side mount push button levers. 8" plastic arm.			
	3	88368	88248
Metal Universal Tank Lever - Fits most toilets on the market today. Single action. Brass arm & spud. Chrome plated handle			
8" Polished Brass	3	88010	88194
Metal Universal Tank Lever - Fits most toilets. Chrome plated handle			
8" Brass Arm	3	88366	88244
Universal Trim-to-Fit Tank Lever - Can be quickly and easily cut to desired length. 10" length can be trimmed to 8", 6", or 4"			
Chrome	3	88531	88274
White	3	88593	88276



FLUSH LEVER
DANCO

Item	Pack	Part #	HDI #
Sidemount Tank Levers for Eljer			
9 1/4" Metal Arm	3	88363	88238
"Touch Flush" Lever for Eljer			
	3	88007	88192
Tank Lever for American Standard - 6" Arm. Molded construction. Used on Plebe & Tiche			
	3	88433	88264
Tank Levers for American Standard - 6" Arm. Plastic construction. Fits Cadet			
White 28°	3	88595	88278
Chrome 28°	3	88596	88280
Chrome 45°	3	88692	88292
Tank Levers for American Standard - 6 1/4" Plastic Arm. Chrome plated handle. Used on Yorkville, Glenwall, Cadet, Baby Devoro, Plebe, New Cadet and the Line			
	3	88901	88320
Designer Tank Levers - Fits most brands and models of toilets. Fits all styles of tanks: Front mount, Angle mount, and Side mount. Lever can be cut to size.			
All Plastic - Chrome Finish	3	10031	85211
Chrome	3	89447A	88374
White Porcelain w/Chrome	3	89448A	88376
PVD Brushed Nickel	3	89449A	88378
Oil-Rubbed Bronze	3	89450A	88380
PVD Polished Brass	3	89451A	88382
Dual Flush Toilet Handle - Reduces water used in every flush by up to 24%. Installs in less than 10 minutes and does not require taking toilet apart to be installed. Push down for water saving flush, Push up for standard full flush.			
Chrome	3	10071	86326



PLUMBING & HEATING



**FLAPPERS
DANCO**

Item	Pack	Part #	HDI #
Universal Flapper - Fits all standard flush valves			
Less Adapter	3	80807	88154
With Adapter	3	80808	85074
Flappers for Amerline/Kohler - Rubber flapper			
	5	80812	88162
Positive Seal Flapper - Used on various manufacture's low consumption toilets including Kohler Wellworth Life and Sterling Windham.			
Flapper	3	88246	88222
Gasket	3	88247	88224
Premium Flapper - Molded in one piece. Fits all standard flush valve			
	3	88353	88228
Premium Flapper - Guarantees fit for virtually all flush valves including "tilt" models. Made of 100% of natural rubber. Silicone treated - chloramine resistant			
Carded	3	88442	88266
Flapper for Eljer - Used on Low Boy style closets. Fits Eljer Patrician, Windsor, & Canterbury one piece aqualine			
	3	88462	88268
Premium Flapper for Kohler - Used on several low consumption toilets including Rialto. Silicone treated - Chloramine resistant.			
	3	88662	88288
Flappers for Amerline/Kohler - Used on: AAA, Alliance, Case, Georgia, Hilgore, Kohler, Kokomo, Lawndale, National, Peerless, Rheem, Verson, Vitroteck, Woodbridge			
	3	88686	88290
Flapper for Coast Flush Guard - Includes 5 color-coded inserts with each item insert having a different size hole which regulates the air that passes through, determining the rate at which the flapper drops.			
	3	88763	88298
Premium Flapper for Toto - For use on all TOTO power toilets with over-sized flush valves with 3" opening. Silicone treated			
	3	88874	88308
Premium Flapper for Kohler - For San Raphael & Rialto			
Silicone Treated	3	88875	88310

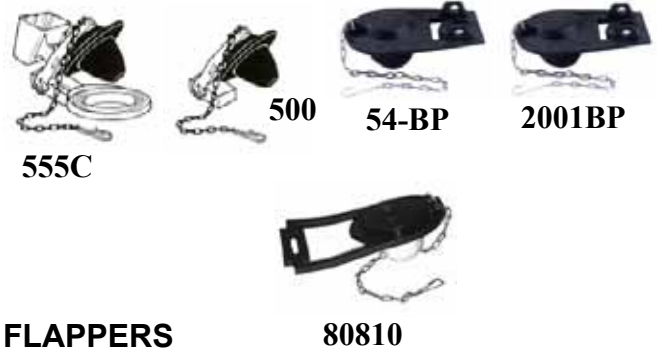

FLAPPERS

DANCO

Item	Pack	Part #	HDI #
Premium Flapper for Crane - Used on Crane's Close-Coupled Closets with Integral China Seats & Overflow. Used on Neuday, Oxford, Drexel, Criterion.			
	3	80810	88160

FLUIDMASTER

Item	Pack	Part #	HDI #
Flush Valve Repair Kit - Renews leaking flush valve seat. Complete with plastic seat, frame, flapper, chain, and sealant.			
	25	555C	87005
Flapper Tank Ball - Replaces old flapper or old fashion tank ball/bracket/lift wire. Complete with flapper, chain, and frame.			
	20	500	87004

LAVELLE

Item	Pack	Part #	HDI #
Flapper Tank Ball - Korky. Fits most conventional flush valves. With chain and hook. Rubber. Carded			
	12	54-BP	85076
Flapper Tank Ball - Korky Plus "Red" Withstands the purification chemicals found in today's municipal water, as well as the toilet cleaning products that deteriorate standard rubber parts used in the water closet.			
	12	2001BP	85078



FLAPPER CHAIN

DANCO

Item	Pack	Part #	HDI #
Flapper Chain, Hook, Ring - Non-corrosive stainless steel. Contains Flapper Chain, Hook, & Ring			
	5	88073	88200
Flush Valve Chain for American Standard - For new style #5 flush valve low profile			
	6	88408	88260



PLUMBING & HEATING



TOILET TANK BALLS



88909

DANCO

Item	Pack	Part #	HDI #
Universal Tank Ball - Molded in one piece. Fits all valves 2 1/4", 2 3/8", 2 1/2", 2 5/8"			
Black	3	80800	88144
Premium Silicone Treated	3	88869	88304
Universal Tank Ball - Self-Aligns. Unverisal fit.			
	5	88762	88296
Tank Ball For Eljer - Used on Eljer "Touch-Flush" Unit			
Rubber Tank Ball	3	80813	88164
Premium Silicone Treated	3	88694	88294
Tank Bulbs - Molded in one piece			
2 1/2"	3	88369	88250
3" Triple Seal Tank Ball - Fits old style case & Kohler closets			
	3	88909	88334

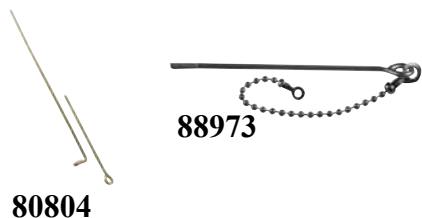

LIFT WIRES

80804

88973

DANCO

Item	Pack	Part #	HDI #
Lift Wires - Contains 9" lever wire & 4 1/2" tank bulb stem			
	5	80804	88148
Tank Bulb Stems - Brass Plated Steel			
4 1/2" Wire with Chain	10	88973	88358



GUIDE ARMS

DANCO

Item	Pack	Part #	HDI #
Adjustable 1" x 1 1/8" x 1 1/8"			
Cast Brass	3	88906	88328



ACTUATING UNIT

DANCO

Item	Pack	Part #	HDI #
For American Standard - Fits American Standard flush valves.			
#4 Sub Assembly	3	88097	88210
#5 Sub Assembly Low Profile	3	88098	88212
#5 Complete Flush Valve	3	89058	88370



FLUSH VALVE REPAIR

DANCO

Item	Pack	Part #	HDI #
Seal for American Standard Flush Valve - Series N-3055			
Seal	3	80955	88190
Flush Valve Seat Discs For American Standard - Used on tilt style flush valves.			
Screw-on Style	3	80555	88142
Snap-on Style	3	80412	88140
2-in-1 Disc Silicone Treated	3	88936	88352
Complete Flush Valve for Universal Rundle - Used on model #278			
	3	41125	88100
Seat Disc & Strap for Universal Rundle - Used on models #259, #260, #278 and #280 flush valve			
Strap	6	80357	88120
Diaphragm Seals for Mansfield Flush Valve			
Fits #210 Series	3	88096	88208
Fits #210 Series, Silicone Treated, Chloramine Resistant	3	88870	88306
Repair Kit for Mansfield Flush Valve - Used on models #208 and #209 Flush Valves			
Valve Seal & Stop	3	88360	88232



PLUMBING & HEATING



PERFECT SEAL

DANCO

Item	Pack	Part #	HDI #
Perfect seal - guarantees a perfect seal on the first toilet installation. Unlike wax rings, perfect seal is 3 times stronger and allows the toilet to be repositioned as needed. Maintains a tight seal when common toilet and floor movement occurs. Accommodates flange heights from 1/2 in. above the floor to 1-1/2 in. below the floor. Repositionable with no mess and three times stronger than a wax ring.			
	20	10718	85159



TOILET FLANGE REPAIR KIT

DANCO

Item	Pack	Part #	HDI #
Hydroseat - Fixes a wobbly or leaking toilet. Repairs a damaged or broken closet flange and allows for multiple resets. Seals out sewer gas. Rubber funnel contours to fit any toilet or closet flange. Closet floor bolts, stainless steel washers and nuts included.			
	5	10672	125232



40618 40619 155000



G237 KIT/32 G-236D G-237D

TOILET BOWL WAX RINGS

DANCO

Item	Pack	Part #	HDI #
Provides a positive seal between closet bowl and flange. Available in a variety of styles to meet virtually any need. Workable in hot & cold temperatures. Fills cracks & crevices. Vermin proof. Kit includes 2 - 1/4" x 2 1/4" solid brass closet bolts.			
Wax Ring less Sleeve for 3" & 4" Openings	48	40618	88092
Wax Ring with Sleeve for 4" Waste Line	24	40619	88094

HARVEY'S

Item	Pack	Part #	HDI #
With Polyethylene Flange fits 3" and 4" lines, extra thick wax gasket with 40% more wax saves using two wax rings for faster installation and a more positive seal. For problem areas that need extra thick wax gasket. Boxed.			
Thick Toilet Bowl Wax Ring	24	001115-24	155000

RADIATOR SPECIALTY

Item	Pack	Part #	HDI #
Kant Leak Flange Wax Ring Kit - provides a complete solution when repairing or replacing a toilet bowl. Universal for all floor type toilet bowls. Ensures lasting seal between toilet bowl and flange. Will not dry, harden or crack. Contains 2.25 x .25 solid brass closet bolts.			
	32	G237 KIT/32	85128
Wax Toilet Bowl Ring - Insures a long lasting waterproof, odor proof, gas proof seal between bowl and flange.			
	60	G236D	85130
Wax Toilet Bowl Ring With Sleeve - Bowl ring with polyethylene horn. Fits both 3" and 4" soil pipe. Ideal for use on short horn bowls.			
	24	G237D	85132



PLUMBING & HEATING



88904

TOILET REPAIR - FLANGES

DANCO

Item	Pack	Part #	HDI #
Floor Flanges - For closets. Cast brass			
4" Lead Drain Line w/1" Lip	3	40637	88096
Anchor Flange - Stops rocking toilets. Quick and easy to install. Case hardened steel construction			
	6	88480	88270
Closet Flange Repair Ring - Platisol coated for long lasting corrosion protection. Unique screw tabs allow ring to be securely attached to a wooden or concrete subfloor.			
	3	88904	88324



TOILET REPAIR - EZ WEDGE

DANCO

Item	Pack	Part #	HDI #
For stabilizing toilets, tubs, furniture and more. Clear plastic. Packaged 6 per card. 1 7/8" x 1 1/8" x 1/4"			
	6	88523	88272



40079B

40077B

80867

88539

80249

80801

80857

80864

TOILET REPAIR WASHERS AND GASKETS

DANCO

Item	Pack	Part #	HDI #
Gaskets for Flush Valve/Ballcock - Apply to the threaded shank as the seal. Between the closet tank and the flush valve or ballcock.			
For Flush Valve	1	40079B	86383
Balloon Tank Gasket - Used between the tank and the closet on free standing closets. Sponge rubber.			
3 3/16" x 2 1/8" x 11/16"	1	40477B	86385
Universal Tank Gasket - Sponge Rubber			
3 1/2" x 2 1/8" x 1 3/16"	5	80867	88186
Flanged Type Closet Spud Gasket			
2"	5	40479B	86389
Cone Washers & Rings - For toilet ballcock. Contains 2 each: 38808, 38805, 38807, 36616, and 4 each: 36617			
	6	88539	88065
Gaskets for Flush Valve/Ballcock - Apply to the threaded shank as the seal between the closet tank and the flush valve or ballcock			
For Ballcock	3	80249	88114
Balloon Tank Gasket - Used between the tank and the closet on free standing closets. For American Standard			
	3	80801	88146
Tank-to-Bowl Gasket for Kohler - Used on Kohler intergral unit closets.			
4 3/16" x 2 3/8" x 3/4"	3	80857	88182
Balloon Tank-to-Bowl Gasket for Gerber - Used on late model Gerber free standing closets. Sponge Rubber			
3 1/8" x 2 1/16" x 1 3/16"	3	80864	88184
Tank-to-Bowl Gasket for Mansfield			
3 1/16" x 2 1/4" x 1/2"	3	88361	88234
Tank-to-Bowl Gasket for Mansfield - Used on Water-saver model #210			
Black Rubber	3	88912	88340



CLOSET BOLTS & SCREWS

DANCO

Item	Pack	Part #	HDI #
Closet Screws - Includes head and washer. 2 per card			
1/4" x 2 1/2"	5	80157	85350
1/4" x 3"	5	88942	86503
Toilet Bolt and Screw Set - Includes 2 each of 1/4" x 2 1/4" bolts and 1/4" x 2 1/4" screws. Brass plated			
	5	88986	86491
Universal Tank-to-Bowl Kit - Complete and ready to go kit. Includes 2 tank bolts with washers and nuts and 1 sponge rubber spud gasket.			
5/16" x 2 1/2"	5	80378	85060
Tank Bolts - Used to attach bowl to tank on close-coupled outfits. 2 per card. Includes washers and nuts			
5/16" x 2 1/2"	6	80819	88174
5/16" x 3"	6	88910	86493
Closet Bolts - Includes round washer. 2 per card.			
1/4" x 2 1/4"	3	80156	86490
1/4" x 3 1/2"	3	88920	88350
5/16" x 2 1/4"	3	89055	86492
5/16" x 3 1/2"	3	43805	85063
"Kwik" Closet Bolts - Unique break-a-way feature enables you to adjust to the proper height without the use of a hacksaw. Quick installation and perfect alignment with unique captured washer feature. Includes extra heavy nuts and nickel plated brass washers.			
1/4" x 2 1/4"	6	88772	88300
5/16" x 2 1/4"	6	88773	85062
Toilet Bolts with Screw-on Caps - Solid brass. Hi-impact plastic caps have unique screw-on design.			
1/4"	6	88883	88314
5/16"	6	88884	88316
Tank Bolts - Used to attach bowl to tank on close-coupled outfits. 2 per card			
5/16" x 3 1/4" Solid Brass	3	88911	88338



TANK-TO-BOWL KIT

DANCO

Item	Pack	Part #	HDI #
American Standard Plebe - Complete and Ready to Go. Includes 2 tank bolts with washers and nuts, 1 sponge rubber spud gasket.			
5/16" x 2 1/2"	3	88191	88218
Gerber - Complete and Ready to Go. Includes 2 tank bolts with washers and nuts, 1 sponge rubber spud gasket			
3/8" x 3 1/4"	3	88193	88220
Eljer - Complete and Ready to Go. Includes 2 tank bolts with washers and nuts, 1 sponge rubber spud gasket			
5/16" x 3 1/4"	3	88359	88230
Mansfield - Complete and Ready to Go. Includes 3 tank bolts with washers & nuts, 1 molded rubber spud gasket			
5/16" x 2 1/2"	3	88913	88342



TANK BOLT WASHERS

DANCO

Item	Pack	Part #	HDI #
Tank Bolt Washers			
5/16" Bolt, 1" x 1/4" x 1/8"	5	80352	85067
3/8" Bolt, 1 1/8" x 5/16" x 1/8"	1	40603B	86387



PLUMBING & HEATING

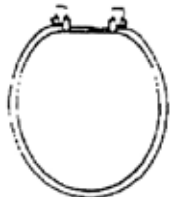

050-1066WT



400-WB

TOILET SEATS

LDR

Item	Pack	Part #	HDI #
Enameled wood composition construction. Plastic hinge mount from the top.			
White	6	050-1066WT	85070

MAGNOLIA

Item	Pack	Part #	HDI #
Solid Plastic seat with four integrally molded bumpers. Matching top mount hinges for easy installation.			
White	6	400-WB	85071



TOILET SEAT BUMPER

DANCO

Item	Pack	Part #	HDI #
Universal Toilet Seat Bumper Kit - White Plastic. Includes 2 Oblong Bumpers, 2 Round Bumpers Adhesive			
Carded	3	10062	88116

80822



88653



TOILET SEAT HINGE BOLTS

DANCO

Item	Pack	Part #	HDI #
2 per package.			
7/16" Diameter White Plastic	3	80822	88180
3/8" diameter White Plastic	3	88095	88206
Brass Plated	3	88653	88286



88018

TOILET SEAT HINGE

DANCO

Item	Pack	Part #	HDI #
White molded plastic. Packed in pairs			
	3	88018	88198
Toilet Seat Hinges			
Chrome Plated	3	88983	88360



89057

TOILET SEAT WASHERS

DANCO

Item	Pack	Part #	HDI #
Toilet Seat Hinge Washers - White rubber. 1 1/8" x 3/8" x 1/8"			
	3	89057	88368

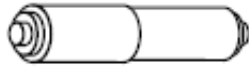

TOILET PAPER ROLLER

DANCO

Item	Pack	Part #	HDI #
Tapered tip allows for replacement of any existing roller. Spring loaded.			
Universal White Plastic	5	88648	88284
6 1/2" x 5/8" Chrome	3	88905	88326

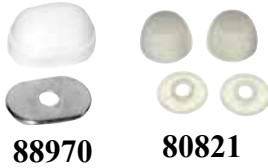

TOILET BOLT CAPS

DANCO

Item	Pack	Part #	HDI #
Oval - Includes 2 caps and 2 washers			
White	6	88970	88356
Round - Contains 2 caps and 2 washers			
White	6	80821	88178
Almond	6	89094	88372
Screw-On - Fits 1/4" & 5/16" closet bolts. Hi-impact plastic construction resists breaking.			
White	6	88877	88312



PLUMBING & HEATING



FAUCET HANDLE REMOVER

DANCO

Item	Pack	Part #	HDI #
Removes all types of frozen handles quickly and easily: hooded, cross arm or lever type. Prevents broke or bent stems. Easy to use and saves time.			
Twisting Handle-off Tool	5	89099	86593



WRENCHES

DANCO/LDR

Item	Pack	Part #	HDI #
4-in-1 Wrench - Fits slip nuts, 2 closet spuds, and basket strainer nuts.			
	5	89106	86573
3" Adjustable Spud Wrench - For use on coupling nuts, locknuts, slip-joint nuts, trap nuts, & 2 closet spud nuts.			
	5	89105	85514
Basin Wrench - Reversing jaws. Grabs coupling nuts firmly			
	5	88451	85512
Bibb Seat Wrench - Unversal style. Hex broach on one end, square broach on the other.			
Tapered for universal fit	5	511-2120	86575
3 steps each end	5	80439	85516
Strap Wrench - Just right for polished surfaces, plastic pipe, and glass pipe.			
6" fits up to 3" OD	5	86714	87031



SHOWER VALVE SOCKET WRENCHES

DANCO

Item	Pack	Part #	HDI #
Set fits 99% of all existing shower valve bonnets. Complete set includes handle and carrying pin			
	5	60505	86599

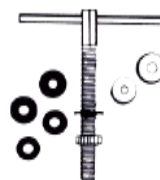

RESEATING TOOL

DANCO

Item	Pack	Part #	HDI #
Reseating Tool w/3 Cutter Wheels - Includes 1/2", 9/16", and 5/8" cutters			
	5	86715	85740



501 186 VIP2 H34

DRAIN KING

GT WATER PRODUCTS

Item	Pack	Part #	HDI #
Drain King unclogs sinks, tubs, showers, and other drains with water pressure. Insert into clogged drain and attached hose to flush away clog.			
For 1" to 2" Drains	12	501	150720
For 1 1/2" to 3" Drains	12	186	150725
For 1 1/2" to 3" Drains Faucet Adapter, Drain Adapter	6	VIP2	150735
For 3" to 4" Drains	12	H34	150730



PLUMBING & HEATING

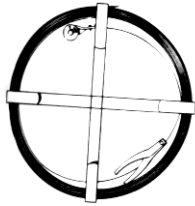

HEAVY DUTY DRAIN TAPE

LDR

Blue tempered steel tape.

1 per sleeve

1/4" x 25'

(85530) 512-2125

1/2" x 50'

(85532) 512-2250

pk 5



TOILET PLUNGER

Korky

Professional strength plunger made of non-marking rubber. Fits most toilets including 1.6. Longer 21" yellow wood handle. Durable and flexible for a more powerful plunge.

(85096) 93-8

pk 8

4" FORCE CUP

LDR

9" wood handle.

Bulk pack

(85092) 512-3110

pk 5

5" FORCE CUP

LDR

19" wood handle.

Bulk pack

(85094) 512-3210

pk 5

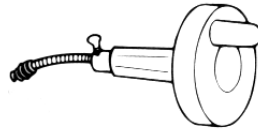

MANUAL CANISTER AUGER

LDR

Medium duty spring wire. Plastic canister.

Bulk packed

1/4" x 15'

(85526) 512-1110

1/4" x 25'

(85528) 512-1130

pk 5



MANUAL DRAIN AUGER

LDR

Spring wire.

1 per sleeve

1/4" x 8'

(85521) 512-1310

1/4" x 15'

(85522) 512-1315

pk 5



DRAIN AUGER

LDR

High quality spring wire, spiral head. Includes handle.

3/8" x 25'

(85523) 512-1425

pk 5



MANUAL TOILET AUGER

LDR

7/16" x 3' spring wire.

1 per sleeve

(85524) 512-1220

pk 5



MASTER PLUNGER

GT Water Products

Our new all-purpose plunger designed to fit all drains and those hard to reach ones- like the bathroom sink. With the "stream line design" this plunger has the plunger power, flexibility and also a patented air release with a quarter turn of the hand.

Black

(150700) MP500-3

pk 15



PLUMBING & HEATING



HOSE FILTER WASHER

DANCO

Item	Pack	Part #	HDI #
For automatic washer inlet hose. Traps scale. Rubber. Brass screen			
2 per card	5	80070	87644

RUBBER HOSE WASHER



DANCO

Item	Pack	Part #	HDI #
5/8" hose size. 3/4" ID x 1" OD x 1/8" thick. 10 per card			
Carded	6	80787	87652

LINT TRAP



DANCO

Item	Pack	Part #	HDI #
Eliminates clogs. Reusable. Cleans easily. 2 per card			
Stainless Steel	3	88995	86866

LDR

Item	Pack	Part #	HDI #
Eliminates clogs. Reusable. Cleans easily. 2 per card			
Nylon	5	504-3110	86865



WASHING MACHINE CONNECTORS

DANCO

Item	Pack	Part #	HDI #
Stainless Steel Connectors - Features Chloramine-resistant inner core and soft cone washer. Flexible. Suitable for water temperatures 33°F to 140°F. Stainless Steel			
3/4" FHT x 3/4" FHT x 48"	10	65705	87584
3/4" FHT x 3/4" FHT x 60"	10	65706	87586
3/4" FHT x 3.4" FHT x 72"	10	65707	87588
Rubber "Y" Fill Hose - 12" Arms. High pressure hose with brass plated couplings			
	5	36336	85162
High Pressure Rubber Fill Hose - 3/4" female hose threads.			
72"	5	36338	87994

LDR/DANCO

Item	Pack	Part #	HDI #
High Pressure Fill Hose - 3/4" female hose threads both ends. 90° formed bend one end. 1 per bag			
6'	5	504-1250	86831
Discharge Hose - 3/4" OD with preformed outlet. Fits 7/8" to 1" discharge stub. 5' long. 1 per bag			
	5	36337	87992



WASHING MACHINE HOSE

RPM PRODUCTS

Item	Pack	Part #	HDI #
For both hot & cold water. Resists softening action of hot water. Complete with instructions & washers.			
4 ft	12	2154	85164
5 ft	12	2155	85166
6 ft	12	2156	85168
8 ft	12	2158	85170



PLUMBING & HEATING



SEPTIC TANK TREATMENT

ENFORCER/ZEP

Item	Pack	Part #	HDI #
Helps to reduce costly pumping & to prevent septic tank backups. 6 month treatment. Pre-measured treatment packs, easy periodic treatments keep systems flowing, helps prevent septic backups.			
6 - 2 oz. pouches	6	ZSTP-6	150420



COPPER SULPHATE ROOT KILLER

ROOTO

99% copper sulphate crystals for destroying roots in sewer lines and in septic systems			
2 lb.	12	1185	150317



SUPER IRON OUT

IRON OUT

All purpose rust & stain remover. Cleans water softeners, toilets, sinks, tubs, & white clothes.			
30 oz.	6	1030N	150400
5 lb.	6	1065N	150401



DRAIN KING MINI SNAKE

GT WATER PRODUCTS

Item	Pack	Part #	HDI #
Used to: Unclog your sinks, shower tubs, bath drains, urinals and laundry basins. Made out of high strength resin.			
	36	DKMS	155600



1270



1070



1071



1090



1033



DC-16



EHCR64



EPRD064

TOILET & DRAIN OPENER/CLEANER

ROOTO

Item	Pack	Part #	HDI #
Thick Drain Opener - Industrial Strength, Twice the ingreidence			
Quart	12	1270	150300
Liquid Drain Cleaner - Liquefies grease without spitting or fuming. Contains Potassium Hydroxide.			
Quart	12	1070	150308
Professional Liquid Drain Cleaner - Opens sinks, traps, floor drains, grease traps. Dissolves grease, food residue, paper, rinds, hair, soap, sanitary napkins & tobacco. Contains sulfuric acid with an inhibitor to keep fuming at a minimum.			
Pint	12	1069	150304
Quart	12	1071	150305
½ Gallon	6	1079	150306
Gallon	4	1084	150307
Grease Trap Toilet & Drain Opener - Cleans grease traps and opens any toilet drain.			
2 lb.	12	1033	150323
Liquid Bowl Cleaner - Delimer - cleaner. Industrial strength. Cleans and removes lime, rust, scale and stains.			
Quart	12	1090	150321

ENFORCER

Drain Care - Enzymatic drain cleaner ends slow drains. Cleans years of buildup from plumbing systems.			
1 lb.	12	ZDC-16	150405
10 Minute Hair Clog Remover - Fast acting. Won't harm pipes. Half gallon opens up to ten hair-clogged drains. Safe for septic systems.			
64 oz.	8	ZHCR64NG	150403
Maximum Strength Gel Drain Opener - Opens clogged drains fast. Safe for all pipes. Pours through standing water.			
64 oz.	8	EPRD064	790343



PLUMBING & HEATING



WATER FILTERS

CULLIGAN

Item	Pack	Part #	IBM #
Refrigerator Water Filter - For refrigerators with ice cube makers or water dispensers. Includes nylon fittings for easy installation.			
	12	IC-100	60032
Whole House System - The do-it-yourself whole house clean water system with by-pass and shut-off valve. Tank wrench included. Cartridge S-1A & CW-F. Cartridge sold separately.			
	6	HF-360	60027
Multi-Purpose Water Filter - Opaque tank. Economical full size, whole house or under sink water filter. Provides effectiveness at a lower price. Cartridge and wrench sold separate. Cartridge S-1A & CW-F			
	6	HF150	60034
Replacement Cartridges			
Twin Pack Cartridge Wound activated Carbon 5 Micron Rating	12	D-10	60028
Single Pack Cartridge Granular activated carbon 20 Micron Rating	12	D-20A	60036
Rust & Sediment Cartridge Twin Pack Fits HF150/HF360 String wound polypropylene 10 Micron Rating	6	CW-F	60030
Rust & Sediment Cartridge Twin Pack Fits HF150/HF360 Pleated Resin Impregnated Cellulose	6	S-1A	60026
Premium Spun Polypropylene Cartridge Twin Pack Fits HF360 5 micron Rating	6	P-5	60152



WATER FILTER ACCESSORIES

CULLIGAN

Item	Pack	Part #	HDI #
Housing Wrench - 3/4" I/O Filter wrench fits HF-360 and HF-150 filters.			
	6	SW-2A	60031
O-Ring - Replacement O-ring. In plastic bag with peg-board header.			
	6	OR-34	60033



PLUMBING & HEATING



KLEEN FLO INTAKE SCREEN

NORTHEN WIRE

Item	Pack	Part #	HDI #
Pump water from a lake, river, canal, cistern or well. Metal, vinyl coated cage with a 2" diameter male iron pipe thread. Cylinder is 9" x 28". Pump capacity of 6.000 gallons per hour			
Complete Intake Screen	1	KF100	40998
Replacement Screen - Fiberglass "bag" fits snugly and is secured with a heavy nylon draw cord. Immune to rot or mildew., highly resistant to puncture, cleaned by water-spray or brushing			
	1	KF101	40999



PITCHER SPOUT PUMP

BOSHART

Item	Pack	Part #	HDI #
Cast iron. For wells to 30' deep. 3" cylinder. Threaded for 1 1/4" pipe.			
Pump	1	19-HP	120501
Replacement Parts			
Plunger Assembly	1	19-HP-01	120503
Handle	1	19-HP-05	120505
Pump Weight & Leather	1	19-HP-02	120507



DRIVE CAP

BOSHART

Item	Pack	Part #	HDI #
Heavy duty forged steel. Vented in top.			
1 1/4"	1	U18-181	50126
2"	1	U18-183	40216



DRIVE COUPLING

BOSHART

Item	Pack	Part #	IBM #
Extra heavy duty. Recessed and straight top.			
1 1/4"	1	U18-184	50125
2"	1	U18-186	40215



WELL POINT

BOSHART

Item	Pack	Part #	HDI #
One piece with forged steel plug, eliminating the possibility of plug loosening on pipe. Rectangular holes punched in the pipe and hot galvanized after punching. Covered with stainless steel wire cloth and then perforated stainless jacket to protect the stainless wire cloth. [Screen is 6" less than overall pipe length} Individually boxed.			
1 1/4" Drive 80-Mesh Gauze			
30" OAL	1	UWP12-24	40317
36"	1	UWP12-30	40319
48"	1	UWP12-42	40323
2" Drive 80-Mesh Gauze			
48" OAL	1	UWP20-42	40326
60"	1	UWP20-54	40327



PLUMBING & HEATING



NU-WELL ACID TABLETS

JOHNSON SCREENS

Item	Pack	Part #	HDI #
Nu-Well acid tablets are the most effective line of chemical solutions for well construction or well rehabilitation. Removes mineral deposits from calcium & magnesium carbonate scale, iron deposits and moderate biological growth. Safer to handle dry form of product. Inhibitor included to protect metal surfaces. Ph activator speeds dissolving action. Non-corrosive. Do not mix this product with any other cleaning product - may lead to toxic fumes.			
4.5 lb.	8		50498
9 lb.	4		50499



PRESSURE SWITCH

SQUARE D

Item	Pack	Part #	HDI #
FSG-2 For domestic water pumps. Diaphragm actuated - 2 pole. 1/4" - 18 pipe thread.			
20/40	20	9013-FSG-2J20	40901
30/50	20	9013-FSG-2J21	40900



WATER PUMP PRESSURE SWITCHES

PLUMB EEZE

Item	Pack	Part #	HDI #
Includes 1/4" tube fitting			
1/4" FPT Pressure Switch	20	PE-PS2	40952
1/4" FPT Low Pressure Cut-Off	20	PE-PS2LP	40953



PE-PG100 PE-PGBM100

PRESSURE GAUGES

PLUMB EEZE

Item	Pack	Part #	HDI #
2" Dial - Steel case; Window: Glass - Bourdon tube; Application: General Purpose - not for use with oxygen; Connection: Brass; Range PSI - 0-100			
1/8" CBM	100	PE-PGBM100	40306
1/4" LM	100	PE-PG100	40328

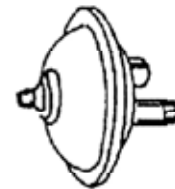

AIR VOLUME CONTROL

BOSHART

Item	Pack	Part #	HDI #
Automatic. Diaphragm type. Less fitting connection and tubing. For domestic water system tanks.			
Brady Style - Non-repairable tanks to 80 gal.	1	PE-AVC45	40902



LOWER VALVE LEATHER

BOSHART

Item	Pack	Part #	HDI #
Genuine oak tanned stock, clean cut, uniform thickness and finely finished. For heavy duty use in wells of any depth.			
3 1/2" OD	12		40957



CUP LEATHER

BOSHART

Item	Pack	Part #	HDI #
Genuine oak tanned stock. For shallow or medium wells.			
2" OD x 1 1/4" ID	12		40955
3" OD x 2" ID	12		40956



PLUMBING & HEATING

PEDESTAL SUMP PUMP



WAYNE

Item	Pack	Part #	HDI #
1/3 hp Thermoplastic pedestal. Mechanical float switch. Over-load protection. Top Suction strainer. Open style impeller prevents clogs. Stainless steel shaft. 11" minimum sump diameter. 2270 gallons per hour at 10'. 1 1/4" - 1 1/2" discharge pipe. GFCI Outlet			
1 year warranty	1	PTU-30	60001
1/3 hp Cast iron pedestal. Adjustable vertical float. Over-load protection. Top suction strainer. Open style impeller. Stainless steel shaft. 12" minimum sump diameter. 1 1/2" NPT discharge.			
2 year warranty	1	SPV-500	60003

DISCHARGE KIT

WAYNE



For use with all types of sump pumps to discharge water outside of the basement at a safe distance from the house. Kit includes 24' of corrugated hose which may be cut at 8' intervals, one male adapter and one hose clamp. Individually packaged.			
1 1/4"	8	56171	60024
1 1/2"	6	66000-WYN	60023



57028-001



57027-001

SUMP PUMP CHECK VALVE

WAYNE

For use with all types of sump pumps. Keeps water from returning to sump basin and reduces noise. Works with 1 1/4" or 1 1/2" OD pipe.			
1 1/4" check valve w/adapter two convertible fittings, 4 hose clamps	1	57028-001	60021
1 1/4" check valve w/adapter	1	57027-001	60040

TRANSFER PUMP

WAYNE



Portable - 1/2 hp Cast iron transfer pump. 3/4" brass hose adapter connect to garden hose. Built-in carry handle for portability. Ball bearing high speed motor-high flow.			
1 year warranty	1	PC4	60005



SPT-33



RSP-130



SPF-33



CDU790

SUBMERSIBLE SUMP PUMP

WAYNE

CDU800

Item	Pack	Part #	HDI #
<i>Thermoplastic base and top assembly.</i> Tethered float switch. Allows installation in 14" or larger sump basins. HD oil filled motor. On level 13", off level 7". 1 1/2" diameter discharge. 1 year warranty			
1/3 hp	1	SPT-33	60006
<i>Thermoplastic Sump Pump With Tether Float Switch</i> - Base suction with debris screen. Corrosion resistant, sealed thermoplastic construction. Fully submersible. Max. flow rate is 3060 gallons per hour; 2460 GPH at 10 ft. of discharge lift. 1-1/2" NPT discharge. 1 year warranty			
1/3 hp	1	RSP-130	60016
SPF-33 has a thermoplastic base and top assembly. CDU790 & CDU800 has a cast iron base and thermoplastic top. Vertical float switch allows use in 11" or larger sump basins. HD oil filled motor. On level 9", off level 4". 1 1/2" diameter discharge.			
1/3 hp - Thermoplastic Base 1 year warranty	1	SPF-33	60002
1/3 hp - Cast Iron Base 3 year warranty	1	CDU790	60004
1/2 hp - Cast Iron Base 3 year warranty	1	CDU800	60011



UTILITY PUMP TSC-130

RUP160

GFU110

WAYNE

Item	Pack	Part #	HDI #
Submersible - 3/4" discharge connects to garden hose. Thermoplastic housing. Bottom suction removes water to within 1/8" of surface. Water cooled for continuous use.			
1/4 hp - 1 year warranty	1	TSC-130	60009
Submersible - 3/4" garden hose 1 1/4" discharge with adapter. Drains water down to 1/4" of surface. Built-in easy carry handle. Corrosion resistant motor housing, volute, base & impeller. Ball bearings, oil free motor			
1/6 hp - 1 year warranty	1	RUP160	60017
Submersible - Pumps Up to 660 GPH @ 0'. Oil-Free Reinforced Thermoplastic Submersible Utility Pump. Corrosion-Resistant, Reinforced Thermoplastic Housing, Volute, And Impeller. Bottom Suction Design Filters Debris and Removes Water Down To 1/8" Of Surface 3/4" Garden Hose Thread. Oil-Free Design Protects Aquatic Life. Easy-Access Handle for Portability. Ideal For Draining Aquariums, Clogged Sinks, Or Removing Standing Water.			
1 year warranty	1	GFU110	60019



PLUMBING & HEATING



SHALLOW WELL JET PUMP

WAYNE

Item	Pack	Part #	HDI #
Designed to pump water from 0 to 25' lifts. Heavy duty square flange motor is universally available if replacement is ever required. 1 1/4" suction, 3/4" discharge. Pressure switch is preset at 30-50 psi. Dual voltage available (115/230).			
1/2 hp, 384 gph @ 5', 50 psi 3 Year Warranty	1	SWS50	60010
1/2 hp, 288 gph @ 5', 50 psi 1 Year Warranty	1	JSU50	60012
3/4 hp, 468 gph @ 5', 50 psi 3 Year Warranty	1	SWS75	60008



LAWN SPRINKLING PUMP

WAYNE

Item	Pack	Part #	HDI #
Designed to operate underground sprinkling systems, draw water from well, lake, or ponds for watering, pool filling, or any other applications where high water volume is needed. All motors are factory wired 240V. 2" NPT suction with 1 1/2" NPT Discharge. 1 year warranty			
1 hp, 2450 gph @ 5', 30 psi	1	WLS100	60037
1 1/2 hp, 2950 gph @ 5', 30 psi	1	WLS150	60038
2 hp, 4200 gph @ 5', 30 psi	1	WLS200	60039



DRILL PUMP

WAYNE

Item	Pack	Part #	HDI #
Empties clogged sinks and washing machines. Drains aquariums, tanks, and more. Maximum flow rate is 85 gallons per hour. Works with any electric drill. Stainless steel shaft for long life.			
1 year warranty	1	WDP-21	60025



SEWAGE EJECTOR PUMP

WAYNE

Item	Pack	Part #	HDI #
Economy residential. Transfers residential sewage to nearby municipal hook-ups. Completely submersible. Polymer and thermoplastic construction. Pumps 2" solids, complies with most state plumbing codes. Automatic overload protection. 7800 gallons per hour. Mercury switch. 1 year warranty			
1/2 hp (split phase w/solid state start)	1	SEL50	60007



PLUMBING & HEATING



PEDESTAL SUMP PUMP SWITCH

WAYNE

Item	Pack	Part #	HDI #
Switch kit. Fits GE, Emerson, Westinghouse or Marathon motors. Carded			
	1	56396	60015



SUBMERSIBLE SUMP PUMP SWITCH KIT

WAYNE

Item	Pack	Part #	HDI #
Fits models: CDU, SPF, SSPF. Carded			
	1	56395	60018



JET PUMP SWITCH

WAYNE

Item	Pack	Part #	HDI #
20-40 pressure switch. Carded			
	1	66025-WYN1	60600



TETHERED SWITCH KIT

WAYNE

Item	Pack	Part #	HDI #
Piggyback tethered switch kit for all brands of sump and sewage pumps up to 1/2 hp. 9' cord. Fits Wayne models SPT, SSPT, WST, CDT, EFL, SEL, DSP, SEP4. Boxed			
	1	56835-WYN1	60601



IMPELLER

WAYNE

Item	Pack	Part #	HDI #
For 1/3 hp SPV500, BPV500. Carded			
	1	56392	60013
For PTU33. Carded			
	1	66001-WYN1	60014

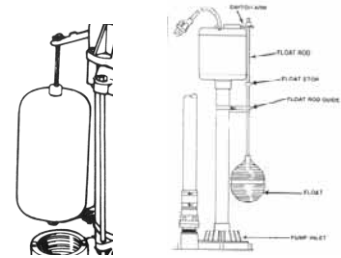

FLOAT KIT

WAYNE

Item	Pack	Part #	HDI #
For CDU/SPF submersible pumps.			
	1	60038-001	60022
Replacement Parts			
Float Stop Grommet	1	17230-001	60900
Float Rod	1	17229-001	60901
Float Rod Guide	1	1509	60903